

Test Report

FCC ID: 2AFP2-TB20

Date of issue: Dec. 25, 2019

Report number: MTi19112810-2E3

Sample description: Wireless Charging Bluetooth Speaker

Model(s): TB20

Applicant: Shenzhen Powerqi Technology Co., Ltd.

Address: 2nd&3rd Floor, Building A4, Block A, Fangxing Science & Tech. Park, No. 13 of BaoNan Road, Longgang District, Shenzhen, China

Date of test: Dec. 05, 2019 – Dec. 25, 2019

Shenzhen Microtest Co., Ltd.
<http://www.mtitest.com>

Table of Contents

1	GENERAL INFORMATION	4
1.1	FEATURE OF EQUIPMENT UNDER TEST (EUT)	4
1.2	TEST MODE	4
1.3	EUT TEST SETUP	5
1.4	ANCILLARY EQUIPMENT	5
1.5	MEASUREMENT UNCERTAINTY	5
2	SUMMARY OF TEST RESULT	6
2.1	OPERATION CHANNEL LIST	6
2.2	TEST CHANNEL	6
3	TEST FACILITIES AND ACCREDITATIONS	7
3.1	TEST LABORATORY	7
3.2	ENVIRONMENTAL CONDITIONS	7
3.3	MEASUREMENT UNCERTAINTY	7
3.4	TEST SOFTWARE	7
4	LIST OF TEST EQUIPMENT	8
5	TEST RESULTS	9
5.1	ANTENNA REQUIREMENT	9
5.1.1	<i>Standard requirement</i>	9
5.1.2	<i>EUT Antenna</i>	9
5.2	CONDUCTED EMISSION	10
5.2.1	<i>Limits</i>	10
5.2.2	<i>Test Procedures</i>	10
5.2.3	<i>Test Setup</i>	10
5.2.4	<i>Test Result</i>	10
5.3	RADIATED EMISSION	15
5.3.1	<i>Limits</i>	15
5.3.2	<i>Test Procedures</i>	16
5.3.3	<i>Test Setup</i>	17
5.3.4	<i>Test Result</i>	17
5.4	OCCUPIED BANDWIDTH	22
5.4.1	<i>Test method</i>	22
5.4.2	<i>Test result</i>	22
	PHOTOGRAPHS OF THE TEST SETUP	23
	PHOTOGRAPHS OF THE EUT	25

Test Result Certification

Applicant's name: Shenzhen Powerqi Technology Co., Ltd.

Address: 2nd&3rd Floor, Building A4, Block A, Fangxing Science & Tech. Park,
No. 13 of BaoNan Road, Longgang District, Shenzhen, China

Manufacture's name: Shenzhen Powerqi Technology Co., Ltd.

Address: 2nd&3rd Floor, Building A4, Block A, Fangxing Science & Tech. Park,
No. 13 of BaoNan Road, Longgang District, Shenzhen, China

Product name: Wireless Charging Bluetooth Speaker

Trademark: Powerqi

Model name: TB20

Standards: FCC Part 15C

Test procedure: ANSI C63.10-2013

This device described above has been tested by Shenzhen Microtest Co., Ltd. and the test results show that the equipment under test (EUT) is in compliance with the FCC requirements. And it is applicable only to the tested sample identified in the report.

Tested by:



Danny Xu

Dec. 25, 2019

Reviewed by:

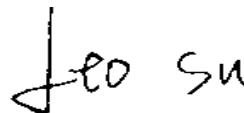

Leo Su

Dec. 25, 2019

Approved by:



Tom Xue

Dec. 25, 2019

1 GENERAL INFORMATION

1.1 Feature of equipment under test (EUT)

Product name:	Wireless Charging Bluetooth Speaker
Model name:	TB20
Model difference:	N/A
Operation frequency:	115–205 kHz
Modulation type:	ASK
Antenna type:	Coil Antenna
Power supply:	DC 9V from adapter AC 120V/60Hz or DC 3.7V from battery
Battery:	DC 3.7 500mAh
Adapter information:	N/A

1.2 Test mode

To investigate the maximum EMI emission characteristics generated from EUT, the test system was pre-scanning tested based on the consideration of following EUT operation mode or test configuration mode which possibly have effect on EMI emission level. Each of these EUT operation mode(s) or test configuration mode(s) mentioned above was evaluated respectively.

Test mode	Description
Mode 1	Charging + TX

Note1: The test modes were carried out for all operation modes. The final test mode of the EUT was the worst test mode for EMI, and its test data was showed.

Note2: EUT is tested under full load and belongs to the worst mode.

1.3 EUT test setup

See photographs of the test setup in the report for the actual setup and connections between EUT and support equipment.

1.4 Ancillary equipment

Equipment	Model	S/N	Manufacturer
Adapter			
Load	/	/	/

1.5 Measurement Uncertainty

Measurement Uncertainty for a Level of Confidence of 95 %, $U=2xUc(y)$

Conducted emission(150kHz~30MHz)	± 2.5 dB
Radiated emission(30MHz~1GHz)	± 4.2 dB
Radiated emission (above 1GHz)	± 4.3 dB
Temperature	± 1 degree
Humidity	± 5 %

2 Summary of Test Result

Item	FCC Part No.	Description of Test	Result
1	FCC PART 15.203	Antenna requirement	Pass
2	FCC PART 15.207	Conducted emission	Pass
3	FCC PART 15.209	Radiated emission	Pass
4	FCC Part 15.215	20dB bandwidth	Pass

2.1 Operation channel list

Channel List

Channel	Frequency (kHz)
Low	115
Middle	141
High	205

2.2 Test channel

Channel	Frequency (kHz)
Middle	141

3 Test Facilities and Accreditations

3.1 Test laboratory

Test Laboratory	Shenzhen Microtest Co., Ltd
Location	No.102A & 302A, East Block, Hengfang Industrial Park, Xingye Road, Xixiang, Bao'an District, Shenzhen, Guangdong, China
FCC Registration No.:	448573

3.2 Environmental conditions

Temperature:	15°C~35°C
Humidity	20%~75%
Atmospheric pressure	98kPa~101kPa

3.3 Measurement uncertainty

Measurement Uncertainty for a Level of Confidence of 95 %, $U=2xUc(y)$

RF frequency	1×10^{-7}
RF power, conducted	± 1 dB
Conducted emission(150kHz~30MHz)	± 2.5 dB
Radiated emission(30MHz~1GHz)	± 4.2 dB
Radiated emission (above 1GHz)	± 4.3 dB
Temperature	± 1 degree
Humidity	± 5 %

3.4 Test software

Software Name	Manufacturer	Model	Version
RF Test System	Shenzhen JS tonscond co., ltd	JS1120-3	2.5.77.0418

4 List of test equipment

Equipment No.	Equipment Name	Manufacturer	Model	Serial No.	Calibration date	Due date
MTI-E004	EMI Test Receiver	Rohde&schwarz	ESPI7	100314	2019/10/09	2020/10/08
MTI-E006	TRILOG Broadband Antenna	Schwarzbeck	VULB 9163	9163-872	2019/10/15	2020/10/14
MTI-E014	amplifier	Hewlett-Packard	8447D	3113A06150	2019/10/09	2020/10/08
MTI-E036	Single path vehicle AMN(LISN)	Schwarzbeck	NNBM 8124	01175	2019/10/09	2020/10/08
MTI-E038	Low noise active vertical monopole antenna	Schwarzbeck	VAMP 9243	#565	2019/10/16	2020/10/15
MTI-E039	Biconical antenna	Schwarzbeck	BBA 9106	#164	2019/10/15	2020/10/14
MTI-E041	MXG Vector Signal Generator	Agilent	N5182A	MY49060455	2019/04/16	2020/04/15
MTI-E042	ESG Series Analog signal generator	Agilent	E4421B	GB40051240	2019/05/21	2020/05/20
MTI-E044	Thermometer clock humidity monitor	-	HTC-1	/	2019/04/17	2020/04/16
MTI-E062	Log Periodic Antenna	Schwarzbeck	VUSLP 9111B	#312	2018/04/11	2020/04/10
MTI-E063	Log Periodic Dipole Array Antenna	ETS-LINDGREN	3148B	00224524	2018/04/11	2020/04/10
MTI-E065	Amplifier	EMtrace	RP06A	00117	2019/04/29	2020/04/28
MTI-E071	PXA Signal Analyzer	Agilent	N9030A	MY51350296	2019/10/25	2020/10/24
MTI-E076	EMI Test Receiver	Rohde&schwarz	ESIB26	100273	2019/04/16	2020/04/15
MTI-E078	Synthesized Sweeper	Agilent	83752A	3610A01957	2019/04/16	2020/04/15
MTI-E079	DC Power Supply	Agilent	E3632A	MY40027695	2019/04/16	2020/04/15
MTI-E093	Artificial mains network	3ctest	LISN J50	ES3911805	2019/04/16	2020/04/15
MTI-E096	Power amplifier	Space-Dtronics	EWLNA0118G-P40	1852001	2019/04/29	2020/04/28
MTI-E097	Current Probe	SOLAR ELECTRONICS CO.	9207-1	220095-1	2019/04/17	2020/04/16
MTI-E098	Loop Sensor	SOLAR ELECTRONICS CO.	7334-1	220095-2	2019/04/21	2020/04/20

Note: the calibration interval of the above test instruments is 12 or 24 months and the calibrations are traceable to international system unit (SI).

5 Test Results

5.1 Antenna requirement

5.1.1 Standard requirement

15.203 requirement: For intentional device, according to 15.203: an intentional radiator shall be designed to ensure that no antenna other than that furnished by the responsible party shall be used with the device

5.1.2 EUT Antenna

The EUT antenna is Coil Antenna. It comply with the standard requirement. In case of replacement of broken antenna the same antenna type must be used.

5.2 Conducted emission

5.2.1 Limits

For the following equipment, when designed to be connected to the public utility (AC) power line the radio frequency voltage that is conducted back onto the AC power line on any frequency or frequencies shall not exceed the limits in the following tables. Compliance with the provisions of this paragraph shall be based on the measurement of the radio frequency voltage between each power line and ground at the power terminal using a 50 μ H/50 ohms line impedance stabilization network (LISN).

Frequency (MHz)	Conducted limit (dB μ V)	
	Quasi-peak	Average
0.15 -0.5	66 - 56 *	56 - 46 *
0.5 -5	56	46
5 -30	60	50

Note: the limit of " * " marked band means the limitation decreases linearly with the logarithm of the frequency in the range.

5.2.2 Test Procedures

The EUT was placed 0.8 meters from the horizontal ground plane with EUT being connected to the power mains through a line impedance stabilization network (LISN). All other support equipment powered from additional LISN(s). The LISN provide 50 Ohm/ 50uH of coupling impedance for the measuring instrument.

Interconnecting cables that hang closer than 40 cm to the ground plane shall be folded back and forth in the center forming a bundle 30 to 40 cm long.

I/O cables that are not connected to a peripheral shall be bundled in the center. The end of the cable may be terminated, if required, using the correct terminating impedance. The overall length shall not exceed 1 m.

LISN is at least 80 cm from nearest part of EUT chassis.

For the actual test configuration, please refer to the related Item – photographs of the test setup.

5.2.3 Test Setup

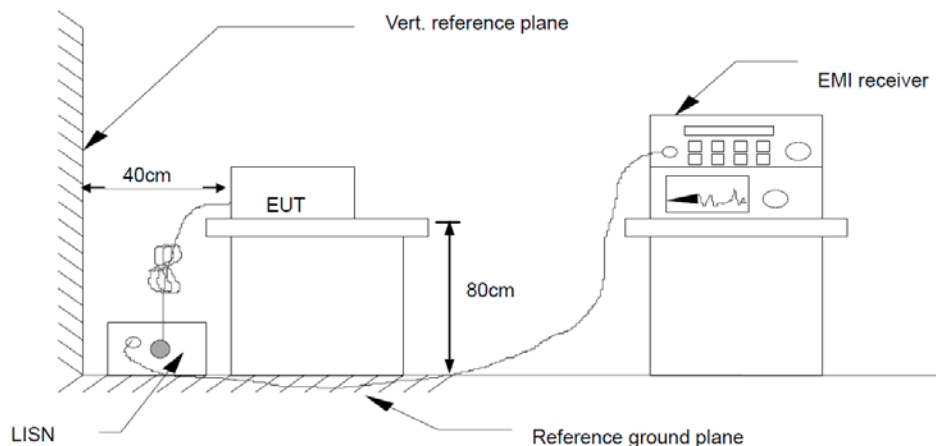

5.2.4 Test Result



EUT:	Wireless Charging Bluetooth Speaker	Model Name:	TB20
Pressure:	101kPa	Phase:	L
Test voltage:	DC 9V from adapter AC 120V/60Hz	Test mode:	Mode 1

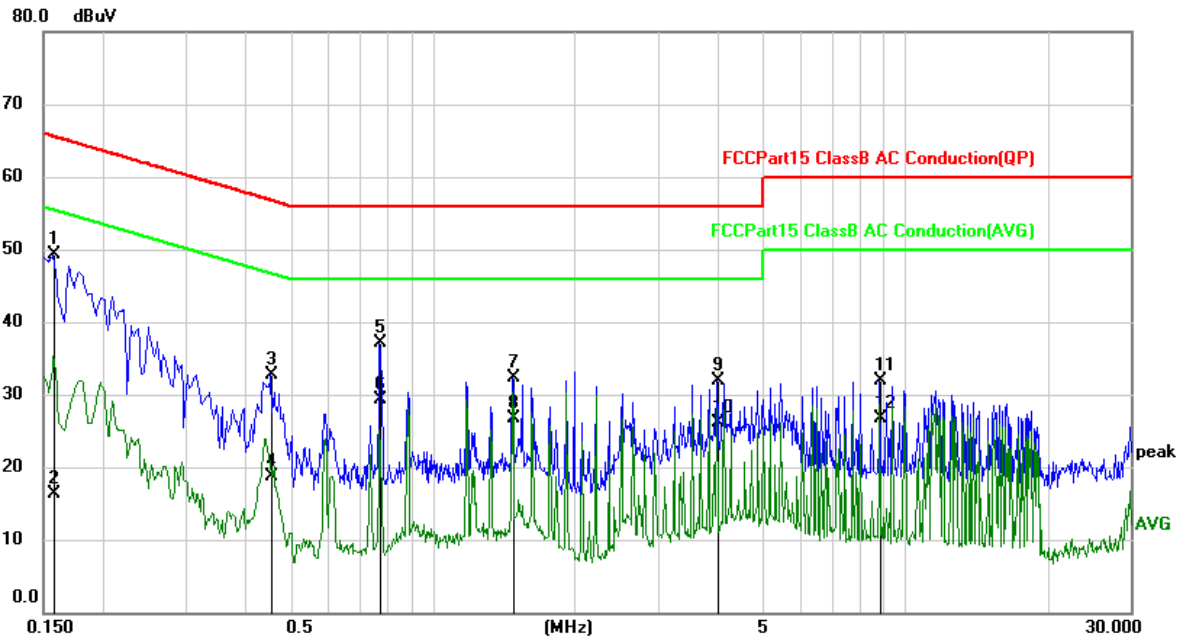

No.	Mk.	Freq.	Reading Level	Correct Factor	Measurement	Limit	Over	Detector
		MHz	dBuV	dB	dBuV	dBuV	dB	
1	*	0.1580	39.67	9.73	49.40	65.57	-16.17	QP
2		0.1580	6.53	9.73	16.26	55.57	-39.31	AVG
3		0.4540	22.80	9.89	32.69	56.80	-24.11	QP
4		0.4540	8.86	9.89	18.75	46.80	-28.05	AVG
5		0.7740	27.20	9.95	37.15	56.00	-18.85	QP
6		0.7740	19.35	9.95	29.30	46.00	-16.70	AVG
7		1.4780	22.35	9.99	32.34	56.00	-23.66	QP
8		1.4780	16.76	9.99	26.75	46.00	-19.25	AVG
9		3.9900	21.94	10.05	31.99	56.00	-24.01	QP
10		3.9900	16.06	10.05	26.11	46.00	-19.89	AVG
11		8.8540	21.67	10.27	31.94	60.00	-28.06	QP
12		8.8540	16.53	10.27	26.80	50.00	-23.20	AVG



EUT:	Wireless Charging Bluetooth Speaker	Model Name:	TB20
Pressure:	101kPa	Phase:	N
Test voltage:	DC 9V from adapter AC 120V/60Hz	Test mode:	Mode 1

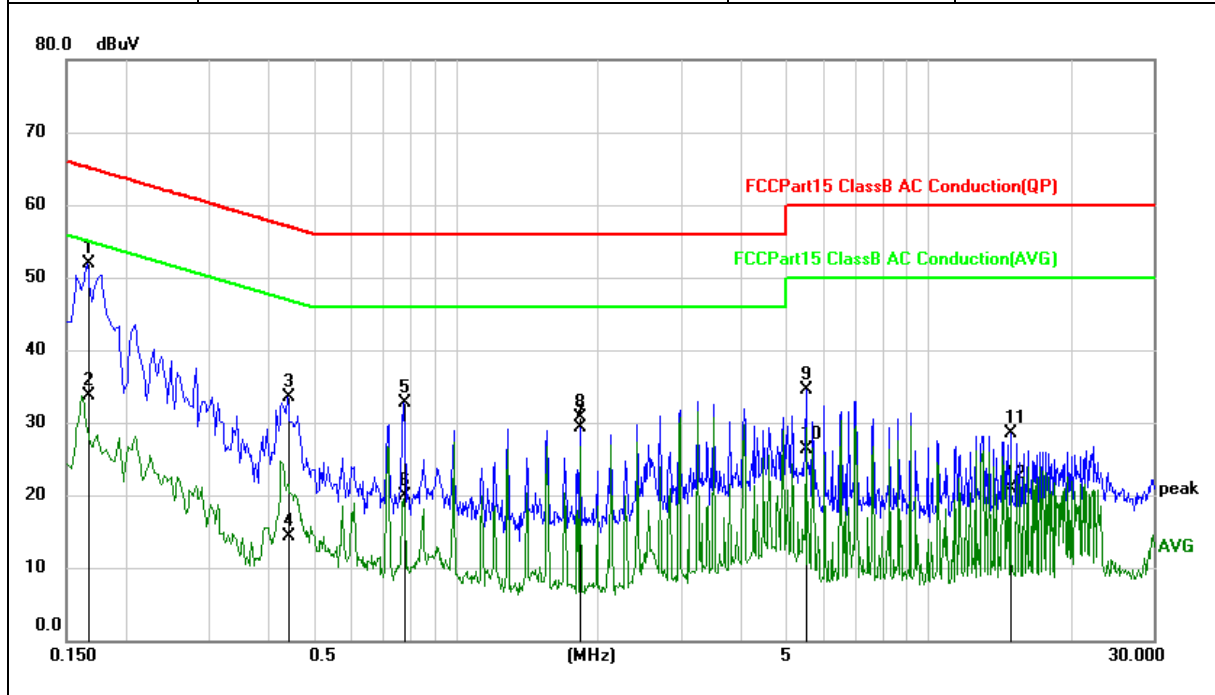

No.	Mk.	Freq. MHz	Reading Level dBuV	Correct Factor dB	Measure- ment dBuV	Limit dBuV	Over dB	Detector
1	*	0.1660	42.10	9.73	51.83	65.16	-13.33	QP
2		0.1660	24.06	9.73	33.79	55.16	-21.37	AVG
3		0.4420	23.65	9.88	33.53	57.02	-23.49	QP
4		0.4420	4.43	9.88	14.31	47.02	-32.71	AVG
5		0.7780	22.81	9.95	32.76	56.00	-23.24	QP
6		0.7780	10.02	9.95	19.97	46.00	-26.03	AVG
7		1.8380	19.39	10.00	29.39	56.00	-26.61	QP
8		1.8380	20.64	10.00	30.64	46.00	-15.36	AVG
9		5.5100	24.45	10.10	34.55	60.00	-25.45	QP
10		5.5100	16.27	10.10	26.37	50.00	-23.63	AVG
11		14.9220	18.31	10.27	28.58	60.00	-31.42	QP
12		14.9220	10.59	10.27	20.86	50.00	-29.14	AVG



EUT:	Wireless Charging Bluetooth Speaker	Model Name:	TB20
Pressure:	101kPa	Phase:	L
Test voltage:	DC 9V from adapter AC 240V/60Hz	Test mode:	Mode 1

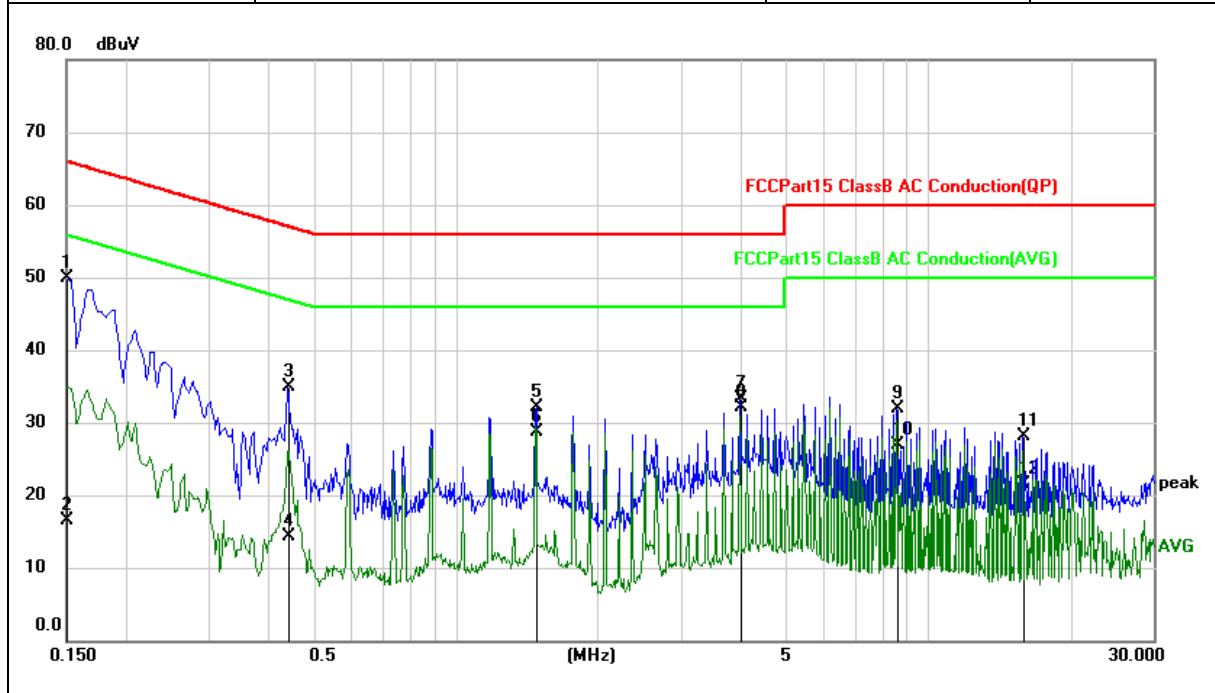

No.	Mk.	Freq. MHz	Reading Level dBuV	Correct Factor dB	Measure- ment dBuV	Limit dBuV	Over dB	Detector
1		0.1500	40.08	9.73	49.81	66.00	-16.19	QP
2		0.1500	6.80	9.73	16.53	56.00	-39.47	AVG
3		0.4420	24.98	9.88	34.86	57.02	-22.16	QP
4		0.4420	4.34	9.88	14.22	47.02	-32.80	AVG
5		1.4819	22.07	9.99	32.06	56.00	-23.94	QP
6		1.4819	18.70	9.99	28.69	46.00	-17.31	AVG
7		3.9940	23.23	10.05	33.28	56.00	-22.72	QP
8	*	3.9940	22.02	10.05	32.07	46.00	-13.93	AVG
9		8.5820	21.66	10.25	31.91	60.00	-28.09	QP
10		8.5820	16.68	10.25	26.93	50.00	-23.07	AVG
11		15.8300	17.81	10.26	28.07	60.00	-31.93	QP
12		15.8300	11.22	10.26	21.48	50.00	-28.52	AVG



EUT:	Wireless Charging Bluetooth Speaker	Model Name:	TB20
Pressure:	101kPa	Phase:	N
Test voltage:	DC 9V from adapter AC 240V/60Hz	Test mode:	Mode 1

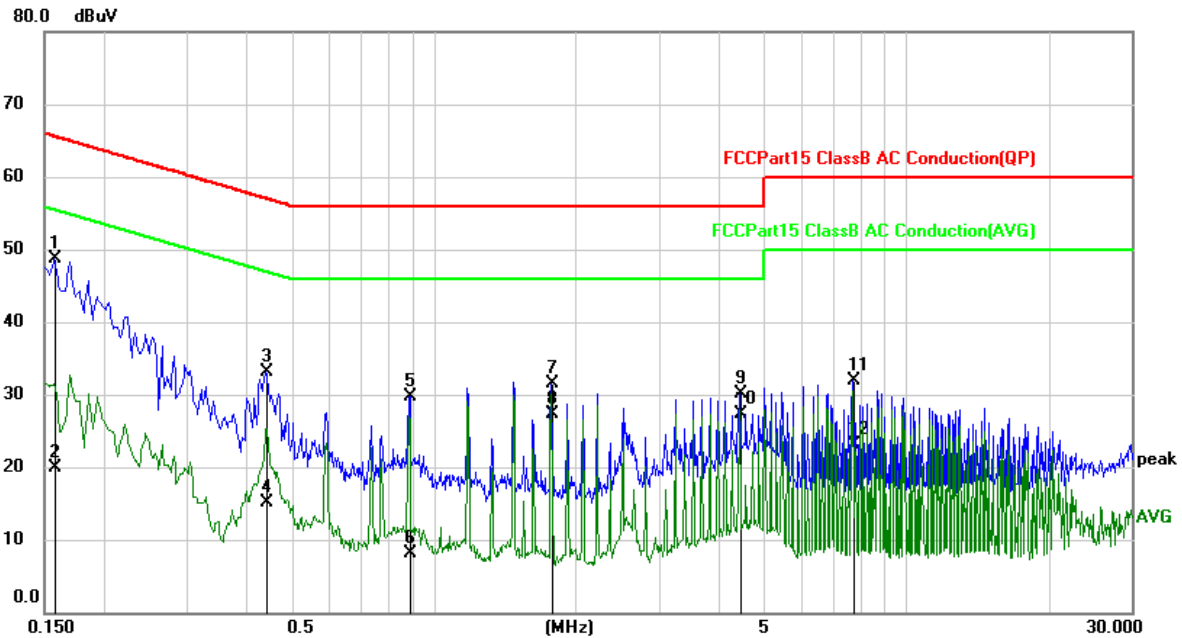

No.	Mk.	Freq. MHz	Reading Level dBuV	Correct Factor dB	Measure- ment dBuV	Limit dBuV	Over dB	Detector
1	*	0.1580	39.00	9.73	48.73	65.57	-16.84	QP
2		0.1580	10.11	9.73	19.84	55.57	-35.73	AVG
3		0.4420	23.31	9.88	33.19	57.02	-23.83	QP
4		0.4420	5.21	9.88	15.09	47.02	-31.93	AVG
5		0.8860	19.70	9.97	29.67	56.00	-26.33	QP
6		0.8860	-1.93	9.97	8.04	46.00	-37.96	AVG
7		1.7740	21.54	10.00	31.54	56.00	-24.46	QP
8		1.7740	17.28	10.00	27.28	46.00	-18.72	AVG
9		4.4380	20.13	10.06	30.19	56.00	-25.81	QP
10		4.4380	17.23	10.06	27.29	46.00	-18.71	AVG
11		7.6900	21.65	10.21	31.86	60.00	-28.14	QP
12		7.6900	12.81	10.21	23.02	50.00	-26.98	AVG

5.3 Radiated emission

5.3.1 Limits

In case the emission fall within the restricted band specified on 15.205(a), then the 15.209(a) limit in the table below has to be followed.

Frequencies (MHz)	Field Strength (microrvolts/meter)	Measurement Distance (meters)
0.009~0.490	2400/F(KHz)	300
0.490~1.705	24000/F(KHz)	30
1.705~30.0	30	30
30~88	100	3
88~216	150	3
216~960	200	3
Above 960	500	3

LIMITS OF RADIATED EMISSION MEASUREMENT (Above 1000MHz)

FREQUENCY (MHz)	Class B (dBuV/m) (at 3M)	
	PEAK	AVERAGE
Above 1000	74	54

Notes:

The limit for radiated test was performed according to FCC PART 15C.

The tighter limit applies at the band edges.

Emission level (dBuV/m)=20log Emission level (uV/m).

FREQUENCY RANGE OF RADIATED MEASUREMENT (For unintentional radiators)

Highest frequency generated or Upper frequency of measurement used in the device or on which the device operates or tunes (MHz)	Range (MHz)
Below 1.705	30
1.705 – 108	1000
108 – 500	2000
500 – 1000	5000
Above 1000	5 th harmonic of the highest frequency or 40 GHz, whichever is lower

Spectrum Parameter	Setting
Attenuation	Auto
Start Frequency	1000 MHz
Stop Frequency	10th carrier harmonic
RB / VB (emission in restricted band)	1 MHz / 1 MHz for Peak, 1 MHz / 10Hz for Average

Receiver Parameter	Setting
Attenuation	Auto
Start ~ Stop Frequency	9kHz~150kHz / RB 200Hz for QP
Start ~ Stop Frequency	150kHz~30MHz / RB 9kHz for QP

Start ~ Stop Frequency	30MHz~1000MHz / RB 120kHz for QP
------------------------	----------------------------------

5.3.2 Test Procedures

- a. The measuring distance of at 3 m shall be used for measurements at frequency up to 25GHz. For frequencies above 1GHz, any suitable measuring distance may be used.
- b. The EUT was placed on the top of a rotating table 0.8 meters above the ground at a 3 meter semi-chamber test. The table was rotated 360 degrees to determine the position of the highest radiation.
- c. The height of the equipment or of the substitution antenna shall be 0.8m; above 1GHz, the height was 1.5m, the height of the test antenna shall vary between 1 m to 4 m. Both horizontal and vertical polarizations of the antenna are set to make the measurement.
- d. The initial step in collecting conducted emission data is a spectrum analyzer peak detector mode pre-scanning the measurement frequency range. Significant peaks are then marked and then Quasi Peak detector mode re-measured.
- e. If the Peak Mode measured value compliance with and lower than Quasi Peak Mode Limit, the EUT shall be deemed to meet QP Limits and then no additional QP Mode measurement performed.
- f. For the actual test configuration, please refer to the related Item –EUT Test Photos.
- g. For the radiated emission test above 1GHz:
Place the measurement antenna away from each area of the EUT determined to be a source of emissions at the specified measurement distance, while keeping the measurement antenna aimed at the source of emissions at each frequency of significant emissions, with polarization oriented for maximum response.
- h. The measurement antenna may have to be higher or lower than the EUT, depending on the radiation pattern of the emission and staying aimed at the emission source for receiving the maximum signal. The final measurement antenna elevation shall be that which maximizes the emissions. The measurement antenna elevation for maximum emissions shall be restricted to a range of heights of from 1 m to 4 m above the ground or reference ground plane.

Note: Both horizontal and vertical antenna polarities were tested and performed pretest to three orthogonal axis. The worst case emissions were reported.

5.3.3 Test Setup

Radiated Emission Test-Up Frequency Below 30MHz

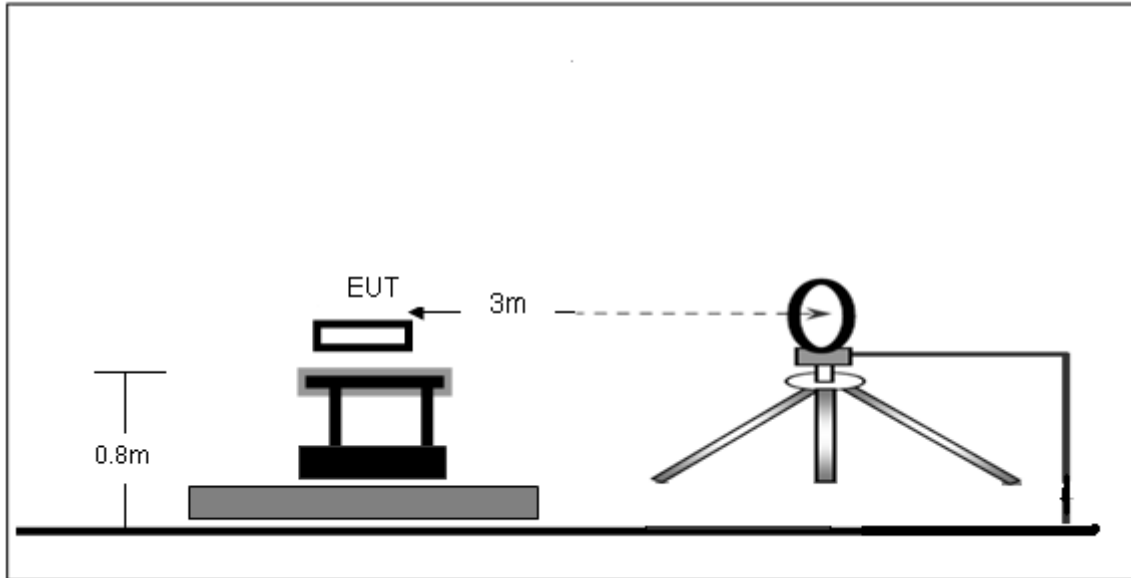

Radiated Emission Test-Up Frequency 30MHz~1GHz

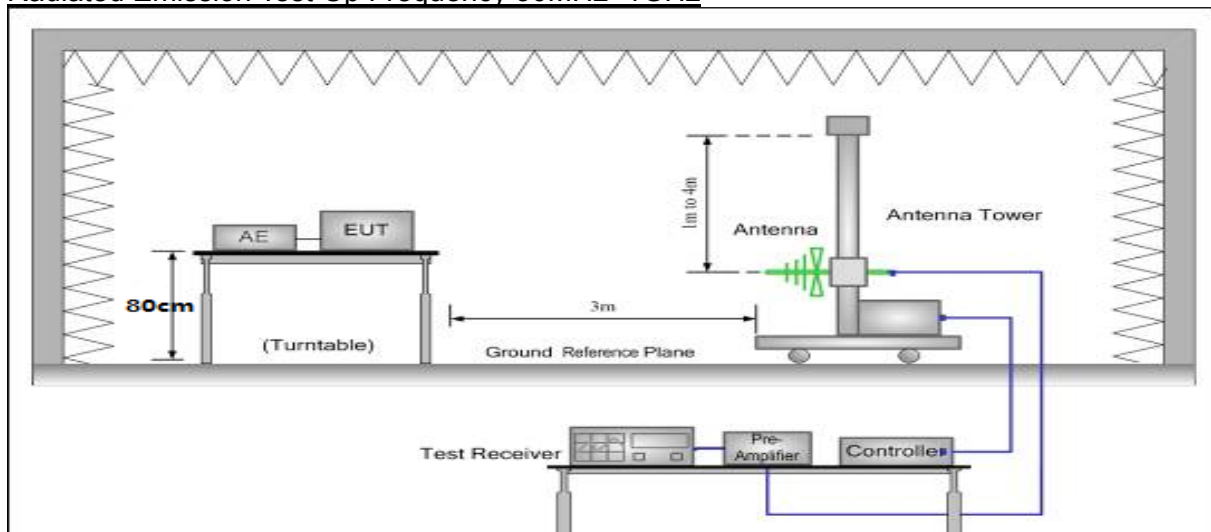

5.3.4 Test Result



Frequency range (9kHz – 30MHz)

EUT:	Wireless Charging Bluetooth Speaker	Model Name:	TB20
Pressure:	101kPa	Test mode:	Mode 1
Test voltage:	DC 9V from adapter AC 120V/60Hz		

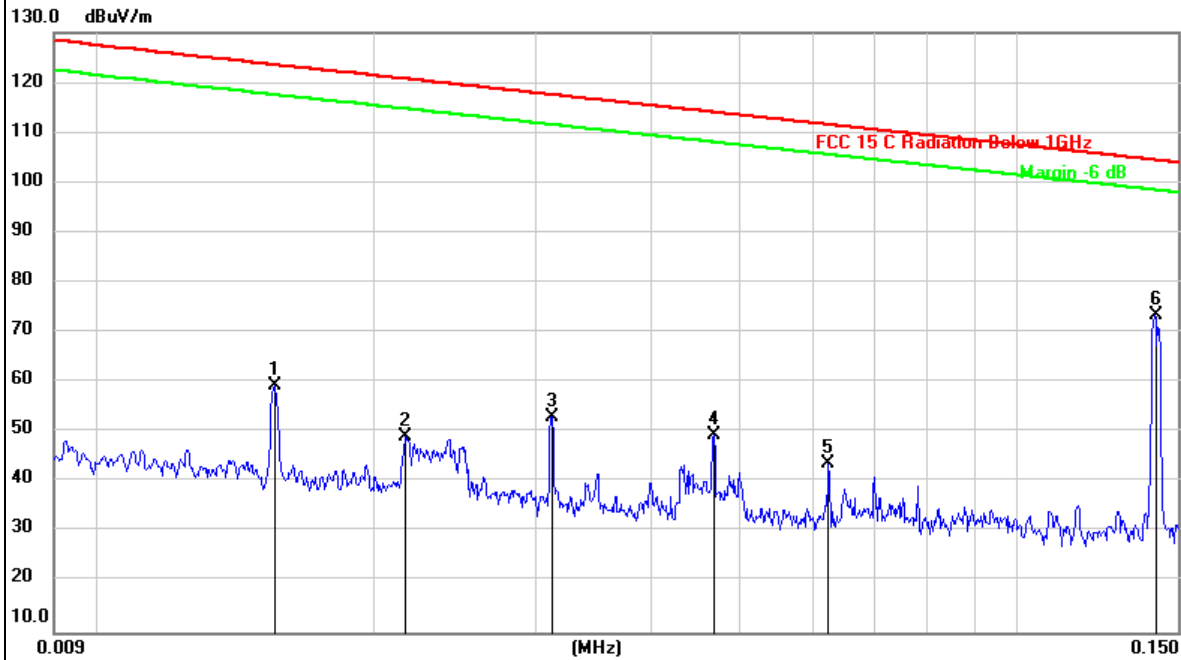

No.	Mk.	Freq. MHz	Reading Level dBuV	Correct Factor dBuV/m	Measure- ment dBuV/m	Limit dBuV/m	Over dB	Detector
1		0.0156	38.64	20.60	59.24	123.57	-64.33	QP
2		0.0217	28.66	20.60	49.26	120.72	-71.46	QP
3		0.0313	32.38	20.61	52.99	117.56	-64.57	QP
4		0.0469	28.65	20.77	49.42	114.07	-64.65	QP
5		0.0625	23.09	20.74	43.83	111.59	-67.76	QP
6	*	0.1414	53.01	20.30	73.31	104.53	-31.22	QP

EUT:	Wireless Charging Bluetooth Speaker	Model Name:	TB20
Pressure:	101kPa	Test mode:	Mode 1
Test voltage:	DC 9V from adapter AC 120V/60Hz		

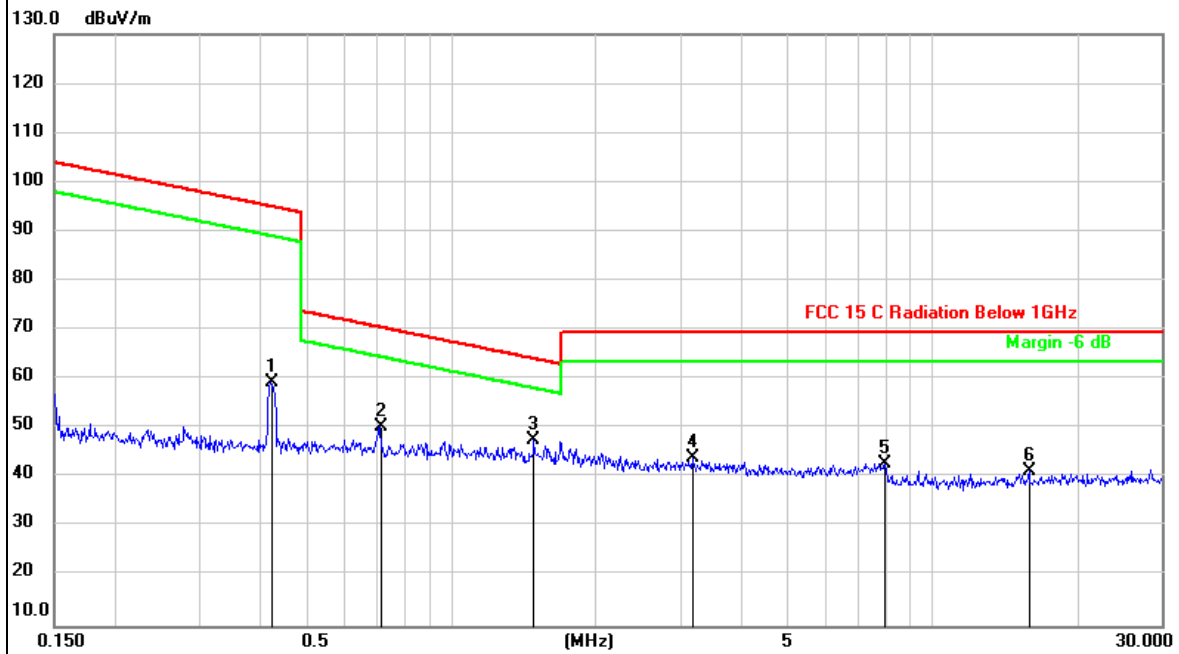

No.	Mk.	Freq. MHz	Reading Level dBuV	Correct Factor dBuV/m	Measure- ment dBuV/m	Limit dBuV/m	Over dB	Detector
1		0.4215	38.83	20.50	59.33	95.10	-35.77	QP
2		0.7122	29.62	20.65	50.27	70.56	-20.29	QP
3	*	1.4874	26.94	20.71	47.65	64.18	-16.53	QP
4		3.1731	23.64	20.42	44.06	69.50	-25.44	QP
5		7.9774	22.34	20.55	42.89	69.50	-26.61	QP
6		15.8854	21.26	19.95	41.21	69.50	-28.29	QP



Frequency range (30MHz – 1GHz)

EUT:	Wireless Charging Bluetooth Speaker	Model Name:	TB20
Pressure:	101kPa	Polarization:	Vertical
Test voltage:	DC 9V from adapter AC 120V/60Hz	Test mode:	Mode 1

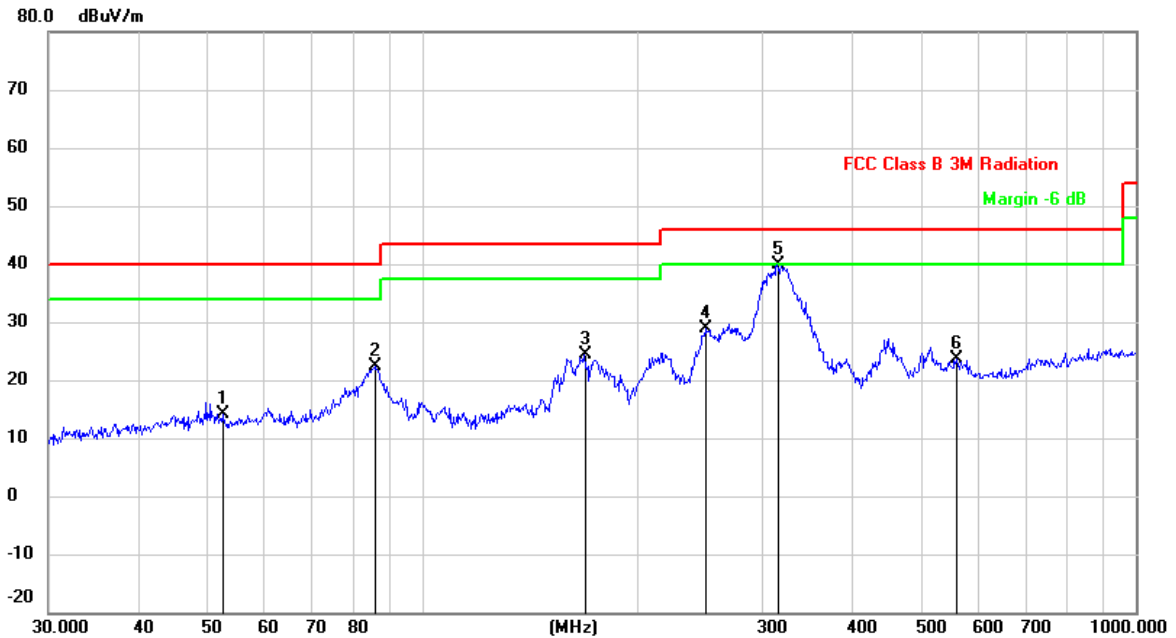

No.	Mk.	Freq. MHz	Reading Level dBuV	Correct Factor dBuV/m	Measurement dBuV/m	Limit dBuV/m	Over dB	Detector
1		52.5752	26.83	-12.65	14.18	40.00	-25.82	QP
2		86.2001	38.84	-16.35	22.49	40.00	-17.51	QP
3		169.0054	39.60	-15.25	24.35	43.50	-19.15	QP
4		249.4250	40.29	-11.29	29.00	46.00	-17.00	QP
5	*	314.3765	49.92	-9.95	39.97	46.00	-6.03	QP
6		560.6928	29.72	-6.15	23.57	46.00	-22.43	QP



EUT:	Wireless Charging Bluetooth Speaker	Model Name:	TB20
Pressure:	101kPa	Polarization:	Horizontal
Test voltage:	DC 9V from adapter AC 120V/60Hz	Test mode:	Mode 1

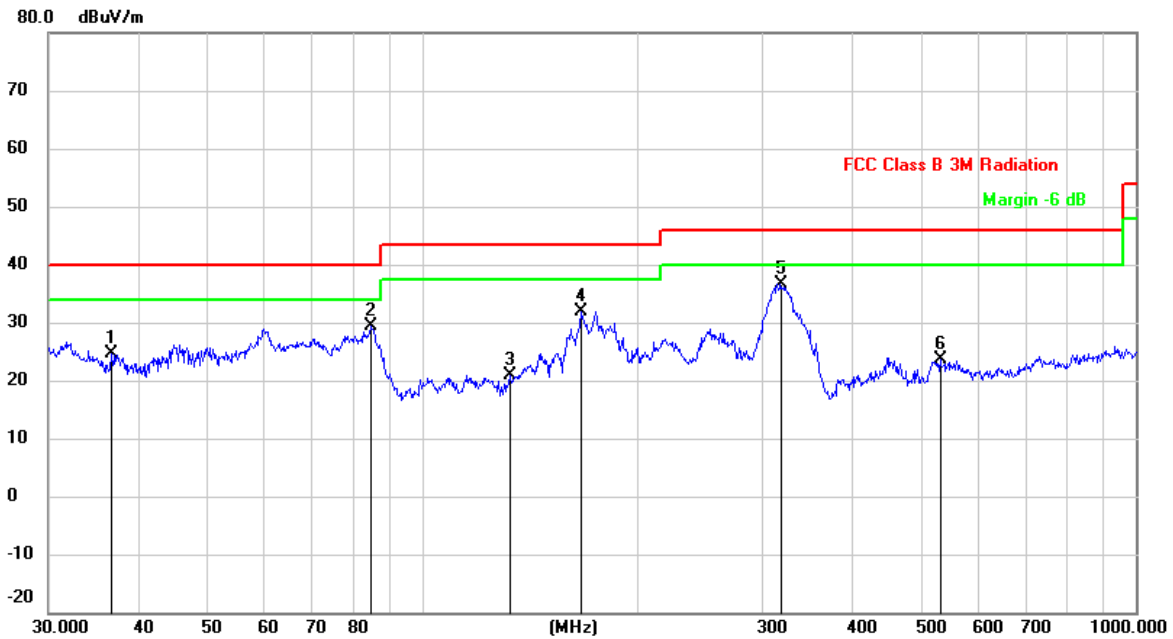

No.	Mk.	Freq.	Reading Level	Correct Factor	Measurement	Limit	Over	Detector
		MHz	dBuV	dBuV/m	dBuV/m	dBuV/m	dB	
1		36.7661	38.64	-14.01	24.63	40.00	-15.37	QP
2		84.7019	45.98	-16.65	29.33	40.00	-10.67	QP
3		132.6850	37.61	-16.76	20.85	43.50	-22.65	QP
4		167.2368	47.29	-15.38	31.91	43.50	-11.59	QP
5	*	317.7011	46.57	-9.92	36.65	46.00	-9.35	QP
6		531.9634	30.86	-7.16	23.70	46.00	-22.30	QP

5.4 Occupied bandwidth

5.4.1 Test method

Use the following spectrum analyzer settings:

Span = approximately 2 to 3 times the 20 dB bandwidth, centered on a hopping channel

RBW $\geq 1\%$ of the 20 dB bandwidth

VBW \geq RBW

Sweep = auto

Detector function = peak

Trace = max hold

The EUT should be transmitting at its maximum data rate. Allow the trace to stabilize. Use the marker-to-peak function to set the marker to the peak of the emission. Use the marker-delta function to measure 20 dB down one side of the emission. Reset the marker-delta function, and move the marker to the other side of the emission, until it is (as close as possible to) even with the reference marker level. The marker-delta reading at this point is the 20 dB bandwidth and 99% occupied bandwidth of the emission.

5.4.2 Test result

Frequency (kHz)	20dB emission bandwidth (kHz)	99% occupied bandwidth (kHz)
141	8.122	6.992

Test plots as below:

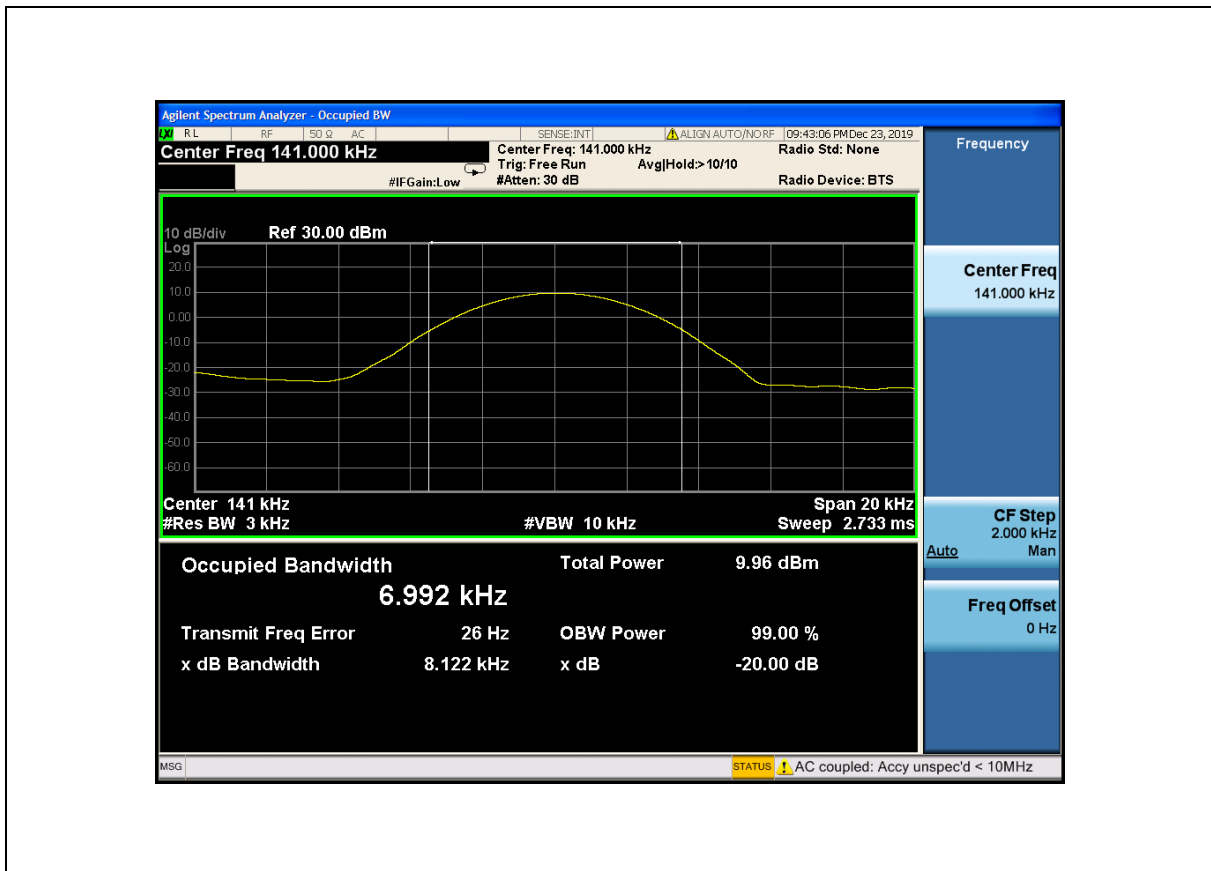

Photographs of the Test Setup

Radiated emission

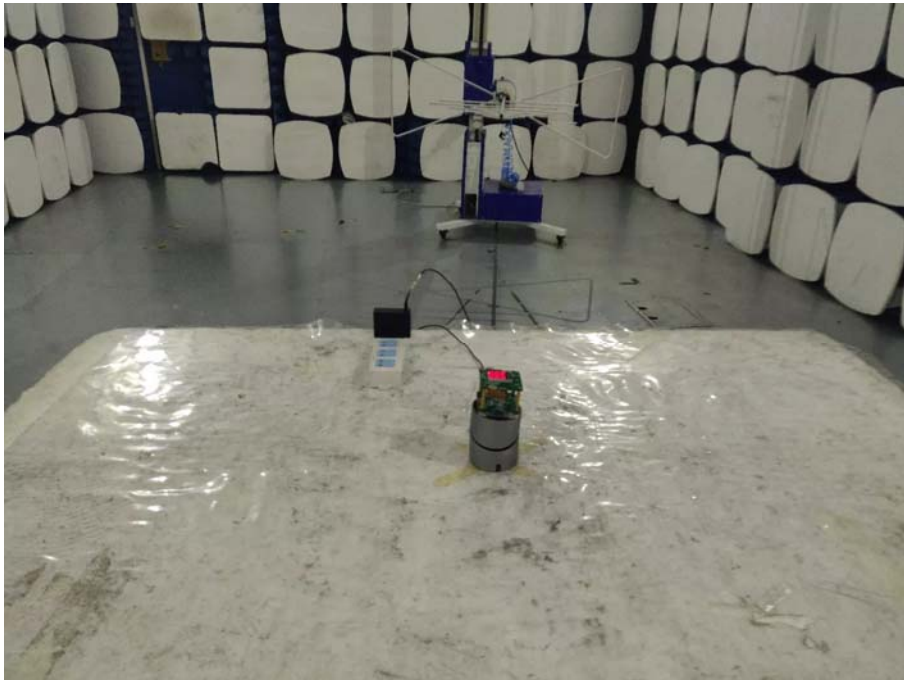

Conducted emission





Photographs of the EUT

See the APPENDIX 1: EUT PHOTOS in the report No.: MTi19112810-2E1-1.

----END OF REPORT----