

# FCC Part 15C Test Report

## FCC ID: 2AFOSWT8266

Product Name:	<b>WT8266</b>
Trademark:	<b>N/A</b>
Model Name :	<b>WT8266</b>
Prepared For :	<b>WIRELESS-TAG TECHNOLOGY CO., LIMITED</b>
Address :	<b>4/F., BAK Sci &amp; Tech Building, No. 9 Keyan Road, Science &amp; Technology Park Central, Nanshan District, Shenzhen, China(Post Code:518057)</b>
Prepared By :	<b>Shenzhen BCTC Technology Co., Ltd.</b>
Address :	<b>No.101,Yousong Road,Longhua New District, Shenzhen,China</b>
Test Date:	<b>Aug. 8 - Aug. 18, 2015</b>
Date of Report :	<b>Aug. 19, 2015</b>
Report No.:	<b>BCTC-15080200</b>

## TEST RESULT CERTIFICATION

**Applicant's name** ..... : WIRELESS-TAG TECHNOLOGY CO., LIMITED  
Address ..... : 4/F., BAK Sci & Tech Building, No. 9 Keyan Road, Science & Technology Park Central, Nanshan District, Shenzhen, China(Post Code:518057)

**Manufacture's Name** ..... : WIRELESS-TAG TECHNOLOGY CO., LIMITED  
Address ..... : 4/F., BAK Sci & Tech Building, No. 9 Keyan Road, Science & Technology Park Central, Nanshan District, Shenzhen, China(Post Code:518057)

### Product description

Product name ..... : WT8266

Model and/or type reference : WT8266

Serial Model ..... : N/A

**Standards** ..... : FCC Part15.247

Test procedure ..... ANSI C63.10-2013

This device described above has been tested by BCTC, and the test results show that the equipment under test (EUT) is in compliance with the FCC requirements. And it is applicable only to the tested sample identified in the report.

This report shall not be reproduced except in full, without the written approval of BCTC, this document may be altered or revised by BCTC, personal only, and shall be noted in the revision of the document.

Testing Engineer : Eric Yang  
(Eric Yang)

Technical Manager : Sophie Lu  
(Sophia Lee)

Authorized Signatory : Casey Wang  
(Casey Wang)



## Table of Contents

	Page
<b>1 . SUMMARY OF TEST RESULTS</b>	<b>5</b>
1.1 TEST FACILITY	5
1.2 MEASUREMENT UNCERTAINTY	5
<b>2 . GENERAL INFORMATION</b>	<b>6</b>
2.1 GENERAL DESCRIPTION OF EUT	6
2.2 DESCRIPTION OF TEST MODES	7
2.3 BLOCK DIGRAM SHOWING THE CONFIGURATION OF SYSTEM TESTED	8
2.4 DESCRIPTION OF SUPPORT UNITS(CONDUCTED MODE)	8
2.5 EQUIPMENTS LIST FOR ALL TEST ITEMS	9
<b>3 . EMC EMISSION TEST</b>	<b>10</b>
3.1 CONDUCTED EMISSION MEASUREMENT	10
3.1.1 POWER LINE CONDUCTED EMISSION LIMITS	10
3.1.2 TEST PROCEDURE	10
3.1.3 DEVIATION FROM TEST STANDARD	10
3.1.4 TEST SETUP	11
3.1.5 EUT OPERATING CONDITIONS	11
3.1.6 TEST RESULTS	11
3.2 RADIATED EMISSION MEASUREMENT	12
3.2.1 RADIATED EMISSION LIMITS	12
3.2.2 TEST PROCEDURE	12
3.2.3 DEVIATION FROM TEST STANDARD	13
3.2.4 TEST SETUP	13
3.2.5 EUT OPERATING CONDITIONS	14
3.2.6 TEST RESULTS (BETWEEN 9KHZ – 30 MHZ)	15
3.2.7 TEST RESULTS (BETWEEN 30MHZ – 1GHZ)	16
3.2.8 TEST RESULTS (ABOVE 1000 MHZ)	18
<b>4 . POWER SPECTRAL DENSITY TEST</b>	<b>23</b>
4.1 APPLIED PROCEDURES / LIMIT	23
4.1.1 TEST PROCEDURE	23
4.1.2 DEVIATION FROM STANDARD	23
4.1.3 TEST SETUP	23
4.1.4 EUT OPERATION CONDITIONS	23
4.1.5 TEST RESULTS	24
<b>5 . BANDWIDTH TEST</b>	<b>30</b>
5.1 APPLIED PROCEDURES / LIMIT	30
5.1.1 TEST PROCEDURE	30
5.1.2 DEVIATION FROM STANDARD	30
5.1.3 TEST SETUP	30
5.1.4 EUT OPERATION CONDITIONS	30

## Table of Contents

	Page
5.1.5 TEST RESULTS	31
<b>6 . PEAK OUTPUT POWER TEST</b>	<b>37</b>
6.1 APPLIED PROCEDURES / LIMIT	37
6.1.1 TEST PROCEDURE	37
6.1.2 DEVIATION FROM STANDARD	37
6.1.3 TEST SETUP	37
6.1.4 EUT OPERATION CONDITIONS	37
6.1.5 TEST RESULTS	38
<b>7 . 100 KHZ BANDWIDTH OF FREQUENCY BAND EDGE</b>	<b>39</b>
7.1 DEVIATION FROM STANDARD	39
7.2 TEST SETUP	39
7.3 EUT OPERATION CONDITIONS	40
7.4 TEST RESULTS	40
<b>8 . ANTENNA REQUIREMENT</b>	<b>45</b>
8.1 STANDARD REQUIREMENT	45
8.2 EUT ANTENNA	45
<b>9 . EUT TEST PHOTO</b>	<b>46</b>
<b>10 . PHOTO OF THE EUT</b>	<b>47</b>

## 1. SUMMARY OF TEST RESULTS

Test procedures according to the technical standards:

FCC Part15 (15.247) , Subpart C			
Standard Section	Test Item	Judgment	Remark
15.207	Conducted Emission	N/A	
15.247 (a)(2)	6dB Bandwidth	PASS	
15.247 (b)	Peak Output Power	PASS	
15.247 (c)	Radiated Spurious Emission	PASS	
15.247 (d)	Power Spectral Density	PASS	
15.205	Band Edge Emission	PASS	
15.203	Antenna Requirement	PASS	

NOTE:

(1) "N/A" denotes test is not applicable in this Test Report

Test produce reference KDB558074 D01 DTS Meas Guidance v03r03

### 1.1 TEST FACILITY

Shenzhen BCTC Technology Co., Ltd.

Add. : No.101,Yousong Road,Longhua New District, Shenzhen,China

FCC Registered No.: 187086

### 1.2 MEASUREMENT UNCERTAINTY

The reported uncertainty of measurement  $y \pm U$  , where expanded uncertainty  $U$  is based on a standard uncertainty multiplied by a coverage factor of  $k=2$  , providing a level of confidence of approximately **95** %.

No.	Item	Uncertainty
1	Conducted Emission Test	$\pm 1.38\text{dB}$
2	RF power,conducted	$\pm 0.16\text{dB}$
3	Spurious emissions,conducted	$\pm 0.21\text{dB}$
4	All emissions,radiated(<1G)	$\pm 4.68\text{dB}$
5	All emissions,radiated(>1G)	$\pm 4.89\text{dB}$
6	Temperature	$\pm 0.5^{\circ}\text{C}$
7	Humidity	$\pm 2\%$

## 2. GENERAL INFORMATION

### 2.1 GENERAL DESCRIPTION OF EUT

Equipment	WT8266	
Trade Name	N/A	
Model Name	WT8266	
Serial Model	N/A	
Model Difference	All the model are the same circuit and RF module,except model names.	
Product Description	The EUT is a WT8266	
	Operation Frequency:	802.11b/g/n20MHz:2412~2462 MHz
	Modulation Type:	OFDM/DSSS
	Bit Rate of Transmitter	802.11b:11/5.5/2/1 Mbps 802.11g:54/48/36/24/18/12/9/6Mbps 802.11n Up to 72Mbps
	Number Of Channel	11 CH, Please see Note 2.
	Antenna Designation:	Please see Note 3.
	Antenna Gain (dBi)	0.0dbi
	Based on the application, features, or specification exhibited in User's Manual, the EUT is considered as an ITE/Computing Device. More details of EUT technical specification, please refer to the User's Manual.	
Channel List	Please refer to the Note 2.	
Adapter	N/A	
Battery	N/A	
Connecting I/O Port(s)	Please refer to the User's Manual	

Note:

1. For a more detailed features description, please refer to the manufacturer's specifications or the User's Manual.

2.

Channel List for 802.11b/g/n(20)							
Channel	Frequency (MHz)	Channel	Frequency (MHz)	Channel	Frequency (MHz)	Channel	Frequency (MHz)
01	2412	04	2427	07	2442	10	2457
02	2417	05	2432	08	2447	11	2462
03	2422	06	2437	09	2452		

3.

Table for Filed Antenna

Ant	Brand	Model Name	Antenna Type	Connector	Gain (dBi)	NOTE
A	N/A	N/A	PIFA Antenna	N/A	1.0	Wifi Antenna

## 2.2 DESCRIPTION OF TEST MODES

To investigate the maximum EMI emission characteristics generated from EUT, the test system was pre-scanning tested based on the consideration of following EUT operation mode or test configuration mode which possibly have effect on EMI emission level. Each of these EUT operation mode(s) or test configuration mode(s) mentioned above was evaluated respectively.

Pretest Mode	Description
Mode 1	802.11b CH1/ CH6/ CH11
Mode 2	802.11g CH1/ CH6/ CH11
Mode 3	802.11n CH1/ CH6/ CH11
Mode 4	Link Mode

For Conducted Emission	
Final Test Mode	Description
Mode 4	Link Mode

For Radiated Emission	
Final Test Mode	Description
Mode 1	802.11b CH1/ CH6/ CH11
Mode 2	802.11g CH1/ CH6/ CH11
Mode 3	802.11n CH1/ CH6/ CH11

Note:

- (1) The measurements are performed at the highest, middle, lowest available channels.
- (2) The measurements are performed at all Bit Rate of Transmitter, the worst data was reported

### 2.3 BLOCK DIGRAM SHOWING THE CONFIGURATION OF SYSTEM TESTED

Radiated Spurious Emission Test

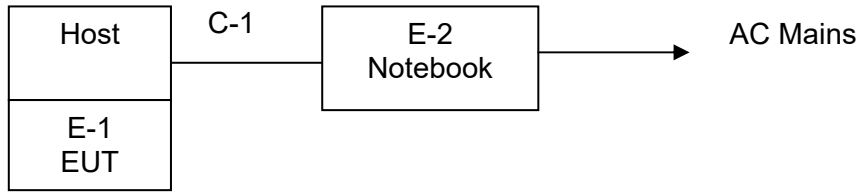

### 2.4 DESCRIPTION OF SUPPORT UNITS(CONDUCTED MODE)

The EUT has been tested as an independent unit together with other necessary accessories or support units. The following support units or accessories were used to form a representative test configuration during the tests.

Item	Equipment	Mfr/Brand	Model/Type No.	Series No.	Note
E-1	WT8266	N/A	WT8266	N/A	EUT
E-2	Notebook	ASUS	X550C	N/A	

Item	Shielded Type	Ferrite Core	Length	Note
C1	NO	NO	0.8M	

Note:

- (1) The support equipment was authorized by Declaration of Confirmation.
- (2) For detachable type I/O cable should be specified the length in cm in 『Length』 column.



## 2.5 EQUIPMENTS LIST FOR ALL TEST ITEMS

### Radiation Test equipment

Item	Kind of Equipment	Manufacturer	Type No.	Serial No.	Last calibration	Calibrated until	Calibration period
1	Spectrum Analyzer	Agilent	E4407B	MY4510957 2	2014.08.25	2015.08.24	1 year
2	Test Receiver	R&S	ESPI	101396	2014.08.25	2015.08.24	1 year
3	Bilog Antenna	SCHWARZBECK	VULB9160	VULB9160- 3369	2014.08.25	2015.08.24	1 year
4	50Ω Coaxial Switch	Anritsu	MP59B	620026441 6	2015.06.07	2016.06.06	1 year
5	Spectrum Analyzer	ADVANTEST	R3132	150900201	2015.06.07	2016.06.06	1 year
6	Horn Antenna	SCHWARZBECK	9120D	9120D-1275	2014.08.25	2015.08.24	1 year
7	Horn Ant	Schwarzbeck	BBHA 9170	9170-181	2015.07.06	2016.07.05	1 year
8	Amplifier	SCHWARZBECK	BBV9718	9718-270	2014.08.25	2015.08.24	1 year
9	Amplifier	SCHWARZBECK	BBV9743	9743-119	2014.08.25	2015.08.24	1 year
10	Loop Antenna	ARA	PLA-1030/B	1029	2015.06.08	2016.06.07	1 year
11	Power Meter	Anritsu	ML2495A	1005008	2015.07.24	2016.07.24	1 year
12	Power Sensor	Anritsu	ML2411B	917018	2015.07.24	2016.07.24	1 year
13	RF cables	R&S	N/A	N/A	2015.07.06	2016.07.05	1 year

### 3. EMC EMISSION TEST

#### 3.1 CONDUCTED EMISSION MEASUREMENT

##### 3.1.1 POWER LINE CONDUCTED EMISSION Limits (Frequency Range 150KHz-30MHz)

FREQUENCY (MHz)	Class A (dBuV)		Class B (dBuV)		Standard
	Quasi-peak	Average	Quasi-peak	Average	
0.15 -0.5	79.00	66.00	66 - 56 *	56 - 46 *	CISPR
0.50 -5.0	73.00	60.00	56.00	46.00	CISPR
5.0 -30.0	73.00	60.00	60.00	50.00	CISPR

0.15 -0.5	79.00	66.00	66 - 56 *	56 - 46 *	FCC
0.50 -5.0	73.00	60.00	56.00	46.00	FCC
5.0 -30.0	73.00	60.00	60.00	50.00	FCC

Note:

- (1) The tighter limit applies at the band edges.
- (2) The limit of " \* " marked band means the limitation decreases linearly with the logarithm of the frequency in the range.

The following table is the setting of the receiver

Receiver Parameters	Setting
Attenuation	10 dB
Start Frequency	0.15 MHz
Stop Frequency	30 MHz
IF Bandwidth	9 kHz

##### 3.1.2 TEST PROCEDURE

- a. The EUT was placed 0.8 meters from the horizontal ground plane with EUT being connected to the power mains through a line impedance stabilization network (LISN). All other support equipments powered from additional LISN(s). The LISN provide 50 Ohm/ 50uH of coupling impedance for the measuring instrument.
- b. Interconnecting cables that hang closer than 40 cm to the ground plane shall be folded back and forth in the center forming a bundle 30 to 40 cm long.
- c. I/O cables that are not connected to a peripheral shall be bundled in the center. The end of the cable may be terminated, if required, using the correct terminating impedance. The overall length shall not exceed 1 m.
- d. LISN at least 80 cm from nearest part of EUT chassis.
- e. For the actual test configuration, please refer to the related Item –EUT Test Photos.

##### 3.1.3 DEVIATION FROM TEST STANDARD

No deviation

### 3.1.4 TEST SETUP

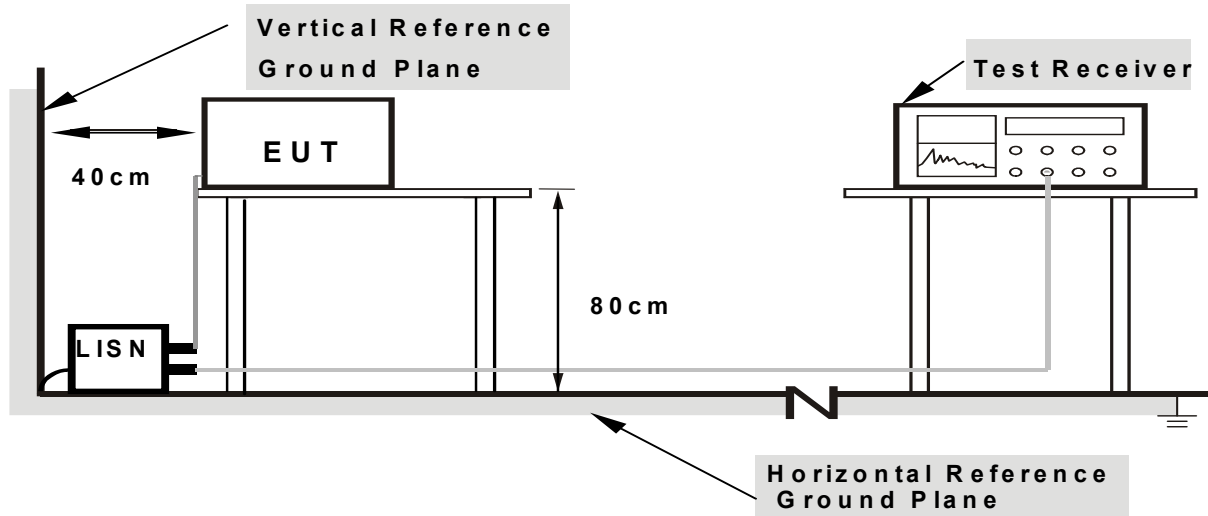

**Note: 1. Support units were connected to second LISN.**

**2. Both of LISNs (AMN) are 80 cm from EUT and at least 80 from other units and other metal planes**

### 3.1.5 EUT OPERATING CONDITIONS

The EUT was configured for testing in a typical fashion (as a customer would normally use it). The EUT has been programmed to continuously transmit during test. This operating condition was tested and used to collect the included data.

### 3.1.6 TEST RESULTS

EUT :	WT8266	Model Name. :	WT8266
Temperature :	26°C	Relative Humidity :	54%
Pressure :	1010hPa	Phase :	/
Test Voltage :	DC 3.3V	Test Mode :	Mode 1

The product's power provide by host, no requirment for conduct test.

### 3.2 RADIATED EMISSION MEASUREMENT

#### 3.2.1 RADIATED EMISSION LIMITS (Frequency Range 9kHz-1000MHz)

20dBc in any 100 kHz bandwidth outside the operating frequency band. In case the emission fall within the restricted band specified on 15.205(a), then the 15.209(a) limit in the table below has to be followed.

Frequencies (MHz)	Field Strength (micorvolts/meter)	Measurement Distance (meters)
0.009~0.490	2400/F(KHz)	300
0.490~1.705	24000/F(KHz)	30
1.705~30.0	30	30
30~88	100	3
88~216	150	3
216~960	200	3
Above 960	500	3

#### LIMITS OF RADIATED EMISSION MEASUREMENT (Above 1000MHz)

FREQUENCY (MHz)	Class A (dBuV/m) (at 3M)		Class B (dBuV/m) (at 3M)	
	PEAK	AVERAGE	PEAK	AVERAGE
Above 1000	80	60	74	54

Notes:

- (1) The limit for radiated test was performed according to FCC PART 15C.
- (2) The tighter limit applies at the band edges.
- (3) Emission level (dBuV/m)=20log Emission level (uV/m).

Spectrum Parameter	Setting
Attenuation	Auto
Start Frequency	1000 MHz
Stop Frequency	10th carrier harmonic
RB / VB (emission in restricted band)	1 MHz / 1 MHz for Peak, 1 MHz / 10Hz for Average

Receiver Parameter	Setting
Attenuation	Auto
Start ~ Stop Frequency	9kHz~150kHz / RB 200Hz for QP
Start ~ Stop Frequency	150kHz~30MHz / RB 9kHz for QP
Start ~ Stop Frequency	30MHz~1000MHz / RB 120kHz for QP

#### 3.2.2 TEST PROCEDURE

- a. The measuring distance of at 3 m shall be used for measurements at frequency up to 1GHz. For frequencies above 1GHz, any suitable measuring distance may be used.

- b. The EUT was placed on the top of a rotating table 0.8 meters above the ground at a 3 meter open area test site. The table was rotated 360 degrees to determine the position of the highest radiation.
- c. The height of the equipment or of the substitution antenna shall be 0.8 m; the height of the test antenna shall vary between 1 m to 4 m. Both horizontal and vertical polarizations of the antenna are set to make the measurement.
- d. The initial step in collecting conducted emission data is a spectrum analyzer peak detector mode pre-scanning the measurement frequency range. Significant peaks are then marked and then Quasi Peak detector mode re-measured.
- e. If the Peak Mode measured value compliance with and lower than Quasi Peak Mode Limit, the EUT shall be deemed to meet QP Limits and then no additional QP Mode measurement performed.
- f. For the actual test configuration, please refer to the related Item –EUT Test Photos.

Note:

Both horizontal and vertical antenna polarities were tested and performed pretest to three orthogonal axis. The worst case emissions were reported

### 3.2.3 DEVIATION FROM TEST STANDARD

No deviation

### 3.2.4 TEST SETUP

(A) Radiated Emission Test-Up Frequency Below 30MHz

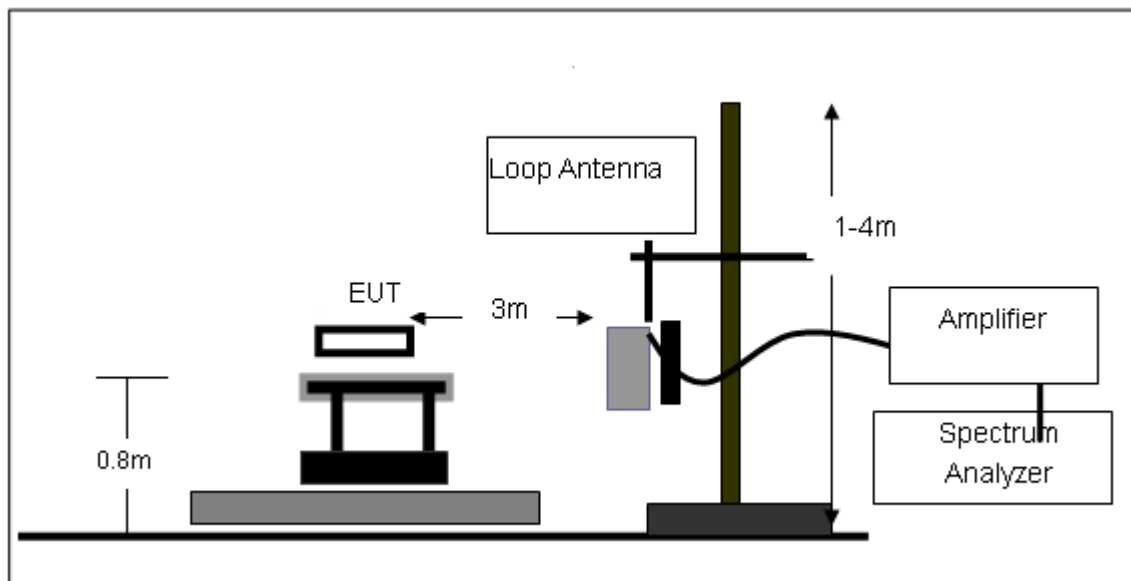

(B) Radiated Emission Test-Up Frequency 30MHz~1GHz

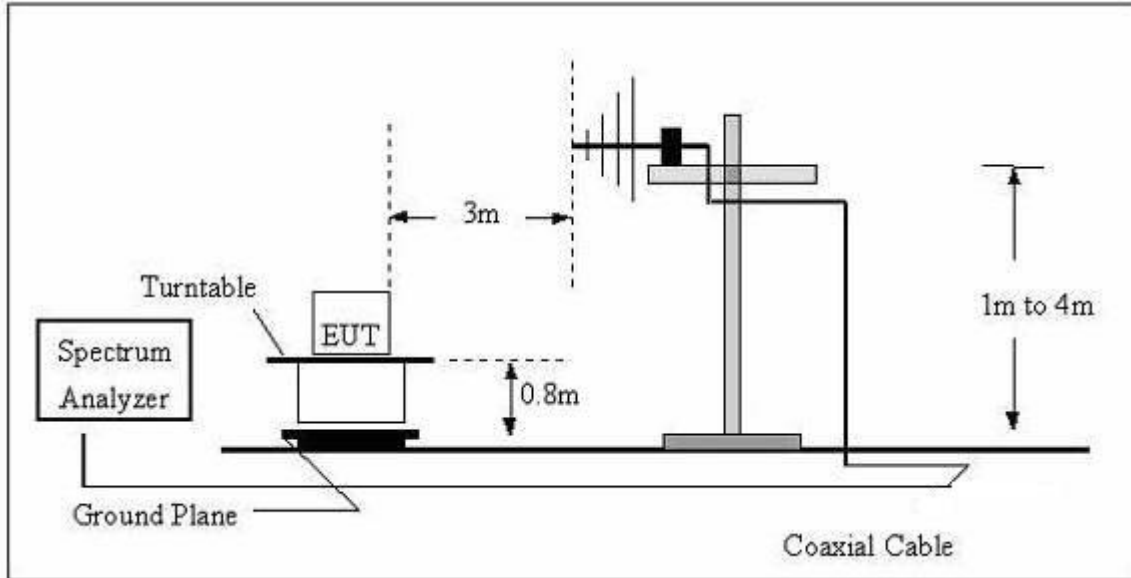

(C) Radiated Emission Test-Up Frequency Above 1GHz

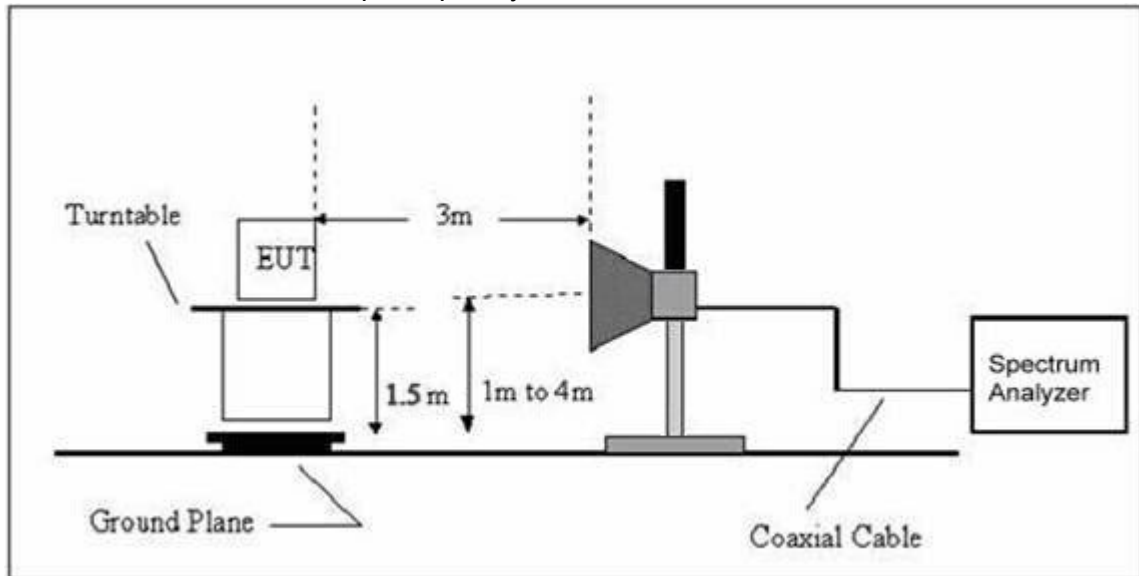

### 3.2.5 EUT OPERATING CONDITIONS

The EUT tested system was configured as the statements of 2.4 Unless otherwise a special operating condition is specified in the follows during the testing.

### 3.2.6 TEST RESULTS (BETWEEN 9KHZ – 30 MHZ)

EUT:	WT8266	Model Name. :	WT8266
Temperature:	20°C	Relative Humidity:	48%
Pressure:	1010 hPa	Test Voltage :	AC120V/60Hz
Test Mode :	TX	Polarization :	--

Freq.	Reading	Limit	Margin	State
(MHz)	(dBuV/m)	(dBuV/m)	(dB)	P/F
--	--	--	--	PASS
--	--	--	--	PASS

#### NOTE:

The amplitude of spurious emissions which are attenuated by more than 20dB below the permissible value has no need to be reported.

Distance extrapolation factor =  $40 \log (\text{specific distance}/\text{test distance})(\text{dB})$ ;

Limit line = specific limits(dBuv) + distance extrapolation factor.

### 3.2.7 TEST RESULTS (BETWEEN 30MHZ – 1GHZ)

EUT :	WT8266	Model Name :	WT8266
Temperature :	26°C	Relative Humidity :	54%
Pressure :	1010 hPa	Polarization :	Horizontal
Test Voltage :	DC5V from laptop		
Test Mode :	TX		

Frequency (MHz)	Meter Reading (dBuV)	Factor (dB)	Emission Level (dBuV/m)	Limits (dBuV/m)	Margin (dB)	Remark
57.3922	11.26	8.58	19.84	40.00	-20.16	QP
250.3011	11.29	13.59	24.88	46.00	-21.12	QP
350.4768	14.58	16.26	30.84	46.00	-15.16	QP
365.5391	14.39	16.88	31.27	46.00	-14.73	QP
400.4319	14.38	18.32	32.70	46.00	-13.30	QP
451.1350	14.13	19.33	33.46	46.00	-12.54	QP

Remark:  
 Factor = Antenna Factor + Cable Loss – Pre-amplifier.  
 All interfaces was connected, and TX mode was link.

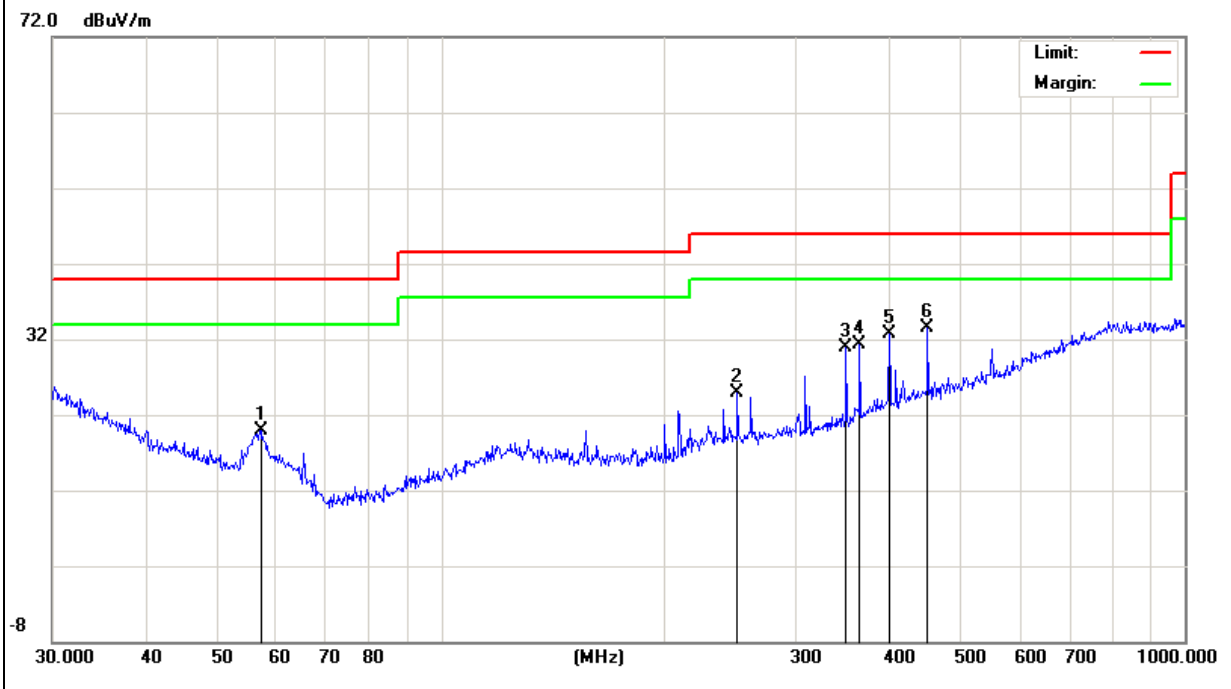



EUT :	WT8266	Model Name :	WT8266
Temperature :	26°C	Relative Humidity :	54%
Pressure :	1010 hPa	Polarization :	Vertical
Test Voltage :	DC5V from laptop		
Test Mode :	TX		

Frequency (MHz)	Meter Reading (dBuV)	Factor (dB)	Emission Level (dBuV/m)	Limits (dBuV/m)	Margin (dB)	Remark
43.5057	14.70	12.41	27.11	40.00	-12.89	QP
111.7380	17.52	10.32	27.84	43.50	-15.66	QP
152.1297	14.80	10.42	25.22	43.50	-18.28	QP
183.2005	14.44	10.65	25.09	43.50	-18.41	QP
219.8449	17.27	12.13	29.40	46.00	-16.60	QP
321.0608	19.40	15.03	34.43	46.00	-11.57	QP

Remark:  
Factor = Antenna Factor + Cable Loss – Pre-amplifier.  
All interfaces was connected, and TX mode was link.

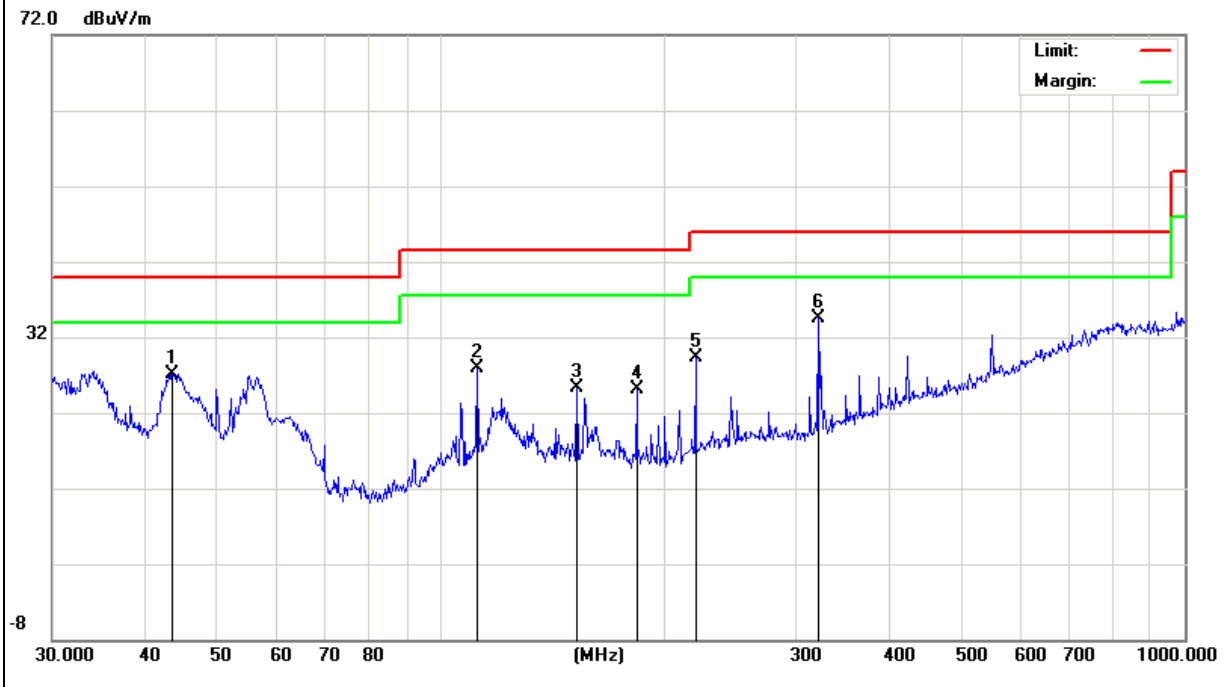

### 3.2.8 TEST RESULTS (ABOVE 1000 MHZ)

#### 802.11b

Normal Voltage

Polar (H/V)	Frequency	Meter Reading	Factor	Emission Level	Limits	Margin	Detector Type
	(MHz)	(dBuV)	(dB)	(dBuV/m)	(dBuV/m)	(dB)	
<b>operation frequency:2412</b>							
V	4824.165	65.02	-3.6	61.42	74	-12.58	Pk
V	4824.165	46.09	-3.6	42.49	54	-11.51	AV
H	4824.316	65.15	-3.58	61.57	74	-12.43	Pk
H	4824.316	44.20	-3.58	40.62	54	-13.38	AV
<b>Remark:</b>							
Absolute Level= ReadingLevel+ Factor, Margin= Limit- Absolute Level							

#### 802.11b

Normal Voltage

Polar (H/V)	Frequency	Meter Reading	Factor	Emission Level	Limits	Margin	Detector Type
	(MHz)	(dBuV)	(dB)	(dBuV/m)	(dBuV/m)	(dB)	
<b>operation frequency:2437</b>							
V	4875.148	62.77	-3.64	59.13	74	-14.87	Pk
V	4875.148	44.27	-3.64	40.63	54	-13.37	AV
H	4874.359	63.88	-3.64	60.24	74	-13.76	Pk
H	4874.359	41.53	-3.64	37.89	54	-16.11	AV
<b>Remark:</b>							
Absolute Level= ReadingLevel+ Factor, Margin= Limit- Absolute Level							

#### 802.11b

Normal Voltage

Polar (H/V)	Frequency	Meter Reading	Factor	Emission Level	Limits	Margin	Detector Type
	(MHz)	(dBuV)	(dB)	(dBuV/m)	(dBuV/m)	(dB)	
<b>operation frequency:2462</b>							
V	4924.367	62.75	-3.64	59.11	74	-14.89	pk
H	4924.367	61.59	-3.66	57.93	74	-16.07	pk
<b>Remark:</b>							
Absolute Level= ReadingLevel+ Factor, Margin= Limit- Absolute Level							

**802.11g**

Normal Voltage

Polar (H/V)	Frequency	Meter Reading	Factor	Emission Level	Limits	Margin	Detector Type
	(MHz)	(dBuV)	(dB)	(dBuV/m)	(dBuV/m)	(dB)	
<b>operation frequency:2412</b>							
V	4824.362	63.98	-3.6	60.38	74	-13.62	Pk
V	4824.362	43.29	-3.6	39.69	54	-34.31	AV
H	4824.518	63.33	-3.6	59.73	74	-14.27	Pk
H	4824.518	43.22	-3.6	39.62	54	-14.38	AV
<b>Remark:</b>							
Absolute Level= ReadingLevel+ Factor, Margin= Limit- Absolute Level							

**802.11g**

Normal Voltage

Polar (H/V)	Frequency	Meter Reading	Factor	Emission Level	Limits	Margin	Detector Type
	(MHz)	(dBuV)	(dB)	(dBuV/m)	(dBuV/m)	(dB)	
<b>operation frequency:2437</b>							
V	4873.538	63.72	-3.63	60.09	74	-13.91	Pk
V	4873.538	45.79	-3.63	42.16	54	-31.84	AV
H	4874.127	64.86	-3.64	61.22	74	-12.78	Pk
H	4874.127	45.30	-3.64	41.66	54	-12.34	AV
<b>Remark:</b>							
Absolute Level= ReadingLevel+ Factor, Margin= Limit- Absolute Level							

**802.11g**

Normal Voltage

Polar (H/V)	Frequency	Meter Reading	Factor	Emission Level	Limits	Margin	Detector Type
	(MHz)	(dBuV)	(dB)	(dBuV/m)	(dBuV/m)	(dB)	
<b>operation frequency:2462</b>							
V	4924.218	60.54	-3.66	56.88	74	-17.12	pk
H	4924.183	58.94	-3.66	55.28	74	-18.72	pk
<b>Remark:</b>							
Absolute Level= ReadingLevel+ Factor, Margin= Limit- Absolute Level							

**802.11n(20MHz)**

Normal Voltage

Polar (H/V)	Frequency	Meter Reading	Factor	Emission Level	Limits	Margin	Detector Type
	(MHz)	(dBuV)	(dB)	(dBuV/m)	(dBuV/m)	(dB)	
<b>operation frequency:2412</b>							
V	4825.162	63.78	-3.58	60.20	74	-13.80	Pk
V	4825.162	46.51	-3.58	42.93	54	-11.07	AV
H	4824.341	64.63	-3.6	61.03	74	-12.97	Pk
H	4824.341	45.05	-3.6	41.45	54	-12.55	AV
<b>Remark:</b>							
Absolute Level= ReadingLevel+ Factor, Margin= Limit- Absolute Level							

**802.11n(20MHz)**

Normal Voltage

Polar (H/V)	Frequency	Meter Reading	Factor	Emission Level	Limits	Margin	Detector Type
	(MHz)	(dBuV)	(dB)	(dBuV/m)	(dBuV/m)	(dB)	
<b>operation frequency:2437</b>							
V	4874.284	65.88	-3.63	62.25	74	-11.75	Pk
V	4874.284	43.82	-3.63	40.19	54	-13.81	AV
H	4873.729	63.88	-3.64	60.24	74	-13.76	Pk
H	4873.729	42.44	-3.64	38.80	54	-15.20	AV
<b>Remark:</b>							
Absolute Level= ReadingLevel+ Factor, Margin= Limit- Absolute Level							

**802.11n(20MHz)**

Normal Voltage

Polar (H/V)	Frequency	Meter Reading	Factor	Emission Level	Limits	Margin	Detector Type
	(MHz)	(dBuV)	(dB)	(dBuV/m)	(dBuV/m)	(dB)	
<b>operation frequency:2462</b>							
V	4924.287	61.07	-3.64	57.43	74	-16.57	pk
V	4924.287	38.85	-3.64	35.21	54	-18.79	AV
H	4925.196	56.30	-3.66	52.64	74	-21.36	pk
<b>Remark:</b>							
Absolute Level= ReadingLevel+ Factor, Margin= Limit- Absolute Level							

For conducted test

All modes for 802.11b/g/n have tested, and the worst result 802.11b Low channel recorded as below.

802.11b 2412MHz

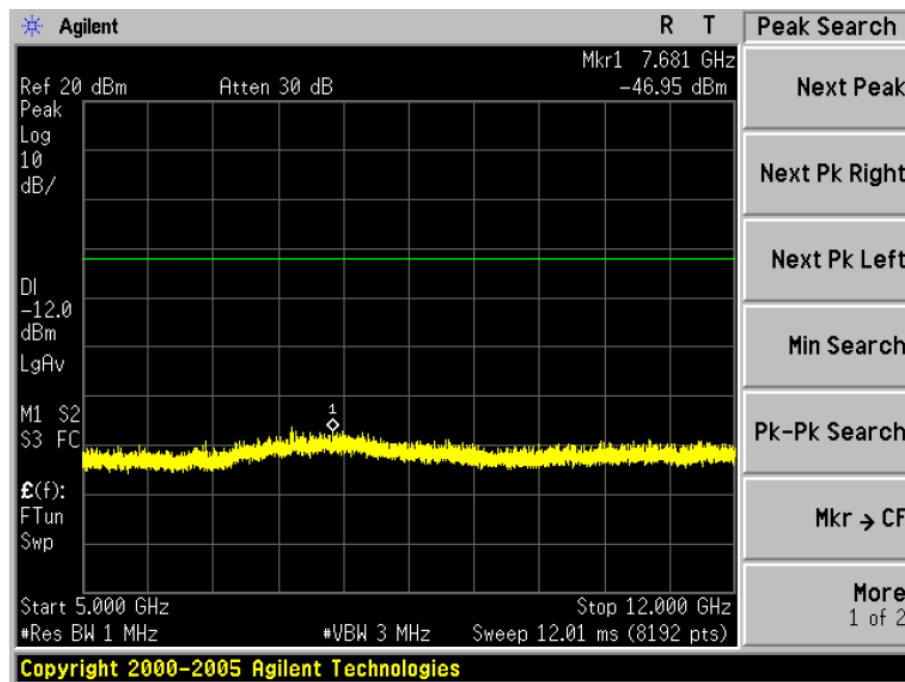
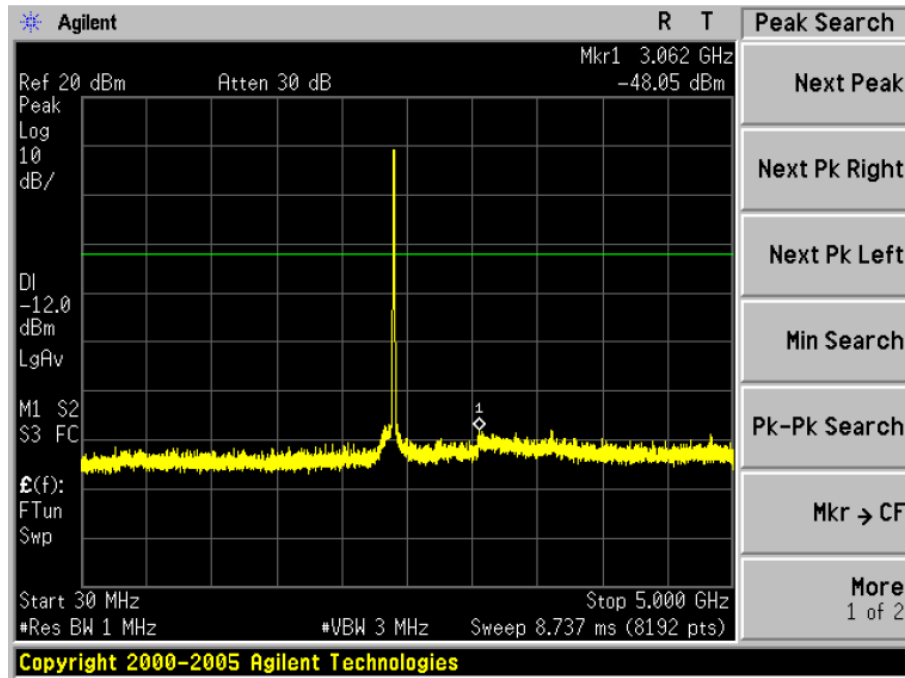

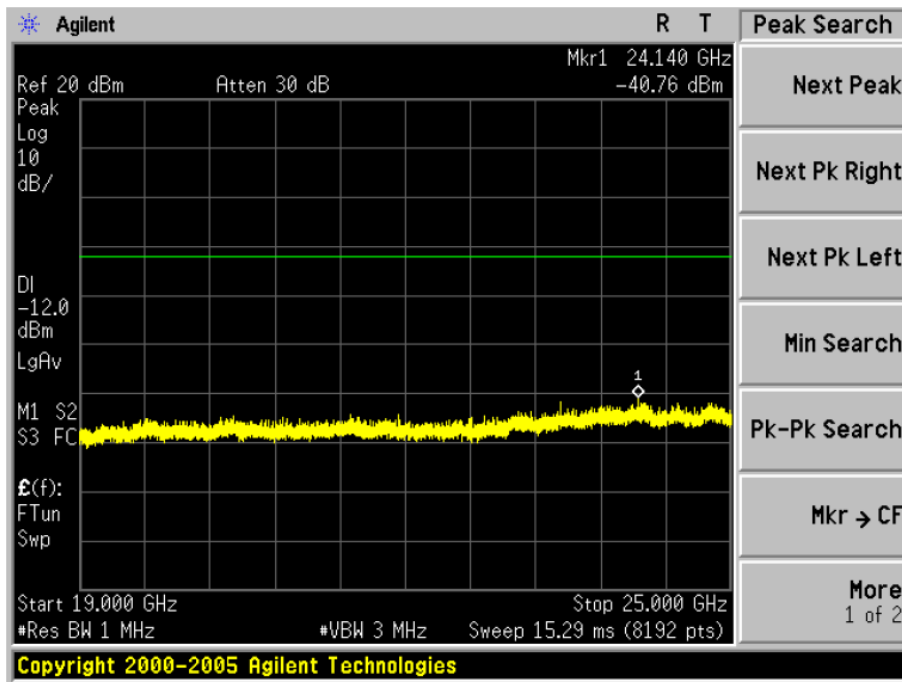
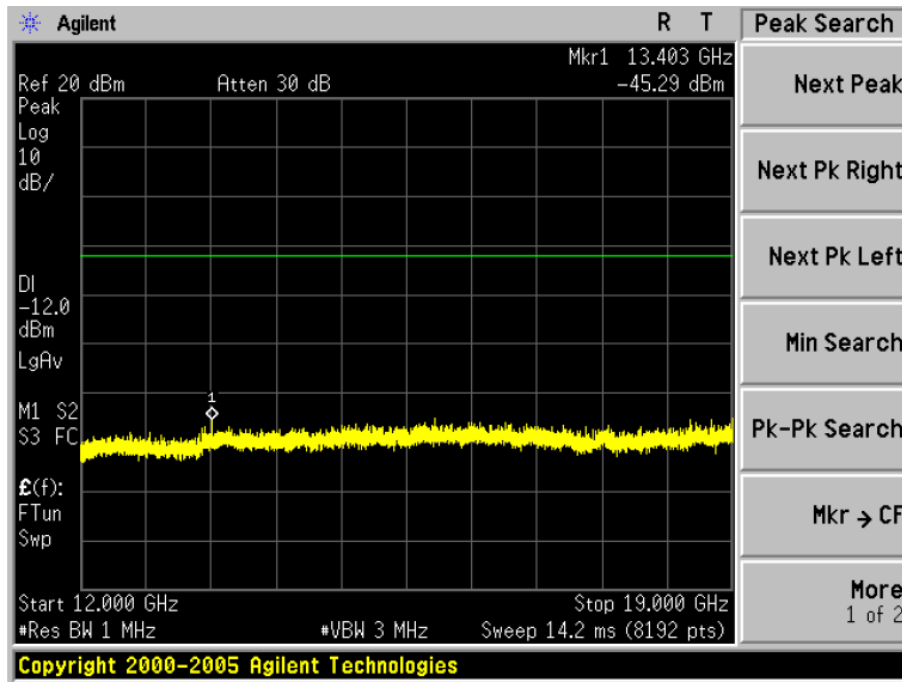

## 4. POWER SPECTRAL DENSITY TEST

### 4.1 APPLIED PROCEDURES / LIMIT

FCC Part15 (15.247) , Subpart C				
Section	Test Item	Limit	Frequency Range (MHz)	Result
15.247	Power Spectral Density	8 dBm (in any 3KHz)	2400-2483.5	PASS

#### 4.1.1 TEST PROCEDURE

1. Set analyzer center frequency to DTS channel center frequency.
2. Set the span to 1.5 times the DTS channel bandwidth.
3. Set the RBW  $\geq$  3 kHz.
4. Set the VBW  $\geq$  3 x RBW.
5. Detector = peak.
6. Sweep time = auto couple.
7. Trace mode = max hold.
8. Allow trace to fully stabilize.
9. Use the peak marker function to determine the maximum amplitude level.
10. If measured value exceeds limit, reduce RBW (no less than 3 kHz) and repeat.

#### 4.1.2 DEVIATION FROM STANDARD

No deviation.

#### 4.1.3 TEST SETUP



#### 4.1.4 EUT OPERATION CONDITIONS

The EUT tested system was configured as the statements of 2.1 Unless otherwise a special operating condition is specified in the follows during the testing.

### 4.1.5 TEST RESULTS

EUT :	WT8266	Model Name :	WT8266
Temperature :	25°C	Relative Humidity :	60%
Pressure :	1015 hPa	Test Voltage :	DC5V from laptop
Test Mode :	TX b Mode /CH01, CH06, CH11		

Frequency	Power Density (dBm)	Limit (dBm)	Result
2412 MHz	-15.15	8	PASS
2437 MHz	-14.54	8	PASS
2462 MHz	-14.77	8	PASS

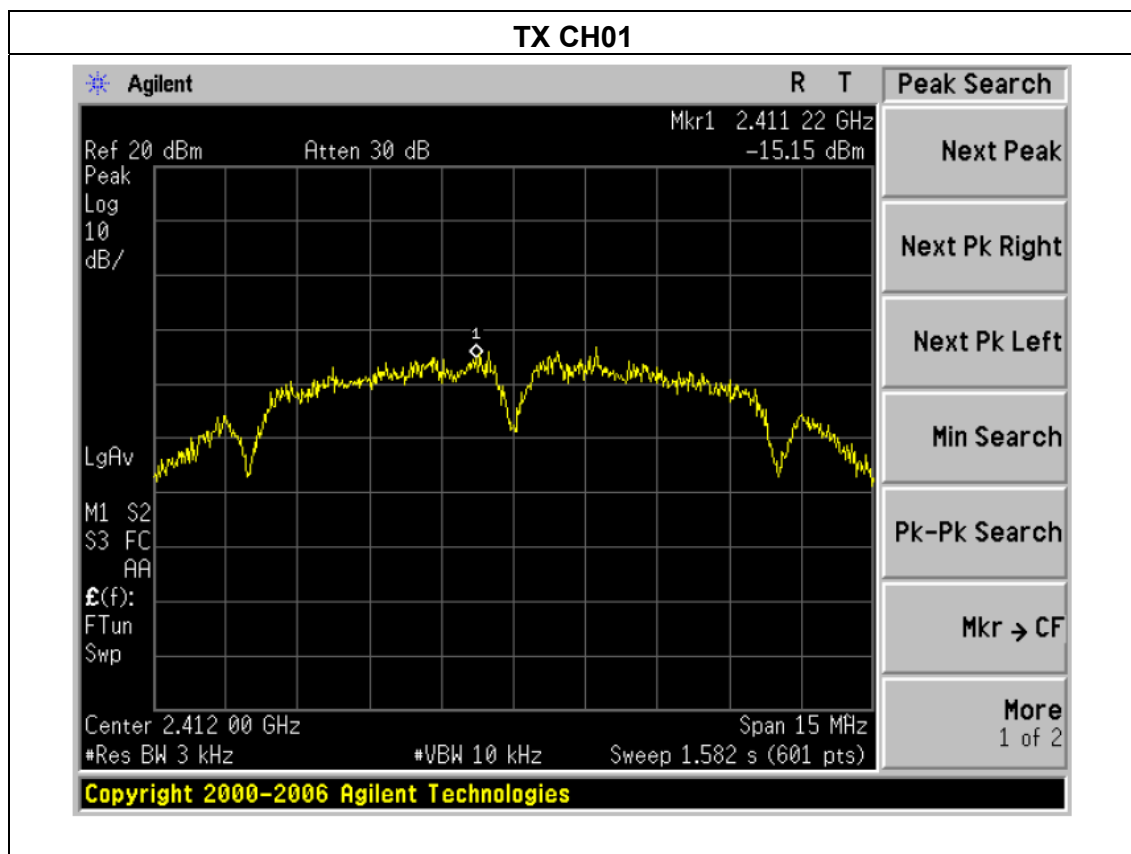



### TX CH06

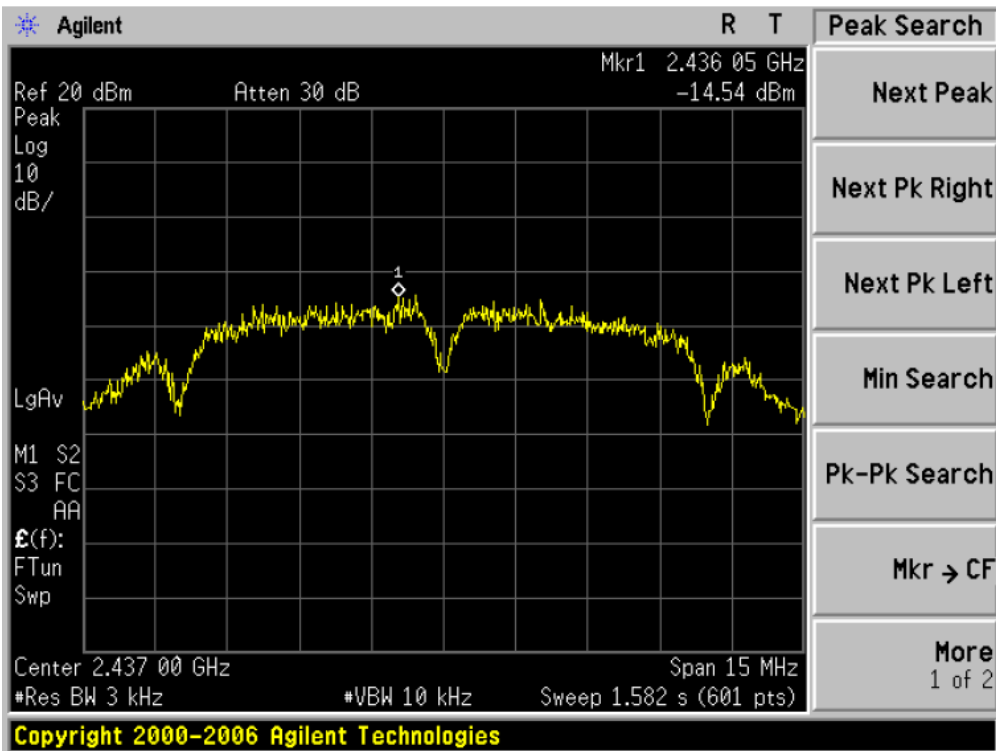

### TX CH11

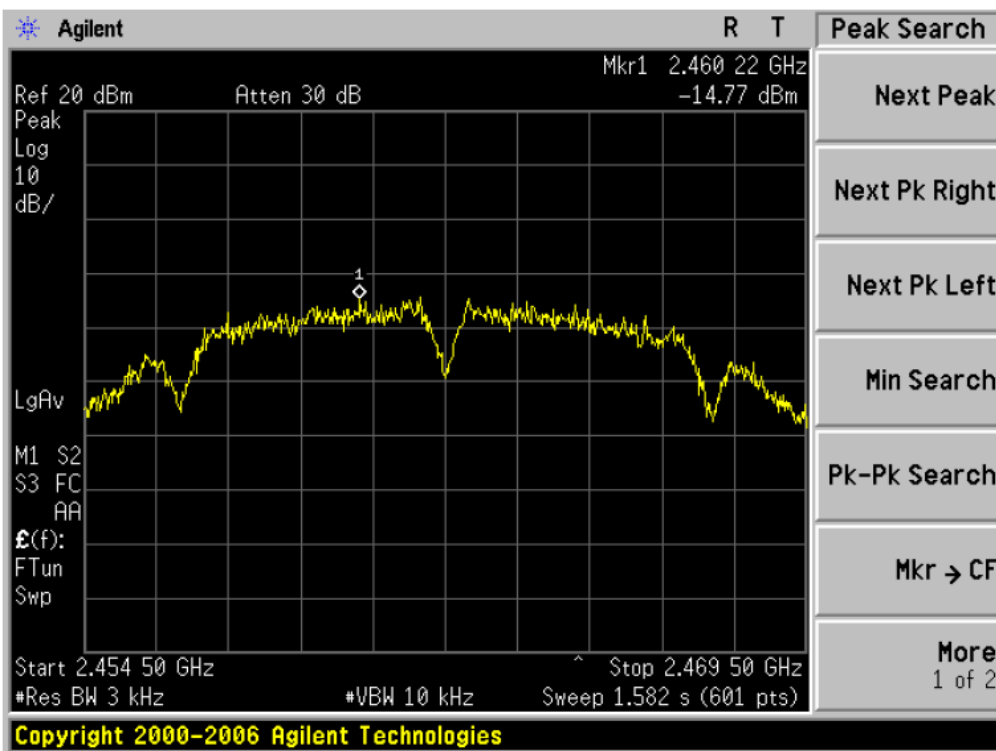

EUT :	WT8266	Model Name :	WT8266
Temperature :	25°C	Relative Humidity :	60%
Pressure :	1015 hPa	Test Voltage :	DC5V from laptop
Test Mode :	TX g Mode /CH01, CH06, CH11		

Frequency	Power Density (dBm)	Limit (dBm)	Result
2412 MHz	-19.11	8	PASS
2437 MHz	-18.47	8	PASS
2462 MHz	-21.06	8	PASS

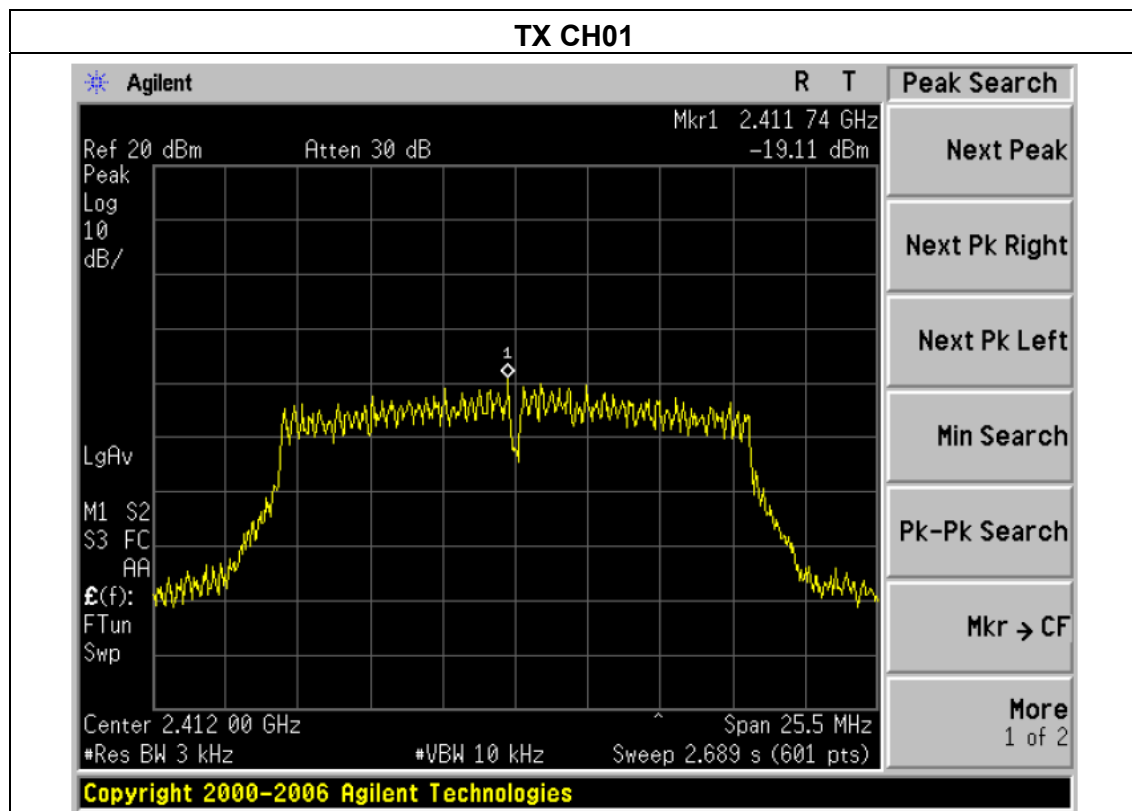

### TX CH06

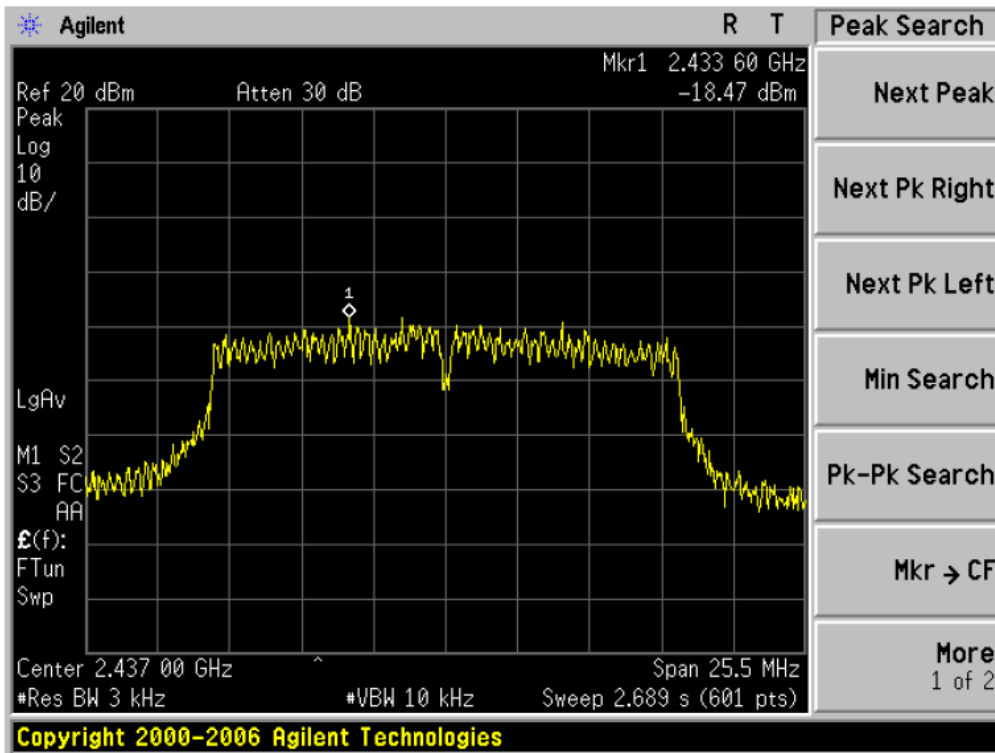

### TX CH11

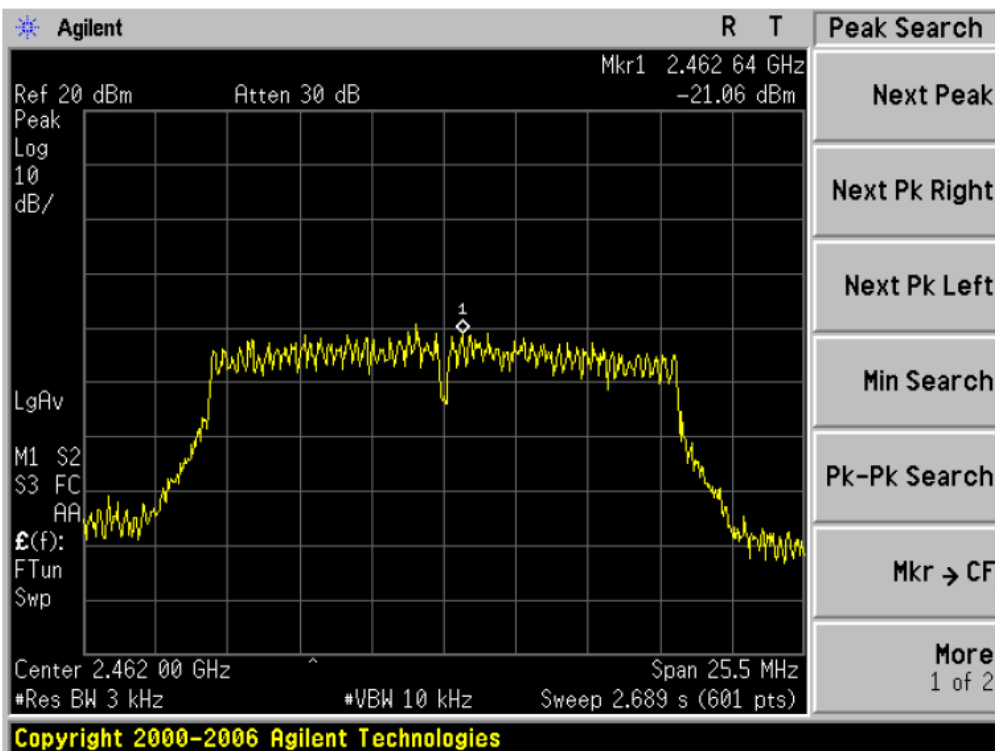

EUT :	WT8266	Model Name :	WT8266
Temperature :	25°C	Relative Humidity :	60%
Pressure :	1015 hPa	Test Voltage :	DC5V from laptop
Test Mode :	TX n Mode(20M) /CH01, CH06, CH11		

Frequency	Power Density (dBm)	Limit (dBm)	Result
2412 MHz	-19.95	8	PASS
2437 MHz	-19.24	8	PASS
2462 MHz	-20.35	8	PASS

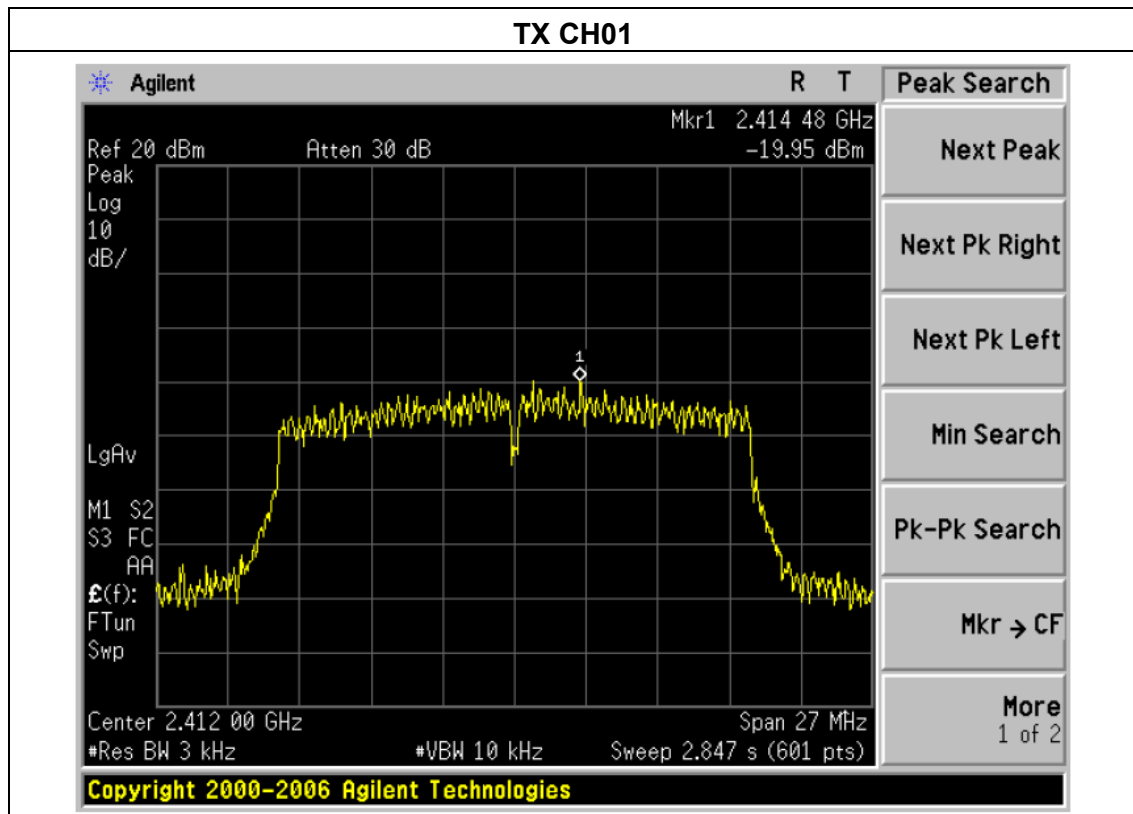

### TX CH06

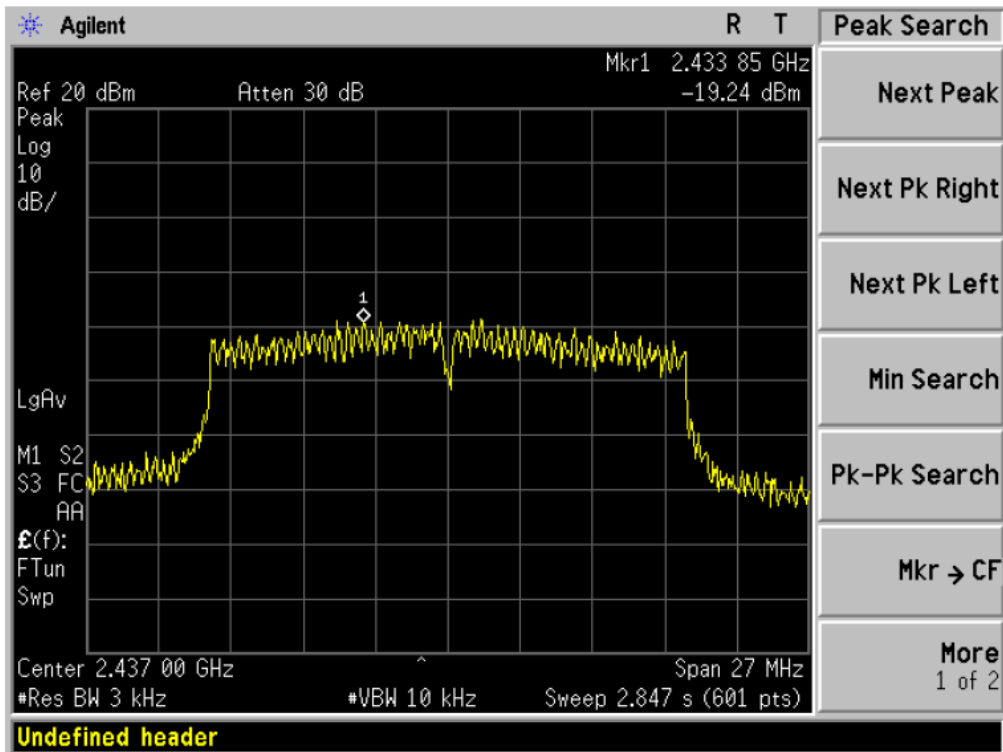

### TX CH11

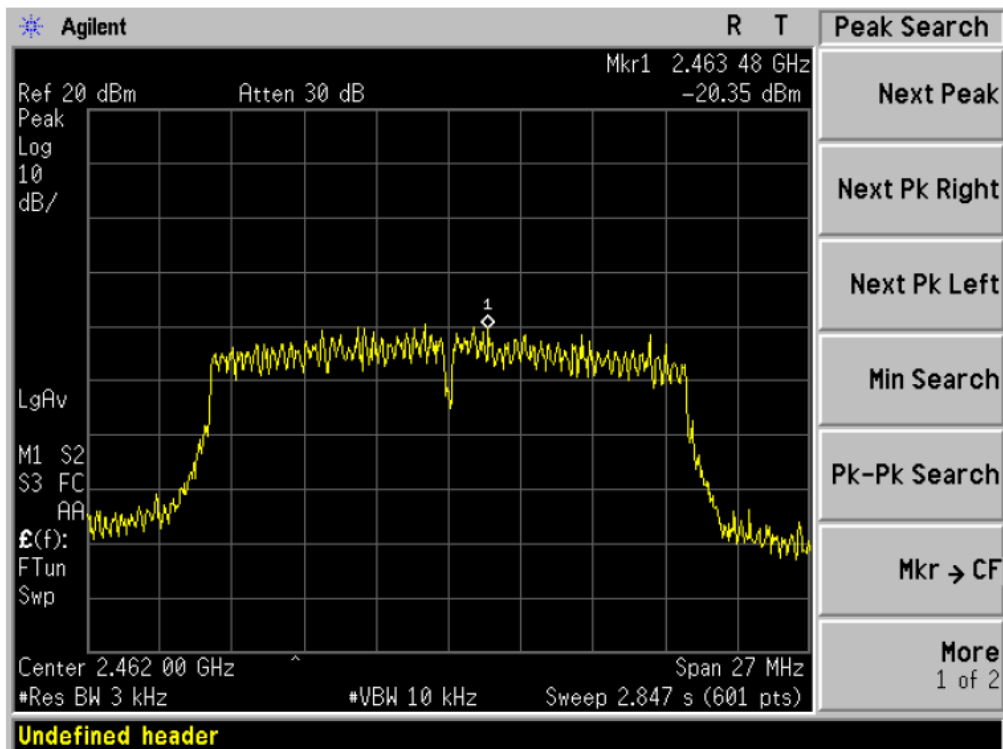

## 5. BANDWIDTH TEST

### 5.1 APPLIED PROCEDURES / LIMIT

FCC Part15 (15.247) , Subpart C				
Section	Test Item	Limit	Frequency Range (MHz)	Result
15.247(a)(2)	Bandwidth	$\geq 500\text{KHz}$ (6dB bandwidth)	2400-2483.5	PASS

#### 5.1.1 TEST PROCEDURE

1. Set resolution bandwidth (RBW) = 1-5% or DTS BW, not to exceed 100 kHz.
2. Set the video bandwidth (VBW)  $\geq 3 \times$  RBW.
3. Detector = Peak.
4. Trace mode = max hold.
5. Sweep = auto couple.
6. Allow the trace to stabilize.
7. Measure the maximum width of the emission that is constrained by the frequencies associated with the two outermost amplitude points (upper and lower) that are attenuated by 6 dB relative to the maximum level measured in the fundamental emission.

#### 5.1.2 DEVIATION FROM STANDARD

No deviation.

#### 5.1.3 TEST SETUP



#### 5.1.4 EUT OPERATION CONDITIONS

The EUT tested system was configured as the statements of 2.4 Unless otherwise a special operating condition is specified in the follows during the testing.

### 5.1.5 TEST RESULTS

EUT :	WT8266	Model Name :	WT8266
Temperature :	25°C	Relative Humidity :	60%
Pressure :	1012 hPa	Test Voltage :	DC5V from laptop
Test Mode :	TX b Mode /CH01, CH06, CH11		

Channel	Frequency (MHz)	6dB bandwidth (MHz)	Limit (kHz)	Result
Low	2412	10.03	500	Pass
Middle	2437	9.58	500	Pass
High	2462	9.58	500	Pass

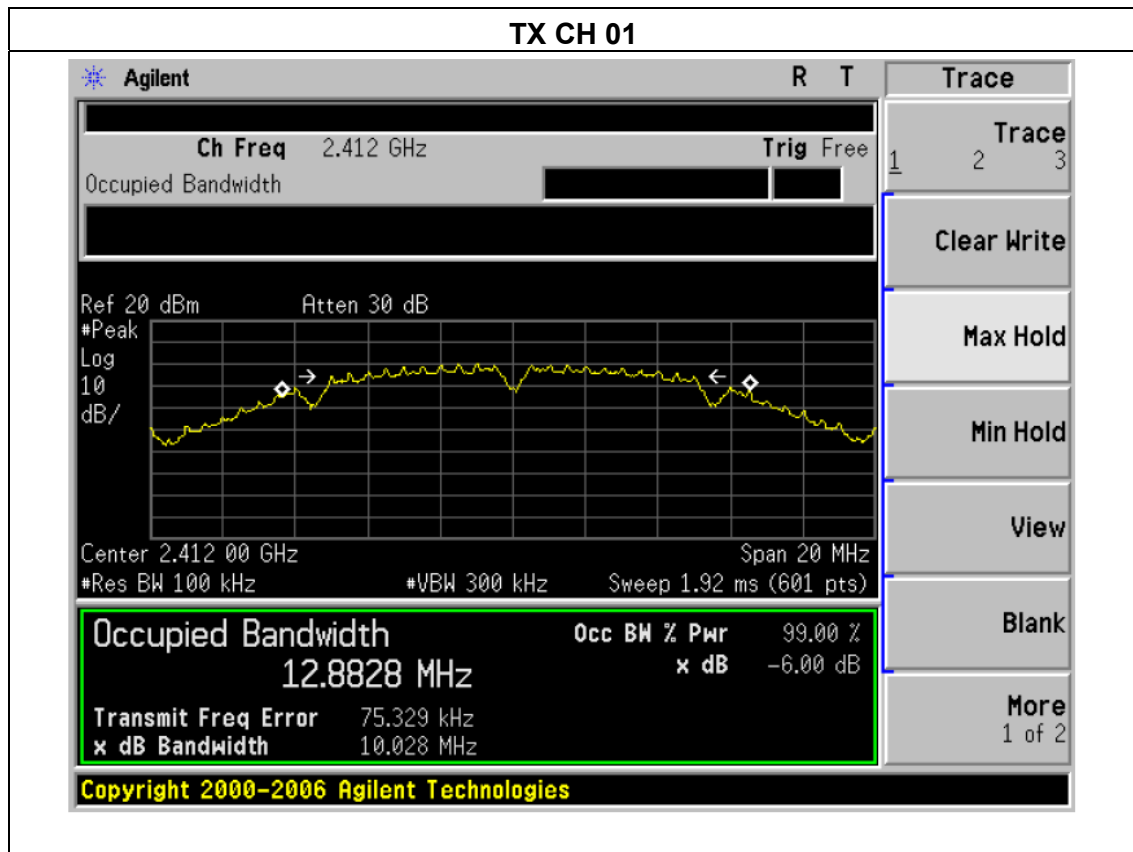

### TX CH 06

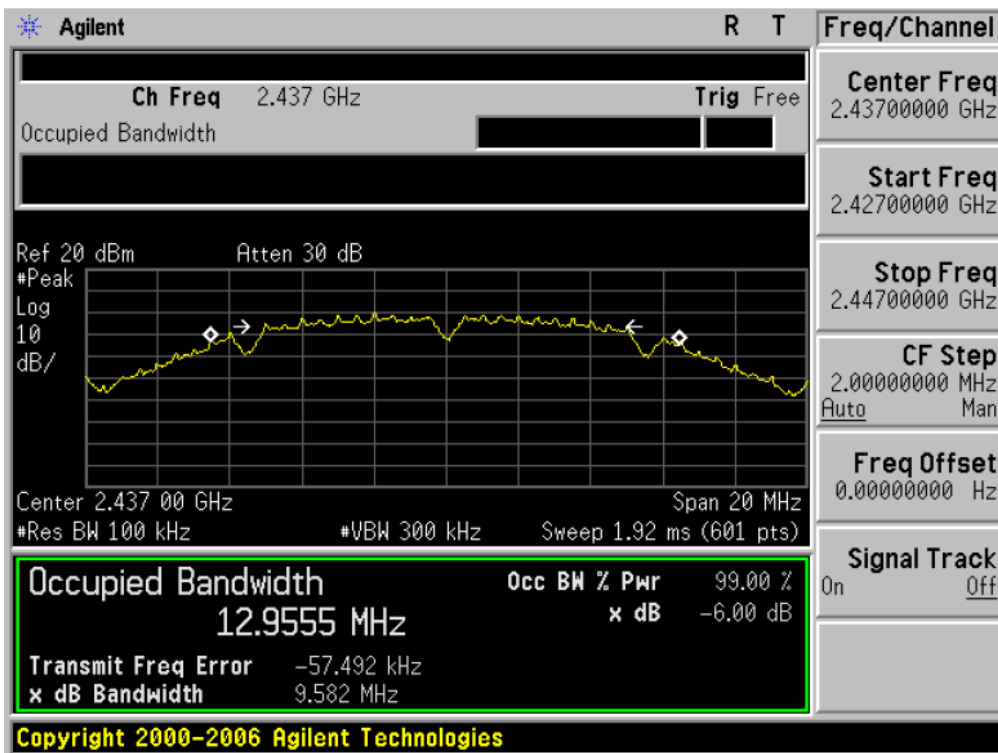

### TX CH 11

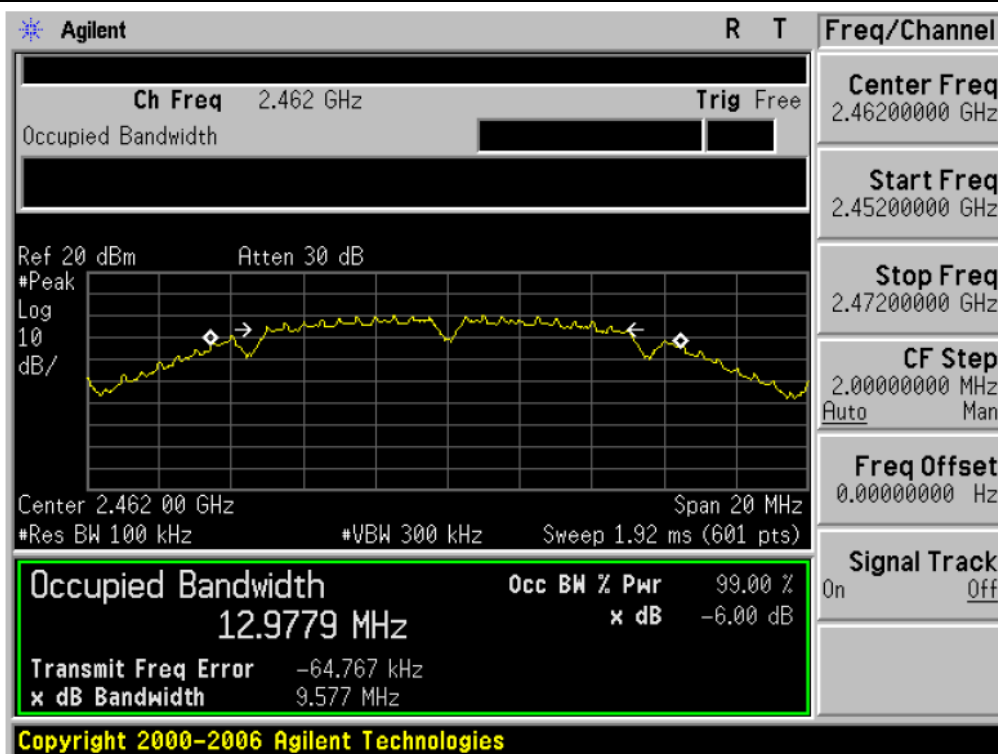



EUT :	WT8266	Model Name :	WT8266
Temperature :	25°C	Relative Humidity :	60%
Pressure :	1012 hPa	Test Voltage :	DC5V from laptop
Test Mode :	TX g Mode /CH01, CH06, CH11		

Channel	Frequency (MHz)	6dB bandwidth (MHz)	Limit (kHz)	Result
Low	2412	15.42	500	Pass
Middle	2437	15.49	500	Pass
High	2462	15.10	500	Pass

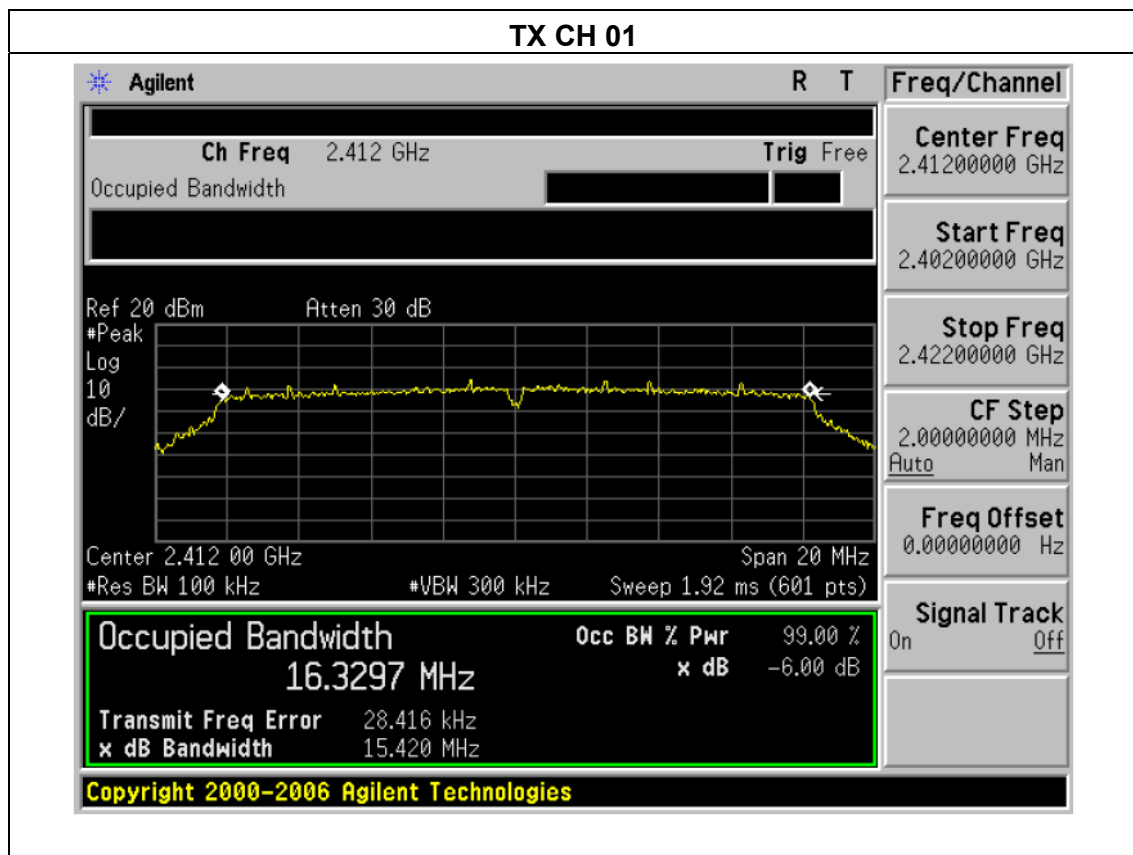

### TX CH 06

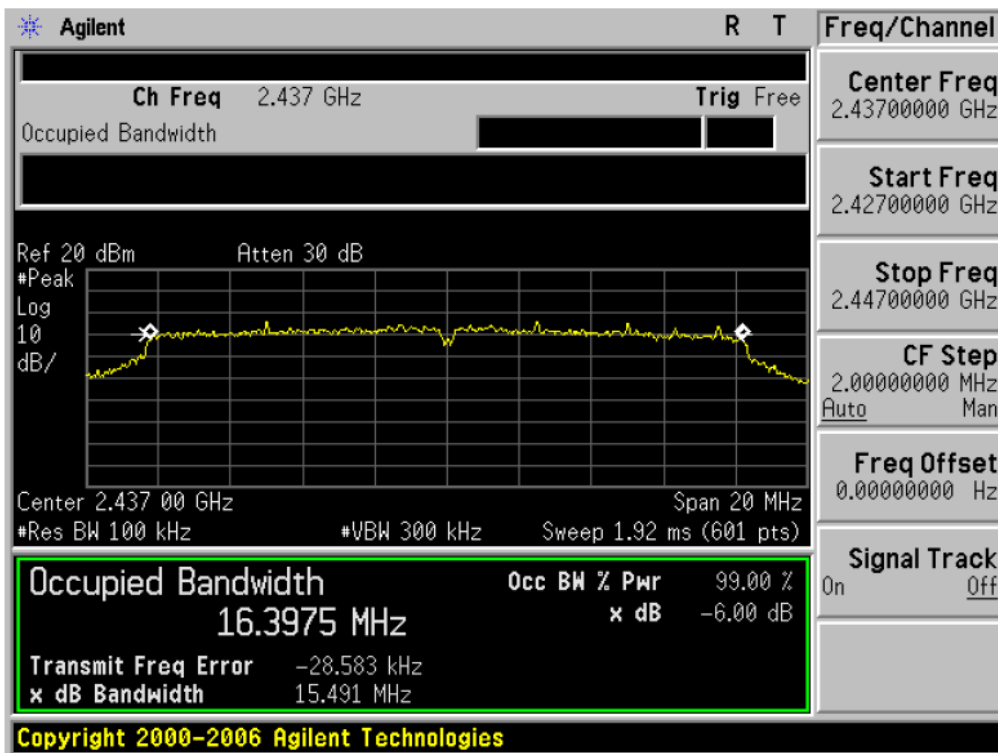

### TX CH 11

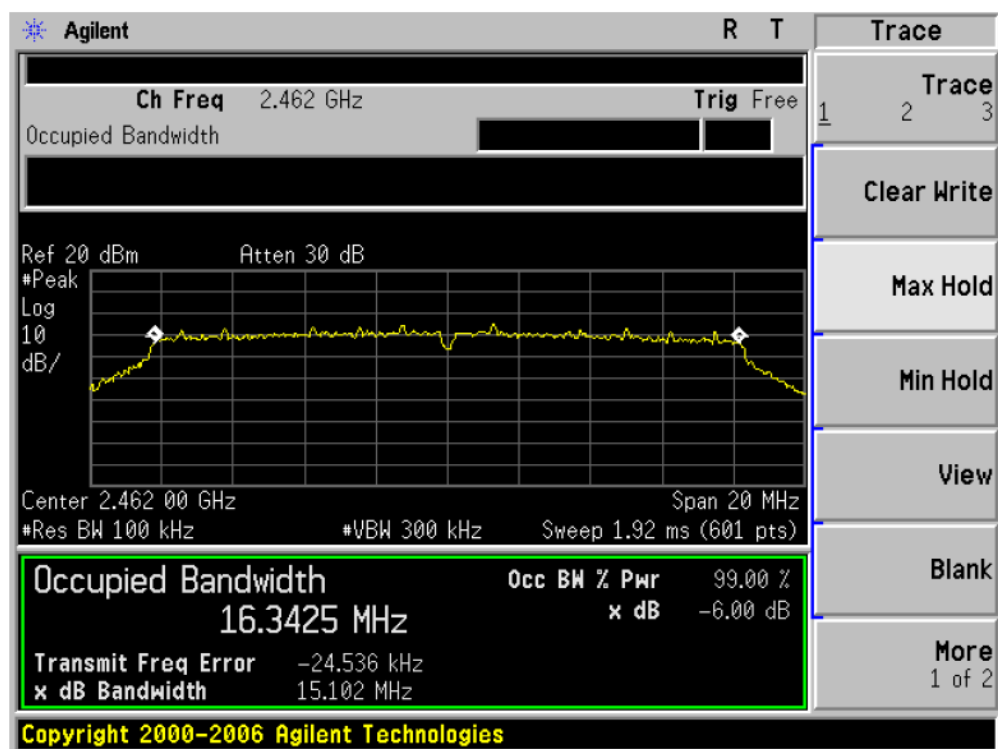

EUT :	WT8266	Model Name :	WT8266
Temperature :	25°C	Relative Humidity :	60%
Pressure :	1012 hPa	Test Voltage :	DC5V from laptop
Test Mode :	TX n Mode(20M) /CH01, CH06, CH11		

Channel	Frequency (MHz)	6dB bandwidth (MHz)	Limit (kHz)	Result
Low	2412	16.11	500	Pass
Middle	2437	16.33	500	Pass
High	2462	17.34	500	Pass

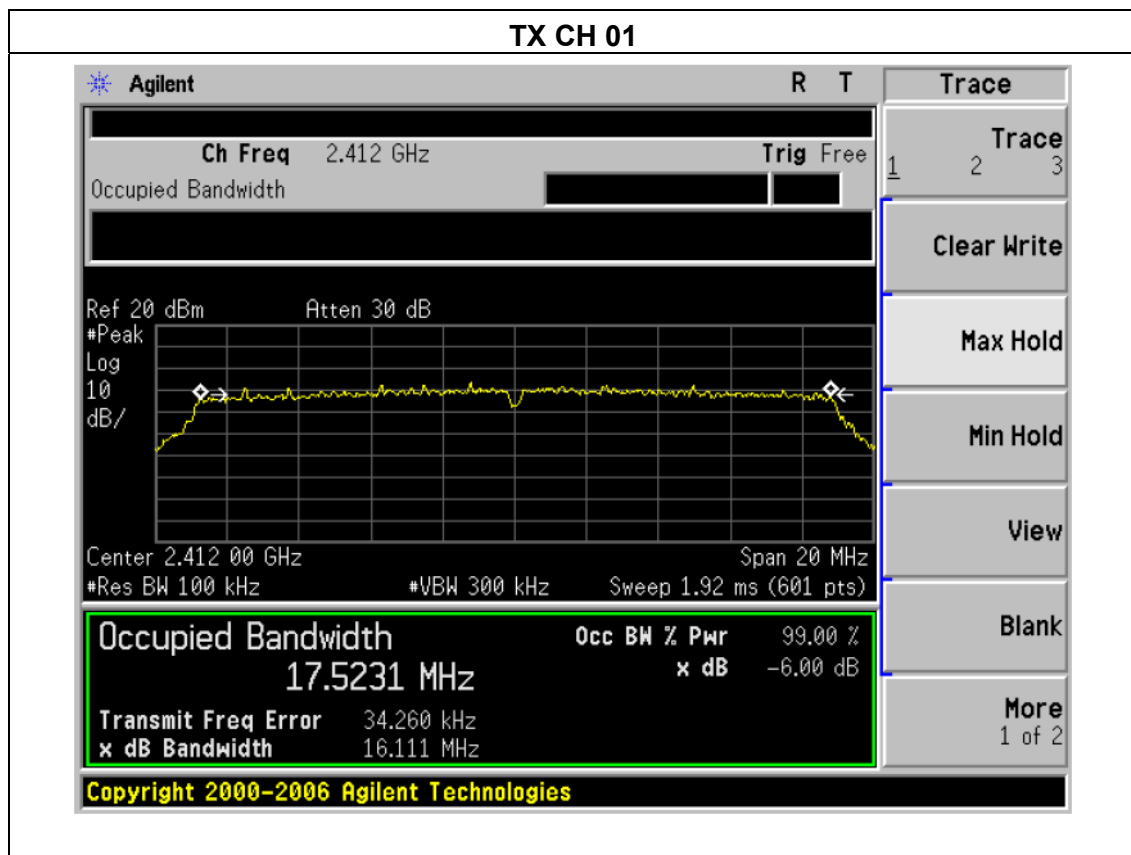

### TX CH 06

Agilent
R T

Ch Freq 2.437 GHz
Trig Free

Ref 20 dBm      Atten 30 dB

#Peak  
Log  
10  
dB/

Center 2.437 00 GHz      Span 20 MHz  
#Res BW 100 kHz      #VBW 300 kHz      Sweep 1.92 ms (601 pts)

<b>Occupied Bandwidth</b>	<b>Occ BW % Pwr</b> 99.00 %
17.5190 MHz	x dB -6.00 dB
<b>Transmit Freq Error</b> -14.464 kHz	
<b>x dB Bandwidth</b> 16.334 MHz	

Copyright 2000-2006 Agilent Technologies

Trace

Trace	2	3
1		

Clear Write

Max Hold

Min Hold

View

Blank

More  
1 of 2

### TX CH 11

Agilent
R T

Ch Freq 2.462 GHz
Trig Free

Ref 20 dBm      Atten 30 dB

#Peak  
Log  
10  
dB/

Start 2.452 00 GHz      Stop 2.472 00 GHz  
#Res BW 100 kHz      #VBW 300 kHz      Sweep 1.92 ms (601 pts)

<b>Occupied Bandwidth</b>	<b>Occ BW % Pwr</b> 99.00 %
17.5222 MHz	x dB -6.00 dB
<b>Transmit Freq Error</b> -18.236 kHz	
<b>x dB Bandwidth</b> 17.341 MHz	

Copyright 2000-2006 Agilent Technologies

Freq/Channel

**Center Freq**  
2.46200000 GHz

**Start Freq**  
2.45200000 GHz

**Stop Freq**  
2.47200000 GHz

**CF Step**  
2.00000000 MHz  
Auto      Man

**Freq Offset**  
0.00000000 Hz

**Signal Track**  
On      Off

## 6. PEAK OUTPUT POWER TEST

### 6.1 APPLIED PROCEDURES / LIMIT

FCC Part15 (15.247) , Subpart C				
Section	Test Item	Limit	Frequency Range (MHz)	Result
15.247(b)(3)	Peak Output Power	1 watt or 30dBm	2400-2483.5	PASS

#### 6.1.1 TEST PROCEDURE

- a. The EUT was directly connected to the Power meter

#### 6.1.2 DEVIATION FROM STANDARD

No deviation.

#### 6.1.3 TEST SETUP



#### 6.1.4 EUT OPERATION CONDITIONS

The EUT tested system was configured as the statements of 2.4 Unless otherwise a special operating condition is specified in the follows during the testing.

### 6.1.5 TEST RESULTS

EUT :	WT8266	Model Name :	WT8266
Temperature :	25°C	Relative Humidity :	60%
Pressure :	1012 hPa	Test Voltage :	DC5V from laptop
Test Mode :	TX b/g/n(20M)		

<b>TX 802.11b Mode</b>				
Test Channe	Frequency	Maximum Conducted Output Power(PK)	Maximum Conducted Output Power(AV)	LIMIT
	(MHz)	(dBm)	(dBm)	dBm
CH01	2412	18.84	17.86	30
CH06	2437	18.74	17.35	30
CH11	2462	18.79	17.28	30
<b>TX 802.11g Mode</b>				
CH01	2412	16.56	15.96	30
CH06	2437	16.49	15.68	30
CH11	2462	16.52	15.87	30
<b>TX 802.11n-HT20 Mode</b>				
CH01	2412	15.76	14.47	30
CH06	2437	15.81	14.37	30
CH11	2462	15.73	14.75	30

## 7. 100 KHZ BANDWIDTH OF FREQUENCY BAND EDGE

### APPLICABLE STANDARD

In any 100 kHz bandwidth outside the frequency band in which the spread spectrum or digitally modulated intentional radiator is operating, the radio frequency power that is produced by the intentional radiator shall be at least 20 dB below that in the 100 kHz bandwidth within the band that contains the highest level of the desired power, based on either an RF conducted or a radiated measurement, provided the transmitter demonstrates compliance with the peak conducted power limits. If the transmitter complies with the conducted power limits based on the use of RMS averaging over a time interval, as permitted under paragraph (b)(3) of this section, the attenuation required under this paragraph shall be 30 dB instead of 20 dB. Attenuation below the general limits specified in §15.209(a) is not required. In addition, radiated emissions which fall in the restricted bands, as defined in §15.205(a), must also comply with the radiated emission limits specified in §15.209(a) (see §15.205(c)).

### TEST PROCEDURE

- a) Check the calibration of the measuring instrument using either an internal calibrator or a known signal from an external generator.
- b) Position the EUT without connection to measurement instrument. Turn on the EUT and connect its antenna terminal to measurement instrument via a low loss cable. Then set it to any one measured frequency within its operating range, and make sure the instrument is operated in its linear range.
- c) Set RBW to 100 kHz and VBW of spectrum analyzer to 300 kHz with a convenient frequency span including 100 kHz bandwidth from band edge.
- d) Measure the highest amplitude appearing on spectral display and set it as a reference level. Plot the graph with marking the highest point and edge frequency.
- e) Repeat above procedures until all measured frequencies were complete.

### 7.1 DEVIATION FROM STANDARD

No deviation.

### 7.2 TEST SETUP



### 7.3 EUT OPERATION CONDITIONS

The EUT tested system was configured as the statements of 2.4 Unless otherwise a special operating condition is specified in the follows during the testing.

### 7.4 TEST RESULTS

EUT :	WT8266	Model Name :	WT8266
Temperature :	25°C	Relative Humidity :	60%
Pressure :	1012 hPa	Test Voltage :	DC5V from laptop

For Radiated:

	Frequency (MHz)	Antenna polarization (H/V)	Worst Emission (dBuV/m)	Band edge Limit (dBuV/m)		Result
			PK	PK	AV	
802.11b Low/Middle /High	<2400	H	50.27	74.00	54.00	Pass
	<2400	V	49.57	74.00	54.00	Pass
	>2483.5	H	49.45	74.00	54.00	Pass
	>2483.5	V	50.14	74.00	54.00	Pass
802.11g Low/Middle /High	<2400	H	49.63	74.00	54.00	Pass
	<2400	V	49.38	74.00	54.00	Pass
	>2483.5	H	49.67	74.00	54.00	Pass
	>2483.5	V	50.11	74.00	54.00	Pass
802.11n (HT20) Low/Middle /High	<2400	H	50.16	74.00	54.00	Pass
	<2400	V	50.22	74.00	54.00	Pass
	>2483.5	H	50.18	74.00	54.00	Pass
	>2483.5	V	50.17	74.00	54.00	Pass
802.11n (HT40) Low/Middle /High	<2400	H	50.08	74.00	54.00	Pass
	<2400	V	50.14	74.00	54.00	Pass
	>2483.5	H	49.49	74.00	54.00	Pass
	>2483.5	V	50.07	74.00	54.00	Pass

If the PK measured levels comply with average limit, then the average level were deemed to comply with average limit.



For Conducted

802.11b: Band Edge, Left Side

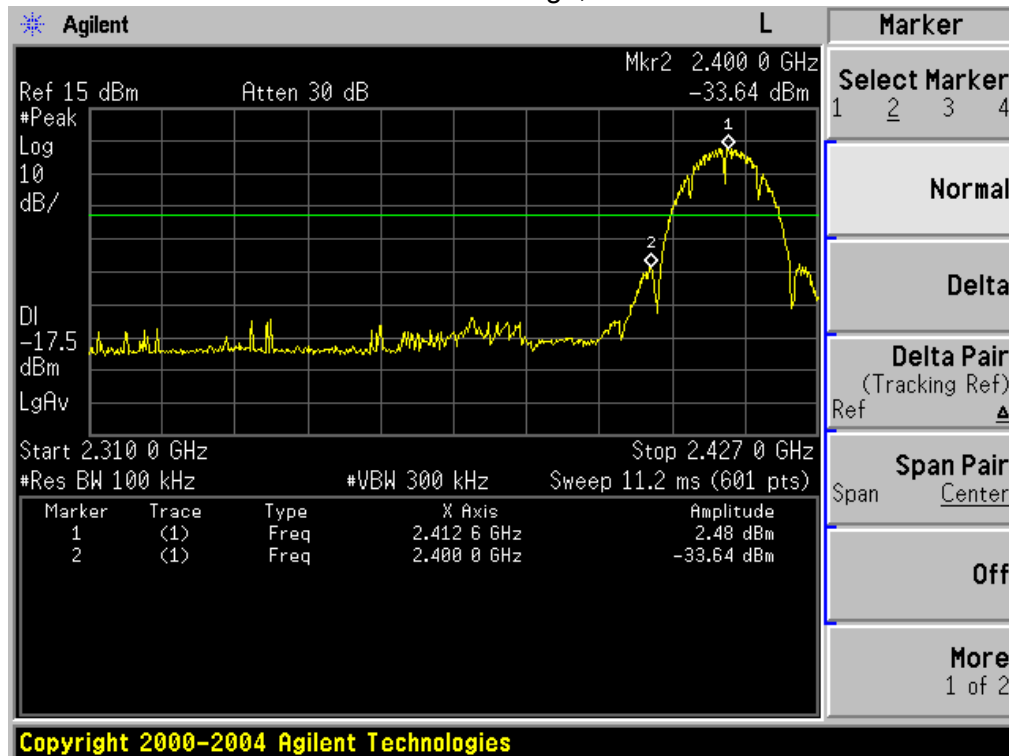

802.11b: Band Edge, Right Side

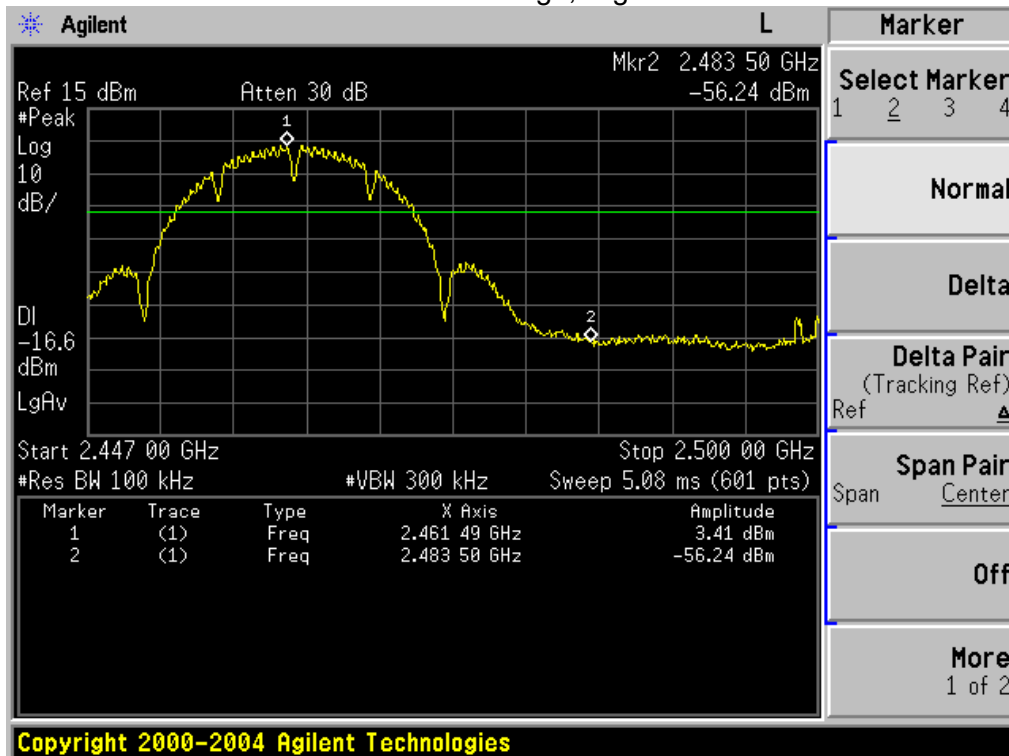

### 802.11g: Band Edge, Left Side

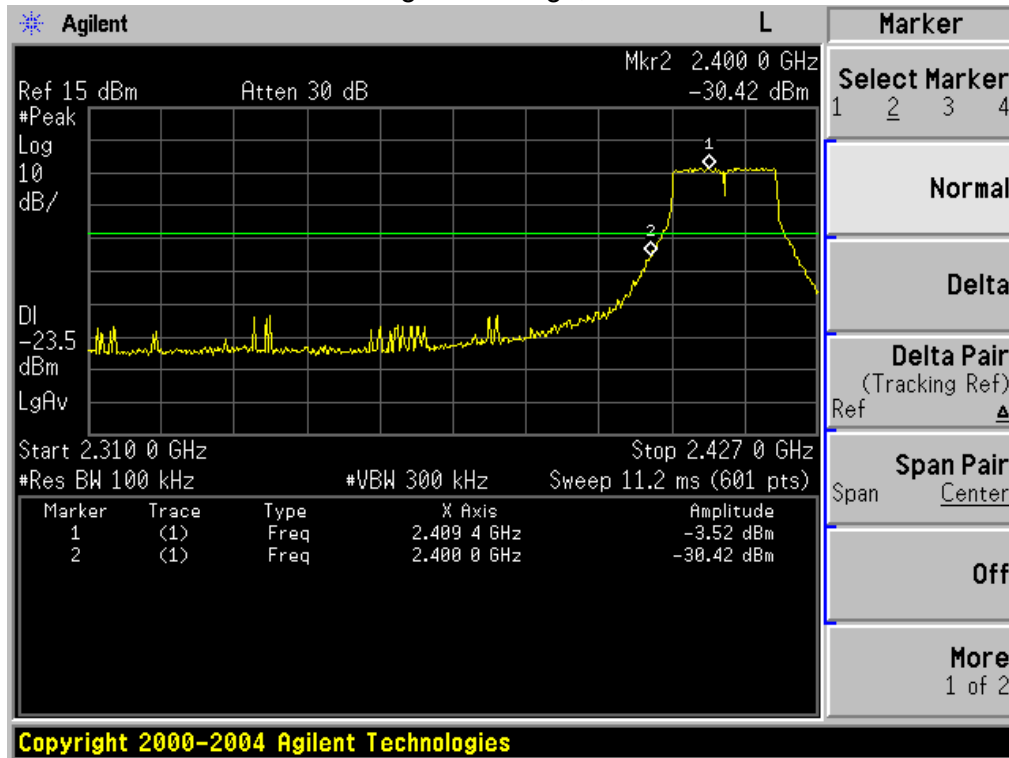

### 802.11g: Band Edge, Right Side

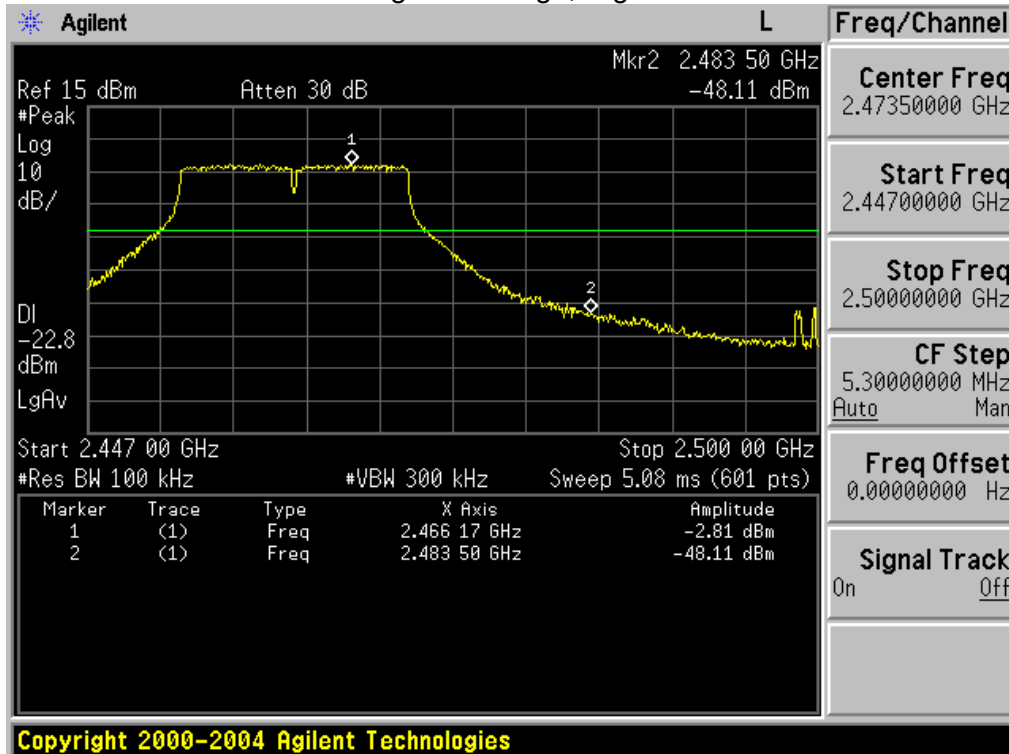

### 802.11n-HT20: Band Edge, Left Side

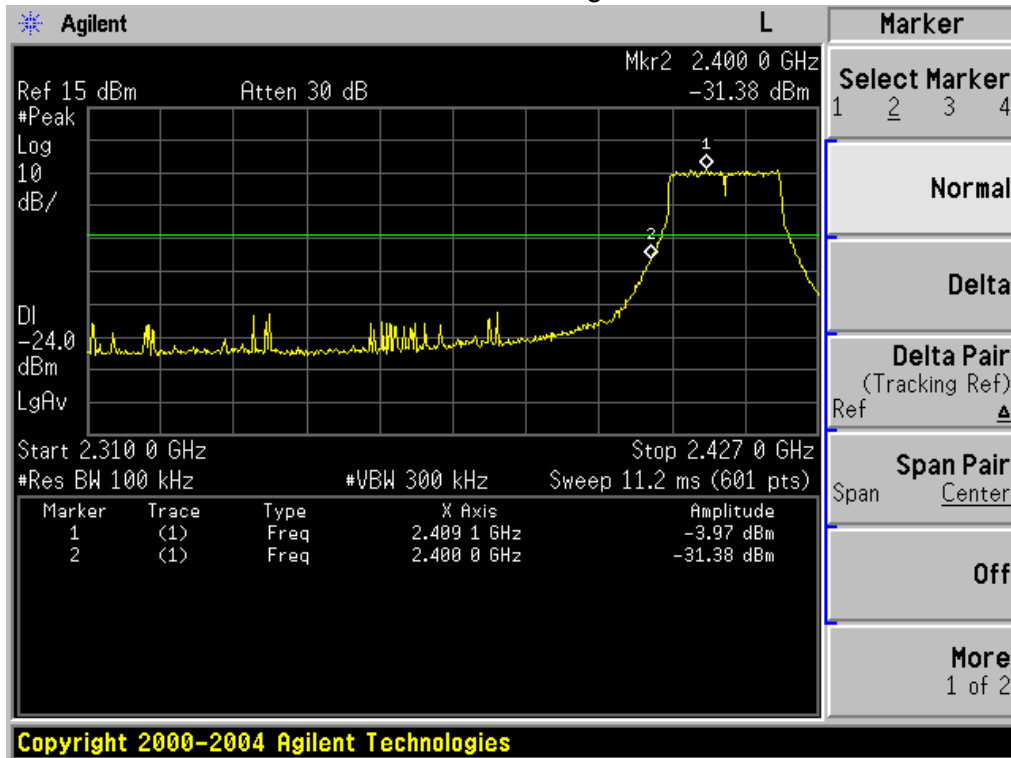

### 802.11n-HT20: Band Edge, Right Side

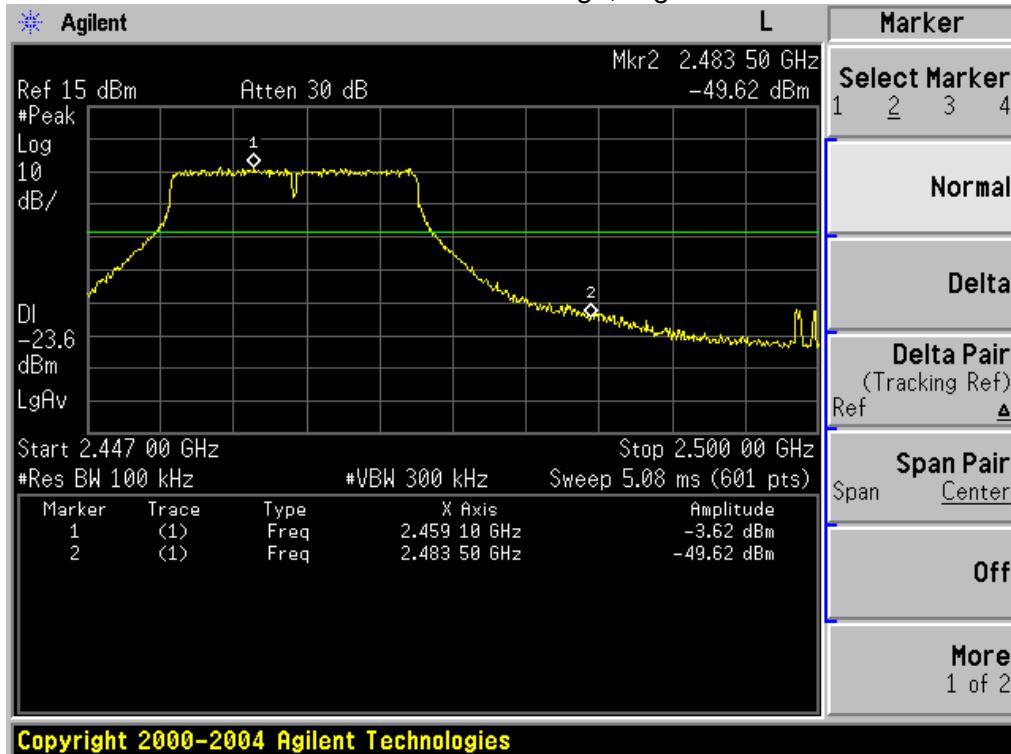

## 8. DUTY CYCLE OF TEST SIGNAL

### 8.1 STANDARD REQUIREMENT

Pre-analysis Check: While conducting average power measurement, duty cycle of each mode shall be checked to ensure its duty cycle in order to compensate for the loss due to insufficient ratio of duty cycle.

All duty cycle is pre-scanned, and result as obtained below shows only the most representative ones where duty cycle is conducted as the given transmission with given virtual operation that expresses the percentage.

### 8.2 FORMULA:

Duty Cycle =  $T_{on} / (T_{on} + T_{off})$

### Measurement Procedure:

1. Set span = Zero
2. RBW = 8MHz
3. VBW = 8MHz,
4. Detector = Peak

### Duty Cycle:

	Duty Cycle	Duty Fator (dB)
802.11b	95.5%	0.20
802.11g	96.2%	0.17
802.11n(HT20)	99.0%	0.00
802.11n(HT40)	96.5%	0.16

Duty Cycle Factor:  $10 * \log (1/0.955) = 0.499$

Duty Cycle Factor:  $10 * \log (1/0.962) = 0.497$

Duty Cycle Factor:  $10 * \log (1/0.99) = 0.01$

Duty Cycle Factor:  $10 * \log (1/0.965) = 1.404$

## **9. ANTENNA REQUIREMENT**

### **9.1 STANDARD REQUIREMENT**

15.203 requirement: For intentional device, according to 15.203: an intentional radiator shall be designed to ensure that no antenna other than that furnished by the responsible party shall be used with the device.

### **9.2 EUT ANTENNA**

The EUT antenna is Integrated antenna. It comply with the standard requirement.

## 10. EUT TEST PHOTO

### Radiated Measurement Photos

