



东莞市一佳电子通讯科技有限公司

Dongguan YIJIA Electronic Communication Technology Co., LTD

Antenna Test Report

Model number : YJT01.009.007.301A

Contents:

1. Antenna Profile

2. Antenna Performance Test

3. Antenna Passive Test

Tester : Shi Yihuang

Approval : Chen Guoqiang

Date : 2023 / 2 / 27



1. Antenna Profile

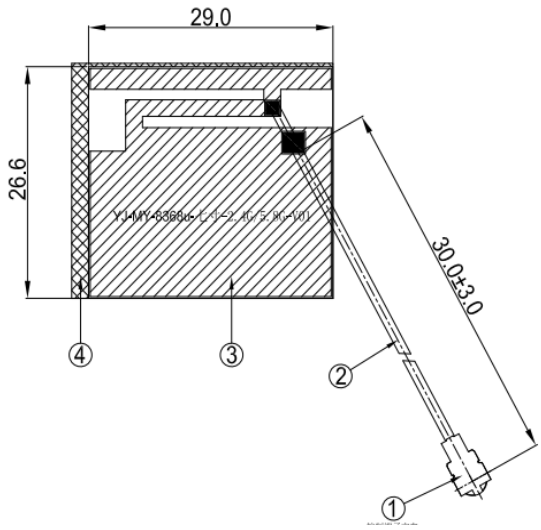

4	Paste+EVA	31.0*27.0*3.0MM	Paste+EVA	EVA1000XA.P01	1
3	FPCB	29.0*26.6MM	FPCB	FPC1000XA.P01	1
2	Coaxial Cable	O.D.1.13 Black	O.D.1.13	COA1000XA.P01	1
1	Mini Connector	Au Plated 1代	Cu	TER1000XA.P01	1
NO	PART NAME	DESCRIPTION	Material	Part Number	Q.TY

**WiFi
Antenna**





2. Antenna Performance Test

**Agilent
E5071B**

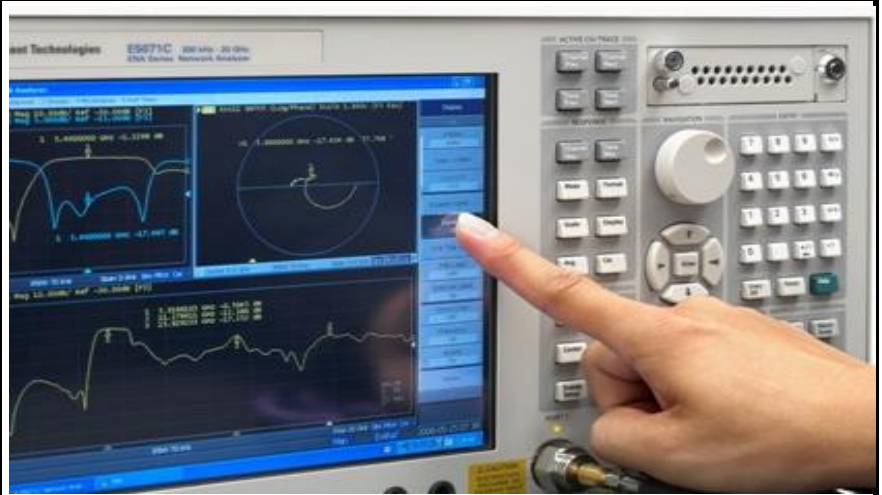

**S
Parameter
Test //
WiFi
Antenna**

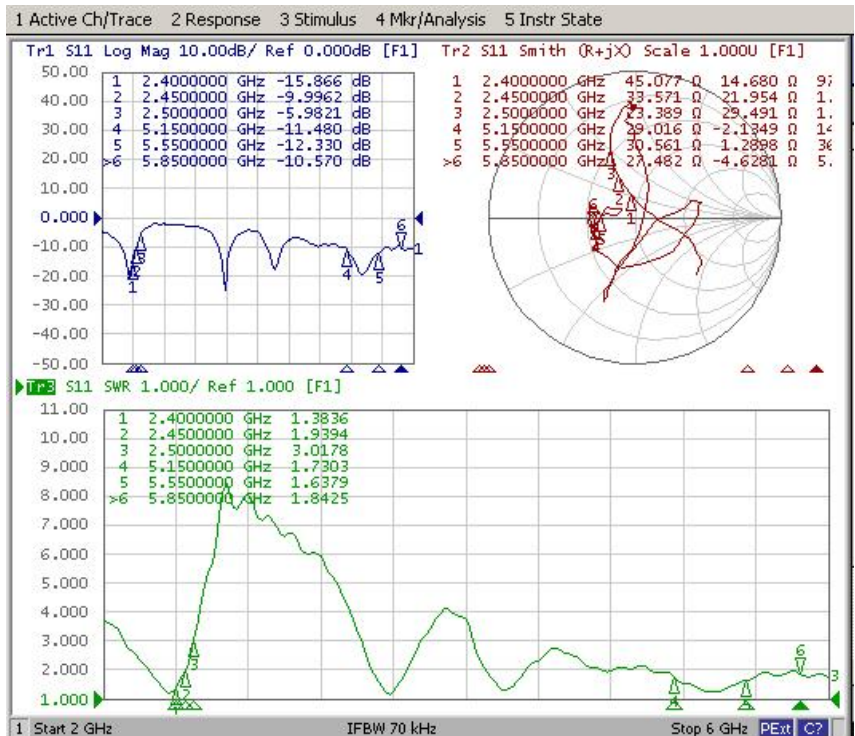



Passive Test For WiFi2.4G

Freq (MHz)	Effi (%)	Effi (dB)	Gain (dBi)
2400	31.55	-5.01	1.8
2410	30.88	-5.1	1.6
2420	30.39	-5.32	1.4
2430	29.87	-5.35	0.8
2440	28.94	-5.44	0.4
2450	30.56	-5.15	0.2
2460	33.12	-4.8	-0.1
2470	36.33	-4.4	-0.3
2480	37.25	-4.29	-0.8
2490	37	-4.32	-1.1
2500	34.87	-4.58	-1.4



Passive Test For WiFi5.8G

Freq (MHz)	Effi (%)	Effi (dB)	Gain (dBi)
5150	26.16	-5.81	-0.7
5200	27.44	-5.62	0.9
5250	28.35	-5.48	0.8
5300	33.72	-4.72	1.7
5350	31.53	-5.01	1.7
5400	27.01	-5.68	1.9
5450	26.01	-5.85	2.0
5500	29.17	-5.35	2.7
5550	29.87	-5.25	2.6
5600	27.94	-5.54	2.7
5650	33.54	-4.74	4.1
5700	36.93	-4.33	3.2
5750	38.12	-4.19	2.6
5800	31.09	-5.07	1.5
5850	30.14	-5.21	1.1



2400.000MHz

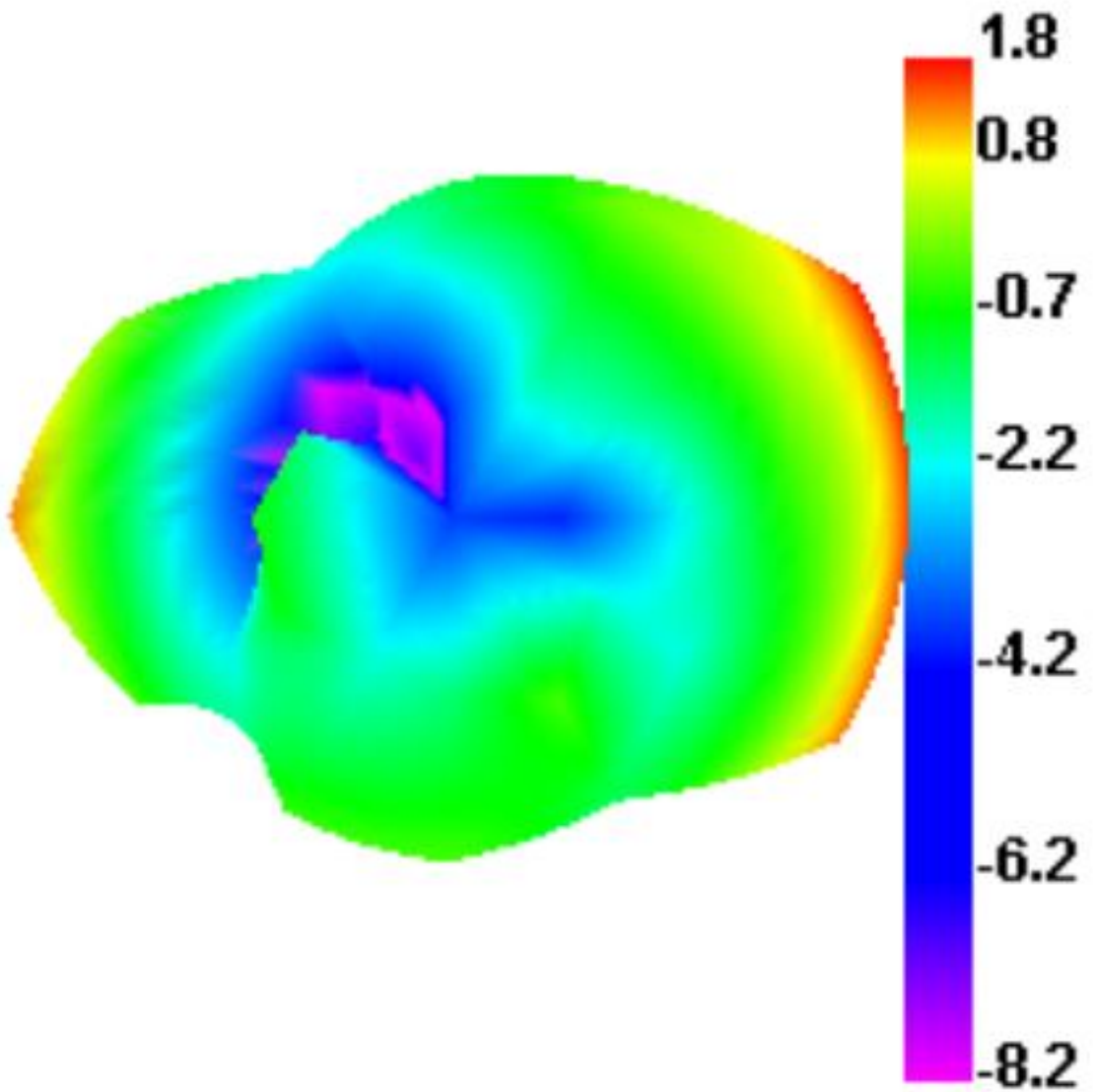



2450.000MHz

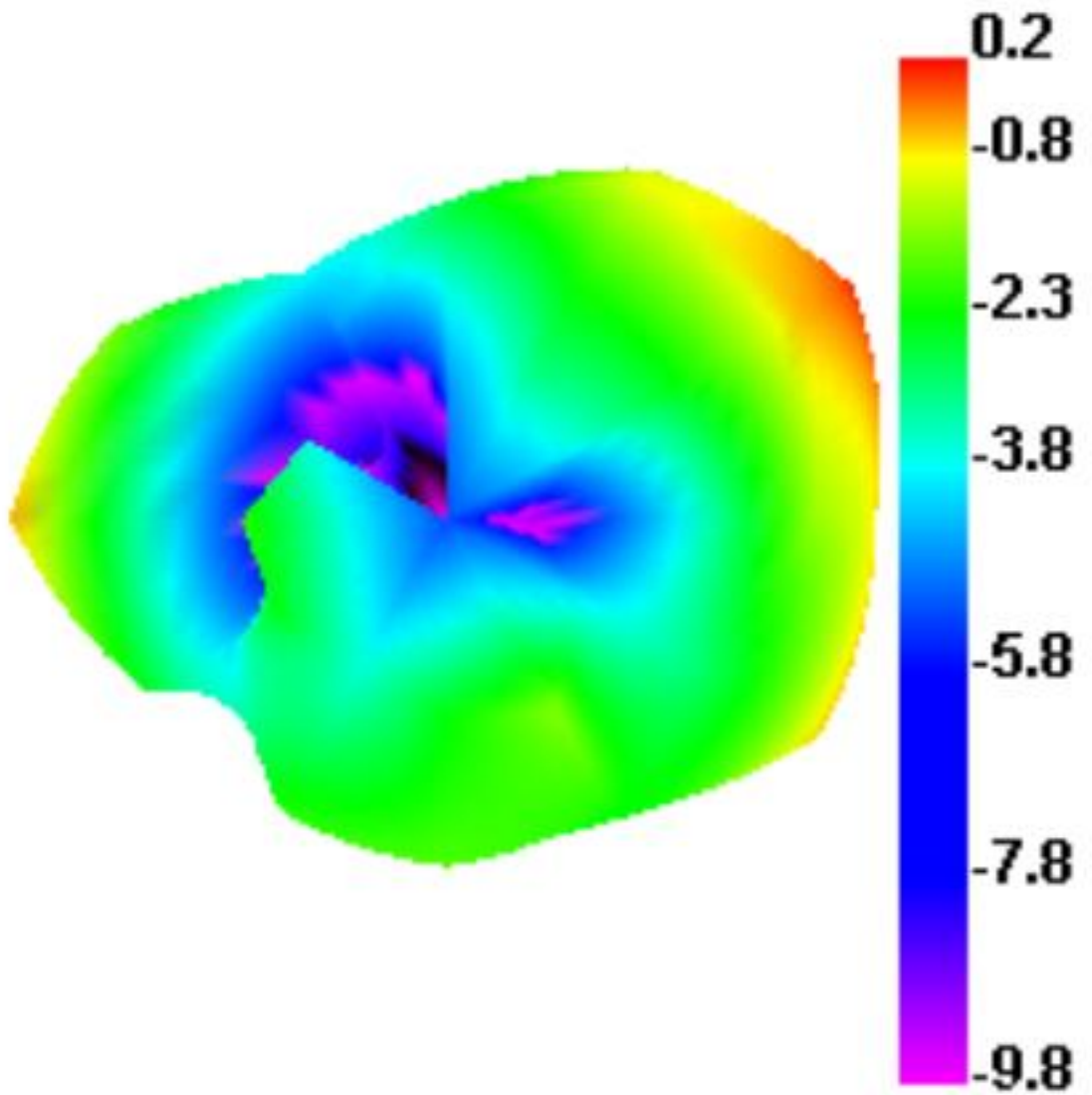



2500.000MHz

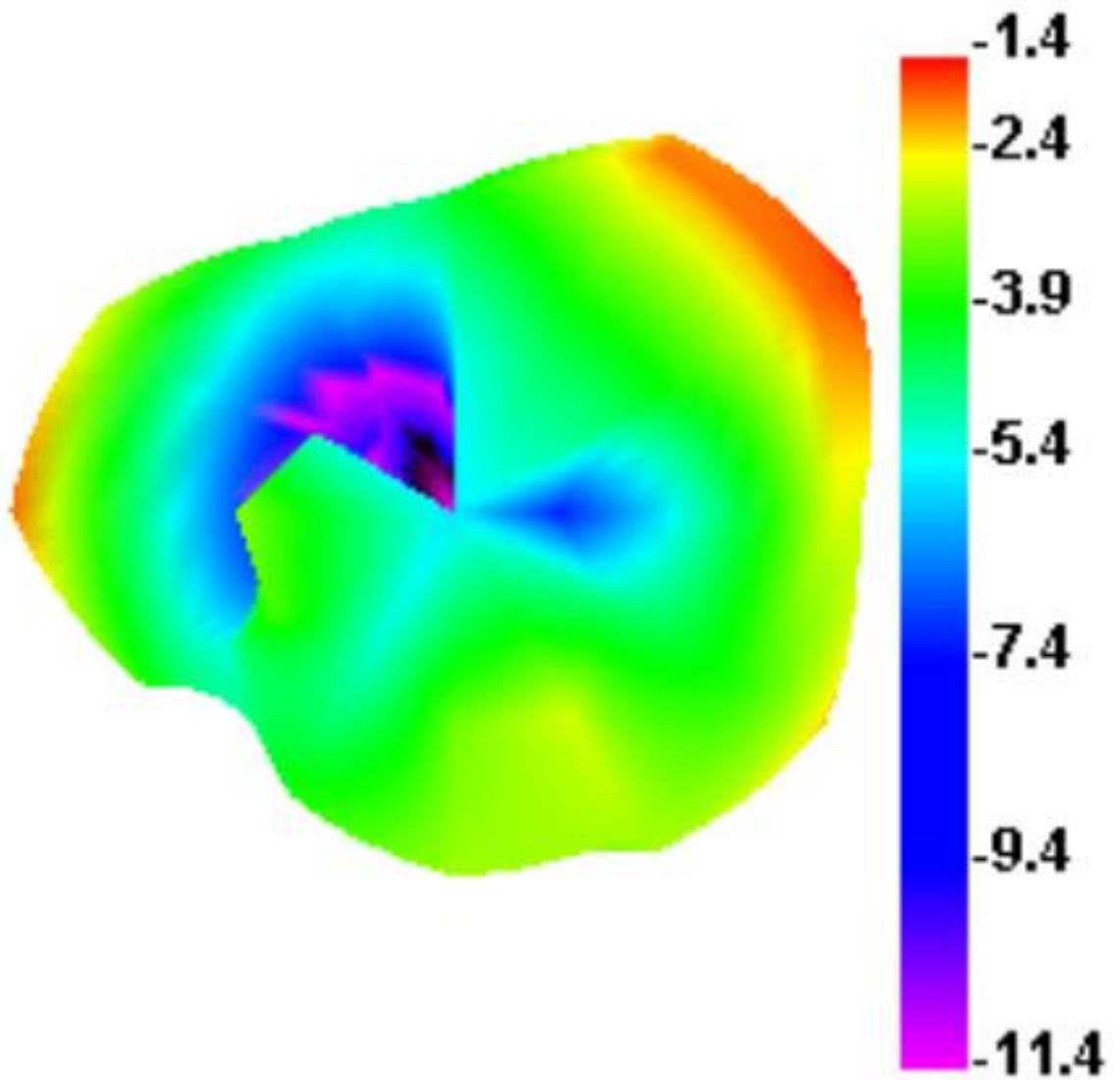



5150.000MHz

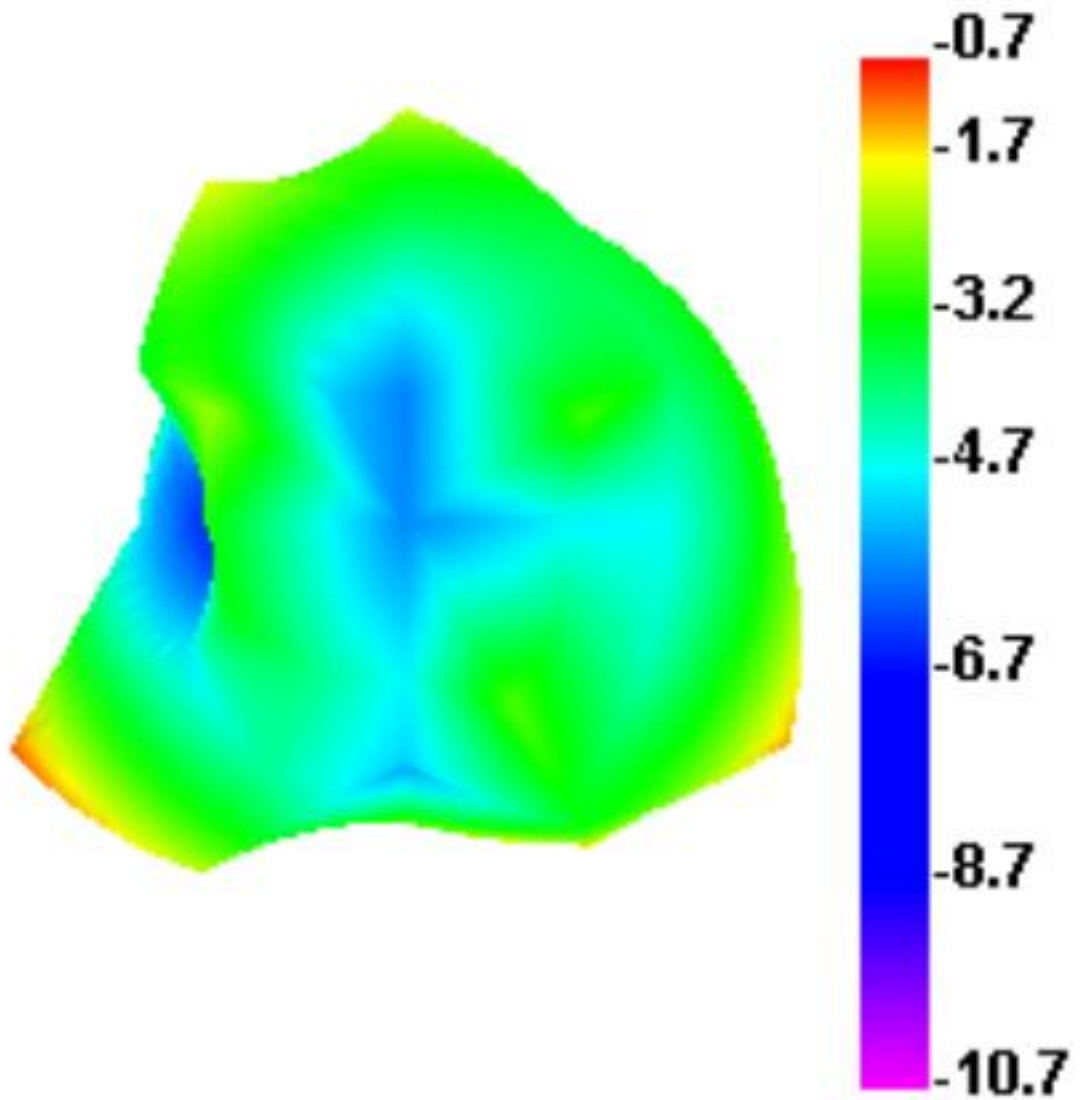



5500.000MHz

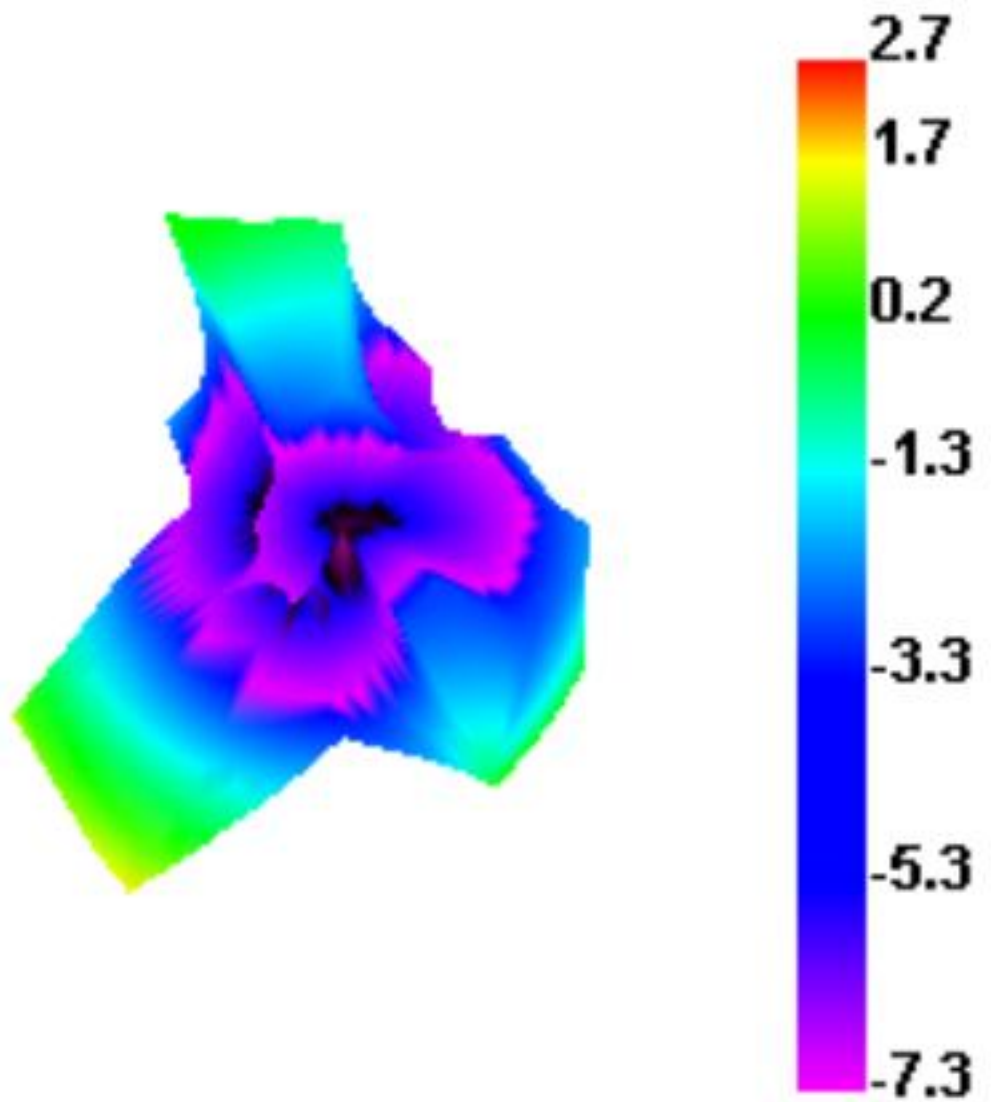



5850.000MHz

