



**In accordance with the requirements of  
FCC 47 CFR Part 2(2.1093), ANSI/IEEE C95.1-1992 and  
IEEE Std 1528-2013**

## **FCC SAR EVALUATION REPORT**

**Product Name :** RK-175

**Trademark :** RTK

**Model Name :** RK-175

**Serial Model :** N/A

**Report No. :** NTEK-2016NT05035459HF

**FCC ID :** 2AFMZ-RK-175

**Prepared for**

ACCESS TELECOM

1882 NW 97th Ave, Doral, Miami, Fl 33172, United States of America.

**Prepared by**

Shenzhen NTEK Testing Technology Co., Ltd.

1/F, Building E, Fenda Science Park, Sanwei Community, Xixiang Street

Bao'an District, Shenzhen P.R. China

Tel.: +86-0755-61156588 Fax.: +86-0755-61156599

Website: [www.ntek.org.cn](http://www.ntek.org.cn)

## TEST RESULT CERTIFICATION

**Applicant's name**..... ACCESS TELECOM

Address ..... 1882 NW 97th Ave, Doral, Miami, FL 33172, United States of America.

**Manufacturer's Name** .... Locopo Technology Co.,Ltd

Address ..... Rm./Flat 1501(056), 15/F,Spa Centre,53-55 Lockhart Road,Wan Chai,  
Kong Kong.

### Product description

Product name..... RK-175

Trademark ..... RTK

Model and/or type  
reference ..... RK-175

Serial Model ..... N/A

**Standards**..... FCC 47 CFR Part 2(2.1093)  
ANSI/IEEE C95.1-1992  
IEEE Std 1528-2013  
Published RF exposure KDB procedures

This device described above has been tested by Shenzhen NTEK. In accordance with the measurement methods and procedures specified in IEEE Std 1528-2013 and KDB 865664 D01. Testing has shown that this device is capable of compliance with localized specific absorption rate (SAR) specified in FCC 47 CFR Part 2(2.1093) and ANSI/IEEE C95.1-1992. The test results in this report apply only to the tested sample of the stated device/equipment. Other similar device/equipment will not necessarily produce the same results due to production tolerance and measurement uncertainties.

This report shall not be reproduced except in full, without the written approval of Shenzhen NTEK, this document may be altered or revised by Shenzhen NTEK, personal only, and shall be noted in the revision of the document.

### Date of Test

Date (s) of performance of tests..... May 06, 2016 ~ May 20, 2016

Date of Issue ..... May 24, 2016

Test Result ..... **Pass**

Prepared By  
(Test Engineer) :



\_\_\_\_\_  
(Jerry)

Approved By  
(Lab Manager) :



\_\_\_\_\_  
(Sam Chen)

### Revision History

REV.	DESCRIPTION	ISSUED DATE	REMARK
Rev.1.0	Initial Test Report Release	May 24, 2016	Jerry

## TABLE OF CONTENTS

1. General Information .....	6
1.1. RF exposure limits.....	6
1.2. Statement of Compliance .....	7
1.3. EUT Description .....	8
1.4. Test specification(s) .....	9
1.5. Ambient Condition.....	9
2. SAR Measurement System .....	10
2.1. SATIMO SAR Measurement Set-up Diagram .....	10
2.2. Robot .....	11
2.3. E-Field Probe.....	12
2.3.1. E-Field Probe Calibration .....	12
2.4. SAM phantoms .....	13
2.4.1. Technical Data .....	13
2.5. Device Holder .....	15
2.6. Test Equipment List .....	16
3. SAR Measurement Procedures .....	18
3.1. Power Reference .....	18
3.2. Area scan & Zoom scan.....	18
3.3. Description of interpolation/extrapolation scheme .....	20
3.4. Volumetric Scan .....	20
3.5. Power Drift .....	20
4. System Verification Procedure .....	21
4.1. Tissue Verification .....	21
4.1.1. Tissue Dielectric Parameter Check Results .....	21
4.2. System Verification Procedure .....	22
4.2.1. System Verification Results .....	23
5. SAR Measurement variability and uncertainty .....	24
5.1. SAR measurement variability .....	24
5.2. SAR measurement uncertainty .....	24
6. RF Exposure Positions .....	25
6.1. Ear and handset reference point .....	25
6.2. Definition of the cheek position .....	25
6.3. Definition of the tilt position .....	27
6.4. Tablet SAR test considerations.....	27
6.5. Phablet SAR test considerations .....	28
7. RF Output Power .....	29
7.1. Maximum Tune-up Limit.....	29
7.2. GSM Conducted Power .....	30
7.3. UMTS Conducted Power .....	31

7.4. WiFi & BT Output Power.....	34
7.4.1. Output Power Results Of WiFi.....	34
7.4.2. Output Power Results Of BT.....	34
8. Antenna Location.....	35
9. Stand-alone SAR test exclusion.....	36
10. SAR Measurement Results.....	37
10.1. SAR measurement results.....	37
10.1.1. SAR measurement Result of GSM850.....	38
10.1.2. SAR measurement Result of GSM1900.....	39
10.1.3. SAR measurement Result of UMTS Band V.....	40
10.1.4. SAR measurement Result of UMTS Band II.....	41
10.1.5. SAR measurement Result of WiFi 2.4G.....	42
10.2. Simultaneous Transmission Possibilities.....	43
10.3. SAR Summation Scenario.....	44
11. Appendix A. Photo documentation.....	48
12. Appendix B. System Check Plots.....	54
13. Appendix C. SAR Measurement Plots.....	61
14. Appendix D. Calibration Certificate.....	72

# 1. General Information

## 1.1. RF exposure limits

(A).Limits for Occupational/Controlled Exposure (W/kg)

Whole-Body	Partial-Body	Hands, Wrists, Feet and Ankles
0.4	8.0	20.0

(B).Limits for General Population/Uncontrolled Exposure (W/kg)

Whole-Body	Partial-Body	Hands, Wrists, Feet and Ankles
0.08	1.6	4.0

NOTE: **Whole-Body SAR** is averaged over the entire body, **partial-body SAR** is averaged over any 1 gram of tissue defined as a tissue volume in the shape of a cube. **SAR for hands, wrists, feet and ankles** is averaged over any 10 grams of tissue defined as a tissue volume in the shape of a cube.

### Occupational/Controlled Environments:

Are defined as locations where there is exposure that may be incurred by people who are aware of the potential for exposure, (i.e. as a result of employment or occupation).

### General Population/Uncontrolled Environments:

Are defined as locations where there is the exposure of individuals who have no knowledge or control of their exposure.

NOTE  
 HEAD AND TRUNK LIMIT  
 1.6 W/kg  
 APPLIED TO THIS EUT

**1.2. Statement of Compliance**

The maximum results of Specific Absorption Rate (SAR) found during testing for are RK-175 as follows.

Band	Max Reported SAR(W/kg)		
	1-g Head	1-g Body(0mm)	Max. SAR Summation
GSM 850	0.057	0.311	1.500
GSM 1900	0.178	0.705	
UMTS Band V	0.057	0.275	
UMTS Band II	0.227	1.018	
WiFi 2.4G	0.351	0.776	

This device is in compliance with Specific Absorption Rate (SAR) for general population/uncontrolled exposure limits (1.6 W/kg) specified in FCC 47 CFR Part 2(2.1093) and ANSI/IEEE C95.1-1992, and had been tested in accordance with the measurement methods and procedures specified in IEEE Std 1528-2013 & KDB 865664 D01.

### 1.3. EUT Description

Device Information			
Product Name	RK-175		
Trade Name	RTK		
Model Name	RK-175		
Serial Model	N/A		
FCC ID	2AFMZ-RK-175		
Device Phase	Identical Prototype		
Exposure Category	General population / Uncontrolled environment		
Antenna	FPCB Antenna		
Device Operating Configurations			
Supporting Mode(s)	GSM 850/1900, UMTS Band V/II, WiFi 2.4G, BT		
Test Modulation	GSM(GMSK/8PSK), UMTS(QPSK), WiFi(DSSS/OFDM)		
Device Class	B		
Operating Frequency Range(s)	Band	Tx (MHz)	Rx (MHz)
	GSM 850	824-849	869-894
	GSM 1900	1850-1910	1930-1990
	UMTS Band V	824-849	869-894
	UMTS Band II	1850-1910	1930-1990
	WiFi 2.4G	2412-2462	
	BT	2402-2480	
GPRS Multislot Class(12)	Max Number of Timeslots in Uplink		4
	Max Number of Timeslots in Downlink		4
	Max Total Timeslot		5
EDGE Multislot Class(12)	Max Number of Timeslots in Uplink		4
	Max Number of Timeslots in Downlink		4
	Max Total Timeslot		5
HSDPA UE Category	14		
HSUPA UE Category	6		
Power Class	4, tested with power level 5(GSM 850)		
	1, tested with power level 0(GSM 1900)		
	3, tested with power control "all 1"(UMTS Band V)		
	3, tested with power control "all 1"(UMTS Band II)		
Test Channels (low-mid-high)	128-189-251(GSM 850)		
	512-661-810(GSM 1900)		
	4132-4182-4233(UMTS Band V)		
	9262-9400-9538(UMTS Band II)		
	802.11 b/g/n:1-3-6-9-11(WiFi 2.4G)		



**1.4. Test specification(s)**

FCC 47 CFR Part 2(2.1093)
ANSI/IEEE C95.1-1992
IEEE Std 1528-2013
KDB 865664 D01 SAR measurement 100 MHz to 6 GHz
KDB 865664 D02 RF Exposure Reporting
KDB 447498 D01 General RF Exposure Guidance
KDB 248227 D01 802.11 Wi-Fi SAR
KDB 941225 D01 3G SAR Procedures
KDB 941225 D06 Hotspot Mode
KDB 648474 D04 Handset SAR

**1.5. Ambient Condition**

Ambient temperature	20°C – 24°C
Relative Humidity	30% – 70%

## 2. SAR Measurement System

### 2.1. SATIMO SAR Measurement Set-up Diagram

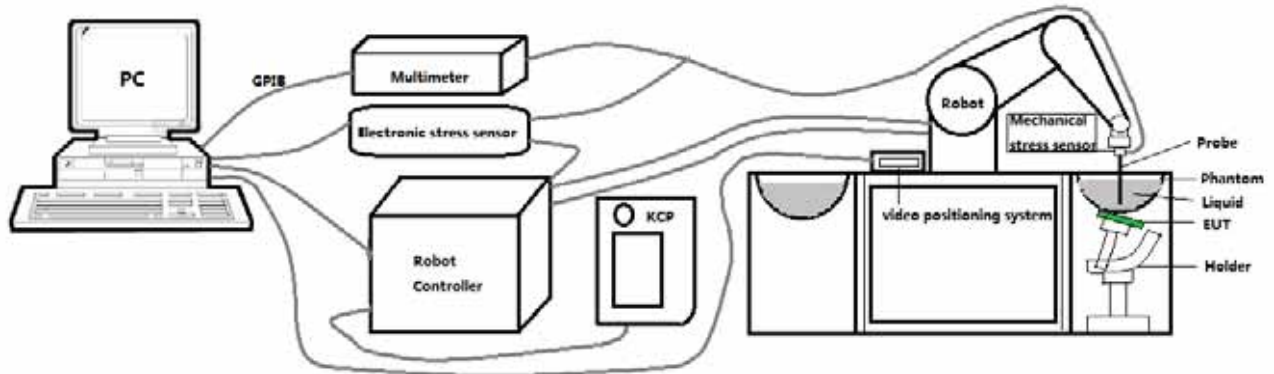

These measurements were performed with the automated near-field scanning system OPENSAR from SATIMO. The system is based on a high precision robot (working range: 901 mm), which positions the probes with a positional repeatability of better than  $\pm 0.03$  mm. The SAR measurements were conducted with dosimetric probe (manufactured by SATIMO), designed in the classical triangular configuration and optimized for dosimetric evaluation.

The first step of the field measurement is the evaluation of the voltages induced on the probe by the device under test. Probe diode detectors are nonlinear. Below the diode compression point, the output voltage is proportional to the square of the applied E-field; above the diode compression point, it is linear to the applied E-field. The compression point depends on the diode, and a calibration procedure is necessary for each sensor of the probe.

The Keithley multimeter reads the voltage of each sensor and send these three values to the PC. The corresponding E field value is calculated using the probe calibration factors, which are stored in the working directory. This evaluation includes linearization of the diode characteristics. The field calculation is done separately for each sensor. Each component of the E field is displayed on the "Dipole Area Scan Interface" and the total E field is displayed on the "3D Interface"

## 2.2. Robot

The SATIMO SAR system uses the high precision robots from KUKA. For the 6-axis controller system, the robot controller version (KUKA) from KUKA is used. The KUKA robot series have many features that are important for our application:



- High precision (repeatability  $\pm 0.03$  mm)
- High reliability (industrial design)
- Jerk-free straight movements
- Low ELF interference (the closed metallic construction shields against motor control fields)

### 2.3. E-Field Probe

This E-field detection probe is composed of three orthogonal dipoles linked to special Schottky diodes with low detection thresholds. The probe allows the measurement of electric fields in liquids such as the one defined in the IEEE and CENELEC standards.

For the measurements the Specific Dosimetric E-Field Probe SN 34/15 EPGO 267 with following specifications is used



- Dynamic range: 0.01-100 W/kg
  - Tip Diameter : 2.5 mm
  - Distance between probe tip and sensor center: 1 mm
  - Distance between sensor center and the inner phantom surface: 4 mm (repeatability better than  $\pm 1$  mm).
  - Probe linearity:  $\pm 0.06$  dB
  - Axial isotropy:  $< 0.25$  dB
  - Hemispherical Isotropy:  $< 0.50$  dB
  - Calibration range: 450MHz to 6000MHz for head & body simulating liquid.
  - Lower detection limit: 9mW/kg
- Angle between probe axis (evaluation axis) and surface normal line: less than  $30^\circ$ .

#### 2.3.1. E-Field Probe Calibration

Each probe needs to be calibrated according to a dosimetric assessment procedure with accuracy better than  $\pm 10\%$ . The spherical isotropy shall be evaluated and within  $\pm 0.25$ dB. The sensitivity parameters (Norm X, Norm Y, and Norm Z), the diode compression parameter (DCP) and the conversion factor (Conv F) of the probe are tested. The calibration data can be referred to appendix D of this report.

## 2.4. SAM phantoms

Photo of SAM phantom SN 16/15 SAM119



The SAM phantom is used to measure the SAR relative to people exposed to electro-magnetic field radiated by mobile phones.

### 2.4.1. Technical Data

Serial Number	Shell thickness	Filling volume	Dimensions	Positionner Material	Permittivity	Loss Tangent
SN 16/15 SAM119	2 mm $\pm$ 0.2 mm	27 liters	Length:1000 mm Width:500 mm Height:200 mm	Gelcoat with fiberglass	3.4	0.02

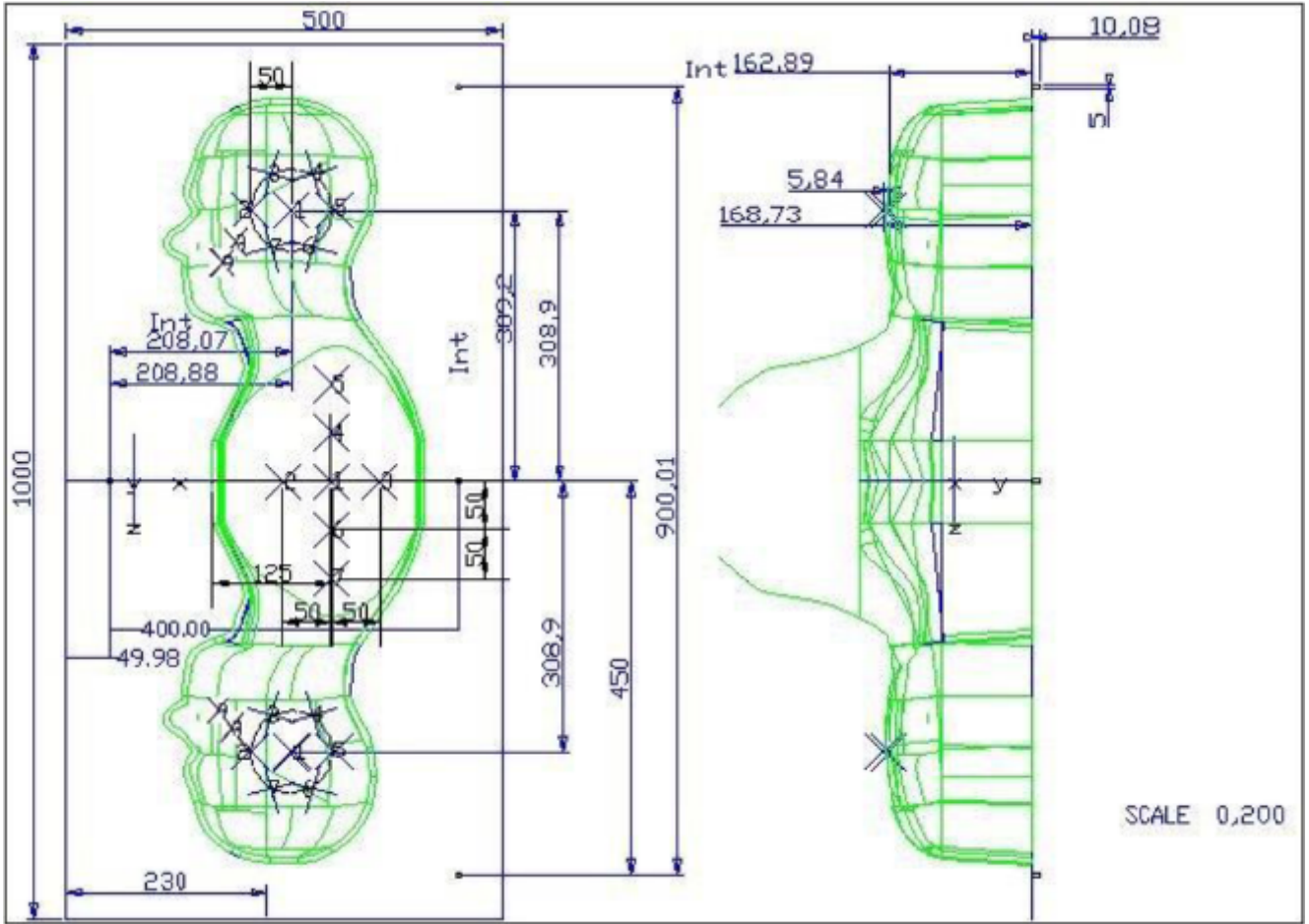

Serial Number	Left Head		Right Head		Flat Part	
<b>SN 16/15 SAM119</b>	2	2.02	2	2.08	1	2.09
	3	2.05	3	2.06	2	2.06
	4	2.07	4	2.07	3	2.08
	5	2.08	5	2.08	4	2.10
	6	2.05	6	2.07	5	2.10
	7	2.05	7	2.05	6	2.07
	8	2.07	8	2.06	7	2.07
	9	2.08	9	2.06	-	-

The test, based on ultrasonic system, allows measuring the thickness with an accuracy of 10 µm.

### 2.5. Device Holder

The positioning system allows obtaining cheek and tilting position with a very good accuracy. In compliance with CENELEC, the tilt angle uncertainty is lower than 1 degree.

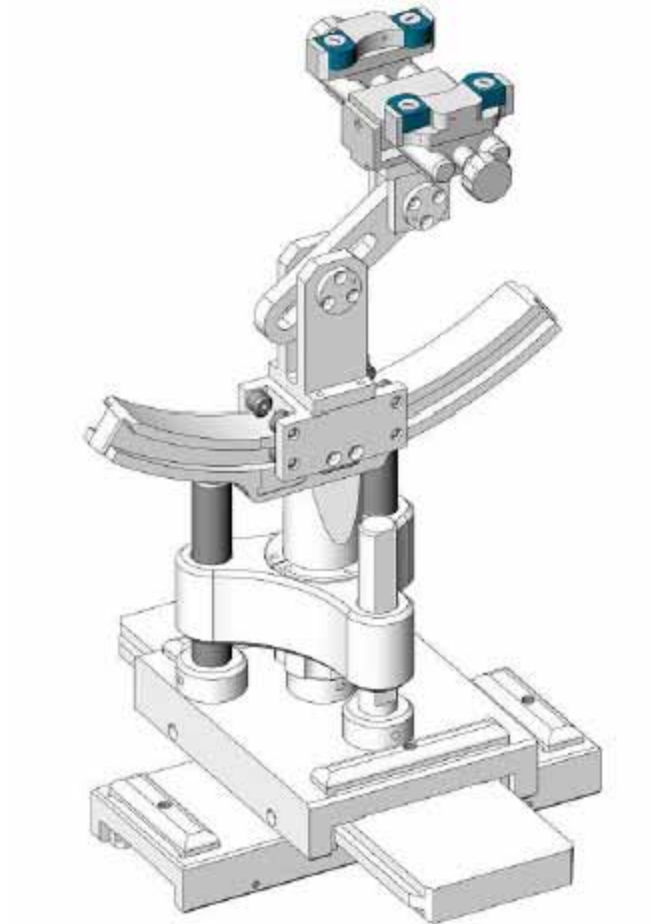

Serial Number	Holder Material	Permittivity	Loss Tangent
SN 16/15 MSH100	Delrin	3.7	0.005

### 2.6. Test Equipment List

This table gives a complete overview of the SAR measurement equipment.

Devices used during the test described are marked

	Manufacturer	Name of Equipment	Type/Model	Serial Number	Calibration	
					Last Cal.	Due Date
<input checked="" type="checkbox"/>	MVG	E FIELD PROBE	SSE2	SN 34/15 EPGO267	Aug. 24, 2015	Aug. 23, 2016
<input type="checkbox"/>	MVG	450 MHz Dipole	SID450	SN 03/15 DIP 0G450-345	Apr. 06, 2015	Apr. 05, 2018
<input type="checkbox"/>	MVG	750 MHz Dipole	SID750	SN 03/15 DIP 0G750-355	Apr. 06, 2015	Apr. 05, 2018
<input checked="" type="checkbox"/>	MVG	835 MHz Dipole	SID835	SN 03/15 DIP 0G835-347	Apr. 06, 2015	Apr. 05, 2018
<input type="checkbox"/>	MVG	900 MHz Dipole	SID900	SN 03/15 DIP 0G900-348	Apr. 06, 2015	Apr. 05, 2018
<input type="checkbox"/>	MVG	1800 MHz Dipole	SID1800	SN 03/15 DIP 1G800-349	Apr. 06, 2015	Apr. 05, 2018
<input checked="" type="checkbox"/>	MVG	1900 MHz Dipole	SID1900	SN 03/15 DIP 1G900-350	Apr. 06, 2015	Apr. 05, 2018
<input type="checkbox"/>	MVG	2000 MHz Dipole	SID2000	SN 03/15 DIP 2G000-351	Apr. 06, 2015	Apr. 05, 2018
<input checked="" type="checkbox"/>	MVG	2450 MHz Dipole	SID2450	SN 03/15 DIP 2G450-352	Apr. 06, 2015	Apr. 05, 2018
<input type="checkbox"/>	MVG	2600 MHz Dipole	SID2600	SN 03/15 DIP 2G600-356	Apr. 06, 2015	Apr. 05, 2018
<input type="checkbox"/>	MVG	5000 MHz Dipole	SWG5500	SN 13/14 WGA 33	Apr. 06, 2015	Apr. 05, 2018
<input checked="" type="checkbox"/>	MVG	Liquid measurement Kit	SCLMP	SN 21/15 OCPG 72	NCR	NCR
<input checked="" type="checkbox"/>	MVG	Power Amplifier	N.A	AMPLISAR_28/14_003	NCR	NCR
<input checked="" type="checkbox"/>	KEITHLEY	Millivoltmeter	2000	4072790	NCR	NCR
<input checked="" type="checkbox"/>	R&S	Universal radio communication tester	CMU200	117858	Aug. 08, 2015	Aug. 07, 2016
<input checked="" type="checkbox"/>	Agilent	Network Analyzer	8753D	3410J01136	Aug. 08, 2015	Aug. 07, 2016
<input checked="" type="checkbox"/>	Agilent	PSG Analog Signal Generator	E8257D	MY51110112	Aug. 08, 2015	Aug. 07, 2016





<input checked="" type="checkbox"/>	Agilent	Power meter	E4419B	MY45102538	Jul. 31, 2015	Jul. 30, 2016
<input checked="" type="checkbox"/>	Agilent	Power sensor	E9301A	MY41495644	Jul. 31, 2015	Jul. 30, 2016
<input checked="" type="checkbox"/>	Agilent	Power sensor	E9301A	US39212148	Jul. 31, 2015	Jul. 30, 2016
<input checked="" type="checkbox"/>	MCLI/USA	Directional Coupler	CB11-20	0D2L51502	Aug. 13, 2015	Aug. 12, 2016

### 3. SAR Measurement Procedures

The measurement procedures are as follows:

<Conducted power measurement>

- (a) For WWAN power measurement, use base station simulator to configure EUT WWAN transmission in conducted connection with RF cable, at maximum power in each supported wireless interface and frequency band.
- (b) Read the WWAN RF power level from the base station simulator.
- (c) For WiFi/BT power measurement, use engineering software to configure EUT WiFi/BT continuously transmission, at maximum RF power in each supported wireless interface and frequency band.
- (d) Connect EUT RF port through RF cable to the power meter, and measure WiFi/BT output power.

<SAR measurement>

- (a) Use base station simulator to configure EUT WWAN transmission in radiated connection, and engineering software to configure EUT WiFi/BT continuously transmission, at maximum RF power, in the highest power channel.
- (b) Place the EUT in the positions as Appendix A demonstrates.
- (c) Set scan area, grid size and other setting on the OPENSAR software.
- (d) Measure SAR results for the highest power channel on each testing position.
- (e) Find out the largest SAR result on these testing positions of each band.
- (f) Measure SAR results for other channels in worst SAR testing position if the reported SAR of highest power channel is larger than 0.8 W/kg.

According to the test standard, the recommended procedure for assessing the peak spatial-average SAR value consists of the following steps:

- (a) Power reference measurement
- (b) Area scan
- (c) Zoom scan
- (d) Power drift measurement

#### 3.1. Power Reference

The Power Reference Measurement and Power Drift Measurements are for monitoring the power drift of the device under test in the batch process. The minimum distance of probe sensors to surface determines the closest measurement point to phantom surface. This distance cannot be smaller than the distance of sensor calibration points to probe tip as defined in the probe properties.

#### 3.2. Area scan & Zoom scan

The area scan is a 2D scan to find the hot spot location on the DUT. The zoom scan is a 3D scan above the hot spot to calculate the 1g and 10g SAR value.

Measurement of the SAR distribution with a grid of 8 to 16 mm \* 8 to 16 mm and a constant distance to

the inner surface of the phantom. Since the sensors cannot directly measure at the inner phantom surface, the values between the sensors and the inner phantom surface are extrapolated. With these values the area of the maximum SAR is calculated by an interpolation scheme. Around this point, a cube of 30 \* 30 \* 30 mm or 32 \* 32 \* 32 mm is assessed by measuring 5 or 8 \* 5 or 8 \* 4 or 5 mm. With these data, the peak spatial-average SAR value can be calculated.

From the scanned SAR distribution, identify the position of the maximum SAR value, in addition identify the positions of any local maxima with SAR values within 2 dB of the maximum value that will not be within the zoom scan of other peaks; additional peaks shall be measured only when the primary peak is within 2 dB of the SAR compliance limit (e.g., 1 W/kg for 1,6 W/kg 1 g limit, or 1,26 W/kg for 2 W/kg, 10 g limit).

Area scan & Zoom scan scan parameters extracted from FCC KDB 865664 D01 SAR measurement 100 MHz to 6 GHz.

		≤ 3 GHz	> 3 GHz	
Maximum distance from closest measurement point (geometric center of probe sensors) to phantom surface		5 ± 1 mm	½·δ·ln(2) ± 0.5 mm	
Maximum probe angle from probe axis to phantom surface normal at the measurement location		30° ± 1°	20° ± 1°	
Maximum area scan spatial resolution: Δx <sub>Area</sub> , Δy <sub>Area</sub>		≤ 2 GHz: ≤ 15 mm 2 – 3 GHz: ≤ 12 mm	3 – 4 GHz: ≤ 12 mm 4 – 6 GHz: ≤ 10 mm	
		When the x or y dimension of the test device, in the measurement plane orientation, is smaller than the above, the measurement resolution must be ≤ the corresponding x or y dimension of the test device with at least one measurement point on the test device.		
Maximum zoom scan spatial resolution: Δx <sub>Zoom</sub> , Δy <sub>Zoom</sub>		≤ 2 GHz: ≤ 8 mm 2 – 3 GHz: ≤ 5 mm *	3 – 4 GHz: ≤ 5 mm * 4 – 6 GHz: ≤ 4 mm *	
Maximum zoom scan spatial resolution, normal to phantom surface	uniform grid: Δz <sub>Zoom</sub> (n)	≤ 5 mm	3 – 4 GHz: ≤ 4 mm 4 – 5 GHz: ≤ 3 mm 5 – 6 GHz: ≤ 2 mm	
	graded grid	Δz <sub>Zoom</sub> (1): between 1 <sup>st</sup> two points closest to phantom surface	≤ 4 mm	3 – 4 GHz: ≤ 3 mm 4 – 5 GHz: ≤ 2.5 mm 5 – 6 GHz: ≤ 2 mm
		Δz <sub>Zoom</sub> (n>1): between subsequent points	≤ 1.5·Δz <sub>Zoom</sub> (n-1)	
Minimum zoom scan volume	x, y, z	≥ 30 mm	3 – 4 GHz: ≥ 28 mm 4 – 5 GHz: ≥ 25 mm 5 – 6 GHz: ≥ 22 mm	

Note: δ is the penetration depth of a plane-wave at normal incidence to the tissue medium; see draft standard IEEE P1528-2011 for details.

\* When zoom scan is required and the *reported* SAR from the *area scan based 1-g SAR estimation* procedures of KDB 447498 is ≤ 1.4 W/kg, ≤ 8 mm, ≤ 7 mm and ≤ 5 mm zoom scan resolution may be applied, respectively, for 2 GHz to 3 GHz, 3 GHz to 4 GHz and 4 GHz to 6 GHz.

### **3.3. Description of interpolation/extrapolation scheme**

The local SAR inside the phantom is measured using small dipole sensing elements inside a probe body. The probe tip must not be in contact with the phantom surface in order to minimise measurements errors, but the highest local SAR will occur at the surface of the phantom.

An extrapolation is used to determine these highest local SAR values. The extrapolation is based on a fourth-order least-square polynomial fit of measured data. The local SAR value is then extrapolated from the liquid surface with a 1 mm step.

The measurements have to be performed over a limited time (due to the duration of the battery) so the step of measurement is high. It could vary between 5 and 8 mm. To obtain an accurate assessment of the maximum SAR averaged over 10 grams and 1 gram requires a very fine resolution in the three dimensional scanned data array.

### **3.4. Volumetric Scan**

The volumetric scan consists to a full 3D scan over a specific area. This 3D scan is useful for multi Tx SAR measurement. Indeed, it is possible with OpenSAR to add, point by point, several volumetric scans to calculate the SAR value of the combined measurement as it is defined in the standard IEEE1528 and IEC62209.

### **3.5. Power Drift**

All SAR testing is under the EUT installed full charged battery and transmit maximum output power. In OpenSAR measurement software, the power reference measurement and power drift measurement procedures are used for monitoring the power drift of EUT during SAR test. Both these procedures measure the field at a specified reference position before and after the SAR testing. The software will calculate the field difference in V/m. If the power drifts more than  $\pm 5\%$ , the SAR will be retested.

## 4. System Verification Procedure

### 4.1. Tissue Verification

The following tissue formulations are provided for reference only as some of the parameters have not been thoroughly verified. The composition of ingredients may be modified accordingly to achieve the desired target tissue parameters required for routine SAR evaluation.

Ingredients (% of weight)	Head Tissue							
Frequency Band (MHz)	750	835	900	1800	1900	2000	2450	2600
Water	34.40	34.40	34.40	55.36	55.36	57.87	57.87	57.87
NaCl	0.79	0.79	0.79	0.35	0.35	0.16	0.16	0.16
1,2-Propanediol	64.81	64.81	64.81	0.00	0.00	0.00	0.00	0.00
Triton X-100	0.00	0.00	0.00	30.45	30.45	19.97	19.97	19.97
DGBE	0.00	0.00	0.00	13.84	13.84	22.00	22.00	22.00
Ingredients (% of weight)	Body Tissue							
Frequency Band (MHz)	750	835	900	1800	1900	2000	2450	2600
Water	50.30	50.30	50.30	69.91	69.91	71.88	71.88	71.88
NaCl	0.60	0.60	0.60	0.13	0.13	0.16	0.16	0.16
1,2-Propanediol	49.10	49.10	49.10	0.00	0.00	0.00	0.00	0.00
Triton X-100	0.00	0.00	0.00	9.99	9.99	19.97	19.97	19.97
DGBE	0.00	0.00	0.00	19.97	19.97	7.99	7.99	7.99

#### 4.1.1. Tissue Dielectric Parameter Check Results

The simulating liquids should be checked at the beginning of a series of SAR measurements to determine if the dielectric parameters are within the tolerances of the specified target values. The measured conductivity and relative permittivity should be within  $\pm 5\%$  of the target values.

Tissue Type	Measured Frequency (MHz)	Target Tissue		Measured Tissue		Liquid Temp.	Test Date
		$\epsilon_r$ ( $\pm 5\%$ )	$\sigma$ (S/m) ( $\pm 5\%$ )	$\epsilon_r$	$\sigma$ (S/m)		
Head 850	835	41.50 (39.43~43.57)	0.90 (0.86~0.94)	41.99	0.88	21.4 °C	May 06, 2016
Body 850	835	55.20 (52.44~57.96)	0.97 (0.92~1.01)	55.19	0.99	21.3 °C	May 06, 2016
Head 1900	1900	40.00 (38.00~42.00)	1.40 (1.33~1.47)	39.10	1.44	21.4 °C	May 07, 2016
Body 1900	1900	53.30 (50.64~55.96)	1.52 (1.44~1.59)	53.36	1.54	21.6 °C	May 07, 2016
Head 2450	2450	39.20 (37.24~41.16)	1.80 (1.71~1.89)	39.95	1.83	21.3 °C	May 09, 2016

Body 2450	2450	52.70 (50.07~55.33)	1.95 (1.85~2.04)	51.32	1.93	21.5 °C	May 10, 2016
--------------	------	------------------------	---------------------	-------	------	---------	--------------

NOTE: The dielectric parameters of the tissue-equivalent liquid should be measured under similar ambient conditions and within 2 °C of the conditions expected during the SAR evaluation to satisfy protocol requirements.

### 4.2. System Verification Procedure

The system verification is performed for verifying the accuracy of the complete measurement system and performance of the software. The dipole is connected to the signal source consisting of signal generator and amplifier via a directional coupler, N-connector cable and adaption to SMA. It is fed with a power of 100mW (below 5GHz) or 100mW (above 5GHz). To adjust this power a power meter is used. The power sensor is connected to the cable before the system verification to measure the power at this point and do adjustments at the signal generator. At the outputs of the directional coupler both return loss as well as forward power are controlled during the system verification to make sure that emitted power at the dipole is kept constant. This can also be checked by the power drift measurement after the test (result on plot).

The system verification is shown as below picture:

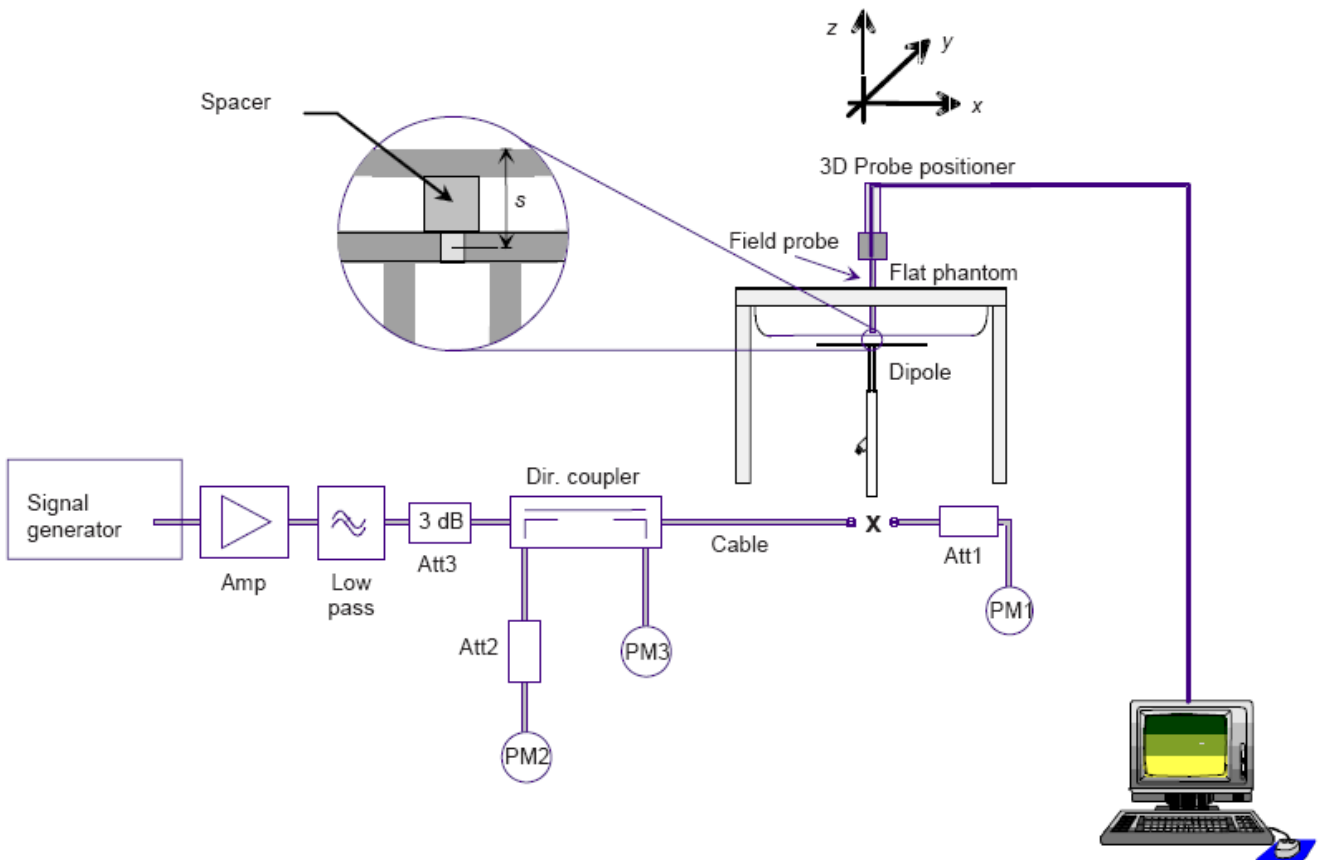

**4.2.1. System Verification Results**

Comparing to the original SAR value provided by SATIMO, the verification data should be within its specification of  $\pm 10\%$ . Below table shows the target SAR and measured SAR after normalized to 1W input power. The table below indicates the system performance verification can meet the variation criterion and the plots can be referred to Appendix B of this report.

System Verification	Target SAR (1W) ( $\pm 10\%$ )		Measured SAR (Normalized to 1W)		Liquid Temp.	Test Date
	1-g (W/Kg)	10-g (W/Kg)	1-g (W/Kg)	10-g (W/Kg)		
835MHz Head	9.56 (8.60~10.51)	6.22 (5.60~6.84)	9.55	6.22	21.4 °C	May 06, 2016
835MHz Body	9.48 (8.53~10.42)	6.29 (5.66~6.91)	8.95	5.88	21.3 °C	May 06, 2016
1900MHz Head	39.70 (35.73~43.67)	20.50 (18.45~22.55)	41.05	20.72	21.4 °C	May 07, 2016
1900MHz Body	38.43 (34.59~42.27)	20.34 (18.31~22.37)	38.96	19.95	21.6 °C	May 07, 2016
2450MHz Head	52.40 (47.16~57.64)	24.00 (21.60~26.40)	55.20	24.65	21.3 °C	May 09, 2016
2450MHz Body	49.32 (44.39~54.25)	22.89 (20.60~25.17)	51.02	23.57	21.5 °C	May 10, 2016

## 5. SAR Measurement variability and uncertainty

### 5.1. SAR measurement variability

Per KDB865664 D01 SAR measurement 100 MHz to 6 GHz, SAR measurement variability must be assessed for each frequency band, which is determined by the SAR probe calibration point and tissue-equivalent medium used for the device measurements. The additional measurements are repeated after the completion of all measurements requiring the same head or body tissue-equivalent medium in a frequency band. The test device should be returned to ambient conditions (normal room temperature) with the battery fully charged before it is re-mounted on the device holder for the repeated measurement(s) to minimize any unexpected variations in the repeated results.

- 1) Repeated measurement is not required when the original highest measured SAR is  $< 0.80$  W/kg; steps 2) through 4) do not apply.
- 2) When the original highest measured SAR is  $\geq 0.80$  W/kg, repeat that measurement once.
- 3) Perform a second repeated measurement only if the ratio of largest to smallest SAR for the original and first repeated measurements is  $> 1.20$  or when the original or repeated measurement is  $\geq 1.45$  W/kg (~ 10% from the 1-g SAR limit).
- 4) Perform a third repeated measurement only if the original, first or second repeated measurement is  $\geq 1.5$  W/kg and the ratio of largest to smallest SAR for the original, first and second repeated measurements is  $> 1.20$ .

### 5.2. SAR measurement uncertainty

Per KDB865664 D01 SAR Measurement 100 MHz to 6 GHz, when the highest measured 1-g SAR within a frequency band is  $< 1.5$  W/kg, the extensive SAR measurement uncertainty analysis described in IEEE Std 1528-2013 is not required in SAR reports submitted for equipment approval. The equivalent ratio (1.5/1.6) is applied to extremity and occupational exposure conditions.



## 6. RF Exposure Positions

### 6.1. Ear and handset reference point

Figure 6.1.1 shows the front, back, and side views of the SAM phantom. The center-of-mouth reference point is labeled “M”, the left ear reference point (ERP) is marked “LE”, and the right ERP is marked “RE”.



Fig 6.1.1 Front, back, and side views of SAM phantom

### 6.2. Definition of the cheek position

1. Define two imaginary lines on the handset, the vertical centerline and the horizontal line. The vertical centerline passes through two points on the front side of the handset: the midpoint of the width  $w_t$  of the handset at the level of the acoustic output (point A in Figure 6.2.1 and Figure 6.2.2), and the midpoint of the width  $w_b$  of the bottom of the handset (point B). The horizontal line is perpendicular to the vertical centerline and passes through the center of the acoustic output (see Figure 6.2.1). The two lines intersect at point A. Note that for many handsets, point A coincides with the center of the acoustic output; however, the acoustic output may be located elsewhere on the horizontal line. Also note that the vertical centerline is not necessarily parallel to the front face of the handset (see Figure 6.2.2), especially for clamshell handsets, handsets with flip covers, and other irregularly-shaped handsets.
2. Position the handset close to the surface of the phantom such that point A is on the (virtual) extension of the line passing through points RE and LE on the phantom (see Figure 6.2.3), such that the plane defined by the vertical centerline and the horizontal line of the handset is approximately parallel to the sagittal plane of the phantom.
3. Translate the handset towards the phantom along the line passing through RE and LE until handset point A touches the pinna at the ERP
4. While maintaining the handset in this plane, rotate it around the LE-RE line until the vertical centerline is in the plane normal to the plane containing B-M and N-F lines, i.e., the Reference Plane.
5. Rotate the handset around the vertical centerline until the handset (horizontal line) is parallel to the N-F line.

6. While maintaining the vertical centerline in the Reference Plane, keeping point A on the line passing through RE and LE, and maintaining the handset contact with the pinna, rotate the handset about the N-F line until any point on the handset is in contact with a phantom point below the pinna on the cheek. See Figure 6.2.3. The actual rotation angles should be documented in the test report.

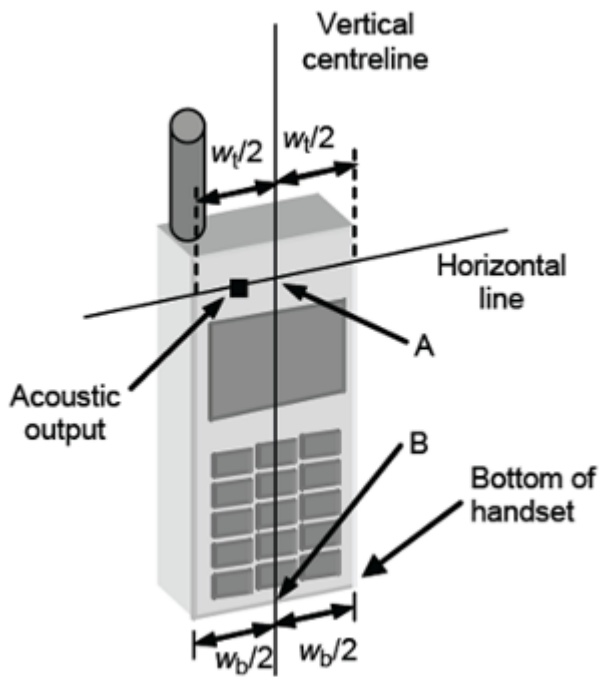

Fig 6.2.1 Handset vertical and horizontal reference lines—“fixed case”

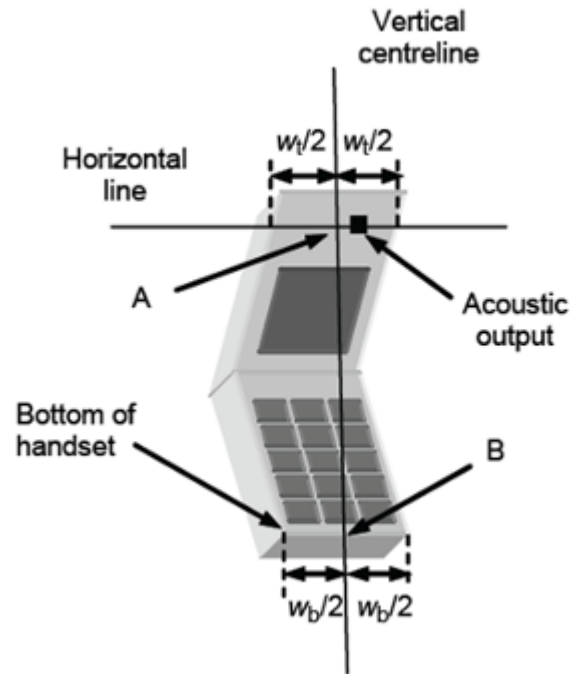

Fig 6.2.2 Handset vertical and horizontal reference lines—“clam-shell case”

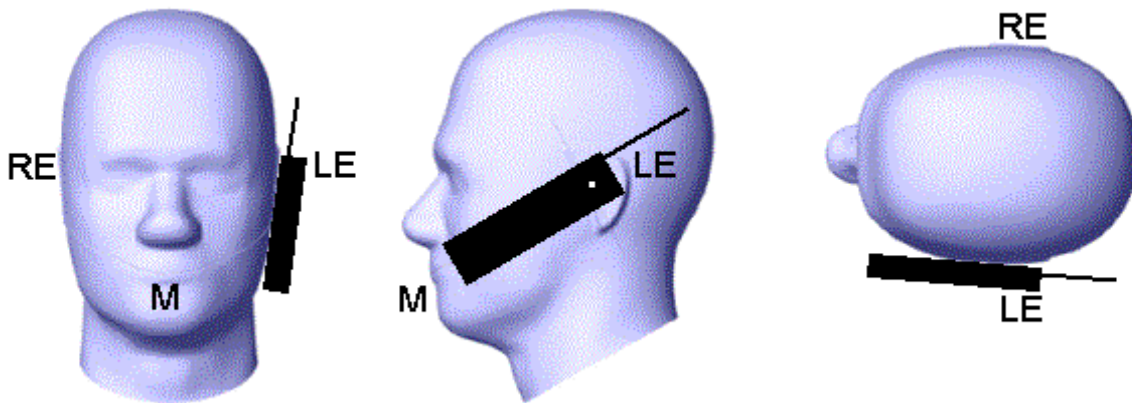

Fig 6.2.3 cheek or touch position. The reference points for the right ear (RE), left ear (LE), and mouth (M), which establish the Reference Plane for handset positioning, are indicated.

### 6.3. Definition of the tilt position

1. While maintaining the orientation of the handset, retract the handset parallel to the reference plane far enough away from the phantom to enable a rotation of the device by 15 degree.
2. Rotate the Handset around the horizontal line by 15 degree (see Figure 6.3.1).
3. While maintaining the orientation of the handset, move the handset towards the phantom on a line passing through RE and LE until any part of the handset touches the ear. The tilt position is obtained when the contact is on the pinna. If the contact is at any location other than the pinna, e.g., the antenna with the back of the phantom head, the angle of the handset shall be reduced. In this case, the tilt position is obtained if any part of the handset is in contact with the pinna as well as a second part of the handset is in contact with the phantom, e.g., the antenna with the back of the head.

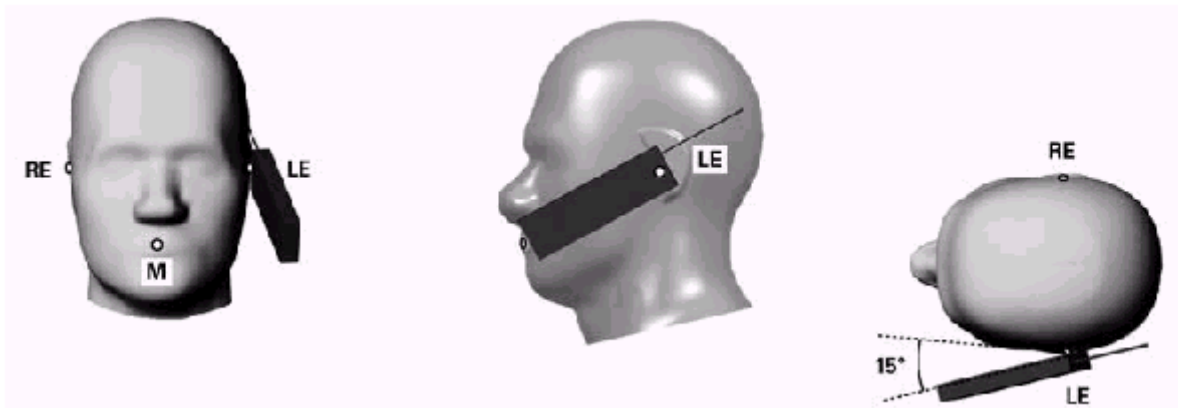

Figure 6.3.1 – Tilt position of the wireless device on the left side of SAM

### 6.4. Tablet SAR test considerations

Most recent tablets are designed with an interactive display that may not require a physical keyboard. Both configurations are used in similar manners and require SAR evaluation for the back surface and edges of the tablet.

- a)  $\leq 5$  mm between the antenna and user for both back surface and edge exposure conditions
- b) the antennas used by the host must have been tested for equipment approval or qualify for SAR test exclusion
- c) the antenna polarization, physical orientation, rotation and installation configurations used by the host must have been tested for compliance or qualify for test exclusion

## 6.5. Phablet SAR test considerations

The UMPC mini-tablets SAR procedures are primarily intended for devices with an overall diagonal dimensions  $\leq 20$  cm that operate like a tablet and mainly support hand-held interactive use next to or near the body of users, with no provision for next to the ear voice mode operations. Early generation mini-tablets are typically designed and optimized for mobile web access and multimedia support; whereas earlier smart phones are primarily intended for voice communication with varying data capabilities. As the use conditions for recent generation UMPC mini-tablets and smart phones are gradually merging; some UMPC mini-tablets are also supporting next to the ear voice mode operations and smart phones are incorporating certain mini-tablet operating characteristics. This new generation of devices has been referred to by industry as “phablets”.

For smart phones with a display diagonal dimension  $> 15.0$  cm or an overall diagonal dimension  $> 16.0$  cm that provide similar mobile web access and multimedia support found in mini-tablets or UMPC mini-tablets that support voice calls next to the ear, unless it is confirmed otherwise through KDB inquiries, the following phablet procedures should be applied to evaluate SAR compliance for each applicable wireless modes and frequency band. Devices marketed as phablets, regardless of form factors and operating characteristics must be tested as a phablet to determine SAR compliance.

1. The normally required head and body-worn accessory SAR test procedures for handsets, including hotspot mode, must be applied.
2. The UMPC mini-tablet procedures must also be applied to test the SAR of all surfaces and edges with an antenna located at  $\leq 25$  mm from that surface or edge, in direct contact with a flat phantom, for 10-g extremity SAR according to the body-equivalent tissue dielectric parameters in KDB 865664 to address interactive hand use exposure conditions. The UMPC mini-tablet 1-g SAR at 5 mm is not required. When hotspot mode applies, 10-g extremity SAR is required only for the surfaces and edges with hotspot mode 1-g reported SAR  $> 1.2$  W/kg; however, when power reduction applies to hotspot mode the measured SAR must be scaled to the maximum output power, including tolerance, allowed for phablet modes to compare with the 1.2 W/kg SAR test reduction threshold. The normal tablet procedures in KDB 616217 are required when the over diagonal dimension of the device is  $> 20.0$  cm. Hotspot mode SAR is not required when normal tablet procedures are applied. Extremity 10-g SAR is also not required for the front (top) surface of large form factor full size tablets. The more conservative tablet SAR results can be used to support the 10-g extremity SAR for phablet mode.
3. The simultaneous transmission operating configurations applicable to voice and data transmissions for both phone and mini-tablet modes must be taken into consideration separately for 1-g and 10-g SAR to determine the simultaneous transmission SAR test exclusion and measurement requirements for the relevant wireless modes and exposure conditions.

## 7. RF Output Power

### 7.1. Maximum Tune-up Limit

Band	Mode	The Tune-up Maximum Power (Customer Declared)(dBm)	Range	Measured Maximum Output Power(dBm)
GSM 850	GSM (GMSK)	32±1	31~33	32.22
	GPRS(GMSK, 1TS)	32±1	31~33	32.20
	GPRS(GMSK, 2TS)	31±1	30~32	31.40
	GPRS(GMSK, 3TS)	29±1	28~30	29.65
	GPRS(GMSK, 4TS)	28±1	27~29	28.51
	EDGE(8PSK, 1TS)	25±1	24~26	25.66
	EDGE(8PSK, 2TS)	24±1	23~25	24.22
	EDGE(8PSK, 3TS)	21±1	20~22	21.67
	EDGE(8PSK, 4TS)	20±1	19~21	20.78
GSM 1900	GSM (GMSK)	29±1	28~30	29.44
	GPRS(GMSK, 1TS)	29±1	28~30	29.42
	GPRS(GMSK, 2TS)	28±1	27~29	28.51
	GPRS(GMSK, 3TS)	26±1	25~27	26.72
	GPRS(GMSK, 4TS)	25±1	24~26	25.60
	EDGE(8PSK, 1TS)	26±1	25~27	26.51
	EDGE(8PSK, 2TS)	25±1	24~26	25.70
	EDGE(8PSK, 3TS)	23±1	22~24	23.84
	EDGE(8PSK, 4TS)	22±1	21~23	22.81
UMTS Band V	RMC 12.2Kbps	23±1	22~24	23.73
	HSDPA Subtest-1	22±1	21~23	22.70
	HSDPA Subtest-2	21±1	20~22	21.42
	HSDPA Subtest-3	21±1	20~22	21.24
	HSDPA Subtest-4	21±1	20~22	21.24
	HSUPA Subtest-1	22±1	21~23	22.70
	HSUPA Subtest-2	21±1	20~22	21.34
	HSUPA Subtest-3	21±1	20~22	21.36
	HSUPA Subtest-4	21±1	20~22	21.36
	HSUPA Subtest-5	21±1	20~22	21.48
UMTS Band II	RMC 12.2Kbps	22±1	21~23	22.80
	HSDPA Subtest-1	22±1	21~23	22.42
	HSDPA Subtest-2	20±1	19~21	20.88
	HSDPA Subtest-3	20±1	19~21	20.45
	HSDPA Subtest-4	20±1	19~21	20.53

	HSUPA Subtest-1	21±1	20~22	21.79
	HSUPA Subtest-2	20±1	19~21	20.86
	HSUPA Subtest-3	20±1	19~21	20.87
	HSUPA Subtest-4	20±1	19~21	20.69
	HSUPA Subtest-5	20±1	19~21	20.97
WiFi 2.4G	802.11b	14±1	13~15	14.14
	802.11g	10±1	9~11	10.71
	802.11n-HT20	10±1	9~11	10.86
	802.11n-HT40	8±1	7~9	8.12
BT	3.0	2±1	1~3	2.43
	4.0	-6±1	-7~-5	-5.65

**7.2. GSM Conducted Power**

- 1) Per KDB 447498 D01, the maximum output power channel is used for SAR testing and for further SAR test reduction.
- 2) Per KDB 941225 D01, considering the possibility of e.g. 3rd party VoIP operation for Head and body-worn SAR test reduction for GSM and GPRS modes is determined by the source-based time-averaged output power including tune-up tolerance. The mode with highest specified time-averaged output power should be tested for SAR compliance in the applicable exposure conditions. For modes with the same specified maximum output power and tolerance, the higher number time-slot configuration should be tested. Therefore, the EUT was set in GPRS for GSM850(4Tx slots) and GSM1900(4Tx slots).
- 3) Per KDB 941225 D01, for Hotspot SAR test reduction for GPRS modes is determined by the source-based time-averaged output power including tune-up tolerance, for modes with the same specified maximum output power and tolerance, the higher number time-slot configuration should be tested, therefore, the EUT was set in GPRS for GSM850(4Tx slots) and GSM1900(4Tx slots).

Band GSM850	Burst-Averaged output Power (dBm)				Frame-Averaged output Power (dBm)				
	Tx Channel	Tune-up	128	189	251	Tune-up	128	189	251
Frequency (MHz)	(dBm)	824.2	836.4	848.8	(dBm)	824.2	836.4	848.8	
GSM (GMSK)	33.00	32.02	32.15	32.22	23.97	22.99	23.12	23.19	
GPRS(GMSK, 1 TS)	33.00	32.05	32.15	32.20	23.97	23.02	23.12	23.17	
GPRS(GMSK, 2 TS)	32.00	31.24	31.35	31.40	25.98	25.22	25.33	25.38	
GPRS(GMSK, 3 TS)	30.00	29.43	29.53	29.65	25.74	25.17	25.27	25.39	
GPRS(GMSK, 4 TS)	29.00	28.23	28.39	28.51	25.99	25.22	25.38	25.50	
EDGE(8PSK, 1 TS)	26.00	25.66	25.31	25.12	16.97	16.63	16.28	16.09	
EDGE(8PSK, 2 TS)	25.00	24.22	24.02	23.72	18.98	18.20	18.00	17.70	
EDGE(8PSK, 3 TS)	22.00	21.67	21.46	21.11	17.74	17.41	17.20	16.85	
EDGE(8PSK, 4 TS)	21.00	20.78	20.38	20.16	17.99	17.77	17.37	17.15	
Band GSM1900	Burst-Averaged output Power (dBm)				Frame-Averaged output Power (dBm)				



Tx Channel	Tune-up	512	661	810	Tune-up	512	661	810
Frequency (MHz)	(dBm)	1850.2	1880.0	1909.8	(dBm)	1850.2	1880.0	1909.8
GSM (GMSK)	30.00	29.44	29.32	29.30	20.97	20.41	20.29	20.27
GPRS(GMSK, 1 TS)	30.00	29.42	29.31	29.25	20.97	20.39	20.28	20.22
GPRS(GMSK, 2 TS)	29.00	28.51	28.45	28.41	22.98	22.49	22.43	22.39
GPRS(GMSK, 3 TS)	27.00	26.72	26.64	26.63	22.74	22.46	22.38	22.37
GPRS(GMSK, 4 TS)	26.00	25.59	25.56	25.60	22.99	22.58	22.55	22.59
EDGE(8PSK, 1 TS)	27.00	26.11	26.41	26.51	17.97	17.08	17.38	17.48
EDGE(8PSK, 2 TS)	26.00	25.16	25.48	25.70	19.98	19.14	19.46	19.68
EDGE(8PSK, 3 TS)	24.00	23.37	23.60	23.84	19.74	19.11	19.34	19.58
EDGE(8PSK, 4 TS)	23.00	22.20	22.57	22.81	19.99	19.19	19.56	19.80

Note: The frame-averaged power is linearly scaled the maximum burst averaged power over 8 time slots.

The calculated method are shown as below:

Frame-averaged power = Maximum burst averaged power (1 TS) – 9.03 dB

Frame-averaged power = Maximum burst averaged power (2 TS) – 6.02 dB

Frame-averaged power = Maximum burst averaged power (3 TS) - 4.26 dB

Frame-averaged power = Maximum burst averaged power (4 TS) – 3.01 dB

### 7.3. UMTS Conducted Power

The following tests were conducted according to the test requirements outlines in 3GPP TS 34.121 specification. A summary of these settings are illustrated below:

#### 1. Release99 Setup Configuration

Mode	Subtest	Rel99
UMTS General Settings	Loopback Mode	Test Mode 1
	Rel99 RMC	12.2kbps RMC
	Power Control Algorithm	Algorithm2
	$\beta_c/\beta_d$	8/15

#### 2. HSDPA Setup Configuration

	Mode	HSDPA	HSDPA	HSDPA	HSDPA
	Subtest	1	2	3	4
UMTS General Settings	Loopback Mode	Test Mode 1			
	Rel99 RMC	12.2kbps RMC			
	HSDPA FRC	H-Set1			
	Power Control Algorithm	Algorithm 2			
	$\beta_c$	2/15	12/15	15/15	15/15
	$\beta_d$	15/15	15/15	8/15	4/15
	Bd (SF)	64			
	$\beta_c/\beta_d$	2/15	12/15	15/8	15/4
HSDPA Specific Settings	$\beta_{hs}$	4/15	24/15	30/15	30/15
	$D_{ACK}$	8			
	$D_{NAK}$	8			
	DCQI	8			
	Ack-Nack repetition factor	3			
	CQI Feedback (Table 5.2B.4)	4ms			
CQI Repetition Factor (Table	2				

	5.2B.4)	
	Ahs = $\beta_{hs}/\beta_c$	30/15

3. HSUPA Setup Configuration

	Mode	HSUPA	HSUPA	HSUPA	HSUPA	HSUPA	
	Subtest	1	2	3	4	5	
UMTS Settings	General	Loopback Mode					Test Mode 1
		Rel99 RMC					12.2kbps RMC
		HSDPA FRC					H-Set1
		HSUPA Test					HSUPA Loopback
		Power Control Algorithm					Algorithm2
		$\beta_c$	11/15	6/15	15/15	2/15	15/15
		$\beta_d$	15/15	15/15	9/15	15/15	15/15
		$\beta_{ec}$	209/225	12/15	30/15	2/15	24/15
		$\beta_c/\beta_d$	11/15	6/15	15/9	2/15	15/15
		$\beta_{hs}$	22/15	12/15	30/15	4/15	30/15
		$\beta_{ed}$	1309/225	94/75	47/15 47/15	56/75	134/15
		CM (dB)	1.0	3.0	2.0	3.0	1.0
HSDPA Settings	Specific	D <sub>ACK</sub>					8
		D <sub>NAK</sub>					8
		DCQI					8
		Ack-Nack repetition factor					3
		CQI Feedback (Table 5.2B.4)					4ms
		CQI Repetition Factor (Table 5.2B.4)					2
		Ahs = $\beta_{hs}/\beta_c$					30/15
HSUPA Settings	Specific	D E-DPCCH	6	8	8	5	7
		DHARQ	0	0	0	0	0
		AG Index	20	12	15	17	21
		ETFICI (from 34.121 Table C.11.1.3)	75	67	92	71	81
		Associated Max UL Data Rate kbps	242.1	174.9	482.8	205.8	308.9



4. UMTS Conducted Power Results

- 1) Per KDB 941225 D01, SAR for Head / Hotspot / Body-worn exposure is measured using a 12.2 kbps RMC with TPC bits configured to all "1's".
- 2) Per KDB 941225 D01, RMC 12.2kbps setting is used to evaluate SAR. If the maximum output power and tune-up tolerance specified for production units in HSDPA / HSUPA is  $\leq \frac{1}{4}$  dB higher than RMC 12.2Kbps or when the highest reported SAR of the RMC12.2Kbps is scaled by the ratio of specified maximum output power and tune-up tolerance of HSDPA / HSUPA to RMC12.2Kbps and the adjusted SAR is  $\leq 1.2$  W/kg, SAR measurement is not required for HSDPA / HSUPA.

Band	UMTS Band V			
Tx Channel	Tune-up	4132	4182	4233
Frequency (MHz)		826.4	836.4	846.6
RMC 12.2Kbps	24.00	23.40	23.73	23.32
HSDPA Subtest-1	23.00	22.42	22.70	22.40
HSDPA Subtest-2	22.00	21.42	21.33	21.37
HSDPA Subtest-3	22.00	21.24	21.18	21.08
HSDPA Subtest-4	22.00	21.22	21.24	21.11
HSUPA Subtest-1	23.00	22.36	22.70	22.42
HSUPA Subtest-2	22.00	21.32	21.25	21.34
HSUPA Subtest-3	22.00	21.36	21.29	21.31
HSUPA Subtest-4	22.00	21.29	21.36	21.19
HSUPA Subtest-5	22.00	21.48	21.39	21.41
Band	UMTS Band II			
Tx Channel	Tune-up	9262	9400	9538
Frequency (MHz)		1852.4	1880	1907.6
RMC 12.2Kbps	23.00	22.20	22.63	22.80
HSDPA Subtest-1	23.00	22.12	22.42	21.80
HSDPA Subtest-2	21.00	20.15	20.09	20.88
HSDPA Subtest-3	21.00	20.07	20.01	20.45
HSDPA Subtest-4	21.00	20.06	19.98	20.53
HSUPA Subtest-1	22.00	21.16	21.51	21.79
HSUPA Subtest-2	21.00	20.49	20.86	20.74
HSUPA Subtest-3	21.00	20.46	20.87	20.77
HSUPA Subtest-4	21.00	20.43	20.65	20.69
HSUPA Subtest-5	21.00	20.97	20.85	20.93

### 7.4. WiFi & BT Output Power

#### 7.4.1. Output Power Results Of WiFi

The output power of WiFi is as following:

Mode	Channel	Frequency (MHz)	Tune-up	Output Power (dBm)
802.11b	1	2412	15.00	13.13
	6	2437	15.00	13.13
	11	2462	15.00	14.14
802.11g	1	2412	11.00	9.18
	6	2437	11.00	10.71
	11	2462	11.00	9.62
802.11n (HT20)	1	2412	11.00	9.11
	6	2437	11.00	10.86
	11	2462	11.00	9.49
802.11n (HT40)	3	2422	9.00	7.79
	6	2437	9.00	8.12
	9	2452	9.00	7.51

#### 7.4.2. Output Power Results Of BT

The output power of BT is as following:

BT(3.0)	Output Power (dBm)				
	Channel	Tune-up	Data Rates		
			1M	2M	3M
	0CH	3.00	1.73	1.29	1.24
	39CH	3.00	2.43	1.99	1.95
	78CH	3.00	2.41	1.99	1.92

BT(4.0)	Channel	Tune-up	Output Power (dBm)
	0CH	-5.00	-6.23
	19CH	-5.00	-5.69
	39CH	-5.00	-5.65

### 8. Antenna Location

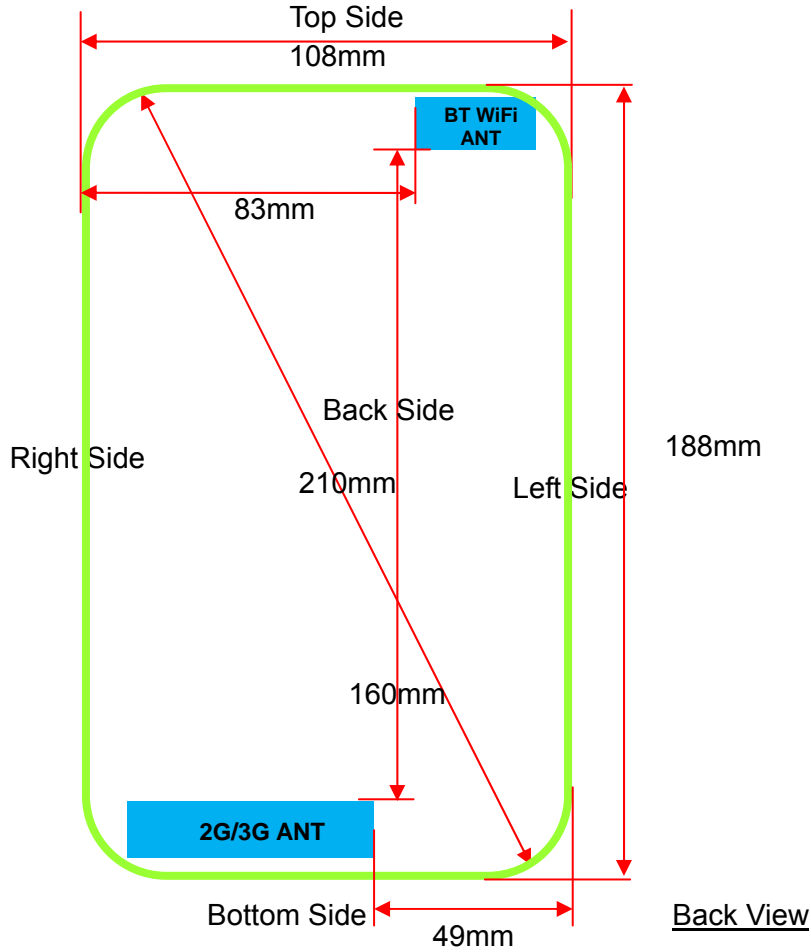

Distance of the Antenna to the EUT surface/edge						
Antennas	Front Side	Back Side	Left Side	Right Side	Top Side	Bottom Side
WWAN Main	≤ 25mm	≤ 25mm	>25mm	≤ 25mm	> 25mm	≤ 25mm
WLAN & BT	≤ 25mm	≤ 25mm	≤ 25mm	> 25mm	≤ 25mm	> 25mm

Positions for SAR tests						
Antennas	Front Side	Back Side	Left Side	Right Side	Top Side	Bottom Side
WWAN Main	Yes	Yes	NO	Yes	NO	Yes
WLAN & BT	Yes	Yes	Yes	NO	Yes	NO

### 9. Stand-alone SAR test exclusion

Per FCC KDB 447498D01, the 1-g SAR and 10-g SAR test exclusion thresholds for 100 MHz to 6 GHz at test separation distances  $\leq 50$  mm are determined by:

$[(\text{max. power of channel, including tune-up tolerance, mW}) / (\text{min. test separation distance, mm})] \cdot [\sqrt{f_{\text{(GHz)}}}] \leq 3.0$  for 1-g SAR and  $\leq 7.5$  for 10-g extremity SAR, where:

- $f_{\text{(GHz)}}$  is the RF channel transmit frequency in GHz
- Power and distance are rounded to the nearest mW and mm before calculation
- The result is rounded to one decimal place for comparison

When the minimum test separation distance is  $< 5$  mm, a distance of 5 mm is applied to determine SAR test exclusion.

Mode	$P_{\text{max}}$ (dBm)	$P_{\text{max}}$ (mW)	Distance (mm)	f (GHz)	Calculation Result	SAR Exclusion threshold	SAR test exclusion
BT	3	2	<5	2.480	0.63	3.0	Yes

NOTE: Standalone SAR test exclusion for BT

When standalone SAR test exclusion applies to an antenna that transmits simultaneously with other antennas, the standalone SAR must be estimated according to following to determine simultaneous transmission SAR test exclusion:

$[(\text{max. power of channel, including tune-up tolerance, mW}) / (\text{min. test separation distance, mm})] \cdot [\sqrt{f_{\text{(GHz)}}/x}] \text{ W/kg}$  for test separation distances  $\leq 50\text{mm}$ , where  $x = 7.5$  for 1-g SAR and  $x = 18.75$  for 10-g SAR.

When the minimum test separation distance is  $< 5$  mm, a distance of 5 mm is applied to determine SAR test exclusion.

Mode	Position	$P_{\text{max}}$ (dBm)	$P_{\text{max}}$ (mW)	Distance (mm)	f (GHz)	x	Estimated SAR (W/Kg)
BT	Head	3	2	<5	2.480	7.5	0.084
BT	Body	3	2	<5	2.480	7.5	0.084

NOTE: Estimated SAR calculation for BT

## 10. SAR Measurement Results

### 10.1. SAR measurement results

General Notes:

- 1) Per KDB447498 D01, all measurement SAR results are scaled to the maximum tune-up tolerance limit to demonstrate compliant.
- 2) Per KDB447498 D01, testing of other required channels within the operating mode of a frequency band is not required when the reported 1-g or 10-g SAR for the mid-band or highest output power channel is:  $\leq 0.8$  W/kg or  $2.0$  W/kg, for 1-g or 10-g respectively, when the transmission band is  $\leq 100$  MHz. When the maximum output power variation across the required test channels is  $> \frac{1}{2}$  dB, instead of the middle channel, the highest output power channel must be used.
- 3) Per KDB865664 D01, for each frequency band, repeated SAR measurement is required only when the measured SAR is  $\geq 0.8$ W/Kg; if the deviation among the repeated measurement is  $\leq 20\%$ , and the measured SAR  $< 1.45$ W/Kg, only one repeated measurement is required.
- 4) Per KDB648474 D04, SAR is evaluated without a headset connected to the device. When the standalone reported Body-Worn SAR is  $\leq 1.2$  W/kg, no additional SAR evaluations using a headset are required.
- 5) Per KDB648474D04, the device is considered a "Phablet" since the diagonal dimension is greater than 160mm and less than 200mm. 10-g Extremity SAR tests are required when hotspot mode does not apply or if hotspot 1-g reported SAR  $> 1.2$  W/kg when scaled to the maximum allowed output power tolerance. When hotspot mode applies, 10-g extremity SAR is required only for the surfaces and edges with hotspot mode 1-g reported SAR  $> 1.2$  W/kg. When power reduction applies to hotspot mode the measured SAR must be scaled to the maximum output power, including tolerance, allowed for Phablet modes to compare with the 1.2 W/kg SAR test reduction threshold. Simultaneous transmission SAR consideration for 10-g extremity SAR requires consideration only when standalone 10-g SAR is required.
- 6) Per KDB865664 D02, SAR plot is only required for the highest measured SAR in each exposure configuration, wireless mode and frequency band combination; Plots are also required when the measured SAR is  $> 1.5$  W/kg, or  $> 7.0$  W/kg for occupational exposure. The published RF exposure KDB procedures may require additional plots; for example, to support SAR to peak location separation ratio test exclusion and/or volume scan post-processing(Refer to appendix C for details).
- 7) Per KDB941225 D06, the DUT Dimension is bigger than 9 cm x 5 cm, so 10mm is chosen as the test separation distance for Hotspot mode. When the antenna-to-edge distance is greater than 2.5cm, such position does not need to be tested.

**10.1.1. SAR measurement Result of GSM850**

Test Position of Head	Test channel /Freq.	Test Mode	SAR Value (W/kg)		Power Drift (±5%)	Conducted power (dBm)	Tune-up power (dBm)	Scaled SAR 1g (W/Kg)
			1g	10g				
Left Cheek	251/848.8	GPRS(GMSK 4TS)	0.051	0.040	0.24	28.51	29.00	<b>0.057</b>
Left Tilt 15 Degree	251/848.8	GPRS(GMSK 4TS)	0.048	0.035	-1.04	28.51	29.00	0.054
Right Cheek	251/848.8	GPRS(GMSK 4TS)	0.051	0.041	-2.49	28.51	29.00	<b>0.057</b>
Right Tilt 15 Degree	251/848.8	GPRS(GMSK 4TS)	0.042	0.033	-0.27	28.51	29.00	0.047

NOTE: Head SAR test results of GSM850.

Test Position of Body with 0mm	Test channel /Freq.	Test Mode	SAR Value (W/kg)		Power Drift (±5%)	Conducted power (dBm)	Tune-up power (dBm)	Scaled SAR 1g (W/Kg)
			1g	10g				
Front Side	251/848.8	GPRS(GMSK 4TS)	0.278	0.171	-0.58	28.51	29.00	<b>0.311</b>
Back Side	251/848.8	GPRS(GMSK 4TS)	0.082	0.056	-1.66	28.51	29.00	0.092
Right Side	251/848.8	GPRS(GMSK 4TS)	0.033	0.022	-2.07	28.51	29.00	0.037
Bottom Side	251/848.8	GPRS(GMSK 4TS)	0.098	0.056	-2.49	28.51	29.00	0.110

NOTE: Body SAR test results of GSM850

**10.1.2. SAR measurement Result of GSM1900**

Test Position of Head	Test channel /Freq.	Test Mode	SAR Value (W/kg)		Power Drift (±5%)	Conducted power (dBm)	Tune-up power (dBm)	Scaled SAR 1g (W/Kg)
			1g	10g				
Left Cheek	810/1909.8	GPRS(GMSK 4TS)	0.162	0.108	-0.78	25.60	26.00	<b>0.178</b>
Left Tilt 15 Degree	810/1909.8	GPRS(GMSK 4TS)	0.087	0.058	-4.32	25.60	26.00	0.095
Right Cheek	810/1909.8	GPRS(GMSK 4TS)	0.100	0.069	-1.09	25.60	26.00	0.110
Right Tilt 15 Degree	810/1909.8	GPRS(GMSK 4TS)	0.053	0.037	1.27	25.60	26.00	0.058

NOTE: Head SAR test results of GSM1900

Test Position of Body with 0mm	Test channel /Freq.	Test Mode	SAR Value (W/kg)		Power Drift (±5%)	Conducted power (dBm)	Tune-up power (dBm)	Scaled SAR 1g (W/Kg)
			1g	10g				
Front Side	810/1909.8	GPRS(GMSK 4TS)	0.598	0.331	-1.96	25.60	26.00	0.656
Back Side	810/1909.8	GPRS(GMSK 4TS)	0.240	0.133	-1.26	25.60	26.00	0.263
Right Side	810/1909.8	GPRS(GMSK 4TS)	0.040	0.028	-0.33	25.60	26.00	0.044
Bottom Side	810/1909.8	GPRS(GMSK 4TS)	0.643	0.305	0.57	25.60	26.00	<b>0.705</b>

NOTE: Body SAR test results of GSM1900

**10.1.3. SAR measurement Result of UMTS Band V**

Test Position of Head	Test channel /Freq.	Test Mode	SAR Value (W/kg)		Power Drift (±5%)	Conducted power (dBm)	Tune-up power (dBm)	Scaled SAR 1g (W/Kg)
			1g	10g				
Left Cheek	4182/836.4	RMC12.2K	0.054	0.045	-1.18	23.73	24.00	<b>0.057</b>
Left Tilt 15 Degree	4182/836.4	RMC12.2K	0.042	0.033	1.24	23.73	24.00	0.045
Right Cheek	4182/836.4	RMC12.2K	0.051	0.043	0.93	23.73	24.00	0.054
Right Tilt 15 Degree	4182/836.4	RMC12.2K	0.038	0.027	-0.32	23.73	24.00	0.040

NOTE: Head SAR test results of UMTS Band V

Test Position of Body with 0mm	Test channel /Freq.	Test Mode	SAR Value (W/kg)		Power Drift (±5%)	Conducted power (dBm)	Tune-up power (dBm)	Scaled SAR 1g (W/Kg)
			1g	10g				
Front Side	4182/836.4	RMC12.2K	0.258	0.162	0.05	23.73	24.00	<b>0.275</b>
Back Side	4182/836.4	RMC12.2K	0.072	0.052	1.44	23.73	24.00	0.077
Right Side	4182/836.4	RMC12.2K	0.042	0.035	1.27	23.73	24.00	0.045
Bottom Side	4182/836.4	RMC12.2K	0.082	0.065	-1.02	23.73	24.00	0.087

NOTE: Body SAR test results of UMTS Band V



**10.1.4. SAR measurement Result of UMTS Band II**

Test Position of Head	Test channel /Freq.	Test Mode	SAR Value (W/kg)		Power Drift (±5%)	Conducted power (dBm)	Tune-up power (dBm)	Scaled SAR 1g (W/Kg)
			1g	10g				
Left Cheek	9538/1907.6	RMC12.2K	0.217	0.153	-2.42	22.80	23.00	<b>0.227</b>
Left Tilt 15 Degree	9538/1907.6	RMC12.2K	0.106	0.068	1.21	22.80	23.00	0.111
Right Cheek	9538/1907.6	RMC12.2K	0.166	0.119	0.53	22.80	23.00	0.174
Right Tilt 15 Degree	9538/1907.6	RMC12.2K	0.089	0.057	-0.27	22.80	23.00	0.093

NOTE: Head SAR test results of UMTS Band II

Test Position of Body with 0mm	Test channel /Freq.	Test Mode	SAR Value (W/kg)		Power Drift (±5%)	Conducted power (dBm)	Tune-up power (dBm)	Scaled SAR 1g (W/Kg)
			1g	10g				
Front Side	9538/1907.6	RMC12.2K	0.862	0.487	-1.00	22.80	23.00	0.903
Back Side	9538/1907.6	RMC12.2K	0.440	0.242	-2.43	22.80	23.00	0.461
Right Side	9538/1907.6	RMC12.2K	0.050	0.039	-0.86	22.80	23.00	0.052
Bottom Side	9538/1907.6	RMC12.2K	0.925	0.480	2.96	22.80	23.00	0.969
Bottom Side-Repeated	9538/1907.6	RMC12.2K	0.911	0.473	-0.04	22.80	23.00	0.954
Front Side	9262/1852.4	RMC12.2K	0.847	0.466	-4.28	22.20	23.00	<b>1.018</b>
Front Side	9400/1880	RMC12.2K	0.879	0.482	-0.31	22.63	23.00	0.957
Bottom Side	9262/1852.4	RMC12.2K	0.838	0.435	-0.48	22.20	23.00	1.007
Bottom Side	9400/1880	RMC12.2K	0.775	0.395	-0.91	22.63	23.00	0.844

NOTE: Body SAR test results of UMTS Band II

**10.1.5. SAR measurement Result of WiFi 2.4G**

Test Position of Head	Test channel /Freq.	Test Mode	SAR Value (W/kg)		Power Drift (±5%)	Conducted power (dBm)	Tune-up power (dBm)	Scaled SAR 1g (W/Kg)
			1g	10g				
Left Cheek	11/2462	802.11b	0.160	0.099	-3.67	14.14	15.00	0.195
Left Tilt 15 Degree	11/2462	802.11b	0.087	0.049	-1.04	14.14	15.00	0.106
Right Cheek	11/2462	802.11b	0.288	0.154	-2.32	14.14	15.00	<b>0.351</b>
Right Tilt 15 Degree	11/2462	802.11b	0.193	0.114	-0.78	14.14	15.00	0.235

NOTE: Head SAR test results of WiFi 2.4G

Test Position of Body with 0mm	Test channel /Freq.	Test Mode	SAR Value (W/kg)		Power Drift (±5%)	Conducted power (dBm)	Tune-up power (dBm)	Scaled SAR 1g (W/Kg)
			1g	10g				
Front Side	11/2462	802.11b	0.395	0.193	-1.22	14.14	15.00	0.482
Back Side	11/2462	802.11b	0.637	0.316	-3.02	14.14	15.00	<b>0.776</b>
Left Side	11/2462	802.11b	0.183	0.107	1.27	14.14	15.00	0.223
Top Side	11/2462	802.11b	0.532	0.260	-0.30	14.14	15.00	0.649

NOTE: Body SAR test results of WiFi 2.4G

### 10.2. Simultaneous Transmission Possibilities

The Simultaneous Transmission Possibilities of this device are as below:

No.	Configuration	Head	Body	Hotspot	Note
1	GSM(Voice) + WiFi 2.4GHz(data)	Yes	Yes	N/A	VOIP
2	UMTS(Voice) + WiFi 2.4GHz(data)	Yes	Yes	N/A	VOIP
3	GSM(Voice) + BT(data)	Yes	Yes	N/A	VOIP
4	UMTS(Voice) + BT(data)	Yes	Yes	N/A	VOIP
5	GPRS/EDGE(data) + WiFi 2.4GHz(data)	Yes	Yes	Yes	2.4GHz Hotspot
6	UMTS(data) + WiFi 2.4GHz(data)	Yes	Yes	Yes	2.4GHz Hotspot
7	GPRS/EDGE(data) + BT(data)	Yes	Yes	Yes	BT Tethering
8	UMTS(data) + BT(data)	Yes	Yes	Yes	BT Tethering

NOTE:

- 1) This device supported VoIP in GPRS/EDGE and UMTS(e.g. 2rd party VoIP).
- 2) This device WiFi 2.4GHz supports Hotspot operation.
- 3) WiFi 2.4GHz and BT share the same antenna, and cannot transmit simultaneously.
- 4) EUT will choose each GSM, and UMTS according to the network signal condition; therefore, they will not operate simultaneously at any moment.
- 5) The Scaled SAR summation is calculated based on the same configuration and test position.

### 10.3. SAR Summation Scenario

Per KDB 447498 D01, simultaneous transmission SAR is compliant if,

- 1) Scalar SAR summation < 1.6W/kg.
- 2)  $SPLSR = (SAR_1 + SAR_2)^{1.5} / (\text{min. separation distance, mm})$ , and the peak separation distance is determined from the square root of  $[(x_1-x_2)^2 + (y_1-y_2)^2 + (z_1-z_2)^2]$ , where  $(x_1, y_1, z_1)$  and  $(x_2, y_2, z_2)$  are the coordinates of the extrapolated peak SAR locations in the zoom scan. If  $SPLSR \leq 0.04$ , simultaneously transmission SAR measurement is not necessary.

Test Position		Scaled SAR <sub>MAX</sub>		1-g SAR (W/Kg)	SPLSR	Remark
		GSM 850	WiFi 2.4G			
Head	Left Cheek	0.057	0.195	0.252	N/A	N/A
	Left Tilt 15 Degree	0.054	0.106	0.160	N/A	N/A
	Right Cheek	0.057	0.351	0.408	N/A	N/A
	Right Tilt 15 Degree	0.047	0.235	0.282	N/A	N/A
Body	Front Side	0.311	0.482	0.793	N/A	N/A
	Back Side	0.092	0.776	0.868	N/A	N/A
	Left Side	N/A	0.223	0.223	N/A	N/A
	Right Side	0.037	N/A	0.037	N/A	N/A
	Top Side	N/A	0.649	0.649	N/A	N/A
	Bottom Side	0.110	N/A	0.110	N/A	N/A

NOTE: 1-g SAR Simultaneous Tx Combination of GSM850 and WiFi 2.4G.

Test Position		Scaled SAR <sub>MAX</sub>		1-g SAR (W/Kg)	SPLSR	Remark
		GSM 1900	WiFi 2.4G			
Head	Left Cheek	0.178	0.195	0.373	N/A	N/A
	Left Tilt 15 Degree	0.095	0.106	0.201	N/A	N/A
	Right Cheek	0.110	0.351	0.461	N/A	N/A
	Right Tilt 15 Degree	0.058	0.235	0.293	N/A	N/A
Body	Front Side	0.656	0.482	1.137	N/A	N/A
	Back Side	0.263	0.776	1.040	N/A	N/A
	Left Side	N/A	0.223	0.223	N/A	N/A
	Right Side	0.044	N/A	0.044	N/A	N/A
	Top Side	N/A	0.649	0.649	N/A	N/A
	Bottom Side	0.705	N/A	0.705	N/A	N/A

NOTE: 1-g SAR Simultaneous Tx Combination of GSM1900 and WiFi 2.4G.

Test Position		Scaled SAR <sub>MAX</sub>		1-g SAR (W/Kg)	SPLSR	Remark
		UMTS Band V	WiFi 2.4G			
Head	Left Cheek	0.057	0.195	0.253	N/A	N/A
	Left Tilt 15 Degree	0.045	0.106	0.151	N/A	N/A
	Right Cheek	0.054	0.351	0.405	N/A	N/A
	Right Tilt 15 Degree	0.040	0.235	0.276	N/A	N/A
Body	Front Side	0.275	0.482	0.756	N/A	N/A
	Back Side	0.077	0.776	0.853	N/A	N/A
	Left Side	N/A	0.223	0.223	N/A	N/A
	Right Side	0.045	N/A	0.045	N/A	N/A
	Top Side	N/A	0.649	0.649	N/A	N/A
	Bottom Side	0.087	N/A	0.087	N/A	N/A

NOTE: 1-g SAR Simultaneous Tx Combination of UMTS Band V and WiFi 2.4G.

Test Position		Scaled SAR <sub>MAX</sub>		1-g SAR (W/Kg)	SPLSR	Remark
		UMTS Band II	WiFi 2.4G			
Head	Left Cheek	0.227	0.195	0.422	N/A	N/A
	Left Tilt 15 Degree	0.111	0.106	0.217	N/A	N/A
	Right Cheek	0.174	0.351	0.525	N/A	N/A
	Right Tilt 15 Degree	0.093	0.235	0.328	N/A	N/A
Body	Front Side	1.018	0.482	<b>1.500</b>	N/A	N/A
	Back Side	0.461	0.776	1.237	N/A	N/A
	Left Side	N/A	0.223	0.223	N/A	N/A
	Right Side	0.052	N/A	0.052	N/A	N/A
	Top Side	N/A	0.649	0.649	N/A	N/A
	Bottom Side	1.007	N/A	1.007	N/A	N/A

NOTE: 1-g SAR Simultaneous Tx Combination of UMTS Band II and WiFi 2.4G.

Test Position		Scaled SAR <sub>MAX</sub>		1-g SAR (W/Kg)	SPLSR	Remark
		GSM 850	BT			
Head	Left Cheek	0.057	0.084	0.141	N/A	N/A
	Left Tilt 15 Degree	0.054	0.084	0.138	N/A	N/A
	Right Cheek	0.057	0.084	0.141	N/A	N/A
	Right Tilt 15 Degree	0.047	0.084	0.131	N/A	N/A
Body	Front Side	0.311	0.084	0.395	N/A	N/A
	Back Side	0.092	0.084	0.176	N/A	N/A
	Left Side	N/A	0.084	0.084	N/A	N/A
	Right Side	0.037	N/A	0.037	N/A	N/A
	Top Side	N/A	0.084	0.084	N/A	N/A
	Bottom Side	0.110	N/A	0.110	N/A	N/A

NOTE: 1-g SAR Simultaneous Tx Combination of GSM850 and BT.

Test Position		Scaled SAR <sub>MAX</sub>		1-g SAR (W/Kg)	SPLSR	Remark
		GSM 1900	BT			
Head	Left Cheek	0.178	0.084	0.262	N/A	N/A
	Left Tilt 15 Degree	0.095	0.084	0.179	N/A	N/A
	Right Cheek	0.110	0.084	0.194	N/A	N/A
	Right Tilt 15 Degree	0.058	0.084	0.142	N/A	N/A
Body	Front Side	0.656	0.084	0.740	N/A	N/A
	Back Side	0.263	0.084	0.347	N/A	N/A
	Left Side	N/A	0.084	0.084	N/A	N/A
	Right Side	0.044	N/A	0.044	N/A	N/A
	Top Side	N/A	0.084	0.084	N/A	N/A
	Bottom Side	0.705	N/A	0.705	N/A	N/A

NOTE: 1-g SAR Simultaneous Tx Combination of GSM1900 and BT.

Test Position		Scaled SAR <sub>MAX</sub>		1-g SAR (W/Kg)	SPLSR	Remark
		UMTS Band V	BT			
Head	Left Cheek	0.057	0.084	0.141	N/A	N/A
	Left Tilt 15 Degree	0.045	0.084	0.129	N/A	N/A
	Right Cheek	0.054	0.084	0.138	N/A	N/A
	Right Tilt 15 Degree	0.040	0.084	0.124	N/A	N/A
Body	Front Side	0.275	0.084	0.359	N/A	N/A
	Back Side	0.077	0.084	0.161	N/A	N/A
	Left Side	N/A	0.084	0.084	N/A	N/A
	Right Side	0.045	N/A	0.045	N/A	N/A
	Top Side	N/A	0.084	0.084	N/A	N/A
	Bottom Side	0.087	N/A	0.087	N/A	N/A

NOTE: 1-g SAR Simultaneous Tx Combination of UMTS Band V and BT.

Test Position		Scaled SAR <sub>MAX</sub>		1-g SAR (W/Kg)	SPLSR	Remark
		UMTS Band II	BT			
Head	Left Cheek	0.227	0.084	0.311	N/A	N/A
	Left Tilt 15 Degree	0.111	0.084	0.195	N/A	N/A
	Right Cheek	0.174	0.084	0.258	N/A	N/A
	Right Tilt 15 Degree	0.093	0.084	0.177	N/A	N/A
Body	Front Side	1.018	0.084	1.102	N/A	N/A
	Back Side	0.461	0.084	0.545	N/A	N/A
	Left Side	N/A	0.084	0.084	N/A	N/A
	Right Side	0.052	N/A	0.052	N/A	N/A
	Top Side	N/A	0.084	0.084	N/A	N/A
	Bottom Side	1.007	N/A	1.007	N/A	N/A

NOTE: 1-g SAR Simultaneous Tx Combination of UMTS Band II and BT.

## 11. Appendix A. Photo documentation

<b>Table of contents</b>
<b>Test Facility</b>
<b>Product Photo</b>
<b>Test Positions</b>
<b>Liquid depth</b>



**Test Facility**

Measurement System SATIMO



**Product Photo**

Front View

Back View



Reference Line

N/A

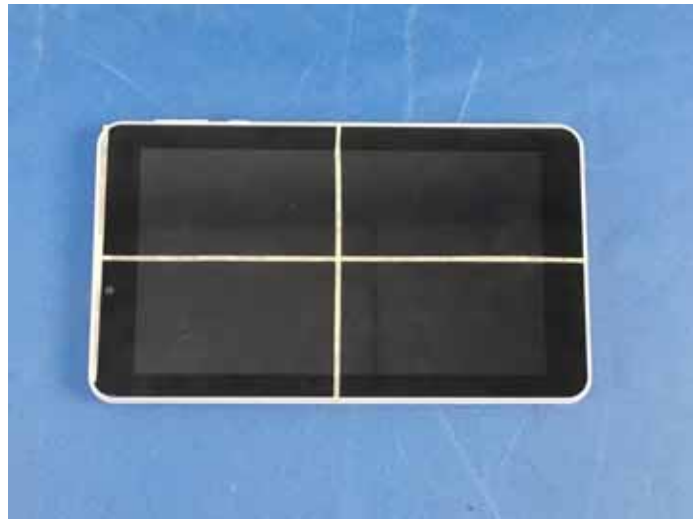

N/A

### Test Positions

Left Cheek



Left Tilt 15 Degree



Right Cheek



Right Tilt 15 Degree



Front Side (0mm)



Back Side (0mm)

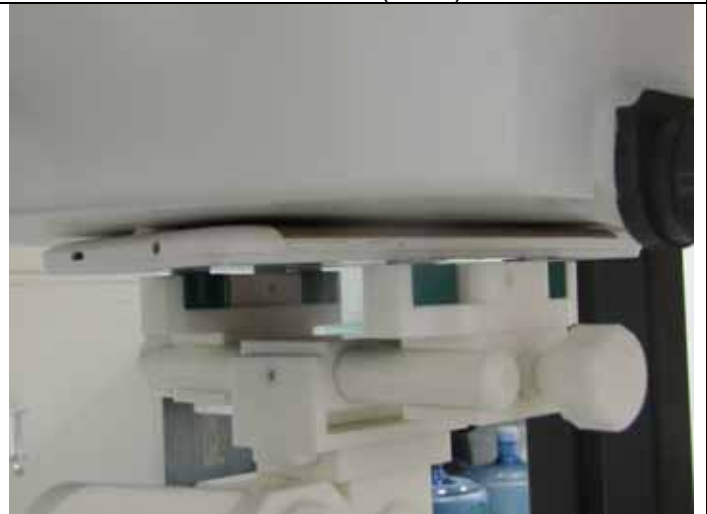

Right Side (0mm)



Left Side (0mm)



Top Side (0mm)



Bottom Side (0mm)



**Liquid depth**

Head 850MHz depth (15.3cm)

Body 850MHz depth (15.2cm)



Head 1900MHz depth (15.2cm)

Body 1900MHz depth (15.3cm)



Head 2450MHz depth (15.1cm)

Body 2450MHz depth (15.1cm)



## 12. Appendix B. System Check Plots

<b>Table of contents</b>
<b>System Performance Check - SID835 - Head</b>
<b>System Performance Check - SID835 - Body</b>
<b>System Performance Check - SID1900 - Head</b>
<b>System Performance Check - SID1900 - Body</b>
<b>System Performance Check - SID2450 - Head</b>
<b>System Performance Check - SID2450 - Body</b>

### System Performance Check - SID835-Head

Date of measurement:	May 06, 2016
Signal:	Communication System: CW; Frequency: 835.00MHz; Duty Cycle: 1:1.00
ConvF:	1.89
Liquid Parameters:	Relative permittivity (real part): 41.99; Conductivity (S/m): 0.88;
Device Position:	Dipole
Area Scan:	dx=15mm dy=15mm, h=5.00mm
Zoom Scan:	5x5x7, dx=8mm dy=8mm dz=5mm, h=5.00mm

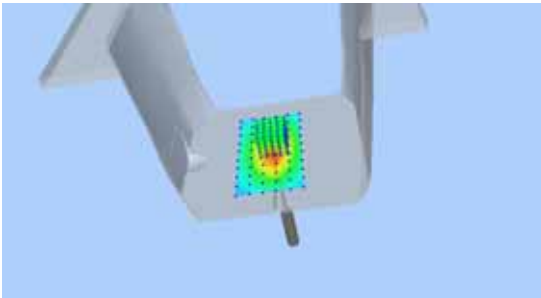
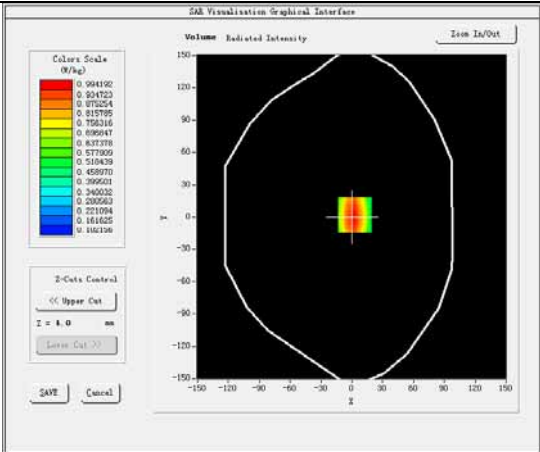
3D screen shot	Volume SAR
	

Maximum location: X=3.00, Y=2.00  
SAR Peak: 1.36 W/kg

SAR 1g (W/Kg)	0.955						
SAR 10g (W/Kg)	0.622						
Power Drift (±5%):	-0.13						
Z (mm)	0.00	4.00	9.00	14.00	19.00	24.00	29.00
SAR (W/Kg)	1.3518	0.9942	0.6824	0.4794	0.3429	0.2508	0.1847

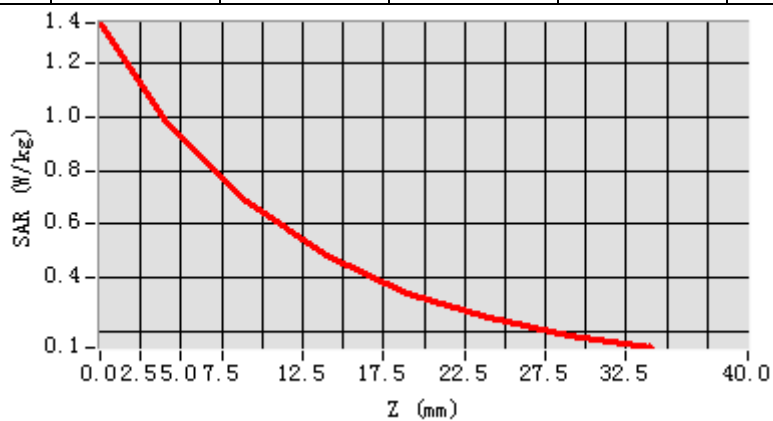



### System Performance Check - SID835-Body

Date of measurement:	May 06, 2016
Signal:	Communication System: CW; Frequency: 835.00MHz; Duty Cycle: 1:1.00
ConvF:	1.94
Liquid Parameters:	Relative permittivity (real part): 55.19; Conductivity (S/m): 0.99;
Device Position:	Dipole
Area Scan:	dx=15mm dy=15mm, h=5.00mm
Zoom Scan:	5x5x7, dx=8mm dy=8mm dz=5mm, h=5.00mm

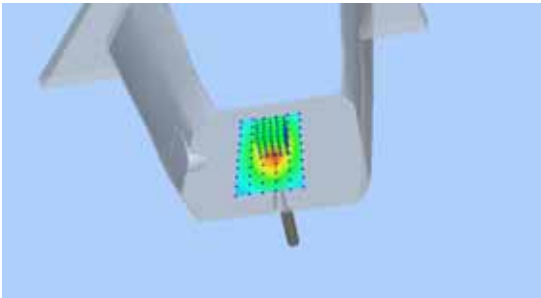
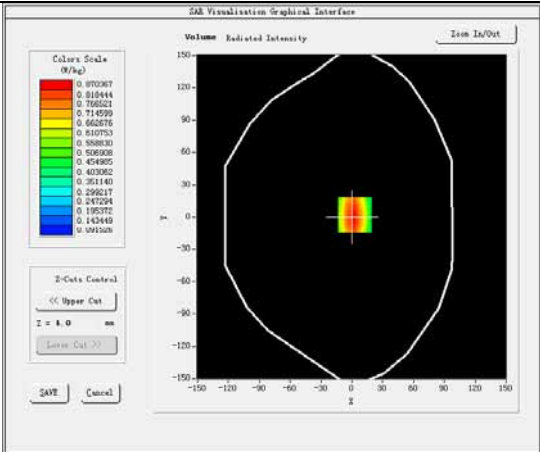
3D screen shot	Volume SAR
	

Maximum location: X=3.00, Y=2.00  
SAR Peak: 1.18 W/kg

SAR 1g (W/Kg)		0.895					
SAR 10g (W/Kg)		0.588					
Power Drift (±5%):		-0.47					
Z (mm)	0.00	4.00	9.00	14.00	19.00	24.00	29.00
SAR (W/Kg)	1.1808	0.8704	0.5986	0.4207	0.3022	0.2215	0.1642

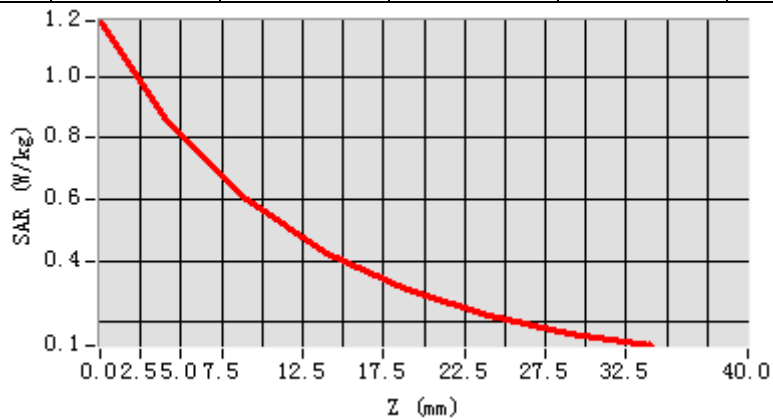



### System Performance Check - SID1900-Head

Date of measurement:	May 07, 2016
Signal:	Communication System: CW; Frequency: 1900.00MHz; Duty Cycle: 1:1.00
ConvF:	2.16
Liquid Parameters:	Relative permittivity (real part): 39.10; Conductivity (S/m): 1.44;
Device Position:	Dipole
Area Scan:	dx=15mm dy=15mm, h=5.00mm
Zoom Scan:	5x5x7, dx=8mm dy=8mm dz=5mm, h=5.00mm

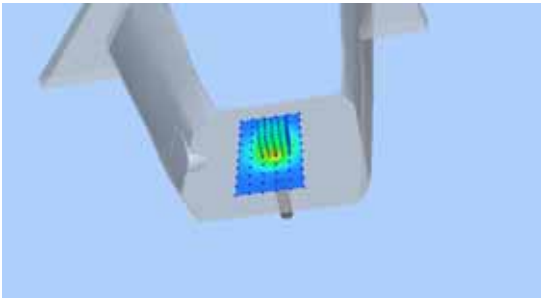
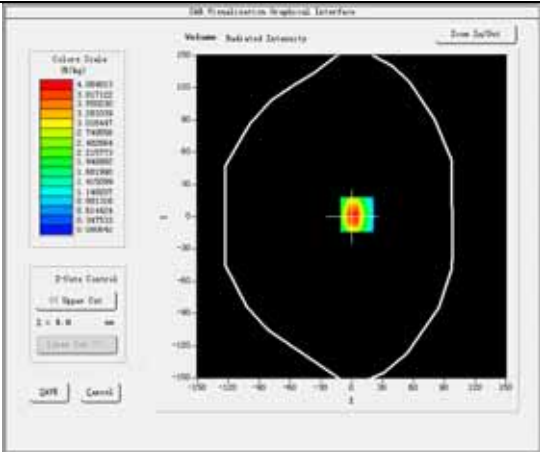
3D screen shot	Volume SAR
	

Maximum location: X=5.00, Y=2.00  
SAR Peak: 6.76 W/kg

SAR 1g (W/Kg)		4.105					
SAR 10g (W/Kg)		2.072					
Power Drift (±5%):		0.09					
Z (mm)	0.00	4.00	9.00	14.00	19.00	24.00	29.00
SAR (W/Kg)	6.3784	4.0840	2.2879	1.3258	0.7722	0.4614	0.2808

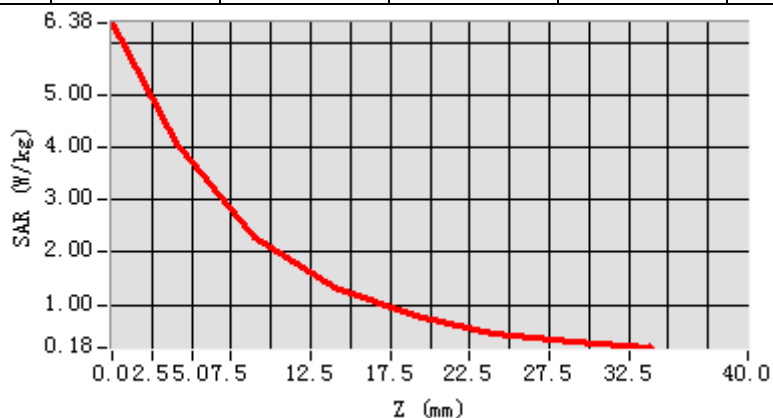

### System Performance Check - SID1900-Body

Date of measurement:	May 07, 2016
Signal:	Communication System: CW; Frequency: 1900.00MHz; Duty Cycle: 1:1.00
ConvF:	2.24
Liquid Parameters:	Relative permittivity (real part): 53.36; Conductivity (S/m): 1.54;
Device Position:	Dipole
Area Scan:	dx=15mm dy=15mm, h=5.00mm
Zoom Scan:	5x5x7, dx=8mm dy=8mm dz=5mm, h=5.00mm

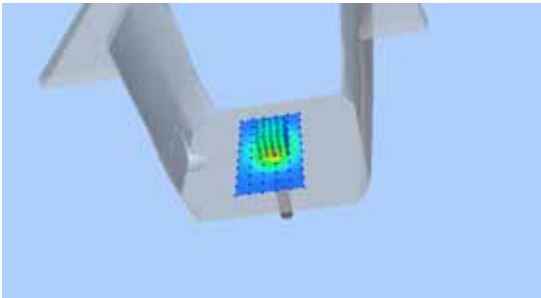
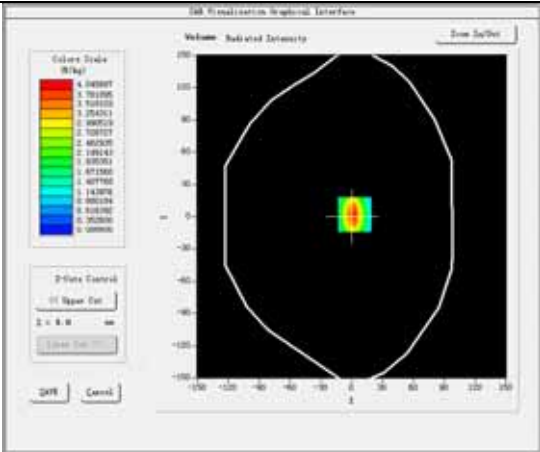
3D screen shot	Volume SAR
	

Maximum location: X=3.00, Y=2.00  
SAR Peak: 6.40 W/kg

SAR 1g (W/Kg)		3.896					
SAR 10g (W/Kg)		1.995					
Power Drift (±5%):		-0.51					
Z (mm)	0.00	4.00	9.00	14.00	19.00	24.00	29.00
SAR (W/Kg)	6.3747	4.0457	2.2409	1.2971	0.7555	0.4530	0.2784

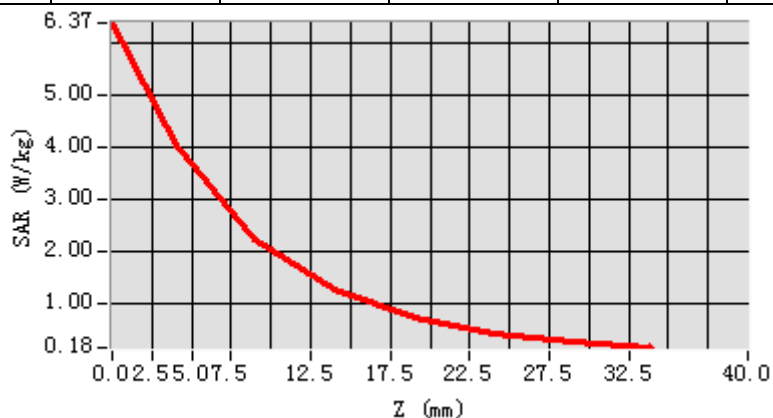

### System Performance Check - SID2450-Head

Date of measurement:	May 09, 2016
Signal:	Communication System: CW; Frequency: 2450.00MHz; Duty Cycle: 1:1.00
ConvF:	2.11
Liquid Parameters:	Relative permittivity (real part): 39.95; Conductivity (S/m): 1.83;
Device Position:	Dipole
Area Scan:	dx=12mm dy=12mm, h=5.00mm
Zoom Scan:	7x7x7, dx=5mm dy=5mm dz=5mm, h=5.00mm

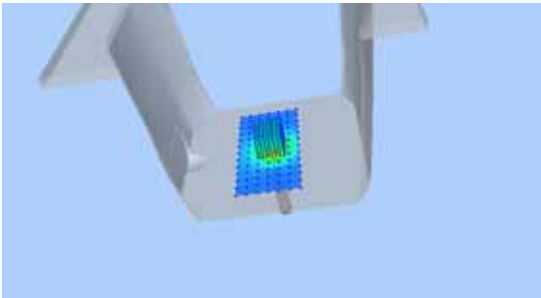
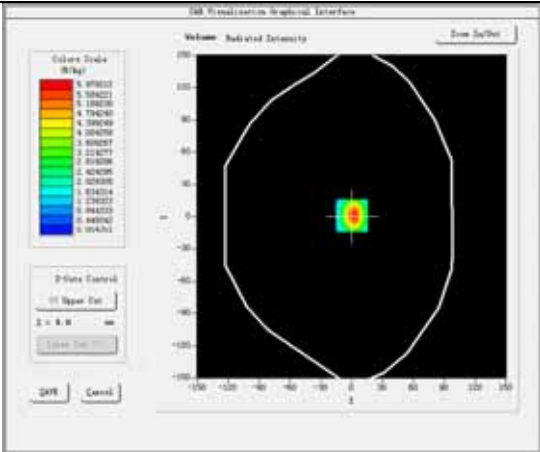
3D screen shot	Volume SAR
	

Maximum location: X=0.00, Y=1.00  
SAR Peak: 10.61 W/kg

SAR 1g (W/Kg)	5.520
SAR 10g (W/Kg)	2.465
Power Drift (±5%):	0.19
Z (mm)	0.00    4.00    9.00    14.00    19.00    24.00    29.00
SAR (W/Kg)	10.5687    5.9792    2.7157    1.2576    0.6074    0.3008    0.1590

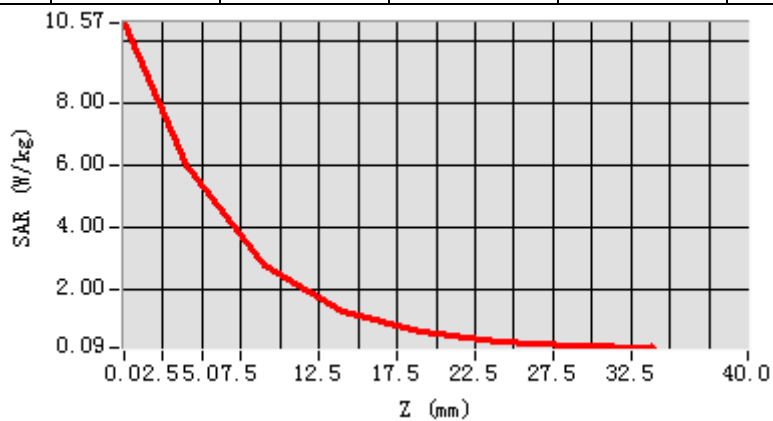

### System Performance Check - SID2450-Body

Date of measurement:	May 10, 2016
Signal:	Communication System: CW; Frequency: 2450.00MHz; Duty Cycle: 1:1.00
ConvF:	2.17
Liquid Parameters:	Relative permittivity (real part): 51.32; Conductivity (S/m): 1.93;
Device Position:	Dipole
Area Scan:	dx=12mm dy=12mm, h=5.00mm
Zoom Scan:	7x7x7, dx=5mm dy=5mm dz=5mm, h=5.00mm

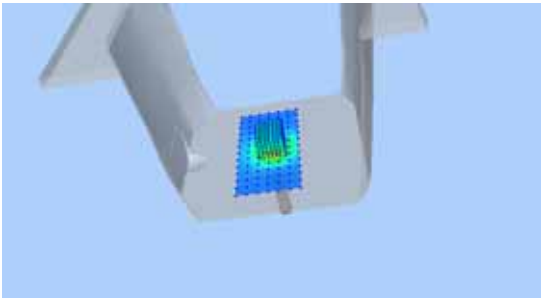
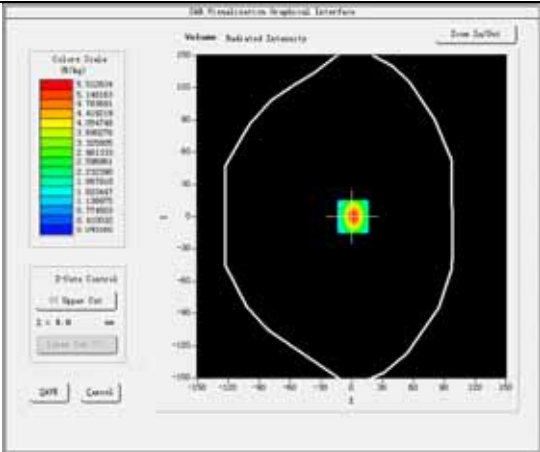
3D screen shot	Volume SAR
	

Maximum location: X=1.00, Y=0.00  
SAR Peak: 9.64 W/kg

SAR 1g (W/Kg)	5.102
SAR 10g (W/Kg)	2.357
Power Drift (±5%):	-0.16
Z (mm)	0.00    4.00    9.00    14.00    19.00    24.00    29.00
SAR (W/Kg)	9.7253    5.5138    2.5204    1.1572    0.5624    0.2788    0.1495

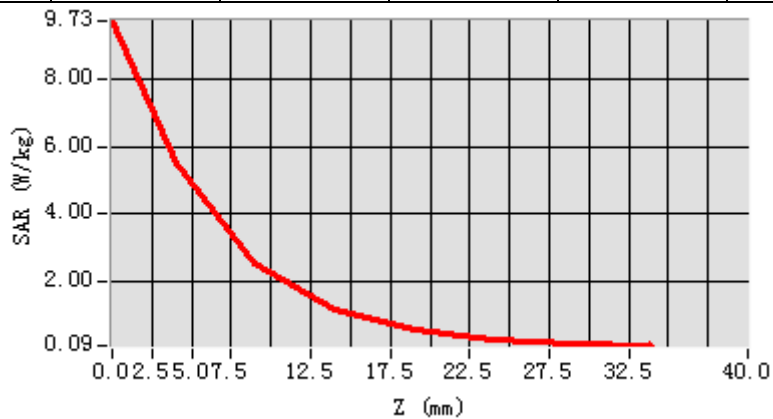

### 13. Appendix C. SAR Measurement Plots

<b>Table of contents</b>
<b>GSM 850 Head</b>
<b>GSM 850 Body</b>
<b>GSM 1900 Head</b>
<b>GSM 1900 Body</b>
<b>UMTS Band V Head</b>
<b>UMTS Band V Body</b>
<b>UMTS Band II Head</b>
<b>UMTS Band II Body</b>
<b>WiFi 2.4G Head</b>
<b>WiFi 2.4G Body</b>

**GSM850\_GPRS(GMSK 4TS)\_Ch251\_Right Cheek**

Date of measurement:	May 06, 2016
Signal:	Communication System: GPRS(GMSK 4TS); Frequency: 848.80MHz; Duty Cycle: 1:2.08
ConvF:	1.89
Liquid Parameters:	Relative permittivity (real part): 41.77; Conductivity (S/m): 0.90;
Device Position:	Cheek
Area Scan:	dx=15mm dy=15mm, h=5.00mm
Zoom Scan:	5x5x7, dx=8mm dy=8mm dz=5mm, h=5.00mm

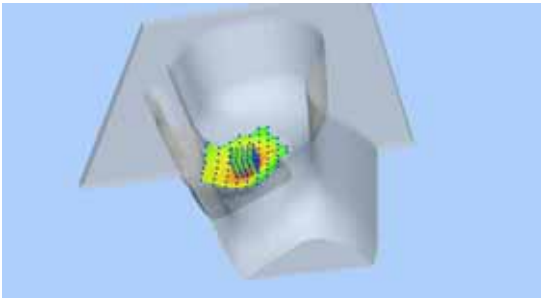
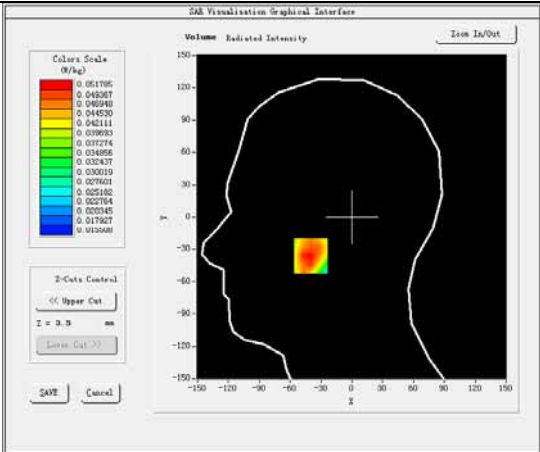
3D screen shot	Volume SAR
	

Maximum location: X=-36.00, Y=-36.00  
SAR Peak: 0.06 W/kg

SAR 1g (W/Kg)		0.051					
SAR 10g (W/Kg)		0.041					
Power Drift (±5%):		-2.49					
Z (mm)	0.00	4.00	9.00	14.00	19.00	24.00	29.00
SAR (W/Kg)	0.0584	0.0518	0.0451	0.0388	0.0340	0.0304	0.0266

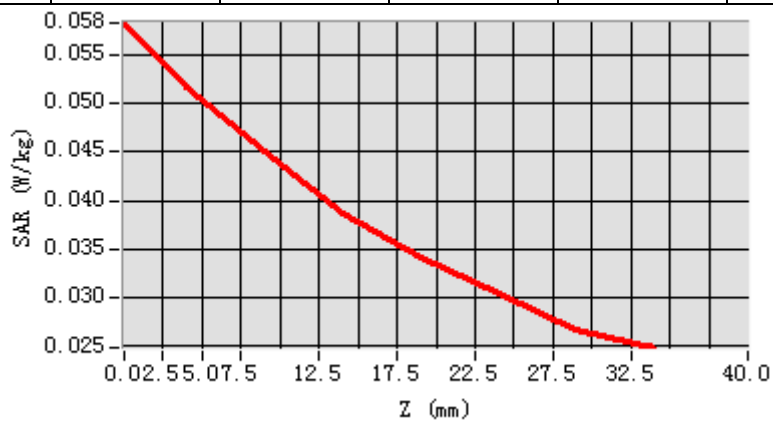

**GSM850\_GPRS(GMSK 4TS)\_Ch251\_Front Side\_0mm**

Date of measurement:	May 06, 2016
Signal:	Communication System: GPRS(GMSK 4TS); Frequency: 848.80MHz; Duty Cycle: 1:2.08
ConvF:	1.94
Liquid Parameters:	Relative permittivity (real part): 55.02; Conductivity (S/m): 1.00;
Device Position:	Body
Area Scan:	dx=15mm dy=15mm, h=5.00mm
Zoom Scan:	5x5x7, dx=8mm dy=8mm dz=5mm, h=5.00mm

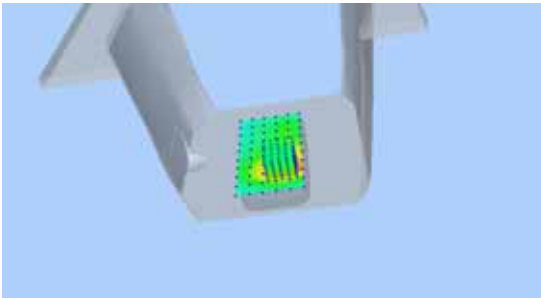
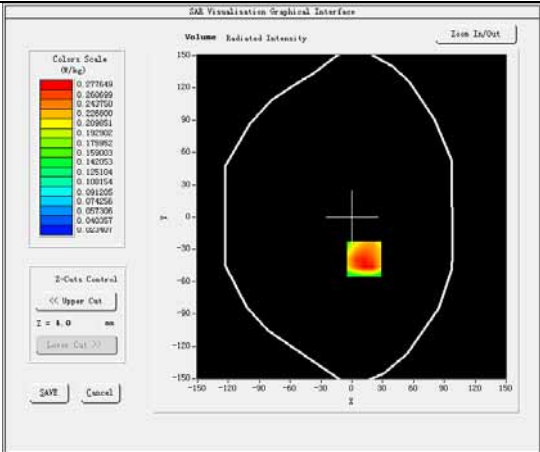
3D screen shot	Volume SAR
	

Maximum location: X=12.00, Y=-39.00  
SAR Peak: 0.45 W/kg

SAR 1g (W/Kg)		0.278					
SAR 10g (W/Kg)		0.171					
Power Drift (±5%):		-0.58					
Z (mm)	0.00	4.00	9.00	14.00	19.00	24.00	29.00
SAR (W/Kg)	0.4047	0.2776	0.1802	0.10789	0.0656	0.0478	0.0201

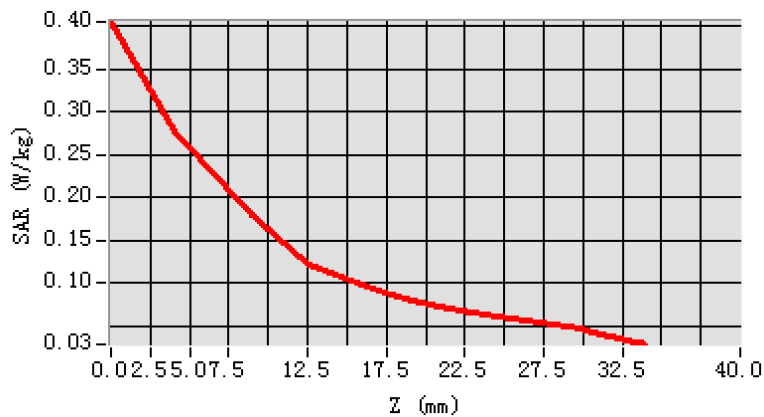

**GSM1900\_GPRS(GMSK 4TS)\_Ch810\_Left Cheek**

Date of measurement:	May 07, 2016
Signal:	Communication System: GPRS(GMSK 4TS); Frequency: 1909.80MHz; Duty Cycle: 1:2.08
ConvF:	2.16
Liquid Parameters:	Relative permittivity (real part): 39.01; Conductivity (S/m): 1.44;
Device Position:	Cheek
Area Scan:	dx=15mm dy=15mm, h=5.00mm
Zoom Scan:	5x5x7, dx=8mm dy=8mm dz=5mm, h=5.00mm

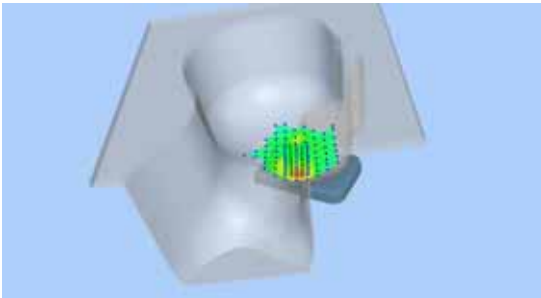
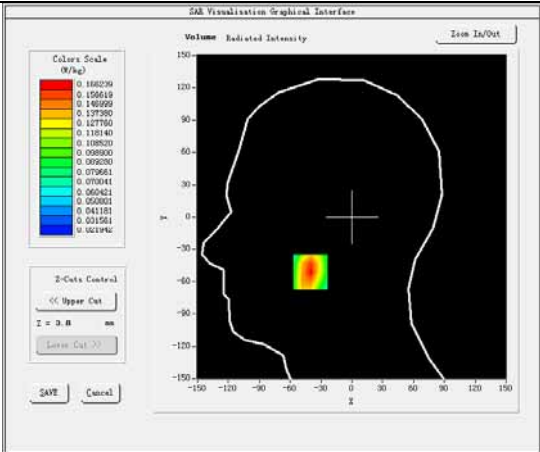
3D screen shot	Volume SAR
	

Maximum location: X=-36.00, Y=-51.00  
SAR Peak: 0.22 W/kg

SAR 1g (W/Kg)		0.162					
SAR 10g (W/Kg)		0.108					
Power Drift (±5%):		-0.78					
Z (mm)	0.00	4.00	9.00	14.00	19.00	24.00	29.00
SAR (W/Kg)	0.2198	0.1662	0.1222	0.0970	0.0768	0.0596	0.0485

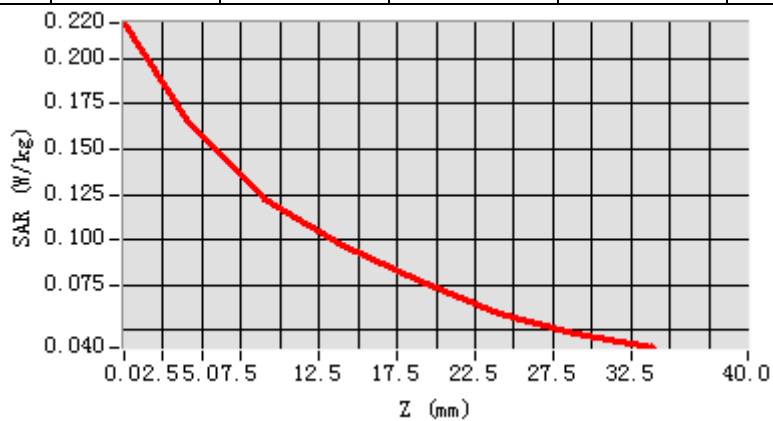



**GSM1900\_GPRS(GMSK 4TS)\_Ch810\_Bottom Side\_0mm**

Date of measurement:	May 07, 2016
Signal:	Communication System: GPRS(GMSK 4TS); Frequency: 1909.80MHz; Duty Cycle: 1:2.08
ConvF:	2.24
Liquid Parameters:	Relative permittivity (real part): 53.34; Conductivity (S/m): 1.55;
Device Position:	Body
Area Scan:	dx=15mm dy=15mm, h=5.00mm
Zoom Scan:	5x5x7, dx=8mm dy=8mm dz=5mm, h=5.00mm

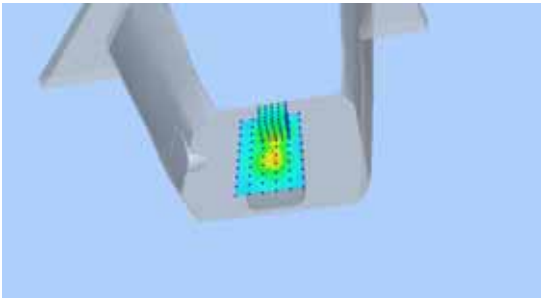
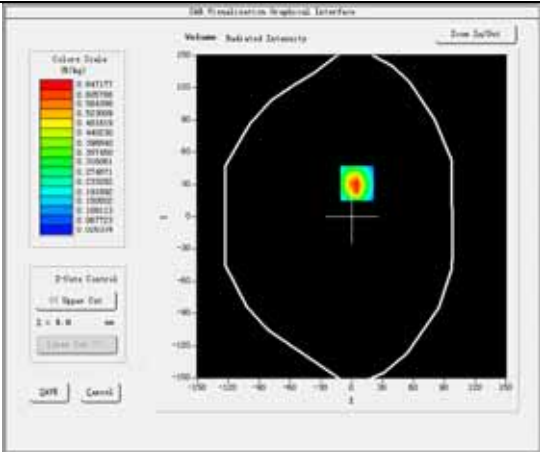
3D screen shot	Volume SAR
	

Maximum location: X=5.00, Y=31.00  
SAR Peak: 1.13 W/kg

SAR 1g (W/Kg)		0.643					
SAR 10g (W/Kg)		0.305					
Power Drift (±5%):		0.57					
Z (mm)	0.00	4.00	9.00	14.00	19.00	24.00	29.00
SAR (W/Kg)	1.0931	0.6472	0.3346	0.2107	0.1344	0.0883	0.0615

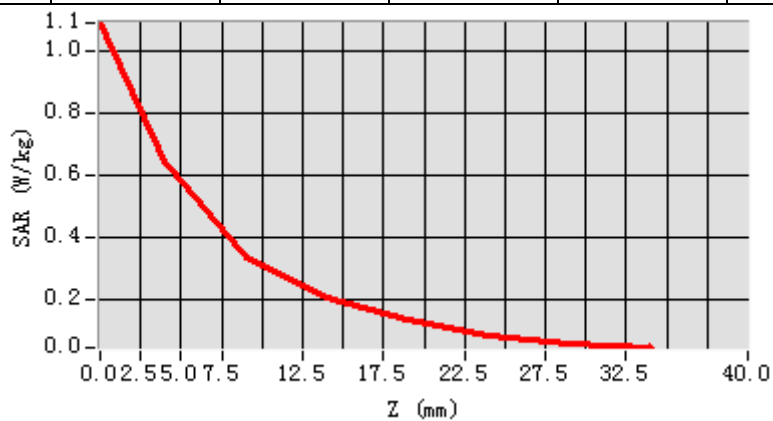

**UMTS Band V\_RMC 12.2Kbps\_Ch4182\_Left Cheek**

Date of measurement:	May 06, 2016
Signal:	Communication System: UMTS-FDD(WCDMA); Frequency: 836.4MHz; Duty Cycle: 1:1.00
ConvF:	1.89
Liquid Parameters:	Relative permittivity (real part): 41.96; Conductivity (S/m): 0.88;
Device Position:	Cheek
Area Scan:	dx=15mm dy=15mm, h=5.00mm
Zoom Scan:	5x5x7, dx=8mm dy=8mm dz=5mm, h=5.00mm

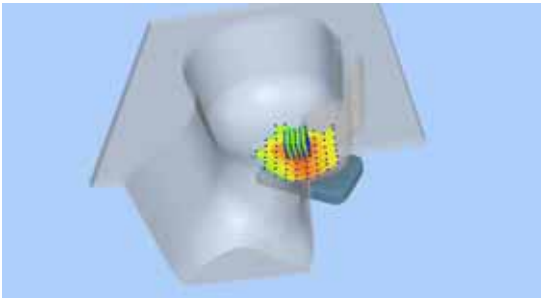
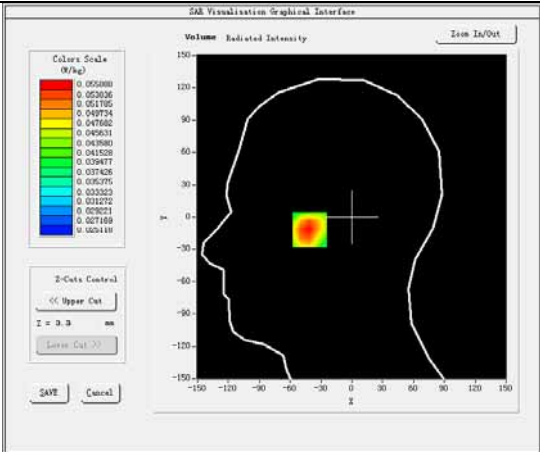
3D screen shot	Volume SAR
	

Maximum location: X=-41.00, Y=-10.00  
SAR Peak: 0.06 W/kg

SAR 1g (W/Kg)		0.054					
SAR 10g (W/Kg)		0.045					
Power Drift (±5%):		-1.18					
Z (mm)	0.00	4.00	9.00	14.00	19.00	24.00	29.00
SAR (W/Kg)	0.0636	0.0559	0.0478	0.0425	0.0368	0.0331	0.0308

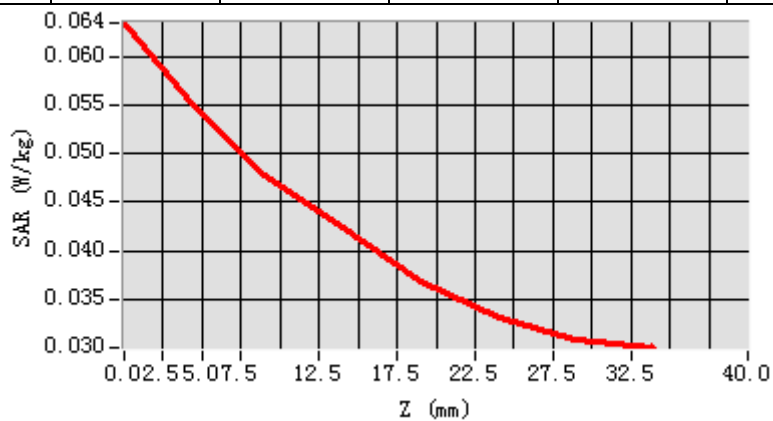

**UMTS Band V\_RMC 12.2Kbps\_Ch4182\_Front Side\_0mm**

Date of measurement:	May 06, 2016
Signal:	Communication System: UMTS-FDD(WCDMA); Frequency: 836.40MHz; Duty Cycle: 1:1.00
ConvF:	1.94
Liquid Parameters:	Relative permittivity (real part): 55.15; Conductivity (S/m): 0.99;
Device Position:	Body
Area Scan:	dx=15mm dy=15mm, h=5.00mm
Zoom Scan:	5x5x7, dx=8mm dy=8mm dz=5mm, h=5.00mm

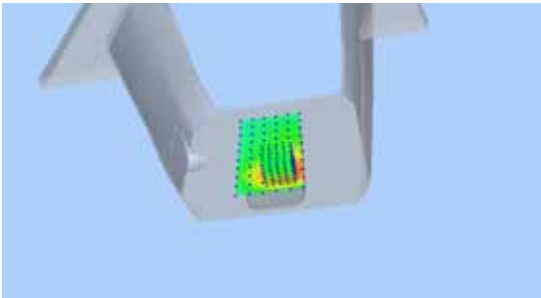
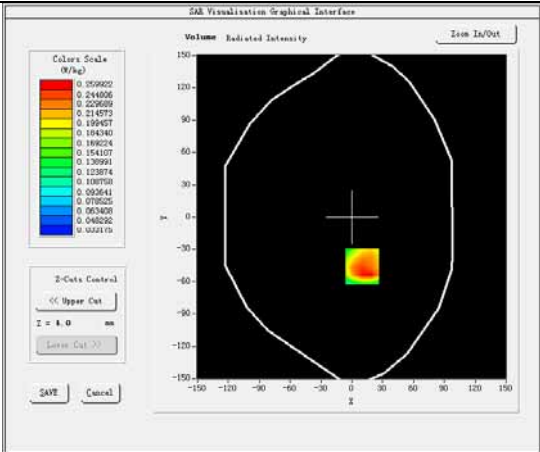
3D screen shot	Volume SAR
	

Maximum location: X=10.00, Y=-46.00  
SAR Peak: 0.43 W/kg

SAR 1g (W/Kg)		0.258					
SAR 10g (W/Kg)		0.162					
Power Drift (±5%):		0.05					
Z (mm)	0.00	4.00	9.00	14.00	19.00	24.00	29.00
SAR (W/Kg)	0.4259	0.2599	0.1466	0.0967	0.0808	0.0547	0.0508

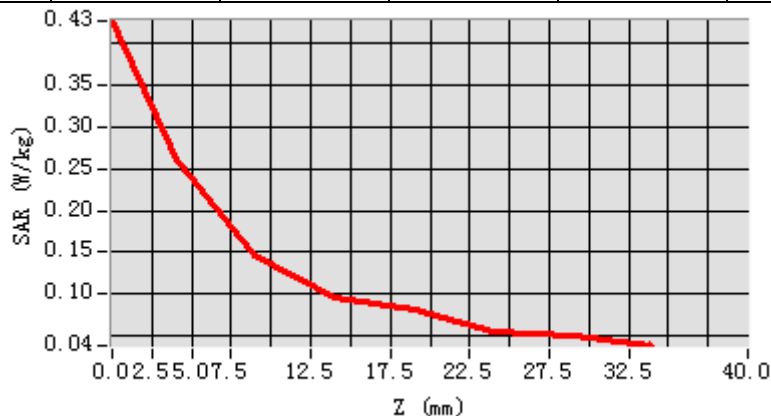

**UMTS Band II\_RMC 12.2Kbps\_Ch9538\_Left Cheek**

Date of measurement:	May 07, 2016
Signal:	Communication System: UMTS-FDD(WCDMA); Frequency: 1907.60MHz; Duty Cycle: 1:1.00
ConvF:	2.16
Liquid Parameters:	Relative permittivity (real part): 39.03; Conductivity (S/m): 1.44;
Device Position:	Cheek
Area Scan:	dx=15mm dy=15mm, h=5.00mm
Zoom Scan:	5x5x7, dx=8mm dy=8mm dz=5mm, h=5.00mm

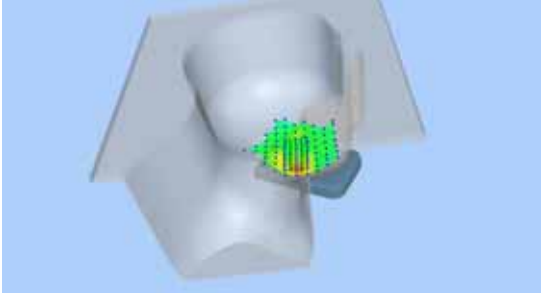
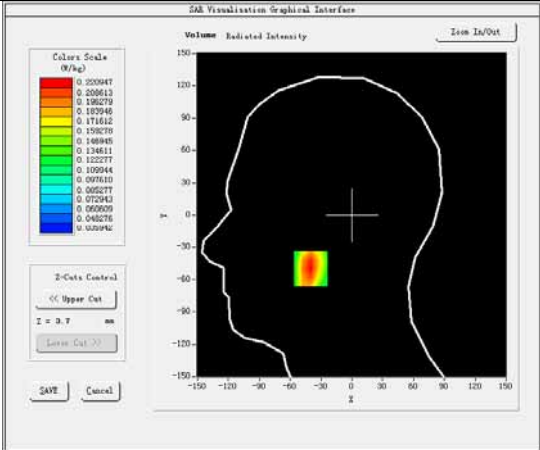
3D screen shot	Volume SAR
	

Maximum location: X=-35.00, Y=-50.00  
SAR Peak: 0.27 W/kg

SAR 1g (W/Kg)		0.217					
SAR 10g (W/Kg)		0.153					
Power Drift (±5%):		-2.42					
Z (mm)	0.00	4.00	9.00	14.00	19.00	24.00	29.00
SAR (W/Kg)	0.2680	0.2209	0.1749	0.1439	0.1161	0.0953	0.0801

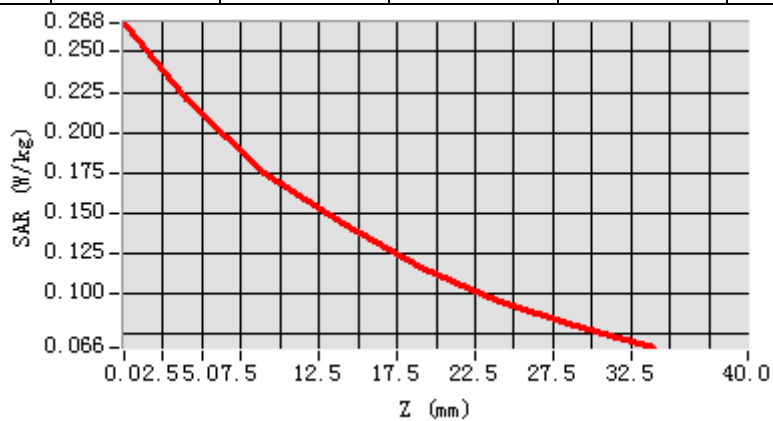

**UMTS Band II\_RMC 12.2Kbps\_Ch9538\_Bottom Side\_0mm**

Date of measurement:	May 07, 2016
Signal:	Communication System: UMTS-FDD(WCDMA); Frequency: 1907.60MHz; Duty Cycle: 1:1.00
ConvF:	2.24
Liquid Parameters:	Relative permittivity (real part): 53.35; Conductivity (S/m): 1.55;
Device Position:	Body
Area Scan:	dx=15mm dy=15mm, h=5.00mm
Zoom Scan:	5x5x7, dx=8mm dy=8mm dz=5mm, h=5.00mm

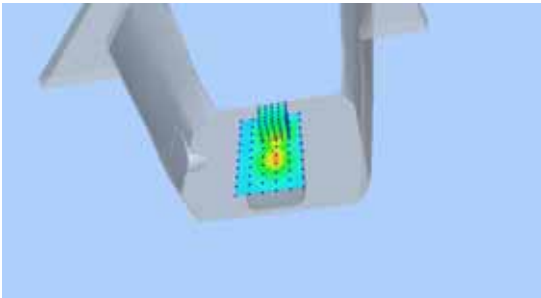
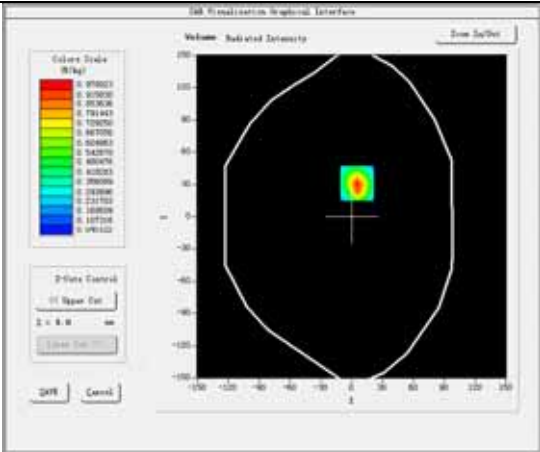
3D screen shot	Volume SAR
	

Maximum location: X=5.00, Y=31.00  
SAR Peak: 1.51 W/kg

SAR 1g (W/Kg)		0.925					
SAR 10g (W/Kg)		0.480					
Power Drift (±5%):		2.96					
Z (mm)	0.00	4.00	9.00	14.00	19.00	24.00	29.00
SAR (W/Kg)	1.5072	0.9780	0.5712	0.3650	0.2374	0.1591	0.1121

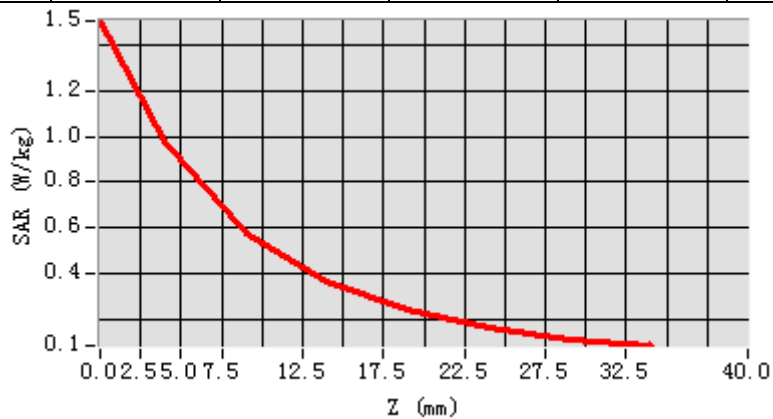

**WiFi 2.4G\_802.11b\_Ch11\_Right Cheek**

Date of measurement:	May 09, 2016
Signal:	Communication System: WiFi 802.11a/b/g/n/ac; Frequency: 2462.00MHz; Duty Cycle: 1:1.00
ConvF:	2.11
Liquid Parameters:	Relative permittivity (real part): 39.87; Conductivity (S/m): 1.84;
Device Position:	Cheek
Area Scan:	dx=12mm dy=12mm, h=5.00mm
Zoom Scan:	7x7x7, dx=5mm dy=5mm dz=5mm, h=5.00mm

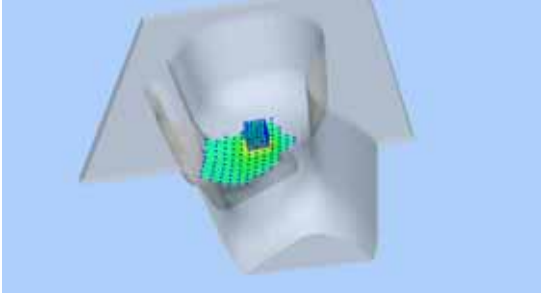
3D screen shot	Volume SAR
	

Maximum location: X=-21.00, Y=12.00  
SAR Peak: 0.49 W/kg

SAR 1g (W/Kg)		0.288					
SAR 10g (W/Kg)		0.154					
Power Drift (±5%):		-2.32					
Z (mm)	0.00	4.00	9.00	14.00	19.00	24.00	29.00
SAR (W/Kg)	0.5323	0.3147	0.1608	0.1124	0.0703	0.0562	0.0461

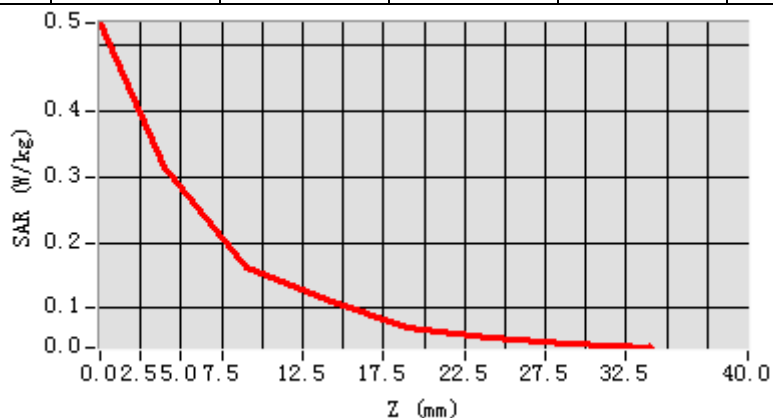

**WiFi 2.4G\_802.11b\_Ch11\_Back Side\_0mm**

Date of measurement:	May 10, 2016
Signal:	Communication System: WiFi 802.11a/b/g/n/ac; Frequency: 2462.00MHz; Duty Cycle: 1:1.00
ConvF:	2.17
Liquid Parameters:	Relative permittivity (real part): 51.25; Conductivity (S/m): 1.95;
Device Position:	Body
Area Scan:	dx=12mm dy=12mm, h=5.00mm
Zoom Scan:	7x7x7, dx=5mm dy=5mm dz=5mm, h=5.00mm

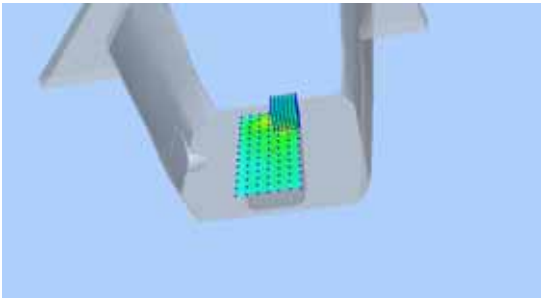
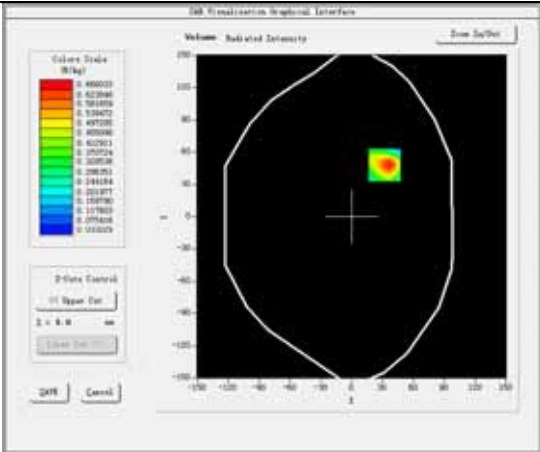
3D screen shot	Volume SAR
	

Maximum location: X=32.00, Y=48.00  
SAR Peak: 1.15 W/kg

SAR 1g (W/Kg)		0.637					
SAR 10g (W/Kg)		0.316					
Power Drift (±5%):		-3.02					
Z (mm)	0.00	4.00	9.00	14.00	19.00	24.00	29.00
SAR (W/Kg)	1.1776	0.6660	0.3139	0.1683	0.1083	0.0632	0.0522

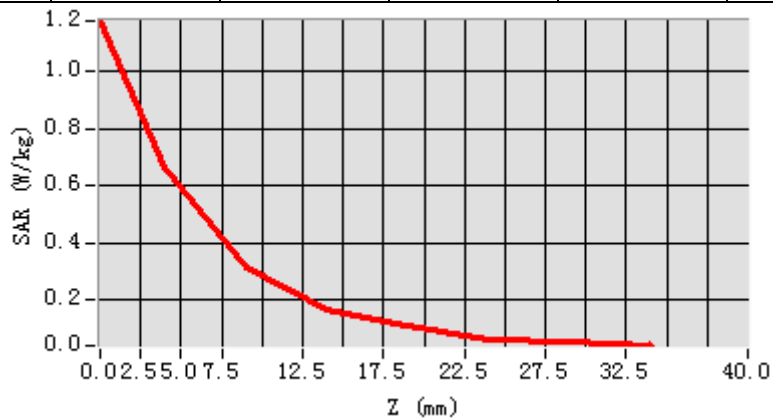

## 14. Appendix D. Calibration Certificate

<b>Table of contents</b>
E Field Probe - SN 34/15 EPGO267
835 MHz Dipole - SN 03/15 DIP 0G835-347
1900 MHz Dipole - SN 03/15 DIP 1G900-350
2450 MHz Dipole - SN 03/15 DIP 2G450-352
Extended Calibration Certificate





## COMOSAR E-Field Probe Calibration Report

Ref : ACR.261.1.15.SATU.A

**NTEK TESTING TECHNOLOGY CO., LTD.**  
**BUILDING E, FENDA SCIENCE PARK, SANWEI**  
**COMMUNITY, XIXIANG STREET,**  
**BAO'AN DISTRICT, SHENZHEN GUANGDONG, CHINA**  
**MVG COMOSAR DOSIMETRIC E-FIELD PROBE**  
**SERIAL NO.: SN 34/15 EPGO267**

**Calibrated at MVG US**  
**2105 Barrett Park Dr. - Kennesaw, GA 30144**



**Calibration Date: 08/24/2015**

*Summary:*

This document presents the method and results from an accredited COMOSAR Dosimetric E-Field Probe calibration performed in MVG USA using the CALISAR / CALIBAIR test bench, for use with a COMOSAR system only. All calibration results are traceable to national metrology institutions.



COMOSAR E-FIELD PROBE CALIBRATION REPORT

Ref: ACR.261.I.15.SATU-A

	<i>Name</i>	<i>Function</i>	<i>Date</i>	<i>Signature</i>
<i>Prepared by :</i>	Jérôme LUC	Product Manager	9/18/2015	<i>JS</i>
<i>Checked by :</i>	Jérôme LUC	Product Manager	9/18/2015	<i>JS</i>
<i>Approved by :</i>	Kim RUTKOWSKI	Quality Manager	9/18/2015	<i>Kim Rutkowski</i>

	<i>Customer Name</i>
<i>Distribution :</i>	NTEK TESTING TECHNOLOGY CO., LTD.

<i>Issue</i>	<i>Date</i>	<i>Modifications</i>
A	9/18/2015	Initial release



COMOSAR E-FIELD PROBE CALIBRATION REPORT

Ref: ACR.261.1.15.SATU-A

TABLE OF CONTENTS

1	Device Under Test .....	4
2	Product Description .....	4
2.1	General Information .....	4
3	Measurement Method .....	4
3.1	Linearity .....	4
3.2	Sensitivity .....	5
3.3	Lower Detection Limit .....	5
3.4	Isotropy .....	5
3.5	Boundary Effect .....	5
4	Measurement Uncertainty .....	5
5	Calibration Measurement Results .....	6
5.1	Sensitivity in air .....	6
5.2	Linearity .....	7
5.3	Sensitivity in liquid .....	7
5.4	Isotropy .....	8
6	List of Equipment .....	10



**1 DEVICE UNDER TEST**

Device Under Test	
Device Type	COMOSAR DOSIMETRIC E FIELD PROBE
Manufacturer	MVG
Model	SSE2
Serial Number	SN 34/15 EPGO267
Product Condition (new / used)	New
Frequency Range of Probe	0.45 GHz-6GHz
Resistance of Three Dipoles at Connector	Dipole 1: R1=0.234 MΩ Dipole 2: R2=0.236 MΩ Dipole 3: R3=0.233 MΩ

A yearly calibration interval is recommended.

**2 PRODUCT DESCRIPTION**

**2.1 GENERAL INFORMATION**

MVG's COMOSAR E field Probes are built in accordance to the IEEE 1528, OET 65 Bulletin C and CEI/IEC 62209 standards.



**Figure 1 – MVG COMOSAR Dosimetric E field Dipole**

Probe Length	330 mm
Length of Individual Dipoles	2 mm
Maximum external diameter	8 mm
Probe Tip External Diameter	2.5 mm
Distance between dipoles / probe extremity	1 mm

**3 MEASUREMENT METHOD**

The IEEE 1528, OET 65 Bulletin C, CENELEC EN50361 and CEI/IEC 62209 standards provide recommended practices for the probe calibrations, including the performance characteristics of interest and methods by which to assess their affect. All calibrations / measurements performed meet the fore mentioned standards.

**3.1 LINEARITY**

The evaluation of the linearity was done in free space using the waveguide, performing a power sweep to cover the SAR range 0.01W/kg to 100W/kg.



**3.2 SENSITIVITY**

The sensitivity factors of the three dipoles were determined using a two step calibration method (air and tissue simulating liquid) using waveguides as outlined in the standards.

**3.3 LOWER DETECTION LIMIT**

The lower detection limit was assessed using the same measurement set up as used for the linearity measurement. The required lower detection limit is 10 mW/kg.

**3.4 ISOTROPY**

The axial isotropy was evaluated by exposing the probe to a reference wave from a standard dipole with the dipole mounted under the flat phantom in the test configuration suggested for system validations and checks. The probe was rotated along its main axis from 0 - 360 degrees in 15 degree steps. The hemispherical isotropy is determined by inserting the probe in a thin plastic box filled with tissue-equivalent liquid, with the plastic box illuminated with the fields from a half wave dipole. The dipole is rotated about its axis (0°-180°) in 15° increments. At each step the probe is rotated about its axis (0°-360°).

**3.5 BOUNDARY EFFECT**

The boundary effect is defined as the deviation between the SAR measured data and the expected exponential decay in the liquid when the probe is oriented normal to the interface. To evaluate this effect, the liquid filled flat phantom is exposed to fields from either a reference dipole or waveguide. With the probe normal to the phantom surface, the peak spatial average SAR is measured and compared to the analytical value at the surface.

**4 MEASUREMENT UNCERTAINTY**

The guidelines outlined in the IEEE 1528, OET 65 Bulletin C, CENELEC EN50361 and CEI/IEC 62209 standards were followed to generate the measurement uncertainty associated with an E-field probe calibration using the waveguide technique. All uncertainties listed below represent an expanded uncertainty expressed at approximately the 95% confidence level using a coverage factor of k=2, traceable to the Internationally Accepted Guides to Measurement Uncertainty.

Uncertainty analysis of the probe calibration in waveguide					
ERROR SOURCES	Uncertainty value (%)	Probability Distribution	Divisor	cl	Standard Uncertainty (%)
Incident or forward power	3.00%	Rectangular	$\sqrt{3}$	1	1.732%
Reflected power	3.00%	Rectangular	$\sqrt{3}$	1	1.732%
Liquid conductivity	5.00%	Rectangular	$\sqrt{3}$	1	2.887%
Liquid permittivity	4.00%	Rectangular	$\sqrt{3}$	1	2.309%
Field homogeneity	3.00%	Rectangular	$\sqrt{3}$	1	1.732%
Field probe positioning	5.00%	Rectangular	$\sqrt{3}$	1	2.887%





COMOSAR E-FIELD PROBE CALIBRATION REPORT

Ref: ACR.261.1.15.SATU.A

Field probe linearity	3.00%	Rectangular	$\sqrt{3}$	1	1.732%
<b>Combined standard uncertainty</b>					5.831%
<b>Expanded uncertainty</b> 95 % confidence level k = 2					12.0%

5 CALIBRATION MEASUREMENT RESULTS

Calibration Parameters	
Liquid Temperature	21 °C
Lab Temperature	21 °C
Lab Humidity	45 %

5.1 SENSITIVITY IN AIR

Normx dipole 1 ( $\mu\text{V}/(\text{V}/\text{m})^2$ )	Normy dipole 2 ( $\mu\text{V}/(\text{V}/\text{m})^2$ )	Normz dipole 3 ( $\mu\text{V}/(\text{V}/\text{m})^2$ )
0.80	0.84	0.81

DCP dipole 1 (mV)	DCP dipole 2 (mV)	DCP dipole 3 (mV)
91	93	90

Calibration curves  $e_i=f(V)$  ( $i=1,2,3$ ) allow to obtain H-field value using the formula:

$$E = \sqrt{E_1^2 + E_2^2 + E_3^2}$$

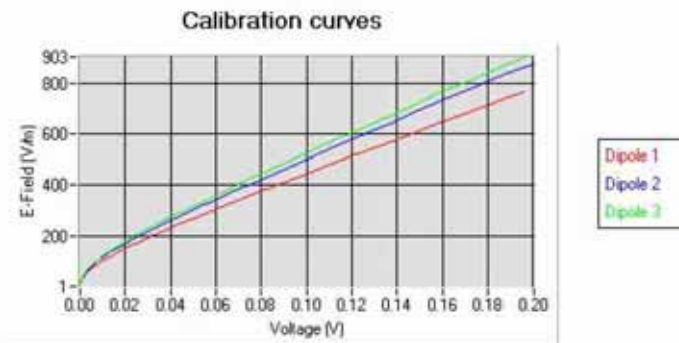



COMOSAR E-FIELD PROBE CALIBRATION REPORT

Ref: ACR.261.1.15.SATU-A

5.2 LINEARITY

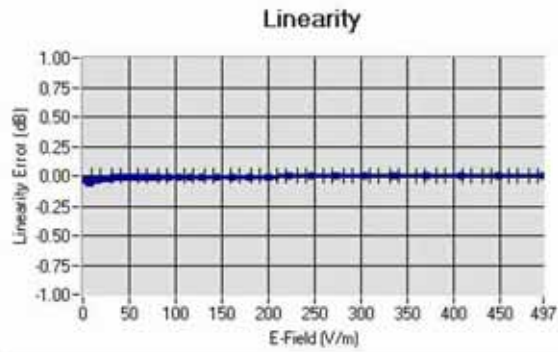

Linearity:  $\pm 1.31\%$  ( $\pm 0.06\text{dB}$ )

5.3 SENSITIVITY IN LIQUID

Liquid	Frequency (MHz +/- 100MHz)	Permittivity	Epsilon (S/m)	ConvF
HL450	450	43.68	0.87	1.87
BL450	450	58.34	0.99	1.92
HL750	750	41.82	0.90	1.69
BL750	750	56.28	0.98	1.75
HL850	835	42.59	0.90	1.89
BL850	835	53.19	0.97	1.94
HL900	900	42.05	0.98	1.74
BL900	900	56.41	1.08	1.81
HL1800	1800	41.82	1.38	1.91
BL1800	1800	53.00	1.52	1.95
HL1900	1900	40.38	1.41	2.16
BL1900	1900	53.93	1.55	2.24
HL2000	2000	40.12	1.43	2.02
BL2000	2000	53.65	1.54	2.09
HL2450	2450	38.34	1.80	2.11
BL2450	2450	52.70	1.94	2.17
HL2600	2600	38.16	1.93	2.16
BL2600	2600	51.55	2.21	2.21
HL5200	5200	36.44	4.79	1.97
BL5200	5200	50.70	5.11	2.03
HL5400	5400	35.99	4.91	2.20
BL5400	5400	50.01	5.64	2.29
HL5600	5600	35.22	5.18	2.24
BL5600	5600	49.34	5.85	2.29
HL5800	5800	34.95	5.42	2.02
BL5800	5800	48.54	6.22	2.09

LOWER DETECTION LIMIT: 9mW/kg



COMOSAR E-FIELD PROBE CALIBRATION REPORT

Ref: ACR.261.1.15.SATU-A

5.4 ISOTROPY

**HL900 MHz**

- Axial isotropy: 0.04 dB
- Hemispherical isotropy: 0.05 dB

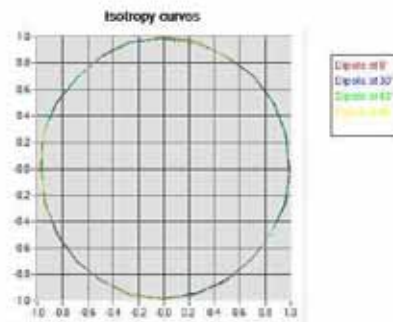

**HL1800 MHz**

- Axial isotropy: 0.06 dB
- Hemispherical isotropy: 0.07 dB

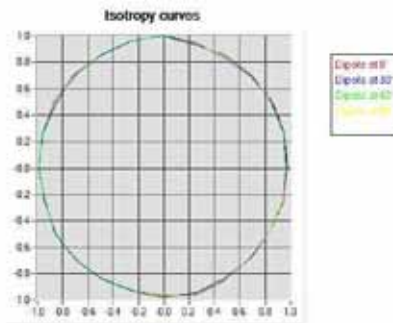





COMOSAR E-FIELD PROBE CALIBRATION REPORT

Ref: ACR.261.1.15.SATU-A

**HL 5600 MHz**

- Axial isotropy: 0.06 dB
- Hemispherical isotropy: 0.08 dB

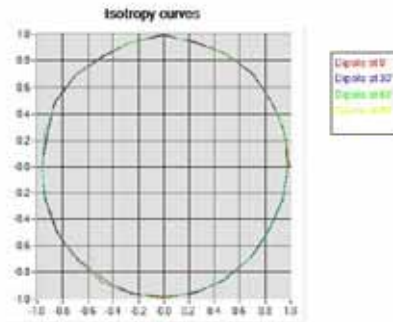



COMOSAR E-FIELD PROBE CALIBRATION REPORT

Ref: ACR.261.1.15.SATU.A

6 LIST OF EQUIPMENT

Equipment Summary Sheet				
Equipment Description	Manufacturer / Model	Identification No.	Current Calibration Date	Next Calibration Date
Fiat Phantom	MVG	SN-20/09-SAM71	Validated. No cal required.	Validated. No cal required.
COMOSAR Test Bench	Version 3	NA	Validated. No cal required.	Validated. No cal required.
Network Analyzer	Rhode & Schwarz ZVA	SN100132	02/2013	02/2016
Reference Probe	MVG	EP 94 SN 37/08	10/2014	10/2015
Multimeter	Keithley 2000	1188656	12/2013	12/2016
Signal Generator	Agilent E4438C	MY49070581	12/2013	12/2016
Amplifier	Aethercomm	SN 046	Characterized prior to test. No cal required.	Characterized prior to test. No cal required.
Power Meter	HP E4418A	US38261498	12/2013	12/2016
Power Sensor	HP ECP-E26A	US37181460	12/2013	12/2016
Directional Coupler	Narda 4216-20	01386	Characterized prior to test. No cal required.	Characterized prior to test. No cal required.
Waveguide	Mega Industries	069Y7-158-13-712	Validated. No cal required.	Validated. No cal required.
Waveguide Transition	Mega Industries	069Y7-158-13-701	Validated. No cal required.	Validated. No cal required.
Waveguide Termination	Mega Industries	069Y7-158-13-701	Validated. No cal required.	Validated. No cal required.
Temperature / Humidity Sensor	Control Company	11-661-9	8/2012	8/2015



## SAR Reference Dipole Calibration Report

Ref : ACR.139.4.15.SATU.A

**NTEK TESTING TECHNOLOGY CO., LTD.**  
**BUILDING E, FENDA SCIENCE PARK, SANWEI**  
**COMMUNITY, XIXIANG STREET,**  
**BAO'AN DISTRICT, SHENZHEN GUANGDONG, CHINA**  
**MVG COMOSAR REFERENCE DIPOLE**  
**FREQUENCY: 835 MHZ**  
**SERIAL NO.: SN 03/15 DIP 0G835-347**

**Calibrated at MVG US**  
**2105 Barrett Park Dr. - Kennesaw, GA 30144**



**04/06/2015**

*Summary:*

This document presents the method and results from an accredited SAR reference dipole calibration performed in MVG USA using the COMOSAR test bench. All calibration results are traceable to national metrology institutions.



SAR REFERENCE DIPOLE CALIBRATION REPORT

Ref. ACR.139.4.15.SATU.A

	<i>Name</i>	<i>Function</i>	<i>Date</i>	<i>Signature</i>
<i>Prepared by :</i>	Jérôme LUC	Product Manager	5/19/2015	<i>JS</i>
<i>Checked by :</i>	Jérôme LUC	Product Manager	5/19/2015	<i>JS</i>
<i>Approved by :</i>	Kim RUTKOWSKI	Quality Manager	5/19/2015	<i>Kim Rutkowski</i>

	<i>Customer Name</i>
<i>Distribution :</i>	NTEK TESTING TECHNOLOGY CO., LTD.

<i>Issue</i>	<i>Date</i>	<i>Modifications</i>
A	5/19/2015	Initial release



## TABLE OF CONTENTS

1	Introduction .....	4
2	Device Under Test .....	4
3	Product Description .....	4
3.1	General Information .....	4
4	Measurement Method .....	5
4.1	Return Loss Requirements .....	5
4.2	Mechanical Requirements .....	5
5	Measurement Uncertainty .....	5
5.1	Return Loss .....	5
5.2	Dimension Measurement .....	5
5.3	Validation Measurement .....	5
6	Calibration Measurement Results .....	6
6.1	Return Loss and Impedance In Head Liquid .....	6
6.2	Return Loss and Impedance In Body Liquid .....	6
6.3	Mechanical Dimensions .....	6
7	Validation measurement .....	7
7.1	Head Liquid Measurement .....	7
7.2	SAR Measurement Result With Head Liquid .....	8
7.3	Body Liquid Measurement .....	9
7.4	SAR Measurement Result With Body Liquid .....	10
8	List of Equipment .....	12



**1 INTRODUCTION**

This document contains a summary of the requirements set forth by the IEEE 1528, FCC KDBs and CEI/IEC 62209 standards for reference dipoles used for SAR measurement system validations and the measurements that were performed to verify that the product complies with the fore mentioned standards.

**2 DEVICE UNDER TEST**

Device Under Test	
Device Type	COMOSAR 835 MHz REFERENCE DIPOLE
Manufacturer	MVG
Model	SID835
Serial Number	SN 03/15 DIP 0G835-347
Product Condition (new / used)	New

A yearly calibration interval is recommended.

**3 PRODUCT DESCRIPTION**

**3.1 GENERAL INFORMATION**

MVG’s COMOSAR Validation Dipoles are built in accordance to the IEEE 1528, FCC KDBs and CEI/IEC 62209 standards. The product is designed for use with the COMOSAR test bench only.



**Figure 1 – MVG COMOSAR Validation Dipole**



#### 4 MEASUREMENT METHOD

The IEEE 1528, FCC KDBs and CEI/IEC 62209 standards provide requirements for reference dipoles used for system validation measurements. The following measurements were performed to verify that the product complies with the fore mentioned standards.

##### 4.1 RETURN LOSS REQUIREMENTS

The dipole used for SAR system validation measurements and checks must have a return loss of -20 dB or better. The return loss measurement shall be performed against a liquid filled flat phantom, with the phantom constructed as outlined in the fore mentioned standards.

##### 4.2 MECHANICAL REQUIREMENTS

The IEEE Std. 1528 and CEI/IEC 62209 standards specify the mechanical components and dimensions of the validation dipoles, with the dimensions frequency and phantom shell thickness dependent. The COMOSAR test bench employs a 2 mm phantom shell thickness therefore the dipoles sold for use with the COMOSAR test bench comply with the requirements set forth for a 2 mm phantom shell thickness.

#### 5 MEASUREMENT UNCERTAINTY

All uncertainties listed below represent an expanded uncertainty expressed at approximately the 95% confidence level using a coverage factor of k=2, traceable to the Internationally Accepted Guides to Measurement Uncertainty.

##### 5.1 RETURN LOSS

The following uncertainties apply to the return loss measurement:

Frequency band	Expanded Uncertainty on Return Loss
400-6000MHz	0.1 dB

##### 5.2 DIMENSION MEASUREMENT

The following uncertainties apply to the dimension measurements:

Length (mm)	Expanded Uncertainty on Length
3 - 300	0.05 mm

##### 5.3 VALIDATION MEASUREMENT

The guidelines outlined in the IEEE 1528, FCC KDBs, CENELEC EN50361 and CEI/IEC 62209 standards were followed to generate the measurement uncertainty for validation measurements.

Scan Volume	Expanded Uncertainty





SAR REFERENCE DIPOLE CALIBRATION REPORT

Ref. ACR.139.4.15.SATU.A

1 g	20.3 %
10 g	20.1 %

6 CALIBRATION MEASUREMENT RESULTS

6.1 RETURN LOSS AND IMPEDANCE IN HEAD LIQUID

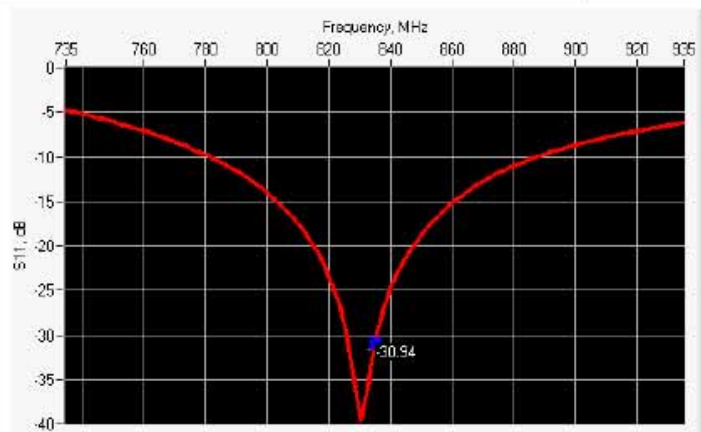

Frequency (MHz)	Return Loss (dB)	Requirement (dB)	Impedance
835	-30.94	-20	52.6 Ω + 1.1 jΩ

6.2 RETURN LOSS AND IMPEDANCE IN BODY LIQUID

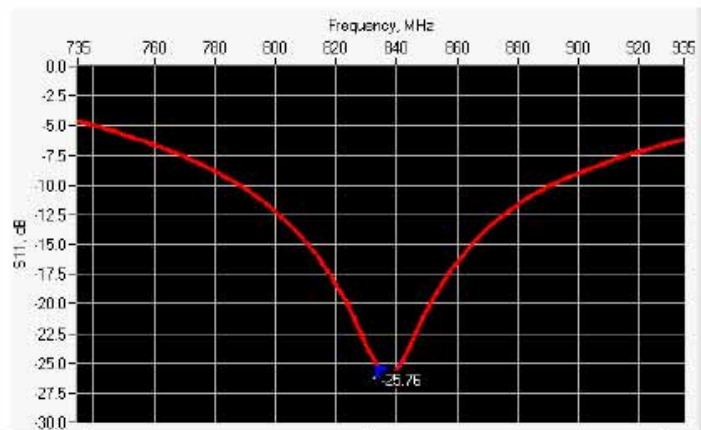

Frequency (MHz)	Return Loss (dB)	Requirement (dB)	Impedance
835	-25.76	-20	47.7 Ω + 4.6 jΩ

6.3 MECHANICAL DIMENSIONS

Frequency MHz	L mm		h mm		d mm	
	required	measured	required	measured	required	measured





SAR REFERENCE DIPOLE CALIBRATION REPORT

Ref ACR.139.4.15.SATU.A

300	420.0 ±1 %		250.0 ±1 %		6.35 ±1 %	
450	290.0 ±1 %		166.7 ±1 %		6.35 ±1 %	
750	176.0 ±1 %		100.0 ±1 %		6.35 ±1 %	
835	161.0 ±1 %	PASS	89.8 ±1 %	PASS	3.6 ±1 %	PASS
900	149.0 ±1 %		83.3 ±1 %		3.6 ±1 %	
1450	89.1 ±1 %		51.7 ±1 %		3.6 ±1 %	
1500	80.5 ±1 %		50.0 ±1 %		3.6 ±1 %	
1640	79.0 ±1 %		45.7 ±1 %		3.6 ±1 %	
1750	75.2 ±1 %		42.9 ±1 %		3.6 ±1 %	
1800	72.0 ±1 %		41.7 ±1 %		3.6 ±1 %	
1900	68.0 ±1 %		39.5 ±1 %		3.6 ±1 %	
1950	66.3 ±1 %		38.5 ±1 %		3.6 ±1 %	
2000	64.5 ±1 %		37.5 ±1 %		3.6 ±1 %	
2100	61.0 ±1 %		35.7 ±1 %		3.6 ±1 %	
2300	55.5 ±1 %		32.6 ±1 %		3.6 ±1 %	
2450	51.5 ±1 %		30.4 ±1 %		3.6 ±1 %	
2600	48.5 ±1 %		28.8 ±1 %		3.6 ±1 %	
3000	41.5 ±1 %		25.0 ±1 %		3.6 ±1 %	
3500	37.0 ±1 %		26.4 ±1 %		3.6 ±1 %	
3700	34.7 ±1 %		26.4 ±1 %		3.6 ±1 %	

7 VALIDATION MEASUREMENT

The IEEE Std. 1528, FCC KDBs and CEI/IEC 62209 standards state that the system validation measurements must be performed using a reference dipole meeting the fore mentioned return loss and mechanical dimension requirements. The validation measurement must be performed against a liquid filled flat phantom, with the phantom constructed as outlined in the fore mentioned standards. Per the standards, the dipole shall be positioned below the bottom of the phantom, with the dipole length centered and parallel to the longest dimension of the flat phantom, with the top surface of the dipole at the described distance from the bottom surface of the phantom.

7.1 HEAD LIQUID MEASUREMENT

Frequency MHz	Relative permittivity (ε <sub>r</sub> )		Conductivity (σ) S/m	
	required	measured	required	measured
300	45.3 ±5 %		0.87 ±5 %	
450	43.5 ±5 %		0.87 ±5 %	
750	41.9 ±5 %		0.89 ±5 %	
835	41.5 ±5 %	PASS	0.90 ±5 %	PASS
900	41.5 ±5 %		0.97 ±5 %	
1450	40.5 ±5 %		1.20 ±5 %	
1500	40.4 ±5 %		1.23 ±5 %	
1640	40.2 ±5 %		1.31 ±5 %	



SAR REFERENCE DIPOLE CALIBRATION REPORT

Ref. ACR.139.4.15.SATU.A

1750	40.1 ±5 %		1.37 ±5 %	
1800	40.0 ±5 %		1.40 ±5 %	
1900	40.0 ±5 %		1.40 ±5 %	
1950	40.0 ±5 %		1.40 ±5 %	
2000	40.0 ±5 %		1.40 ±5 %	
2100	39.8 ±5 %		1.49 ±5 %	
2300	39.5 ±5 %		1.67 ±5 %	
2450	39.2 ±5 %		1.80 ±5 %	
2600	39.0 ±5 %		1.96 ±5 %	
3000	38.5 ±5 %		2.40 ±5 %	
3500	37.9 ±5 %		2.91 ±5 %	

7.2 SAR MEASUREMENT RESULT WITH HEAD LIQUID

The IEEE Std. 1528 and CEI/IEC 62209 standards state that the system validation measurements should produce the SAR values shown below (for phantom thickness of 2 mm), within the uncertainty for the system validation. All SAR values are normalized to 1 W forward power. In bracket, the measured SAR is given with the used input power.

Software	OPENSAR V4
Phantom	SN 20/09 SAM71
Probe	SN 18/11 EPG122
Liquid	Head Liquid Values: eps' : 42.3 sigma : 0.92
Distance between dipole center and liquid	15.0 mm
Area scan resolution	dx=8mm/dy=8mm
Zoon Scan Resolution	dx=8mm/dy=8mm/dz=5mm
Frequency	835 MHz
Input power	20 dBm
Liquid Temperature	21 °C
Lab Temperature	21 °C
Lab Humidity	45 %

Frequency MHz	1 g SAR (W/kg/W)		10 g SAR (W/kg/W)	
	required	measured	required	measured
300	2.85		1.94	
450	4.58		3.06	
750	8.49		5.55	
835	9.56	9.60 (0.96)	6.22	6.24 (0.62)
900	10.9		6.99	
1450	29		16	
1500	30.5		16.8	
1640	34.2		18.4	
1750	36.4		19.3	



SAR REFERENCE DIPOLE CALIBRATION REPORT

Ref: ACR.139.4.15.SATU.A

1800	38.4		20.1	
1900	39.7		20.5	
1950	40.5		20.9	
2000	41.1		21.1	
2100	43.6		21.9	
2300	48.7		23.3	
2450	52.4		24	
2600	55.3		24.6	
3000	63.8		25.7	
3500	67.1		25	

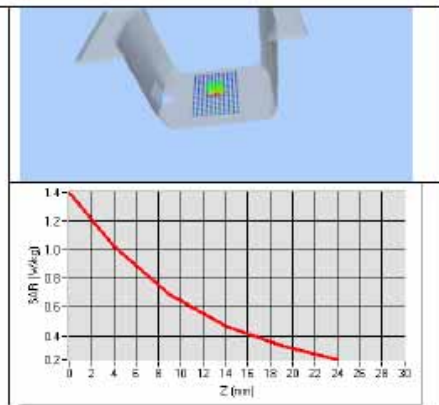
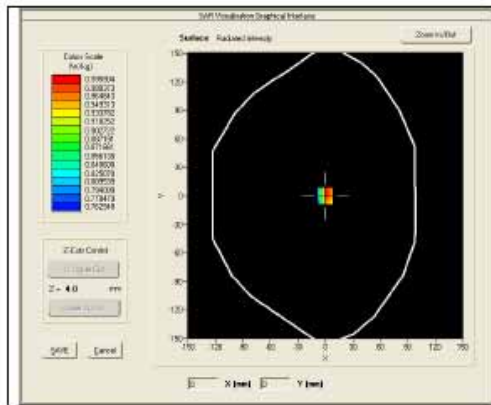

7.3 BODY LIQUID MEASUREMENT

Frequency MHz	Relative permittivity ( $\epsilon_r'$ )		Conductivity ( $\sigma$ ) S/m	
	required	measured	required	measured
150	61.9 ±5 %		0.80 ±5 %	
300	58.2 ±5 %		0.92 ±5 %	
450	56.7 ±5 %		0.94 ±5 %	
750	55.5 ±5 %		0.96 ±5 %	
835	55.2 ±5 %	PASS	0.97 ±5 %	PASS
900	55.0 ±5 %		1.05 ±5 %	
915	55.0 ±5 %		1.06 ±5 %	
1450	54.0 ±5 %		1.30 ±5 %	
1610	53.8 ±5 %		1.40 ±5 %	
1800	53.3 ±5 %		1.52 ±5 %	
1900	53.3 ±5 %		1.52 ±5 %	
2000	53.3 ±5 %		1.52 ±5 %	
2100	53.2 ±5 %		1.62 ±5 %	



SAR REFERENCE DIPOLE CALIBRATION REPORT

Ref. ACR.139.4.15.SATU.A

2450	52.7 ±5 %		1.95 ±5 %	
2600	52.5 ±5 %		2.16 ±5 %	
3000	52.0 ±5 %		2.73 ±5 %	
3500	51.3 ±5 %		3.31 ±5 %	
5200	49.0 ±10 %		5.30 ±10 %	
5300	48.9 ±10 %		5.42 ±10 %	
5400	48.7 ±10 %		5.53 ±10 %	
5500	48.6 ±10 %		5.65 ±10 %	
5600	48.5 ±10 %		5.77 ±10 %	
5800	48.2 ±10 %		6.00 ±10 %	

7.4 SAR MEASUREMENT RESULT WITH BODY LIQUID

Software	OPENSAR V4
Phantom	SN 20/09 SAM71
Probe	SN 18/11 EPG122
Liquid	Body Liquid Values: eps' : 53.3 sigma : 0.97
Distance between dipole center and liquid	15.0 mm
Area scan resolution	dx=8mm/dy=8mm
Zoon Scan Resolution	dx=8mm/dy=8mm/dz=5mm
Frequency	835 MHz
Input power	20 dBm
Liquid Temperature	21 °C
Lab Temperature	21 °C
Lab Humidity	45 %

Frequency MHz	1 g SAR (W/kg/W)	10 g SAR (W/kg/W)
	measured	measured
835	9.48 (0.95)	6.29 (0.63)



SAR REFERENCE DIPOLE CALIBRATION REPORT

Ref. ACR.139.4.15.SATU.A

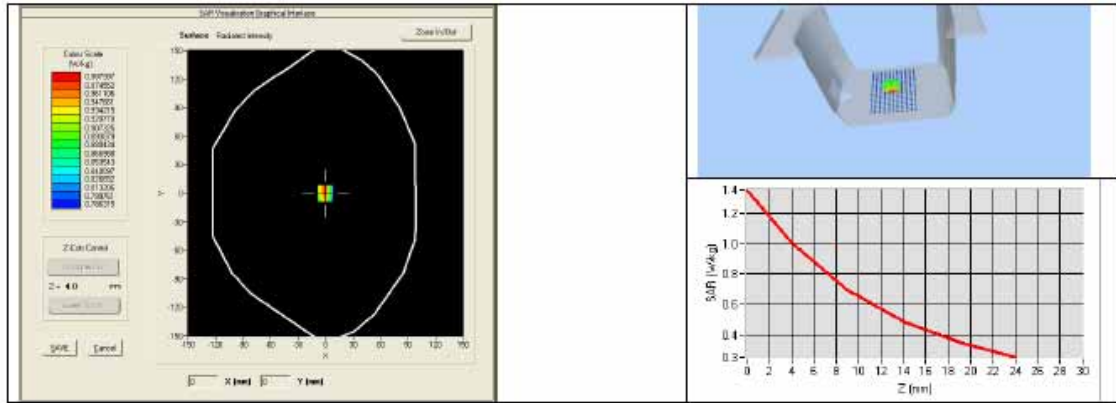



**8 LIST OF EQUIPMENT**

Equipment Summary Sheet				
Equipment Description	Manufacturer / Model	Identification No.	Current Calibration Date	Next Calibration Date
SAM Phantom	MVG	SN-20/09-SAM71	Validated. No cal required.	Validated. No cal required.
COMOSAR Test Bench	Version 3	NA	Validated. No cal required.	Validated. No cal required.
Network Analyzer	Rhode & Schwarz ZVA	SN100132	02/2013	02/2016
Calipers	Carrera	CALIPER-01	12/2013	12/2016
Reference Probe	MVG	EPG122 SN 18/11	10/2014	10/2015
Multimeter	Keithley 2000	1188656	12/2013	12/2016
Signal Generator	Agilent E4438C	MY49070581	12/2013	12/2016
Amplifier	Aethercomm	SN 046	Characterized prior to test. No cal required.	Characterized prior to test. No cal required.
Power Meter	HP E4418A	US38261498	12/2013	12/2016
Power Sensor	HP ECP-E26A	US37181460	12/2013	12/2016
Directional Coupler	Narda 4216-20	01386	Characterized prior to test. No cal required.	Characterized prior to test. No cal required.
Temperature and Humidity Sensor	Control Company	11-661-9	8/2012	8/2015



## SAR Reference Dipole Calibration Report

Ref : ACR.139.7.15.SATU.A

**NTEK TESTING TECHNOLOGY CO., LTD.**  
**BUILDING E, FENDA SCIENCE PARK, SANWEI**  
**COMMUNITY, XIXIANG STREET,**  
**BAO'AN DISTRICT, SHENZHEN GUANGDONG, CHINA**  
**MVG COMOSAR REFERENCE DIPOLE**  
**FREQUENCY: 1900 MHZ**  
**SERIAL NO.: SN 03/15 DIP 1G900-350**

**Calibrated at MVG US**  
**2105 Barrett Park Dr. - Kennesaw, GA 30144**



**04/06/2015**

### *Summary:*

This document presents the method and results from an accredited SAR reference dipole calibration performed in MVG USA using the COMOSAR test bench. All calibration results are traceable to national metrology institutions.





SAR REFERENCE DIPOLE CALIBRATION REPORT

Ref: ACR.139.7.15.SATU.A

	<i>Name</i>	<i>Function</i>	<i>Date</i>	<i>Signature</i>
<i>Prepared by :</i>	Jérôme LUC	Product Manager	5/19/2015	<i>JS</i>
<i>Checked by :</i>	Jérôme LUC	Product Manager	5/19/2015	<i>JS</i>
<i>Approved by :</i>	Kim RUTKOWSKI	Quality Manager	5/19/2015	<i>Kim Rutkowski</i>

	<i>Customer Name</i>
<i>Distribution :</i>	NTEK TESTING TECHNOLOGY CO., LTD.

<i>Issue</i>	<i>Date</i>	<i>Modifications</i>
A	5/19/2015	Initial release





## TABLE OF CONTENTS

1	Introduction.....	4
2	Device Under Test.....	4
3	Product Description.....	4
3.1	General Information.....	4
4	Measurement Method.....	5
4.1	Return Loss Requirements.....	5
4.2	Mechanical Requirements.....	5
5	Measurement Uncertainty.....	5
5.1	Return Loss.....	5
5.2	Dimension Measurement.....	5
5.3	Validation Measurement.....	5
6	Calibration Measurement Results.....	6
6.1	Return Loss and Impedance In Head Liquid.....	6
6.2	Return Loss and Impedance In Body Liquid.....	6
6.3	Mechanical Dimensions.....	6
7	Validation measurement.....	7
7.1	Head Liquid Measurement.....	7
7.2	SAR Measurement Result With Head Liquid.....	8
7.3	Body Liquid Measurement.....	9
7.4	SAR Measurement Result With Body Liquid.....	10
8	List of Equipment.....	11



## 1 INTRODUCTION

This document contains a summary of the requirements set forth by the IEEE 1528, FCC KDBs and CEI/IEC 62209 standards for reference dipoles used for SAR measurement system validations and the measurements that were performed to verify that the product complies with the fore mentioned standards.

## 2 DEVICE UNDER TEST

Device Under Test	
Device Type	COMOSAR 1900 MHz REFERENCE DIPOLE
Manufacturer	MVG
Model	SID1900
Serial Number	SN 03/15 DIP 1G900-350
Product Condition (new / used)	New

A yearly calibration interval is recommended.

## 3 PRODUCT DESCRIPTION

### 3.1 GENERAL INFORMATION

MVG's COMOSAR Validation Dipoles are built in accordance to the IEEE 1528, FCC KDBs and CEI/IEC 62209 standards. The product is designed for use with the COMOSAR test bench only.



**Figure 1 – MVG COMOSAR Validation Dipole**



**4 MEASUREMENT METHOD**

The IEEE 1528, FCC KDBs and CEI/IEC 62209 standards provide requirements for reference dipoles used for system validation measurements. The following measurements were performed to verify that the product complies with the fore mentioned standards.

**4.1 RETURN LOSS REQUIREMENTS**

The dipole used for SAR system validation measurements and checks must have a return loss of -20 dB or better. The return loss measurement shall be performed against a liquid filled flat phantom, with the phantom constructed as outlined in the fore mentioned standards.

**4.2 MECHANICAL REQUIREMENTS**

The IEEE Std. 1528 and CEI/IEC 62209 standards specify the mechanical components and dimensions of the validation dipoles, with the dimensions frequency and phantom shell thickness dependent. The COMOSAR test bench employs a 2 mm phantom shell thickness therefore the dipoles sold for use with the COMOSAR test bench comply with the requirements set forth for a 2 mm phantom shell thickness.

**5 MEASUREMENT UNCERTAINTY**

All uncertainties listed below represent an expanded uncertainty expressed at approximately the 95% confidence level using a coverage factor of k=2, traceable to the Internationally Accepted Guides to Measurement Uncertainty.

**5.1 RETURN LOSS**

The following uncertainties apply to the return loss measurement:

Frequency band	Expanded Uncertainty on Return Loss
400-6000MHz	0.1 dB

**5.2 DIMENSION MEASUREMENT**

The following uncertainties apply to the dimension measurements:

Length (mm)	Expanded Uncertainty on Length
3 - 300	0.05 mm

**5.3 VALIDATION MEASUREMENT**

The guidelines outlined in the IEEE 1528, FCC KDBs, CENELEC EN50361 and CEI/IEC 62209 standards were followed to generate the measurement uncertainty for validation measurements.

Scan Volume	Expanded Uncertainty
1 g	20.3 %



SAR REFERENCE DIPOLE CALIBRATION REPORT

Ref: ACR.139.7.15.SATU.A

10 g	20.1 %
------	--------

**6 CALIBRATION MEASUREMENT RESULTS**

**6.1 RETURN LOSS AND IMPEDANCE IN HEAD LIQUID**

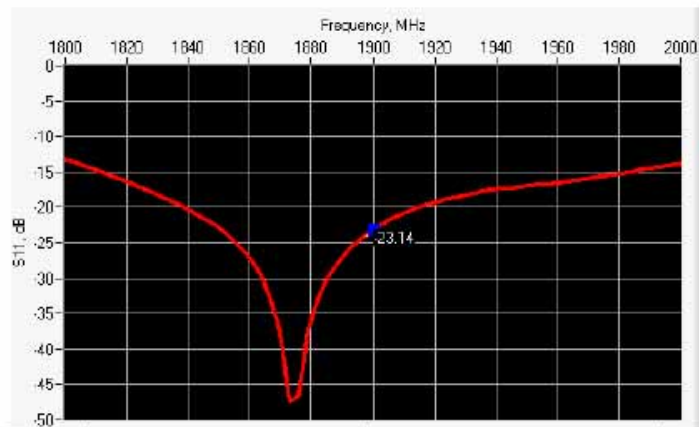

Frequency (MHz)	Return Loss (dB)	Requirement (dB)	Impedance
1900	-23.14	-20	53.6 Ω + 5.9 jΩ

**6.2 RETURN LOSS AND IMPEDANCE IN BODY LIQUID**

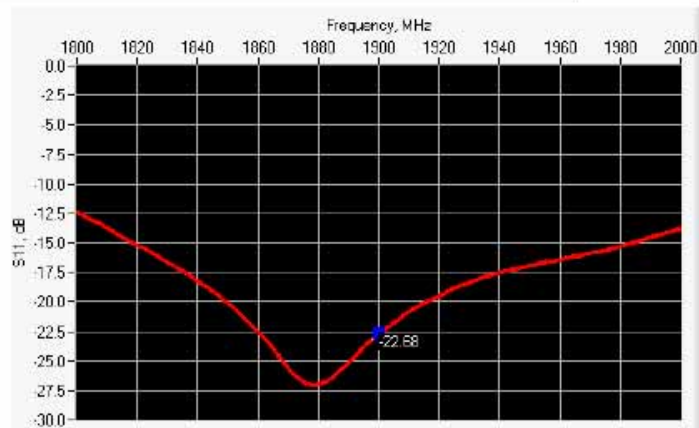

Frequency (MHz)	Return Loss (dB)	Requirement (dB)	Impedance
1900	-22.68	-20	49.3 Ω + 7.3 jΩ

**6.3 MECHANICAL DIMENSIONS**

Frequency MHz	L mm		h mm		d mm	
	required	measured	required	measured	required	measured
300	420.0 ±1 %		250.0 ±1 %		6.35 ±1 %	



SAR REFERENCE DIPOLE CALIBRATION REPORT

Ref. ACR.139.7.15.SATU.A

450	290.0 ±1 %.		166.7 ±1 %.		6.35 ±1 %.	
750	176.0 ±1 %.		100.0 ±1 %.		6.35 ±1 %.	
835	161.0 ±1 %.		89.8 ±1 %.		3.6 ±1 %.	
900	149.0 ±1 %.		83.3 ±1 %.		3.6 ±1 %.	
1450	89.1 ±1 %.		51.7 ±1 %.		3.6 ±1 %.	
1500	80.5 ±1 %.		50.0 ±1 %.		3.6 ±1 %.	
1640	79.0 ±1 %.		45.7 ±1 %.		3.6 ±1 %.	
1750	75.2 ±1 %.		42.9 ±1 %.		3.6 ±1 %.	
1800	72.0 ±1 %.		41.7 ±1 %.		3.6 ±1 %.	
1900	68.0 ±1 %.	PASS	39.5 ±1 %.	PASS	3.6 ±1 %.	PASS
1950	66.3 ±1 %.		38.5 ±1 %.		3.6 ±1 %.	
2000	64.5 ±1 %.		37.5 ±1 %.		3.6 ±1 %.	
2100	61.0 ±1 %.		35.7 ±1 %.		3.6 ±1 %.	
2300	55.5 ±1 %.		32.6 ±1 %.		3.6 ±1 %.	
2450	51.5 ±1 %.		30.4 ±1 %.		3.6 ±1 %.	
2600	48.5 ±1 %.		28.8 ±1 %.		3.6 ±1 %.	
3000	41.5 ±1 %.		25.0 ±1 %.		3.6 ±1 %.	
3500	37.0 ±1 %.		26.4 ±1 %.		3.6 ±1 %.	
3700	34.7 ±1 %.		26.4 ±1 %.		3.6 ±1 %.	

7 VALIDATION MEASUREMENT

The IEEE Std. 1528, FCC KDBs and CEI/IEC 62209 standards state that the system validation measurements must be performed using a reference dipole meeting the fore mentioned return loss and mechanical dimension requirements. The validation measurement must be performed against a liquid filled flat phantom, with the phantom constructed as outlined in the fore mentioned standards. Per the standards, the dipole shall be positioned below the bottom of the phantom, with the dipole length centered and parallel to the longest dimension of the flat phantom, with the top surface of the dipole at the described distance from the bottom surface of the phantom.

7.1 HEAD LIQUID MEASUREMENT

Frequency MHz	Relative permittivity ( $\epsilon_r'$ )		Conductivity ( $\sigma$ ) S/m	
	required	measured	required	measured
300	45.3 ±5 %		0.87 ±5 %	
450	43.5 ±5 %		0.87 ±5 %	
750	41.9 ±5 %		0.89 ±5 %	
835	41.5 ±5 %		0.90 ±5 %	
900	41.5 ±5 %		0.97 ±5 %	
1450	40.5 ±5 %		1.20 ±5 %	
1500	40.4 ±5 %		1.23 ±5 %	
1640	40.2 ±5 %		1.31 ±5 %	
1750	40.1 ±5 %		1.37 ±5 %	



SAR REFERENCE DIPOLE CALIBRATION REPORT

Ref: ACR.139.7.15.SATU.A

1800	40.0 ±5 %		1.40 ±5 %	
1900	40.0 ±5 %	PASS	1.40 ±5 %	PASS
1950	40.0 ±5 %		1.40 ±5 %	
2000	40.0 ±5 %		1.40 ±5 %	
2100	39.8 ±5 %		1.49 ±5 %	
2300	39.5 ±5 %		1.67 ±5 %	
2450	39.2 ±5 %		1.80 ±5 %	
2600	39.0 ±5 %		1.96 ±5 %	
3000	38.5 ±5 %		2.40 ±5 %	
3500	37.9 ±5 %		2.91 ±5 %	

7.2 SAR MEASUREMENT RESULT WITH HEAD LIQUID

The IEEE Std. 1528 and CEI/IEC 62209 standards state that the system validation measurements should produce the SAR values shown below (for phantom thickness of 2 mm), within the uncertainty for the system validation. All SAR values are normalized to 1 W forward power. In bracket, the measured SAR is given with the used input power.

Software	OPENSAR V4
Phantom	SN 20/09 SAM71
Probe	SN 18/11 EPG122
Liquid	Head Liquid Values: eps' : 40.4 sigma : 1.41
Distance between dipole center and liquid	10.0 mm
Area scan resolution	dx=8mm/dy=8mm
Zoon Scan Resolution	dx=8mm/dy=8mm/dz=5mm
Frequency	1900 MHz
Input power	20 dBm
Liquid Temperature	21 °C
Lab Temperature	21 °C
Lab Humidity	45 %

Frequency MHz	1 g SAR (W/kg/W)		10 g SAR (W/kg/W)	
	required	measured	required	measured
300	2.85		1.94	
450	4.58		3.06	
750	8.49		5.55	
835	9.56		6.22	
900	10.9		6.99	
1450	29		16	
1500	30.5		16.8	
1640	34.2		18.4	
1750	36.4		19.3	
1800	38.4		20.1	





SAR REFERENCE DIPOLE CALIBRATION REPORT

Ref: ACR.139.7.15.SATU.A

1900	39.7	39.32 (3.93)	20.5	20.53 (2.05)
1950	40.5		20.9	
2000	41.1		21.1	
2100	43.6		21.9	
2300	48.7		23.3	
2450	52.4		24	
2600	55.3		24.6	
3000	63.8		25.7	
3500	67.1		25	

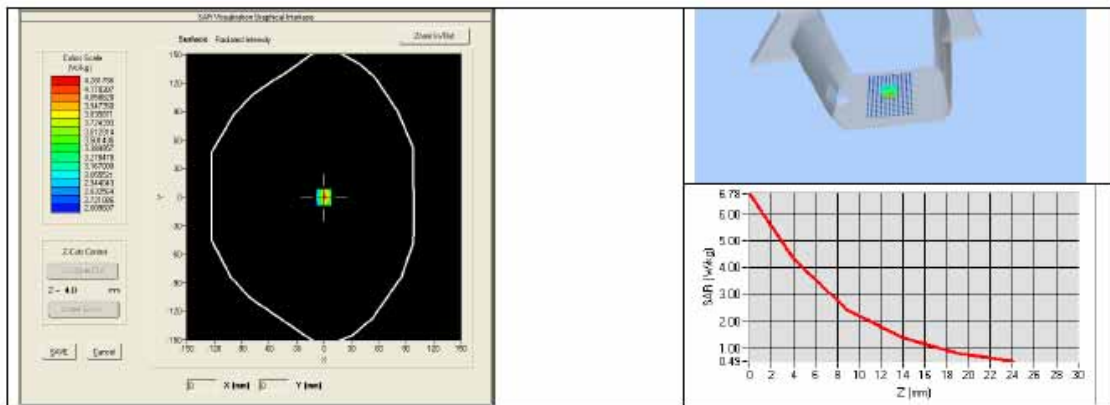

7.3 BODY LIQUID MEASUREMENT

Frequency MHz	Relative permittivity ( $\epsilon_r'$ )		Conductivity ( $\sigma$ ) S/m	
	required	measured	required	measured
150	61.9 ±5 %		0.80 ±5 %	
300	58.2 ±5 %		0.92 ±5 %	
450	56.7 ±5 %		0.94 ±5 %	
750	55.5 ±5 %		0.96 ±5 %	
835	55.2 ±5 %		0.97 ±5 %	
900	55.0 ±5 %		1.05 ±5 %	
915	55.0 ±5 %		1.06 ±5 %	
1450	54.0 ±5 %		1.30 ±5 %	
1610	53.8 ±5 %		1.40 ±5 %	
1800	53.3 ±5 %		1.52 ±5 %	
1900	53.3 ±5 %	PASS	1.52 ±5 %	PASS
2000	53.3 ±5 %		1.52 ±5 %	
2100	53.2 ±5 %		1.62 ±5 %	
2450	52.7 ±5 %		1.95 ±5 %	



SAR REFERENCE DIPOLE CALIBRATION REPORT

Ref. ACR.139.7.15.SATU.A

2600	52.5 ±5 %		2.16 ±5 %
3000	52.0 ±5 %		2.73 ±5 %
3500	51.3 ±5 %		3.31 ±5 %
5200	49.0 ±10 %		5.30 ±10 %
5300	48.9 ±10 %		5.42 ±10 %
5400	48.7 ±10 %		5.53 ±10 %
5500	48.6 ±10 %		5.65 ±10 %
5600	48.5 ±10 %		5.77 ±10 %
5800	48.2 ±10 %		6.00 ±10 %

7.4 SAR MEASUREMENT RESULT WITH BODY LIQUID

Software	OPENSAR V4
Phantom	SN 20/09 SAM71
Probe	SN 18/11 EPG122
Liquid	Body Liquid Values: $\epsilon_{ps}' : 53.9$ $\sigma$ : 1.55
Distance between dipole center and liquid	10.0 mm
Area scan resolution	$dx=8mm/dy=8mm$
Zoon Scan Resolution	$dx=8mm/dy=8mm/dz=5mm$
Frequency	1900 MHz
Input power	20 dBm
Liquid Temperature	21 °C
Lab Temperature	21 °C
Lab Humidity	45 %

Frequency MHz	1 g SAR (W/kg/W)	10 g SAR (W/kg/W)
	measured	measured
1900	38.43 (3.84)	20.34 (2.03)

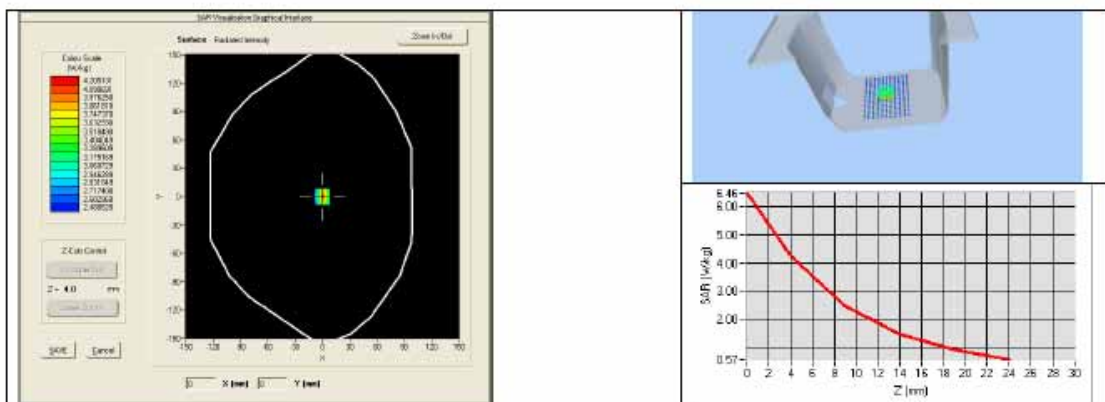





SAR REFERENCE DIPOLE CALIBRATION REPORT

Ref: ACR.139.7.15.SATU.A

**8 LIST OF EQUIPMENT**

Equipment Summary Sheet				
Equipment Description	Manufacturer / Model	Identification No.	Current Calibration Date	Next Calibration Date
SAM Phantom	MVG	SN-20/09-SAM71	Validated. No cal required.	Validated. No cal required.
COMOSAR Test Bench	Version 3	NA	Validated. No cal required.	Validated. No cal required.
Network Analyzer	Rhode & Schwarz ZVA	SN100132	02/2013	02/2016
Calipers	Carrera	CALIPER-01	12/2013	12/2016
Reference Probe	MVG	EPG122 SN 18/11	10/2014	10/2015
Multimeter	Keithley 2000	1188656	12/2013	12/2016
Signal Generator	Agilent E4438C	MY49070581	12/2013	12/2016
Amplifier	Aethercomm	SN 046	Characterized prior to test. No cal required.	Characterized prior to test. No cal required.
Power Meter	HP E4418A	US38261498	12/2013	12/2016
Power Sensor	HP ECP-E26A	US37181460	12/2013	12/2016
Directional Coupler	Narda 4216-20	01386	Characterized prior to test. No cal required.	Characterized prior to test. No cal required.
Temperature and Humidity Sensor	Control Company	11-661-9	8/2012	8/2015



## SAR Reference Dipole Calibration Report

Ref : ACR.139.9.15.SATU.A

**NTEK TESTING TECHNOLOGY CO., LTD.**  
**BUILDING E, FENDA SCIENCE PARK, SANWEI**  
**COMMUNITY, XIXIANG STREET,**  
**BAO'AN DISTRICT, SHENZHEN GUANGDONG, CHINA**  
**MVG COMOSAR REFERENCE DIPOLE**  
**FREQUENCY: 2450 MHZ**  
**SERIAL NO.: SN 03/15 DIP 2G450-352**

**Calibrated at MVG US**  
2105 Barrett Park Dr. - Kennesaw, GA 30144



**04/06/2015**

*Summary:*

This document presents the method and results from an accredited SAR reference dipole calibration performed in MVG USA using the COMOSAR test bench. All calibration results are traceable to national metrology institutions.



SAR REFERENCE DIPOLE CALIBRATION REPORT

Ref: ACR.139.9.15.SATU.A

	<i>Name</i>	<i>Function</i>	<i>Date</i>	<i>Signature</i>
<i>Prepared by :</i>	Jérôme LUC	Product Manager	5/19/2015	<i>JLS</i>
<i>Checked by :</i>	Jérôme LUC	Product Manager	5/19/2015	<i>JLS</i>
<i>Approved by :</i>	Kim RUTKOWSKI	Quality Manager	5/19/2015	<i>Kim Rutkowski</i>

	<i>Customer Name</i>
<i>Distribution :</i>	NTEK TESTING TECHNOLOGY CO., LTD.

<i>Issue</i>	<i>Date</i>	<i>Modifications</i>
A	5/19/2015	Initial release



## TABLE OF CONTENTS

1	Introduction.....	4
2	Device Under Test.....	4
3	Product Description.....	4
3.1	General Information.....	4
4	Measurement Method.....	5
4.1	Return Loss Requirements.....	5
4.2	Mechanical Requirements.....	5
5	Measurement Uncertainty.....	5
5.1	Return Loss.....	5
5.2	Dimension Measurement.....	5
5.3	Validation Measurement.....	5
6	Calibration Measurement Results.....	6
6.1	Return Loss and Impedance In Head Liquid.....	6
6.2	Return Loss and Impedance In Body Liquid.....	6
6.3	Mechanical Dimensions.....	6
7	Validation measurement.....	7
7.1	Head Liquid Measurement.....	7
7.2	SAR Measurement Result With Head Liquid.....	8
7.3	Body Liquid Measurement.....	9
7.4	SAR Measurement Result With Body Liquid.....	10
8	List of Equipment.....	11



SAR REFERENCE DIPOLE CALIBRATION REPORT

Ref: ACR.139.9.15.SATU.A

**1 INTRODUCTION**

This document contains a summary of the requirements set forth by the IEEE 1528, FCC KDBs and CEI/IEC 62209 standards for reference dipoles used for SAR measurement system validations and the measurements that were performed to verify that the product complies with the fore mentioned standards.

**2 DEVICE UNDER TEST**

Device Under Test	
Device Type	COMOSAR 2450 MHz REFERENCE DIPOLE
Manufacturer	MVG
Model	SID2450
Serial Number	SN 03/15 DIP 2G450-352
Product Condition (new / used)	New

A yearly calibration interval is recommended.

**3 PRODUCT DESCRIPTION**

**3.1 GENERAL INFORMATION**

MVG’s COMOSAR Validation Dipoles are built in accordance to the IEEE 1528, FCC KDBs and CEI/IEC 62209 standards. The product is designed for use with the COMOSAR test bench only.



**Figure 1 – MVG COMOSAR Validation Dipole**





**4 MEASUREMENT METHOD**

The IEEE 1528, FCC KDBs and CEI/IEC 62209 standards provide requirements for reference dipoles used for system validation measurements. The following measurements were performed to verify that the product complies with the fore mentioned standards.

**4.1 RETURN LOSS REQUIREMENTS**

The dipole used for SAR system validation measurements and checks must have a return loss of -20 dB or better. The return loss measurement shall be performed against a liquid filled flat phantom, with the phantom constructed as outlined in the fore mentioned standards.

**4.2 MECHANICAL REQUIREMENTS**

The IEEE Std. 1528 and CEI/IEC 62209 standards specify the mechanical components and dimensions of the validation dipoles, with the dimensions frequency and phantom shell thickness dependent. The COMOSAR test bench employs a 2 mm phantom shell thickness therefore the dipoles sold for use with the COMOSAR test bench comply with the requirements set forth for a 2 mm phantom shell thickness.

**5 MEASUREMENT UNCERTAINTY**

All uncertainties listed below represent an expanded uncertainty expressed at approximately the 95% confidence level using a coverage factor of k=2, traceable to the Internationally Accepted Guides to Measurement Uncertainty.

**5.1 RETURN LOSS**

The following uncertainties apply to the return loss measurement:

Frequency band	Expanded Uncertainty on Return Loss
400-6000MHz	0.1 dB

**5.2 DIMENSION MEASUREMENT**

The following uncertainties apply to the dimension measurements:

Length (mm)	Expanded Uncertainty on Length
3 - 300	0.05 mm

**5.3 VALIDATION MEASUREMENT**

The guidelines outlined in the IEEE 1528, FCC KDBs, CENELEC EN50361 and CEI/IEC 62209 standards were followed to generate the measurement uncertainty for validation measurements.

Scan Volume	Expanded Uncertainty
1 g	20.3 %



SAR REFERENCE DIPOLE CALIBRATION REPORT

Ref: ACR.139.9.15.SATU.A

10 g	20.1 %
------	--------

6 CALIBRATION MEASUREMENT RESULTS

6.1 RETURN LOSS AND IMPEDANCE IN HEAD LIQUID

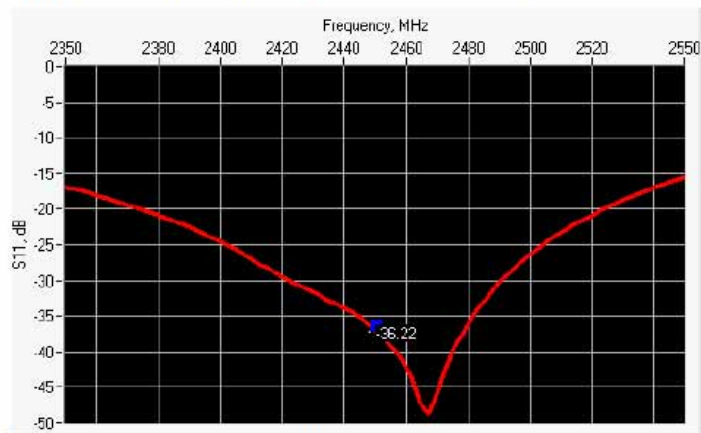

Frequency (MHz)	Return Loss (dB)	Requirement (dB)	Impedance
2450	-36.22	-20	48.9 Ω + 1.1 jΩ

6.2 RETURN LOSS AND IMPEDANCE IN BODY LIQUID

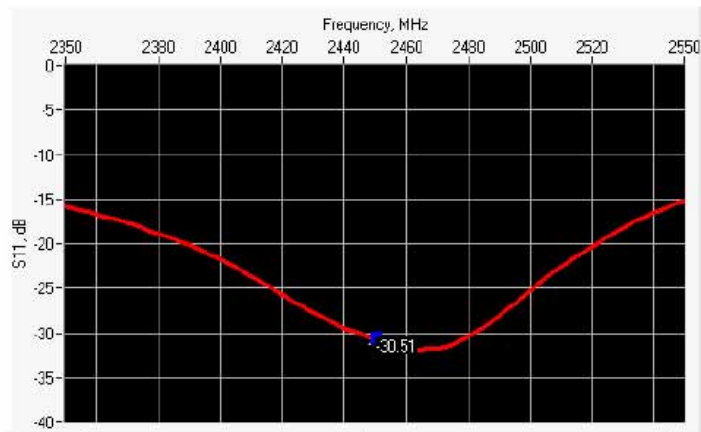

Frequency (MHz)	Return Loss (dB)	Requirement (dB)	Impedance
2450	-30.51	-20	52.2 Ω + 2.0 jΩ

6.3 MECHANICAL DIMENSIONS

Frequency MHz	L mm		h mm		d mm	
	required	measured	required	measured	required	measured
300	420.0 ±1 %		250.0 ±1 %		6.35 ±1 %	



SAR REFERENCE DIPOLE CALIBRATION REPORT

Ref. ACR.139.9.15.SATU.A

450	290.0 ±1 %.		166.7 ±1 %.		6.35 ±1 %.	
750	176.0 ±1 %.		100.0 ±1 %.		6.35 ±1 %.	
835	161.0 ±1 %.		89.8 ±1 %.		3.6 ±1 %.	
900	149.0 ±1 %.		83.3 ±1 %.		3.6 ±1 %.	
1450	89.1 ±1 %.		51.7 ±1 %.		3.6 ±1 %.	
1500	80.5 ±1 %.		50.0 ±1 %.		3.6 ±1 %.	
1640	79.0 ±1 %.		45.7 ±1 %.		3.6 ±1 %.	
1750	75.2 ±1 %.		42.9 ±1 %.		3.6 ±1 %.	
1800	72.0 ±1 %.		41.7 ±1 %.		3.6 ±1 %.	
1900	68.0 ±1 %.		39.5 ±1 %.		3.6 ±1 %.	
1950	66.3 ±1 %.		38.5 ±1 %.		3.6 ±1 %.	
2000	64.5 ±1 %.		37.5 ±1 %.		3.6 ±1 %.	
2100	61.0 ±1 %.		35.7 ±1 %.		3.6 ±1 %.	
2300	55.5 ±1 %.		32.6 ±1 %.		3.6 ±1 %.	
2450	51.5 ±1 %.	PASS	30.4 ±1 %.	PASS	3.6 ±1 %.	PASS
2600	48.5 ±1 %.		28.8 ±1 %.		3.6 ±1 %.	
3000	41.5 ±1 %.		25.0 ±1 %.		3.6 ±1 %.	
3500	37.0±1 %.		26.4 ±1 %.		3.6 ±1 %.	
3700	34.7±1 %.		26.4 ±1 %.		3.6 ±1 %.	

7 VALIDATION MEASUREMENT

The IEEE Std. 1528, FCC KDBs and CEI/IEC 62209 standards state that the system validation measurements must be performed using a reference dipole meeting the fore mentioned return loss and mechanical dimension requirements. The validation measurement must be performed against a liquid filled flat phantom, with the phantom constructed as outlined in the fore mentioned standards. Per the standards, the dipole shall be positioned below the bottom of the phantom, with the dipole length centered and parallel to the longest dimension of the flat phantom, with the top surface of the dipole at the described distance from the bottom surface of the phantom.

7.1 HEAD LIQUID MEASUREMENT

Frequency MHz	Relative permittivity (ε <sub>r</sub> )		Conductivity (σ) S/m	
	required	measured	required	measured
300	45.3 ±5 %		0.87 ±5 %	
450	43.5 ±5 %		0.87 ±5 %	
750	41.9 ±5 %		0.89 ±5 %	
835	41.5 ±5 %		0.90 ±5 %	
900	41.5 ±5 %		0.97 ±5 %	
1450	40.5 ±5 %		1.20 ±5 %	
1500	40.4 ±5 %		1.23 ±5 %	
1640	40.2 ±5 %		1.31 ±5 %	
1750	40.1 ±5 %		1.37 ±5 %	





**SAR REFERENCE DIPOLE CALIBRATION REPORT**

Ref: ACR.139.9.15.SATU.A

1800	40.0 ±5 %		1.40 ±5 %	
1900	40.0 ±5 %		1.40 ±5 %	
1950	40.0 ±5 %		1.40 ±5 %	
2000	40.0 ±5 %		1.40 ±5 %	
2100	39.8 ±5 %		1.49 ±5 %	
2300	39.5 ±5 %		1.67 ±5 %	
2450	39.2 ±5 %	PASS	1.80 ±5 %	PASS
2600	39.0 ±5 %		1.96 ±5 %	
3000	38.5 ±5 %		2.40 ±5 %	
3500	37.9 ±5 %		2.91 ±5 %	

**7.2 SAR MEASUREMENT RESULT WITH HEAD LIQUID**

The IEEE Std. 1528 and CEI/IEC 62209 standards state that the system validation measurements should produce the SAR values shown below (for phantom thickness of 2 mm), within the uncertainty for the system validation. All SAR values are normalized to 1 W forward power. In bracket, the measured SAR is given with the used input power.

Software	OPENSAR V4
Phantom	SN 20/09 SAM71
Probe	SN 18/11 EPG122
Liquid	Head Liquid Values: eps' : 38.3 sigma : 1.80
Distance between dipole center and liquid	10.0 mm
Area scan resolution	dx=8mm/dy=8mm
Zoon Scan Resolution	dx=5mm/dy=5mm/dz=5mm
Frequency	2450 MHz
Input power	20 dBm
Liquid Temperature	21 °C
Lab Temperature	21 °C
Lab Humidity	45 %

Frequency MHz	1 g SAR (W/kg/W)		10 g SAR (W/kg/W)	
	required	measured	required	measured
300	2.85		1.94	
450	4.58		3.06	
750	8.49		5.55	
835	9.56		6.22	
900	10.9		6.99	
1450	29		16	
1500	30.5		16.8	
1640	34.2		18.4	
1750	36.4		19.3	
1800	38.4		20.1	



SAR REFERENCE DIPOLE CALIBRATION REPORT

Ref. ACR.139.9.15.SATU.A

1900	39.7		20.5	
1950	40.5		20.9	
2000	41.1		21.1	
2100	43.6		21.9	
2300	48.7		23.3	
2450	52.4	52.28 (5.23)	24	23.80 (2.38)
2600	55.3		24.6	
3000	63.8		25.7	
3500	67.1		25	

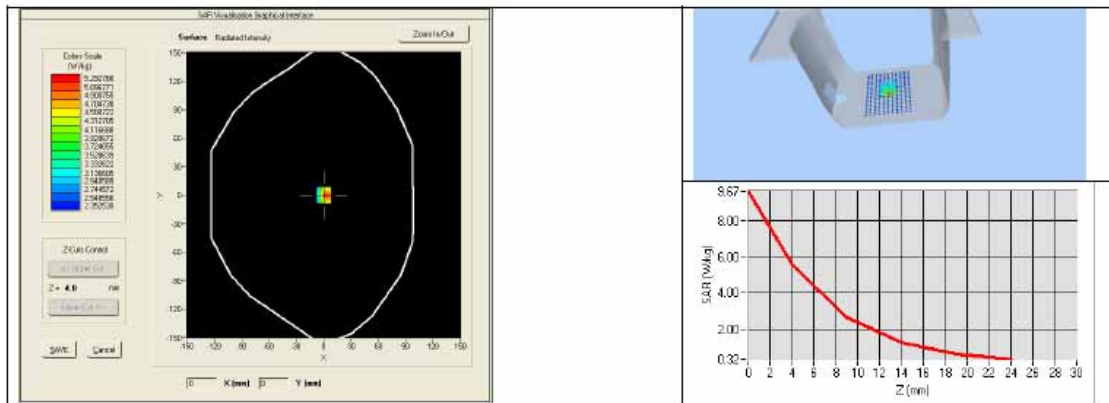

7.3 BODY LIQUID MEASUREMENT

Frequency MHz	Relative permittivity ( $\epsilon_r'$ )		Conductivity ( $\sigma$ ) S/m	
	required	measured	required	measured
150	61.9 ±5 %		0.80 ±5 %	
300	58.2 ±5 %		0.92 ±5 %	
450	56.7 ±5 %		0.94 ±5 %	
750	55.5 ±5 %		0.96 ±5 %	
835	55.2 ±5 %		0.97 ±5 %	
900	55.0 ±5 %		1.05 ±5 %	
915	55.0 ±5 %		1.06 ±5 %	
1450	54.0 ±5 %		1.30 ±5 %	
1610	53.8 ±5 %		1.40 ±5 %	
1800	53.3 ±5 %		1.52 ±5 %	
1900	53.3 ±5 %		1.52 ±5 %	
2000	53.3 ±5 %		1.52 ±5 %	
2100	53.2 ±5 %		1.62 ±5 %	
2450	52.7 ±5 %	PASS	1.95 ±5 %	PASS



SAR REFERENCE DIPOLE CALIBRATION REPORT

Ref: ACR.139.9.15.SATU.A

2600	52.5 ±5 %		2.16 ±5 %	
3000	52.0 ±5 %		2.73 ±5 %	
3500	51.3 ±5 %		3.31 ±5 %	
5200	49.0 ±10 %		5.30 ±10 %	
5300	48.9 ±10 %		5.42 ±10 %	
5400	48.7 ±10 %		5.53 ±10 %	
5500	48.6 ±10 %		5.65 ±10 %	
5600	48.5 ±10 %		5.77 ±10 %	
5800	48.2 ±10 %		6.00 ±10 %	

7.4 SAR MEASUREMENT RESULT WITH BODY LIQUID

Software	OPENSAR V4
Phantom	SN 20/09 SAM71
Probe	SN 18/11 EPG122
Liquid	Body Liquid Values: eps' : 52.7 sigma : 1.94
Distance between dipole center and liquid	10.0 mm
Area scan resolution	dx=8mm/dy=8mm
Zoon Scan Resolution	dx=5mm/dy=5mm/dz=5mm
Frequency	2450 MHz
Input power	20 dBm
Liquid Temperature	21 °C
Lab Temperature	21 °C
Lab Humidity	45 %

Frequency MHz	1 g SAR (W/kg/W)	10 g SAR (W/kg/W)
	measured	measured
2450	49.32 (4.93)	22.89 (2.29)

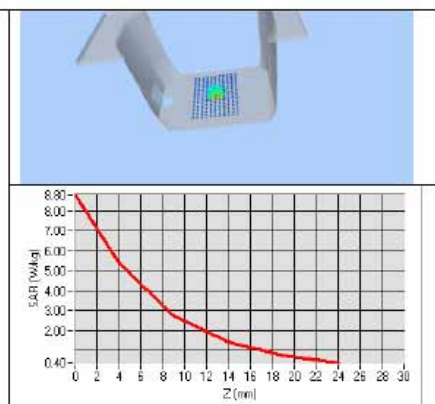
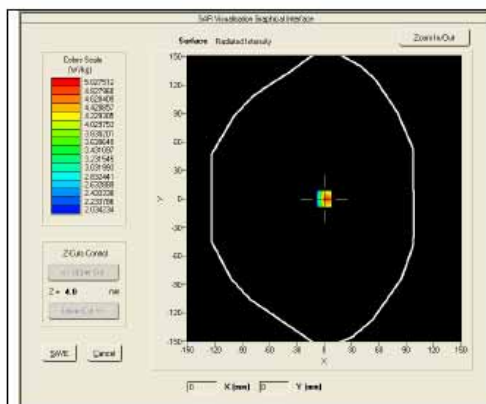



SAR REFERENCE DIPOLE CALIBRATION REPORT

Ref: ACR.139.9.15.SATU.A

8 LIST OF EQUIPMENT

Equipment Summary Sheet				
Equipment Description	Manufacturer / Model	Identification No.	Current Calibration Date	Next Calibration Date
SAM Phantom	MVG	SN-20/09-SAM71	Validated. No cal required.	Validated. No cal required.
COMOSAR Test Bench	Version 3	NA	Validated. No cal required.	Validated. No cal required.
Network Analyzer	Rhode & Schwarz ZVA	SN100132	02/2013	02/2016
Calipers	Carrera	CALIPER-01	12/2013	12/2016
Reference Probe	MVG	EPG122 SN 18/11	10/2014	10/2015
Multimeter	Keithley 2000	1188656	12/2013	12/2016
Signal Generator	Agilent E4438C	MY49070581	12/2013	12/2016
Amplifier	Aethercomm	SN 046	Characterized prior to test. No cal required.	Characterized prior to test. No cal required.
Power Meter	HP E4418A	US38261498	12/2013	12/2016
Power Sensor	HP ECP-E26A	US37181460	12/2013	12/2016
Directional Coupler	Narda 4216-20	01386	Characterized prior to test. No cal required.	Characterized prior to test. No cal required.
Temperature and Humidity Sensor	Control Company	11-661-9	8/2012	8/2015



**<Justification of the extended calibration>**

If dipoles are verified in return loss(<-20dB, within 20% of prior calibration),and in impedance (within 5 ohm of prior calibration), the annual calibration is not necessary and the calibration interval can be extended.

**<Head 835MHz>**

Return Loss (dB)	Delta (%)	Impedance	Delta(ohm)	Date of Measurement
-30.94	-	52.6	-	Apr. 06, 2015
-30.947	0.023	52.615	0.015	Apr. 05, 2016

The return loss is <-20dB, within 20% of prior calibration; the impedance is within 5 ohm of prior calibration. Therefore the verification result should support extended calibration.

Dipole Verification Data

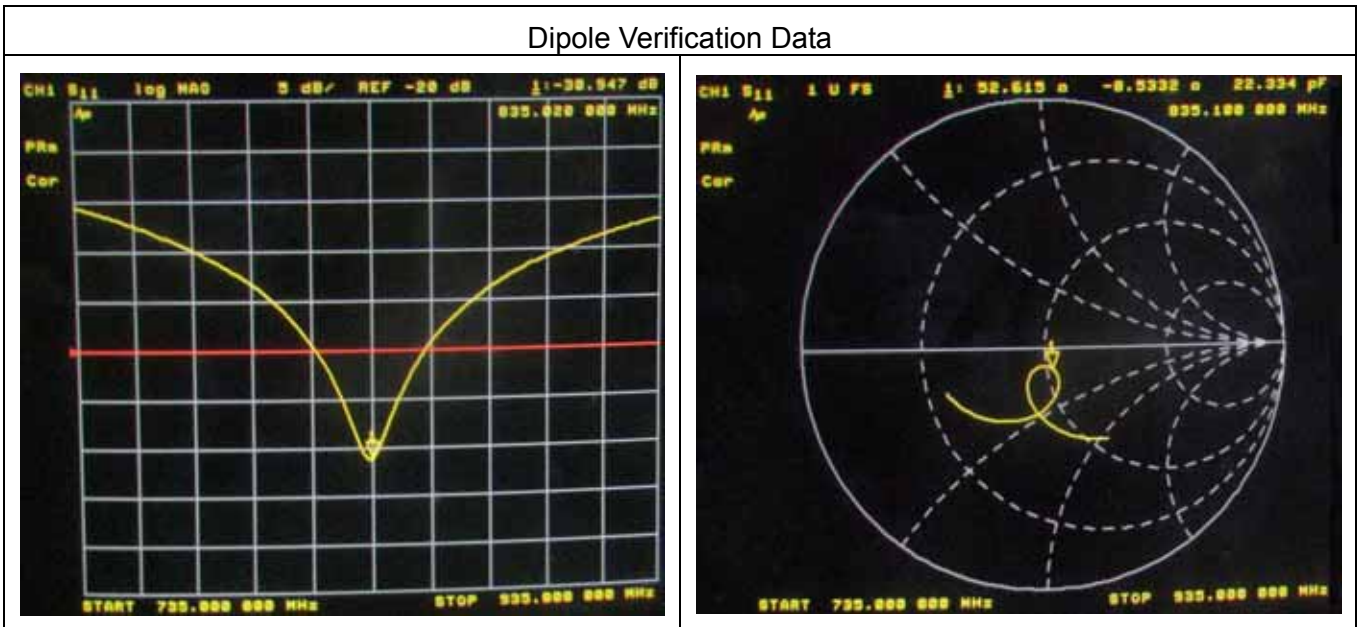

<Body 835MHz>

Return Loss (dB)	Delta (%)	Impedance	Delta(ohm)	Date of Measurement
-25.76	-	47.7	-	Apr. 06, 2015
-25.789	0.113	47.734	0.034	Apr. 05, 2016

The return loss is <-20dB, within 20% of prior calibration; the impedance is within 5 ohm of prior calibration. Therefore the verification result should support extended calibration.

Dipole Verification Data

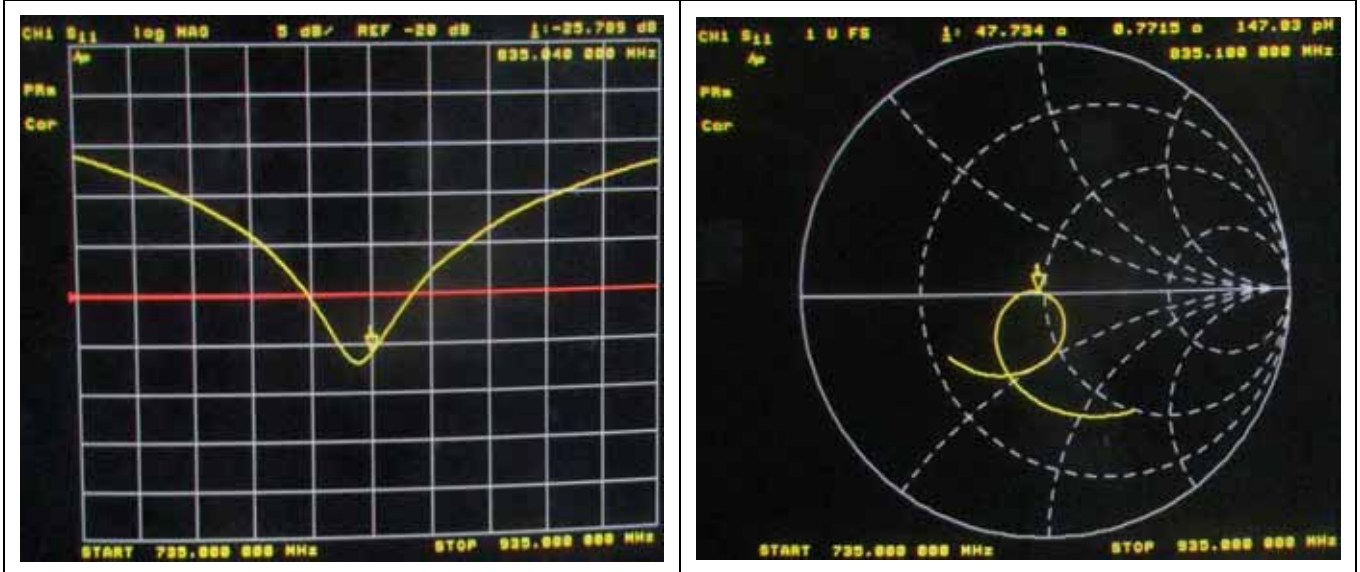

<Head 1900MHz>

Return Loss (dB)	Delta (%)	Impedance	Delta(ohm)	Date of Measurement
-23.14	-	53.6	-	Apr. 06, 2015
-23.144	0.017	53.604	0.004	Apr. 05, 2016

The return loss is <-20dB, within 20% of prior calibration; the impedance is within 5 ohm of prior calibration. Therefore the verification result should support extended calibration.

Dipole Verification Data

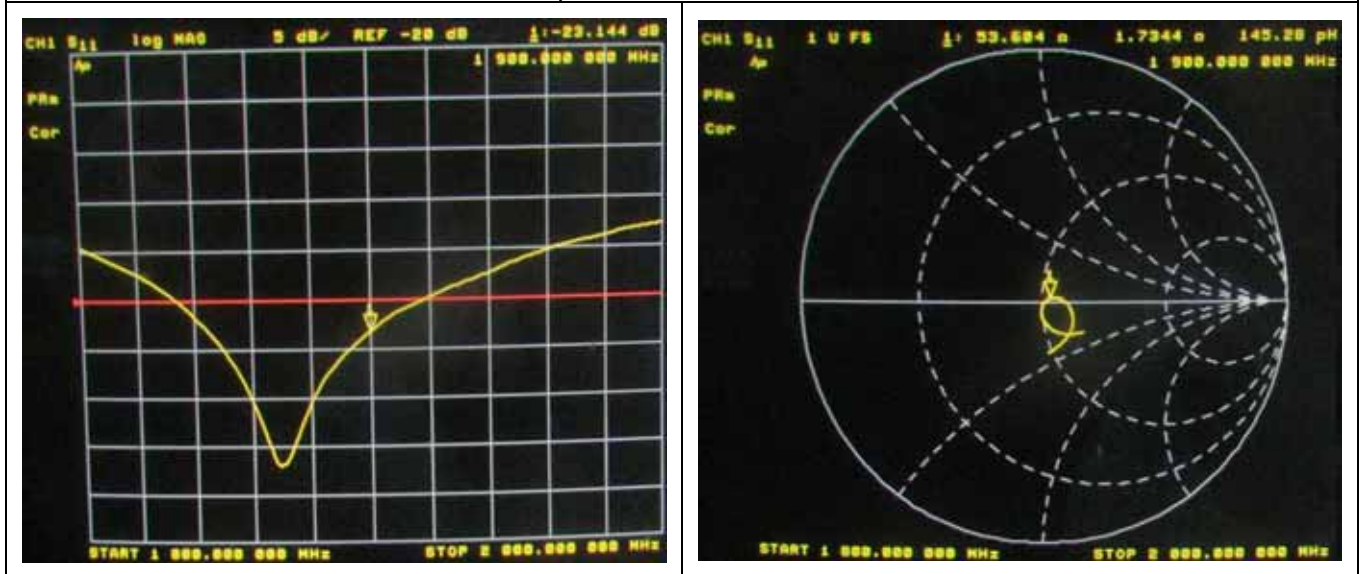

<Body 1900MHz>

Return Loss (dB)	Delta (%)	Impedance	Delta(ohm)	Date of Measurement
-22.68	-	49.3	-	Apr. 06, 2015
-22.679	0.004	49.311	0.011	Apr. 05, 2016

The return loss is <-20dB, within 20% of prior calibration; the impedance is within 5 ohm of prior calibration. Therefore the verification result should support extended calibration.

Dipole Verification Data

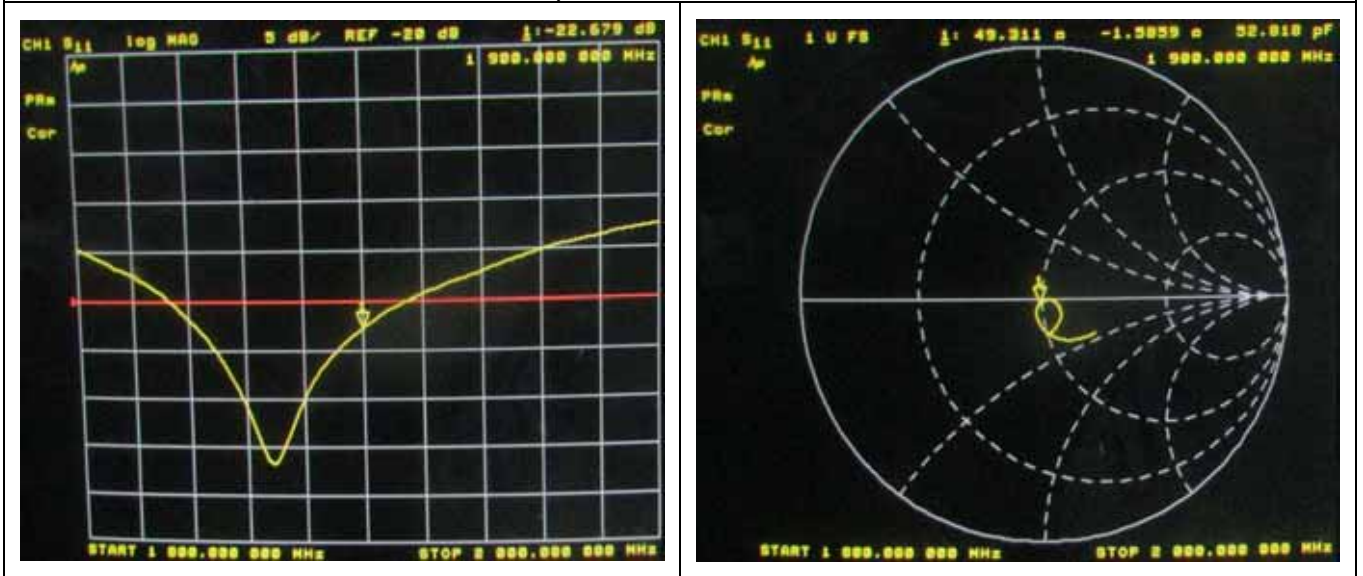



<Head 2450MHz>

Return Loss (dB)	Delta (%)	Impedance	Delta(ohm)	Date of Measurement
-36.22	-	48.9	-	Apr. 06, 2015
-36.296	0.21	48.99	0.09	Apr. 05, 2016

The return loss is <-20dB, within 20% of prior calibration; the impedance is within 5 ohm of prior calibration. Therefore the verification result should support extended calibration.

Dipole Verification Data

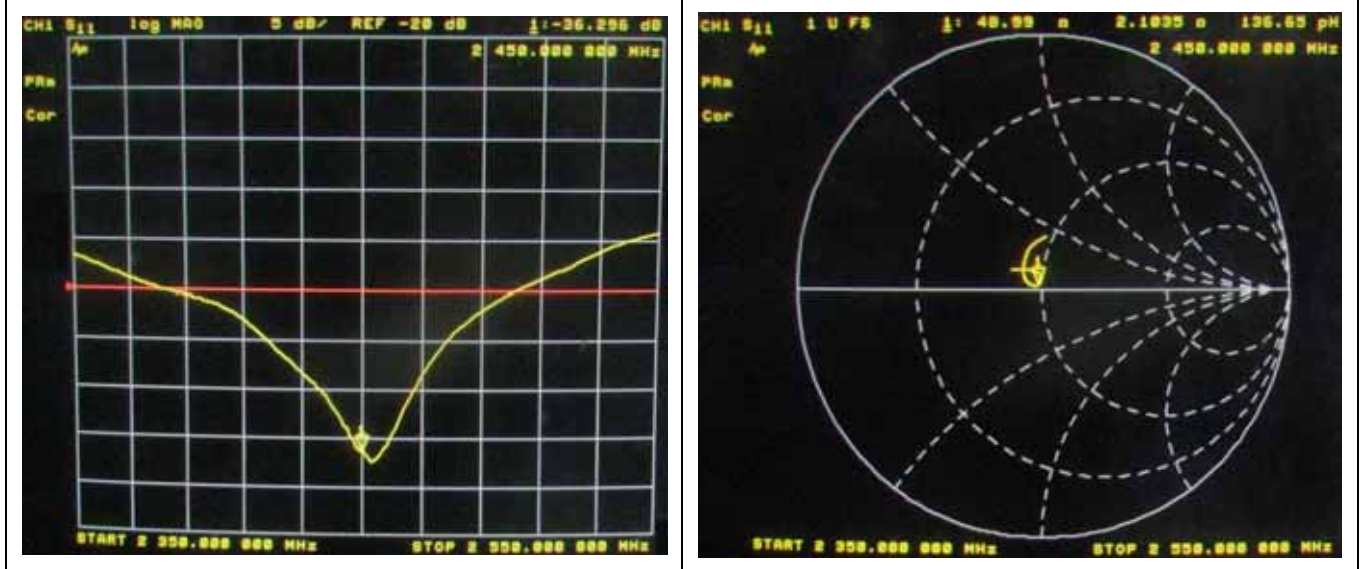

<Body 2450MHz>

Return Loss (dB)	Delta (%)	Impedance	Delta(ohm)	Date of Measurement
-30.51	-	52.2	-	Apr. 06, 2015
-30.498	0.039	52.16	0.04	Apr. 05, 2016

The return loss is <-20dB, within 20% of prior calibration; the impedance is within 5 ohm of prior calibration. Therefore the verification result should support extended calibration.

Dipole Verification Data

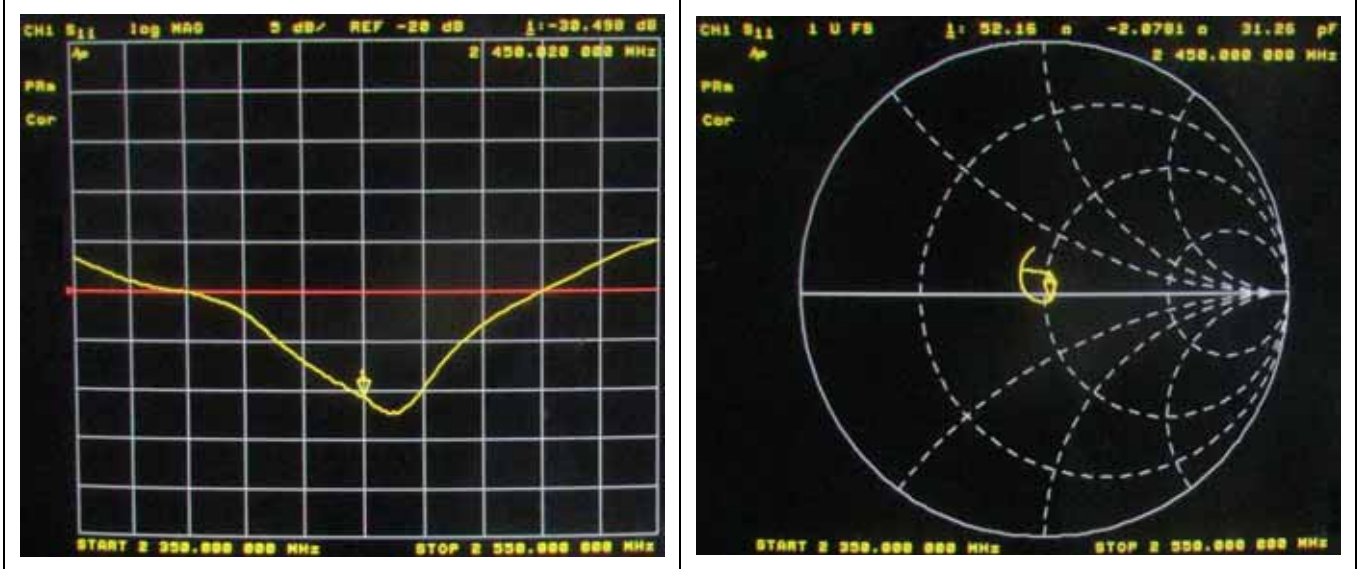

END