



TELEMATICS  
MOBILE INFORMATION EXCHANGE

## MiX 6000 LTE Installation Guide



## Table of Contents

1	Introduction .....	4
1.1	MiX 6000 Hardware Features .....	4
2	Product Variants and Part Numbers .....	5
2.1	MiX 6000 Power Requirements .....	7
3	Safety - read before installation .....	7
3.1	Installer Requirements .....	7
3.2	Tools .....	7
3.3	Secure the workplace .....	7
3.4	ESD - Installation Handling Precautions .....	8
4	Sim Card .....	8
4.1	Preparing the SIM card .....	8
4.2	Inserting the SIM card .....	8
4.3	Configuration of unit .....	11
5	Installation .....	11
5.1	Installation Steps .....	11
5.2	Installation Precautions .....	11
5.3	Positioning of product components .....	12
5.4	General Wiring Requirements .....	12
5.5	Harnesses and connectors .....	14
5.5.1	Harness Part Numbers .....	15
5.5.2	Main Harness .....	15
5.5.3	Auxiliary Harness AUX .....	16
5.5.4	Code Plug Harness CP4 .....	17
5.5.5	Serial Harness SR1 .....	17
5.5.6	Mix 6000 Serial Harness 2 (use Serial Harness SR1) .....	19
5.5.7	Mix 6000 Serial Harness 3 (use Serial Harness SR1) .....	19
5.5.8	Mix 6000 Serial Harness 4 (use Serial Harness SR1) .....	20
5.5.9	MODEM, GNSS and WiFi-BT Antennas .....	20
5.5.10	GNSS antenna connection .....	21
5.5.11	MODEM antenna connection .....	21
6	Positioning the MiX 6000 Unit in the vehicle .....	22
7	Starter Interrupt .....	23
8	Code Plug Socket Installation .....	25
9	Signal Inputs .....	26
9.1	Digital Inputs .....	26
9.2	Ignition Input .....	27
10	Power Outputs .....	28
10.1	Positive Drive .....	28
11	Serial Communication .....	29
12	CAN .....	29
12.1	Overview .....	29
12.1.1	Tools and Inspection needed for CAN Installation: .....	29
12.1.2	Wire lengths .....	30
12.1.3	CAN Termination and Transmissions .....	30
12.2	DLD and DTCO .....	30
12.2.1	D-8 .....	30
12.2.2	Connect CAN to DTCO .....	31
12.2.3	K-line .....	31
13	MiX TechTool .....	31
14	WiFi Installation .....	31
15	After Installation .....	32
15.1	Beep codes .....	32
15.2	LED flash codes .....	32
15.3	GNSS LED flash codes (GREEN) (LED 3 - Right) .....	33

15.4	MODEM LED flash codes (RED) (LED 2 - Middle)	33
15.5	Power Indicator (LED 1 – Left)	34
16	Testing Installation	34
16.1	Test Drive	34
17	Closing Steps	34
18	Routine Maintenance	36
19	MiX 6000 Specifications	36
19.1	Technical description	36
19.2	Auxiliary inputs/outputs	36
20	Regulatory and Environmental Considerations	37
21	Appendix A: Mounting of unit	38
22	Glossary	40

# 1 Introduction

The MiX 6000 LTE is a high-end fleet management on-board computer that incorporates the latest market trends.



## 1.1 MiX 6000 Hardware Features








Digital/Analog Inputs	Up to 8 different digital or, alternatively, analogue inputs can be configured to monitor any device that generates a change in voltage, e.g. seat belts, headlights, refrigeration units, temperature sensors, emergency lights, doors, PTO, UDS, trailer coupling etc. Disconnection of these inputs can be detected using open-wire detect. Two of the frequency inputs can be reconfigured to provide 2 x additional analog inputs so that a total of 10 x analog inputs are available)
Frequency Inputs	Up to 4 x frequency/pulse inputs for integration with legacy sensors exist. Two of the frequency inputs can be reconfigured to provide an additional 2 x analog inputs, so that a total of 2 x frequency inputs and 10 x analog inputs are available.
Tacho Inputs	It is possible to configure any of the 12 existing inputs listed above (Digital/Analogue and Frequency) as tacho inputs
Ignition input	Used to monitor the ignition switch status. Maximum 36V input, impedance > 100kΩ. The unit is able to detect when the Ignition gets connected or disconnected. Disconnection of this input can be detected with open-wire detect.
CAN	The system has 2 x CAN (FD compatible) inputs that support J1939 and OBDII CAN. Transmit is under software control and CAN ports are high impedance with no 120 Ohm terminating resistor.
GNSS	GPS and GLONASS available.
Modem	LTE Cat 4 with 3G/2G fallback
Serial Ports	4x RS232 serial ports Serial port #1 is also capable of J1708 (9600 bps) or RS-485 (Baud rate up to 1Mbit/s over a maximum cable length of 100m)
K-line and D8	K-line interface for Digital Tachograph (DTCO D8 input)
Bluetooth	Support up to Bluetooth V4.2 and BLE.
WiFi	WiFi Module Support IEEE Std 802.11 b/g/n
Accelerometer	3-axis ±2 g/ ±4 g / ±8 g / ±16 g dynamically selectable full-scale and is capable of measuring acceleration with output data rates from 1 Hz to 5.3 kHz
Dead reckoning	Dead reckoning allows navigation to commence as soon as power is applied to the module (i.e. before GNSS fix has been established) and given the following conditions: a) The vehicle has not moved without power applied to the module

	<p>b) At least a dead-reckoning fix was available when the vehicle was last used</p> <p>c) A back-up supply has been available for the module since the vehicle was last used.</p>
Positive drive	8 x Positive drive with open-load detect and current sense diagnostics, with 250mA current limit per drive
Tamper detection	A tamper switch detects when the covers are removed. Shorting, cutting, or unplugging any of the external antennas will also be detected.
Code Plug	Standard code plug circuit (Optional: 5V aux output, 150 mA max)
Internal backup battery	An internal battery provides power up to 10 hours if the supply from the vehicle's battery is removed.
Buzzer and LED	A Buzzer is available to warn the driver and to provide feedback of the vehicle's status. 3 x LEDs provide feedback on the status of the unit.
RF Transceiver	434 or 915 MHz RF transceiver
RTC	Real time clock with coin-cell battery.
SIM	Dual Nano
Antennae	External LTE, GNSS, MagiX and WiFi/BT antennae

## 2 Product Variants and Part Numbers

The following product variants are available:

Part Number	Picture	Product Name	Required/Optional	Description
U0042MT		MiX 6AMB-4G	Region specific	MiX 6000 MK2 6AMB-4G Electronic Unit
U0043MT		MiX 6AMB-4G Kit	Region specific	MiX 6000 MK2 6AMB-4G Electronic Unit with kit accessory parts (440FT0032, 440FT0033, A0049MT and A0050MT).
U0044MT		MiX 6AMB-4G-B	Region specific	MiX 6000 MK2 6AMB-4G-B Electronic Unit with Backup Battery.
U0045MT		MiX 6AMB-4G-B Kit	Region specific	MiX 6000 MK2 6AMB-4G-B Electronic Unit with Backup Battery and kit accessory parts (440FT0032, 440FT0033, A0049MT and A0050MT)

Part Number	Picture	Product Name	Required/Optional	Description
440FT0033		Main Harness MP10	Required (included in kit)	Main Harness (Power, Ignition, Ground, Relay Socket, Buzzer, CAN Connector, 5V, 2xInput, Positive Drive) with Rovi connector.
440FT0032		Code Plug Harness with socket CP4	Required (included in kit)	Code Plug Harness with socket
A0049MT		External LTE antenna PA8 Fakra connector	Required (included in kit)	LTE Primary Antenna
A0049MT		PUCK Antenna	Required (included in kit)	PUCK Antenna, LTE Diversity, WiFi/Bluetooth and GNSS
A0041MT		Auxiliary Harness AX5	Optional	Provides access to all the other Relay Drives and Frequency Inputs.
440FT0931		Serial Harness SR1	Optional	(Up to 4) Serial Harness (RX, TX, CTS, RTS, GND, DSR-DTR looped, RS232 with DB9 Male Connector)
440FT0244		MiX 6000 Mounting Bracket	Optional	Mounting bracket with clips that can be fitted with screws. Note that these brackets are supplied as consumables in bulk bags of 50 items per bag and it is not part of any kit.

## 2.1 MiX 6000 Power Requirements

The MiX 6000 is designed for use in 12 V or 24 V vehicles. Special vehicles and working machines with voltages above 32 V will require a voltage converter to facilitate the required power supply input.

## 3 Safety - read before installation

### 3.1 Installer Requirements

- ❗ Installation should only be undertaken by a vehicle technician with comprehensive occupation specific knowledge. Installation by an unqualified technician may adversely affect the operating reliability of the vehicle and could endanger other road users.
- ❗ A basic knowledge of vehicle electrical and mechanical systems is required to successfully install the Fleet Manager system.
- ❗ The system should only be installed by a suitably qualified vehicle technician with a basic knowledge of the operation of computers.
- ❗ Installation technicians should attend a training course to acquire the skills needed for installation, configuration and operation of the Fleet Manager system.
- ❗ Installers should consult the vehicle manufacturer's documentation for the specific vehicle make and model prior to undertaking an installation.
- ❗ Installers should pay particular attention to the location of fuel systems, hydraulic systems, compressed air systems and other electrical and mechanical systems, which may have a bearing on the installation.
- ❗ Installers should pay attention to any changes to the vehicle's systems or settings, which should be noted prior to the installation.
- ❗ Installers should not smoke or make use of naked flames, which could cause a fire in or near the vehicle.

After installation, verify that no interference is caused to the vehicle's electrical system. Check dashboard warning lights and error messages. Should any error conditions exist, remove the installed unit and contact MiX Telematics for assistance.

### 3.2 Tools

- Standard technical equipment and appropriate tools for use with vehicles are required to install the MiX 6000.
- Vehicle specific tools may be required for the removal of consoles and covers.
- Supporting tools:
  - Multi-meter

### 3.3 Secure the workplace

- Remove the ignition key from the vehicle's ignition lock.
- Ensure that the vehicle's engine cannot be unintentionally started during the installation.
- Short-circuiting the vehicle's electrical system may result in fire, explosion of the battery and/or damage to other electrical systems.
- Electrical shock from high voltage batteries must be avoided, as this may lead to death or injury.

### 3.4 ESD - Installation Handling Precautions

Prior to touching the PCB, inserting a new SIM or replacing the battery, always take ESD precautions:

- Either use an earthed wrist strap or touch a known earth point (or negative potential in the vehicle) prior to handling the unit.
- If the PCB must be handled, avoid direct contact with any of the components and handle it by only touching the edges of the PCB.

## 4 Sim Card

### 4.1 Preparing the SIM card

The two SIM card slots are at the back of the unit. One must first remove the back cover as described in the steps below.

Before inserting the SIM card, determine if the SIM needs to be secured with a unique PIN.

If a PIN secured SIM is required:

- Ensure that the SIM is configured as “PIN required”.
- Ensure that the PIN is set as either 0000 or 00000.
- The MiX 6000 will change the PIN to a unique number that it calculates for the device.
- The SIM is then locked to the device and the PUK will be locked if inserted into another device.

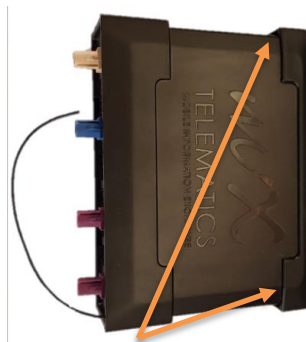
If an unsecured SIM is required:

- Ensure that the SIM is configured as “PIN not required”.
- The MiX 6000 will leave the SIM with this configuration.
- This SIM can be moved to a different device without risk of the PUK begin locked.

### 4.2 Inserting the SIM card

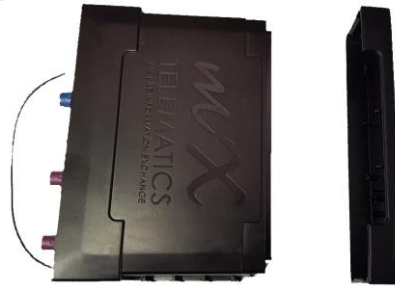
In order to insert the SIM card, the following steps must be followed:

- The SIM card is accessible from the back panel. Insert the SIM card as indicated below.

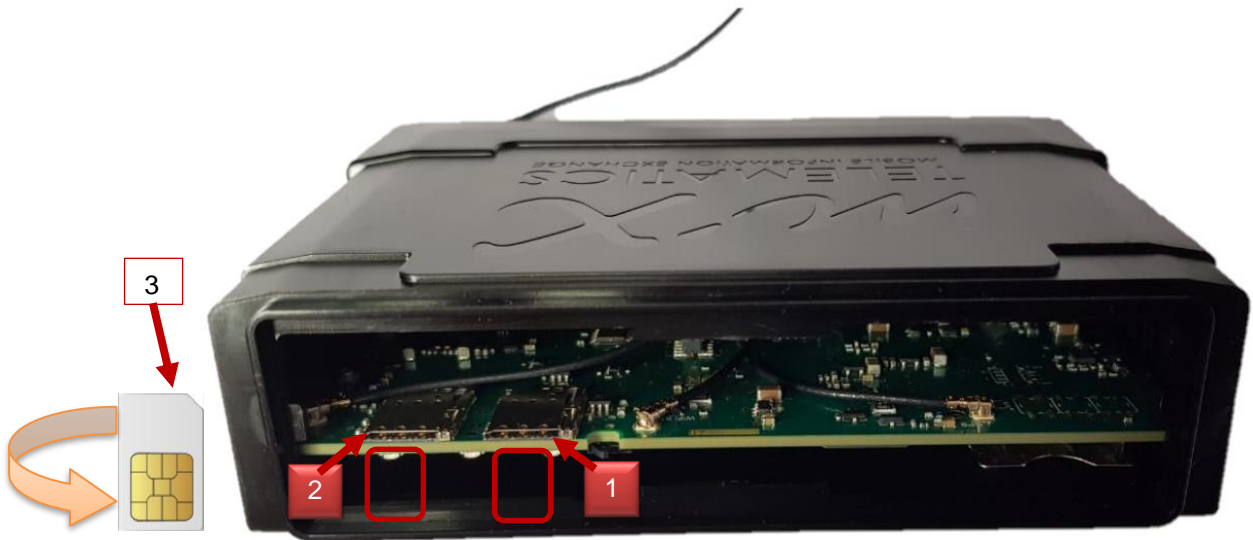


**Figure 1: Opening of side clips**





**Figure 2: Unhook the cover**



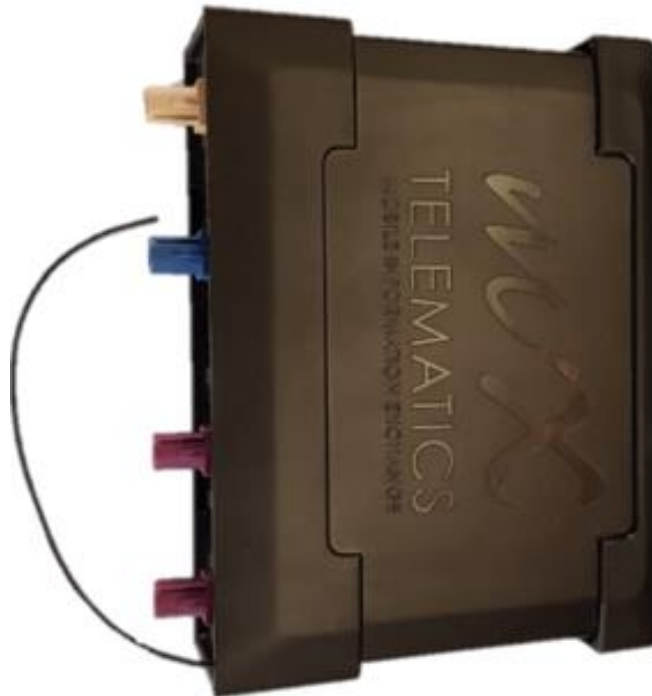
**Figure 3: Position the SIM as shown on the unit**

Note the orientation must be as shown above on Figure 3:

- Arrow “1” shows the position of SIM card #1
- Arrow “2” shows the position of SIM Card #2
- Arrow “3” shows the orientation of SIM Cards (both the same and contacts facing the PCB)



**Figure 4: Insert the SIM card into the correct SIM card slot; ensure it is fully seated (clicks into place).**



**Figure 5: Clip the cover back on, make sure it clicks into place.**

### 4.3 Configuration of unit

The MiX 6000 is configured with default fleet settings during commissioning. It is possible to make over the air (OTA) changes to some settings via the MiX Fleet Manager software interface.

## 5 Installation

### 5.1 Installation Steps

Step	Action	Software Tools
1)	Ensure the SIM is correctly prepared (refer to section 4.1)	None
2)	Insert the SIM card (refer to ESD precautions in section 3.4). The SIM card orientation is illustrated in section 4.2	None
3)	Configure the unit as described in section 4.3	DynaMiX
4)	Configure Bluetooth if applicable (section 13)	Bluetooth Installation Tool
5)	Configure WiFi if applicable (section 14)	WiFi Installation Tool
6)	Install harness	None
7)	Install code plug socket	None
8)	Install MODEM external antenna	None
9)	Install GPS external antenna	None
10)	Connect power and signal inputs	None
11)	Test Installation	Verify that the unit reports to the Back End
12)	Test MODEM observing the LED flashing sequence (see section 15.4)	None
13)	Test GPS observing the LED flashing sequence (see section 15.3)	None
14)	Install	

The MiX 6000 unit maintains an on-board GPS odometer. This starts at 0 km from the factory. An offset can be sent from the MiX Telematics Fleet Manager user interface to align the odometer value of the MiX 6000 unit with the vehicle odometer at install time. An updated value can be sent at any time to realign these two values.

### 5.2 Installation Precautions

Should it be necessary to remove seats, covers or other components, care should be taken to avoid accidental damage and/or disconnection of cables.

- ⓘ All components should be checked for damage prior to being installed into the vehicle.
- ⓘ A drill should be used for small installation openings.
- ⓘ For larger openings, a conical milling cutter, compass saw or file should be used.
- ⓘ All rough edges should be trimmed.

- ⓘ Careful attention must be paid to the manufacturers' safety regulations for all tools used.
- ⓘ Oils and fuels must be collected in appropriate containers and disposed of in accordance with the law.

### 5.3 Positioning of product components

Installers should ensure that the components of the product do not influence or hamper the functioning of the vehicle's systems.

- ⓘ Care should be taken to ensure that the product's components are not damaged during installation.
- ⓘ Ensure that sufficient space is available for all components of the product, prior to commencing the installation.
- ⓘ Should the bracket be used to fix the unit to the vehicle, make sure that the unit and bracket are securely clipped together. Add a cable-tie around the complete housing and bracket assembly for a more secure mounting if required.

ⓘ Avoid installing in known high-temperature areas, such as parts of the engine bay or near major heat sources.

- Operating range (with backup battery): -20 °C to +60 °C
- Operating range (without backup battery): -40 °C to +85 °C
- Battery will only charge in the range 0 °C to +45 °C

- ⓘ Ensure that the unit and harness are secured to prevent the harness vibrating differently to the unit at the harness connectors.
- ⓘ Correct placement of the external antenna is important to ensure good GNSS reception. It is advisable to install the unit in a location where the GNSS antenna view of the sky is relatively unobstructed by metal. Most vehicle boots for example, may form a metal cage, which prevents GNSS reception. Under the vehicle bonnet will also not give good performance.
  - Please note that the voltage of the external relay is rated to the vehicle voltage specification. Do not run a 12 V relay at 24 V. The Relay Specifications are:
    - Coil current rating: < 250 mA
    - Coil Voltage Rating: Must match the vehicle battery supply
  - Please pay attention to the routing course of cables and wiring (avoid hot parts that can melt or damage the wires.)
  - Do not install the product in or near the location of mechanical or electrical airbags.
  - Do not drill into supporting or stabilizing braces or beams.

### 5.4 General Wiring Requirements

Note the product's wire gauge cross-sectional area. If the wire gauge cross-section is reduced, current density increases, which may cause the wiring to overheat.

- Cables should be routed in existing channels and should not be routed parallel to ignition cables or other cables subject to high current.
- Cables should be fixed with cable-ties or adhesive tape.
- Do not route cables over moving parts or too close to the high voltage areas (like the spark plugs).
- Do not fix cables on the steering column.
- Ensure that the cables are not exposed to pulling, pressure or shearing deformation.

- If the cables are routed through drilled holes, rubber grommets or similar protection should be used.
- Suitable cable-strippers should be used to strip insulating material from cables and cable-strippers should be adjusted to suit the wire gauge being stripped, to avoid damaging or separating the wire strands.
- Cables should only be connected using solder or suitable crimping lugs.
- A proper crimping tool should be used on all crimping lugs.
- Careful attention must be paid to the manufacturers' safety regulations for all tools used.
- Insulate all exposed wires to prevent short-circuits. Use good quality adhesive tape or heat shrink (provided).

**⚠ Connections to vehicle power supply must be installed with a fuse (check if the main harness is fitted with a fuse). The fuse is shipped loose with main harness.**

- Be aware that short-circuiting may be caused by faulty connections and crushed or damaged cables.
- Short-circuiting the vehicle's electrical system may result in fire, explosion of the battery and/or damage to other electrical systems. To prevent this, all connections carrying current must be soldered and insulated correctly. Other connections such as the speed signal, RPM signal, brake light or clutch switch can be made with crimping lugs.
- Incorrect connections can lead to short circuits. Connections should only be made in accordance with the vehicle's wiring diagram.
- Current and voltage should be measured with a multi-meter or diode test lamp.
- The use of inadequate test equipment may result in damage to control devices or other electrical systems.
- Route the harness in such a way as to prevent water condensation that may form on the cable from running into the unit. This can be achieved by having the harness at a lower point just before it connects to the unit. If the back plate is lower than the rest of the unit, water can accumulate inside the unit with no way to escape. The unit should also never be exposed to direct water spray and jets.
- Shortening of antenna wires:
  - It would be better to circle/coil excess wires. Avoid sharp bends (zigzags). Take care not to tie coax wires too tight. The coax should not be squeezed or pinched. Use the broadest possible cable tie.
  - The best place to circle/coil the wires is about 300 mm in line from the antenna.
  - If the MODEM and GNSS antennas are both coiled, they should be spaced apart.
    - Refer to section [5.5.10](#) for more detailed GNSS wiring instructions
    - Refer to section [5.5.11](#) for more detailed MODEM wiring instructions

**X Avoid**

**✓ Recommended**

*Note, that pictures below are for illustration purposes only. They do not present the actual antennae for this product.*

Avoid sharp corners and bends:



Avoid coupling between 2 different pieces of wire:



Use rounded bends:



Separate coiled wires where possible:

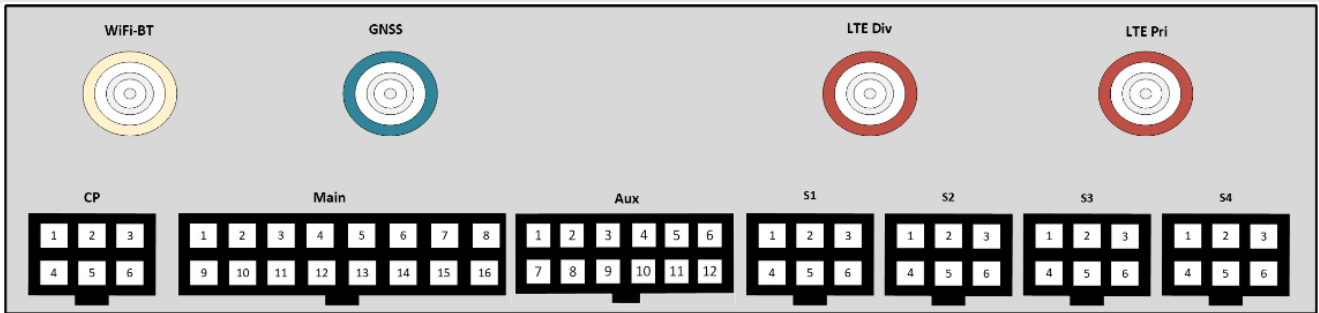


### 5.5 Harnesses and connectors

Please read the Safety section (Section 2) of this document before installing the vehicle harness. Confirm which of the harnesses will be used in the installation, as the colour of the wires will differ depending on the harness selected. All connector diagrams are shown from the back (wiring side) of the harness.



See the diagram below for a numbered depiction.



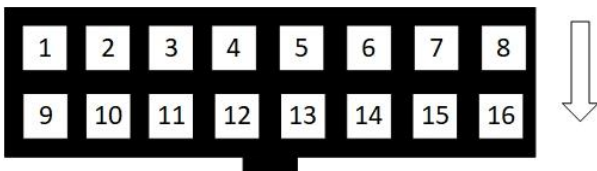
The pin layout and wire colours of the various harness options as well as detailed tables describing pin functions are shown below.

### 5.5.1 Harness Part Numbers

P/N	Description	Weight [kg]
<b>440FT0033</b>	Main Harness MP10	0.291
<b>A0050MT</b>	PUCK Antenna, MiX 6K LTE Diversity, WiFi/Bluetooth and GNSS	0.194
<b>A0049MT</b>	External LTE antenna PA8 Fakra connector	0.037
<b>440FT0032</b>	Code Plug Harness with socket CP4	0.056
<b>A0041MT</b>	Auxiliary Harness AX5 (optional)	0.091
<b>440FT0931</b>	Serial Harness SR1 (optional)	0.092

(See Section 2 for more details.)

### 5.5.2 Main Harness

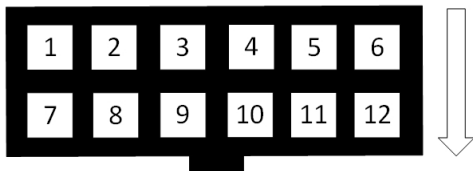


Connector viewed from the back (wiring side) of harness (440FT0033) (connector mounted upside down)

PIN	Colour	Name	Function	Application Information
1	Red	BAT+	Vehicle battery +	Connect to vehicle battery +12 V to +24 V. <b>Must be protected with the provided 7.5 A slow blow fuse, or a similar one already present in the vehicles wiring.</b>
2	Black	IGN	Ignition input	Connect to vehicle ignition switch. Must be protected with a 1 amp fuse.
3	White/Violet	ANALOG 1	Analogue input 1	Maximum signal voltage = 38 V. Do not connect signals from unsuppressed inductive sources such as relay coils (where severe voltage spikes can be generated).
4	White/Red	ANALOG 2	Analogue input 2	

PIN	Colour	Name	Function	Application Information
5	Dark Green	FREQUENCY 1	RPM (Input 4)	Frequency Input. Maximum signal voltage level = 38 V.
6	Blue/White	FREQUENCY 2	Speed (Input 3)	
7	Red/Blue	POSD5	Ext. Relay Drive 1	Load current must not exceed 250 mA Output controlled by MiX 6000 and selected in Vehicle Properties of frontend user software.
8	Brown/Blue	POSD6	Immobiliser Relay	
9	Brown	GND	Ground	Connect directly to vehicle ground. <b>⚠ Do not tap into an existing ground wire carrying high current.</b>
10	Red/White	5V-OUT	Code Plug 5V Out	Can deliver maximum 150 mA.
11	Yellow	CAN1-P	CAN1 High	1 <sup>st</sup> CAN Bus: Used to monitor supported CAN bus.
12	Green	CAN1-N	CAN1 Low	
13	Grey	K-LINE	K-Line serial signal	Serial communication to DTCO.
14	Yellow/Green	BUZZOUT	Buzzer Output	Provides warning sounds.
15	Yellow/Black	CAN2-P	CAN2 High	2 <sup>nd</sup> CAN Bus: Used to monitor supported CAN bus.
16	Green/Black	CAN2-N	CAN2 Low	

### 5.5.3 Auxiliary Harness AUX



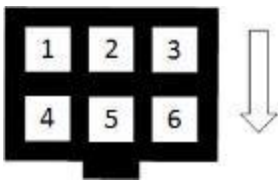
Connector viewed from the back (wiring side) of harness (A0041MT)

Pin	Colour (Prim/Sec)	Signal Name	Function	Application Information
1	Red/Yellow	Positive Drive #7	Power to external devices	Load current must not exceed 250 mA Output controlled by MiX 6000 and selected in Vehicle Properties of front end user software.
2	Red/Green	Positive Drive #8	Power to external devices	
3	White/ Yellow	Analog #4	Digital/Analog Input 4	Maximum signal voltage = 38 V. Do not connect signals from unsuppressed inductive sources such as relay coils (where severe voltage spikes can be generated)
4	White/Blue	Analog #6	Digital/Analog Input 6	
5	White/Grey	Analog #8	Digital/Analog Input 8	
6	White	Analog #10	Digital/Analog Input 10	



Pin	Colour (Prim/Sec)	Signal Name	Function	Application Information
7	Blue/White	RS485-A	RS485 A	RS485 serial communication line A
8	Brown/White	RS485-B	RS485 B	RS485 serial communication line B
9	White/Green	Analog #3	Digital/Analog Input 3	Maximum signal voltage = 38 V. Do not connect signals from unsuppressed inductive sources such as relay coils (where severe voltage spikes can be generated)
10	White/Black	Analog #5	Digital/Analog Input 5	
11	White/Brown	Analog #7	Digital/Analog Input 7	
12	White/Orange	Analog #9	Digital/Analog Input 9	

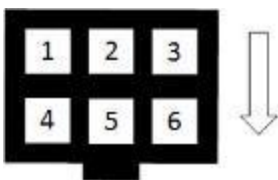
#### 5.5.4 Code Plug Harness CP4



Connector viewed from the back (wiring side) of harness (440FT0032)

Pin	Colour (Prim/Sec)	Name	Function	Application Information
1	White	CP Clock	Code Plug Clock	
2	Red/White	CP 5V	Code Plug 5 V	5 V; 150 mA max
3	Green	CP Data	Code Plug Data	
4	Red (Twisted with white)	LED	Code Plug LED	
5	NC			Not connected
6	Black/White	GND	Ground	

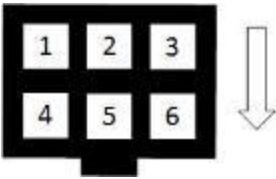
#### 5.5.5 Serial Harness SR1



Connector viewed from the back (wiring side) of harness (440FT0931)

Pin	Colour (Prim/Sec)	Name	Function	Application Information
1	Yellow	S1-TXD	RS-232 Transmit	Only available if the RS-485 is not in use (refer to auxiliary harness pin 7 and 8)
2	White	S1-RXD	RS-232 Receive	
3	Blue	S1-RTS	Ready to send	
4	Green	S1-CTS	Clear to send	
5	Red	POSD 1	Positive Drive 1	Load current must not exceed 250 mA. Output controlled by MiX 6000 and selected in Vehicle Properties of front end user software
6	Brown	GND	Ground	

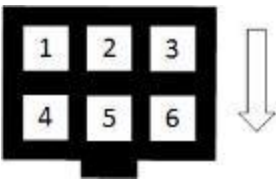
### 5.5.6 Mix 6000 Serial Harness 2 (use Serial Harness SR1)



Connector viewed from the back (wiring side) of harness (440FT0931)

Pin	Colour (Prim/Sec)	Name	Function	Application Information
1	Yellow	S2-TXD	RS-232 Transmit	
2	White	S2-RXD	RS-232 Receive	
3	Blue	S2-RTS	Ready to send	RTS looped to CTS
4	Green	S2-CTS	Clear to send	RTS looped to CTS
5	Red	POSD 2	Positive Drive 2	Load current must not exceed 250 mA Output controlled by MiX 6000 and selected in Vehicle Properties of front end user software
6	Brown	GND	Ground	

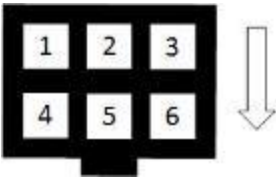
### 5.5.7 Mix 6000 Serial Harness 3 (use Serial Harness SR1)



Connector viewed from the back (wiring side) of harness (440FT0931)

Pin	Colour (Prim/Sec)	Name	Function	Application Information
1	Yellow	S3-TXD	RS-232 Transmit	
2	White	S3-RXD	RS-232 Receive	
3	Blue	S3-RTS	Ready to send	RTS looped to CTS
4	Green	S3-CTS	Clear to send	RTS looped to CTS
5	Red	POSD 3	Positive Drive 3	Load current must not exceed 250 mA Output controlled by MiX 6000 and selected in Vehicle Properties of front end user software
6	Brown	GND	Ground	

### 5.5.8 Mix 6000 Serial Harness 4 (use Serial Harness SR1)



Connector viewed from the back (wiring side) of harness (440FT0931)

Pin	Colour (Prim/Sec)	Name	Function	Application Information
1	Yellow	S4-TXD	RS-232 Transmit	
2	White	S4-RXD	RS-232 Receive	
3	Blue	S4-RTS	Ready to send	RTS looped to CTS
4	Green	S4-CTS	Clear to send	RTS looped to CTS
5	Red	POSD 4	Positive Drive 4	Load current must not exceed 250 mA Output controlled by MiX 6000 and selected in Vehicle Properties of front end user software
6	Brown	GND	Ground	

### 5.5.9 MODEM, GNSS and WiFi-BT Antennas

The WiFi and Bluetooth transceivers share the same antenna. The system detects automatically whether an external antenna is fitted or not. It can also detect tampering, like an external antenna disconnect or a short.

Refer to the picture in section 5.5 showing the positions of the connectors for the external antennas.

**⚠ The Unit contains an internal MODEM antenna and must be mounted more than 20 cm away from the human body under normal operating conditions.**

### 5.5.10 GNSS antenna connection

For best results the external GNSS antenna should be mounted with a good view of the sky. Mount the GNSS antenna horizontally where the least metal (or any conductive) obstruction between the antenna and the satellites will occur. The top side of the antenna is the rounded side.

**⚠ For best results place the antenna on a metal surface facing towards the sky (see picture below).**



- Harness is shipped with the WiFi, BT and Modem Diversity antenna wires each bundled separately.
- If the MODEM and GNSS antennas are both coiled, they should be spaced apart.
- Avoid pinching the coaxial cable or bending it sharply (zigzags).
- It would be better to circle/coil excess wires. Take care not to tie coax wires too tight. Using the broadest possible cable tie (refer to section [5.4](#)).
- The best place to circle/coil the wires is about 300 mm in line from the antenna.

### 5.5.11 MODEM antenna connection

It is recommended to adhere to following important principles:

- ⚠ Do not mount the MODEM Primary (blade) antenna on metal**, as this effects MODEM communication. For best results, mount on glass or other non-conducting surfaces.
- Do not mount a MODEM primary antenna directly on another MODEM antenna or any other antennae.
- Do not mount the MODEM primary antenna directly on the OBC.
- Do not pinch the coaxial cable.
- Avoid pinching the coaxial cable or bending it sharply (zigzags).
- It would be better to circle/coil excess wires. Take care not to tie coax wires too tight. Using the broadest possible cable tie (refer to section [5.4](#)).
- The best place to circle/coil the wires is about 300 mm in line from the antenna.
- If the MODEM and GNSS antennas are both coiled, they should be spaced apart.

## 6 Positioning the MiX 6000 Unit in the vehicle

**Note:** Please follow the instructions, regarding the positioning of product components, as contained in the “Safety” section, of this document, section [3](#).

- Due to possible RF interference, from devices that could be plugged in to lighter/auxiliary sockets, do not install the electronic unit closer than 30cm from any 12 V power outlets in the vehicles. Also take care that any external antenna is at least 60 cm away from any of these 12 V outlets.
- The MiX 6000 must be installed inside the passenger compartment or the driver cabin, to protect it from possible damage by water, solvents, fuel or other environmental factors.
- The MiX 6000 should not be installed in or near the ventilation, heating system, or hot surfaces, which may cause it to overheat or be damaged by condensed water vapour.
- The MiX 6000 should be installed in a position where it will not be subjected to pressure, impact or excessive vibration. Uneven surfaces, where the box can be deformed or damaged should be avoided.
- Select the installation position carefully before proceeding with the installation.
- Mark and drill the required holes.
- Route cables from the unit to the appropriate senders within the vehicle. Additional information can be found in the “Harness Installation” section [5.5](#) of this document.

## 7 Starter Interrupt

The MiX 6000 requires an external relay for the interruption of the vehicle's starter circuit. Positive Drive 6 (POSD6, pin 8 of the Main Harness MP10, see section 5.5.2) is connected to the starter relay.

ⓘ The relay required should be adequately rated for the purpose intended.

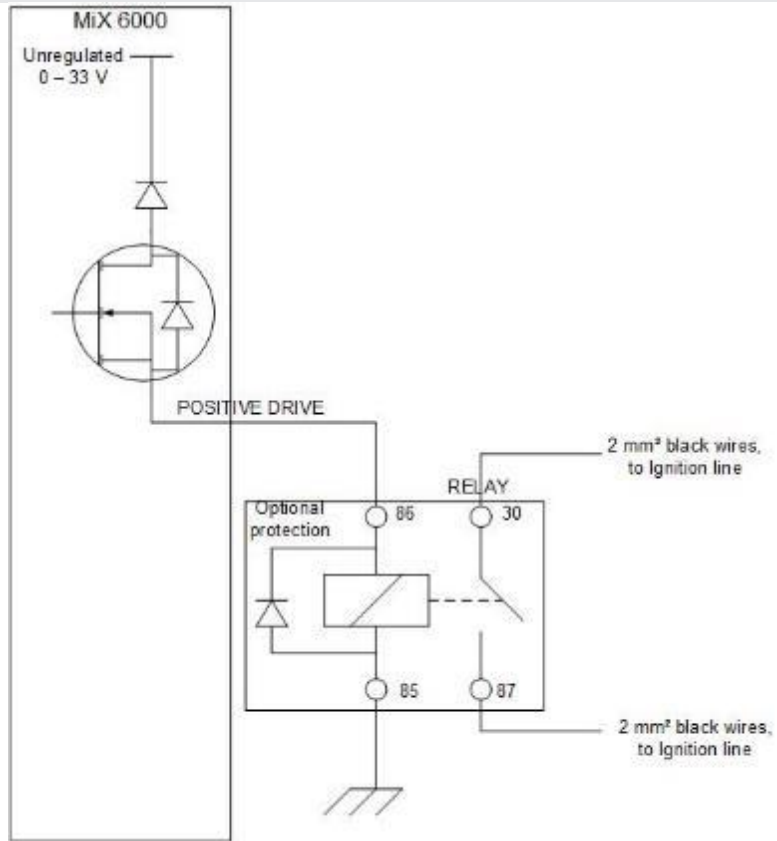
- Please note that a 30 A or 40 A (contact rating) relay should be selected.
- A standard 5 PIN automotive relay manufactured by a reputable supplier (e.g. Bosch) would be adequate. The correct relay operating voltage is required; failure to do so may damage the relay.
- 24 V relays will not function correctly in 12 V applications and 12 V relays will be damaged when used at 24 V.



To connect the relay, it only needs to be plugged into the relay socket on the Main Harness. The two 2 mm<sup>2</sup> black wires represent the two sides of the relay contacts that are controlled via the driver ID Plug. Cut the wires as short as possible, where higher current will be interrupted via the relay.

Also use a cable-tie to secure the relay through the mounting ear (5mm hole) to the main harness, or where possible an M5 lock-nut and bolt is to be used to secure the relay to the vehicle. Ensure that the relay wires have enough play on them not to strain the relay terminal crimps connecting the relay to the wires.

It is not necessary to use a relay with a built in protective diode, because the MiX 6000 has built in protection already. Positive drive/relay outputs are protected against shorts to ground and battery positive and the system can detect these faults. See simplified connection diagram below:





## 8 Code Plug Socket Installation

**Note:** Please follow the instructions, regarding the positioning of product components, as contained in the “Safety” section 3 of this document.

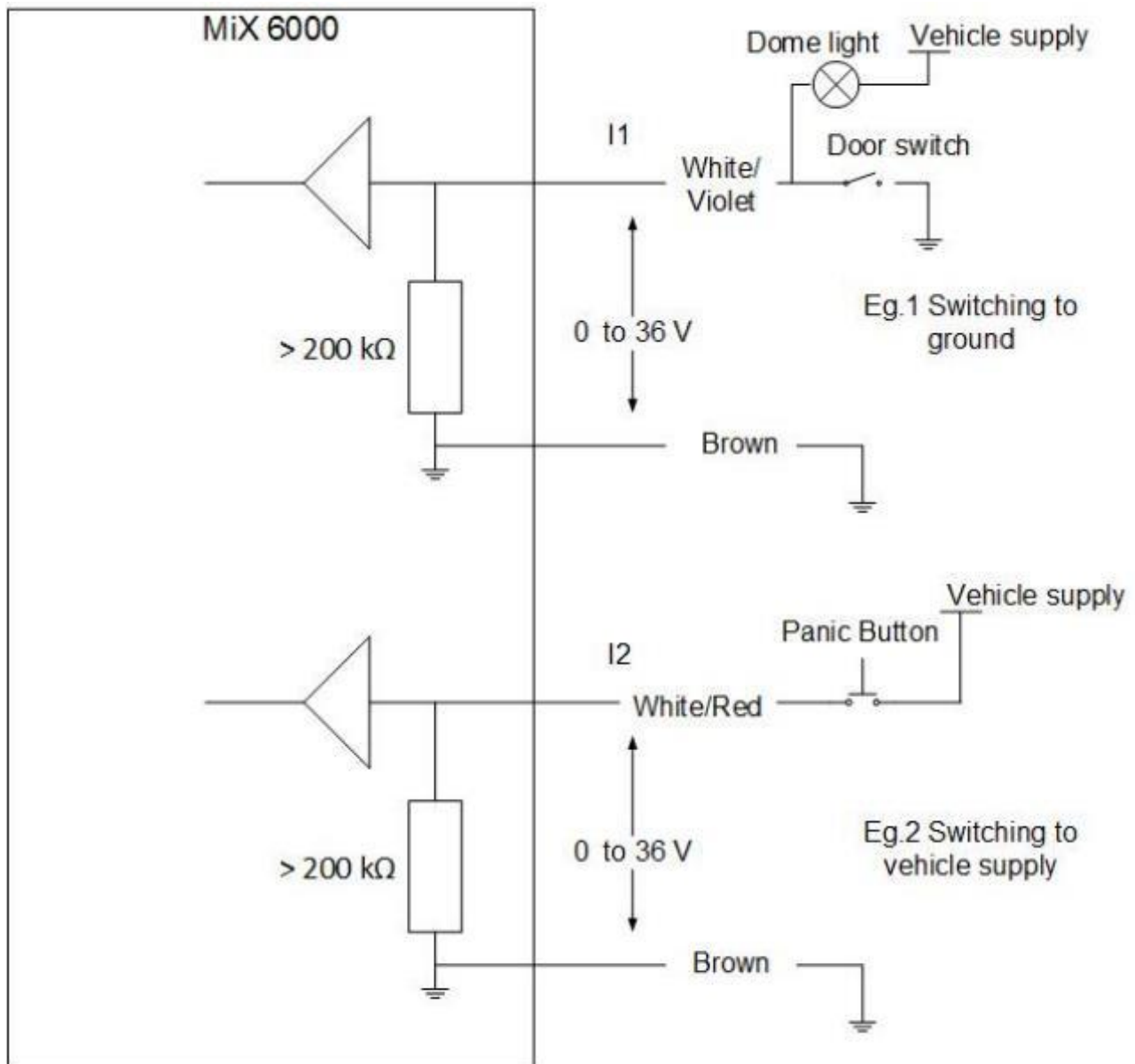
- The Code Plug Socket must be installed inside the passenger compartment or the driver cabin, to protect it from possible damage by water or other environmental factors.
- The Code Plug Socket should not be installed in or near the ventilation or heating systems, which may cause damage to it due to overheating.
- The Code Plug Socket should be installed in a position where it will not be subjected to pressure, impact or excessive vibration.
- Select the installation position carefully before proceeding with the installation.
- Mark and drill or cut the required hole. Hole size = 13/16” or 20 mm
- Remove the mounting clip from the socket.
- Remove the protection film from the adhesive surface of the foam ring and press it firmly against the back of the interface.
- Insert the socket into the mounting hole and slide the mounting clip into position.

## 9 Signal Inputs

### 9.1 Digital Inputs

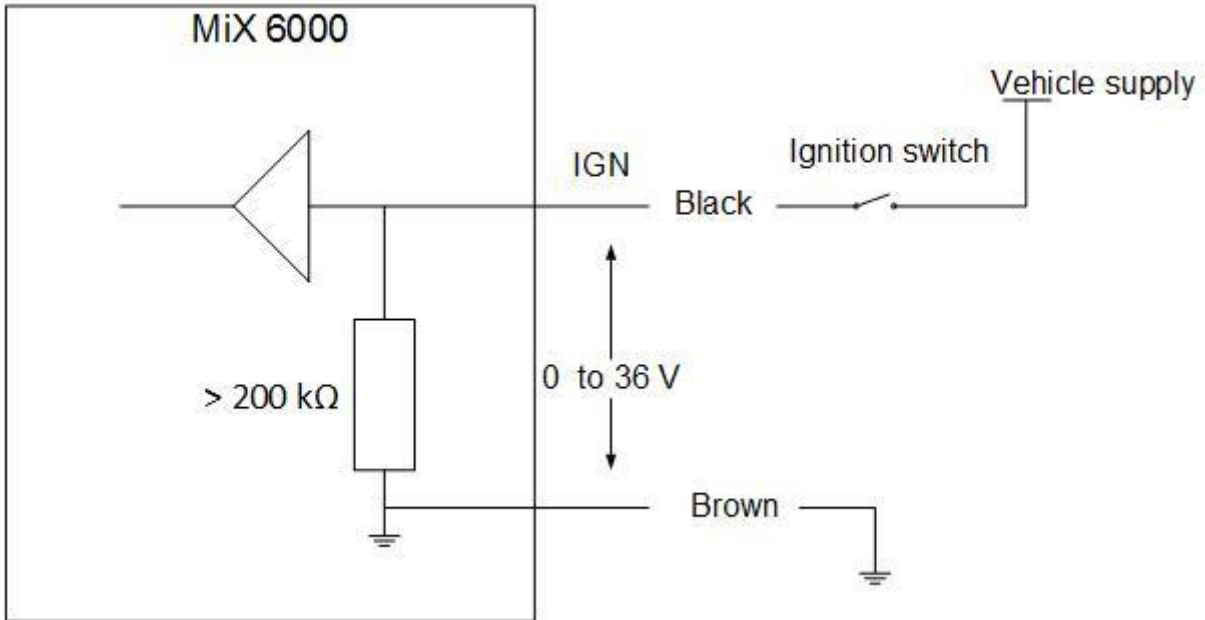
The MiX 6000 is equipped with eight digital/analog inputs (I1-I8), which can be used to monitor digital signals. When the voltage threshold is crossed, an event is triggered. The voltage threshold and the hysteresis are set in software. Please refer to the “Specifications” (19.2) and “Harness Installation” (5.5) sections, of this document, for more details. The external inputs and ignition line are protected from typical vehicle transients and can be directly connected to most vehicle inputs between 0 and 36 V. The input impedance is >200 kΩ. Typical connections are shown below:

Note: There is no internal pull-up resistor in the MiX 6000 so observe the correct wiring configurations shown below for switching to ground or switching to vehicle supply.



## 9.2 Ignition Input

The MiX 6000 includes a dedicated ignition input that must be wired if the starter interrupt immobilizer functionality is required. The input should be connected to the ignition signal on the vehicle. The MiX 6000 will automatically compensate for a 12 or 24 V vehicle supply and no configuration is required. For a typical connection, see below:



Note: If a minimal install is being performed and the vehicle's ignition wire is not available the MiX 6000 can use its internal accelerometer, GNSS, Gyro and measurements of the vehicle's power supply to determine trip start and stop conditions. If this configuration is required, it is important to configure the unit correctly see [4.3](#). For improved trip start/end plotting accuracy on the MiX Telematics Fleet Manager user interface, it is recommended that the wired ignition configuration be used.

## 10 Power Outputs

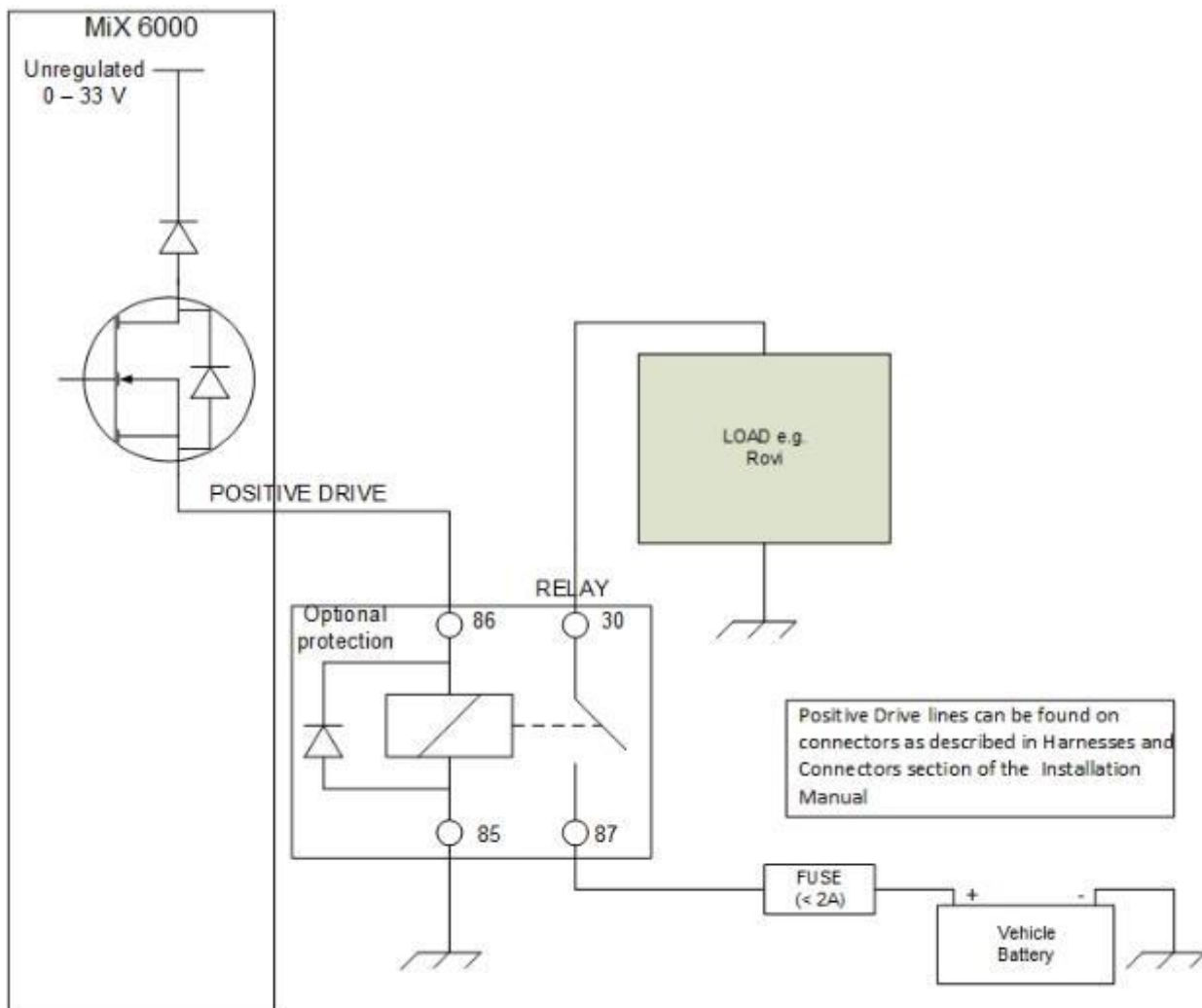
### 10.1 Positive Drive

The Positive Drive output supplies power to MiX 6000 accessories. There are eight Positive Drives in total.

- This output is controlled by the MiX 6000 and is configured in the Vehicle Properties of the Fleet Manager Application software.
- Access to these outputs is described in section 5.5.
- Do NOT connect an external voltage to the positive drive line.

All Positive drive outputs (1-8) can only manage 250 mA each. These circuits are protected against over current and voltage. Should it be necessary to drive a peripheral devices (e.g. MiX Rovi, Mix Display, etc.) that draw more than 250 mA at any stage, it is advisable to make use of an alternative relay to ensure reliable functionality.

Below is a functional block diagram that describes how to wire such a device.



- ⓘ The relay required should be adequately rated for the purpose intended. Please refer to the Starter Interrupt section 7 of this document, for more details.

## 11 Serial Communication

The MiX 6000 is equipped with four RS232 external serial ports. Refer to [5.5](#) for details of the wiring. The serial ports can be used to connect to external peripherals.

All serial ports support RTS/CTS hardware flow control. All serial ports are paired to a positive drive, each capable of supplying 250 mA. For higher power peripherals, use a relay.

All serial ports are capable of up to 115200 baud operation.

## 12 CAN

### 12.1 Overview

Installation of MiX 6000 CAN-bus should only be carried out by trained installers:

- Observe proper ESD precautions
- Improper connection of the MiX 6000 to the vehicle's CAN-bus may cause interference with the vehicle's normal operation.
- The MiX 6000 is already loaded with compatible device drivers.
- The unit still needs to be configured for the vehicle in which it will be installed, and the vehicle ID and odometer still need to be configured. Specifically, the MiX 6000 may not record any CAN data until it is configured.

**⚠ Software control to configure settings to set unit to listen-only for safety-critical installs.**

After installation, verify that no interference is caused to the vehicle's electrical system. Check dashboard warning lights and error messages. Should any error conditions exist, remove the MiX 6000 installation and contact MiX Telematics for assistance.

- Colour coding of the wires are shown in sections 5.5.2:
  - CAN1 Interface wires are designated by a green and a yellow wire, connected to pins 11 and 12 on the Main Harness.
  - CAN2 Interface wires are designated by a green and a yellow wire, connected to pins 16 and 15 on the Main Harness.
  - The convention is that the wire with the colour closer to white in the spectrum (lighter colour) is CAN-H and the wire with the colour closer to black in the colour spectrum (darker colour) is CAN-L.
  - This means that the Green wire is CAN-L and the Yellow wire is CAN-H. The two wires should always be twisted together and if they are not already twisted, they should be twisted together.

#### 12.1.1 Tools and Inspection needed for CAN Installation:

Supporting tools

- Multi-meter
- Oscilloscope
- Laptop with CAN to USB interface (for example Vector CANcaseXL, IXXAT)
- Identify possible CAN busses by looking for twisted pair wires in the vehicle.

- With the vehicle's ignition turned on, measure the voltages relative to ground on each of the wires using a multi-meter.
  - For CAN, the voltage readings of the two wires should be very similar (usually 2.5V), with CAN-H likely to read only slightly higher than CAN-L.
- The actual data can be probed using an oscilloscope.
- With a properly configured 3<sup>rd</sup> party CAN tool, like the Vector CANcaseXL, the actual data can be recorded.
- CAN Baud rates of 250kb/s (SAE J1939) and 500kb/s are the most common.

### 12.1.2 Wire lengths

The CAN wires between the MiX 6000 and the vehicle's bus should not be longer than 300mm. Excessive wire length may cause interference with the vehicle's normal operation.

### 12.1.3 CAN Termination and Transmissions

The MiX6000 does not have any CAN jumpers but the following rules and guidelines should be followed when installing the system

- A properly terminated CAN bus will have a DC resistance of approximately 60  $\Omega$  (one 120  $\Omega$  terminating resistor at each end). By measuring the DC resistance on the vehicle bus between CANH and CANL, before the MiX 6000 is connected, an installer can determine whether additional termination is required. If the resistance measures 60  $\Omega$ , no further termination is required. If it measures 120  $\Omega$ , then additional termination must be added.
- Typically, a bus showing 120  $\Omega$  before installation will only have one node on it, and will not be safety critical. Examples of this might be a DTCO bus or any of the OBDII connections.
- A bus showing 40  $\Omega$  before installation may indicate triple termination, which can cause CAN errors and failure. If this is the case, it is best to advise the customer and ensure this error is corrected by removing the offending unit or termination before MiX 6000 installation.
- After installation of the MiX 6000 and configuration of the termination resistance the CAN bus should measure as 60  $\Omega$ , with the unit powered on and if not, the settings should be checked.

## 12.2 DLD and DTCO

The MiX 6000 also satisfies the need for Remote DTCO Download functionality by incorporating CAN, D8 and K-line communication. The main functionality is the ability to remotely download DTCO data as well as the D8 status change for the Hours of Service solution.

This functionality allows the user to perform the following:

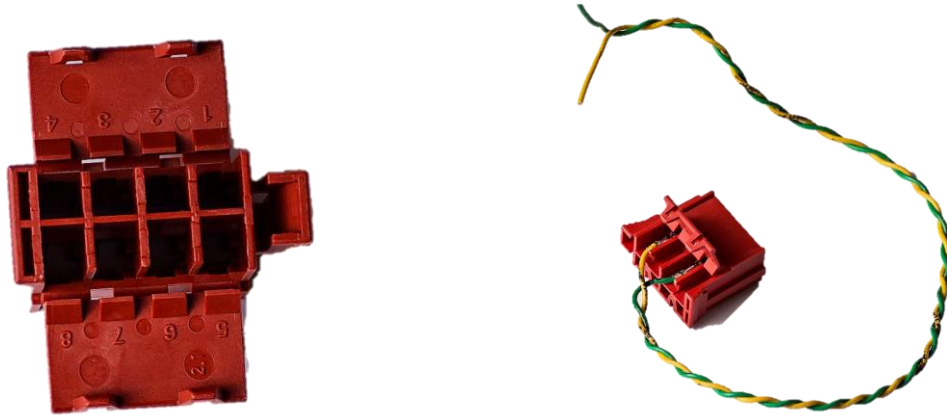
- Synchronise download schedules.
- Authenticate remote tachograph cards.
- Transfer downloaded files to back-office archiving systems.
- Receive updated firmware and configuration settings.

### 12.2.1 D-8

The D8-line is a free running data interface for fleet management systems. The DTCO information (like date, time, currently selected driver and co-driver activity, hours of service, speed of vehicle, etc.) is sent on this communication line. Any of the 4 available serial ports can be configured to communicate to the DTCO D-8 line. The pin numbers of the serial port are shown in sections 5.5.5 to 5.5.8. Connect to pin 2 of the serial port to pin 8 of the brown DTCO D-connector.

### 12.2.2 Connect CAN to DTCO

Refer to section 12.1 on CAN. One of the available CAN busses (normally CAN #2) can be routed to the DTCO CAN. The Yellow and Green wires must be routed to DTCO C (red) connector pin 5 (Yellow) (CAN-H) and 7 (Green) (CAN-L). See pictures below.



### 12.2.3 K-line

Connect the DTCO K-line to pin 13 of the Main Harness (see section [5.5.2](#)).

**⚠ Caution: Should the K-line be incorrectly wired, the K-line circuit can be damaged.**

## 13 MiX TechTool

An Android and iOS version of the MiX Tech Tool is available that can connect to the MiX 6000 via Bluetooth. Refer to the documentation on this tool for detailed instructions.

## 14 WiFi Installation

The WiFi can be used to connect the MiX 6000 to local WiFi networks.

## 15 After Installation

### 15.1 Beep codes

The MiX 6000 has an output that drives a buzzer. The buzzer is not included inside the enclosure but is part of the 10-wire main harness. If any of the other reduced wire count main harnesses are installed, beep codes will not be audible.

The following beep codes will apply when a harness with an external buzzer is installed:

- Double beep when the device reboots or is powered up from shipping mode.
- Triple beep when an over speeding, harsh braking, harsh acceleration or harsh cornering event occurs.
- Continuous slow beeping at trip start for the duration of the user configured driver ID prompt period. (When a valid driver ID is inserted two short beeps will sound and the slow prompt beeps will stop – Default driver ID prompt period is set to zero seconds, disabling the driver ID prompt).
- Five very short beeps when new configuration is sent to the device. (This will typically happen when the first configuration settings are sent to a new device during a successful first connection. This will repeat every time any adjustment is made to device configuration or settings, such as adjusting an over speeding threshold).

### 15.2 LED flash codes

The MiX 6000 has three LEDs for diagnostic purposes. Refer to the Figure 8 below.



**Figure 8: Picture indication the sequence and position of diagnostic LEDs**


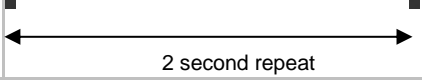

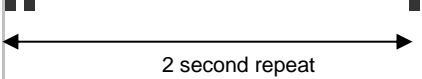

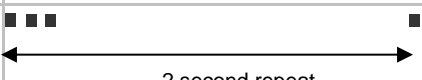








LED 1: Under FW control (left)



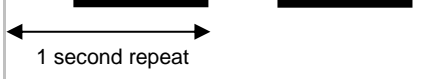

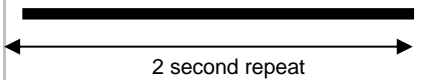

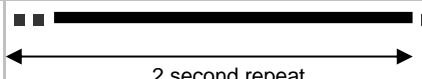

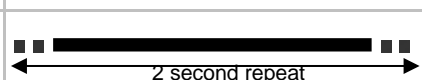



LED 2: Under FW control (middle)


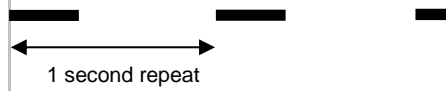

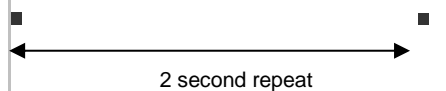

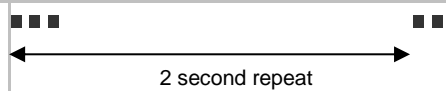

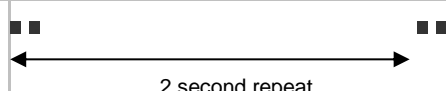


LED 3: Controlled Power by Power Manager (right)

### 15.3 GNSS LED flash codes (GREEN) (LED 3 - Right)

Out of trip (2 second repeat cycle, LED mostly OFF)			
Out of trip with no GNSS lock			GREEN LED: One short ON blip once every two seconds
Out of trip with 2D GNSS lock			GREEN LED: Two short ON blips every two seconds
Out of trip with 3D GNSS lock			GREEN LED: Three short ON blips every two seconds
In trip (1 second repeat cycle, LED mostly ON)			
In trip with no GNSS lock			GREEN LED: Toggles ON/OFF in quick succession continuously
In trip with 2D GNSS lock			GREEN LED: 50% ON and 50% toggling ON/OFF in quick succession every second
In trip and GNSS has acquired 3D lock. The unit will subsequently be able to report accurate GNSS points.			GREEN LED: Mostly ON followed by two short OFF blips every second

### 15.4 MODEM LED flash codes (RED) (LED 2 - Middle)

No communication settings received (LED mostly ON)			
MODEM OFF			RED LED: OFF
MODEM ON, searching for network*			RED LED: Mostly ON with some OFF time once every second
SMS only			RED LED: Almost completely ON with one short OFF blip once every two seconds
GPRS ready			RED LED: Almost completely ON with three short OFF blips once every two seconds
MODEM Connected			RED LED: Almost completely ON with two short OFF blips once every two seconds
Other (e.g. WiFi or Ethernet) connected			RED LED: Almost completely ON with 4 short OFF blips once every two seconds
Communication settings received (LED mostly OFF)			
MODEM OFF			RED LED: OFF

MODEM ON, searching for network			RED LED: Mostly OFF with some ON time once every second
SMS only			RED LED: Almost completely OFF with 1 short ON blip once every two seconds
GPRS ready			RED LED: Almost completely OFF with 3 short ON blips once every two seconds
MODEM Connected			RED LED: Almost completely OFF with 2 short ON blips once every two seconds
Other (e.g. WiFi or Ethernet) Connected			RED LED: Almost completely OFF with 4 short ON blips once every two seconds

## 15.5 Power Indicator (LED 1 – Left)

LED 3 is the power indicator (RED).

- Run mode: POWER light fully ON while MIX6000 application is running (Main micro powered on)
- Stop mode: POWER light is of while MIX6000 application is in stop mode (Main micro in stop mode)
- Power off: POWER light blinks once per second while the unit is in power off mode (Power micro in stop mode, ready to act on wake sources: Accelerometer , External Battery voltage, Ignition, code plug insert and panic (A1))

## 16 Testing Installation

### 16.1 Test Drive

Disarm the system by inserting the blue plug into the Code Plug socket.

- Wait for the audible signal.
- Remove the plug.
- Start the engine.
- Carry out a test drive.

## 17 Closing Steps

- Check all relevant vehicle functions.
- Explain the functions of the MiX 6000 system to the user.

## Troubleshooting

Supporting Documentation can be found at:

 Confluence Link: <https://confluence.mixtelematics.com/display/MFHF/MiX+6000+Home+Page>

 The audible and visual information generated by the MiX 6000 are described in section [15.1](#) and [15.2](#) of this document.

Symptom	Probable Cause	Action
Unit does not switch ON (LED does not flash)	No battery voltage applied to MiX 6000.	<ul style="list-style-type: none"> <li>❗ Check the voltage supply to the MiX 6000.</li> <li>❗ Ensure the connectors are properly fitted.</li> <li>❗ Check fuse if applicable.</li> </ul>
GNSS does not get lock	Orientation of the external antenna is incorrect.  Location of external antenna is limiting good GNSS reception	<ul style="list-style-type: none"> <li>❗ Mount the external antenna with the rounded surface facing up, and the label side down.</li> <li>❗ Check the installation of the external GNSS antenna and ensure that the antenna is facing towards the satellites view of the sky is relatively unobstructed by metal or conductive parts. Refer to section <a href="#">5.5.10</a>.</li> </ul>
MODEM unable to register on network (see MODEM LED flash codes in section 0)	No SIM card inserted or SIM inserted the wrong way round  Automatic commissioning is not possible on the MODEM network selected  MODEM network is out of range  External antenna not proper type  External antenna not correctly mounted.	<ul style="list-style-type: none"> <li>❗ Refer to section <a href="#">4.2</a> for the correct SIM card orientation. Alternatively replace the SIM card.</li> <li>❗ Use a serial configuration harness and the Configuration software to manually program APN and server settings for the unit.</li> <li>❗ Check wiring - refer to section <a href="#">5.5.10</a>.</li> <li>❗ Check coverage of chosen MODEM network using coverage map or a cell phone on the same network.</li> <li>❗ Refer to section <a href="#">5.5.11</a></li> </ul>

## 18 Routine Maintenance

Item	Maintenance	Period
1)	Please ensure that the Code Plug Socket is kept clean and free of dust and dirt. This part is available as an accessory if it needs to be replaced.	Monthly
2)	The internal battery needs to be replaced when a replacement message is generated. Replace the battery if it is swollen.	Back End Warning Message

## 19 MiX 6000 Specifications

### 19.1 Technical description

Refer to the section on Product Variants and Part Numbers (Section 2) for more details.

### 19.2 Auxiliary inputs/outputs

<b>8 x Configurable Analogue or Digital Inputs (I1 to I8)</b>	<p>8 x analogue or digital values can be configured to monitor any device that generates a change in voltage. E.g. seat belts, headlights, refrigeration units, temperature sensors, emergency lights, doors, PTO, UDS, trailer coupling etc.</p> <p>A 12-bit Analog-to-Digital Converter is used for two input ranges. The first voltage range is 0 – 38 volts in steps of approximately 9.3 mV and the second voltage range is 0-5V in steps of 1.2 mV.</p> <p>Input impedance is greater than 200kOhm, and disconnection of any of these inputs can be detected using open-wire detect.</p> <p><b>Note:</b> Do not connect signals from unsuppressed inductive sources such as relay coils (where severe voltage spikes can be generated)</p>
<b>4 x Frequency Inputs (F1 – F4)</b>	<p>Maximum input voltage is 38 V.            Maximum detectable frequency is equal or lower than 50kHz            Input impedance &gt; 200kOhm</p> <p>F1 and F2 are Speed and RPM (high frequency inputs)            F3 and F4 are slow frequency inputs and can be reconfigured as I9 and I10 to become two extra input ports</p> <p>Software adjustable upper and lower voltage thresholds, make it possible to monitor signals of less than a volt, even with a substantial DC voltage offset.            Automatic setup and detection of the signal is possible, and diagnostic information is available to the main processor.</p>
<b>Tacho Inputs</b>	<p>It is possible to configure any of the 12 existing inputs listed above (Digital/Analogue and Frequency) as tacho inputs (slow frequency)</p>
<b>4 x RS232 Serial Interface</b>	<p>This can be connected to any RS232 serial device.</p>
<b>2 x CAN Interface</b>	<p>This can be connected to a J1939 CAN bus. Transmit is under software control and CAN ports are high impedance with no 120 Ohm terminating resistor.</p>

<b>8 x Positive Drive</b>	Positive Drive outputs are used to power external devices at currents up to 250 mA. Disconnection of loads can be detected using open-load detect.
<b>1 x K-line</b>	DTCO K-line
<b>1 x D8</b>	The D8-line is a free running data interface for fleet management systems. The DTCO information (like date, time, currently selected driver and co-driver activity (hours of service), speed of vehicle etc.) is sent on this communication line. Any of the 4 x RS 232 ports can be configured to communicate with the DTCO D8 line.
<b>Ignition input</b>	The ignition input is used only to monitor the vehicle's ignition line state, and can measure up to 38V. Disconnection of this wire can be detected with open-wire detect.

## 20 Regulatory and Environmental Considerations

- 1) The product cannot be installed in places where it is exposed to water jets and temporary immersion into water.
- 2) The product was designed to endure standard transport vibration and shock.
- 3) The optimal operating temperature for the product (with battery) is between -20 and 60 °C.
- 4) The unit (with a battery fitted) SHALL NOT BE EXPOSED to temperatures > 75 °C.
- 5) The non-battery unit can operate between -40 °C and 85 °C

**⚠ This device complies with Part 15 of the FCC Rules. Operation is subject to the following two conditions:**

- (1) this device may not cause harmful interference, and
- (2) this device must accept any interference received, including interference that may cause undesired operation.

No changes / modifications shall be made to the equipment without the manufacturer's permission as this may void the user's authority to operate the equipment.

This equipment complies with FCC radiation exposure limits for an uncontrolled environment. This equipment shall be installed and operated with a minimum distance of 20 cm (7.9 in) between users and/or bystanders and the device.

## 21 Appendix A: Mounting of unit

The MiX 6000 can be ordered with or without backup battery. Refer to table in section 2 with product variants for more details.

- a) Four individual mounting clips are shipped with the product as shown in Figure 12 below:



**Figure 12: Individual mounting clips.**



**Figure 13: Attach the clips by sliding them over the brackets on the unit.**

- b) A large single bracket can also be used to mount the bracket as shown in Figure 14 below.



**Figure 14: Single mounting bracket (440FT0244)**

- c) If the single mounting clip is used to mount the unit, note that the mounting bracket fits over the clips. It helps to secure the side clip.
- d) To open the unit, one must first remove the mounting clip that helps to secure the side clips as shown in Figure 15. Use a flat, thin plastic object (to avoid scratching the enclosure) when opening the unit.



**Figure 15: Alternative option: Single mounting clip**



**Figure 16: Position the single bracket mounting clip as shown above.**

## 22 Glossary

Abbreviation	Description
<b>BT</b>	Bluetooth
<b>DLD</b>	Download Device
<b>DTCO</b>	Digital Tachograph
<b>GPS</b>	Global Positioning System
<b>GNSS</b>	Global Navigation Satellite System
<b>MODEM</b>	Global System for Mobile Communications
<b>GND</b>	Ground (0V)
<b>RX</b>	Receive
<b>TX</b>	Transmit
<b>WiFi</b>	Local Area Wireless Computer Network
<b>BT</b>	Bluetooth