

FCC Test Report

MiX Telematics International (Pty) Ltd
Telematics Unit, Model: MiX 46MC-4G-B

In accordance with FCC 47 CFR Part 15C

Prepared for: MiX Telematics Europe Ltd
Cherry Orchard North
Kembrey Business Park
Swindon
Wiltshire
SN2 8UH
United Kingdom



FCC ID: 2AFMS-4XM CXG

COMMERCIAL-IN-CONFIDENCE

Document 75948420-06 Issue 02

SIGNATURE			
NAME	JOB TITLE	RESPONSIBLE FOR	ISSUE DATE
	Senior Engineer	Authorised Signatory	20 December 2021

Signatures in this approval box have checked this document in line with the requirements of TÜV SÜD document control rules.

ENGINEERING STATEMENT

The measurements shown in this report were made in accordance with the procedures described on test pages. All reported testing was carried out on a sample equipment to demonstrate limited compliance with FCC 47 CFR Part 15C. The sample tested was found to comply with the requirements defined in the applied rules.

RESPONSIBLE FOR	NAME	DATE	SIGNATURE
Testing	Graeme Lawler	20 December 2021	

FCC Accreditation
90987 Octagon House, Fareham Test Laboratory

EXECUTIVE SUMMARY

A sample of this product was tested and found to be compliant with FCC 47 CFR Part 15C: 2019, for the tests detailed in section 1.3.

		DISCLAIMER AND COPYRIGHT This non-binding report has been prepared by TÜV SÜD with all reasonable skill and care. The document is confidential to the potential Client and TÜV SÜD. No part of this document may be reproduced without the prior written approval of TÜV SÜD. © 2021 TÜV SÜD. This report relates only to the actual item/items tested.
		ACCREDITATION Our UKAS Accreditation does not cover opinions and interpretations and any expressed are outside the scope of our UKAS Accreditation. Results of tests not covered by our UKAS Accreditation Schedule are marked NUA (Not UKAS Accredited).

TÜV SÜD
is a trading name of TÜV SÜD Ltd
Registered in Scotland at East Kilbride,
Glasgow G75 0QF, United Kingdom
Registered number: SC215164

TÜV SÜD Ltd is a
TÜV SÜD Group Company

Phone: +44 (0) 1489 558100
Fax: +44 (0) 1489 558101
www.tuv-sud.co.uk

TÜV SÜD
Octagon House
Concorde Way
Fareham
Hampshire PO15 5RL
United Kingdom



Contents

1	Report Summary	2
1.1	Report Modification Record.....	2
1.2	Introduction.....	2
1.3	Brief Summary of Results	3
1.4	Application Form	4
1.5	Manufacturer's Declared Variant(s)	7
1.6	Product Information	8
1.7	Deviations from the Standard.....	8
1.8	EUT Modification Record	9
1.9	Test Location	9
2	Test Details	10
2.1	Authorised Band Edges	10
2.2	Restricted Band Edges.....	14
2.3	Spurious Radiated Emissions	17
3	Measurement Uncertainty	57



1 Report Summary

1.1 Report Modification Record

Alterations and additions to this report will be issued to the holders of each copy in the form of a complete document.

Issue	Description of Change	Date of Issue
1	First Issue	06 May 2020
2	Addition of Declared Variants	20-December-2021

Table 1

1.2 Introduction

Applicant	MiX Telematics Europe Ltd
Manufacturer	MiX Telematics International (Pty) Ltd
Model Number(s)	MiX 46MC-4G-B
Manufacturer Declared Variant(s)	MiX 46MC-4G MiX 4401 MiX 4401-B MiX 4433 MiX 4433-B
Serial Number(s)	53000102
Hardware Version(s)	1
Software Version(s)	48
Number of Samples Tested	1
Test Specification/Issue/Date	FCC 47 CFR Part 15C: 2019
Order Number	P0093369
Date	20-February-2020
Date of Receipt of EUT	02-March-2020
Start of Test	03-March-2020
Finish of Test	08-March-2020
Name of Engineer(s)	Graeme Lawler
Related Document(s)	ANSI C63.10 (2013)



1.3 Brief Summary of Results

A brief summary of the tests carried out in accordance with FCC 47 CFR Part 15C is shown below.

Section	Specification Clause	Test Description	Result	Comments/Base Standard
Configuration and Mode: 915 MHz transmitter				
2.1	15.247 (d)	Authorised Band Edges	Pass	ANSI C63.10 (2013)
2.2	15.205	Restricted Band Edges	Pass	ANSI C63.10 (2013)
2.3	15.205, 15.247 (d)	Spurious Radiated Emissions	Pass	ANSI C63.10 (2013)
-	15.247 (a)(1)	Frequency Hopping Systems - Number of Hopping Channels	N/T	Refer to Document 75942815-02 for results*
-	15.247 (a)(1)	Frequency Hopping Systems - 20 dB Bandwidth	N/T	Refer to Document 75942815-02 for results*
-	15.247 (a)(1)	Frequency Hopping Systems - Channel Separation	N/T	Refer to Document 75942815-02 for results*
-	15.247 (a)(1)	Frequency Hopping Systems - Average Time of Occupancy	N/T	Refer to Document 75942815-02 for results*
-	15.247 (b)	Maximum Conducted Output Power	N/T	Refer to Document 75942815-02 for results*

Table 2

N/T – Not Tested

*The manufacturer has declared the radio device is electrically identical and therefore the conducted results will be the same.



1.4 Application Form

Equipment Description

Technical Description: <i>(Please provide a brief description of the intended use of the equipment)</i>	The MiX 46MC-4G is a fleet product that incorporates the latest market trends. It consists mainly of an on-board computer, an LTE CAT M1 modem with 2G fall-back, a GNSS, an accelerometer, Low Energy Bluetooth, I/O, 2 x CAN, 2 x RS232, 4 x positive drives and 434 / 915 MHz short range transceiver.
Manufacturer:	MiX Telematics International (Pty) Ltd.
Model:	MiX 46MC-4G; MiX 46MC-4G-B
Part Number:	440FT0194; 440FT0195
Hardware Version:	1
Software Version:	4.8
FCC ID (if applicable)	2AFMS-4XMCXG
IC (if applicable)	

Intentional Radiators

Technology	LTE Band 12	LTE Band 13	LTE Band 5	LTE Band 4	LTE Band 3	LTE Band 2	SRD915	SRD2400
Frequency Band (MHz)	699-716	777-787	824-849	1710-1755	1710-1785	1880-1910	902-928	2400-2480
Conducted Declared Output Power (dBm)	23	23	23	23	23	23	20	7
Antenna Gain (dBi)	0.76	1.39	0.21	1.46	1.46	2.07	0	1.4
Supported Bandwidth(s) (MHz)	1.4	1.4	1.4	1.4	1.4	1.4	0.025	1
Modulation Scheme(s)	QPSK/ 16-QAM	QPSK/ 16-QAM	QPSK/ 16-QAM	QPSK/ 16-QAM	QPSK/ 16-QAM	QPSK/ 16-QAM	2FSK	GFSK
ITU Emission Designator	1M40W7D	1M40W7D	1M40W7D	1M40W7D	1M40W7D	1M40W7D	38K4F7D	1M00G7D
Bottom Frequency (MHz)	699	777	824	1710	1710	1850	902	2402
Middle Frequency (MHz)	707.5	782	836.5	1747.5	1747.5	1880	915	2440
Top Frequency (MHz)	716	787	849	1755	1785	1910	928	2480

Un-intentional Radiators

Highest frequency generated or used in the device or on which the device operates or tunes	2480 MHz
Lowest frequency generated or used in the device or on which the device operates or tunes	699 MHz
Class A Digital Device (Use in commercial, industrial or business environment) <input type="checkbox"/>	
Class B Digital Device (Use in residential environment only) <input checked="" type="checkbox"/>	



AC Power Source

AC supply frequency:	N/A	Hz
Voltage	N/A	V
Max current:	N/A	A
Single Phase <input type="checkbox"/> Three Phase <input type="checkbox"/>		

DC Power Source

Nominal voltage:	13.8/27.6 V DC	V
Extreme upper voltage:	32	V
Extreme lower voltage:	10.5	V
Max current:	2A typical; 4.5A absolute max (7.5A Fused)	A

Battery Power Source

Voltage:	3.2	V
End-point voltage:	3.2	V (Point at which the battery will terminate)
Alkaline <input type="checkbox"/> Leclanche <input checked="" type="checkbox"/> Lithium <input type="checkbox"/> Nickel Cadmium <input type="checkbox"/> Lead Acid* <input type="checkbox"/> *(Vehicle regulated)		
Other <input type="checkbox"/>	Please detail:	

Charging

Can the EUT transmit whilst being charged	Yes <input checked="" type="checkbox"/> No <input type="checkbox"/>
---	---

Temperature

Minimum temperature:	-20	°C
Maximum temperature:	60	°C

Antenna Characteristics

Antenna connector <input checked="" type="checkbox"/>			State impedance	50	Ohm
Temporary antenna connector <input type="checkbox"/>			State impedance		Ohm
Integral antenna <input checked="" type="checkbox"/>	Type:	LTE BLE SRD915 GNSS	Gain	3 1.4 0 4	dBi
External antenna <input checked="" type="checkbox"/>	Type:	GNSS	Gain	4	dBi
For external antenna only: Standard Antenna Jack <input checked="" type="checkbox"/> If yes, describe how user is prohibited from changing antenna (if not professional installed): Equipment is only ever professionally installed <input checked="" type="checkbox"/> Non-standard Antenna Jack <input type="checkbox"/>					



Ancillaries (if applicable)

Manufacturer:	MiX Telematics	Part Number:	440FT0033
Model:	Main Harness MP10	Country of Origin:	South Africa
Manufacturer:	MiX Telematics	Part Number:	440FT0032
Model:	Code Plug Harness with Socket CP4	Country of Origin:	South Africa
Manufacturer:	MiX Telematics	Part Number:	440FT0931
Model:	Serial Harness SR1	Country of Origin:	South Africa
Manufacturer:	RF Design	Part Number:	440FT0933
Model:	External GNSS Antenna PA2	Country of Origin:	South Africa

I hereby declare that the information supplied is correct and complete.

Name: Ben van der Merwe
Position held: Senior RF Engineer
Date: 29 April 2020



1.5 Manufacturer’s Declared Variant(s)

The following product variants (with part numbers) are available:

Part ID	Official Name	Description
440FT0194	MiX 46MC-4G	MiX 4000 LTE with 2G fall back (Model 46MC-4G) Electronic Unit; with Magix 434MHz and 915MHz support.
440FT0195	MiX 46MC-4G-B	MiX 4000 LTE with 2G fall back (Model 46MC-4G-B) Electronic Unit with Battery (plugged in) with Magix 434MHz and 915MHz support.

The variants MiX 46MC-4G and MiX 46MC-4G-B, present the same electrical, physical and electro mechanics characteristics, the same PCB (440AWZ124), layout and components.

The only difference between them is that the model MiX 46MC-4G-B has an internal backup battery, allowing the device to work after the disconnection of the vehicle’s battery.

MiX Telematics International (Pty) Ltd, hereby certify that the models listed below, present the same electrical, physical and electro mechanics characteristics, the same PCB and layout.

Assembly Number	Assembly Name	Description
U0071MT	MiX 4401	MiX 4401 Electronic Unit: Quectel BG96; SRD 434MHz, 915MHz
U0073MT	MiX 4401-B	MiX 4401-B Electronic Unit with Backup Battery: Quectel BG96; SRD 434MHz, 915MHz
U00109MT	MiX 4433	MiX 4433 Electronic Unit: Quectel EG91-NA; SRD 915MHz
U00111MT	MiX 4433-B	MiX 4433 Electronic Unit with Backup Battery: Quectel EG91-NA; SRD 915MHz

The components are also the same apart from:

- a) For the MiX 4401/MiX 4401-B both the 434 and 915 MHz transceiver circuits are populated. Only one of these can operate per region. This is configurable via Software.
- b) The MiX 4433/MiX 4433-B only has a 915 MHz transceiver. The components for the 434 MHz transceiver are not populated.
- c) Having different modems, namely BG96 and EG91-NA respectively. The modems originate from the same modem supplier, namely Quectel. The modems have the same PCB footprint.
 The “-B” variants have an internal backup battery plugged in, allowing the device to work after the disconnection of the vehicle’s battery. The functionality and purposes of the products are the same.

1.6 Product Information

1.6.1 Technical Description

The MiX 46MC-4G is a fleet product that incorporates the latest market trends. It consists mainly of an on-board computer, a LTE CAT M1 modem with 2G fallback, a GNSS, an accelerometer, Bluetooth Low Energy, I/O, 2 x CAN, 2 x RS232, 4 x positive drives and 434 / 915 MHz short range transceiver.

1.6.2 Test Setup Diagram(s)

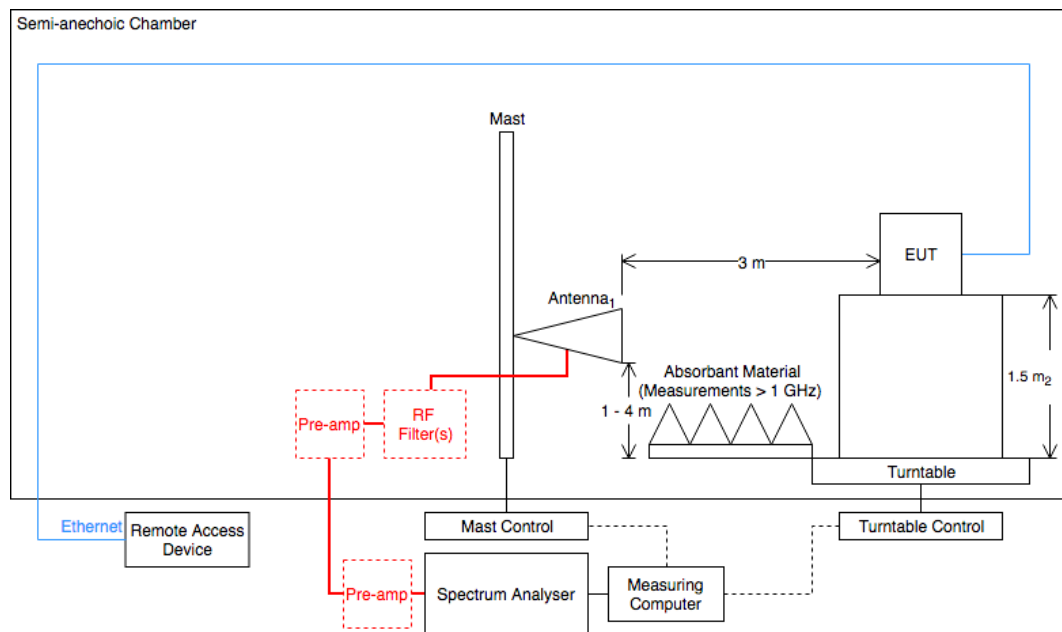

- ¹ Antenna is boresighted for measurements > 1 GHz.
- ² Height from the EUT to ground is 0.8 m for measurements < 1 GHz.

1.6.3 EUT Configuration and Rationale for Radiated Spurious Emissions

The EUT was placed on a non-conducting platform in a manner typical of a normal installation. The EUT would be fitted in multiple planes, pre-scans were performed with the EUT orientated in X, Y and Z planes with reference to the ground plane.

Ports on the EUT were terminated with loads as described in ANSI C63.4 clause 6.2.4

1.7 Deviations from the Standard

No deviations from the applicable test standard were made during testing.



1.8 EUT Modification Record

The table below details modifications made to the EUT during the test programme.

The modifications incorporated during each test are recorded on the appropriate test pages.

Modification State	Description of Modification still fitted to EUT	Modification Fitted By	Date Modification Fitted
Model: MiX 46MC-4G-B, Serial Number: 53000102			
0	As supplied by the customer	Not Applicable	Not Applicable

Table 3

1.9 Test Location

TÜV SÜD conducted the following tests at our Fareham Test Laboratory.

Test Name	Name of Engineer(s)	Accreditation
Configuration and Mode: 915 MHz transmitter		
Authorised Band Edges	Graeme Lawler	UKAS
Restricted Band Edges	Graeme Lawler	UKAS
Spurious Radiated Emissions	Graeme Lawler	UKAS

Table 4

Office Address:

Octagon House
Concorde Way
Segensworth North
Fareham
Hampshire
PO15 5RL
United Kingdom



2 Test Details

2.1 Authorised Band Edges

2.1.1 Specification Reference

FCC 47 CFR Part 15C, Clause 15.247 (d)

2.1.2 Equipment Under Test and Modification State

MiX 46MC-4G-B, S/N: 53000102 - Modification State 0

2.1.3 Date of Test

08-March-2020

2.1.4 Test Method

The test was performed in accordance with ANSI C63.10, clause 6.10.4.

2.1.5 Environmental Conditions

Ambient Temperature 22.1 °C

Relative Humidity 32.9 %

2.1.6 Test Results

915 MHz transmitter

Mode	Frequency (MHz)	Band Edge Frequency (MHz)	Level (dBc)
Static	902.2	902	-42.83
Static	927.4	928	-60.98
Hopping	All Channels	902	-40.01
Hopping	All Channels	928	-69.27

Table 5 - Authorised Band Edge Results

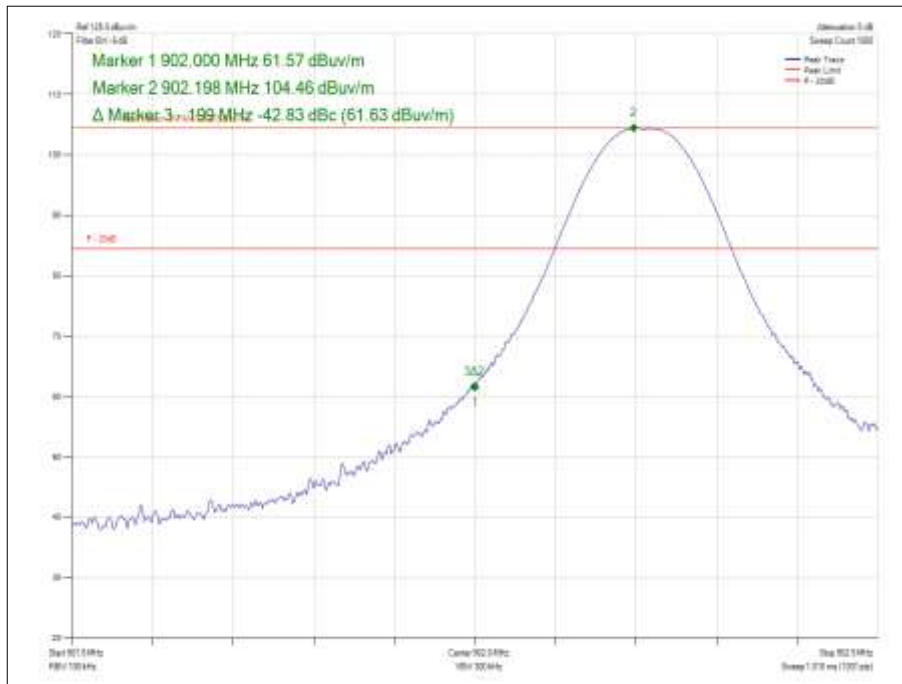

Figure 1 – Static, 902.2 MHz - Measured Frequency 902 MHz

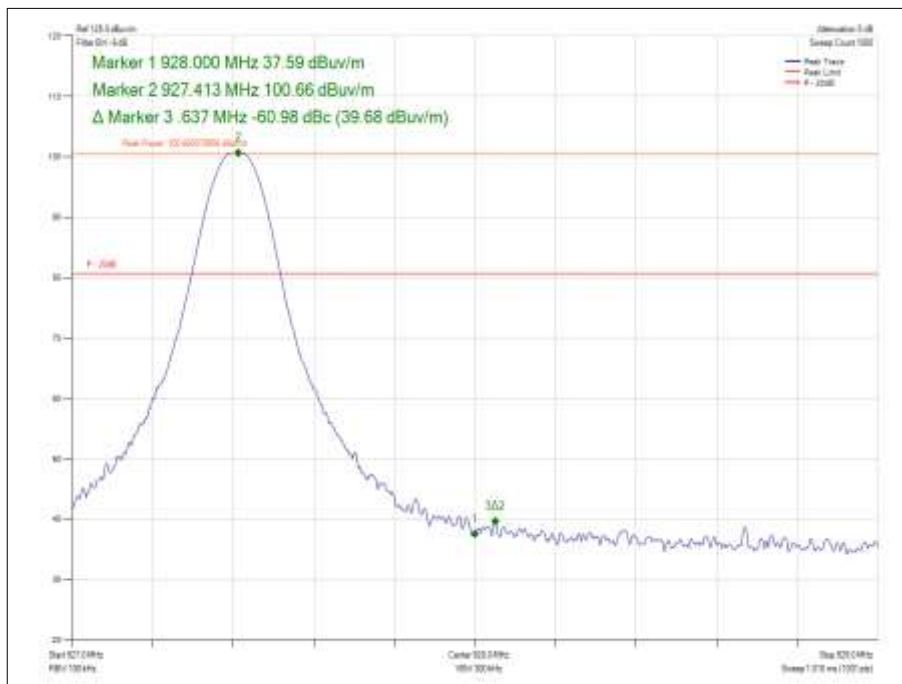

Figure 2 – Static, 927.4 MHz - Measured Frequency 928 MHz

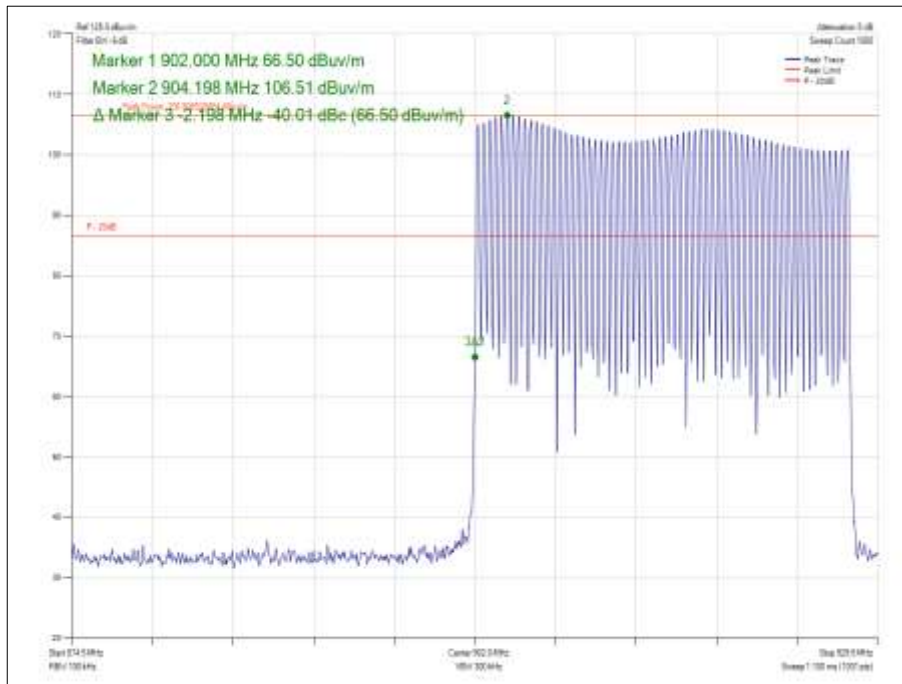

Figure 3 - Hopping - Measured Frequency 902 MHz

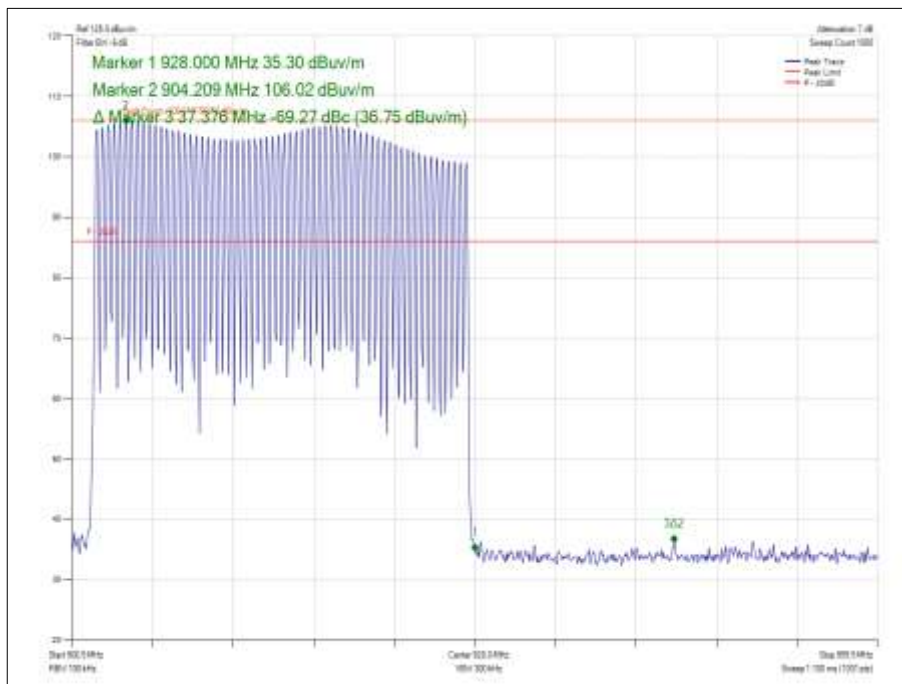

Figure 4 - Hopping - Measured Frequency 928 MHz

FCC 47 CFR Part 15, Limit Clause 15.247 (d)

20 dB below the fundamental measured in a 100 kHz bandwidth using a peak detector. If the transmitter complies with the conducted power limits, based on the use of RMS averaging over a time interval, the attenuation required shall be 30 dB below the fundamental instead of 20 dB.



2.1.7 Test Location and Test Equipment Used

This test was carried out in EMC Chamber 5.

Instrument	Manufacturer	Type No	TE No	Calibration Period (months)	Calibration Due
Screened Room (5)	Rainford	Rainford	1545	36	23-Jan-2021
Turntable Controller	Inn-Co GmbH	CO 1000	1606	-	TU
DC Power Supply	Hewlett Packard	6269B	1909	-	TU
Multimeter	Iso-tech	IDM101	2417	12	11-Nov-2020
Antenna with permanent attenuator (Bilog)	Chase	CBL6143	2904	24	30-Sep-2021
Comb Generator	Schaffner	RSG1000	3034	-	TU
Cable (Yellow, Rx, Km-Km 2m)	Scott Cables	KPS-1501-2000-KPS	4527	6	09-Jun-2020
Mast Controller	Maturo GmbH	NCD	4810	-	TU
Tilt Antenna Mast	Maturo GmbH	TAM 4.0-P	4811	-	TU
Double Ridge Broadband Horn Antenna	Schwarzbeck	BBHA 9120 B	4848	12	11-Mar-2020
4dB Attenuator	Pasternack	PE7047-4	4935	24	30-Sep-2021
Hygrometer	Rotronic	HP21	4989	12	02-May-2020
EmX Emissions Software	TUV SUD	EmX	5125	-	Software
8 Meter Cable	Teledyne	PR90-088-8MTR	5212	12	30-Aug-2020
EMI Test Receiver	Rohde & Schwarz	ESW44	5382	12	08-Oct-2020

Table 6

TU - Traceability Unscheduled



2.2 Restricted Band Edges

2.2.1 Specification Reference

FCC 47 CFR Part 15C, Clause 15.205

2.2.2 Equipment Under Test and Modification State

MiX 46MC-4G-B, S/N: 53000102 - Modification State 0

2.2.3 Date of Test

08-March-2020

2.2.4 Test Method

This test was performed in accordance with ANSI C63.10, clause 6.10.5.

The final measurement was performed using a peak detector.

The following conversion can be applied to convert from dBµV/m to µV/m:
 $10^{(\text{Field Strength in dB}\mu\text{V/m}/20)}$.

2.2.5 Environmental Conditions

Ambient Temperature 22.1 °C
Relative Humidity 32.9 %

2.2.6 Test Results

915 MHz transmitter

Mode	Frequency (MHz)	Band Edge Frequency (MHz)	Peak Level (dBµV/m)
Static	902.2	614	33.45
Static	927.4	960	36.20

Table 7 - Restricted Band Edge Results

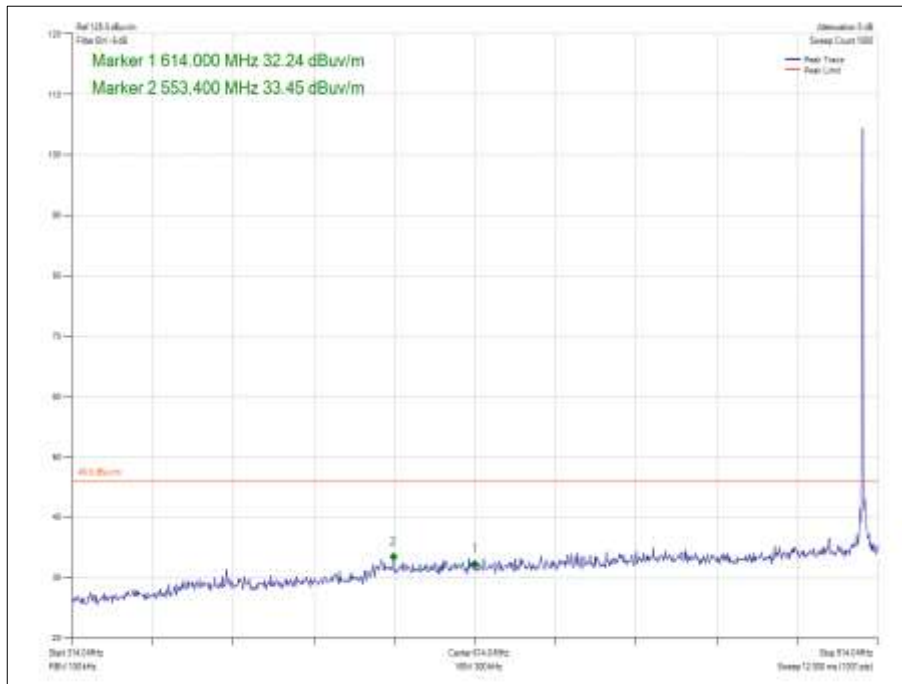

Figure 5 - Static - Measured Frequency 614 MHz - Peak

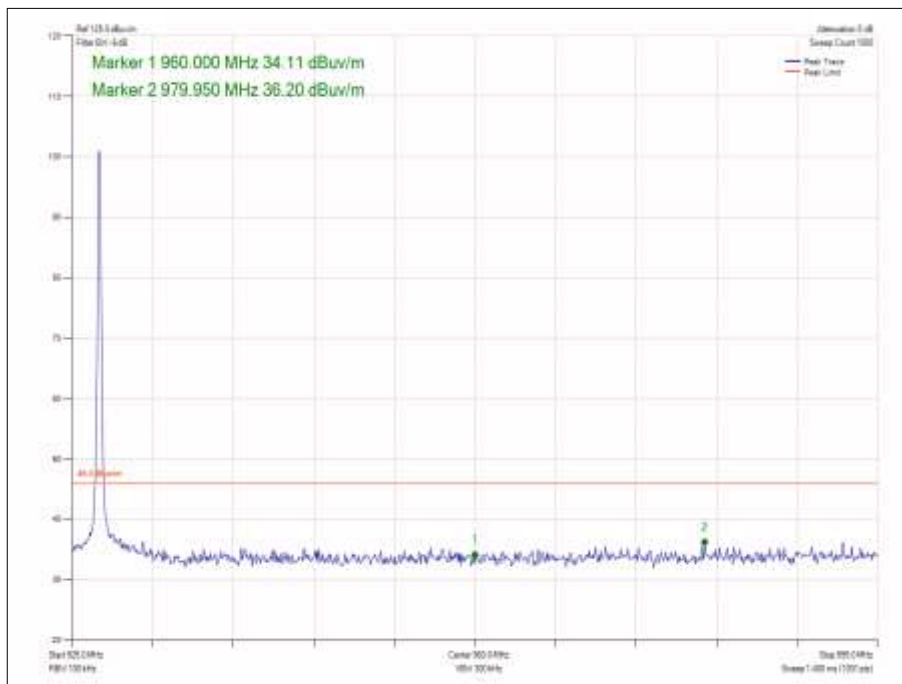

Figure 6 - Static - Measured Frequency 960 MHz - Peak



FCC 47 CFR Part 15, Limit Clause 15.209

Frequency (MHz)	Field Strength ($\mu\text{V}/\text{m}$ at 3 m)
30 to 88	100
88 to 216	150
216 to 960	200
Above 960	500

Table 8

2.2.7 Test Location and Test Equipment Used

This test was carried out in EMC Chamber 5.

Instrument	Manufacturer	Type No	TE No	Calibration Period (months)	Calibration Due
Screened Room (5)	Rainford	Rainford	1545	36	23-Jan-2021
Turntable Controller	Inn-Co GmbH	CO 1000	1606	-	TU
DC Power Supply	Hewlett Packard	6269B	1909	-	TU
Multimeter	Iso-tech	IDM101	2417	12	11-Nov-2020
Antenna with permanent attenuator (Bilog)	Chase	CBL6143	2904	24	30-Sep-2021
Comb Generator	Schaffner	RSG1000	3034	-	TU
Cable (Yellow, Rx, Km-Km 2m)	Scott Cables	KPS-1501-2000-KPS	4527	6	09-Jun-2020
Mast Controller	Maturo GmbH	NCD	4810	-	TU
Tilt Antenna Mast	Maturo GmbH	TAM 4.0-P	4811	-	TU
Double Ridge Broadband Horn Antenna	Schwarzbeck	BBHA 9120 B	4848	12	11-Mar-2020
4dB Attenuator	Pasternack	PE7047-4	4935	24	30-Sep-2021
Hygrometer	Rotronic	HP21	4989	12	02-May-2020
EmX Emissions Software	TUV SUD	EmX	5125	-	Software
8 Meter Cable	Teledyne	PR90-088-8MTR	5212	12	30-Aug-2020
EMI Test Receiver	Rohde & Schwarz	ESW44	5382	12	08-Oct-2020

Table 9

TU - Traceability Unscheduled



2.3 Spurious Radiated Emissions

2.3.1 Specification Reference

FCC 47 CFR Part 15C, Clause 15.247 (d) and 15.205

2.3.2 Equipment Under Test and Modification State

MiX 46MC-4G-B, S/N: 53000102 - Modification State 0

2.3.3 Date of Test

03-March-2020 to 08-March-2020

2.3.4 Test Method

This test was performed in accordance with ANSI C63.10, clause 6.3, 6.5 and 6.6.

The EUT was placed on the non-conducting platform in a manner typical of a normal installation. For an EUT which could reasonable be used in multiple planes, pre-scans were performed with the EUT orientated in X, Y and Z planes with reference to the ground plane.

Ports on the EUT were terminated with loads as described in ANSI C63.4, clause 6.2.4. For EUT's with multiple connectors of the same type, additional interconnecting cables were connected, and pre-scans performed to determine whether the level of the emissions were increased by >2 dB. For frequencies > 1 GHz, plots for average measurements were taken in accordance with ANSI C63.10, clause 4.1.4.2.5 to characterize the EUT. Where emissions were detected, final average measurements were taken in accordance with ANSI C63.10, clause 4.1.4.2.2.

The plots shown are the characterization of the EUT. The limits on the plots represent the most stringent case for restricted bands, (74/54 dBuV/m) when compared to 20 dBc outside restricted bands. The limits shown have been used as a threshold to determine where further measurements are necessary. Where results are within 10 dB of the limits shown on the plots, further investigation was carried out and reported in results tables.

The following conversion can be applied to convert from dB μ V/m to μ V/m:
 $10^{(\text{Field Strength in dB}\mu\text{V/m}/20)}$.

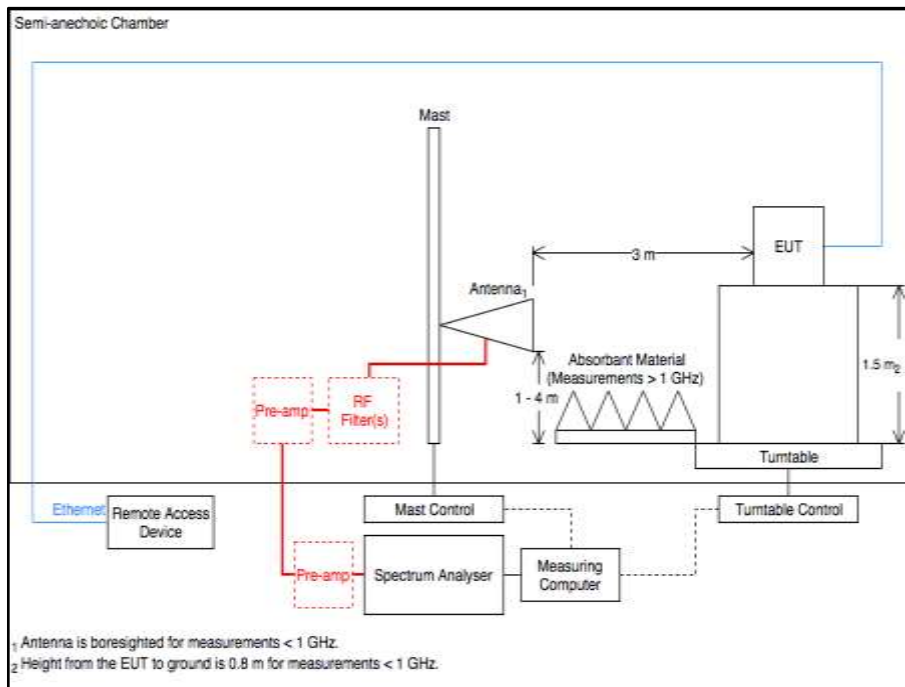

Figure 7 - Radiated Emissions Test Setup Diagram

2.3.5 Environmental Conditions

Ambient Temperature	20.3 - 22.1 °C
Relative Humidity	32.1 - 32.9 %



2.3.6 Test Results

915 MHz transmitter

Frequency (MHz)	Level (dBµV/m)	Limit (dBµV/m)	Margin (dB)	Detector	Angle (°)	Height (cm)	Polarisation	Orientation
*								

Table 10 - 902.2 MHz, 30 MHz to 1 GHz - Emission Results

*No emissions were detected within 10 dB of the limit.

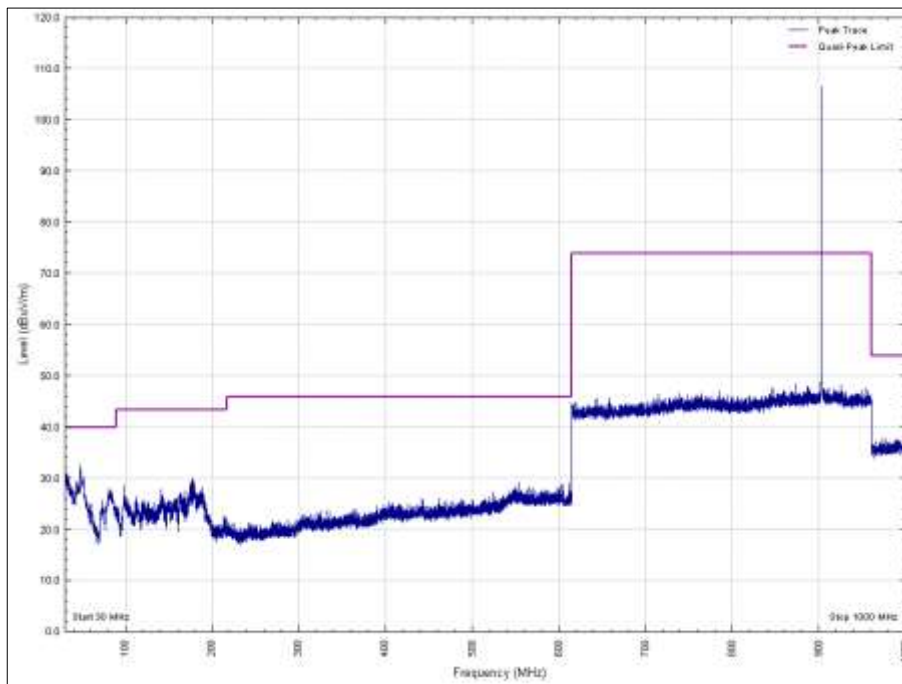

Figure 8 - 902.2 MHz, 30 MHz to 1 GHz, Vertical, X Orientation

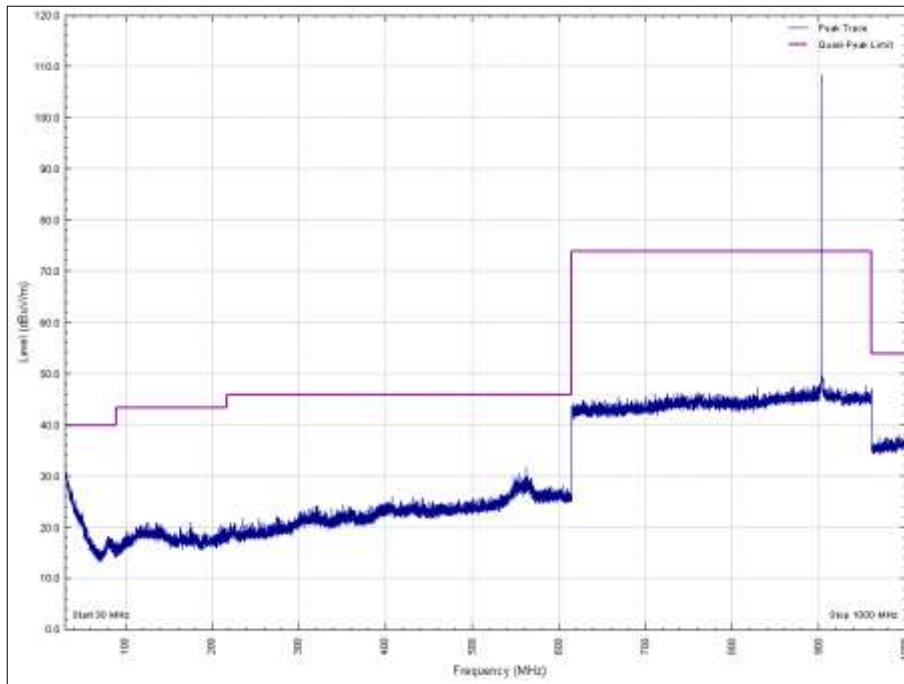

Figure 9 - 902.2 MHz, 30 MHz to 1 GHz, Horizontal, X Orientation

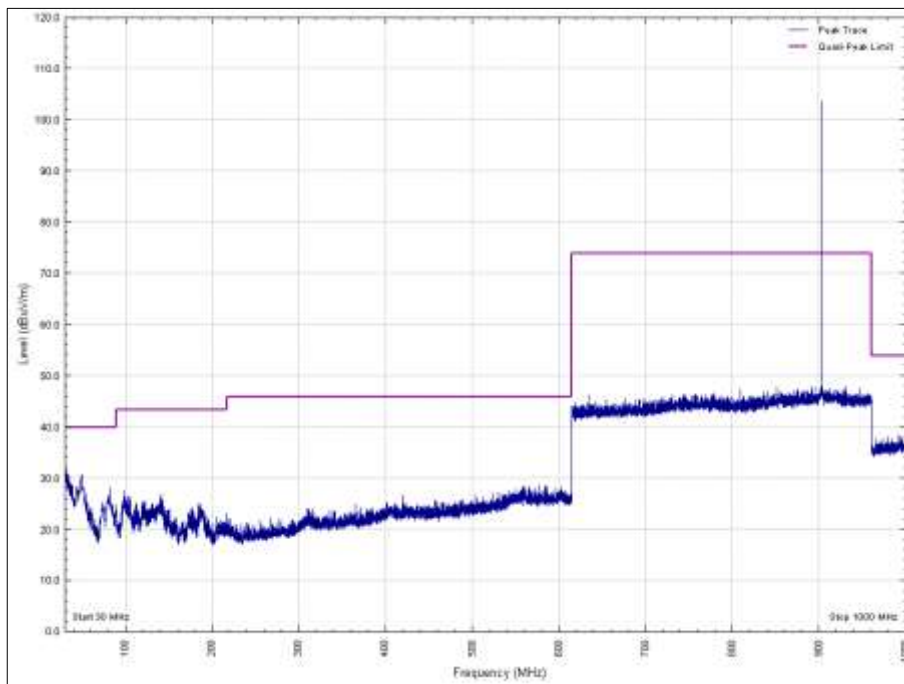

Figure 10 - 902.2 MHz, 30 MHz to 1 GHz, Vertical, Y Orientation

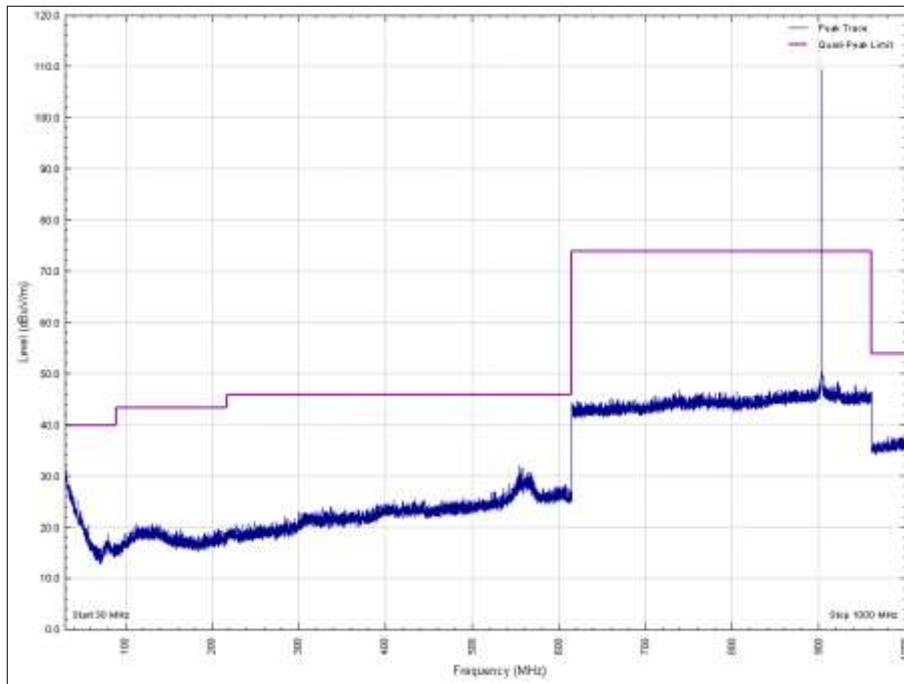

Figure 11 - 902.2 MHz, 30 MHz to 1 GHz, Horizontal, Y Orientation

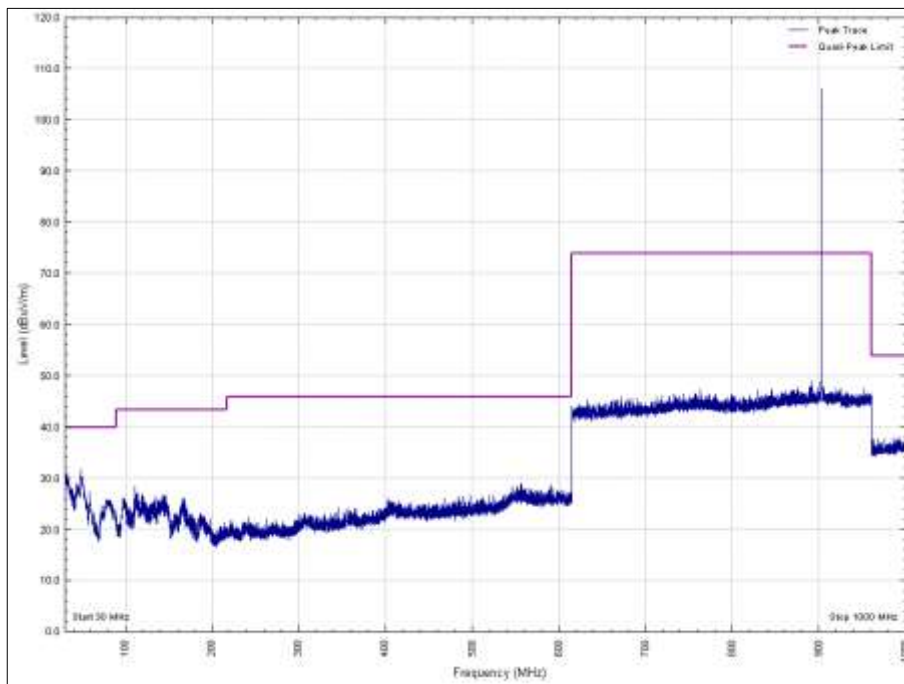

Figure 12 - 902.2 MHz, 30 MHz to 1 GHz, Vertical, Z Orientation

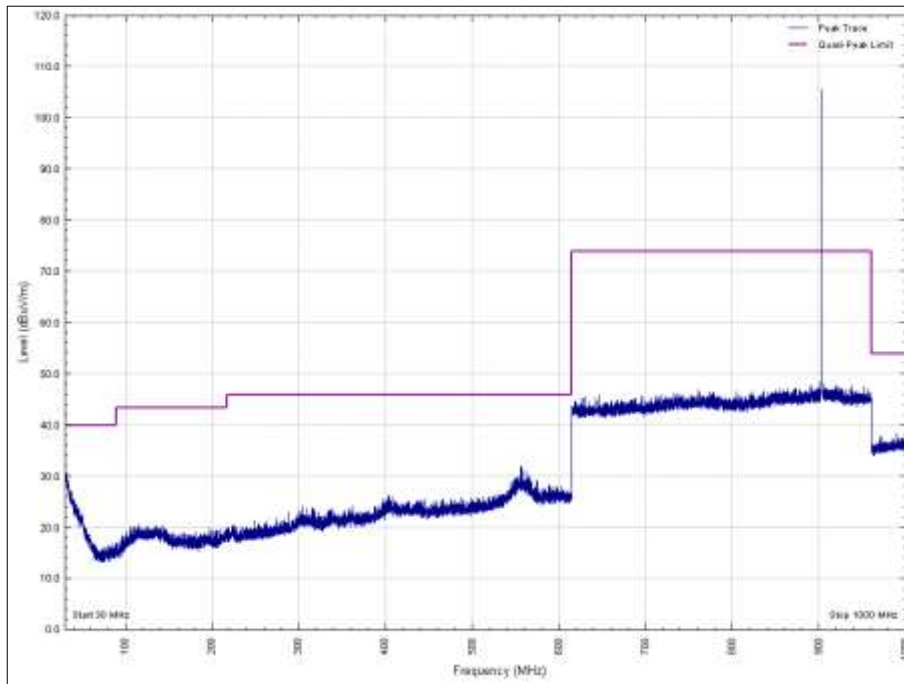

Figure 13 - 902.2 MHz, 30 MHz to 1 GHz, Horizontal, Z Orientation



Frequency (MHz)	Level (dBµV/m)	Limit (dBµV/m)	Margin (dB)	Detector	Angle (°)	Height (cm)	Polarisation	Orientation
3608.842	45.92	53.98	8.06	CISPR Average	325	382	Vertical	Y
3608.857	46.81	53.98	7.17	CISPR Average	34	100	Horizontal	Z
5413.336	45.64	53.98	8.34	CISPR Average	330	100	Vertical	Y

Table 11 - 902.2 MHz, 1 GHz to 10 GHz Emissions Results

No other emissions were detected within 10 dB of the limit.

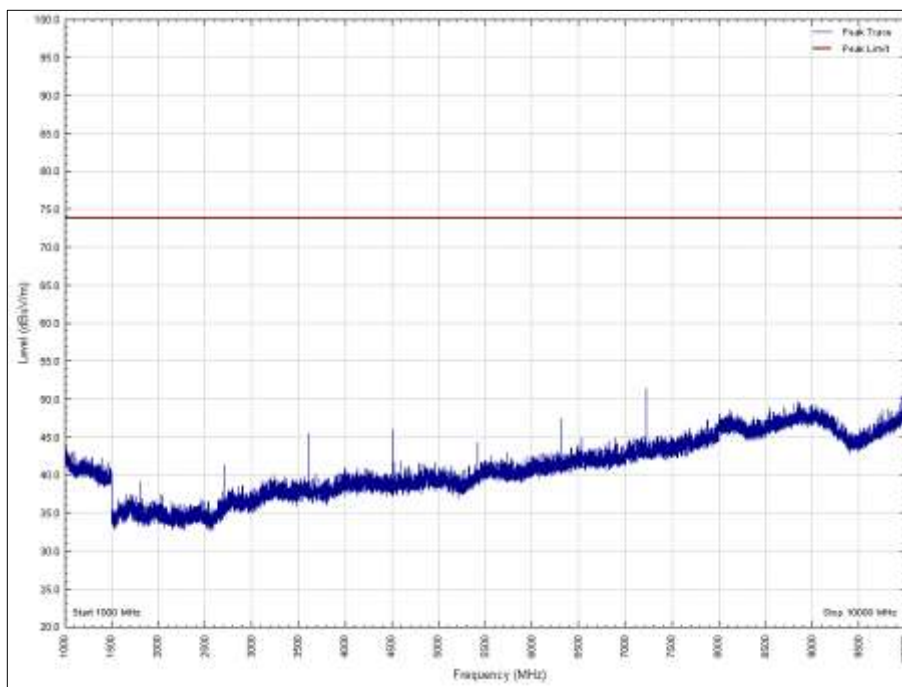

Figure 14 - 902.2 MHz, 1 GHz to 10 GHz, Vertical, X Orientation: - Peak

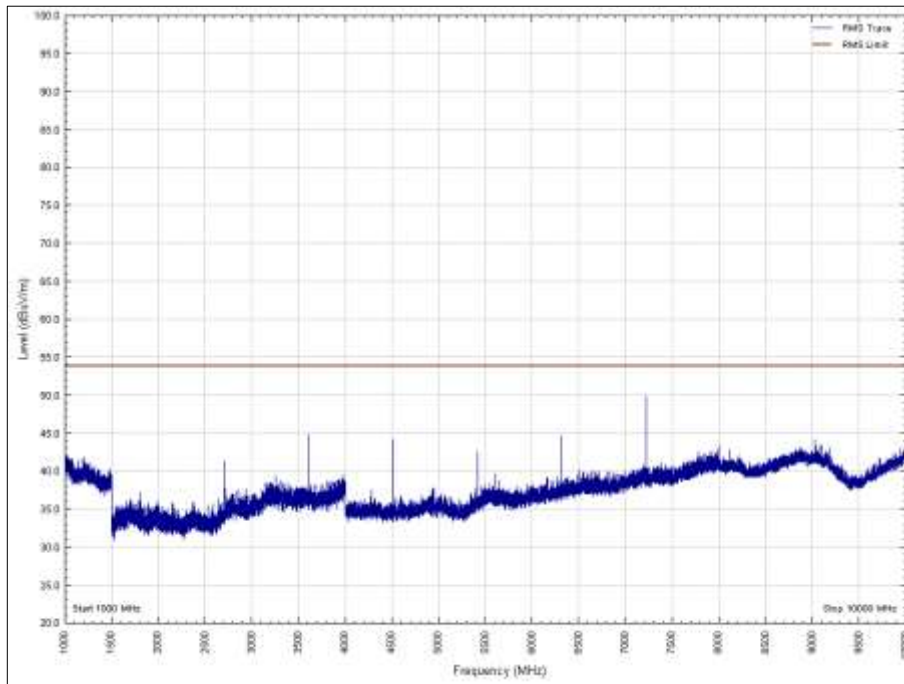

Figure 15 - 902.2 MHz, 1 GHz to 10 GHz, Vertical, X Orientation: - Average

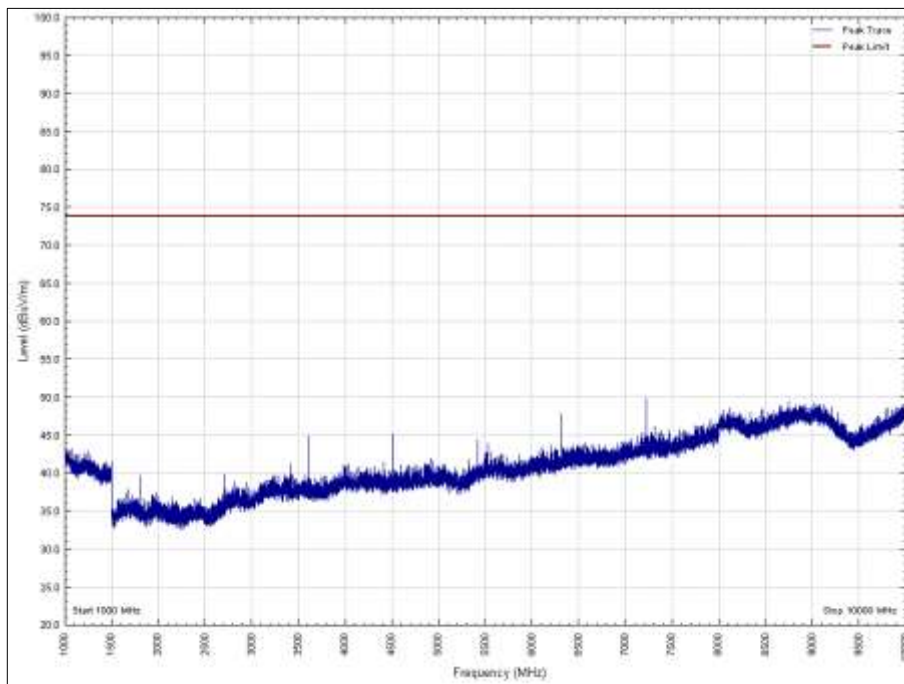

Figure 16 - 902.2 MHz, 1 GHz to 10 GHz, Horizontal, X Orientation: - Peak

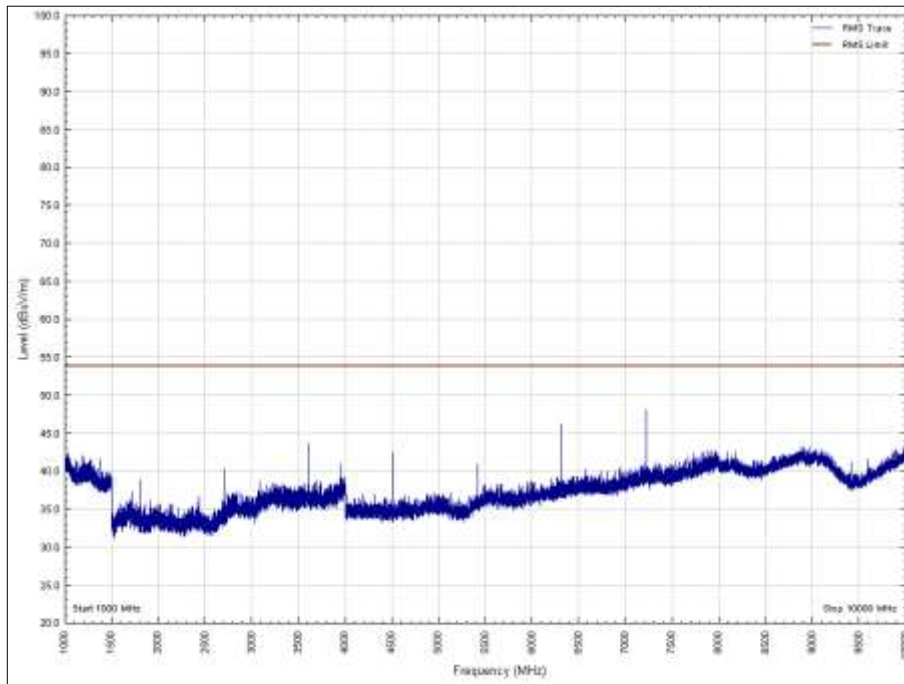

Figure 17 - 902.2 MHz, 1 GHz to 10 GHz, Horizontal, X Orientation: - Average

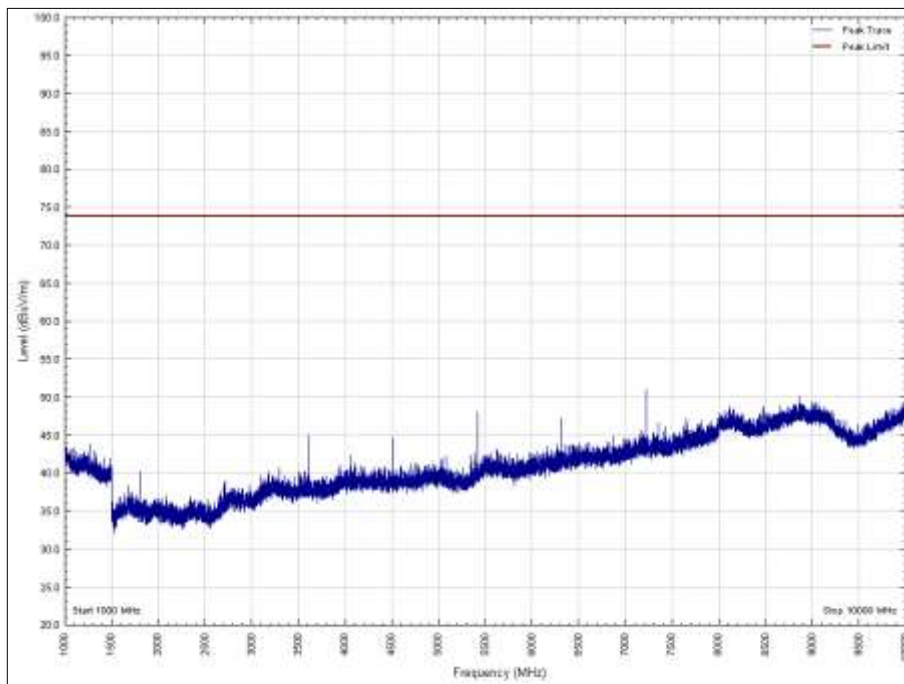

Figure 18 - 902.2 MHz, 1 GHz to 10 GHz, Vertical, Y Orientation: - Peak

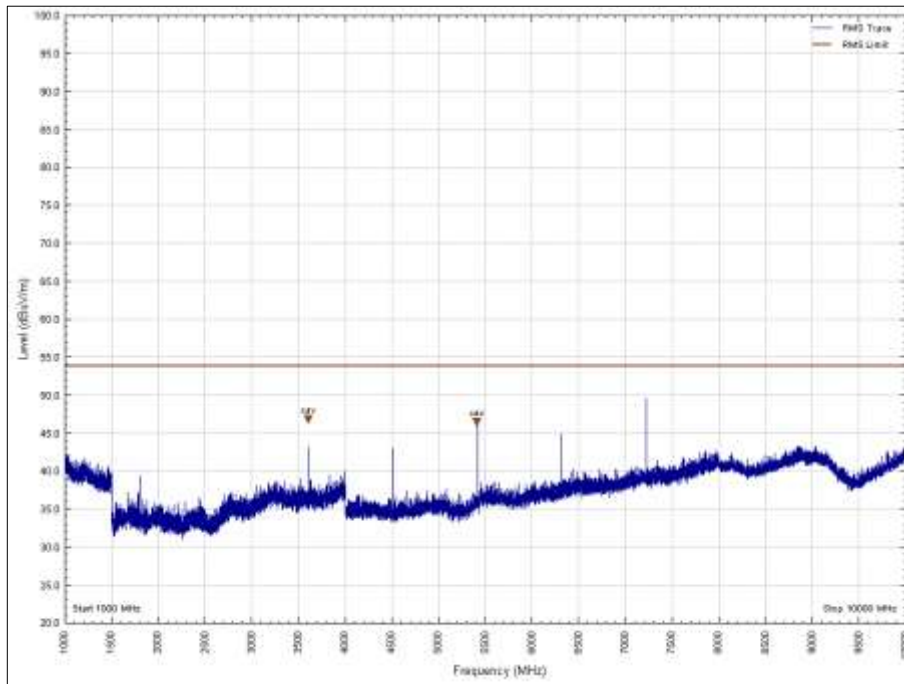

Figure 19 - 902.2 MHz, 1 GHz to 10 GHz, Vertical, Y Orientation: - Average

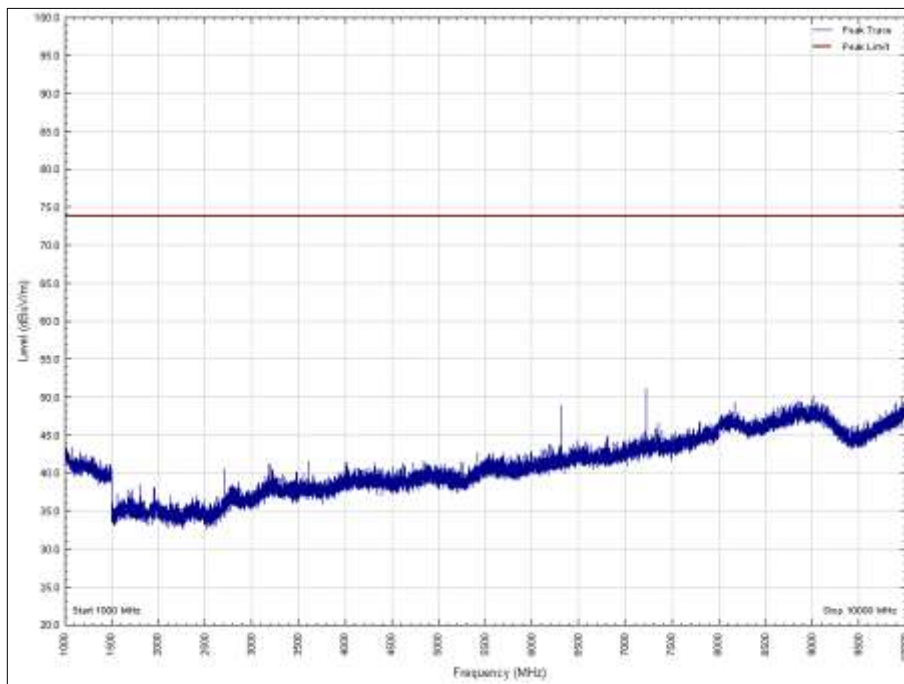

Figure 20 - 902.2 MHz, 1 GHz to 10 GHz, Horizontal, Y Orientation: - Peak

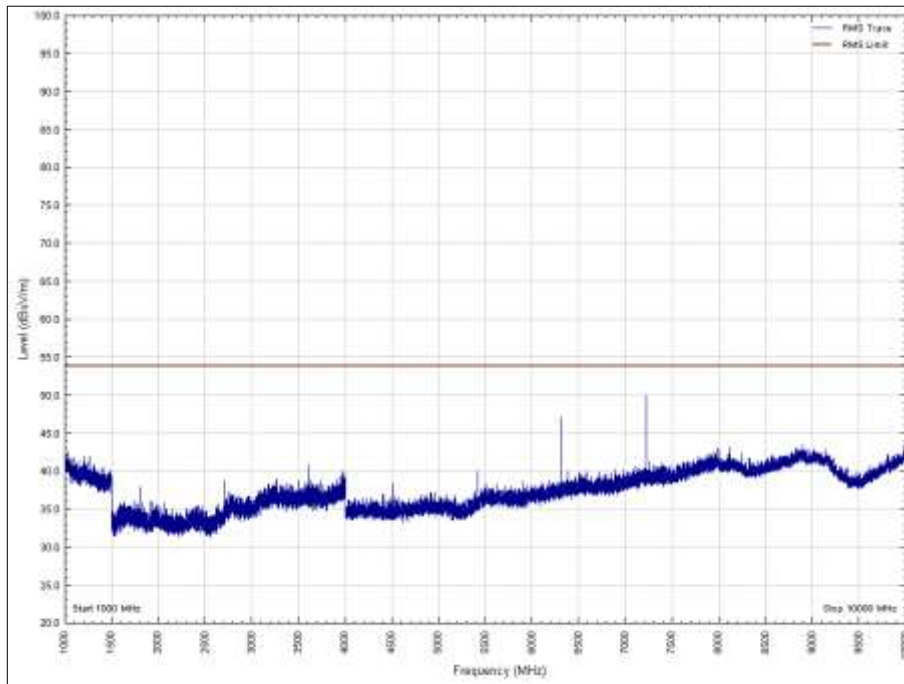

Figure 21 - 902.2 MHz, 1 GHz to 10 GHz, Horizontal, Y Orientation: - Average

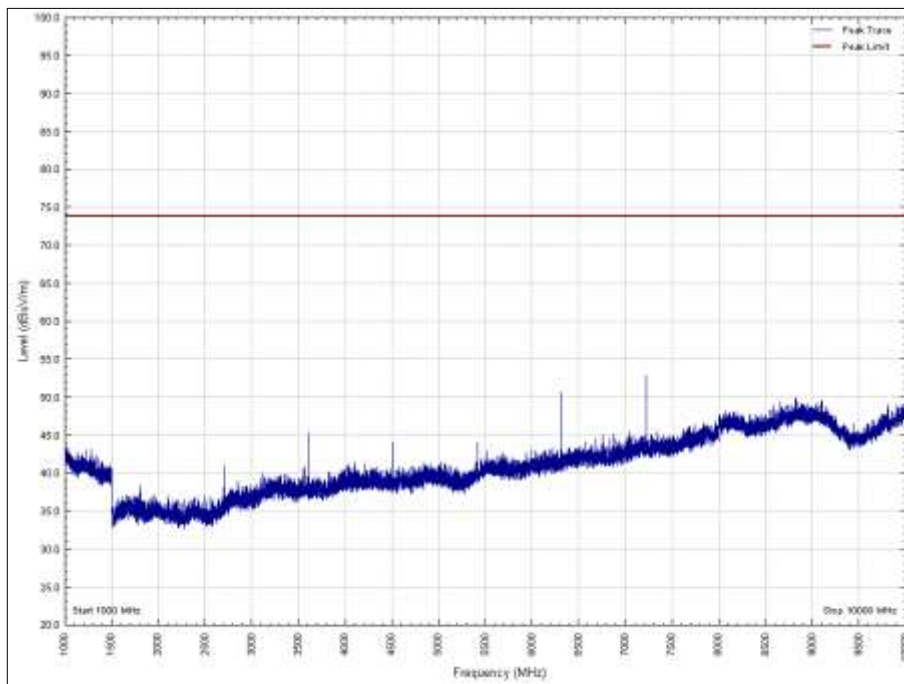

Figure 22 - 902.2 MHz, 1 GHz to 10 GHz, Vertical, Z Orientation: - Peak

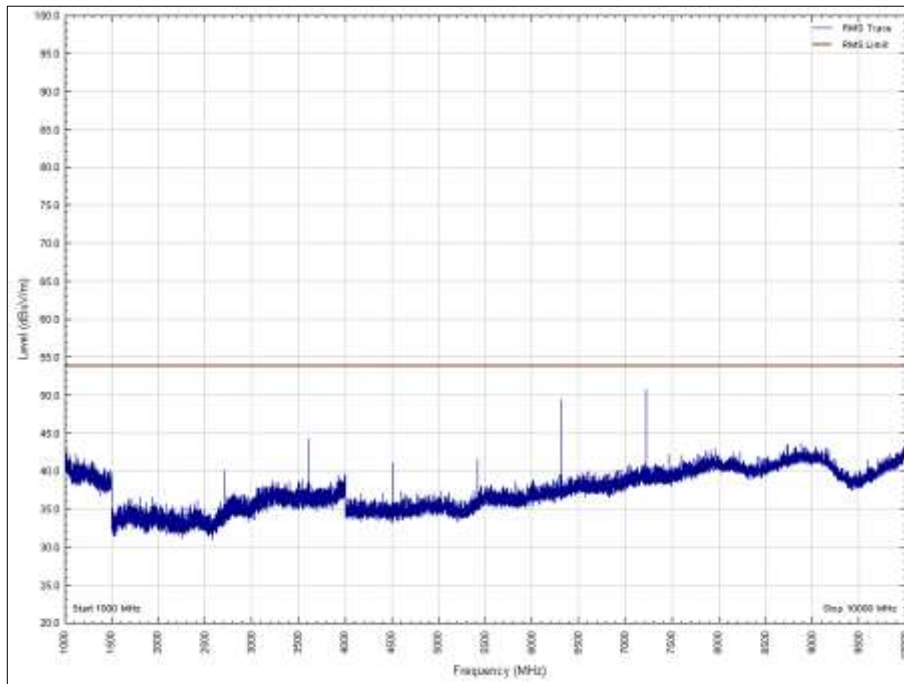

Figure 23 - 902.2 MHz, 1 GHz to 10 GHz, Vertical, Z Orientation: - Average

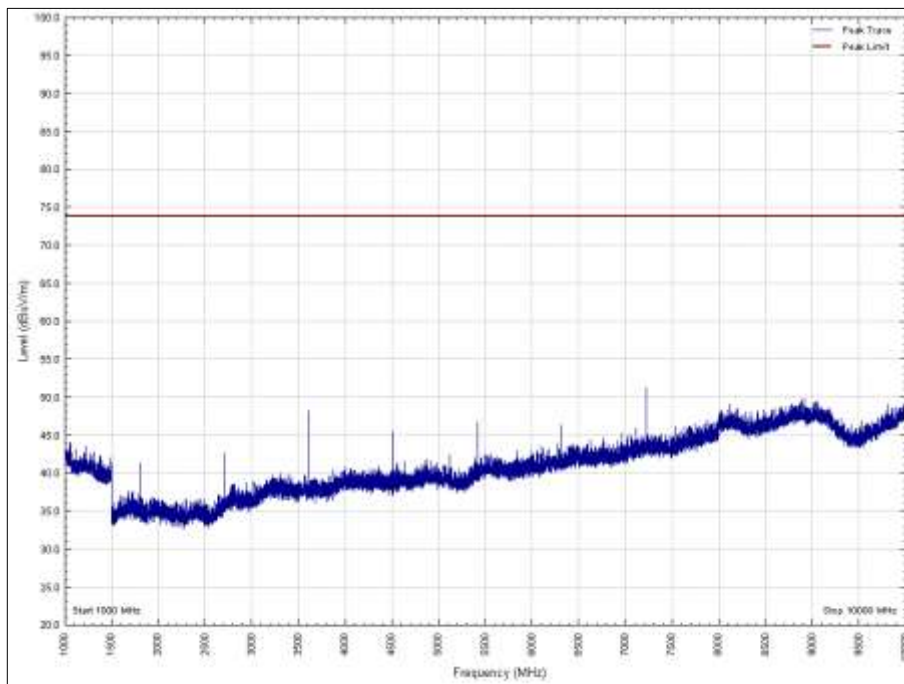

Figure 24 - 902.2 MHz, 1 GHz to 10 GHz, Horizontal, Z Orientation: - Peak

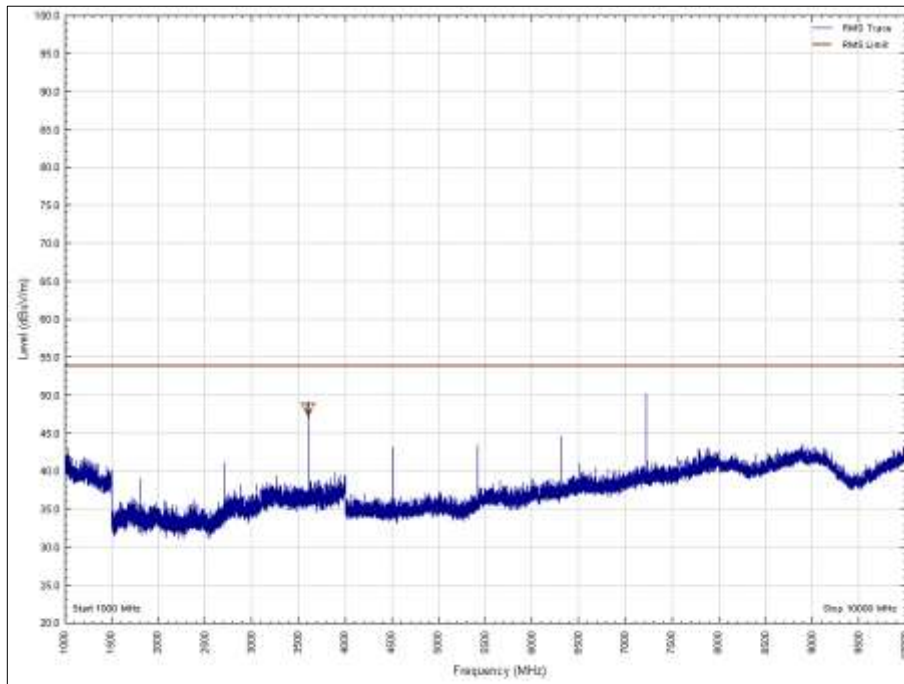

Figure 25 - 902.2 MHz, 1 GHz to 10 GHz, Horizontal, Z Orientation: - Average



Frequency (MHz)	Level (dBµV/m)	Limit (dBµV/m)	Margin (dB)	Detector	Angle (°)	Height (cm)	Polarisation	Orientation
*								

Table 12 - 915.0 MHz, 30 MHz to 1 GHz - Emission Results

*No emissions were detected within 10 dB of the limit.

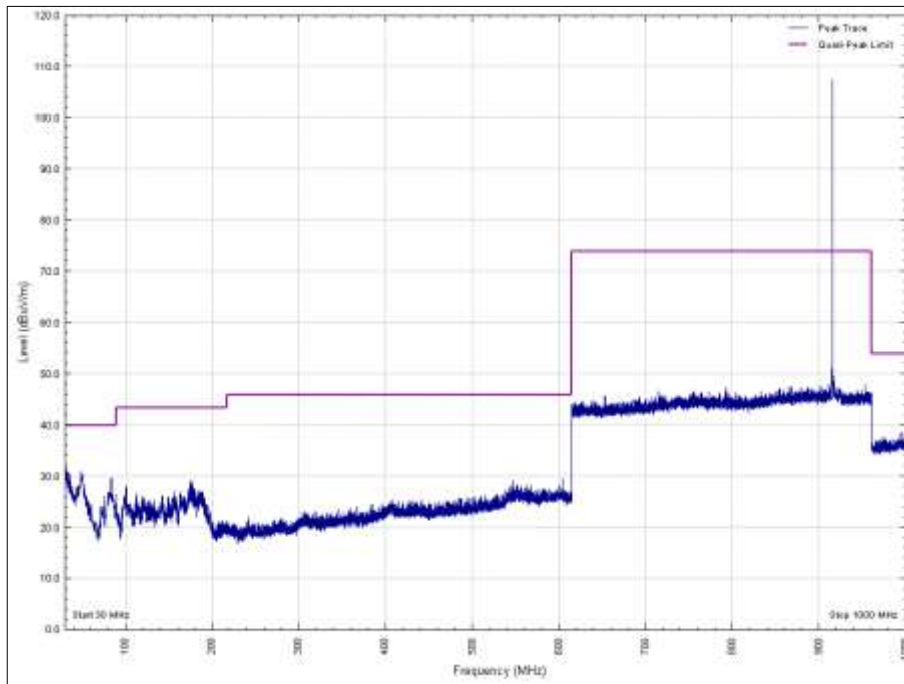

Figure 26 - 915.0 MHz, 30 MHz to 1 GHz, Vertical, X Orientation

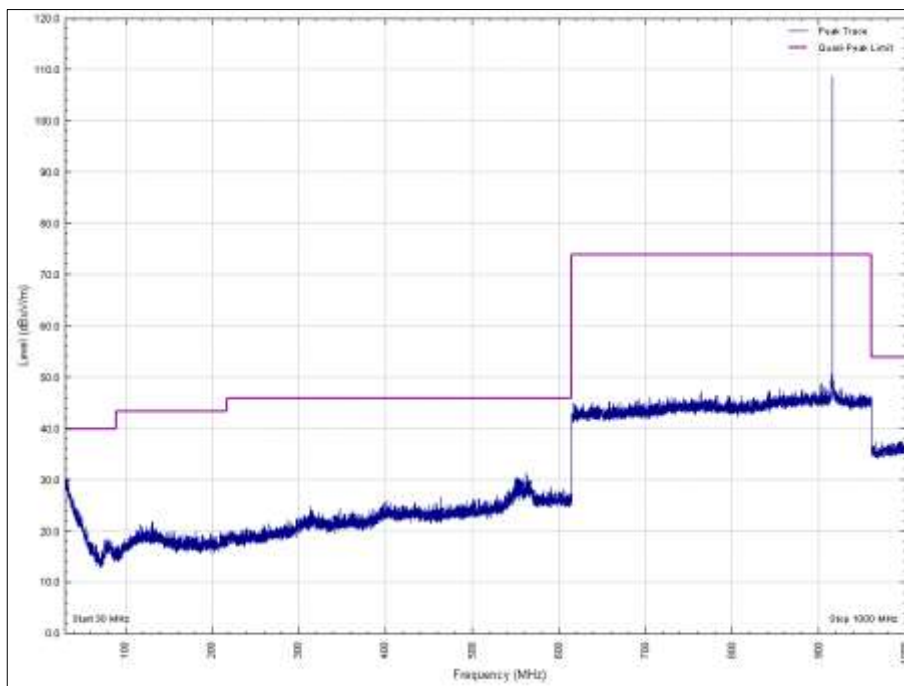

Figure 27 - 915.0 MHz, 30 MHz to 1 GHz, Horizontal, X Orientation

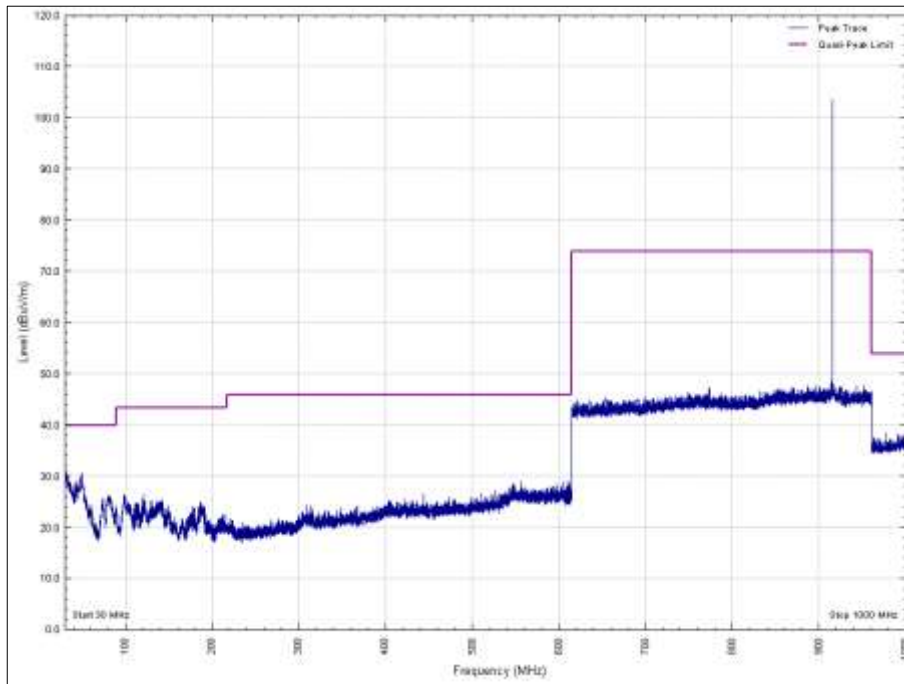

Figure 28 - 915.0 MHz, 30 MHz to 1 GHz, Vertical, Y Orientation

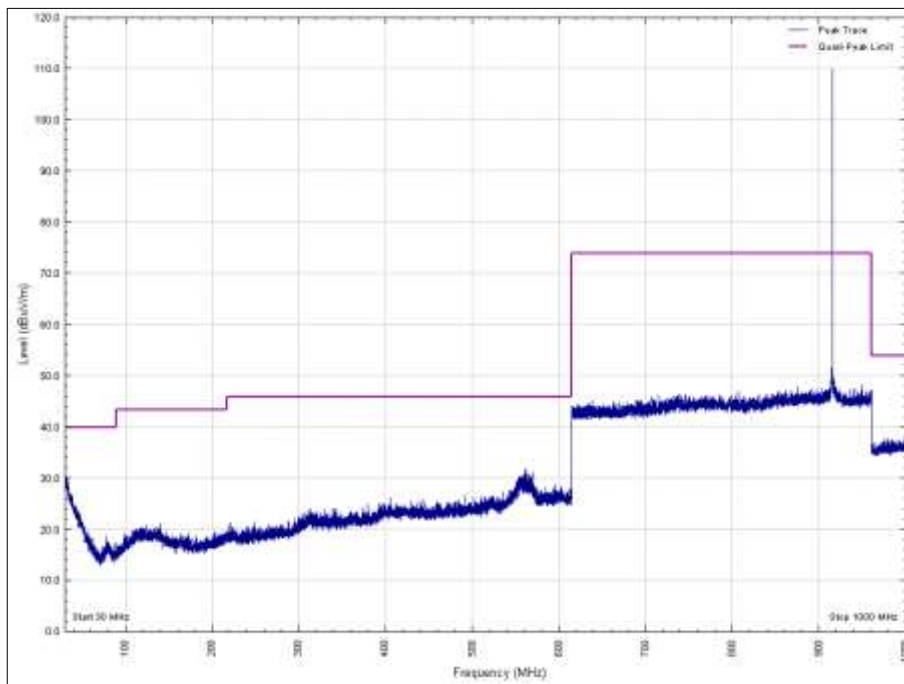

Figure 29 - 915.0 MHz, 30 MHz to 1 GHz, Horizontal, Y Orientation

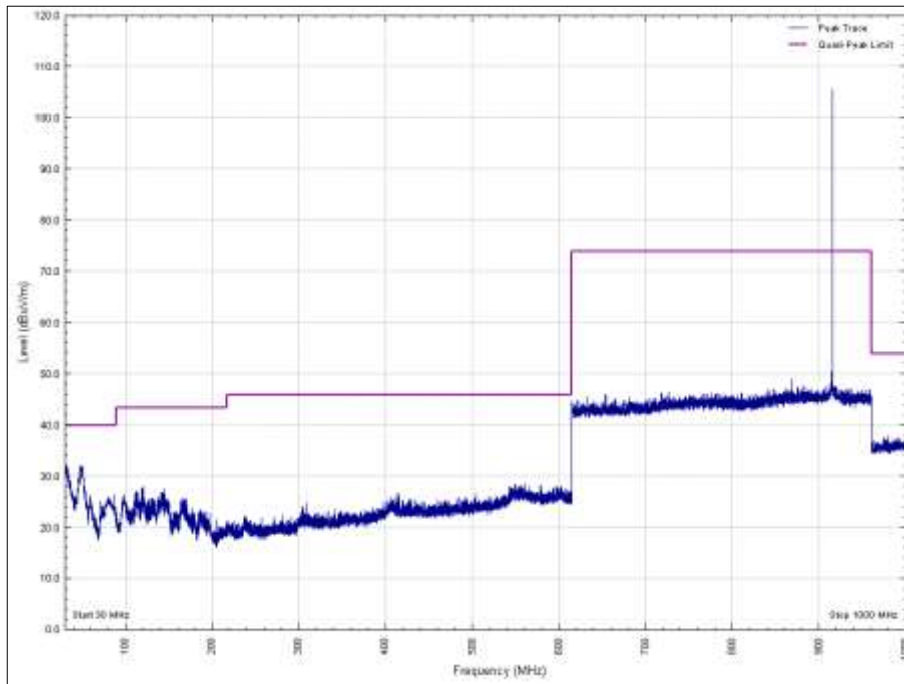

Figure 30 - 915.0 MHz, 30 MHz to 1 GHz, Vertical, Z Orientation

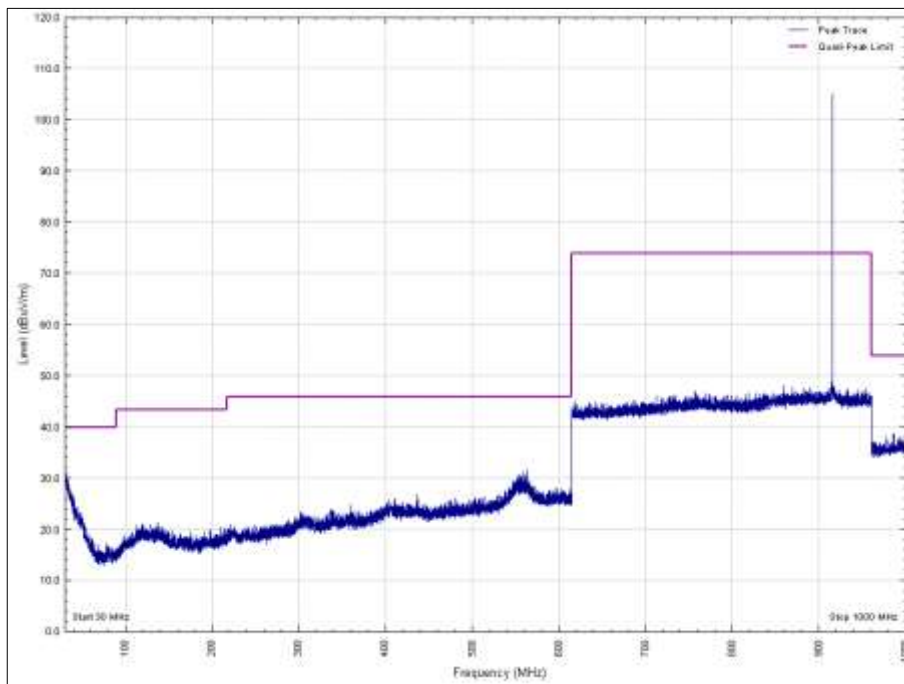

Figure 31 - 915.0 MHz, 30 MHz to 1 GHz, Horizontal, Z Orientation



Frequency (MHz)	Level (dBµV/m)	Limit (dBµV/m)	Margin (dB)	Detector	Angle (°)	Height (cm)	Polarisation	Orientation
3660.043	45.98	53.98	8.00	CISPR Average	324	358	Vertical	Y
3660.127	45.45	53.98	8.53	CISPR Average	37	100	Horizontal	Z
4574.950	44.07	53.98	9.91	CISPR Average	321	106	Horizontal	X
4575.013	47.93	53.98	6.05	CISPR Average	327	252	Horizontal	Z
4575.038	45.72	53.98	8.26	CISPR Average	24	105	Vertical	Y
7319.956	49.70	53.98	4.28	CISPR Average	263	106	Horizontal	X
7319.958	50.95	53.98	3.03	CISPR Average	338	100	Vertical	X
7319.959	48.28	53.98	5.70	CISPR Average	123	100	Horizontal	Y
7320.174	51.48	53.98	2.50	CISPR Average	348	105	Vertical	Y
7320.226	52.38	53.98	1.60	CISPR Average	39	184	Vertical	Z
7320.041	51.89	53.98	2.09	CISPR Average	12	100	Horizontal	Z

Table 13 - 915.0 MHz - 1 GHz to 10 GHz Emissions Results

No other emissions were detected within 10 dB of the limit.

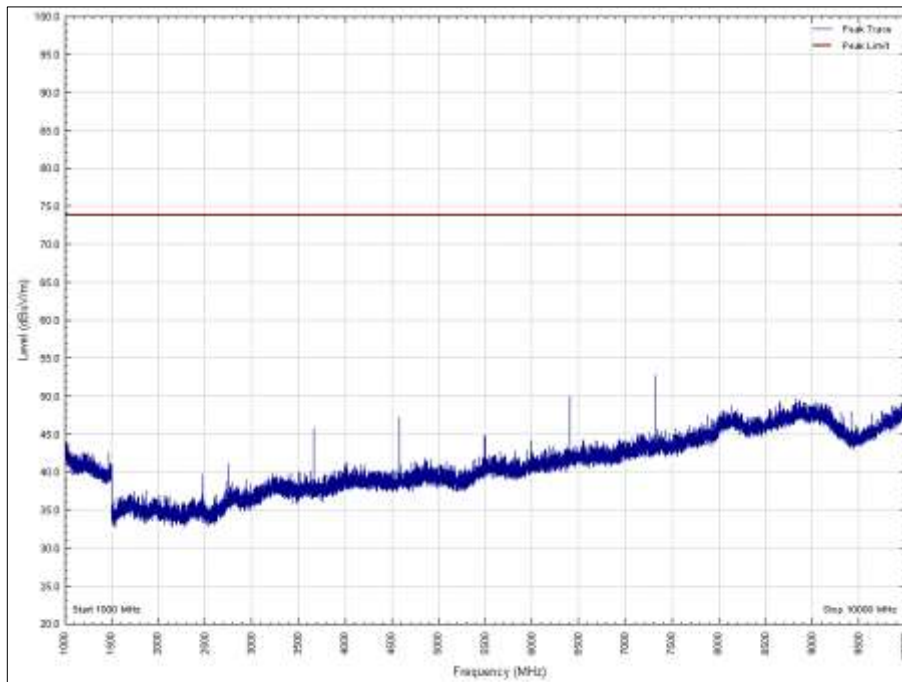

Figure 32 - 915.0 MHz - 1 GHz to 10 GHz, Vertical, EUT Orientation: X, Peak

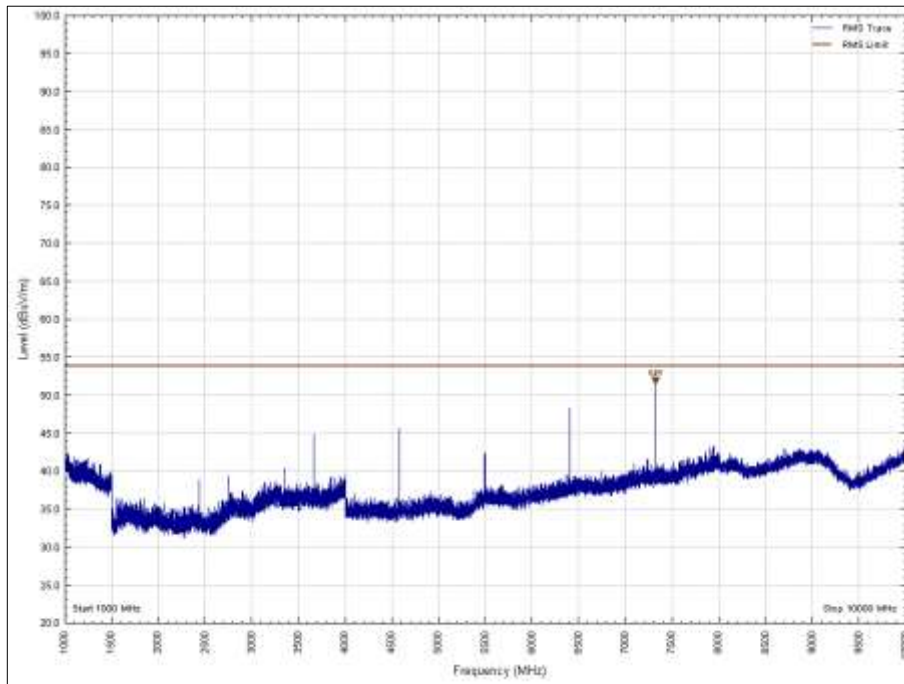

Figure 33 - 915.0 MHz - 1 GHz to 10 GHz, Vertical, EUT Orientation: X, Average

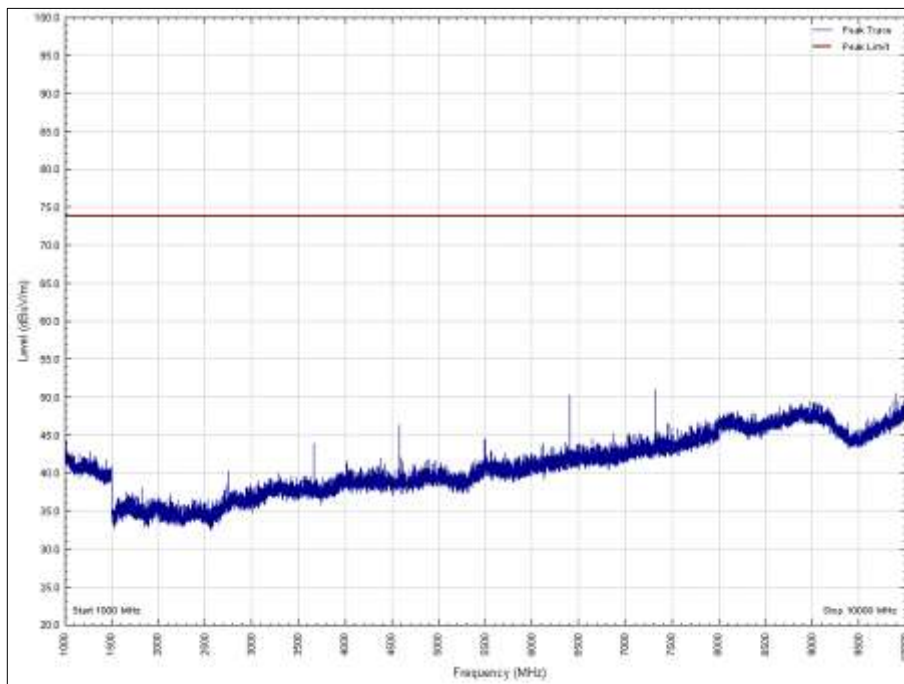

Figure 34 - 915.0 MHz - 1 GHz to 10 GHz, Horizontal, EUT Orientation: X, Peak

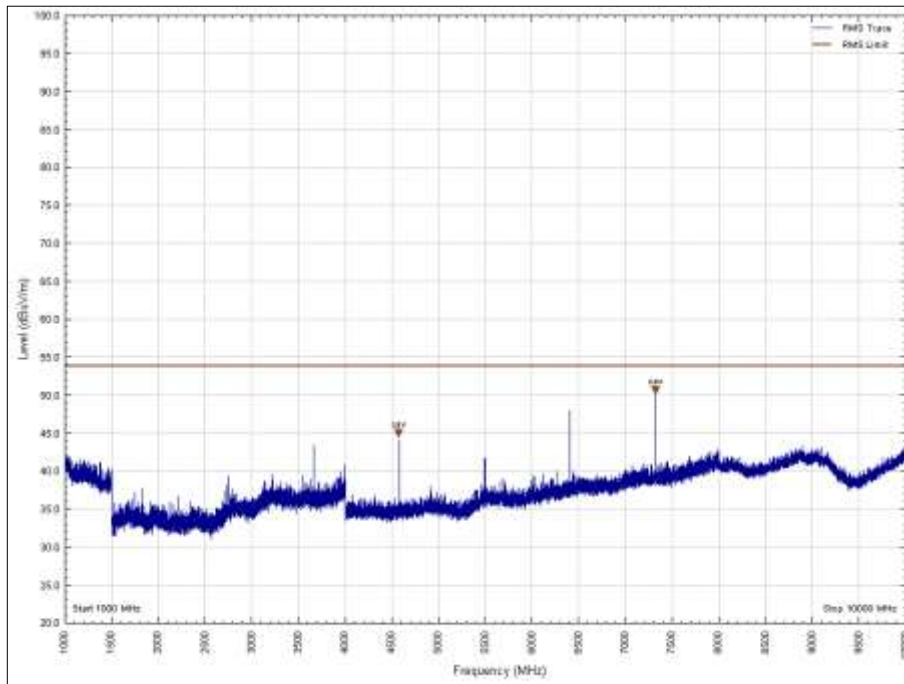

Figure 35 - 915.0 MHz - 1 GHz to 10 GHz, Horizontal, EUT Orientation: X, Average

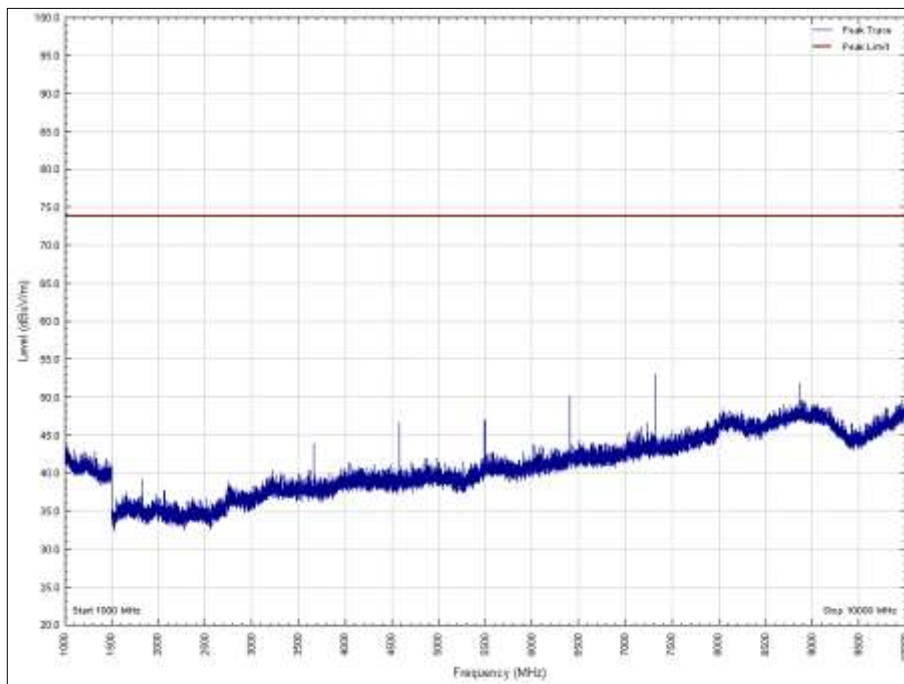

Figure 36 - 915.0 MHz - 1 GHz to 10 GHz, Vertical, EUT Orientation: Y, Peak

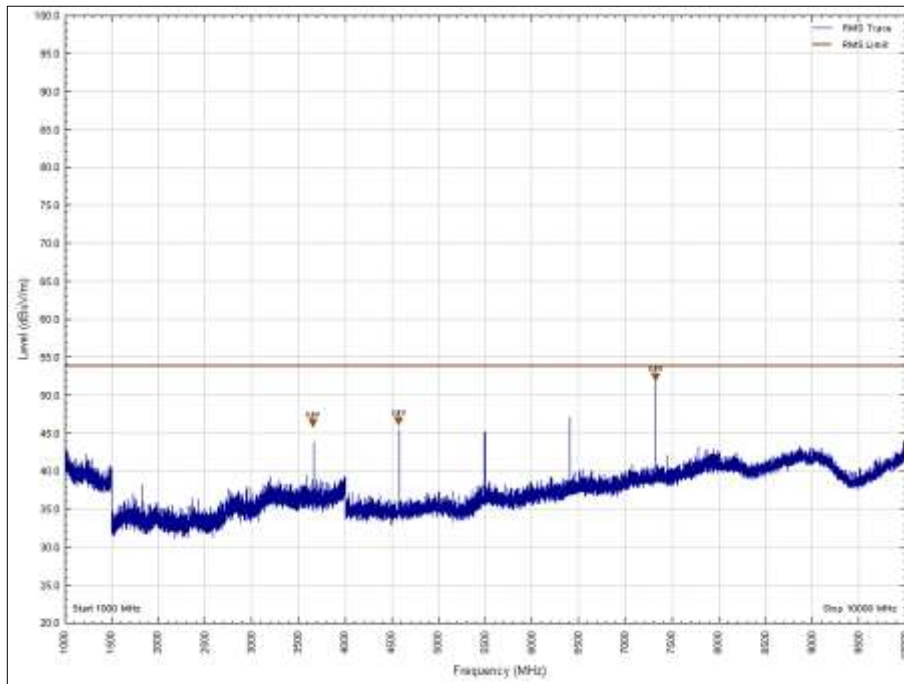

Figure 37 - 915.0 MHz - 1 GHz to 10 GHz, Vertical, EUT Orientation: Y, Average

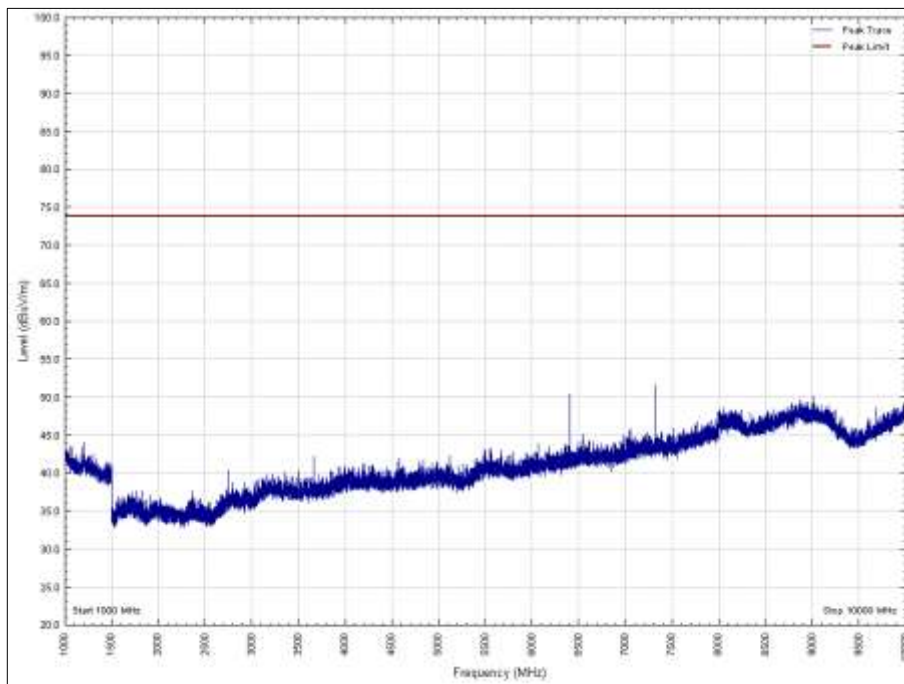

Figure 38 - 915.0 MHz - 1 GHz to 10 GHz, Horizontal, EUT Orientation: Y, Peak

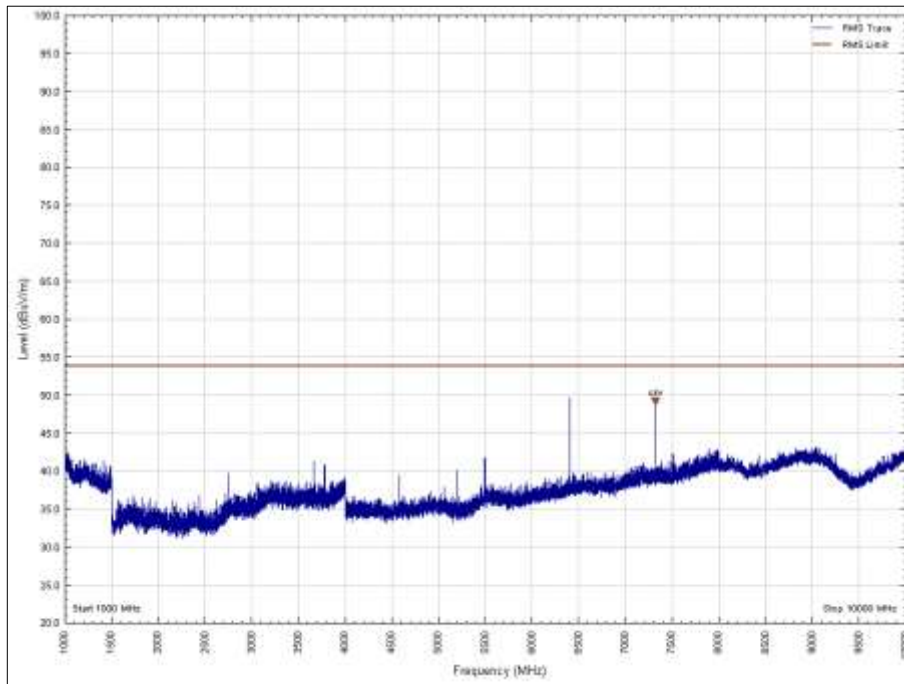

Figure 39 - 915.0 MHz - 1 GHz to 10 GHz, Horizontal, EUT Orientation: Y, Average

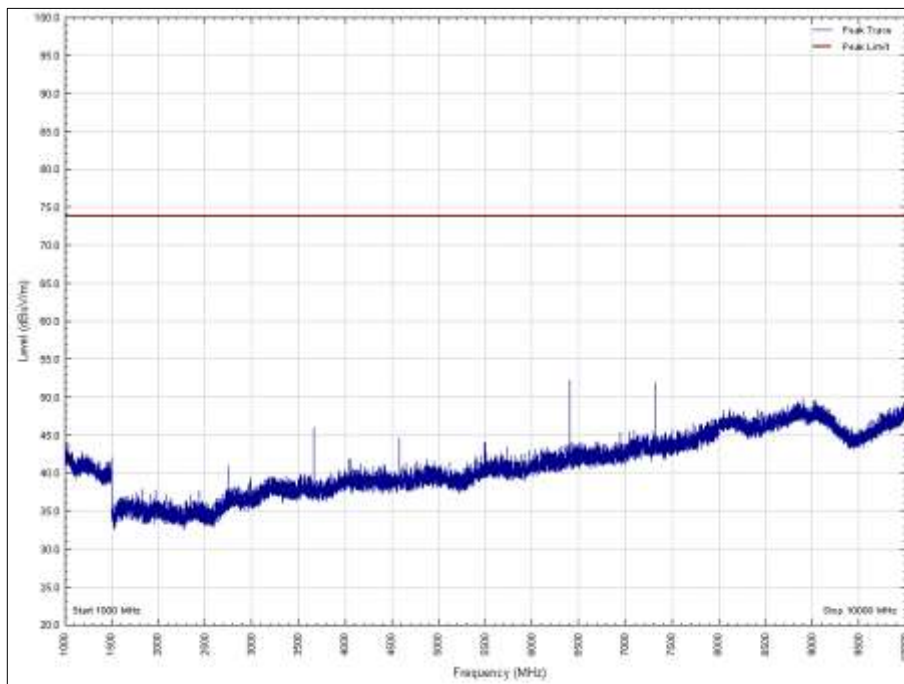

Figure 40 - 915.0 MHz - 1 GHz to 10 GHz, Vertical, EUT Orientation: Z, Peak

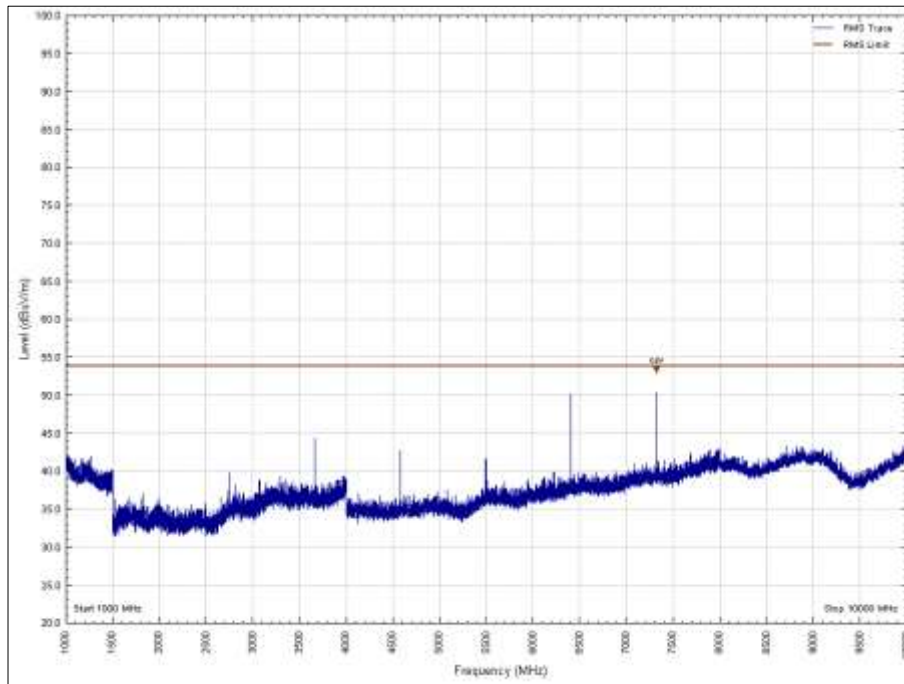

Figure 41 - 915.0 MHz - 1 GHz to 10 GHz, Vertical, EUT Orientation: Z, Average

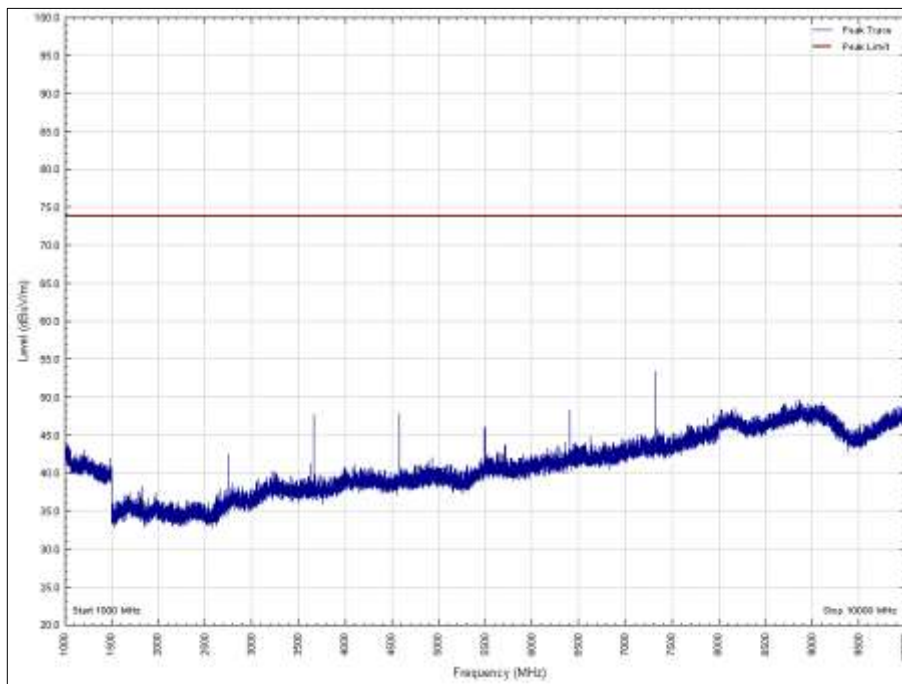

Figure 42 - 915.0 MHz - 1 GHz to 10 GHz, Horizontal, EUT Orientation: Z, Peak

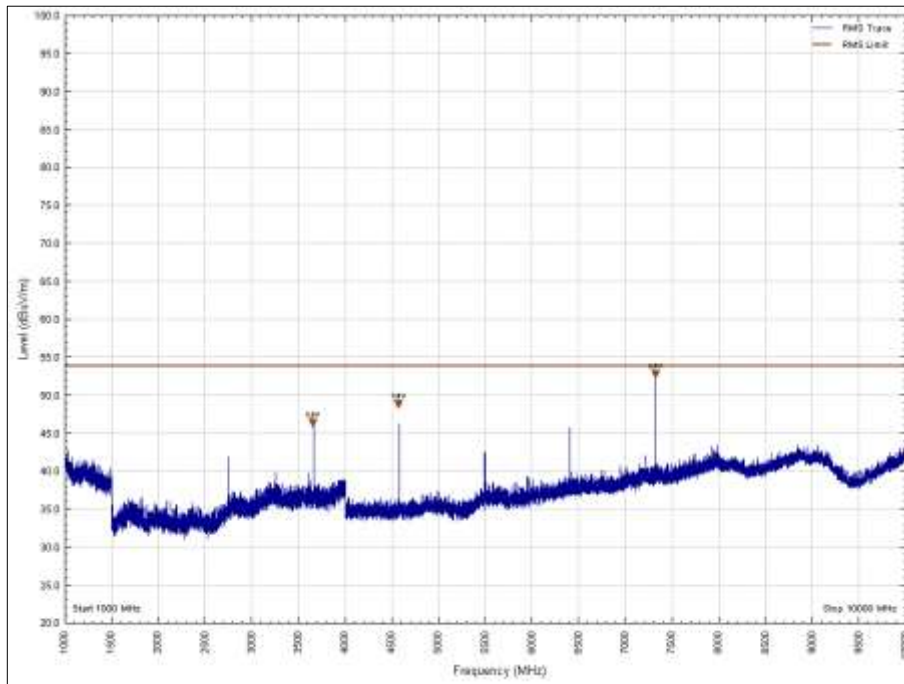

Figure 43 - 915.0 MHz - 1 GHz to 10 GHz, Horizontal, EUT Orientation: Z, Average



Frequency (MHz)	Level (dBµV/m)	Limit (dBµV/m)	Margin (dB)	Detector	Angle (°)	Height (cm)	Polarisation	Orientation
*								

Table 14 - 927.4 MHz, 30 MHz to 1 GHz - Emission Results

*No emissions were detected within 10 dB of the limit.

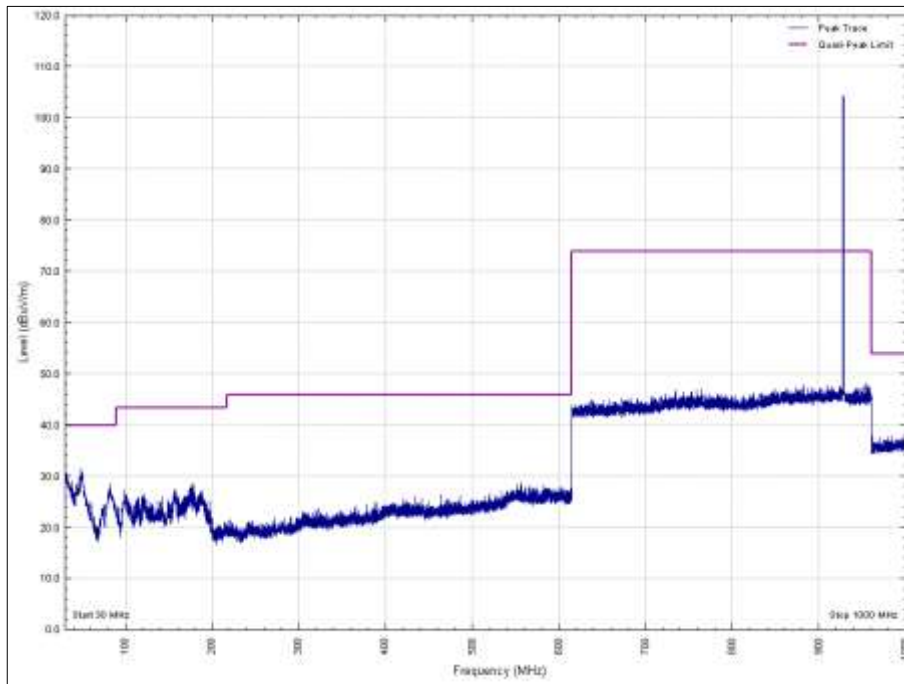

Figure 44 - 927.4 MHz, 30 MHz to 1 GHz, Vertical, X Orientation

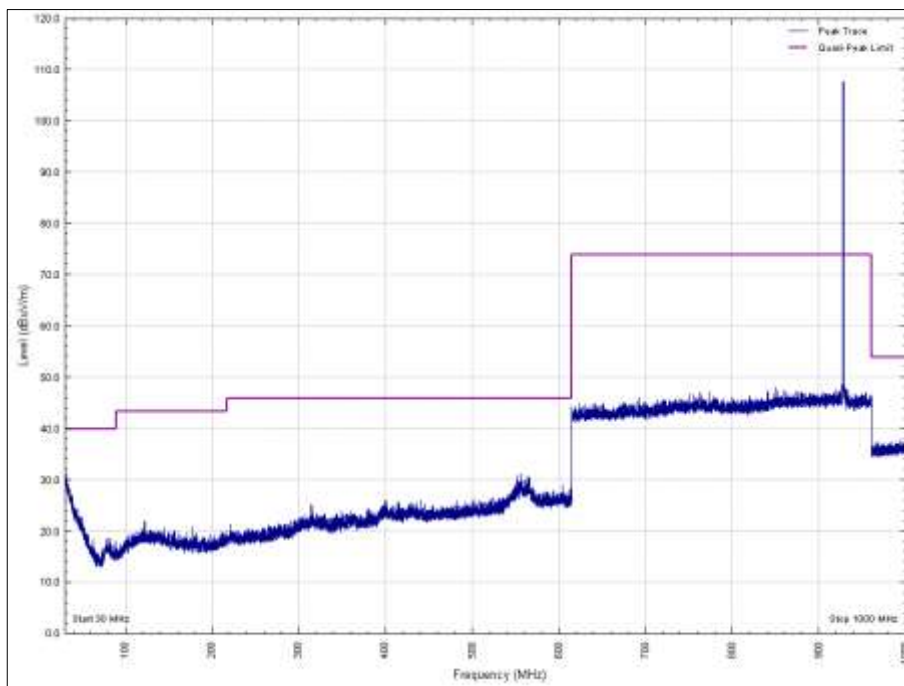

Figure 45 - 927.4 MHz, 30 MHz to 1 GHz, Horizontal, X Orientation

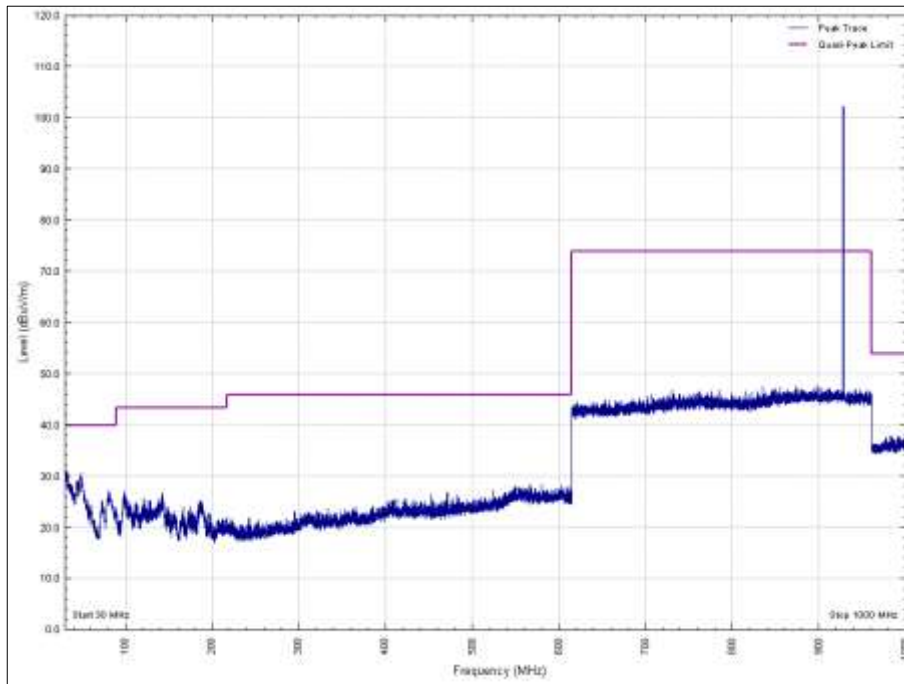

Figure 46 - 927.4 MHz, 30 MHz to 1 GHz, Vertical, Y Orientation

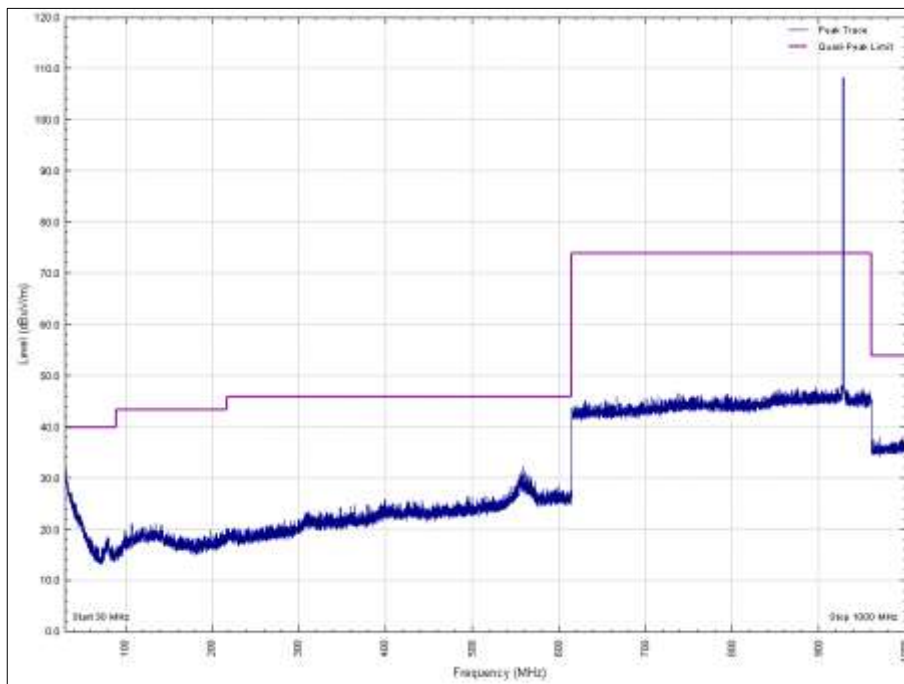

Figure 47 - 927.4 MHz, 30 MHz to 1 GHz, Horizontal, Y Orientation

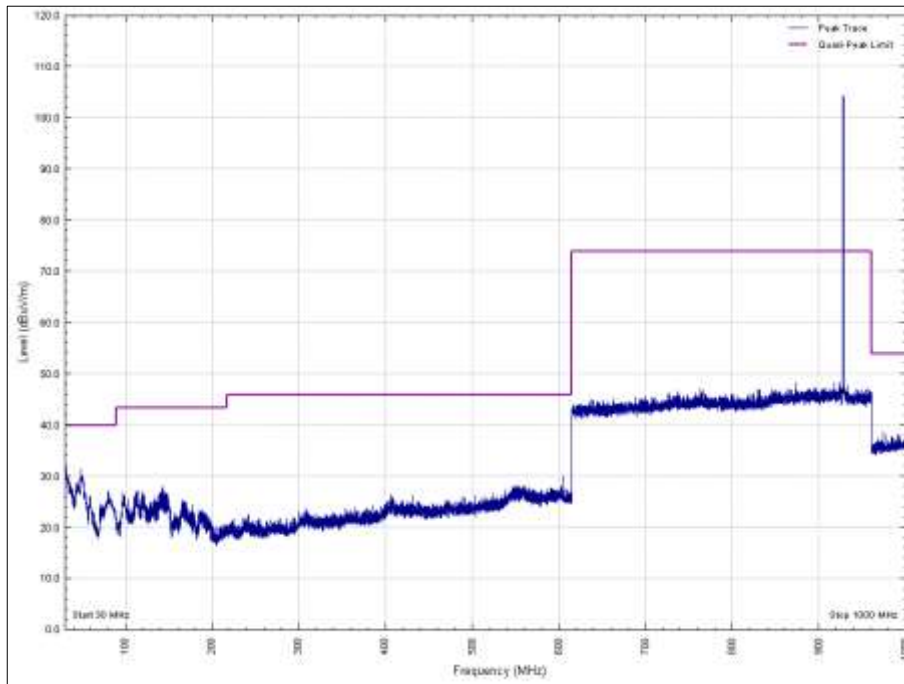

Figure 48 - 927.4 MHz, 30 MHz to 1 GHz, Vertical, Z Orientation

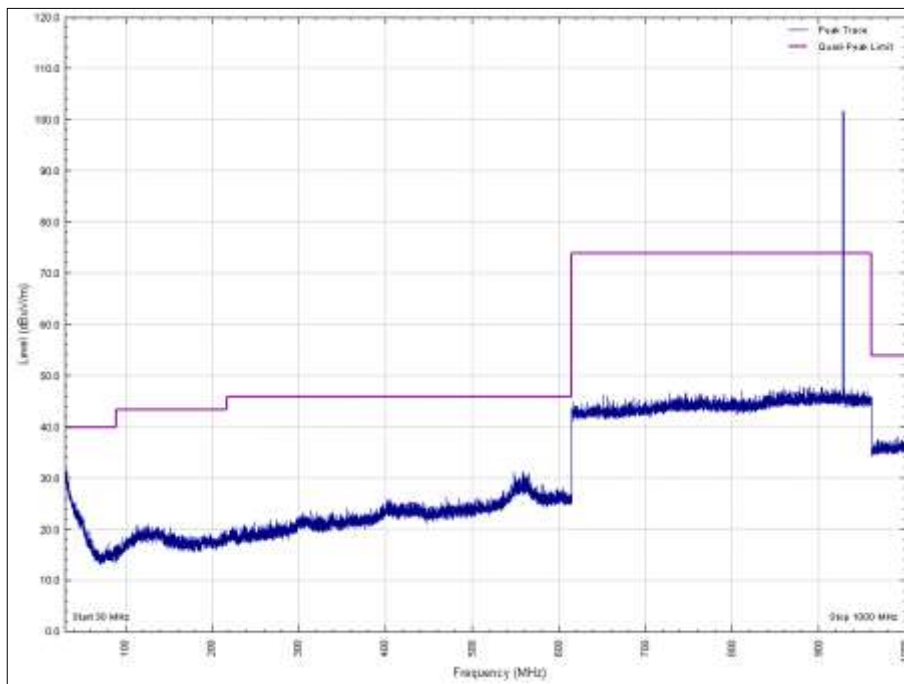

Figure 49 - 927.4 MHz, 30 MHz to 1 GHz, Horizontal, Z Orientation



Frequency (MHz)	Level (dBµV/m)	Limit (dBµV/m)	Margin (dB)	Detector	Angle (°)	Height (cm)	Polarisation	Orientation
4637.019	45.75	53.98	8.23	CISPR Average	323	104	Vertical	Y
4637.040	47.09	53.98	6.89	CISPR Average	326	249	Horizontal	Z
7419.240	49.24	53.98	4.74	CISPR Average	169	104	Vertical	X
7419.282	48.70	53.98	5.28	CISPR Average	262	104	Horizontal	X
7419.210	49.59	53.98	4.39	CISPR Average	351	101	Vertical	Y
7419.290	46.80	53.98	7.18	CISPR Average	126	104	Horizontal	Y
7419.110	46.77	53.98	6.21	CISPR Average	78	100	Vertical	Z
7419.402	49.53	53.98	4.45	CISPR Average	12	366	Horizontal	Z

Table 15 - 927.4 MHz - 1 GHz to 10 GHz Emissions Results

No other emissions were detected within 10 dB of the limit.

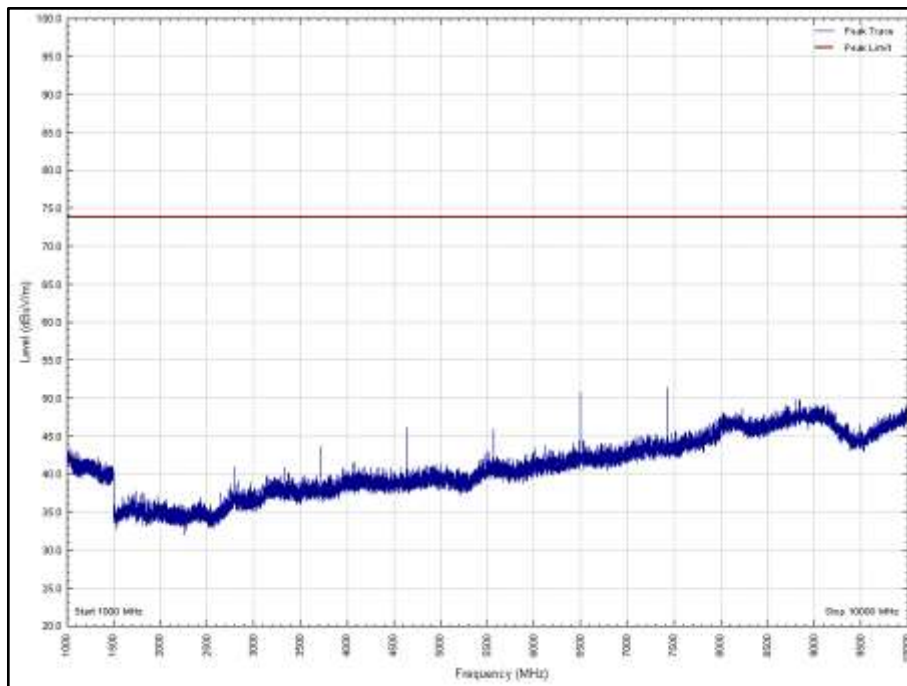

Figure 50 - 927.4 MHz - 1 GHz to 25 GHz, Vertical, EUT Orientation: X, Peak

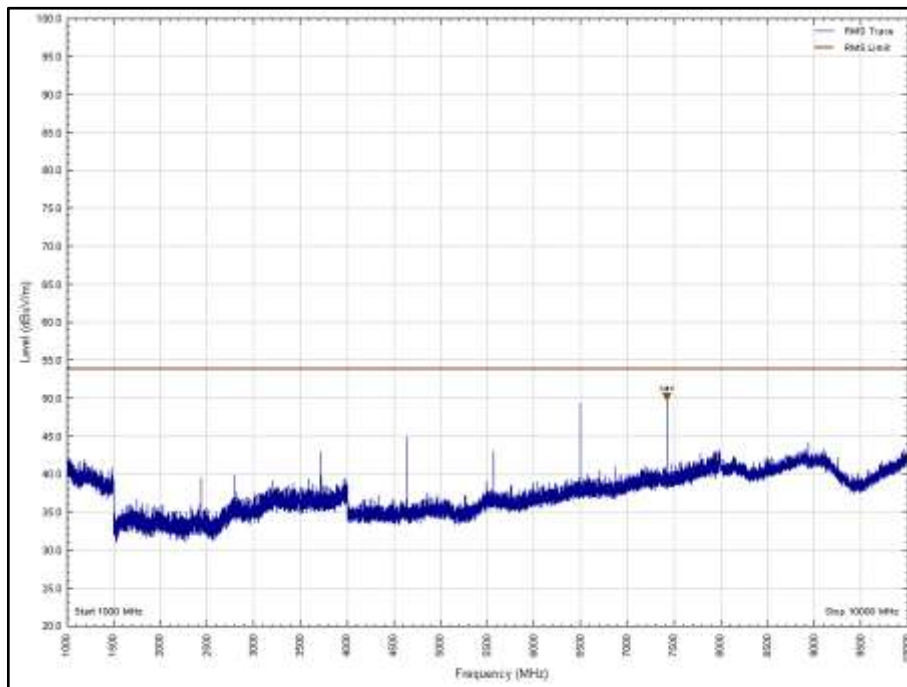

Figure 51 - 927.4 MHz - 1 GHz to 25 GHz, Vertical, EUT Orientation: X, Average

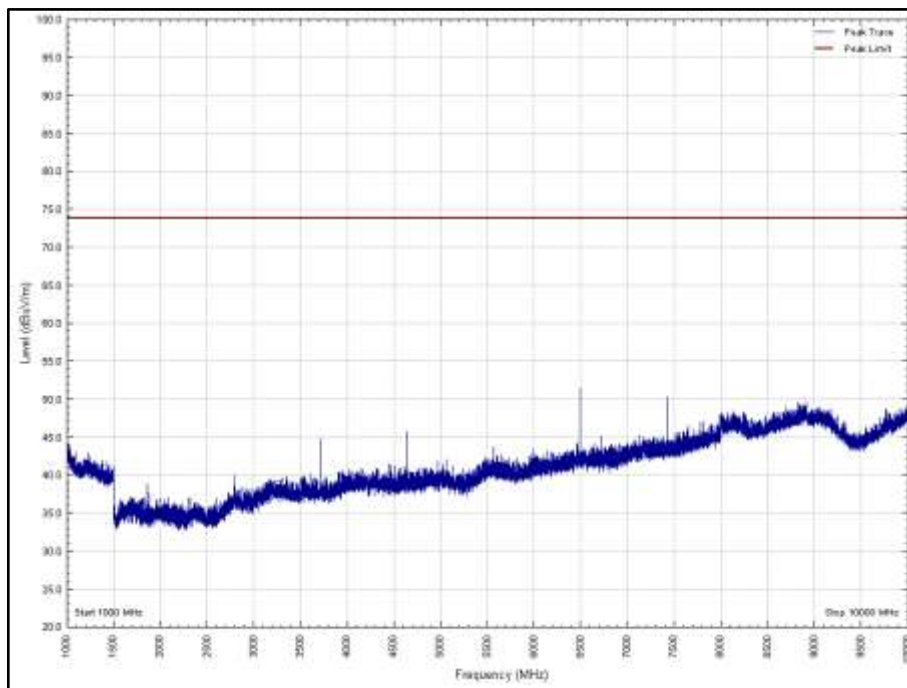

Figure 52 - 927.4 MHz - 1 GHz to 25 GHz, Horizontal, EUT Orientation: X, Peak

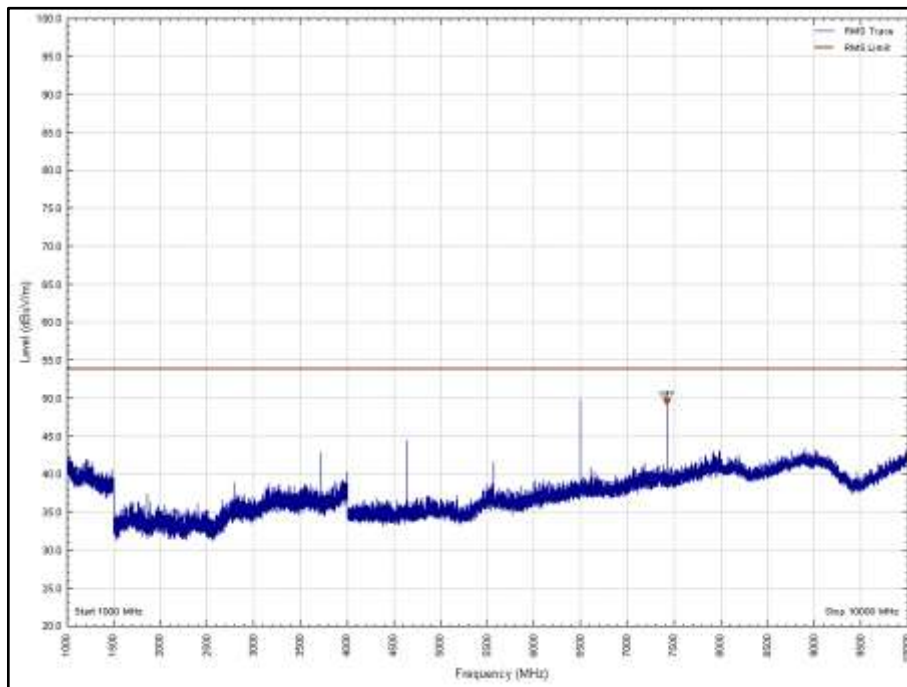

Figure 53 - 927.4 MHz - 1 GHz to 25 GHz, Horizontal, EUT Orientation: X, Average

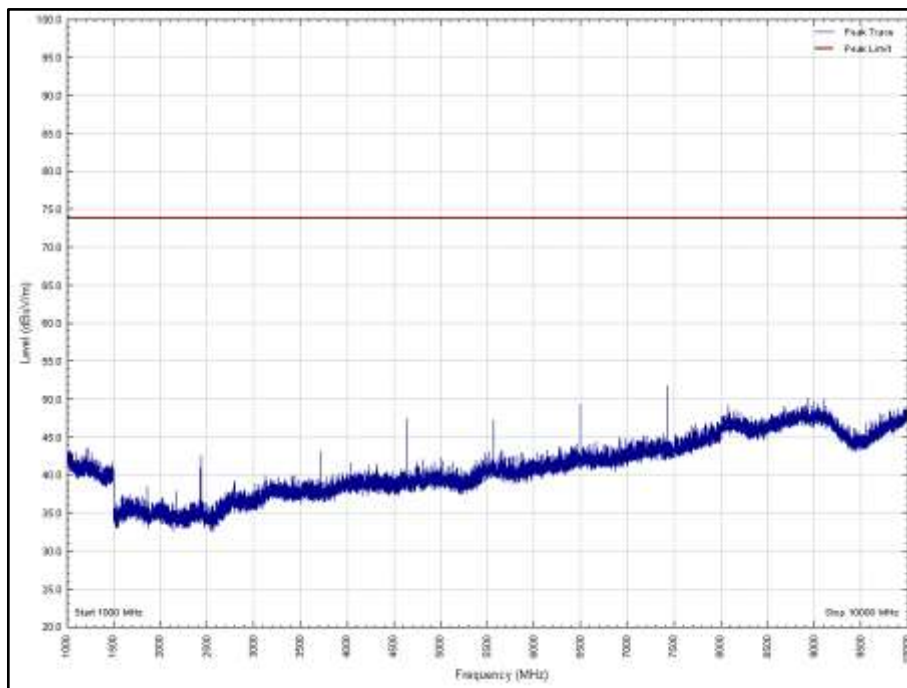

Figure 54 - 927.4 MHz - 1 GHz to 25 GHz, Vertical, EUT Orientation: Y, Peak

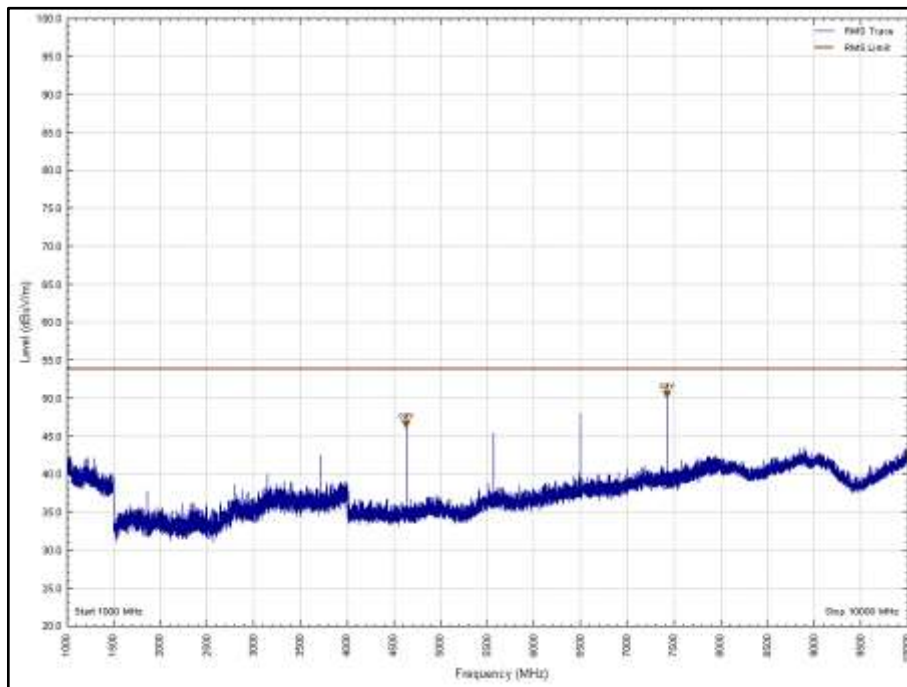

Figure 55 - 927.4 MHz - 1 GHz to 25 GHz, Vertical, EUT Orientation: Y, Average

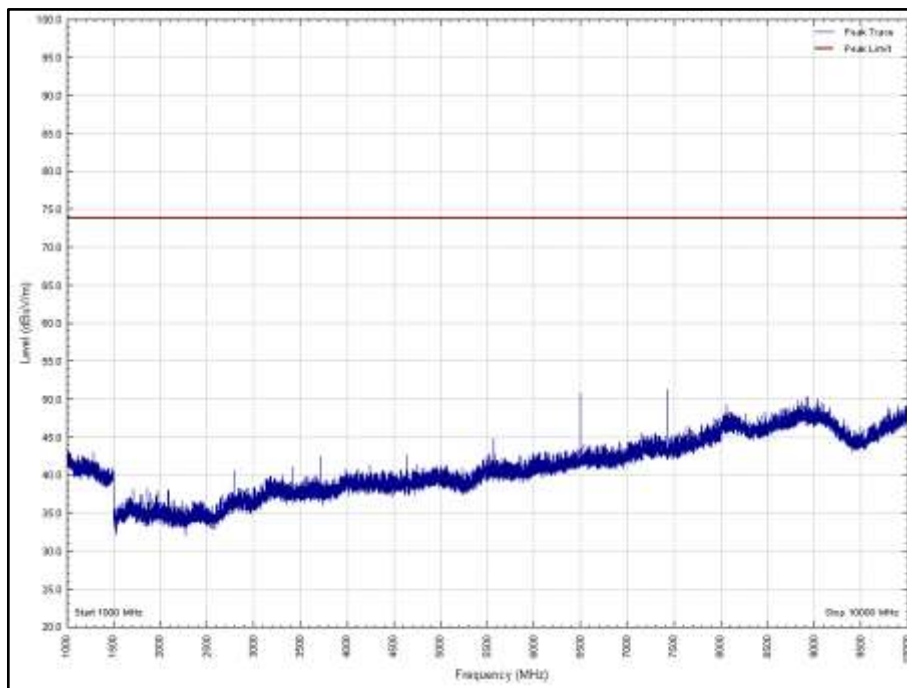

Figure 56 - 927.4 MHz - 1 GHz to 25 GHz, Horizontal, EUT Orientation: Y, Peak

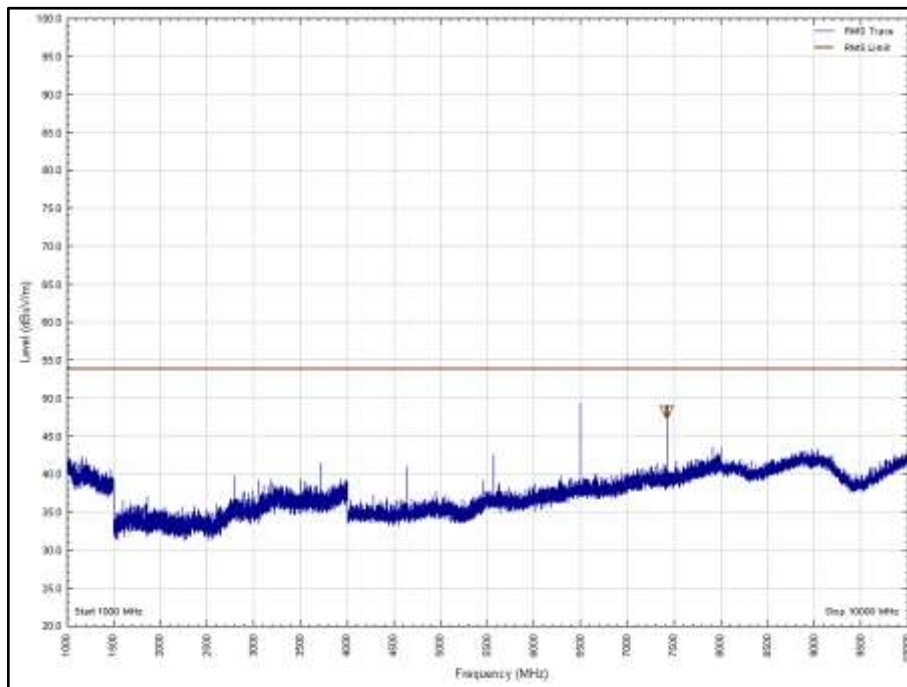

Figure 57 - 927.4 MHz - 1 GHz to 25 GHz, Horizontal, EUT Orientation: Y, Average

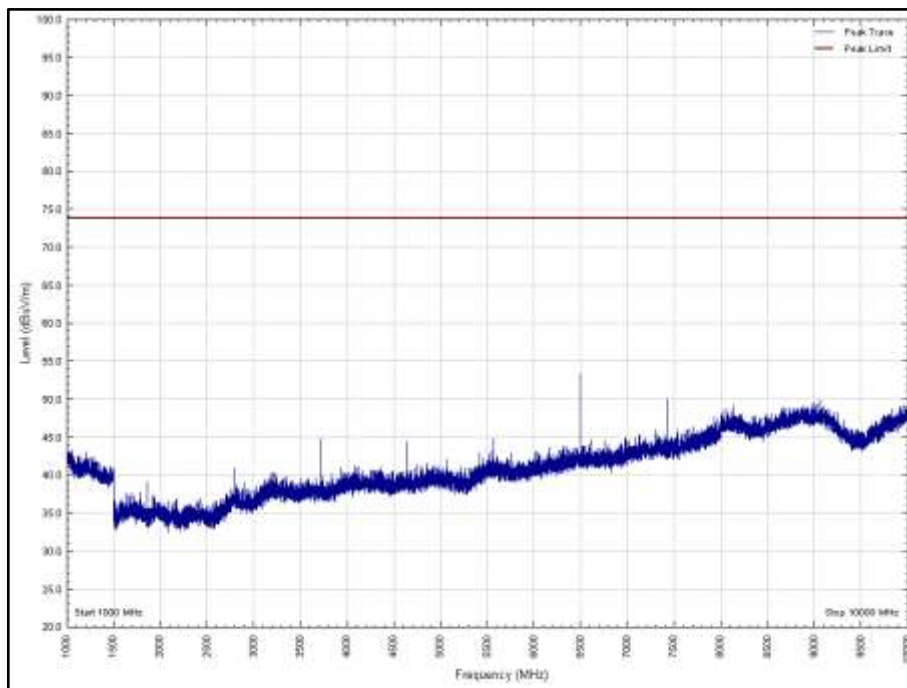

Figure 58 - 927.4 MHz - 1 GHz to 25 GHz, Vertical, EUT Orientation: Z, Peak

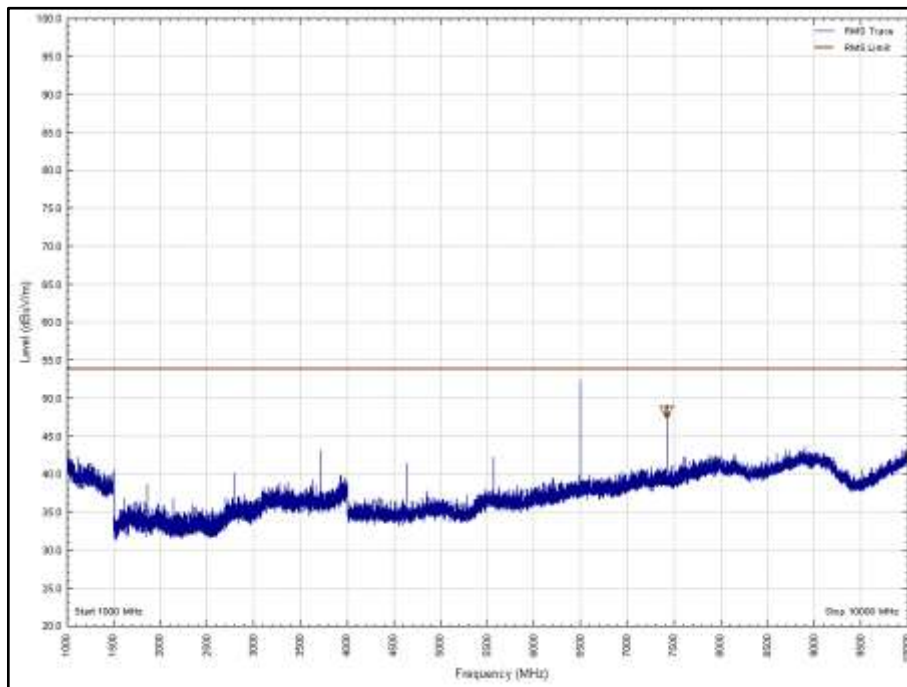

Figure 59 - 927.4 MHz - 1 GHz to 25 GHz, Vertical, EUT Orientation: Z, Average

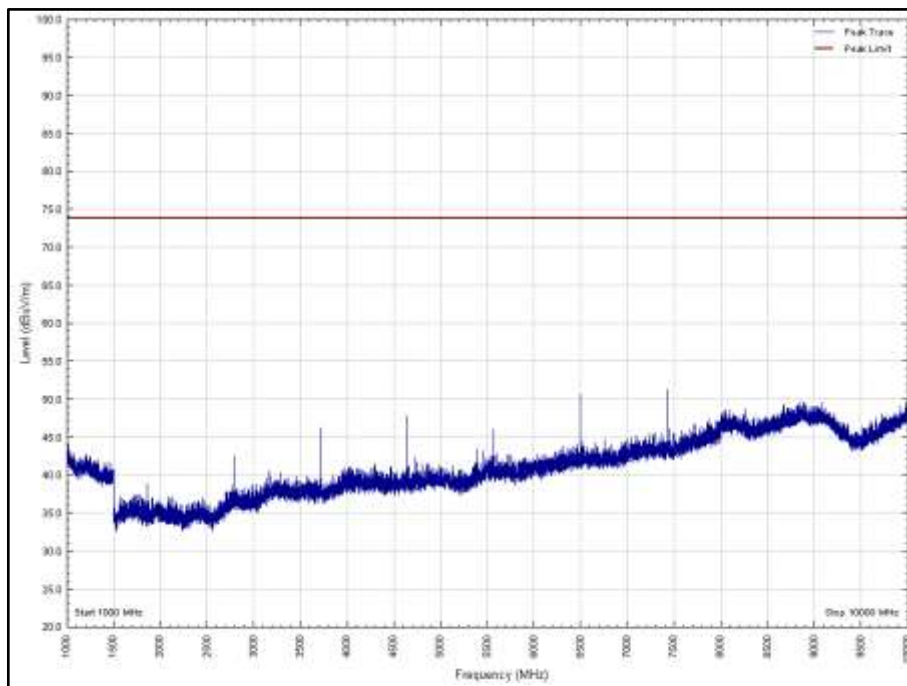

Figure 60 - 927.4 MHz - 1 GHz to 25 GHz, Horizontal, EUT Orientation: Z, Peak

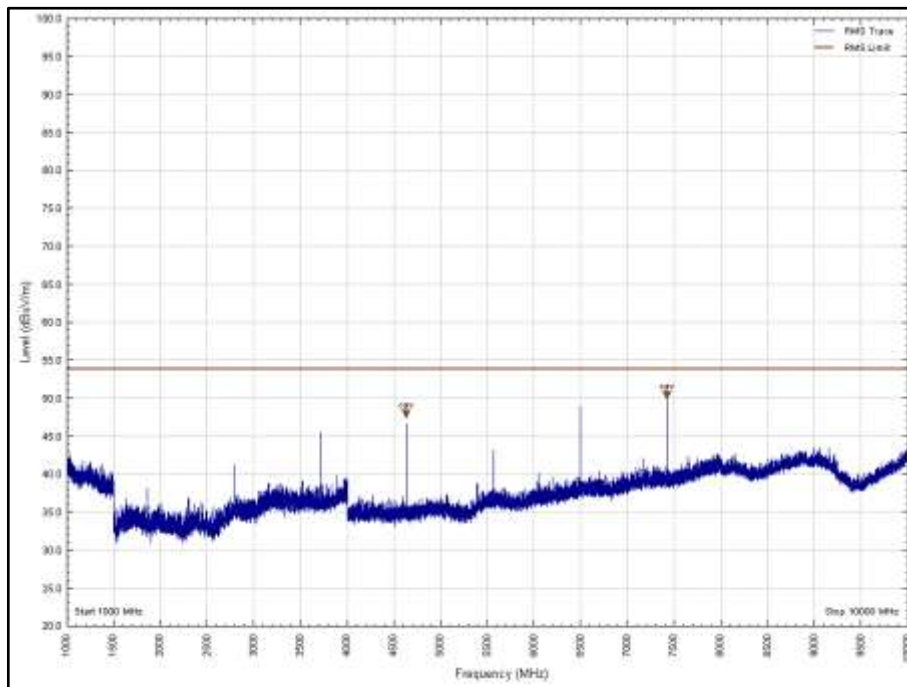

Figure 61 - 927.4 MHz - 1 GHz to 25 GHz, Horizontal, EUT Orientation: Z, Average

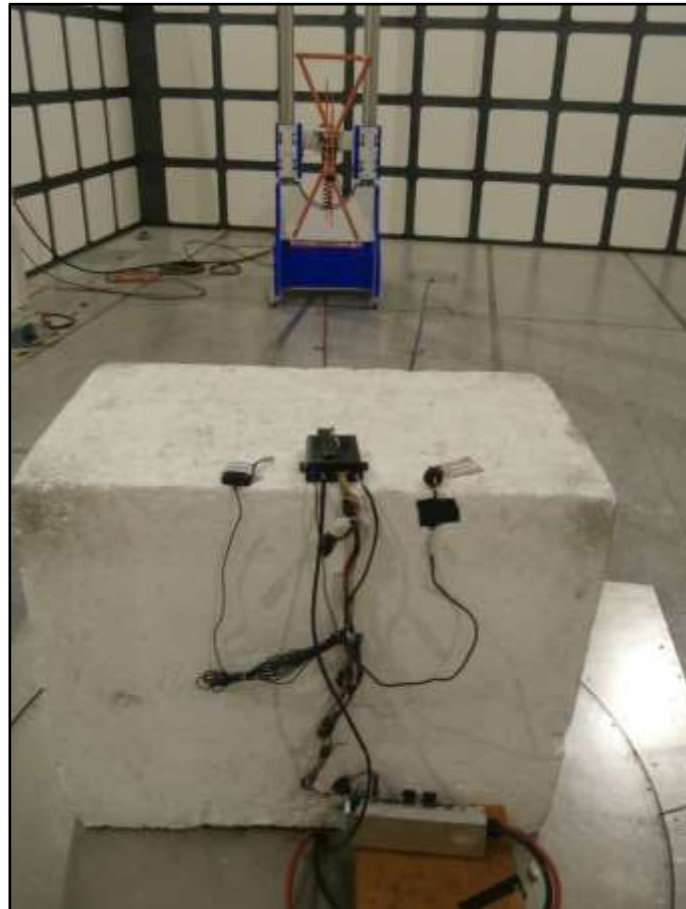

Figure 62 - Test Setup – 30 MHz to 1 GHz – X Orientation



Figure 63 - Test Setup - 30 MHz to 1 GHz – Y Orientation

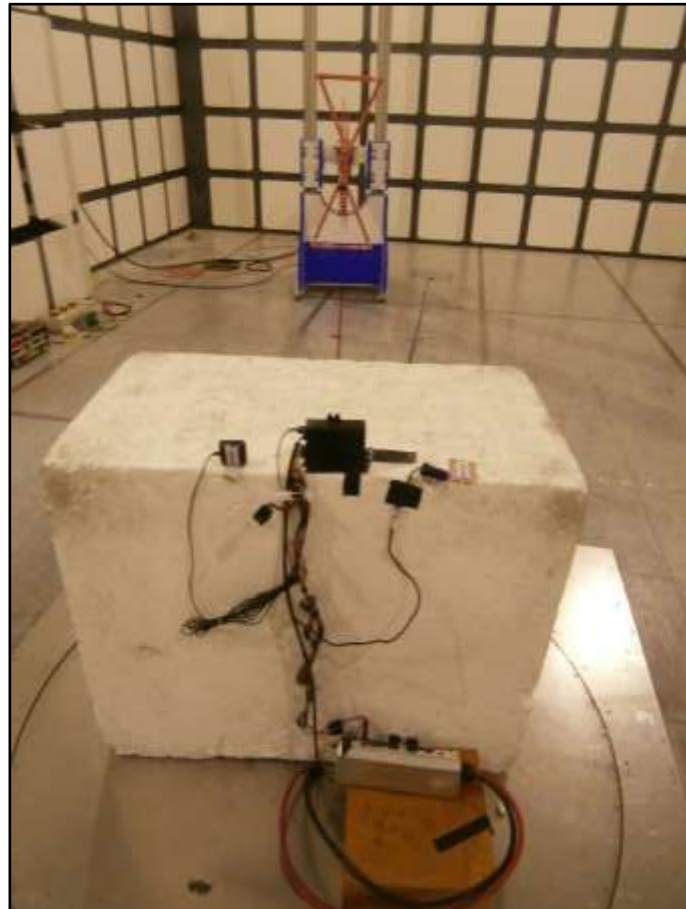

Figure 64 - Test Setup - 30 MHz to 1 GHz – Z Orientation



Figure 65 - Test Setup - 1 GHz to 10 GHz – X Orientation

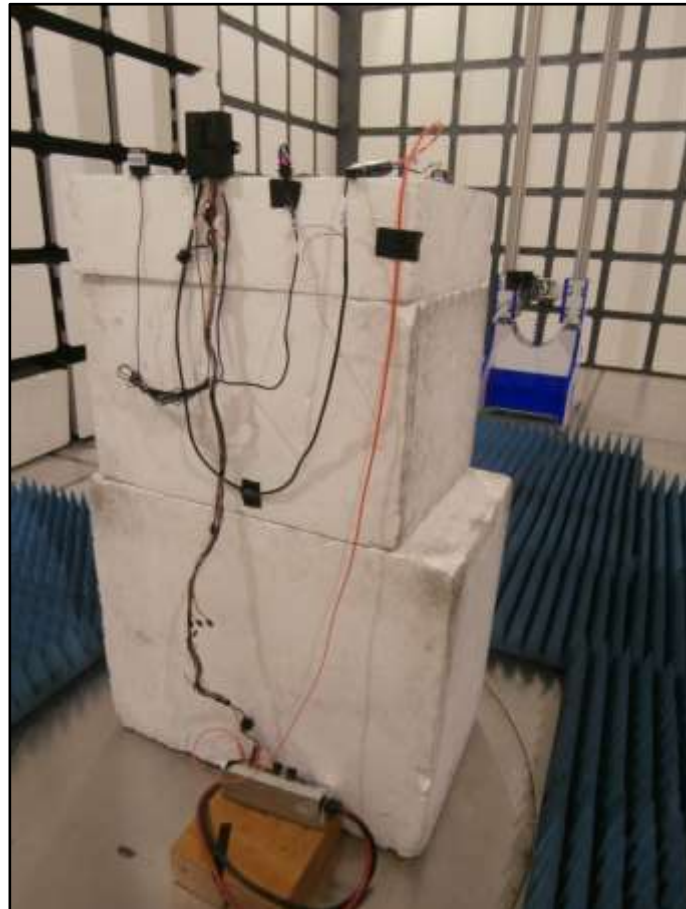

Figure 66 - Test Setup - 1 GHz to 10 GHz – Y Orientation

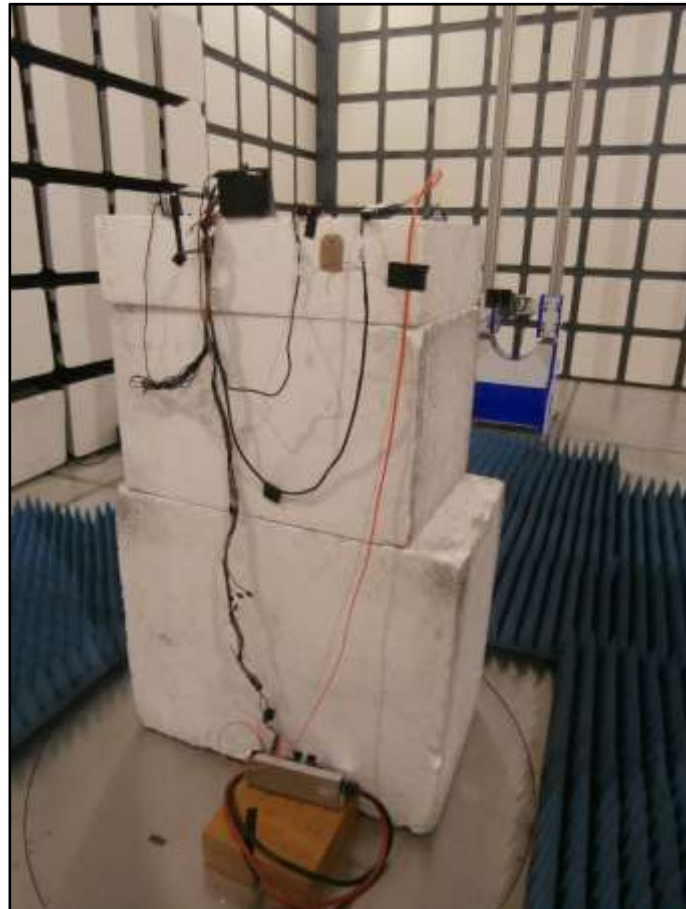

Figure 67 - Test Setup - 1 GHz to 10 GHz – Z Orientation

FCC 47 CFR Part 15, Limit Clause 15.247 (d)

In any 100 kHz bandwidth outside the frequency band in which the spread spectrum or digitally modulated intentional radiator is operating, the radio frequency power that is produced by the intentional radiator shall be at least 20 dB below that in the 100 kHz bandwidth within the band that contains the highest level of the desired power, based on either an RF conducted or a radiated measurement, provided the transmitter demonstrates compliance with the peak conducted power limits. If the transmitter complies with the conducted power limits based on the use of RMS averaging over a time interval, as permitted under paragraph (b)(3) of this section, the attenuation required under this paragraph shall be 30 dB instead of 20 dB.

Attenuation below the general limits specified in § 15.209(a) is not required. In addition, radiated emissions which fall in the restricted bands, as defined in § 15.205(a), must also comply with the radiated emission limits specified in 15.209(a)



2.3.7 Test Location and Test Equipment Used

This test was carried out in EMC Chamber 5.

Instrument	Manufacturer	Type No	TE No	Calibration Period (months)	Calibration Due
Antenna 18-40GHz (Double Ridge Guide)	Link Microtek Ltd	AM180HA-K-TU2	230	24	02-May-2020
Pre-Amplifier	Phase One	PS04-0086	1533	12	04-Aug-2020
Network Analyser	Rohde & Schwarz	ZVA 40	3548	12	11-Dec-2020
18GHz - 40GHz Pre-Amplifier	Phase One	PS04-0087	1534	12	18-Feb-2021
Screened Room (5)	Rainford	Rainford	1545	36	23-Jan-2021
Turntable Controller	Inn-Co GmbH	CO 1000	1606	-	TU
DC Power Supply	Hewlett Packard	6269B	1909	-	TU
Multimeter	Iso-tech	IDM101	2417	12	11-Nov-2020
Antenna with permanent attenuator (Bilog)	Chase	CBL6143	2904	24	30-Sep-2021
Comb Generator	Schaffner	RSG1000	3034	-	TU
EMI Test Receiver	Rohde & Schwarz	ESU40	3506	12	03-Jan-2021
'2.92mm' - '2.92mm' RF Cable (2m)	Rhophase	KPS-1503-2000-KPS	3695	12	11-Jun-2020
Cable (Yellow, Rx, Km-Km 2m)	Scott Cables	KPS-1501-2000-KPS	4527	6	09-Jun-2020
Mast Controller	Maturo GmbH	NCD	4810	-	TU
Tilt Antenna Mast	Maturo GmbH	TAM 4.0-P	4811	-	TU
Double Ridge Broadband Horn Antenna	Schwarzbeck	BBHA 9120 B	4848	12	11-Mar-2020
4dB Attenuator	Pasternack	PE7047-4	4935	24	30-Sep-2021
High Pass filter	Wainwright	WHKX12-1290-1500-18000-80SS	4961	12	11-Oct-2019
Hygrometer	Rotronic	HP21	4989	12	02-May-2020
EmX Emissions Software	TUV SUD	EmX	5125	-	Software
8 Meter Cable	Teledyne	PR90-088-8MTR	5212	12	30-Aug-2020
Antenna (DRG Horn 7.5-18GHz)	Schwarzbeck	HWRD750	5348	12	04-Sep-2020
Preamplifier (30dB 1GHz to 18GHz)	Schwarzbeck	BBV 9718 C	5350	12	21-Aug-2020
EMI Test Receiver	Rohde & Schwarz	ESW44	5382	12	08-Oct-2020

Table 16

TU - Traceability Unscheduled
 O/P Mon – Output Monitored



3 Measurement Uncertainty

For a 95% confidence level, the measurement uncertainties for defined systems are:

Test Name	Measurement Uncertainty
Spurious Radiated Emissions	30 MHz to 1 GHz: ± 5.2 dB 1 GHz to 40 GHz: ± 6.3 dB
Restricted Band Edges	30 MHz to 1 GHz: ± 5.2 dB 1 GHz to 40 GHz: ± 6.3 dB
Authorised Band Edges	30 MHz to 1 GHz: ± 5.2 dB 1 GHz to 40 GHz: ± 6.3 dB

Table 17

Measurement Uncertainty Decision Rule

Determination of conformity with the specification limits is based on the decision rule according to IEC Guide 115: 2007, clause 4.4.3 and 4.5.1.