

RF Report

MiX Telematics International (Pty) Ltd
Model: MiX 3400-B

Antenna Gain Measurements

Prepared for: MiX Telematics International (Pty) Ltd
Blaauwklip Office Park 2
Cnr Strand & Webersvalley Roads
Stellenbosch
South Africa



Add value.
Inspire trust.

COMMERCIAL-IN-CONFIDENCE

Document 75952029-29 Issue 01

SIGNATURE

A handwritten signature in black ink, appearing to read 'S Marshall'.

NAME	JOB TITLE	RESPONSIBLE FOR	ISSUE DATE
Steve Marshall	Senior Engineer	Authorised Signatory	16 February 2023

Signatures in this approval box have checked this document in line with the requirements of TÜV SÜD document control rules.

TÜV SÜD
is a trading name of TÜV SÜD Ltd
Registered in Scotland at East Kilbride,
Glasgow G75 0QF, United Kingdom
Registered number: SC215164

TÜV SÜD Ltd is a
TÜV SÜD Group Company

Phone: +44 (0) 1489 558100
Fax: +44 (0) 1489 558101
www.tuvsud.com/en

TÜV SÜD
Octagon House
Concorde Way
Fareham
Hampshire PO15 5RL
United Kingdom

1 Test Details

1.1 Antenna Gain Measurements

1.1.1 Equipment Under Test and Modification State

MiX 3400-B, S/N: 33000052 - Modification State 0
MiX 3400-B, S/N: 33000051 - Modification State 0

1.1.2 Date of Test

03-January-2023 to 01-February-2023

1.1.3 Test Method

The manufacturer provided a modified sample with a temporary 50 ohm SMA connector in place of the antenna which was used to perform a conducted power measurement in accordance with ANSI C63.10 clause 11.9.1.1.

The non-modified sample was then placed in a fully anechoic chamber on a turntable at 1.5m height at a measurement distance of 1m. The equipment under test (EUT) was placed in 3 orientations (X, Y, Z) to establish which plane provided the maximum EIRP.

The chamber is calibrated to make EIRP measurements thus for each frequency point the total loss from the centre of the turntable is known and set as a correction factor on the measuring equipment. The EUT was oriented for maximum EIRP and rotated in azimuth in 15 degree steps and the EIRP recorded as shown on the polar plots in the test result section below.

1.1.4 Environmental Conditions

Ambient Temperature 23.6 - 26.1 °C
Relative Humidity 29.5 - 32.2 %

1.1.5 Test Equipment Diagram

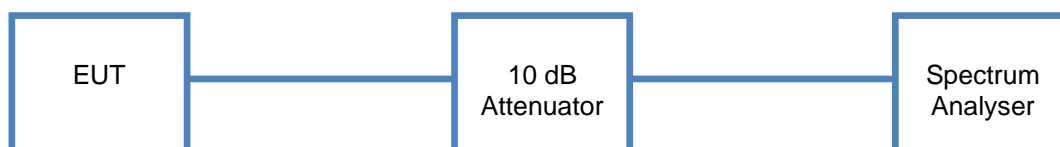

Figure 1 – Conducted Test Setup

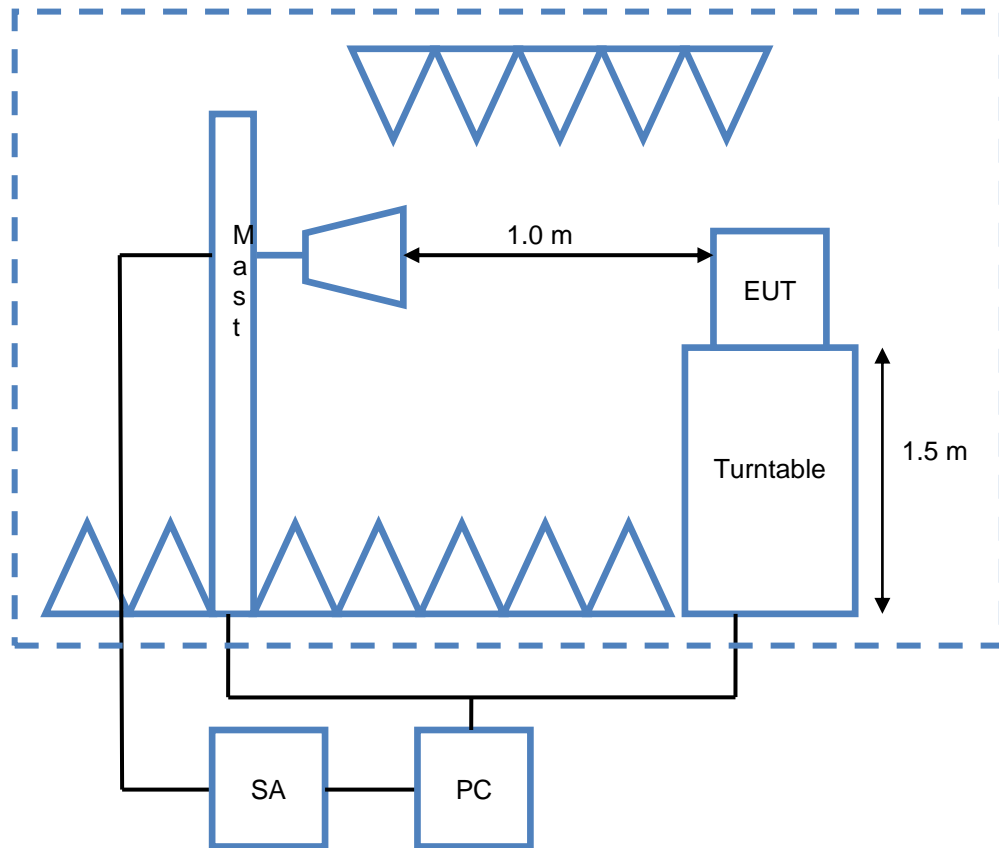

Figure 2 – Radiated Test Setup

1.1.6 Test Results

Antenna gain Mix 3400-B

Summary of Results

Frequency (MHz)	Result
2402	-2.08
2440	-3.27
2480	-2.00

Table 1 – Antenna Gain Results

Conducted Results

Frequency (MHz)	Result (dBm)
2402	4.60
2440	4.54
2480	4.43

Table 2 – Maximum Conducted Output Power Results

Radiated Results

Frequency (MHz)	Result (dBm EIRP)
2402	2.52
2440	1.27
2480	2.43

Table 3 – Maximum Radiated Output Power Results

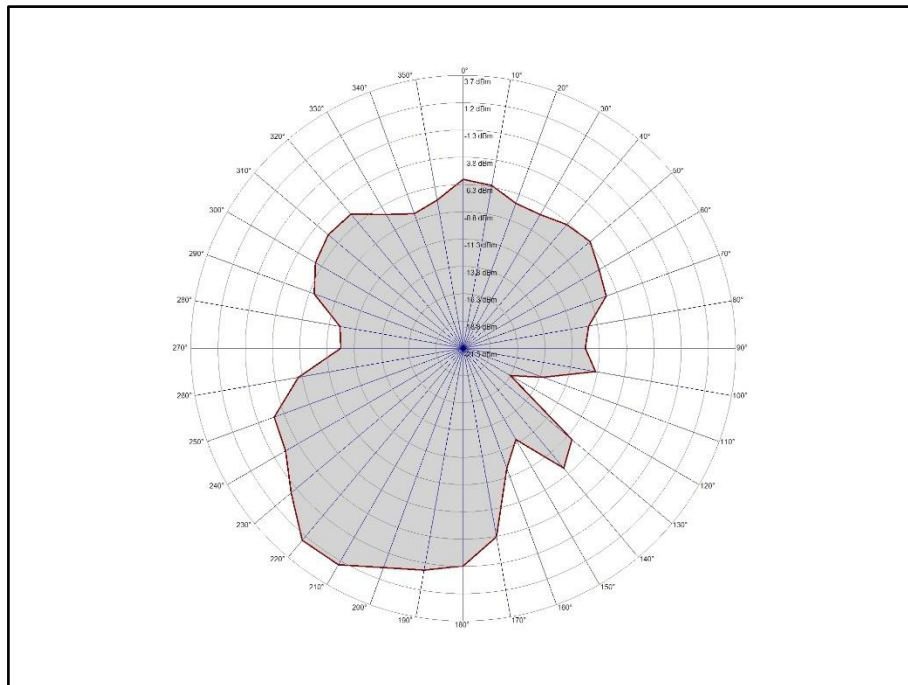

Figure 3 - 2402 MHz, Horizontal

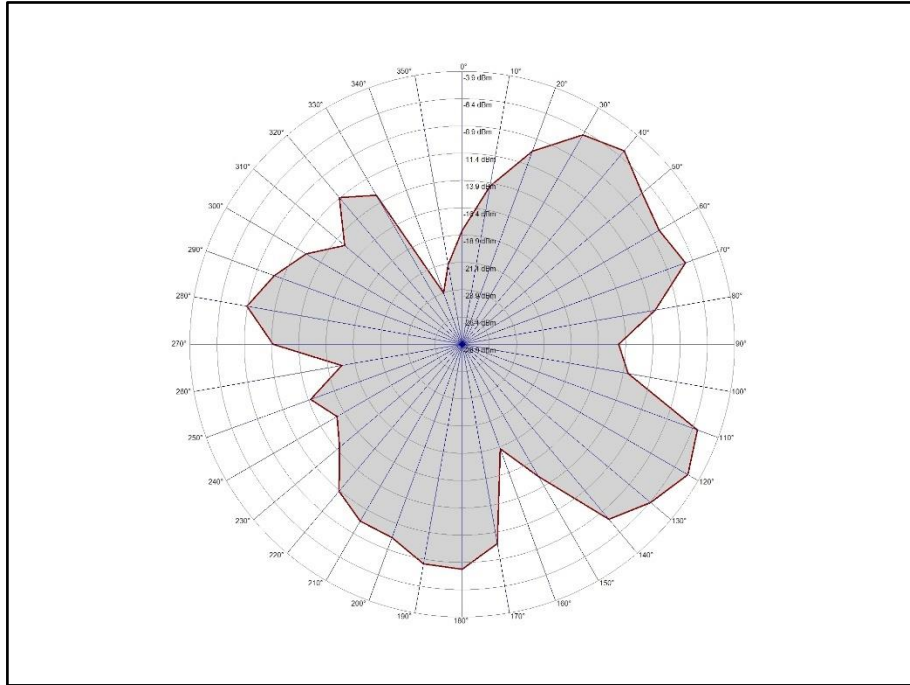

Figure 4 - 2402 MHz, Vertical

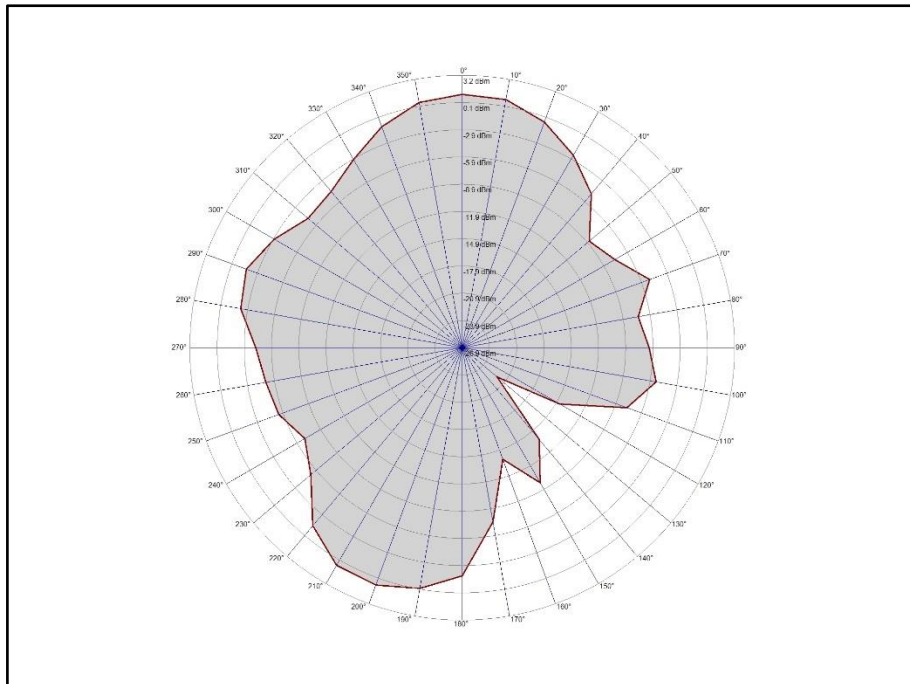

Figure 5 - 2440 MHz, Horizontal

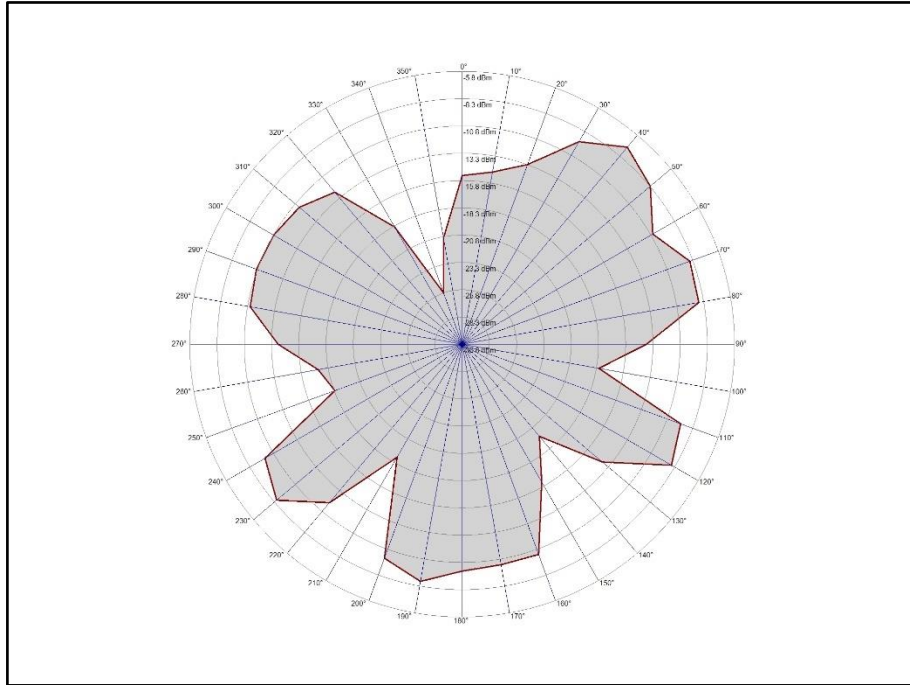

Figure 6 - 2440 MHz, Vertical

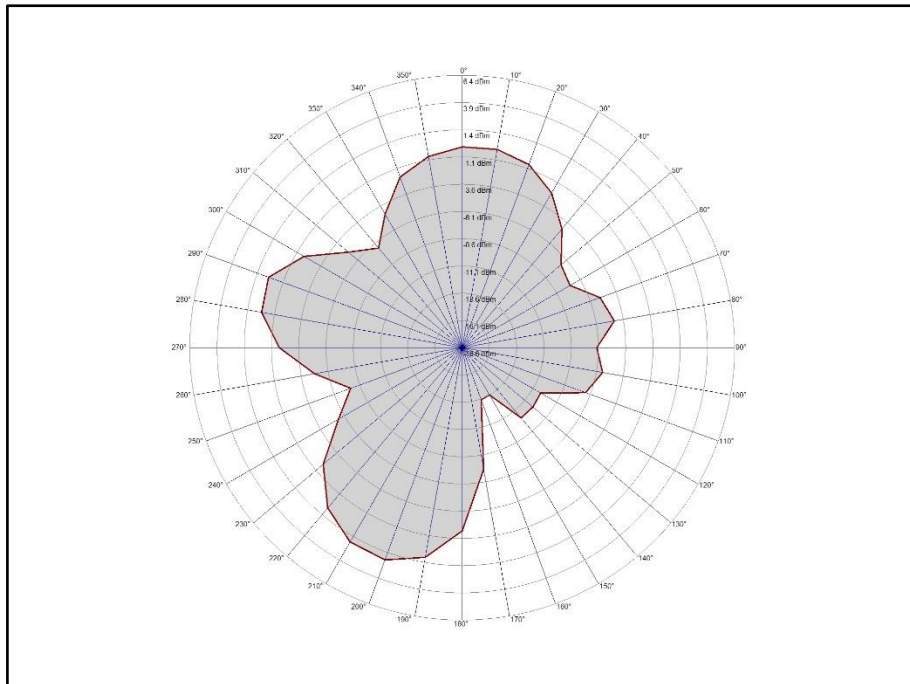

Figure 7 - 2480 MHz, Horizontal

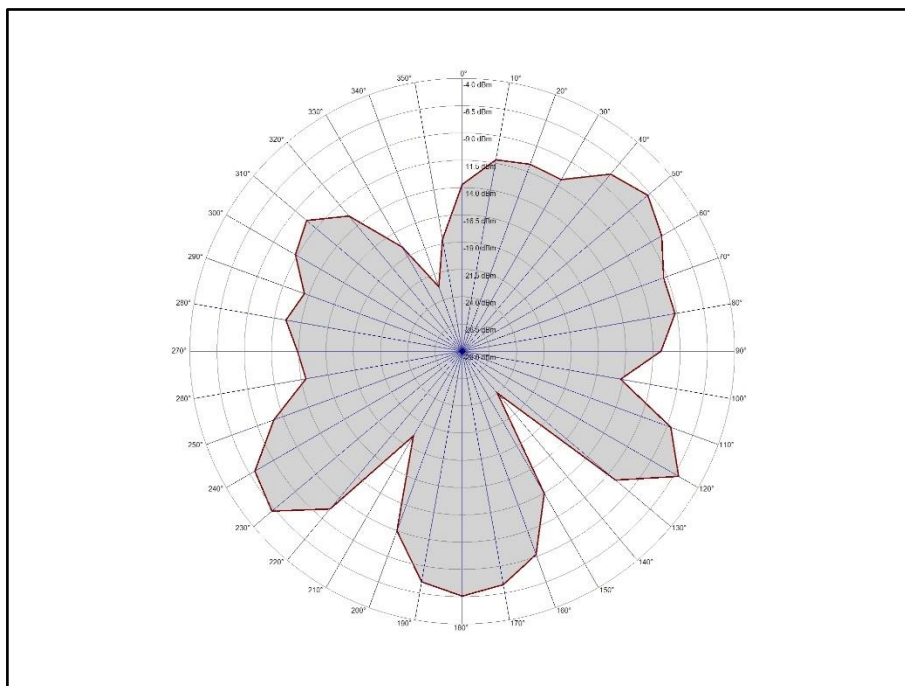

Figure 8 - 2480 MHz, Vertical



1.1.7 Test Location and Test Equipment Used

This test was carried out in RF Chamber 8.

Instrument	Manufacturer	Type No.	TE No.	Calibration Period (months)	Calibration Expiry Date
Antenna (Double Ridge Guide)	EMCO	3115	34	12	16-Oct-2023
Screened Room (8)	Rainford	Rainford	1548	12	17-Mar-2023
Hygrometer	Rotronic	I-1000	2882	12	11-Feb-2023
Network Analyser	Rohde & Schwarz	ZVA 40	3548	12	24-Feb-2023
2m N(m) - N(m) RF Cable	Rhophase	NPS-2303-2000-NPS	3604	-	TU
Calibration Unit	Rohde & Schwarz	ZV-Z54	4368	12	24-Feb-2023
Frequency Standard	Spectracom	SecureSync 1200-0408-0601	4393	6	13-Jul-2023
PXA Signal Analyser	Agilent Technologies	N9030A PXA	4409	12	21-Feb-2023
Digital Multi-meter	Iso-tech	IDM93N	4435	12	07-Mar-2023
2 metre N-Type Cable	Florida Labs	NMS-235SP-78.8-NMS	4508	12	14-Apr-2023
Quad Power Supply	Rohde & Schwarz	HMP4040	4955	-	O/P Mon
Cable (40 GHz)	Rosenberger	LU1-001-1000	5023	-	O/P Mon
Cable (18 GHz)	Rosenberger	LU7-096-4000	5040	-	O/P Mon
Emissions Software	TUV SUD	EmX V3.1.6 V.	5125	-	Software
8m N-Type Cable	Junkosha	MWX221-08000NMSNMS/B	5521	-	O/P Mon
Cable (SMA to SMA 3m)	Junkosha	MWX221-03000AMSAMS/B	6011	12	07-Jun-2023
Coaxial Fixed Attenuator DC-18GHz 5W 10dB	RF-Lambda	RFS5G18B10SMP	6177	12	17-Jul-2023

Table 4

TU - Traceability Unscheduled

O/P Mon – Output Monitored using calibrated equipment

1.1.8 Test Setup Photos

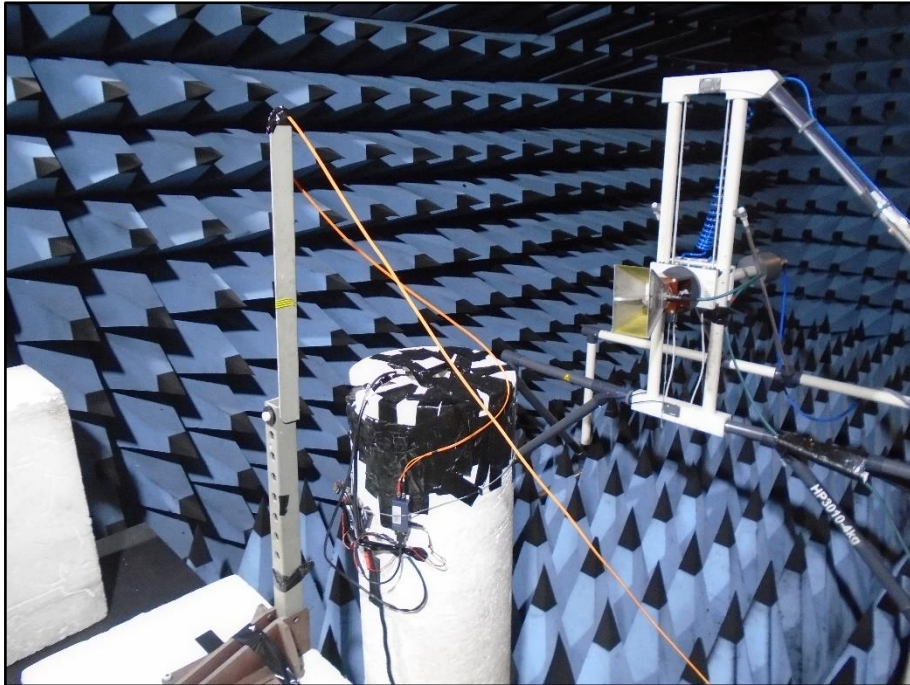

Figure 9 – Test Setup Photo – Orientation X (Worst Case)



Figure 10 – Photograph of Sample