

承 認 書

SPECIFICATION FOR APPROVAL

客 戶：
CUSTOMER: **D706**

客 戶 料 號：
CUST P/N:

泛 亞 料 號：
FINE P/N:

產 品 型 號：
DESC: **FYD70612024040101L**

日 期：
DATE: **2024/04/01**

版 本：
Version: **A.0**

擬 制 PREPARED BY	審 核 CHECKED BY	批 准 APPROVED BY	客 戶 承 認 CUSTOMER APPROVE
尹 艺	蒋 慧 璇	蔡 纪 雨	

东莞市泛亚电子有限公司

Dongguan FANYA Electronics Co., LTD

公司地址：东莞市石碣镇刘屋科技东路 194 号

TEL: 0769-22490287 / 22452492

FAX: 0769-22499451

E-mail: fineelec@163.com

SPECIFICATION

產品型號: DESC	FYD70612024040101L	版本 Rev: A.0	客戶 CUST: 泛亚料号 Fine P/N: 客户料号 CUST P/N:	D706
---------------	--------------------	----------------	--	------

一、尺寸 DIMENSION:(mm)

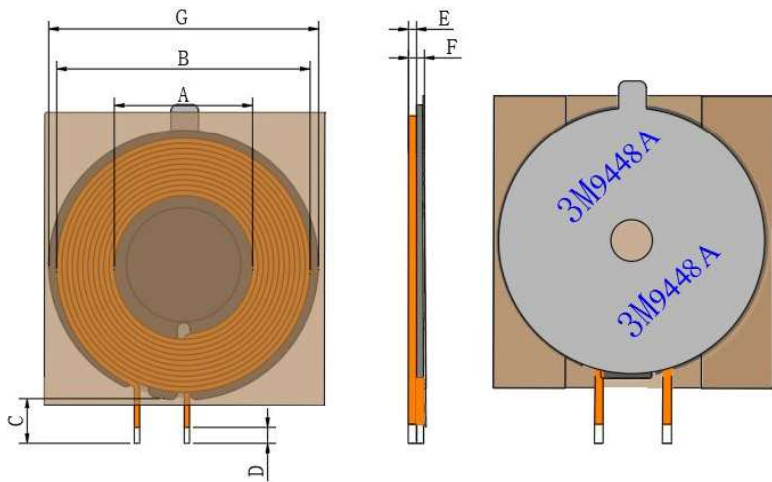

A	21.8±0.5
B	39.5±1.0
C	5.52±1.5
D	2.5MAX(不带黄胶)
E	0.8±0.2
F	2.5MAX(不含离型纸)
G	42.4±0.5

注:

1. 线圈交叉出线;
2. 线圈反贴硬磁片, 硬磁片尺寸 ϕ 42.4*1.0mm, 开双直槽; 磁片中间贴 ϕ 18*0.75mm 小磁片, 贴合用 ϕ 15*0.08mm 普通双面背胶贴合;
- 4.线圈正反面用特殊材料膜覆盖, 特殊材料膜贴合结尾在线圈背面。
- 5.背胶贴在特殊材料膜上, 背胶尺寸 ϕ 41.2*0.15mm 带手撕位 3M9448A 双面背胶

二、原理图 SCHEMATIC DIAGRAM:

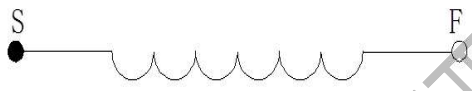

三、绕线参数 Winding Specification:

序号 NO.	端子 TERMINAL	线径 WIRE	圈数 Turns	绕线方向 Winding Direction
1	S F	Litz 0.08*65P	11Ts	CW

四、电气特性 ELECTRICAL CHARACTERISTICS:

湿度 RELATIVE HUMIDITY:65±20%

序号 NO.	项目 ITEM	端子 TERMINAL	标准 SPECIFICATION	测试条件 TEST FREQUENCY	测试仪器 TEST EQUIPMENTS
1	IND.	S-F	8.3uH ±10% 加磁片	100KHz/1.0V	TH2829LX
2	DCR	S-F	100mΩ Max	@25℃	TH2829LX

擬制/日期 PREPARED BY/DATE 尹艺 2024/04/01	審核/日期 CHECKED BY/DATE 蔡纪雨 2024/04/01
--	--

SPECIFICATION

產品型號: DESC	FYD70612024040101L	版本 Rev: A.0	客戶 CUST: 泛亚料号 Fine P/N: 客户料号 CUST P/N:	D706
---------------	---------------------------	----------------	--	------

五、包装 PACKING:

5.1 包装图片 Packing pictures:

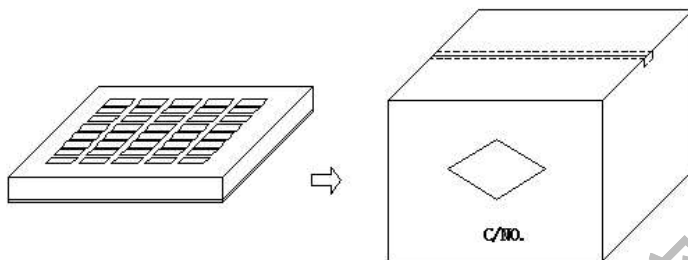

5.2 包装数量及规格 Packing Quantity:

项目 Item	数量 Quantity	材料规格 Material
盘 Box	200 Pcs	370*265*55mm
箱 Big Carton	1000 Pcs	420*270*310mm

5.3 包装以现有包装盘为参照标准，以实际出货包装为准,如有特需要求可以定制。

The packaging shall be based on the existing packing plate and the actual delivery package shall prevail. If there is any requirement, we can customize it.

六、材料清单 Material list:

序号 number	材料名称 Material name	品名描述 Description	制造商 Manufacturer
1	Litz 0.08*65 股	Litz 0.08*65 股	
2	无铅锡条	无铅锡条	
3	硬磁片	Φ42.4*1.0mm, 开双直槽	
4	小磁片	Φ18*0.75mm	
5	普通背胶	φ15*0.08mm 普通双面背胶	
6	特殊材料膜	70*46*0.03mm	
7	结构胶	峙鸿 SH8536	
8	3M9448A 双面背胶	Φ41.2*0.15mm 开孔带手撕位 3M9448A 双面背胶	
9			

擬制/日期 PREPARED BY/DATE	審核/日期 CHECKED BY/DATE
尹艺 2024/04/01	蔡纪雨 2024/04/01

Test Report

No.: SZXEC23000888001

Date: Jun 13, 2023

Page 1 of 12

Client Name: DONGGUAN FINE ELECTRONICS LIMITED

Client Address: 194 KEJI EAST ROAD, SHIJIE TOWN, DONGGUAN CITY, GUANGDONG PROVINCE

Sample Name: Coil

The above sample(s) and information were provided by the client.

SGS Job No.: SZP23-001370

Sample Receiving Date: May 15, 2023

Testing Period: May 15, 2023 ~ May 24, 2023

Test Requested: Select test(s) as requested by the client.

Test Method(s): Please refer to next page(s).

Test Result(s): Please refer to next page(s).

Test Requirement	Conclusion
EU RoHS Directive (EU) 2015/863 amending Annex II to Directive 2011/65/EU- Lead, Mercury, Cadmium, Hexavalent chromium, Polybrominated biphenyls (PBBs), Polybrominated diphenyl ethers (PBDEs), Bis(2-ethylhexyl) phthalate (DEHP), Butyl benzyl phthalate (BBP), Dibutyl phthalate (DBP) and Diisobutyl phthalate (DIBP)	Pass

Signed for and on behalf of
SGS-CSTC Standards Technical Services Co., Ltd. Shenzhen Branch



Tina Fan
Approved Signatory

scan to see the report



4ED252AA



SGS-CSTC Standards Technical Services Co., Ltd.
Shenzhen Branch Testing Center Chemical Laboratory

Unless otherwise agreed in writing, this document is issued by the Company subject to its General Conditions of Service printed overleaf, available on request or accessible at <http://www.sgs.com/en/Terms-and-Conditions.aspx> and, for electronic format documents, subject to Terms and Conditions for Electronic Documents at <http://www.sgs.com/en/Terms-and-Conditions/Terms-e-Document.aspx>. Attention is drawn to the limitation of liability, indemnification and jurisdiction issues defined therein. Any holder of this document is advised that information contained hereon reflects the Company's findings at the time of its intervention only and within the limits of Client's instructions, if any. The Company's sole responsibility is to its Client and this document does not exonerate parties to a transaction from exercising all their rights and obligations under the transaction documents. This document cannot be reproduced except in full, without prior written approval of the Company. Any unauthorized alteration, forgery or falsification of the content or appearance of this document is unlawful and offenders may be prosecuted to the fullest extent of the law. Unless otherwise stated the results shown in this test report refer only to the sample(s) tested.

Attention: To check the authenticity of testing /inspection report & certificate, please contact us at telephone: (86-755) 8307 1443, or email: CN.Doccheck@sgs.com

Room 101-901, Plant 4 & Room 101, Plant 2 & Room 101, Plant 3 & Room 301-501, Plant 3, Jianghao (Bantian) Industrial Plant Area, No. 430, Jihua Road, Bantian Community, Bantian Street, Longgang District, Shenzhen, Guangdong, China 518129 www.sgs.com
中国·广东·深圳市龙岗区坂田街道坂田社区吉华路430号江豪(坂田)工业厂区厂房4号101-901、2号101、3号101、3号301-501 邮编:518129 t:(86-755) 25328888 sgs.china@sgs.com

Test Result(s):

Test Part Description:

SN ID	Sample No.	SGS Sample ID	Description
SN1	A1	SZX23-0008880-0001.C001	Copper-colored metal wire with colorless transparent surface A1#
SN2	A2	SZX23-0008880-0001.C002	Silvery metal wire with red surface A2#
SN3	A3	SZX23-0008880-0001.C003	White material A3#
SN4	A4	SZX23-0008880-0001.C004	White material A4#
SN5	A5	SZX23-0008880-0001.C005	Dark grey core A5#
SN6	A6	SZX23-0008880-0001.C006	Silvery metal A6#

Remarks:

- (1) 1 mg/kg = 1 ppm = 0.0001%
- (2) MDL = Method Detection Limit
- (3) ND = Not Detected (< MDL)
- (4) "-" = Not Regulated

EU RoHS Directive (EU) 2015/863 amending Annex II to Directive 2011/65/EU- Lead, Mercury, Cadmium, Hexavalent chromium, Polybrominated biphenyls (PBBs), Polybrominated diphenyl ethers (PBDEs), Bis(2-ethylhexyl) phthalate (DEHP), Butyl benzyl phthalate (BBP), Dibutyl phthalate (DBP) and Diisobutyl phthalate (DIBP)

Test Method: With reference to IEC 62321-4:2013+AMD1:2017, IEC 62321-5:2013, IEC 62321-7-2:2017, IEC 62321-6:2015 and IEC 62321-8:2017, analysis was performed by ICP-OES, UV-Vis and GC-MS.

Test Item(s)	Limit	Unit(s)	MDL	A1	A2	A3
Cadmium(Cd)	100	mg/kg	2	ND	ND	ND
Lead (Pb)	1000	mg/kg	2	ND	ND	ND
Mercury (Hg)	1000	mg/kg	2	ND	ND	ND
Hexavalent Chromium (Cr(VI))	1000	mg/kg	8	ND	ND	ND
Polybromobiphenyl (PBBs)	1000	mg/kg	-	ND	ND	ND
Monobromobiphenyl (MonoBB)	-	mg/kg	5	ND	ND	ND
Dibromobiphenyl (DiBB)	-	mg/kg	5	ND	ND	ND
Tribromobiphenyl (TriBB)	-	mg/kg	5	ND	ND	ND
Tetrabromobiphenyl (TetraBB)	-	mg/kg	5	ND	ND	ND
Pentabromobiphenyl (PentaBB)	-	mg/kg	5	ND	ND	ND
Hexabromobiphenyl (HexaBB)	-	mg/kg	5	ND	ND	ND
Heptabromobiphenyl (HeptaBB)	-	mg/kg	5	ND	ND	ND
Octabromobiphenyl (OctaBB)	-	mg/kg	5	ND	ND	ND
Nonabromobiphenyl (NonaBB)	-	mg/kg	5	ND	ND	ND
Decabromobiphenyl (DecaBB)	-	mg/kg	5	ND	ND	ND
Polybromodiphenyl ether(PBDEs)	1000	mg/kg	-	ND	ND	ND
Monobromodiphenylether (MonoBDE)	-	mg/kg	5	ND	ND	ND
Dibromodiphenylether (DiBDE)	-	mg/kg	5	ND	ND	ND
Tribromodiphenylether (TriBDE)	-	mg/kg	5	ND	ND	ND
Tetrabromodiphenylether (TetraBDE)	-	mg/kg	5	ND	ND	ND



SGS-CSTC Standards Technical Services Co., Ltd.
Shenzhen Branch Testing Center-Chemical Laboratory

Unless otherwise agreed in writing, this document is issued by the Company subject to its General Conditions of Service printed overleaf, available on request or accessible at <http://www.sgs.com/en/Terms-and-Conditions.aspx> and, for electronic format documents, subject to Terms and Conditions for Electronic Documents at <http://www.sgs.com/en/Terms-and-Conditions/Terms-e-Documents.aspx>. Attention is drawn to the limitation of liability, indemnification and jurisdiction issues defined therein. Any holder of this document is advised that information contained hereon reflects the Company's findings at the time of its intervention only and within the limits of Client's instructions, if any. The Company's sole responsibility is to its Client and this document does not exonerate parties to a transaction from exercising all their rights and obligations under the transaction documents. This document cannot be reproduced except in full, without prior written approval of the Company. Any unauthorized alteration, forgery or falsification of the content or appearance of this document is unlawful and offenders may be prosecuted to the fullest extent of the law. Unless otherwise stated the results shown in this test report refer only to the sample(s) tested.

Attention: To check the authenticity of testing /inspection report & certificate, please contact us at telephone: (86-755) 8307 1443, or email: CN.Doccheck@sgs.com

Room 101-901, Plant 4 & Room 101, Plant 2 & Room 101, Plant 3 & Room 301-501, Plant 3, Jianghao (Bantian) Industrial Plant Area, No. 430, Jihua Road, Bantian Community, Bantian Street, Longgang District, Shenzhen, Guangdong, China 518129 www.sgs.com.cn
中国·广东·深圳市龙岗区坂田街道坂田社区吉华路430号江灏(坂田)工业厂区厂房4号101-901、2号101、3号101、3号301-501 邮编:518129 t:(86-755) 25328888 sgs.china@sgs.com

Test Report

No.: SZXEC23000888001

Date: Jun 13, 2023

Page 3 of 12

Test Item(s)	Limit	Unit(s)	MDL	A1	A2	A3
Pentabromodiphenylether (PentaBDE)	-	mg/kg	5	ND	ND	ND
Hexabromodiphenylether (HexaBDE)	-	mg/kg	5	ND	ND	ND
Heptabromodiphenylether (HeptaBDE)	-	mg/kg	5	ND	ND	ND
Octabromodiphenylether (OctaBDE)	-	mg/kg	5	ND	ND	ND
Nonabromodiphenylether (NonaBDE)	-	mg/kg	5	ND	ND	ND
Decabromodiphenylether (DecaBDE)	-	mg/kg	5	ND	ND	ND
Dibutyl Phthalate(DBP)	1000	mg/kg	50	ND	ND	ND
Benzyl Butyl Phthalate(BBP)	1000	mg/kg	50	ND	ND	ND
Bis-(2-ethylhexyl) Phthalate(DEHP)	1000	mg/kg	50	ND	ND	ND
Diisobutyl Phthalate(DIBP)	1000	mg/kg	50	ND	ND	ND

Test Item(s)	Limit	Unit(s)	MDL	A4	A5
Cadmium(Cd)	100	mg/kg	2	ND	ND
Lead (Pb)	1000	mg/kg	2	ND	ND
Mercury (Hg)	1000	mg/kg	2	ND	ND
Hexavalent Chromium (Cr(VI))	1000	mg/kg	8	ND	ND
Polybromobiphenyl (PBBs)	1000	mg/kg	-	ND	ND
Monobromobiphenyl (MonoBB)	-	mg/kg	5	ND	ND
Dibromobiphenyl (DiBB)	-	mg/kg	5	ND	ND
Tribromobiphenyl (TriBB)	-	mg/kg	5	ND	ND
Tetrabromobiphenyl (TetraBB)	-	mg/kg	5	ND	ND
Pentabromobiphenyl (PentaBB)	-	mg/kg	5	ND	ND
Hexabromobiphenyl (HexaBB)	-	mg/kg	5	ND	ND
Heptabromobiphenyl (HeptaBB)	-	mg/kg	5	ND	ND
Octabromobiphenyl (OctaBB)	-	mg/kg	5	ND	ND
Nonabromobiphenyl (NonaBB)	-	mg/kg	5	ND	ND
Decabromobiphenyl (DecaBB)	-	mg/kg	5	ND	ND
Polybromodiphenyl ether(PBDEs)	1000	mg/kg	-	ND	ND
Monobromodiphenylether (MonoBDE)	-	mg/kg	5	ND	ND
Dibromodiphenylether (DiBDE)	-	mg/kg	5	ND	ND
Tribromodiphenylether (TriBDE)	-	mg/kg	5	ND	ND
Tetrabromodiphenylether (TetraBDE)	-	mg/kg	5	ND	ND
Pentabromodiphenylether (PentaBDE)	-	mg/kg	5	ND	ND
Hexabromodiphenylether (HexaBDE)	-	mg/kg	5	ND	ND
Heptabromodiphenylether (HeptaBDE)	-	mg/kg	5	ND	ND
Octabromodiphenylether (OctaBDE)	-	mg/kg	5	ND	ND



SGS-CSTC Standards Technical Services Co., Ltd.
Shenzhen Branch Testing Center-Chemical Laboratory

Unless otherwise agreed in writing, this document is issued by the Company subject to its General Conditions of Service printed overleaf, available on request or accessible at <http://www.sgs.com/en/Terms-and-Conditions.aspx> and, for electronic format documents, subject to Terms and Conditions for Electronic Documents at <http://www.sgs.com/en/Terms-and-Conditions/Terms-e-Documents.aspx>. Attention is drawn to the limitation of liability, indemnification and jurisdiction issues defined therein. Any holder of this document is advised that information contained hereon reflects the Company's findings at the time of its intervention only and within the limits of Client's instructions, if any. The Company's sole responsibility is to its Client and this document does not exonerate parties to a transaction from exercising all their rights and obligations under the transaction documents. This document cannot be reproduced except in full, without prior written approval of the Company. Any unauthorized alteration, forgery or falsification of the content or appearance of this document is unlawful and offenders may be prosecuted to the fullest extent of the law. Unless otherwise stated the results shown in this test report refer only to the sample(s) tested.

Attention: To check the authenticity of testing /inspection report & certificate, please contact us at telephone: (86-755) 8307 1443, or email: CN.Doccheck@sgs.com

Room 101-901, Plant 4 & Room 101, Plant 2 & Room 101, Plant 3 & Room 301-501, Plant 3, Jianghao (Bantian) Industrial Plant Area, No. 430, Jihua Road, Bantian Community, Bantian Street, Longgang District, Shenzhen, Guangdong, China 518129 www.sgs.com.cn
中国·广东·深圳市龙岗区坂田街道坂田社区吉华路430号江灏(坂田)工业厂区厂房4号101-901、2号101、3号101、3号301-501 邮编:518129 t:(86-755) 25328888 sgs.china@sgs.com

Test Report

No.: SZXEC23000888001

Date: Jun 13, 2023

Page 4 of 12

Test Item(s)	Limit	Unit(s)	MDL	A4	A5
Nonabromodiphenylether (NonaBDE)	-	mg/kg	5	ND	ND
Decabromodiphenylether (DecaBDE)	-	mg/kg	5	ND	ND
Dibutyl Phthalate(DBP)	1000	mg/kg	50	ND	ND
Benzyl Butyl Phthalate(BBP)	1000	mg/kg	50	ND	ND
Bis-(2-ethylhexyl) Phthalate(DEHP)	1000	mg/kg	50	ND	ND
Diisobutyl Phthalate(DIBP)	1000	mg/kg	50	ND	ND

Notes:

- (1) The maximum permissible limit is quoted from RoHS Directive (EU) 2015/863.
- (2) IEC 62321 series is equivalent to EN 62321 series.
- (3) The restriction of DEHP, BBP, DBP and DIBP shall apply to medical devices, including in vitro medical devices, and monitoring and control instruments, including industrial monitoring and control instruments, from 22 July 2021.

Test Method: With reference to IEC 62321-4:2013+AMD1:2017, IEC 62321-5:2013, IEC 62321-7-1:2015, IEC 62321-6:2015 and IEC62321-8:2017, analysis was performed by ICP-OES, UV-Vis and GC-MS.

Test Item(s)	Limit	Unit(s)	MDL	A6
Cadmium(Cd)	100	mg/kg	2	ND
Lead(Pb)	1000	mg/kg	2	65
Mercury(Hg)	1000	mg/kg	2	ND
Hexavalent Chromium (Cr(VI)) ▼	-	µg/cm ²	0.10	ND
Polybromobiphenyl (PBBs)	1000	mg/kg	-	ND
Monobromobiphenyl (MonoBB)	-	mg/kg	5	ND
Dibromobiphenyl (DiBB)	-	mg/kg	5	ND
Tribromobiphenyl (TriBB)	-	mg/kg	5	ND
Tetrabromobiphenyl (TetraBB)	-	mg/kg	5	ND
Pentabromobiphenyl (PentaBB)	-	mg/kg	5	ND
Hexabromobiphenyl (HexaBB)	-	mg/kg	5	ND
Heptabromobiphenyl (HeptaBB)	-	mg/kg	5	ND
Octabromobiphenyl (OctaBB)	-	mg/kg	5	ND
Nonabromobiphenyl (NonaBB)	-	mg/kg	5	ND
Decabromobiphenyl (DecaBB)	-	mg/kg	5	ND
Polybromodiphenyl ether(PBDEs)	1000	mg/kg	-	ND
Monobromodiphenylether (MonoBDE)	-	mg/kg	5	ND
Dibromodiphenylether (DiBDE)	-	mg/kg	5	ND
Tribromodiphenylether (TriBDE)	-	mg/kg	5	ND
Tetrabromodiphenylether (TetraBDE)	-	mg/kg	5	ND
Pentabromodiphenylether (PentaBDE)	-	mg/kg	5	ND
Hexabromodiphenylether (HexaBDE)	-	mg/kg	5	ND
Heptabromodiphenylether (HeptaBDE)	-	mg/kg	5	ND
Octabromodiphenylether (OctaBDE)	-	mg/kg	5	ND
Nonabromodiphenylether (NonaBDE)	-	mg/kg	5	ND



SGS-CSTC Standards Technical Services Co., Ltd.
Shenzhen Branch Testing Center Chemical Laboratory

Unless otherwise agreed in writing, this document is issued by the Company subject to its General Conditions of Service printed overleaf, available on request or accessible at <http://www.sgs.com/en/Terms-and-Conditions.aspx> and, for electronic format documents, subject to Terms and Conditions for Electronic Documents at <http://www.sgs.com/en/Terms-and-Conditions/Terms-e-Documents.aspx>. Attention is drawn to the limitation of liability, indemnification and jurisdiction issues defined therein. Any holder of this document is advised that information contained hereon reflects the Company's findings at the time of its intervention only and within the limits of Client's instructions, if any. The Company's sole responsibility is to its Client and this document does not exonerate parties to a transaction from exercising all their rights and obligations under the transaction documents. This document cannot be reproduced except in full, without prior written approval of the Company. Any unauthorized alteration, forgery or falsification of the content or appearance of this document is unlawful and offenders may be prosecuted to the fullest extent of the law. Unless otherwise stated the results shown in this test report refer only to the sample(s) tested.

Attention: To check the authenticity of testing /inspection report & certificate, please contact us at telephone: (86-755) 8307 1443, or email: CN.Doccheck@sgs.com

Room 101-901, Plant 4 & Room 101, Plant 2 & Room 101, Plant 3 & Room 301-501, Plant 3, Jianghao (Bantian) Industrial Plant Area, No. 430, Jihua Road, Bantian Community, Bantian Street, Longgang District, Shenzhen, Guangdong, China 518129 www.sgs.com
中国·广东·深圳市龙岗区坂田街道坂田社区吉华路430号江灏(坂田)工业区厂房4号101-901、2号101、3号101、3号301-501 邮编:518129 t:(86-755) 25328888 sgs.china@sgs.com

Test Report

No.: SZXEC23000888001

Date: Jun 13, 2023

Page 5 of 12

Test Item(s)	Limit	Unit(s)	MDL	A6
Decabromodiphenylether (DecaBDE)	-	mg/kg	5	ND
Dibutyl Phthalate(DBP)	1000	mg/kg	50	ND
Benzyl Butyl Phthalate(BBP)	1000	mg/kg	50	ND
Bis-(2-ethylhexyl) Phthalate(DEHP)	1000	mg/kg	50	ND
Diisobutyl Phthalate(DIBP)	1000	mg/kg	50	ND

Notes:

- (1) The maximum permissible limit is quoted from RoHS Directive (EU) 2015/863.
- (2) IEC 62321 series is equivalent to EN 62321 series.
- (3) ▼ = a. The sample is positive for Cr(VI) if the Cr(VI) concentration is greater than 0.13 µg/cm².
The sample coating is considered to contain Cr(VI)
- b. The sample is negative for Cr(VI) if Cr(VI) is ND (concentration less than 0.10 µg/cm²).
The coating is considered a non-Cr(VI) based coating
- c. The result between 0.10 µg/cm² and 0.13 µg/cm² is considered to be inconclusive -
unavoidable coating variations may influence the determination

Information on storage conditions and production date of the tested sample is unavailable and thus Cr(VI) results represent status of the sample at the time of testing.

Unless otherwise stated, the decision rule for conformity reporting is based on Binary Statement for Simple Acceptance Rule (w=0) stated in ILAC-G8:09/2019.



Unless otherwise agreed in writing, this document is issued by the Company subject to its General Conditions of Service printed overleaf, available on request or accessible at <http://www.sgs.com/en/Terms-and-Conditions.aspx> and, for electronic format documents, subject to Terms and Conditions for Electronic Documents at <http://www.sgs.com/en/Terms-and-Conditions/Terms-e-Documents.aspx>. Attention is drawn to the limitation of liability, indemnification and jurisdiction issues defined therein. Any holder of this document is advised that information contained hereon reflects the Company's findings at the time of its intervention only and within the limits of Client's instructions, if any. The Company's sole responsibility is to its Client and this document does not exonerate parties to a transaction from exercising all their rights and obligations under the transaction documents. This document cannot be reproduced except in full, without prior written approval of the Company. Any unauthorized alteration, forgery or falsification of the content or appearance of this document is unlawful and offenders may be prosecuted to the fullest extent of the law. Unless otherwise stated the results shown in this test report refer only to the sample(s) tested.

Attention: To check the authenticity of testing /inspection report & certificate, please contact us at telephone: (86-755) 8307 1443, or email: CN.Doccheck@sgs.com

SGS CSTC Shenzhen Branch
Inspection & Testing Services

Room 101-901, Plant 4 & Room 101, Plant 2 & Room 101, Plant 3 & Room 301-901, Plant 3, Jiangheo (Bantian) Industrial Plant Area, No. 430, Jihua Road, Bantian Community, Bantian Street, Longgang District, Shenzhen, Guangdong, China 518129 www.sgs.com
 中国·广东·深圳市龙岗区坂田街道坂田社区吉华路430号江禾(坂田)工业区厂房4号101-901、2号101、3号101、3号301-501 邮编:518129 t:(86-755) 25328888 sgs.china@sgs.com

Elements Testing Flow Chart

These samples were dissolved totally by pre-conditioning method according to below flow chart.

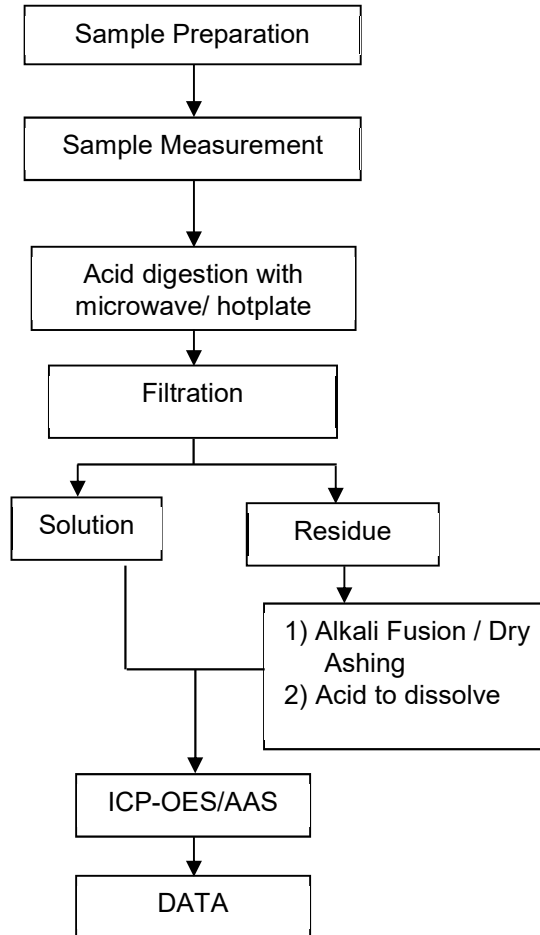

Unless otherwise agreed in writing, this document is issued by the Company subject to its General Conditions of Service printed overleaf, available on request or accessible at <http://www.sgs.com/en/Terms-and-Conditions.aspx> and, for electronic format documents, subject to Terms and Conditions for Electronic Documents at <http://www.sgs.com/en/Terms-and-Conditions/Terms-e-Documents.aspx>. Attention is drawn to the limitation of liability, indemnification and jurisdiction issues defined therein. Any holder of this document is advised that information contained hereon reflects the Company's findings at the time of its intervention only and within the limits of Client's instructions, if any. The Company's sole responsibility is to its Client and this document does not exonerate parties to a transaction from exercising all their rights and obligations under the transaction documents. This document cannot be reproduced except in full, without prior written approval of the Company. Any unauthorized alteration, forgery or falsification of the content or appearance of this document is unlawful and offenders may be prosecuted to the fullest extent of the law. Unless otherwise stated the results shown in this test report refer only to the sample(s) tested.

Attention: To check the authenticity of testing /inspection report & certificate, please contact us at telephone: (86-755) 8307 1443, or email: CN.Doccheck@sgs.com

SGS-CSTC Standards Technical Services Co., Ltd.
Shenzhen Branch Testing Center Chemical Laboratory

Room 101-901, Plant 4 & Room 101, Plant 2 & Room 101, Plant 3 & Room 301-501, Plant 3, Jianghao (Bantian) Industrial Plant Area, No. 430, Jihua Road, Bantian Community, Bantian Street, Longgang District, Shenzhen, Guangdong, China 518129 www.sgs.com
中国·广东·深圳市龙岗区坂田街道坂田社区吉华路430号江灏(坂田)工业区厂房4号101-901、2号101、3号301-501 邮编:518129 t:(86-755) 25328888 sgs.china@sgs.com

ATTACHMENTS

Hexavalent Chromium (Cr(VI)) Testing Flow Chart

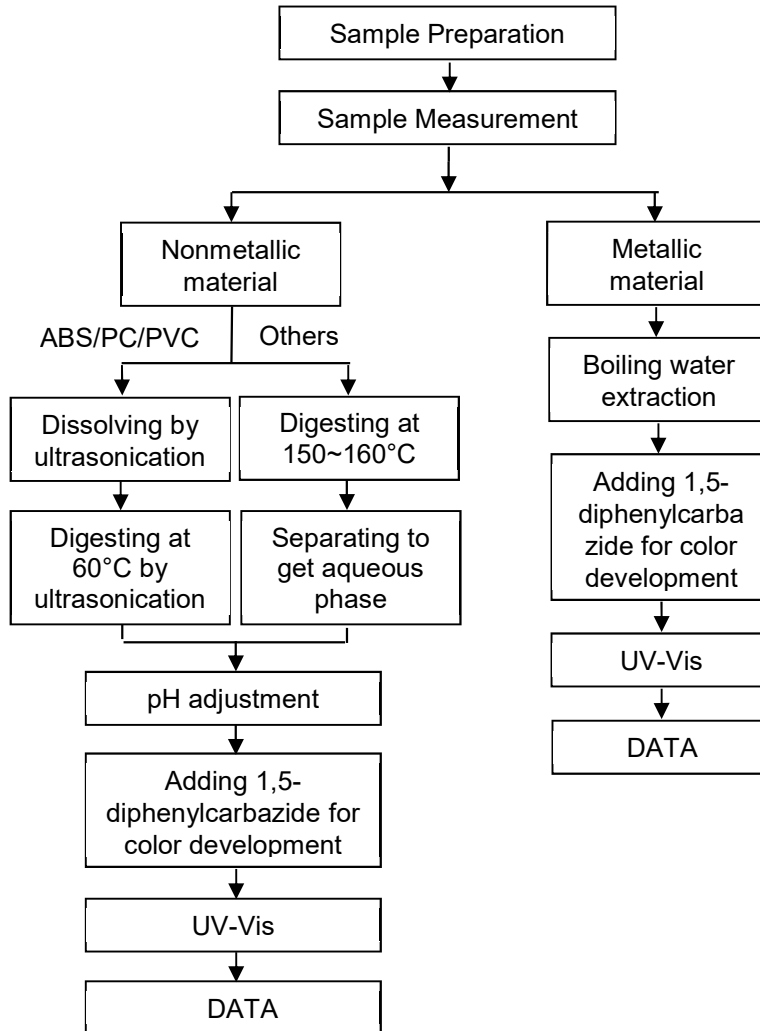

Unless otherwise agreed in writing, this document is issued by the Company subject to its General Conditions of Service printed overleaf, available on request or accessible at <http://www.sgs.com/en/Terms-and-Conditions.aspx> and, for electronic format documents, subject to Terms and Conditions for Electronic Documents at <http://www.sgs.com/en/Terms-and-Conditions/Terms-e-Documents.aspx>. Attention is drawn to the limitation of liability, indemnification and jurisdiction issues defined therein. Any holder of this document is advised that information contained hereon reflects the Company's findings at the time of its intervention only and within the limits of Client's instructions, if any. The Company's sole responsibility is to its Client and this document does not exonerate parties to a transaction from exercising all their rights and obligations under the transaction documents. This document cannot be reproduced except in full, without prior written approval of the Company. Any unauthorized alteration, forgery or falsification of the content or appearance of this document is unlawful and offenders may be prosecuted to the fullest extent of the law. Unless otherwise stated the results shown in this test report refer only to the sample(s) tested.

Attention: To check the authenticity of testing /inspection report & certificate, please contact us at telephone: (86-755) 8307 1443, or email: CN.Doccheck@sgs.com

SGS-CSTC Standards Technical Services Co., Ltd.
Shenzhen Branch Testing Center-Chemical Laboratory

Room 101-901, Plant 4 & Room 101, Plant 2 & Room 101, Plant 3 & Room 301-501, Plant 3, Jianghao (Bantian) Industrial Plant Area, No. 430, Jihua Road, Bantian Community, Bantian Street, Longgang District, Shenzhen, Guangdong, China 518129 www.sgs.com.cn
中国·广东·深圳市龙岗区坂田街道坂田社区吉华路430号江灏(坂田)工业区厂房4号101-901、2号101、3号301-501 邮编:518129 t:(86-755) 25328888 sgs.china@sgs.com

PBBs/PBDEs Testing Flow Chart

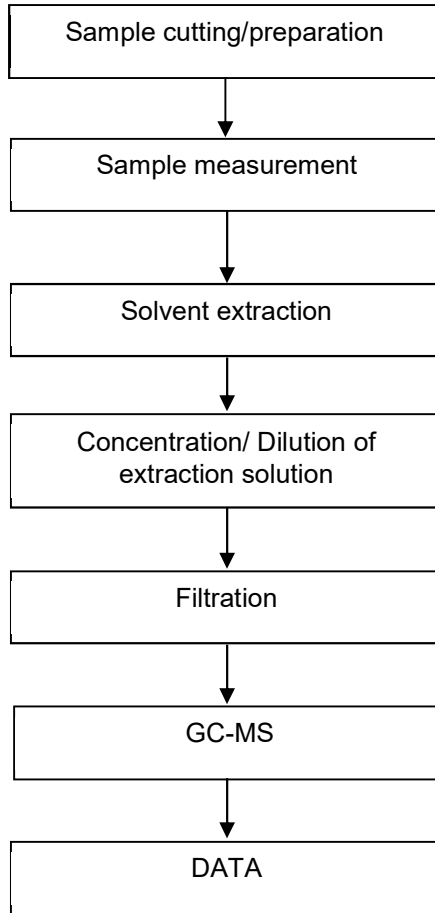

Unless otherwise agreed in writing, this document is issued by the Company subject to its General Conditions of Service printed overleaf, available on request or accessible at <http://www.sgs.com/en/Terms-and-Conditions.aspx> and, for electronic format documents, subject to Terms and Conditions for Electronic Documents at <http://www.sgs.com/en/Terms-and-Conditions/Terms-e-Documents.aspx>. Attention is drawn to the limitation of liability, indemnification and jurisdiction issues defined therein. Any holder of this document is advised that information contained hereon reflects the Company's findings at the time of its intervention only and within the limits of Client's instructions, if any. The Company's sole responsibility is to its Client and this document does not exonerate parties to a transaction from exercising all their rights and obligations under the transaction documents. This document cannot be reproduced except in full, without prior written approval of the Company. Any unauthorized alteration, forgery or falsification of the content or appearance of this document is unlawful and offenders may be prosecuted to the fullest extent of the law. Unless otherwise stated the results shown in this test report refer only to the sample(s) tested.

Attention: To check the authenticity of testing /inspection report & certificate, please contact us at telephone: (86-755) 8307 1443, or email: CN.Doccheck@sgs.com

SGS-CSTC Standards Technical Services Co., Ltd.
Shenzhen Branch Testing Center Chemical Laboratory

Room 101-901, Plant 4 & Room 101, Plant 2 & Room 101, Plant 3 & Room 301-501, Plant 3, Jianghao (Bantian) Industrial Plant Area, No. 430, Jihua Road, Bantian Community, Bantian Street, Longgang District, Shenzhen, Guangdong, China 518129 www.sgs.com
中国·广东·深圳市龙岗区坂田街道坂田社区吉华路430号江灏(坂田)工业区厂房4号101-901、2号101、3号101、3号301-501 邮编:518129 t:(86-755) 25328888 sgs.china@sgs.com

Phthalates Testing Flow Chart

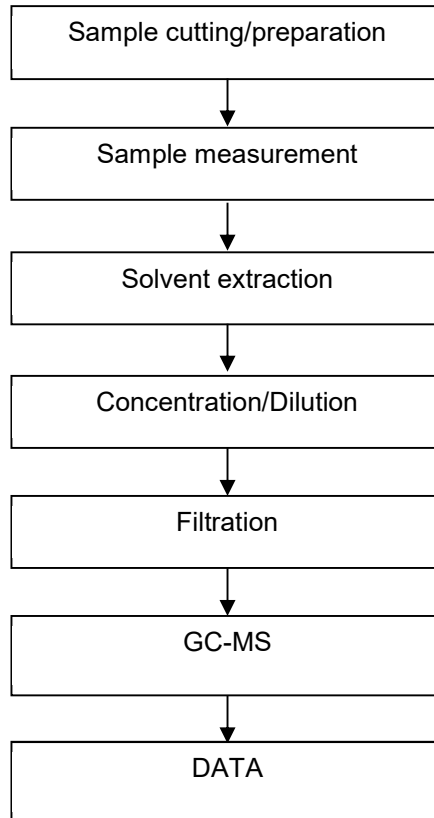

Unless otherwise agreed in writing, this document is issued by the Company subject to its General Conditions of Service printed overleaf, available on request or accessible at <http://www.sgs.com/en/Terms-and-Conditions.aspx> and, for electronic format documents, subject to Terms and Conditions for Electronic Documents at <http://www.sgs.com/en/Terms-and-Conditions/Terms-e-Documents.aspx>. Attention is drawn to the limitation of liability, indemnification and jurisdiction issues defined therein. Any holder of this document is advised that information contained hereon reflects the Company's findings at the time of its intervention only and within the limits of Client's instructions, if any. The Company's sole responsibility is to its Client and this document does not exonerate parties to a transaction from exercising all their rights and obligations under the transaction documents. This document cannot be reproduced except in full, without prior written approval of the Company. Any unauthorized alteration, forgery or falsification of the content or appearance of this document is unlawful and offenders may be prosecuted to the fullest extent of the law. Unless otherwise stated the results shown in this test report refer only to the sample(s) tested.

Attention: To check the authenticity of testing /inspection report & certificate, please contact us at telephone: (86-755) 8307 1443, or email: CN.Doccheck@sgs.com

SGS-CSTC Standards Technical Services Co., Ltd.
Shenzhen Branch Testing Center Chemical Laboratory

Room 101-901, Plant 4 & Room 101, Plant 2 & Room 101, Plant 3 & Room 301-501, Plant 3, Jianghao (Bantian) Industrial Plant Area, No. 430, Jihua Road, Bantian Community, Bantian Street, Longgang District, Shenzhen, Guangdong, China 518129 www.sgs.com.cn
中国·广东·深圳市龙岗区坂田街道坂田社区吉华路430号江灏(坂田)工业区厂房4号101-901、2号101、3号101、3号301-501 邮编:518129 t:(86-755) 25328888 sgs.china@sgs.com

Test Report

No.: SZXEC23000888001

Date: Jun 13, 2023

Page 10 of 12

Sample Photo:

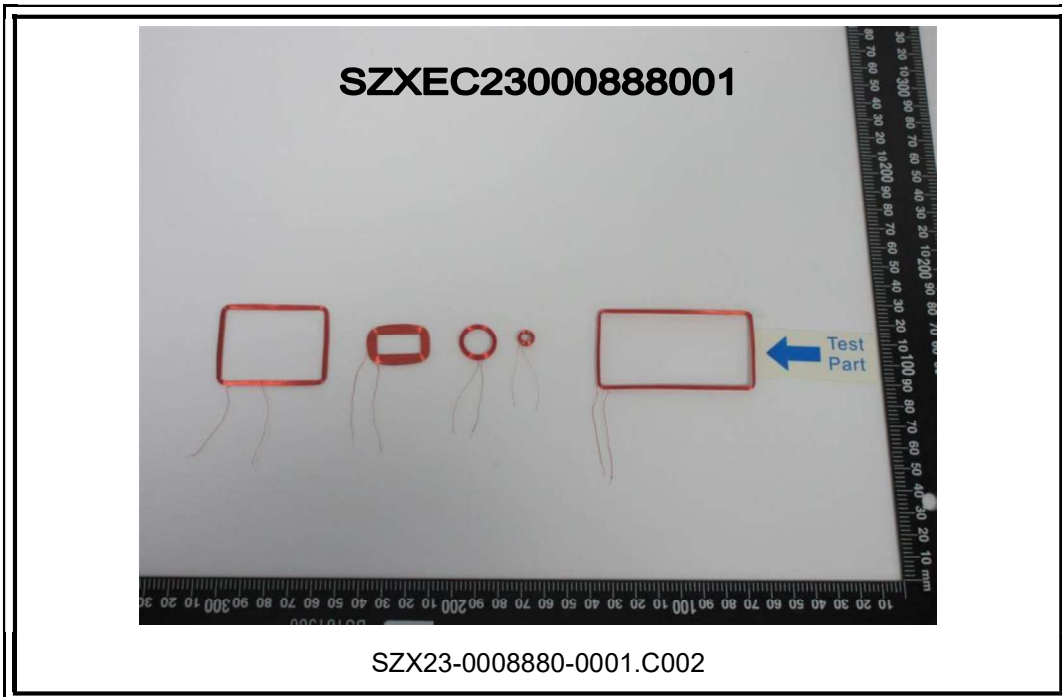

Unless otherwise agreed in writing, this document is issued by the Company subject to its General Conditions of Service printed overleaf, available on request or accessible at <http://www.sgs.com/en/Terms-and-Conditions.aspx> and, for electronic format documents, subject to Terms and Conditions for Electronic Documents at <http://www.sgs.com/en/Terms-and-Conditions/Terms-e-Documents.aspx>. Attention is drawn to the limitation of liability, indemnification and jurisdiction issues defined therein. Any holder of this document is advised that information contained hereon reflects the Company's findings at the time of its intervention only and within the limits of Client's instructions, if any. The Company's sole responsibility is to its Client and this document does not exonerate parties to a transaction from exercising all their rights and obligations under the transaction documents. This document cannot be reproduced except in full, without prior written approval of the Company. Any unauthorized alteration, forgery or falsification of the content or appearance of this document is unlawful and offenders may be prosecuted to the fullest extent of the law. Unless otherwise stated the results shown in this test report refer only to the sample(s) tested.

Attention: To check the authenticity of testing /inspection report & certificate, please contact us at telephone: (86-755) 8307 1443, or email: CN.Doccheck@sgs.com

SGS-CSTC Standards Technical Services Co., Ltd.
Shenzhen Branch Testing Center Chemical Laboratory

Room 101-901, Plant 4 & Room 101, Plant 2 & Room 101, Plant 3 & Room 301-901, Plant 3, Jiangheo (Bantian) Industrial Plant Area, No. 430, Jihua Road, Bantian Community, Bantian Street, Longgang District, Shenzhen, Guangdong, China 518129 www.sgs.com
中国·广东·深圳市龙岗区坂田街道坂田社区吉华路430号江源(坂田)工业厂区厂房4号101-901、2号101、3号101、3号301-501 邮编:518129 t:(86-755) 25328888 sgs.china@sgs.com



Unless otherwise agreed in writing, this document is issued by the Company subject to its General Conditions of Service printed overleaf, available on request or accessible at <http://www.sgs.com/en/Terms-and-Conditions.aspx> and, for electronic format documents, subject to Terms and Conditions for Electronic Documents at <http://www.sgs.com/en/Terms-and-Conditions/Terms-e-Documents.aspx>. Attention is drawn to the limitation of liability, indemnification and jurisdiction issues defined therein. Any holder of this document is advised that information contained hereon reflects the Company's findings at the time of its intervention only and within the limits of Client's instructions, if any. The Company's sole responsibility is to its Client and this document does not exonerate parties to a transaction from exercising all their rights and obligations under the transaction documents. This document cannot be reproduced except in full, without prior written approval of the Company. Any unauthorized alteration, forgery or falsification of the content or appearance of this document is unlawful and offenders may be prosecuted to the fullest extent of the law. Unless otherwise stated the results shown in this test report refer only to the sample(s) tested.

Attention: To check the authenticity of testing /inspection report & certificate, please contact us at telephone: (86-755) 8307 1443, or email: CN.Doccheck@sgs.com

SGS-CSTC Standards Technical Services Co., Ltd.
Shenzhen Branch Testing Center Chemical Laboratory

Room 101-901, Plant 4 & Room 101, Plant 2 & Room 101, Plant 3 & Room 301-501, Plant 3, Jianghao (Bantian) Industrial Plant Area, No. 430, Jihua Road, Bantian Community, Bantian Street, Longgang District, Shenzhen, Guangdong, China 518129 www.sgs.com
中国·广东·深圳市龙岗区坂田街道坂田社区吉华路430号江灏(坂田)工业厂区厂房4号101-901、2号101、3号101、3号301-501 邮编:518129 t:(86-755) 25328888 sgs.china@sgs.com



SGS authenticate the photo on original report only

*** End of Report ***



Unless otherwise agreed in writing, this document is issued by the Company subject to its General Conditions of Service printed overleaf, available on request or accessible at <http://www.sgs.com/en/Terms-and-Conditions.aspx> and, for electronic format documents, subject to Terms and Conditions for Electronic Documents at <http://www.sgs.com/en/Terms-and-Conditions/Terms-e-Document.aspx>. Attention is drawn to the limitation of liability, Indemnification and Jurisdiction issues defined therein. Any holder of this document is advised that information contained hereon reflects the Company's findings at the time of its intervention only and within the limits of Client's instructions, if any. The Company's sole responsibility is to its Client and this document does not exonerate parties to a transaction from exercising all their rights and obligations under the transaction documents. This document cannot be reproduced except in full, without prior written approval of the Company. Any unauthorized alteration, forgery or falsification of the content or appearance of this document is unlawful and offenders may be prosecuted to the fullest extent of the law. Unless otherwise stated the results shown in this test report refer only to the sample(s) tested.

Attention: To check the authenticity of testing /inspection report & certificate, please contact us at telephone: (86-755) 8307 1443, or email: CN.Doccheck@sgs.com

检测报告

编号: SZXEC23000888002

日期: 2023年06月13日

第1页, 共12页

客户名称: 东莞市泛亚电子有限公司
客户地址: 广东省东莞市石碣镇科技东路194号

样品名称: 线圈
以上样品及信息由客户提供。

SGS 工作编号: SZP23-001370
样品接收时间: 2023年05月15日
检测周期: 2023年05月15日~2023年05月24日
检测要求: 根据客户要求检测
检测方法: 见后续页。
检测结果: 见后续页。

检测要求	结论
欧盟 RoHS 指令 2011/65/EU 附录 II 的修正指令(EU) 2015/863- 铅、汞、镉、六价铬、多溴联苯(PBBs)、多溴二苯醚(PBDEs)、邻苯二甲酸二丁酯 (DBP)、邻苯二甲酸丁苄酯(BBP)、邻苯二甲酸二(2-乙基己基)酯(DEHP)和邻苯二甲酸二异丁酯(DIBP)	符合

通标标准技术服务有限公司深圳分公司
授权签名

Tina Fan 范萍
批准签署人

scan to see the report



C7C4328B

Unless otherwise agreed in writing, this document is issued by the Company subject to its General Conditions of Service printed overleaf, available on request or accessible at <http://www.sgs.com/en/Terms-and-Conditions.aspx> and, for electronic format documents, subject to Terms and Conditions for Electronic Documents at <http://www.sgs.com/en/Terms-and-Conditions/Terms-e-Documents.aspx>. Attention is drawn to the limitation of liability, indemnification and jurisdiction issues defined therein. Any holder of this document is advised that information contained hereon reflects the Company's findings at the time of its intervention only and within the limits of Client's instructions, if any. The Company's sole responsibility is to its Client and this document does not exonerate parties to a transaction from exercising all their rights and obligations under the transaction documents. This document cannot be reproduced except in full, without prior written approval of the Company. Any unauthorized alteration, forgery or falsification of the content or appearance of this document is unlawful and offenders may be prosecuted to the fullest extent of the law. Unless otherwise stated the results shown in this test report refer only to the sample(s) tested.

Attention: To check the authenticity of testing / inspection report & certificate, please contact us at telephone: (86-755) 8307 1443, or email: CN.Doccheck@sgs.com

Room 101-901, Plant 4 & Room 101, Plant 2 & Room 101, Plant 3 & Room 301-501, Plant 3, Jianghao (Bantian) Industrial Plant Area, No. 430, Jihua Road, Bantian Community, Bantian Street, Longgang District, Shenzhen, Guangdong, China 518129 www.sgs.com.cn
中国·广东·深圳市龙岗区坂田街道坂田社区吉华路430号江豪(坂田)工业厂区厂房4号101-901、2号101、3号101、3号301-501 邮编:518129 t:(86-755)25328888 sgs.china@sgs.com



检测结果:

检测部件外观描述:

样品序号	样品编号	SGS 样品 ID	样品描述
SN1	A1	SZX23-0008880-0001.C001	带无色透明表层的铜色金属线 A1#
SN2	A2	SZX23-0008880-0001.C002	带红色表层的银色金属线 A2#
SN3	A3	SZX23-0008880-0001.C003	白色材料 A3#
SN4	A4	SZX23-0008880-0001.C004	白色材料 A4#
SN5	A5	SZX23-0008880-0001.C005	深灰色磁芯 A5#
SN6	A6	SZX23-0008880-0001.C006	银色金属 A6#

备注:

- (1) 1 mg/kg = 1 ppm = 0.0001%
- (2) MDL= 方法检测限
- (3) ND = 未检出 (< MDL)
- (4) "-" = 未规定

欧盟 RoHS 指令 2011/65/EU 附录 II 的修正指令(EU) 2015/863- 铅、汞、镉、六价铬、多溴联苯(PBBs)、多溴二苯醚(PBDEs)、邻苯二甲酸二丁酯 (DBP)、邻苯二甲酸丁苄酯(BBP)、邻苯二甲酸二(2-乙基己基)酯 (DEHP)和邻苯二甲酸二异丁酯(DIBP)

检测方法: 参考 IEC 62321-4:2013+AMD1:2017, IEC 62321-5:2013, IEC 62321-7-2:2017, IEC 62321-6:2015 和 IEC 62321-8:2017, 采用 ICP-OES, UV-Vis 和 GC-MS 进行分析。

检测项目	限值	单位	MDL	A1	A2	A3
镉 (Cd)	100	mg/kg	2	ND	ND	ND
铅 (Pb)	1000	mg/kg	2	ND	ND	ND
汞 (Hg)	1000	mg/kg	2	ND	ND	ND
六价铬(Cr(VI))	1000	mg/kg	8	ND	ND	ND
多溴联苯之和(PBBs)	1000	mg/kg	-	ND	ND	ND
一溴联苯(MonoBB)	-	mg/kg	5	ND	ND	ND
二溴联苯(DiBB)	-	mg/kg	5	ND	ND	ND
三溴联苯(TriBB)	-	mg/kg	5	ND	ND	ND
四溴联苯(TetraBB)	-	mg/kg	5	ND	ND	ND
五溴联苯(PentaBB)	-	mg/kg	5	ND	ND	ND
六溴联苯(HexaBB)	-	mg/kg	5	ND	ND	ND
七溴联苯(HeptaBB)	-	mg/kg	5	ND	ND	ND
八溴联苯(OctaBB)	-	mg/kg	5	ND	ND	ND
九溴联苯(NonaBB)	-	mg/kg	5	ND	ND	ND
十溴联苯(DecaBB)	-	mg/kg	5	ND	ND	ND



SGS-Standard Technical Services Co., Ltd.
Shenzhen Branch Testing Center-Chemical Laboratory

Unless otherwise agreed in writing, this document is issued by the Company subject to its General Conditions of Service printed overleaf, available on request or accessible at <http://www.sgs.com/en/Terms-and-Conditions.aspx> and, for electronic format documents, subject to Terms and Conditions for Electronic Documents at <http://www.sgs.com/en/Terms-and-Conditions/Terms-e-Documents.aspx>. Attention is drawn to the limitation of liability, indemnification and jurisdiction issues defined therein. Any holder of this document is advised that information contained hereon reflects the Company's findings at the time of its intervention only and within the limits of Client's instructions, if any. The Company's sole responsibility is to its Client and this document does not exonerate parties to a transaction from exercising all their rights and obligations under the transaction documents. This document cannot be reproduced except in full, without prior written approval of the Company. Any unauthorized alteration, forgery or falsification of the content or appearance of this document is unlawful and offenders may be prosecuted to the fullest extent of the law. Unless otherwise stated the results shown in this test report refer only to the sample(s) tested.

Attention: To check the authenticity of testing /inspection report & certificate, please contact us at telephone: (86-755) 8307 1443, or email: CN.Doccheck@sgs.com

Room 101-901, Plant 4 & Room 101, Plant 2 & Room 101, Plant 3 & Room 301-501, Plant 3, Jianghao (Bantian) Industrial Plant Area, No. 430, Jihua Road, Bantian Community, Bantian Street, Longgang District, Shenzhen, Guangdong, China 518129 www.sgs.com.cn
中国·广东·深圳市龙岗区坂田街道坂田社区吉华路430号江灏(坂田)工业区厂房4号101-901、2号101、3号101、3号301-501 邮编:518129 t:(86-755) 25328888 sgs.china@sgs.com

检测报告

编号: SZXEC23000888002

日期: 2023年06月13日

第3页, 共12页

检测项目	限值	单位	MDL	A1	A2	A3
多溴二苯醚之和(PBDEs)	1000	mg/kg	-	ND	ND	ND
一溴二苯醚(MonoBDE)	-	mg/kg	5	ND	ND	ND
二溴二苯醚(DiBDE)	-	mg/kg	5	ND	ND	ND
三溴二苯醚(TriBDE)	-	mg/kg	5	ND	ND	ND
四溴二苯醚(TetraBDE)	-	mg/kg	5	ND	ND	ND
五溴二苯醚(PentaBDE)	-	mg/kg	5	ND	ND	ND
六溴二苯醚(HexaBDE)	-	mg/kg	5	ND	ND	ND
七溴二苯醚(HeptaBDE)	-	mg/kg	5	ND	ND	ND
八溴二苯醚(OctaBDE)	-	mg/kg	5	ND	ND	ND
九溴二苯醚(NonaBDE)	-	mg/kg	5	ND	ND	ND
十溴二苯醚(DecaBDE)	-	mg/kg	5	ND	ND	ND
邻苯二甲酸二丁酯 (DBP)	1000	mg/kg	50	ND	ND	ND
邻苯二甲酸丁苄酯 (BBP)	1000	mg/kg	50	ND	ND	ND
邻苯二甲酸二(2-乙基己基)酯 (DEHP)	1000	mg/kg	50	ND	ND	ND
邻苯二甲酸二异丁酯 (DIBP)	1000	mg/kg	50	ND	ND	ND

检测项目	限值	单位	MDL	A4	A5
镉 (Cd)	100	mg/kg	2	ND	ND
铅 (Pb)	1000	mg/kg	2	ND	ND
汞 (Hg)	1000	mg/kg	2	ND	ND
六价铬(Cr(VI))	1000	mg/kg	8	ND	ND
多溴联苯之和(PBBs)	1000	mg/kg	-	ND	ND
一溴联苯(MonoBB)	-	mg/kg	5	ND	ND
二溴联苯(DiBB)	-	mg/kg	5	ND	ND
三溴联苯(TriBB)	-	mg/kg	5	ND	ND
四溴联苯(TetraBB)	-	mg/kg	5	ND	ND
五溴联苯(PentaBB)	-	mg/kg	5	ND	ND
六溴联苯(HexaBB)	-	mg/kg	5	ND	ND
七溴联苯(HeptaBB)	-	mg/kg	5	ND	ND
八溴联苯(OctaBB)	-	mg/kg	5	ND	ND
九溴联苯(NonaBB)	-	mg/kg	5	ND	ND
十溴联苯(DecaBB)	-	mg/kg	5	ND	ND
多溴二苯醚之和(PBDEs)	1000	mg/kg	-	ND	ND
一溴二苯醚(MonoBDE)	-	mg/kg	5	ND	ND
二溴二苯醚(DiBDE)	-	mg/kg	5	ND	ND
三溴二苯醚(TriBDE)	-	mg/kg	5	ND	ND
四溴二苯醚(TetraBDE)	-	mg/kg	5	ND	ND
五溴二苯醚(PentaBDE)	-	mg/kg	5	ND	ND
六溴二苯醚(HexaBDE)	-	mg/kg	5	ND	ND
七溴二苯醚(HeptaBDE)	-	mg/kg	5	ND	ND
八溴二苯醚(OctaBDE)	-	mg/kg	5	ND	ND
九溴二苯醚(NonaBDE)	-	mg/kg	5	ND	ND
十溴二苯醚(DecaBDE)	-	mg/kg	5	ND	ND



SGS-CSTC Standards Technical Services Co., Ltd.
Shenzhen Branch Testing Center-Chemical Laboratory

Unless otherwise agreed in writing, this document is issued by the Company subject to its General Conditions of Service printed overleaf, available on request or accessible at <http://www.sgs.com/en/Terms-and-Conditions.aspx> and, for electronic format documents, subject to Terms and Conditions for Electronic Documents at <http://www.sgs.com/en/Terms-and-Conditions/Terms-e-Documents.aspx>. Attention is drawn to the limitation of liability, indemnification and jurisdiction issues defined therein. Any holder of this document is advised that information contained hereon reflects the Company's findings at the time of its intervention only and within the limits of Client's instructions, if any. The Company's sole responsibility is to its Client and this document does not exonerate parties to a transaction from exercising all their rights and obligations under the transaction documents. This document cannot be reproduced except in full, without prior written approval of the Company. Any unauthorized alteration, forgery or falsification of the content or appearance of this document is unlawful and offenders may be prosecuted to the fullest extent of the law. Unless otherwise stated the results shown in this test report refer only to the sample(s) tested.

Attention: To check the authenticity of testing /inspection report & certificate, please contact us at telephone: (86-755) 8307 1443, or email: CN.Doccheck@sgs.com

Room 101-901, Plant 4 & Room 101, Plant 2 & Room 101, Plant 3 & Room 301-501, Plant 3, Jianghao (Bantian) Industrial Plant Area, No. 430, Jihua Road, Bantian Community, Bantian Street, Longgang District, Shenzhen, Guangdong, China 518129 www.sgs.com.cn
中国·广东·深圳市龙岗区坂田街道坂田社区吉华路430号江灏(坂田)工业区厂房4号101-901、2号101、3号101、3号301-501 邮编:518129 t:(86-755) 25328888 sgs.china@sgs.com

检测报告

编号: SZXEC23000888002

日期: 2023年06月13日

第4页, 共12页

检测项目	限值	单位	MDL	A4	A5
邻苯二甲酸二丁酯 (DBP)	1000	mg/kg	50	ND	ND
邻苯二甲酸丁苄酯 (BBP)	1000	mg/kg	50	ND	ND
邻苯二甲酸二(2-乙基己基)酯 (DEHP)	1000	mg/kg	50	ND	ND
邻苯二甲酸二异丁酯 (DIBP)	1000	mg/kg	50	ND	ND

备注:

- (1) 最大允许极限值引用自 RoHS 指令(EU) 2015/863。
- (2) IEC 62321 系列等同于 EN 62321 系列。
- (3) 2021年7月22号开始, DEHP, BBP, DBP 和 DIBP 的限制适用于医疗器械, 包括体外医疗器械, 监控仪表, 包括工业监测和控制仪器。

检测方法: 参考 IEC 62321-4:2013+AMD1:2017, IEC 62321-5:2013, IEC 62321-7-1:2015, IEC 62321-6:2015 和 IEC 62321-8:2017, 采用 ICP-OES, UV-Vis 和 GC-MS 进行分析。

检测项目	限值	单位	MDL	A6
镉 (Cd)	100	mg/kg	2	ND
铅 (Pb)	1000	mg/kg	2	65
汞 (Hg)	1000	mg/kg	2	ND
六价铬(Cr(VI))▼	-	µg/cm ²	0.10	ND
多溴联苯之和(PBBs)	1000	mg/kg	-	ND
一溴联苯(MonoBB)	-	mg/kg	5	ND
二溴联苯(DiBB)	-	mg/kg	5	ND
三溴联苯(TriBB)	-	mg/kg	5	ND
四溴联苯(TetraBB)	-	mg/kg	5	ND
五溴联苯(PentaBB)	-	mg/kg	5	ND
六溴联苯(HexaBB)	-	mg/kg	5	ND
七溴联苯(HeptaBB)	-	mg/kg	5	ND
八溴联苯(OctaBB)	-	mg/kg	5	ND
九溴联苯(NonaBB)	-	mg/kg	5	ND
十溴联苯(DecaBB)	-	mg/kg	5	ND
多溴二苯醚之和(PBDEs)	1000	mg/kg	-	ND
一溴二苯醚(MonoBDE)	-	mg/kg	5	ND
二溴二苯醚(DiBDE)	-	mg/kg	5	ND
三溴二苯醚(TriBDE)	-	mg/kg	5	ND
四溴二苯醚(TetraBDE)	-	mg/kg	5	ND
五溴二苯醚(PentaBDE)	-	mg/kg	5	ND
六溴二苯醚(HexaBDE)	-	mg/kg	5	ND
七溴二苯醚(HeptaBDE)	-	mg/kg	5	ND
八溴二苯醚(OctaBDE)	-	mg/kg	5	ND
九溴二苯醚(NonaBDE)	-	mg/kg	5	ND
十溴二苯醚(DecaBDE)	-	mg/kg	5	ND
邻苯二甲酸二丁酯 (DBP)	1000	mg/kg	50	ND



SGS-CSTC Testing Technology Co., Ltd.
Shenzhen Branch Testing Center-Chemical Laboratory

Unless otherwise agreed in writing, this document is issued by the Company subject to its General Conditions of Service printed overleaf, available on request or accessible at <http://www.sgs.com/en/Terms-and-Conditions.aspx> and, for electronic format documents, subject to Terms and Conditions for Electronic Documents at <http://www.sgs.com/en/Terms-and-Conditions/Terms-e-Documents.aspx>. Attention is drawn to the limitation of liability, indemnification and jurisdiction issues defined therein. Any holder of this document is advised that information contained hereon reflects the Company's findings at the time of its intervention only and within the limits of Client's instructions, if any. The Company's sole responsibility is to its Client and this document does not exonerate parties to a transaction from exercising all their rights and obligations under the transaction documents. This document cannot be reproduced except in full, without prior written approval of the Company. Any unauthorized alteration, forgery or falsification of the content or appearance of this document is unlawful and offenders may be prosecuted to the fullest extent of the law. Unless otherwise stated the results shown in this test report refer only to the sample(s) tested.

Attention: To check the authenticity of testing /inspection report & certificate, please contact us at telephone: (86-755) 8307 1443, or email: CN.Doccheck@sgs.com

Room 101-901, Plant 4 & Room 101, Plant 2 & Room 101, Plant 3 & Room 301-501, Plant 3, Jianghao (Bantian) Industrial Plant Area, No. 430, Jihua Road, Bantian Community, Bantian Street, Longgang District, Shenzhen, Guangdong, China 518129 www.sgs.com.cn
中国·广东·深圳市龙岗区坂田街道坂田社区吉华路430号江灏(坂田)工业区厂房4号101-901、2号101、3号101、3号301-501 邮编:518129 t:(86-755) 25328888 sgs.china@sgs.com

检测报告

编号: SZXEC23000888002

日期: 2023年06月13日

第5页, 共12页

检测项目	限值	单位	MDL	A6
邻苯二甲酸丁苄酯 (BBP)	1000	mg/kg	50	ND
邻苯二甲酸二(2-乙基己基)酯 (DEHP)	1000	mg/kg	50	ND
邻苯二甲酸二异丁酯 (DIBP)	1000	mg/kg	50	ND

备注:

- (1) 最大允许限值引用自RoHS指令(EU) 2015/863。
- (2) IEC 62321系列等同于 EN 62321系列。
- (3) ▼ = a. 当六价铬的浓度高于0.13 µg/cm²时, 样品为阳性, 即含有六价铬;
 b. 当六价铬的浓度为ND (低于0.10 µg/cm²) 时, 样品为阴性, 即未检测到六价铬;
 c. 当六价铬的浓度介于0.10 µg/cm²与0.13 µg/cm²之间时, 无法直接判定是否检测到六价铬, 因不同个体的样品表面差异可能会影响测定结果。

由于未获知样品的存储条件和生产日期, 样品的六价铬检测结果仅能代表测试时样品含六价铬的状态。

除非另有说明, 参照 ILAC-G8:09/2019, 使用简单接受 (w=0) 的二元判定规则进行符合性判定。
 除非另有说明, 此报告结果仅对检测的样品负责。本报告未经本公司书面许可, 不可部分复制。
 检测报告仅用于客户科研、教学、内部质量控制、产品研发等目的, 仅供内部参考。



Unless otherwise agreed in writing, this document is issued by the Company subject to its General Conditions of Service printed overleaf, available on request or accessible at <http://www.sgs.com/en/Terms-and-Conditions.aspx> and, for electronic format documents, subject to Terms and Conditions for Electronic Documents at <http://www.sgs.com/en/Terms-and-Conditions/Terms-e-Documents.aspx>. Attention is drawn to the limitation of liability, indemnification and jurisdiction issues defined therein. Any holder of this document is advised that information contained hereon reflects the Company's findings at the time of its intervention only and within the limits of Client's instructions, if any. The Company's sole responsibility is to its Client and this document does not exonerate parties to a transaction from exercising all their rights and obligations under the transaction documents. This document cannot be reproduced except in full, without prior written approval of the Company. Any unauthorized alteration, forgery or falsification of the content or appearance of this document is unlawful and offenders may be prosecuted to the fullest extent of the law. Unless otherwise stated the results shown in this test report refer only to the sample(s) tested.

Attention: To check the authenticity of testing /inspection report & certificate, please contact us at telephone: (86-755) 8307 1443, or email: CN.Doccheck@sgs.com

SGS-CSTC Standards Technical Services Co., Ltd.
 Shenzhen Branch Testing Center-Chemical Laboratory

Room 101-901, Plant 4 & Room 101, Plant 2 & Room 101, Plant 3 & Room 301-501, Plant 3, Jiangheo (Bantian) Industrial Plant Area, No. 430, Jihua Road, Bantian Community, Bantian Street, Longgang District, Shenzhen, Guangdong, China 518129 www.sgs.com
 中国·广东·深圳市龙岗区坂田街道坂田社区吉华路430号江源(坂田)工业区厂房4号101-901、2号101、3号101、3号301-501 邮编:518129 t:(86-755) 25328888 sgs.china@sgs.com

附件

元素检测流程图

样品按照下述流程被完全消解

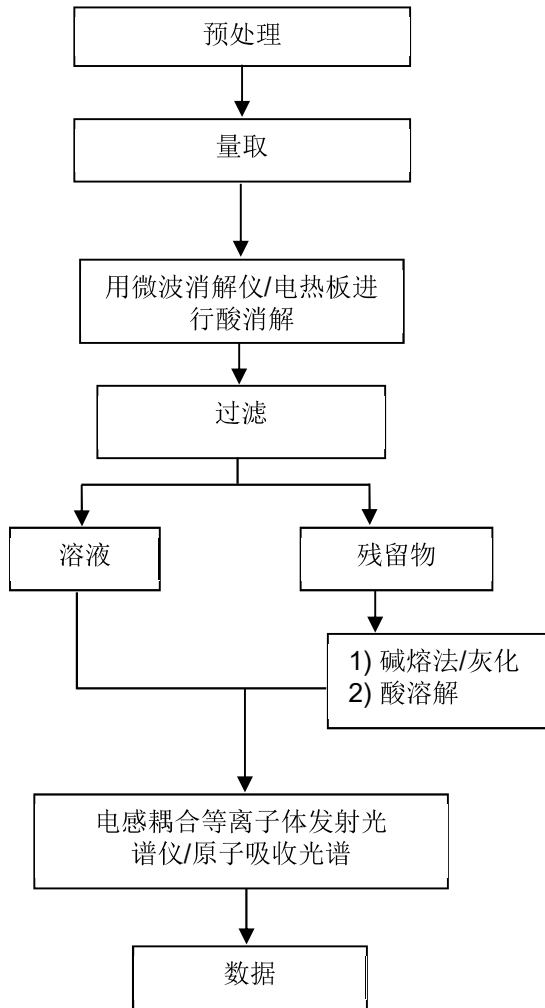

SGS-CSTC Standards Technical Services Co., Ltd.
Shenzhen Branch Testing Center Chemical Laboratory

Unless otherwise agreed in writing, this document is issued by the Company subject to its General Conditions of Service printed overleaf, available on request or accessible at <http://www.sgs.com/en/Terms-and-Conditions.aspx> and, for electronic format documents, subject to Terms and Conditions for Electronic Documents at <http://www.sgs.com/en/Terms-and-Conditions/Terms-e-Documents.aspx>. Attention is drawn to the limitation of liability, indemnification and jurisdiction issues defined therein. Any holder of this document is advised that information contained hereon reflects the Company's findings at the time of its intervention only and within the limits of Client's instructions, if any. The Company's sole responsibility is to its Client and this document does not exonerate parties to a transaction from exercising all their rights and obligations under the transaction documents. This document cannot be reproduced except in full, without prior written approval of the Company. Any unauthorized alteration, forgery or falsification of the content or appearance of this document is unlawful and offenders may be prosecuted to the fullest extent of the law. Unless otherwise stated the results shown in this test report refer only to the sample(s) tested.

Attention: To check the authenticity of testing /inspection report & certificate, please contact us at telephone: (86-755) 8307 1443, or email: CN.Doccheck@sgs.com

Room 101-901, Plant 4 & Room 101, Plant 2 & Room 101, Plant 3 & Room 301-501, Plant 3, Jianghao (Bantian) Industrial Plant Area, No. 430, Jihua Road, Bantian Community, Bantian Street, Longgang District, Shenzhen, Guangdong, China 518129 www.sgs.com
中国·广东·深圳市龙岗区坂田街道坂田社区吉华路430号江灏(坂田)工业区厂房4号101-901、2号101、3号301-501 邮编:518129 t(86-755) 25328888 sgs.china@sgs.com

六价铬检测流程图

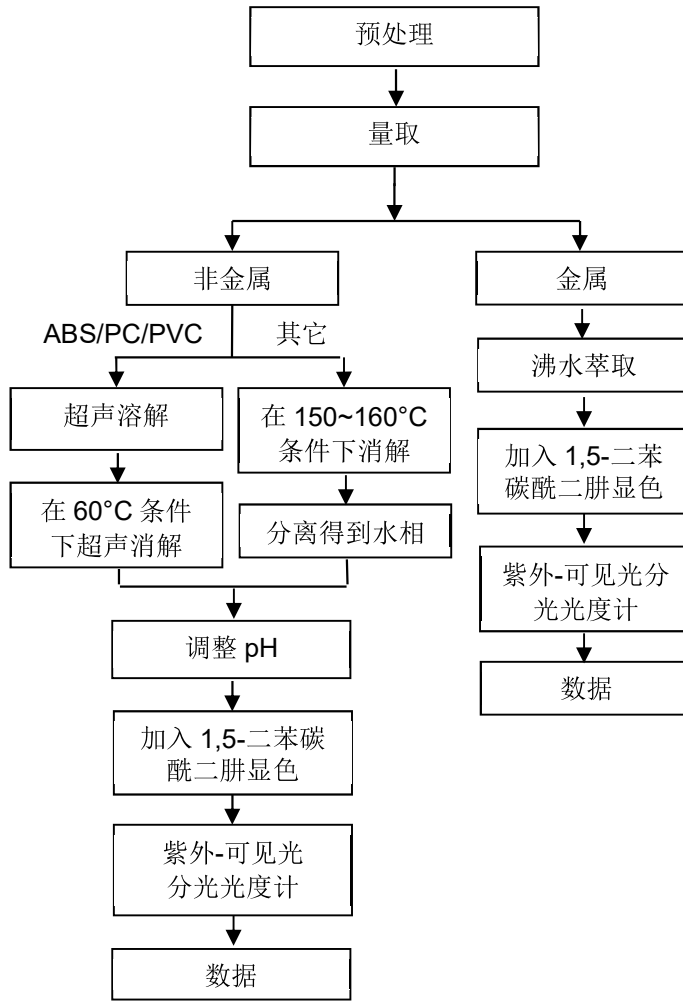

Unless otherwise agreed in writing, this document is issued by the Company subject to its General Conditions of Service printed overleaf, available on request or accessible at <http://www.sgs.com/en/Terms-and-Conditions.aspx> and, for electronic format documents, subject to Terms and Conditions for Electronic Documents at <http://www.sgs.com/en/Terms-and-Conditions/Terms-e-Documents.aspx>. Attention is drawn to the limitation of liability, indemnification and jurisdiction issues defined therein. Any holder of this document is advised that information contained hereon reflects the Company's findings at the time of its intervention only and within the limits of Client's instructions, if any. The Company's sole responsibility is to its Client and this document does not exonerate parties to a transaction from exercising all their rights and obligations under the transaction documents. This document cannot be reproduced except in full, without prior written approval of the Company. Any unauthorized alteration, forgery or falsification of the content or appearance of this document is unlawful and offenders may be prosecuted to the fullest extent of the law. Unless otherwise stated the results shown in this test report refer only to the sample(s) tested.

Attention: To check the authenticity of testing /inspection report & certificate, please contact us at telephone: (86-755) 8307 1443, or email: CN.Doccheck@sgs.com

SGS-CTC 标准技术服务(深圳)有限公司
检验检测专用章
SGS-CTC Standards Technical Services Co., Ltd.
Shenzhen Branch Testing Center Chemical Laboratory

Room 101-901, Plant 4 & Room 101, Plant 2 & Room 101, Plant 3 & Room 301-501, Plant 3, Jianghao (Bantian) Industrial Plant Area, No. 430, Jihua Road, Bantian Community, Bantian Street, Longgang District, Shenzhen, Guangdong, China 518129 www.sgs.com.cn
中国·广东·深圳市龙岗区坂田街道坂田社区吉华路430号江灏(坂田)工业区厂房4号101-901、2号101、3号301-501 邮编:518129 t:(86-755) 25328888 sgs.china@sgs.com

PBBs/PBDEs 检测流程图

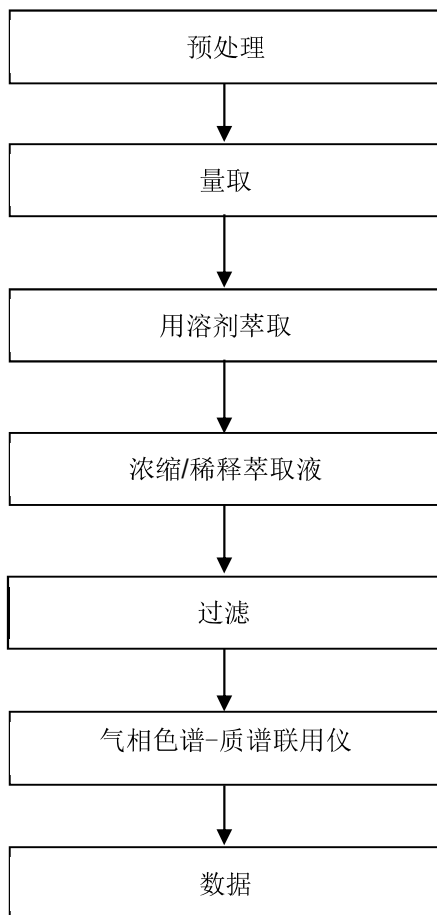

Unless otherwise agreed in writing, this document is issued by the Company subject to its General Conditions of Service printed overleaf, available on request or accessible at <http://www.sgs.com/en/Terms-and-Conditions.aspx> and, for electronic format documents, subject to Terms and Conditions for Electronic Documents at <http://www.sgs.com/en/Terms-and-Conditions/Terms-e-Documents.aspx>. Attention is drawn to the limitation of liability, indemnification and jurisdiction issues defined therein. Any holder of this document is advised that information contained hereon reflects the Company's findings at the time of its intervention only and within the limits of Client's instructions, if any. The Company's sole responsibility is to its Client and this document does not exonerate parties to a transaction from exercising all their rights and obligations under the transaction documents. This document cannot be reproduced except in full, without prior written approval of the Company. Any unauthorized alteration, forgery or falsification of the content or appearance of this document is unlawful and offenders may be prosecuted to the fullest extent of the law. Unless otherwise stated the results shown in this test report refer only to the sample(s) tested.

Attention: To check the authenticity of testing /inspection report & certificate, please contact us at telephone: (86-755) 8307 1443, or email: CN.Doccheck@sgs.com

SGS-CSTC Standards Technical Services Co., Ltd.
Shenzhen Branch Testing Center Chemical Laboratory

Room 101-901, Plant 4 & Room 101, Plant 2 & Room 101, Plant 3 & Room 301-501, Plant 3, Jianghao (Bantian) Industrial Plant Area, No. 430, Jihua Road, Bantian Community, Bantian Street, Longgang District, Shenzhen, Guangdong, China 518129 www.sgs.com.cn
中国·广东·深圳市龙岗区坂田街道坂田社区吉华路430号江灏(坂田)工业区厂房4号101-901、2号101、3号101、3号301-501 邮编:518129 t:(86-755) 25328888 sgs.china@sgs.com

Phthalates 检测流程图

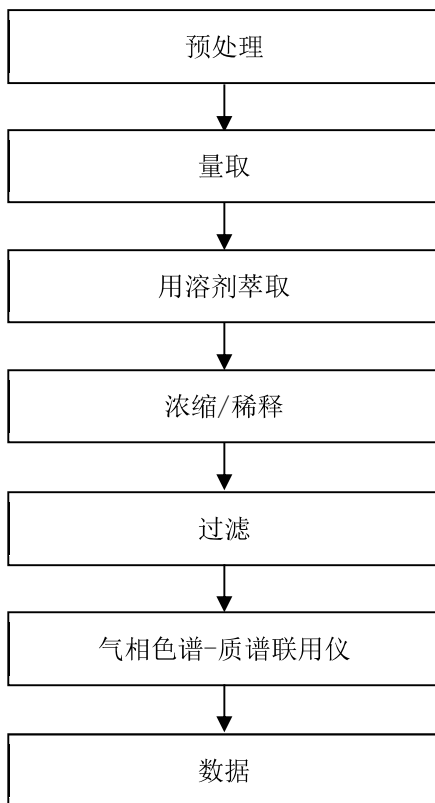

Unless otherwise agreed in writing, this document is issued by the Company subject to its General Conditions of Service printed overleaf, available on request or accessible at <http://www.sgs.com/en/Terms-and-Conditions.aspx> and, for electronic format documents, subject to Terms and Conditions for Electronic Documents at <http://www.sgs.com/en/Terms-and-Conditions/Terms-e-Documents.aspx>. Attention is drawn to the limitation of liability, indemnification and jurisdiction issues defined therein. Any holder of this document is advised that information contained hereon reflects the Company's findings at the time of its intervention only and within the limits of Client's instructions, if any. The Company's sole responsibility is to its Client and this document does not exonerate parties to a transaction from exercising all their rights and obligations under the transaction documents. This document cannot be reproduced except in full, without prior written approval of the Company. Any unauthorized alteration, forgery or falsification of the content or appearance of this document is unlawful and offenders may be prosecuted to the fullest extent of the law. Unless otherwise stated the results shown in this test report refer only to the sample(s) tested.

Attention: To check the authenticity of testing /inspection report & certificate, please contact us at telephone: (86-755) 8307 1443, or email: CN.Doccheck@sgs.com

SGS-CSTC Standards Technical Services Co., Ltd.
Shenzhen Branch Testing Center Chemical Laboratory

Room 101-901, Plant 4 & Room 101, Plant 2 & Room 101, Plant 3 & Room 301-501, Plant 3, Jiangtao (Bantian) Industrial Plant Area, No. 430, Jihua Road, Bantian Community, Bantian Street, Longgang District, Shenzhen, Guangdong, China 518129 www.sgs.com
中国·广东·深圳市龙岗区坂田街道坂田社区吉华路430号江涛(坂田)工业厂区厂房4号101-901、2号101、3号101、3号301-501 邮编:518129 t:(86-755) 25328888 sgs.china@sgs.com

检测报告

编号: SZXEC23000888002

日期: 2023年06月13日

第10页, 共12页

样品照片:

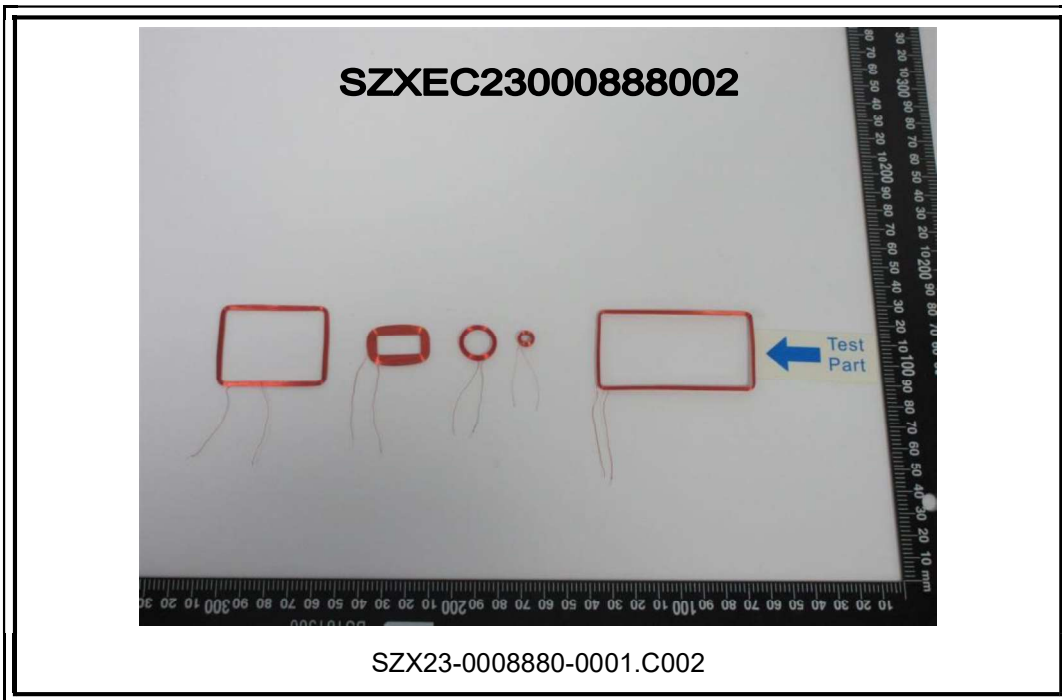

Unless otherwise agreed in writing, this document is issued by the Company subject to its General Conditions of Service printed overleaf, available on request or accessible at <http://www.sgs.com/en/Terms-and-Conditions.aspx> and, for electronic format documents, subject to Terms and Conditions for Electronic Documents at <http://www.sgs.com/en/Terms-and-Conditions/Terms-e-Documents.aspx>. Attention is drawn to the limitation of liability, indemnification and jurisdiction issues defined therein. Any holder of this document is advised that information contained hereon reflects the Company's findings at the time of its intervention only and within the limits of Client's instructions, if any. The Company's sole responsibility is to its Client and this document does not exonerate parties to a transaction from exercising all their rights and obligations under the transaction documents. This document cannot be reproduced except in full, without prior written approval of the Company. Any unauthorized alteration, forgery or falsification of the content or appearance of this document is unlawful and offenders may be prosecuted to the fullest extent of the law. Unless otherwise stated the results shown in this test report refer only to the sample(s) tested.

Attention: To check the authenticity of testing /inspection report & certificate, please contact us at telephone: (86-755) 8307 1443, or email: CN.Doccheck@sgs.com

SGS-CSTC Standards Technical Services Co., Ltd.
Shenzhen Branch Testing Center-Chemical Laboratory

Room 101-901, Plant 4 & Room 101, Plant 2 & Room 101, Plant 3 & Room 301-501, Plant 3, Jiangheo (Bantian) Industrial Plant Area, No. 430, Jihua Road, Bantian Community, Bantian Street, Longgang District, Shenzhen, Guangdong, China 518129 www.sgs.com
中国·广东·深圳市龙岗区坂田街道坂田社区吉华路430号江源(坂田)工业区厂房4号101-901、2号101、3号301-501 邮编:518129 t:(86-755) 25328888 sgs.china@sgs.com



Unless otherwise agreed in writing, this document is issued by the Company subject to its General Conditions of Service printed overleaf, available on request or accessible at <http://www.sgs.com/en/Terms-and-Conditions.aspx> and, for electronic format documents, subject to Terms and Conditions for Electronic Documents at <http://www.sgs.com/en/Terms-and-Conditions/Terms-e-Documents.aspx>. Attention is drawn to the limitation of liability, indemnification and jurisdiction issues defined therein. Any holder of this document is advised that information contained hereon reflects the Company's findings at the time of its intervention only and within the limits of Client's instructions, if any. The Company's sole responsibility is to its Client and this document does not exonerate parties to a transaction from exercising all their rights and obligations under the transaction documents. This document cannot be reproduced except in full, without prior written approval of the Company. Any unauthorized alteration, forgery or falsification of the content or appearance of this document is unlawful and offenders may be prosecuted to the fullest extent of the law. Unless otherwise stated the results shown in this test report refer only to the sample(s) tested.

Attention: To check the authenticity of testing /inspection report & certificate, please contact us at telephone: (86-755) 8307 1443, or email: CN.Doccheck@sgs.com

SGS-CSTC Standards Technical Services Co., Ltd.
Shenzhen Branch Testing Center Chemical Laboratory

Room 101-901, Plant 4 & Room 101, Plant 2 & Room 101, Plant 3 & Room 301-501, Plant 3, Jianghao (Bantian) Industrial Plant Area, No. 430, Jihua Road, Bantian Community, Bantian Street, Longgang District, Shenzhen, Guangdong, China 518129 www.sgs.com.cn
中国·广东·深圳市龙岗区坂田街道坂田社区吉华路430号江灏(坂田)工业区厂房4号101-901、2号101、3号101、3号301-501 邮编:518129 t:(86-755) 25328888 sgs.china@sgs.com



此照片仅限于随 SGS 正本报告使用

报告结束



SGS-CSTC Standards Technical Services Co., Ltd.
Shenzhen Branch Testing Center Chemical Laboratory

Unless otherwise agreed in writing, this document is issued by the Company subject to its General Conditions of Service printed overleaf, available on request or accessible at <http://www.sgs.com/en/Terms-and-Conditions.aspx> and, for electronic format documents, subject to Terms and Conditions for Electronic Documents at <http://www.sgs.com/en/Terms-and-Conditions/Terms-e-Documents.aspx>. Attention is drawn to the limitation of liability, indemnification and jurisdiction issues defined therein. Any holder of this document is advised that information contained hereon reflects the Company's findings at the time of its intervention only and within the limits of Client's instructions, if any. The Company's sole responsibility is to its Client and this document does not exonerate parties to a transaction from exercising all their rights and obligations under the transaction documents. This document cannot be reproduced except in full, without prior written approval of the Company. Any unauthorized alteration, forgery or falsification of the content or appearance of this document is unlawful and offenders may be prosecuted to the fullest extent of the law. Unless otherwise stated the results shown in this test report refer only to the sample(s) tested.

Attention: To check the authenticity of testing /inspection report & certificate, please contact us at telephone: (86-755) 8307 1443, or email: CN.Doccheck@sgs.com

Room 101-901, Plant 4 & Room 101, Plant 2 & Room 101, Plant 3 & Room 301-501, Plant 3, Jianghao (Bantian) Industrial Plant Area, No. 430, Jihua Road, Bantian Community, Bantian Street, Longgang District, Shenzhen, Guangdong, China 518129 www.sgs.com
中国·广东·深圳市龙岗区坂田街道坂田社区吉华路430号江灏(坂田)工业厂区厂房4号101-901、2号101、3号101、3号301-501 邮编:518129 t:(86-755) 25328888 sgs.china@sgs.com

Test Report

No.: SZXEC23000888003

Date: Jun 13, 2023

Page 1 of 6

Client Name: DONGGUAN FINE ELECTRONICS LIMITED

Client Address: 194 KEJI EAST ROAD, SHIJIE TOWN, DONGGUAN CITY, GUANGDONG PROVINCE

Sample Name: Coil

The above sample(s) and information were provided by the client.

SGS Job No.: SZP23-001370
 Sample Receiving Date: May 15, 2023
 Testing Period: May 15, 2023 ~ May 24, 2023
 Test Requested: Select test(s) as requested by the client.
 Test Method(s): Please refer to next page(s).
 Test Result(s): Please refer to next page(s).

Test Requirement	Conclusion
Halogen	See Results

Signed for and on behalf of
 SGS-CSTC Standards Technical Services Co., Ltd. Shenzhen Branch

Tina Fan
 Approved Signatory

scan to see the report



49B63686



SGS-CSTC Standards Technical Services Co., Ltd.
 Shenzhen Branch Testing Center Chemical Laboratory

Unless otherwise agreed in writing, this document is issued by the Company subject to its General Conditions of Service printed overleaf, available on request or accessible at <http://www.sgs.com/en/Terms-and-Conditions.aspx> and, for electronic format documents, subject to Terms and Conditions for Electronic Documents at <http://www.sgs.com/en/Terms-and-Conditions/Terms-e-Document.aspx>. Attention is drawn to the limitation of liability, indemnification and jurisdiction issues defined therein. Any holder of this document is advised that information contained hereon reflects the Company's findings at the time of its intervention only and within the limits of Client's instructions, if any. The Company's sole responsibility is to its Client and this document does not exonerate parties to a transaction from exercising all their rights and obligations under the transaction documents. This document cannot be reproduced except in full, without prior written approval of the Company. Any unauthorized alteration, forgery or falsification of the content or appearance of this document is unlawful and offenders may be prosecuted to the fullest extent of the law. Unless otherwise stated the results shown in this test report refer only to the sample(s) tested.

Attention: To check the authenticity of testing /inspection report & certificate, please contact us at telephone: (86-755) 8307 1443, or email: CN.Doccheck@sgs.com

Room 101-901, Plant 4 & Room 101, Plant 2 & Room 101, Plant 3 & Room 301-501, Plant 3, Jianghao (Bantian) Industrial Plant Area, No. 430, Jihua Road, Bantian Community, Bantian Street, Longgang District, Shenzhen, Guangdong, China 518129 www.sgs.com
 中国·广东·深圳市龙岗区坂田街道坂田社区吉华路430号江豪(坂田)工业厂区厂房4号101-901、2号101、3号101、3号301-501 邮编:518129 t:(86-755) 25328888 sgs.china@sgs.com

Test Result(s):

Test Part Description:

SN ID	Sample No.	SGS Sample ID	Description
SN1	A1	SZX23-0008880-0001.C001	Copper-colored metal wire with colorless transparent surface A1#
SN2	A2	SZX23-0008880-0001.C002	Silvery metal wire with red surface A2#
SN3	A3	SZX23-0008880-0001.C003	White material A3#
SN4	A4	SZX23-0008880-0001.C004	White material A4#
SN5	A5	SZX23-0008880-0001.C005	Dark grey core A5#
SN6	A6	SZX23-0008880-0001.C006	Silvery metal A6#

Remarks:

- (1) 1 mg/kg = 1 ppm = 0.0001%
- (2) MDL = Method Detection Limit
- (3) ND = Not Detected (< MDL)
- (4) "-" = Not Regulated

Halogen

Test Method: With reference to EN 14582:2016, analysis was performed by IC.

Test Item(s)	Unit(s)	MDL	A1	A2	A3
Fluorine(F)	mg/kg	20	ND	ND	ND
Chlorine(Cl)	mg/kg	50	ND	ND	70
Bromine(Br)	mg/kg	50	ND	ND	ND
Iodine(I)	mg/kg	50	ND	ND	ND

Test Item(s)	Unit(s)	MDL	A4	A5	A6
Fluorine(F)	mg/kg	20	ND	ND	ND
Chlorine(Cl)	mg/kg	50	130	ND	ND
Bromine(Br)	mg/kg	50	ND	ND	ND
Iodine(I)	mg/kg	50	ND	ND	ND

Unless otherwise stated, the decision rule for conformity reporting is based on Binary Statement for Simple Acceptance Rule (w=0) stated in ILAC-G8:09/2019.



Unless otherwise agreed in writing, this document is issued by the Company subject to its General Conditions of Service printed overleaf, available on request or accessible at <http://www.sgs.com/en/Terms-and-Conditions.aspx> and, for electronic format documents, subject to Terms and Conditions for Electronic Documents at <http://www.sgs.com/en/Terms-and-Conditions/Terms-e-Documents.aspx>. Attention is drawn to the limitation of liability, indemnification and jurisdiction issues defined therein. Any holder of this document is advised that information contained hereon reflects the Company's findings at the time of its intervention only and within the limits of Client's instructions, if any. The Company's sole responsibility is to its Client and this document does not exonerate parties to a transaction from exercising all their rights and obligations under the transaction documents. This document cannot be reproduced except in full, without prior written approval of the Company. Any unauthorized alteration, forgery or falsification of the content or appearance of this document is unlawful and offenders may be prosecuted to the fullest extent of the law. Unless otherwise stated the results shown in this test report refer only to the sample(s) tested.

Attention: To check the authenticity of testing /inspection report & certificate, please contact us at telephone: (86-755) 8307 1443, or email: CN.Doccheck@sgs.com

SGS-CSTC Standards Technical Services Co., Ltd.
Shenzhen Branch Testing Center Chemical Laboratory

Room 101-901, Plant 4 & Room 101, Plant 2 & Room 101, Plant 3 & Room 301-501, Plant 3, Jianghao (Bantian) Industrial Plant Area, No. 430, Jihua Road, Bantian Community, Bantian Street, Longgang District, Shenzhen, Guangdong, China 518129 www.sgs.com.cn
中国·广东·深圳市龙岗区坂田街道坂田社区吉华路430号江灏(坂田)工业区厂房4号101-901、2号101、3号101、3号301-501 邮编:518129 t:(86-755) 25328888 sgs.china@sgs.com

Halogen Testing Flow Chart

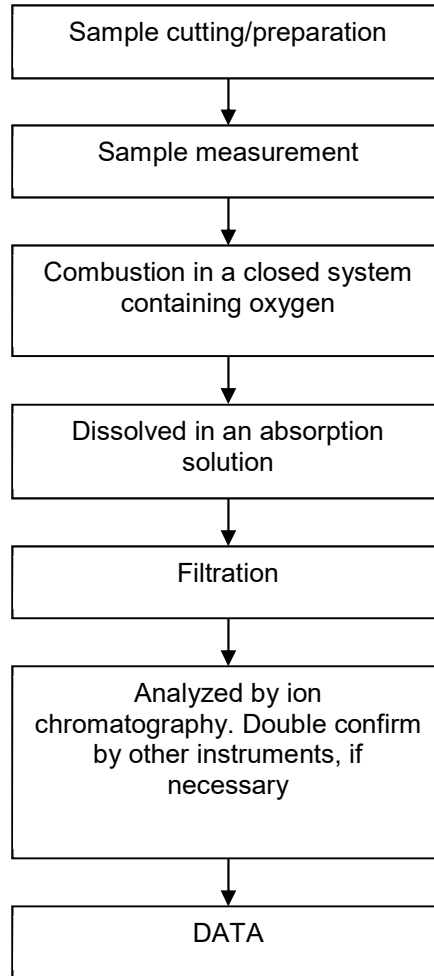

Unless otherwise agreed in writing, this document is issued by the Company subject to its General Conditions of Service printed overleaf, available on request or accessible at <http://www.sgs.com/en/Terms-and-Conditions.aspx> and, for electronic format documents, subject to Terms and Conditions for Electronic Documents at <http://www.sgs.com/en/Terms-and-Conditions/Terms-e-Documents.aspx>. Attention is drawn to the limitation of liability, indemnification and jurisdiction issues defined therein. Any holder of this document is advised that information contained hereon reflects the Company's findings at the time of its intervention only and within the limits of Client's instructions, if any. The Company's sole responsibility is to its Client and this document does not exonerate parties to a transaction from exercising all their rights and obligations under the transaction documents. This document cannot be reproduced except in full, without prior written approval of the Company. Any unauthorized alteration, forgery or falsification of the content or appearance of this document is unlawful and offenders may be prosecuted to the fullest extent of the law. Unless otherwise stated the results shown in this test report refer only to the sample(s) tested.

Attention: To check the authenticity of testing /inspection report & certificate, please contact us at telephone: (86-755) 8307 1443, or email: CN.Doccheck@sgs.com

Test Report

No.: SZXEC23000888003

Date: Jun 13, 2023

Page 4 of 6

Sample Photo:

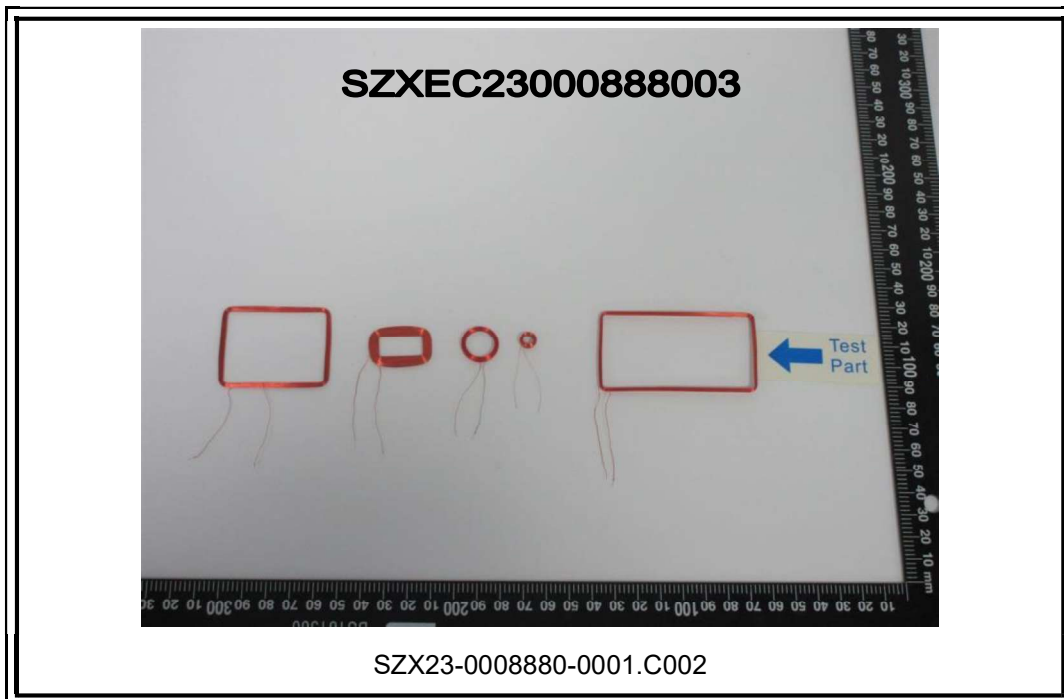

Unless otherwise agreed in writing, this document is issued by the Company subject to its General Conditions of Service printed overleaf, available on request or accessible at <http://www.sgs.com/en/Terms-and-Conditions.aspx> and, for electronic format documents, subject to Terms and Conditions for Electronic Documents at <http://www.sgs.com/en/Terms-and-Conditions/Terms-e-Documents.aspx>. Attention is drawn to the limitation of liability, indemnification and jurisdiction issues defined therein. Any holder of this document is advised that information contained hereon reflects the Company's findings at the time of its intervention only and within the limits of Client's instructions, if any. The Company's sole responsibility is to its Client and this document does not exonerate parties to a transaction from exercising all their rights and obligations under the transaction documents. This document cannot be reproduced except in full, without prior written approval of the Company. Any unauthorized alteration, forgery or falsification of the content or appearance of this document is unlawful and offenders may be prosecuted to the fullest extent of the law. Unless otherwise stated the results shown in this test report refer only to the sample(s) tested.

Attention: To check the authenticity of testing /inspection report & certificate, please contact us at telephone: (86-755) 8307 1443, or email: CN.Doccheck@sgs.com

SGS-CSTC Standards Technical Services Co., Ltd.
Shenzhen Branch Testing Center Chemical Laboratory

Room 101-901, Plant 4 & Room 101, Plant 2 & Room 101, Plant 3 & Room 301-901, Plant 3, Jianghao (Bantian) Industrial Plant Area, No. 430, Jihua Road, Bantian Community, Bantian Street, Longgang District, Shenzhen, Guangdong, China 518129 www.sgs.com
中国·广东·深圳市龙岗区坂田街道坂田社区吉华路430号江灏(坂田)工业厂区厂房4号101-901、2号101、3号301-501 邮编:518129 t:(86-755) 25328888 sgs.china@sgs.com



Unless otherwise agreed in writing, this document is issued by the Company subject to its General Conditions of Service printed overleaf, available on request or accessible at <http://www.sgs.com/en/Terms-and-Conditions.aspx> and, for electronic format documents, subject to Terms and Conditions for Electronic Documents at <http://www.sgs.com/en/Terms-and-Conditions/Terms-e-Documents.aspx>. Attention is drawn to the limitation of liability, indemnification and jurisdiction issues defined therein. Any holder of this document is advised that information contained hereon reflects the Company's findings at the time of its intervention only and within the limits of Client's instructions, if any. The Company's sole responsibility is to its Client and this document does not exonerate parties to a transaction from exercising all their rights and obligations under the transaction documents. This document cannot be reproduced except in full, without prior written approval of the Company. Any unauthorized alteration, forgery or falsification of the content or appearance of this document is unlawful and offenders may be prosecuted to the fullest extent of the law. Unless otherwise stated the results shown in this test report refer only to the sample(s) tested.

Attention: To check the authenticity of testing /inspection report & certificate, please contact us at telephone: (86-755) 8307 1443, or email: CN.Doccheck@sgs.com



SGS authenticate the photo on original report only

*** End of Report ***



SGS-CSTC Standards Technical Services Co., Ltd.
Shenzhen Branch Testing Center Chemical Laboratory

Unless otherwise agreed in writing, this document is issued by the Company subject to its General Conditions of Service printed overleaf, available on request or accessible at <http://www.sgs.com/en/Terms-and-Conditions.aspx> and, for electronic format documents, subject to Terms and Conditions for Electronic Documents at <http://www.sgs.com/en/Terms-and-Conditions/Terms-e-Document.aspx>. Attention is drawn to the limitation of liability, Indemnification and Jurisdiction issues defined therein. Any holder of this document is advised that information contained hereon reflects the Company's findings at the time of its intervention only and within the limits of Client's instructions, if any. The Company's sole responsibility is to its Client and this document does not exonerate parties to a transaction from exercising all their rights and obligations under the transaction documents. This document cannot be reproduced except in full, without prior written approval of the Company. Any unauthorized alteration, forgery or falsification of the content or appearance of this document is unlawful and offenders may be prosecuted to the fullest extent of the law. Unless otherwise stated the results shown in this test report refer only to the sample(s) tested.

Attention: To check the authenticity of testing /inspection report & certificate, please contact us at telephone: (86-755) 8307 1443, or email: CN.Doccheck@sgs.com

Room 101-901, Plant 4 & Room 101, Plant 2 & Room 101, Plant 3 & Room 301-501, Plant 3, Jianghao (Bantian) Industrial Plant Area, No. 430, Jihua Road, Bantian Community, Bantian Street, Longgang District, Shenzhen, Guangdong, China 518129 www.sgs.com
中国·广东·深圳市龙岗区坂田街道坂田社区吉华路430号江灏(坂田)工业区厂房4号101-901、2号101、3号101、3号301-501 邮编:518129 t:(86-755) 25328888 sgs.china@sgs.com

检测报告

编号: SZXEC23000888004

日期: 2023年06月13日

第1页, 共6页

客户名称: 东莞市泛亚电子有限公司
客户地址: 广东省东莞市石碣镇科技东路194号

样品名称: 线圈
以上样品及信息由客户提供。

SGS 工作编号: SZP23-001370
样品接收时间: 2023年05月15日
检测周期: 2023年05月15日~2023年05月24日
检测要求: 根据客户要求检测
检测方法: 见后续页。
检测结果: 见后续页。

检测要求	结论
卤素	见检测结果

通标标准技术服务有限公司深圳分公司
授权签名

范萍

Tina Fan 范萍
批准签署人

scan to see the report



A0813539

Unless otherwise agreed in writing, this document is issued by the Company subject to its General Conditions of Service printed overleaf, available on request or accessible at <http://www.sgs.com/en/Terms-and-Conditions.aspx> and, for electronic format documents, subject to Terms and Conditions for Electronic Documents at <http://www.sgs.com/en/Terms-and-Conditions/Terms-e-Documents.aspx>. Attention is drawn to the limitation of liability, indemnification and jurisdiction issues defined therein. Any holder of this document is advised that information contained hereon reflects the Company's findings at the time of its intervention only and within the limits of Client's instructions, if any. The Company's sole responsibility is to its Client and this document does not exonerate parties to a transaction from exercising all their rights and obligations under the transaction documents. This document cannot be reproduced except in full, without prior written approval of the Company. Any unauthorized alteration, forgery or falsification of the content or appearance of this document is unlawful and offenders may be prosecuted to the fullest extent of the law. Unless otherwise stated the results shown in this test report refer only to the sample(s) tested.

Attention: To check the authenticity of testing / inspection report & certificate, please contact us at telephone: (86-755) 8307 1443, or email: CN.Doccheck@sgs.com

Room 101-901, Plant 4 & Room 101, Plant 2 & Room 101, Plant 3 & Room 301-501, Plant 3, Jianghao (Bantian) Industrial Plant Area, No. 430, Jihua Road, Bantian Community, Bantian Street, Longgang District, Shenzhen, Guangdong, China 518129 www.sgs.com
中国·广东·深圳市龙岗区坂田街道坂田社区吉华路430号江豪(坂田)工业区厂房4号101-901、2号101、3号101、3号301-501 邮编:518129 t:(86-755)25328888 sgs.china@sgs.com



检测结果:

检测部件外观描述:

样品序号	样品编号	SGS 样品 ID	样品描述
SN1	A1	SZX23-0008880-0001.C001	带无色透明表层的铜色金属线 A1#
SN2	A2	SZX23-0008880-0001.C002	带红色表层的银色金属线 A2#
SN3	A3	SZX23-0008880-0001.C003	白色材料 A3#
SN4	A4	SZX23-0008880-0001.C004	白色材料 A4#
SN5	A5	SZX23-0008880-0001.C005	深灰色磁芯 A5#
SN6	A6	SZX23-0008880-0001.C006	银色金属 A6#

备注:

- (1) 1 mg/kg = 1 ppm = 0.0001%
- (2) MDL= 方法检测限
- (3) ND = 未检出 (< MDL)
- (4) "-" = 未规定

卤素

检测方法: 参考 EN 14582:2016, 采用 IC 进行分析。

检测项目	单位	MDL	A1	A2	A3
氟 (F)	mg/kg	20	ND	ND	ND
氯 (Cl)	mg/kg	50	ND	ND	70
溴 (Br)	mg/kg	50	ND	ND	ND
碘 (I)	mg/kg	50	ND	ND	ND

检测项目	单位	MDL	A4	A5	A6
氟 (F)	mg/kg	20	ND	ND	ND
氯 (Cl)	mg/kg	50	130	ND	ND
溴 (Br)	mg/kg	50	ND	ND	ND
碘 (I)	mg/kg	50	ND	ND	ND

除非另有说明, 参照 ILAC-G8:09/2019, 使用简单接受 (w=0) 的二元判定规则进行符合性判定。

除非另有说明, 此报告结果仅对检测的样品负责。本报告未经本公司书面许可, 不可部分复制。

检测报告仅用于客户科研、教学、内部质量控制、产品研发等目的, 仅供内部参考。



SGS-CTC Standards Technical Services Co., Ltd.
Shenzhen Branch Testing Center-Chemical Laboratory

Unless otherwise agreed in writing, this document is issued by the Company subject to its General Conditions of Service printed overleaf, available on request or accessible at <http://www.sgs.com/en/Terms-and-Conditions.aspx> and, for electronic format documents, subject to Terms and Conditions for Electronic Documents at <http://www.sgs.com/en/Terms-and-Conditions/Terms-e-Documents.aspx>. Attention is drawn to the limitation of liability, indemnification and jurisdiction issues defined therein. Any holder of this document is advised that information contained hereon reflects the Company's findings at the time of its intervention only and within the limits of Client's instructions, if any. The Company's sole responsibility is to its Client and this document does not exonerate parties to a transaction from exercising all their rights and obligations under the transaction documents. This document cannot be reproduced except in full, without prior written approval of the Company. Any unauthorized alteration, forgery or falsification of the content or appearance of this document is unlawful and offenders may be prosecuted to the fullest extent of the law. Unless otherwise stated the results shown in this test report refer only to the sample(s) tested.

Attention: To check the authenticity of testing /inspection report & certificate, please contact us at telephone: (86-755) 8307 1443, or email: CN.Doccheck@sgs.com

Room 101-901, Plant 4 & Room 101, Plant 2 & Room 101, Plant 3 & Room 301-501, Plant 3, Jianghao (Bantian) Industrial Plant Area, No. 430, Jihua Road, Bantian Community, Bantian Street, Longgang District, Shenzhen, Guangdong, China 518129 www.sgs.com.cn
中国·广东·深圳市龙岗区坂田街道坂田社区吉华路430号江灏(坂田)工业厂区厂房4号101-901、2号101、3号101、3号301-501 邮编:518129 t:(86-755) 25328888 sgs.china@sgs.com

卤素检测流程图

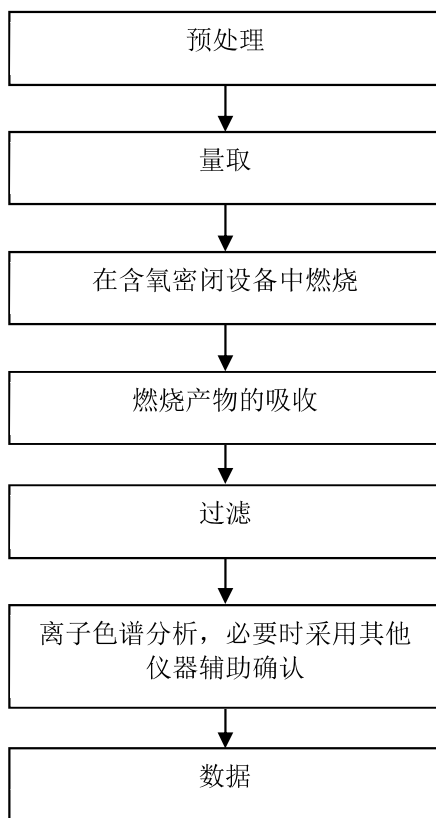

检测报告

编号: SZXEC23000888004

日期: 2023年06月13日

第4页, 共6页

样品照片:

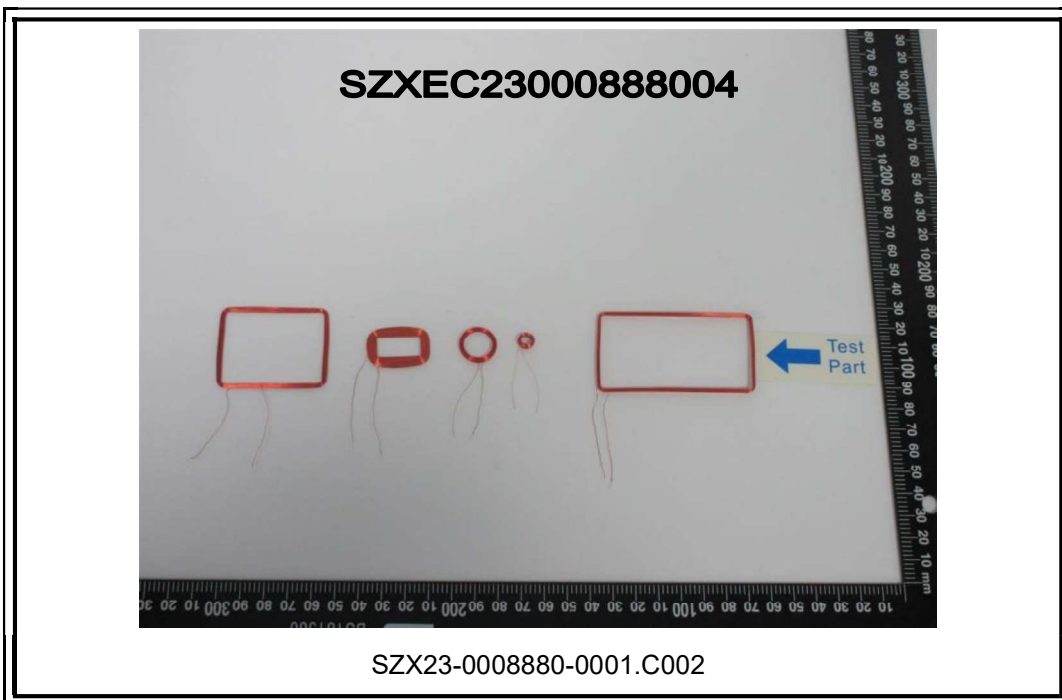

Unless otherwise agreed in writing, this document is issued by the Company subject to its General Conditions of Service printed overleaf, available on request or accessible at <http://www.sgs.com/en/Terms-and-Conditions.aspx> and, for electronic format documents, subject to Terms and Conditions for Electronic Documents at <http://www.sgs.com/en/Terms-and-Conditions/Terms-e-Documents.aspx>. Attention is drawn to the limitation of liability, indemnification and jurisdiction issues defined therein. Any holder of this document is advised that information contained hereon reflects the Company's findings at the time of its intervention only and within the limits of Client's instructions, if any. The Company's sole responsibility is to its Client and this document does not exonerate parties to a transaction from exercising all their rights and obligations under the transaction documents. This document cannot be reproduced except in full, without prior written approval of the Company. Any unauthorized alteration, forgery or falsification of the content or appearance of this document is unlawful and offenders may be prosecuted to the fullest extent of the law. Unless otherwise stated the results shown in this test report refer only to the sample(s) tested.

Attention: To check the authenticity of testing /inspection report & certificate, please contact us at telephone: (86-755) 8307 1443, or email: CN.Doccheck@sgs.com

SGS-CSTC Standards Technical Services Co., Ltd.
Shenzhen Branch Testing Center-Chemical Laboratory

Room 101-901, Plant 4 & Room 101, Plant 2 & Room 101, Plant 3 & Room 301-501, Plant 3, Jiangheo (Bantian) Industrial Plant Area, No. 430, Jihua Road, Bantian Community, Bantian Street, Longgang District, Shenzhen, Guangdong, China 518129 www.sgs.com
中国·广东·深圳市龙岗区坂田街道坂田社区吉华路430号江源(坂田)工业区厂房4号101-901、2号101、3号301-501 邮编:518129 t:(86-755) 25328888 sgs.china@sgs.com



Unless otherwise agreed in writing, this document is issued by the Company subject to its General Conditions of Service printed overleaf, available on request or accessible at <http://www.sgs.com/en/Terms-and-Conditions.aspx> and, for electronic format documents, subject to Terms and Conditions for Electronic Documents at <http://www.sgs.com/en/Terms-and-Conditions/Terms-e-Documents.aspx>. Attention is drawn to the limitation of liability, indemnification and jurisdiction issues defined therein. Any holder of this document is advised that information contained hereon reflects the Company's findings at the time of its intervention only and within the limits of Client's instructions, if any. The Company's sole responsibility is to its Client and this document does not exonerate parties to a transaction from exercising all their rights and obligations under the transaction documents. This document cannot be reproduced except in full, without prior written approval of the Company. Any unauthorized alteration, forgery or falsification of the content or appearance of this document is unlawful and offenders may be prosecuted to the fullest extent of the law. Unless otherwise stated the results shown in this test report refer only to the sample(s) tested.

Attention: To check the authenticity of testing /inspection report & certificate, please contact us at telephone: (86-755) 8307 1443, or email: CN.Doccheck@sgs.com

SGS-CSTC Standards Technical Services Co., Ltd.
Shenzhen Branch Testing Center-Chemical Laboratory

Room 101-901, Plant 4 & Room 101, Plant 2 & Room 101, Plant 3 & Room 301-501, Plant 3, Jianghao (Bantian) Industrial Plant Area, No. 430, Jihua Road, Bantian Community, Bantian Street, Longgang District, Shenzhen, Guangdong, China 518129 www.sgs.com.cn
中国·广东·深圳市龙岗区坂田街道坂田社区吉华路430号江灏(坂田)工业区厂房4号101-901、2号101、3号301-501 邮编:518129 t:(86-755) 25328888 sgs.china@sgs.com



此照片仅限于随 SGS 正本报告使用

报告结束



Unless otherwise agreed in writing, this document is issued by the Company subject to its General Conditions of Service printed overleaf, available on request or accessible at <http://www.sgs.com/en/Terms-and-Conditions.aspx> and, for electronic format documents, subject to Terms and Conditions for Electronic Documents at <http://www.sgs.com/en/Terms-and-Conditions/Terms-e-Documents.aspx>. Attention is drawn to the limitation of liability, indemnification and jurisdiction issues defined therein. Any holder of this document is advised that information contained hereon reflects the Company's findings at the time of its intervention only and within the limits of Client's instructions, if any. The Company's sole responsibility is to its Client and this document does not exonerate parties to a transaction from exercising all their rights and obligations under the transaction documents. This document cannot be reproduced except in full, without prior written approval of the Company. Any unauthorized alteration, forgery or falsification of the content or appearance of this document is unlawful and offenders may be prosecuted to the fullest extent of the law. Unless otherwise stated the results shown in this test report refer only to the sample(s) tested.

Attention: To check the authenticity of testing /inspection report & certificate, please contact us at telephone: (86-755) 8307 1443, or email: CN.Doccheck@sgs.com

SGS-CSTC Standards Technical Services Co., Ltd.
Shenzhen Branch Testing Center Chemical Laboratory

Room 101-901, Plant 4 & Room 101, Plant 2 & Room 101, Plant 3 & Room 301-501, Plant 3, Jianghao (Bantian) Industrial Plant Area, No. 430, Jihua Road, Bantian Community, Bantian Street, Longgang District, Shenzhen, Guangdong, China 518129 www.sgs.com
中国·广东·深圳市龙岗区坂田街道坂田社区吉华路430号江灏(坂田)工业厂区厂房4号101-901、2号101、3号101、3号301-501 邮编:518129 t:(86-755) 25328888 sgs.china@sgs.com

Test Report (SVHC)

No.: SZXEC23000888005

Date: Jun 13, 2023

Page 1 of 14

Client Name: DONGGUAN FINE ELECTRONICS LIMITED

Client Address: 194 KEJI EAST ROAD, SHIJIE TOWN, DONGGUAN CITY, GUANGDONG PROVINCE

Sample Name: Coil

The above sample(s) and information were provided by the client.

SGS Job No.: SZP23-001370

Sample Receiving Date: May 15, 2023

Testing Period: May 15, 2023 ~ May 24, 2023

Test Requested: As requested by client, SVHC screening is performed according to:
 (i) Two hundred and thirty-three (233) substances in the Candidate List of Substances of Very High Concern (SVHC) for authorization published by European Chemicals Agency (ECHA) on and before Jan 17, 2023 regarding Regulation (EC) No 1907/2006 concerning the REACH.
 (ii) One (1) potential Substances of Very High Concern (SVHC) in the notification of WTO on Jun 1, 2021.
 (iii) Two (2) substances in the Public Consultation List of potential Substances of Very High Concern (SVHC) published by European Chemicals Agency (ECHA) on and before Feb 17, 2023 regarding Regulation (EC) No 1907/2006 concerning the REACH.

Test Method(s): Please refer to next page(s).

Test Result(s): Please refer to next page(s).

Summary:

According to the specified scope and evaluation screening, the test results of SVHC are $\leq 0.1\%$ (w/w) in the submitted sample.	Pass
---	------

Signed for and on behalf of
 SGS-CSTC Standards Technical Services Co., Ltd. Shenzhen Branch

Tina Fan
 Approved Signatory

scan to see the report



C9FAC476



SGS-CSTC Standards Technical Services Co., Ltd.
 Shenzhen Branch Testing Center Chemical Laboratory

Unless otherwise agreed in writing, this document is issued by the Company subject to its General Conditions of Service printed overleaf, available on request or accessible at <http://www.sgs.com/en/Terms-and-Conditions.aspx> and, for electronic format documents, subject to Terms and Conditions for Electronic Documents at <http://www.sgs.com/en/Terms-and-Conditions/Terms-e-Documents.aspx>. Attention is drawn to the limitation of liability, indemnification and jurisdiction issues defined therein. Any holder of this document is advised that information contained hereon reflects the Company's findings at the time of its intervention only and within the limits of Client's instructions, if any. The Company's sole responsibility is to its Client and this document does not exonerate parties to a transaction from exercising all their rights and obligations under the transaction documents. This document cannot be reproduced except in full, without prior written approval of the Company. Any unauthorized alteration, forgery or falsification of the content or appearance of this document is unlawful and offenders may be prosecuted to the fullest extent of the law. Unless otherwise stated the results shown in this test report refer only to the sample(s) tested.

Attention: To check the authenticity of testing /inspection report & certificate, please contact us at telephone: (86-755) 8307 1443, or email: CN.Doccheck@sgs.com

Room 101-901, Plant 4 & Room 101, Plant 2 & Room 101, Plant 3 & Room 301-501, Plant 3, Jianghao (Bantian) Industrial Plant Area, No. 430, Jihua Road, Bantian Community, Bantian Street, Longgang District, Shenzhen, Guangdong, China 518129 www.sgs.com
 中国·广东·深圳市龙岗区坂田街道坂田社区吉华路430号江豪(坂田)工业厂区厂房4号101-901、2号101、3号101、3号301-501 邮编:518129 t:(86-755) 25328888 sgs.china@sgs.com

Test Report (SVHC)

No.: SZXEC23000888005

Date: Jun 13, 2023

Page 2 of 14

Remark :

1. The chemical analysis of specified SVHC is performed by means of currently available analytical techniques against the following SVHC related documents published by ECHA:
<http://echa.europa.eu/web/guest/candidate-list-table>
 These lists are under evaluation by ECHA and may subject to change in the future.

2. REACH obligation:

- 2.1 Concerning article(s):

- Communication:

- Article 33 of Regulation (EC) No 1907/2006 requires supplier of an article containing a substance meeting the criteria in Article 57 and identified in accordance with Article 59(1) in a concentration above 0.1% weight by weight (w/w) shall provide the recipient of the article with sufficient information, available to the supplier, to allow safe use of the article including, as a minimum, the name of that substance in the Candidate List.

- Notification:

- In accordance with Regulation (EC) No 1907/2006, any EU producer or importer of articles shall notify ECHA, in accordance with paragraph 4 of Article 7, if a substance meets the criteria in Article 57 and is identified in accordance with Article 59(1) of the Regulation, if (a) the substance in the Candidate List is present in those articles in quantities totaling over one tonne per producer or importer per year; and (b) the substance in the Candidate List is present in those articles above a concentration of 0.1% weight by weight (w/w).

SGS adopts the ruling of the Court of Justice of the European Union on the definition of an article under REACH unless indicated otherwise. Detail explanation is available at the following link:
<http://www.sgs.com/-/media/global/documents/technical-documents/technical-bulletins/sgs-crs-position-statement-on-svhc-in-articles-a4-en-16-06.pdf?la=en>

- 2.2 Concerning material(s):

- Test results in this report are based on the tested sample. This report refers to testing result of tested sample submitted as homogenous material(s). In case such material is being used to compose an article, the results indicated in this report may not represent SVHC concentration in such article. If this report refers to testing result of composite material group by equal weight proportion, the material in each composite test group may come from more than one article.

If the sample is a substance or mixture, and it directly exports to EU, client has the obligation to comply with the supply chain communication obligation under Article 31 of Regulation (EC) No. 1907/2006 and the conditions of Authorization of substance of very high concern included in the Annex XIV of the Regulation (EC) No. 1907/2006.

- 2.3 Concerning substance and preparation:

- If a SVHC is found over 0.1% (w/w) and/or the specific concentration limit which is set in Regulation (EC) No 1272/2008 and its amendments, client is suggested to prepare a Safety Data Sheet (SDS) against the SVHC to comply with the supply chain communication obligation under Regulation (EC) No 1907/2006, in which:

- a substance that is classified as hazardous under the CLP Regulation (EC) No 1272/2008.
 - a mixture that is classified as hazardous under the CLP Regulation (EC) No 1272/2008, when it contains a substance with concentration equal to, or greater than the classification limit as set in Regulation (EC) No. 1272/2008; or
 - a mixture is not classified as hazardous under the CLP Regulation (EC) No 1272/2008, but contains either:



SGS-CTS Standards Technical Services Co., Ltd.
 Shenzhen Branch Testing Center Chemical Laboratory

Unless otherwise agreed in writing, this document is issued by the Company subject to its General Conditions of Service printed overleaf, available on request or accessible at <http://www.sgs.com/en/Terms-and-Conditions.aspx> and, for electronic format documents, subject to Terms and Conditions for Electronic Documents at <http://www.sgs.com/en/Terms-and-Conditions/Terms-e-Documents.aspx>. Attention is drawn to the limitation of liability, indemnification and jurisdiction issues defined therein. Any holder of this document is advised that information contained hereon reflects the Company's findings at the time of its intervention only and within the limits of Client's instructions, if any. The Company's sole responsibility is to its Client and this document does not exonerate parties to a transaction from exercising all their rights and obligations under the transaction documents. This document cannot be reproduced except in full, without prior written approval of the Company. Any unauthorized alteration, forgery or falsification of the content or appearance of this document is unlawful and offenders may be prosecuted to the fullest extent of the law. Unless otherwise stated the results shown in this test report refer only to the sample(s) tested.

Attention: To check the authenticity of testing /inspection report & certificate, please contact us at telephone: (86-755) 8307 1443, or email: CN.Doccheck@sgs.com

Room 101-901, Plant 4 & Room 101, Plant 2 & Room 101, Plant 3 & Room 301-501, Plant 3, Jianghao (Bantian) Industrial Plant Area, No. 430, Jihua Road, Bantian Community, Bantian Street, Longgang District, Shenzhen, Guangdong, China 518129 www.sgs.com
 中国·广东·深圳市龙岗区坂田街道坂田社区吉华路430号江豪(坂田)工业区厂房4号101-901、2号101、3号101、3号301-501 邮编:518129 t:(86-755) 25328888 sgs.china@sgs.com

**Test Report
(SVHC)**

No.: SZXEC23000888005

Date: Jun 13, 2023

Page 3 of 14

- (a) a substance posing human health or environmental hazards in an individual concentration of $\geq 1\%$ by weight for mixtures that are solid or liquids (i.e., non-gaseous mixtures) or $\geq 0.2\%$ by volume for gaseous mixtures; or
- (b) a substance that is PBT, or vPvB in an individual concentration of $\geq 0.1\%$ by weight for mixtures that are solid or liquids (i.e., non-gaseous mixtures); or
- (c) a substance on the SVHC candidate list (for reasons other than those listed above), in an individual concentration of $\geq 0.1\%$ by weight for non-gaseous mixtures; or
- (d) a substance for which there are Europe-wide workplace exposure limits

3. If a SVHC is found over the reporting limit, client is suggested to identify the composite component which contains the SVHC and the exact concentration of the SVHC by requesting further quantitative analysis from the laboratory.

Test Sample:

Testing Group:

Test Result ID	Description	Test Part ID	SGS Sample ID
001	Copper-colored metal wire with colorless transparent surface A#+Silvery metal wire with red surface B#+White material C#+White material D#+Dark grey core E#	A7	SZX23-0008880-0001.C007

Test Method:

With reference to SGS In-House method, analysis was performed by ICP-OES, UV-VIS, GC-MS, HPLC-DAD/MS and Colorimetric Method.



Unless otherwise agreed in writing, this document is issued by the Company subject to its General Conditions of Service printed overleaf, available on request or accessible at <http://www.sgs.com/en/Terms-and-Conditions.aspx> and, for electronic format documents, subject to Terms and Conditions for Electronic Documents at <http://www.sgs.com/en/Terms-and-Conditions/Terms-e-Documents.aspx>. Attention is drawn to the limitation of liability, indemnification and jurisdiction issues defined therein. Any holder of this document is advised that information contained hereon reflects the Company's findings at the time of its intervention only and within the limits of Client's instructions, if any. The Company's sole responsibility is to its Client and this document does not exonerate parties to a transaction from exercising all their rights and obligations under the transaction documents. This document cannot be reproduced except in full, without prior written approval of the Company. Any unauthorized alteration, forgery or falsification of the content or appearance of this document is unlawful and offenders may be prosecuted to the fullest extent of the law. Unless otherwise stated the results shown in this test report refer only to the sample(s) tested.

Attention: To check the authenticity of testing /inspection report & certificate, please contact us at telephone: (86-755) 8307 1443, or email: CN.Doccheck@sgs.com

SGS CSTC Standards Technical Services Co., Ltd.
Shenzhen Branch Testing Center Chemical Laboratory

Room 101-901, Plant 4 & Room 101, Plant 2 & Room 101, Plant 3 & Room 301-501, Plant 3, Jianghao (Bantian) Industrial Plant Area, No. 430, Jihua Road, Bantian Community, Bantian Street, Longgang District, Shenzhen, Guangdong, China 518129 www.sgs.com
中国·广东·深圳市龙岗区坂田街道坂田社区吉华路430号江灏(坂田)工业厂区厂房4号101-901、2号101、3号301-501 邮编:518129 t:(86-755) 25328888 sgs.china@sgs.com

**Test Report
(SVHC)**

No.: SZXEC23000888005

Date: Jun 13, 2023

Page 4 of 14

Test Results: (Substances in the Candidate List of SVHC)

Batch	Substance Name	CAS No.	001 Concentration (%)	RL (%)
-	All tested SVHC in Candidate list	-	ND	-

Test Results: (Potential SVHC)

Batch	Substance Name	CAS No.	001 Concentration (%)	RL (%)
/	All tested Potential SVHC	-	ND	-

Notes:

- (1) The table above only shows detected SVHC, and SVHC that below RL are not reported. Please refer to Appendix for the full list of tested SVHC.
- (2) RL = Reporting Limit (Test data will be shown if it ≥ RL. RL is not regulatory limit.)
ND = Not detected (lower than RL), ND is denoted on the SVHC substance.
- (3) * The test result is based on the calculation of selected element(s) and to the worst-case scenario.
** The test result is based on the calculation of selected marker(s) and to the worst-case scenario.
Calculated concentration of boric compounds are based on water extractive boron detected by ICP-OES.
Calculated concentration of Barium diboron tetraoxide is based on water extractive boron and barium detected by ICP-OES.
RL = 0.005% is evaluated for element (i.e. cobalt, arsenic, lead, chromium (VI), aluminum, zirconium, boron, strontium, zinc, antimony, titanium, barium, cadmium respectively), except molybdenum
RL=0.0005%, boron RL=0.0025% (only for Lead bis(tetrafluoroborate)), fluorine RL=0.050%.
- (4) § The substance is proposed for the identification as SVHC only where it contains Michler's ketone (CAS Number: 90-94-8) or Michler's base (CAS Number: 101-61-1) ≥0.1% (w/w).
- (5) / = Potential SVHC
- (6) Composite test has been performed in equal proportion for the components/material per client requested. And the result is calculated using the minimum sample weight.

Unless otherwise stated, the decision rule for conformity reporting is based on Binary Statement for Simple Acceptance Rule (w=0) stated in ILAC-G8:09/2019.



Unless otherwise agreed in writing, this document is issued by the Company subject to its General Conditions of Service printed overleaf, available on request or accessible at <http://www.sgs.com/en/Terms-and-Conditions.aspx> and, for electronic format documents, subject to Terms and Conditions for Electronic Documents at <http://www.sgs.com/en/Terms-and-Conditions/Terms-e-Documents.aspx>. Attention is drawn to the limitation of liability, indemnification and jurisdiction issues defined therein. Any holder of this document is advised that information contained hereon reflects the Company's findings at the time of its intervention only and within the limits of Client's instructions, if any. The Company's sole responsibility is to its Client and this document does not exonerate parties to a transaction from exercising all their rights and obligations under the transaction documents. This document cannot be reproduced except in full, without prior written approval of the Company. Any unauthorized alteration, forgery or falsification of the content or appearance of this document is unlawful and offenders may be prosecuted to the fullest extent of the law. Unless otherwise stated the results shown in this test report refer only to the sample(s) tested.

Attention: To check the authenticity of testing /inspection report & certificate, please contact us at telephone: (86-755) 8307 1443, or email: CN.Doccheck@sgs.com

SGS-CSTC Standards Technical Services Co., Ltd.
Shenzhen Branch Testing Center-Chemical Laboratory

Room 101-901, Plant 4 & Room 101, Plant 2 & Room 101, Plant 3 & Room 301-501, Plant 3, Jianghao (Bantian) Industrial Plant Area, No. 430, Jihua Road, Bantian Community, Bantian Street, Longgang District, Shenzhen, Guangdong, China 518129 www.sgs.com
中国·广东·深圳市龙岗区坂田街道坂田社区吉华路430号江灏(坂田)工业区厂房4号101-901、2号101、3号301-501 邮编:518129 t(86-755) 25328888 sgs.china@sgs.com

Test Report (SVHC)

No.: SZXEC23000888005

Date: Jun 13, 2023

Page 5 of 14

Appendix

Full list of tested SVHC:

Batch	No.	Substance Name	CAS No.	RL (%)
I	1	4,4'-Diaminodiphenylmethane(MDA)	101-77-9	0.050
I	2	5-tert-butyl-2,4,6-trinitro-m-xylene (musk xylene)	81-15-2	0.050
I	3	Alkanes, C10-13, chloro (Short Chain Chlorinated Paraffins)	85535-84-8	0.050
I	4	Anthracene	120-12-7	0.050
I	5	Benzyl butyl phthalate (BBP)	85-68-7	0.050
I	6	Bis(2-ethylhexyl)phthalate (DEHP)	117-81-7	0.050
I	7	Bis(tributyltin)oxide (TBTO)	56-35-9	0.050
I	8	Cobalt dichloride*	7646-79-9	0.005
I	9	Diarsenic pentaoxide*	1303-28-2	0.005
I	10	Diarsenic trioxide*	1327-53-3	0.005
I	11	Dibutyl phthalate (DBP)	84-74-2	0.050
I	12	Hexabromocyclododecane (HBCDD) and all major diastereoisomers identified (α -HBCDD, β -HBCDD, γ -HBCDD)	-	0.050
I	13	Lead hydrogen arsenate*	7784-40-9	0.005
I	14	Sodium dichromate*	10588-01-9 /7789-12-0	0.005
I	15	Triethyl arsenate*	15606-95-8	0.005
II	16	2,4-Dinitrotoluene	121-14-2	0.050
II	17	Acrylamide	79-06-1	0.050
II	18	Anthracene oil**	90640-80-5	0.050
II	19	Anthracene oil, anthracene paste**	90640-81-6	0.050
II	20	Anthracene oil, anthracene paste, anthracene fraction**	91995-15-2	0.050
II	21	Anthracene oil, anthracene paste, distn. Lights**	91995-17-4	0.050
II	22	Anthracene oil, anthracene-low**	90640-82-7	0.050
II	23	Diisobutyl phthalate	84-69-5	0.050
II	24	Lead chromate molybdate sulphate red (C.I. Pigment Red 104)*	12656-85-8	0.005
II	25	Lead chromate*	7758-97-6	0.005
II	26	Lead sulfochromate yellow (C.I. Pigment Yellow 34)*	1344-37-2	0.005
II	27	Pitch, coal tar, high temp. **	65996-93-2	0.050
II	28	Tris(2-chloroethyl)phosphate	115-96-8	0.050
III	29	Ammonium dichromate*	7789-09-5	0.005
III	30	Boric acid*	-	0.005
III	31	Disodium tetraborate, anhydrous*	12179-04-3 /1303-96-4 /1330-43-4	0.005
III	32	Potassium chromate*	7789-00-6	0.005
III	33	Potassium dichromate*	7778-50-9	0.005
III	34	Sodium chromate*	7775-11-3	0.005
III	35	Tetraboron disodium heptaoxide, hydrate*	12267-73-1	0.005



Unless otherwise agreed in writing, this document is issued by the Company subject to its General Conditions of Service printed overleaf, available on request or accessible at <http://www.sgs.com/en/Terms-and-Conditions.aspx> and, for electronic format documents, subject to Terms and Conditions for Electronic Documents at <http://www.sgs.com/en/Terms-and-Conditions/Terms-e-Documents.aspx>. Attention is drawn to the limitation of liability, indemnification and jurisdiction issues defined therein. Any holder of this document is advised that information contained hereon reflects the Company's findings at the time of its intervention only and within the limits of Client's instructions, if any. The Company's sole responsibility is to its Client and this document does not exonerate parties to a transaction from exercising all their rights and obligations under the transaction documents. This document cannot be reproduced except in full, without prior written approval of the Company. Any unauthorized alteration, forgery or falsification of the content or appearance of this document is unlawful and offenders may be prosecuted to the fullest extent of the law. Unless otherwise stated the results shown in this test report refer only to the sample(s) tested.

Attention: To check the authenticity of testing /inspection report & certificate, please contact us at telephone: (86-755) 8307 1443, or email: CN.Doccheck@sgs.com

SGS-CTC (Shenzhen) Technical Services Co., Ltd.
Shenzhen Branch Testing Center Chemical Laboratory

Room 101-901, Plant 4 & Room 101, Plant 2 & Room 101, Plant 3 & Room 301-501, Plant 3, Jianghao (Bantian) Industrial Plant Area, No. 430, Jihua Road, Bantian Community, Bantian Street, Longgang District, Shenzhen, Guangdong, China 518129 www.sgs.com
中国·广东·深圳市龙岗区坂田街道坂田社区吉华路430号江灏(坂田)工业区厂房4号101-901、2号101、3号101、3号301-501 邮编:518129 t:(86-755) 25328888 sgs.china@sgs.com

Test Report (SVHC)

No.: SZXEC23000888005

Date: Jun 13, 2023

Page 6 of 14

Batch	No.	Substance Name	CAS No.	RL (%)
III	36	Trichloroethylene	79-01-6	0.050
IV	37	2-Ethoxyethanol	110-80-5	0.050
IV	38	2-Methoxyethanol	109-86-4	0.050
IV	39	Chromic acid, Oligomers of chromic acid and dichromic acid, Dichromic acid*	-	0.005
IV	40	Chromium trioxide*	1333-82-0	0.005
IV	41	Cobalt(II) carbonate*	513-79-1	0.005
IV	42	Cobalt(II) diacetate*	71-48-7	0.005
IV	43	Cobalt(II) dinitrate*	10141-05-6	0.005
IV	44	Cobalt(II) sulphate*	10124-43-3	0.005
V	45	1,2,3-trichloropropane	96-18-4	0.050
V	46	1,2-Benzenedicarboxylic acid, di-C6-8-branched alkyl esters, C7-rich	71888-89-6	0.050
V	47	1,2-Benzenedicarboxylic acid, di-C7-11-branched and linear alkyl esters	68515-42-4	0.050
V	48	1-methyl-2-pyrrolidone	872-50-4	0.050
V	49	2-ethoxyethyl acetate	111-15-9	0.050
V	50	Hydrazine	302-01-2 /7803-57-8	0.050
V	51	strontium chromate*	7789-06-2	0.005
VI	52	1,2-Dichloroethane	107-06-2	0.050
VI	53	2,2'-dichloro-4,4'-methylenedianiline	101-14-4	0.050
VI	54	2-Methoxyaniline; o-Anisidine	90-04-0	0.050
VI	55	4-(1,1,3,3-tetramethylbutyl)phenol	140-66-9	0.050
VI	56	Aluminosilicate Refractory Ceramic Fibres*	-	0.005
VI	57	Arsenic acid*	7778-39-4	0.005
VI	58	Bis(2-methoxyethyl) ether	111-96-6	0.050
VI	59	Bis(2-methoxyethyl) phthalate	117-82-8	0.050
VI	60	Calcium arsenate*	7778-44-1	0.005
VI	61	Dichromium tris(chromate)*	24613-89-6	0.005
VI	62	Formaldehyde, oligomeric reaction products with aniline	25214-70-4	0.050
VI	63	Lead diazide, Lead azide*	13424-46-9	0.005
VI	64	Lead dipicrate*	6477-64-1	0.005
VI	65	Lead styphnate*	15245-44-0	0.005
VI	66	N,N-dimethylacetamide	127-19-5	0.050
VI	67	Pentazinc chromate octahydroxide*	49663-84-5	0.005
VI	68	Phenolphthalein	77-09-8	0.050
VI	69	Potassium hydroxyoctaoxodizincatedichromate*	11103-86-9	0.005
VI	70	Trilead diarsenate*	3687-31-8	0.005
VI	71	Zirconia Aluminosilicate Refractory Ceramic Fibres*	-	0.005
VII	72	[4-[[4-anilino-1-naphthyl][4-(dimethylamino)phenyl]methylene]cyclohexa-2,5-dien-1-ylidene] dimethylammonium chloride (C.I. Basic Blue 26)§	2580-56-5	0.050



SGS-CSTC Standards Technical Services Co., Ltd.
Shenzhen Branch Testing Center Chemical Laboratory

Unless otherwise agreed in writing, this document is issued by the Company subject to its General Conditions of Service printed overleaf, available on request or accessible at <http://www.sgs.com/en/Terms-and-Conditions.aspx> and, for electronic format documents, subject to Terms and Conditions for Electronic Documents at <http://www.sgs.com/en/Terms-and-Conditions/Terms-e-Document.aspx>. Attention is drawn to the limitation of liability, indemnification and jurisdiction issues defined therein. Any holder of this document is advised that information contained hereon reflects the Company's findings at the time of its intervention only and within the limits of Client's instructions, if any. The Company's sole responsibility is to its Client and this document does not exonerate parties to a transaction from exercising all their rights and obligations under the transaction documents. This document cannot be reproduced except in full, without prior written approval of the Company. Any unauthorized alteration, forgery or falsification of the content or appearance of this document is unlawful and offenders may be prosecuted to the fullest extent of the law. Unless otherwise stated the results shown in this test report refer only to the sample(s) tested.

Attention: To check the authenticity of testing /inspection report & certificate, please contact us at telephone: (86-755) 8307 1443, or email: CN.Doccheck@sgs.com

Room 101-901, Plant 4 & Room 101, Plant 2 & Room 101, Plant 3 & Room 301-501, Plant 3, Jiangqiao (Bantian) Industrial Plant Area, No. 430, Jihua Road, Bantian Community, Bantian Street, Longgang District, Shenzhen, Guangdong, China 518129 www.sgs.com.cn
中国·广东·深圳市龙岗区坂田街道坂田社区吉华路430号江桥(坂田)工业厂区4号101-901、2号101、3号101、3号301-501 邮编:518129 t(86-755) 25328888 sgs.china@sgs.com

Test Report (SVHC)

No.: SZXEC23000888005

Date: Jun 13, 2023

Page 7 of 14

Batch	No.	Substance Name	CAS No.	RL (%)
VII	73	[4-[4,4'-bis(dimethylamino) benzhydrylidene]cyclohexa-2,5-dien-1-ylidene]dimethylammonium chloride (C.I. Basic Violet 3) §	548-62-9	0.050
VII	74	1,2-bis(2-methoxyethoxy)ethane (TEGDME; triglyme)	112-49-2	0.050
VII	75	1,2-dimethoxyethane; ethylene glycol dimethyl ether (EGDME)	110-71-4	0.050
VII	76	4,4'-bis(dimethylamino) benzophenone (Michler's Ketone)	90-94-8	0.050
VII	77	4,4'-bis(dimethylamino)-4''-(methylamino)trityl alcohol§	561-41-1	0.050
VII	78	Diboron trioxide*	1303-86-2	0.005
VII	79	Formamide	75-12-7	0.050
VII	80	Lead(II) bis(methanesulfonate)*	17570-76-2	0.005
VII	81	N,N,N',N'-tetramethyl-4,4'-methylenedianiline (Michler's base)	101-61-1	0.050
VII	82	TGIC (1,3,5-tris(oxiranylmethyl)-1,3,5-triazine-2,4,6-(1H,3H,5H)-trione)	2451-62-9	0.050
VII	83	α,α-Bis[4-(dimethylamino)phenyl]-4 (phenylamino)naphthalene-1-methanol (C.I. Solvent Blue 4) §	6786-83-0	0.050
VII	84	β-TGIC (1,3,5-tris[(2S and 2R)-2,3-epoxypropyl]-1,3,5-triazine-2,4,6-(1H,3H,5H)-trione)	59653-74-6	0.050
VIII	85	[Phthalato(2-)]dioxotrilead*	69011-06-9	0.005
VIII	86	1,2-Benzenedicarboxylic acid, dipentylester, branched and linear	84777-06-0	0.050
VIII	87	1,2-Diethoxyethane	629-14-1	0.050
VIII	88	1-Bromopropane	106-94-5	0.050
VIII	89	3-Ethyl-2-methyl-2-(3-methylbutyl)-1,3-oxazolidine	143860-04-2	0.050
VIII	90	4-(1,1,3,3-tetramethylbutyl)phenol, ethoxylated	-	0.050
VIII	91	4,4'-Methylenedi-o-toluidine	838-88-0	0.050
VIII	92	4,4'-Oxydianiline and its salts	101-80-4	0.050
VIII	93	4-Aminoazobenzene	60-09-3	0.050
VIII	94	4-Methyl-m-phenylenediamine	95-80-7	0.050
VIII	95	4-Nonylphenol, branched and linear	-	0.050
VIII	96	6-Methoxy-m-toluidine	120-71-8	0.050
VIII	97	Acetic acid, lead salt, basic*	51404-69-4	0.005
VIII	98	Biphenyl-4-ylamine	92-67-1	0.050
VIII	99	Decabromodiphenyl ether (DecaBDE)	1163-19-5	0.050
VIII	100	Cyclohexane-1,2-dicarboxylic anhydride, cis-cyclohexane-1,2-dicarboxylic anhydride, trans-cyclohexane-1,2-dicarboxylic anhydride	-	0.050
VIII	101	Diazene-1,2-dicarboxamide (C,C'-azodi(formamide))	123-77-3	0.050



Unless otherwise agreed in writing, this document is issued by the Company subject to its General Conditions of Service printed overleaf, available on request or accessible at <http://www.sgs.com/en/Terms-and-Conditions.aspx> and, for electronic format documents, subject to Terms and Conditions for Electronic Documents at <http://www.sgs.com/en/Terms-and-Conditions/Terms-e-Documents.aspx>. Attention is drawn to the limitation of liability, indemnification and jurisdiction issues defined therein. Any holder of this document is advised that information contained hereon reflects the Company's findings at the time of its intervention only and within the limits of Client's instructions, if any. The Company's sole responsibility is to its Client and this document does not exonerate parties to a transaction from exercising all their rights and obligations under the transaction documents. This document cannot be reproduced except in full, without prior written approval of the Company. Any unauthorized alteration, forgery or falsification of the content or appearance of this document is unlawful and offenders may be prosecuted to the fullest extent of the law. Unless otherwise stated the results shown in this test report refer only to the sample(s) tested.

Attention: To check the authenticity of testing/inspection report & certificate, please contact us at telephone: (86-755) 8307 1443, or email: CN.Doccheck@sgs.com

SGS-CSTC Standards Technical Services Co., Ltd.
Inspection & Testing Services
Shenzhen Branch

Room 101-901, Plant 4 & Room 101, Plant 2 & Room 101, Plant 3 & Room 301-501, Plant 3, Jianghao (Bantian) Industrial Plant Area, No. 430, Jihua Road, Bantian Community, Bantian Street, Loogang District, Shenzhen, Guangdong, China 518129 www.sgs.com
中国·广东·深圳市龙岗区坂田街道坂田社区吉华路430号江灏(坂田)工业区厂房4号101-901、2号101、3号101、3号301-501 邮编:518129 t(86-755) 25328888 sgs.china@sgs.com

Test Report (SVHC)

No.: SZXEC23000888005

Date: Jun 13, 2023

Page 8 of 14

Batch	No.	Substance Name	CAS No.	RL (%)
VIII	102	Dibutyltin dichloride (DBTC)	683-18-1	0.050
VIII	103	Diethyl sulphate	64-67-5	0.050
VIII	104	Diisopentylphthalate	605-50-5	0.050
VIII	105	Dimethyl sulphate	77-78-1	0.050
VIII	106	Dinoseb	88-85-7	0.050
VIII	107	Dioxobis(stearato)trilead*	12578-12-0	0.005
VIII	108	Fatty acids, C16-18, lead salts*	91031-62-8	0.005
VIII	109	Furan	110-00-9	0.050
VIII	110	Henicosafuoroundecanoic acid	2058-94-8	0.050
VIII	111	Heptacosafuorotetradecanoic acid	376-06-7	0.050
VIII	112	Hexahydromethylphthalic anhydride, Hexahydro-4-methylphthalic anhydride, Hexahydro-1-methylphthalic anhydride, Hexahydro-3-methylphthalic anhydride	-	0.050
VIII	113	Lead bis(tetrafluoroborate)*	13814-96-5	0.005
VIII	114	Lead cyanamidate*	20837-86-9	0.005
VIII	115	Lead dinitrate*	10099-74-8	0.005
VIII	116	Lead monoxide*	1317-36-8	0.005
VIII	117	Lead oxide sulfate*	12036-76-9	0.005
VIII	118	Lead tetroxide (orange lead)*	1314-41-6	0.005
VIII	119	Lead titanium trioxide*	12060-00-3	0.005
VIII	120	Lead titanium zirconium oxide*	12626-81-2	0.005
VIII	121	Methoxyacetic acid	625-45-6	0.050
VIII	122	Methyloxirane (Propylene oxide)	75-56-9	0.050
VIII	123	N,N-Dimethylformamide	68-12-2	0.050
VIII	124	N-Methylacetamide	79-16-3	0.050
VIII	125	N-Pentyl-isopentylphthalate	776297-69-9	0.050
VIII	126	o-Aminoazotoluene	97-56-3	0.050
VIII	127	o-Toluidine	95-53-4	0.050
VIII	128	Pentacosafuorotridecanoic acid	72629-94-8	0.050
VIII	129	Pentalead tetraoxide sulphate*	12065-90-6	0.005
VIII	130	Pyrochlore, antimony lead yellow*	8012-00-8	0.005
VIII	131	Silicic acid, barium salt, lead-doped*	68784-75-8	0.005
VIII	132	Silicic acid, lead salt*	11120-22-2	0.005
VIII	133	Sulfurous acid, lead salt, dibasic*	62229-08-7	0.005
VIII	134	Tetraethyllead*	78-00-2	0.005
VIII	135	Tetralead trioxide sulphate*	12202-17-4	0.005
VIII	136	Tricosafuorododecanoic acid	307-55-1	0.050
VIII	137	Trilead bis(carbonate)dihydroxide (basic lead carbonate)*	1319-46-6	0.005
VIII	138	Trilead dioxide phosphonate*	12141-20-7	0.005
IX	139	4-Nonylphenol, branched and linear, ethoxylated	-	0.050
IX	140	Ammonium pentadecafluorooctanoate (APFO)**	3825-26-1	0.050
IX	141	Cadmium oxide*	1306-19-0	0.005
IX	142	Cadmium	7440-43-9	0.005
IX	143	Dipentyl phthalate (DPP)	131-18-0	0.050



Unless otherwise agreed in writing, this document is issued by the Company subject to its General Conditions of Service printed overleaf, available on request or accessible at <http://www.sgs.com/en/Terms-and-Conditions.aspx> and, for electronic format documents, subject to Terms and Conditions for Electronic Documents at <http://www.sgs.com/en/Terms-and-Conditions/Terms-e-Documents.aspx>. Attention is drawn to the limitation of liability, indemnification and jurisdiction issues defined therein. Any holder of this document is advised that information contained hereon reflects the Company's findings at the time of its intervention only and within the limits of Client's instructions, if any. The Company's sole responsibility is to its Client and this document does not exonerate parties to a transaction from exercising all their rights and obligations under the transaction documents. This document cannot be reproduced except in full, without prior written approval of the Company. Any unauthorized alteration, forgery or falsification of the content or appearance of this document is unlawful and offenders may be prosecuted to the fullest extent of the law. Unless otherwise stated the results shown in this test report refer only to the sample(s) tested.

Attention: To check the authenticity of testing /inspection report & certificate, please contact us at telephone: (86-755) 8307 1443, or email: CN.Doccheck@sgs.com

SGS-CSTC Shenzhen Technical Services Co., Ltd.
Shenzhen Branch Testing Center Chemical Laboratory

Room 101-901, Plant 4 & Room 101, Plant 2 & Room 101, Plant 3 & Room 301-501, Plant 3, Jianghao (Bantian) Industrial Plant Area, No. 430, Jihua Road, Bantian Community, Bantian Street, Longgang District, Shenzhen, Guangdong, China 518129 www.sgs.com
中国·广东·深圳市龙岗区坂田街道坂田社区吉华路430号江灏(坂田)工业厂区厂房4号101-901、2号101、3号101、3号301-501 邮编:518129 t(86-755) 25328888 sgs.china@sgs.com

Test Report (SVHC)

No.: SZXEC23000888005

Date: Jun 13, 2023

Page 9 of 14

Batch	No.	Substance Name	CAS No.	RL (%)
IX	144	Pentadecafluorooctanoic acid (PFOA)	335-67-1	0.050
X	145	Cadmium sulphide*	1306-23-6	0.005
X	146	Dihexyl phthalate	84-75-3	0.050
X	147	Disodium 3,3'-[[1,1'-biphenyl]-4,4'-diylbis(azo)]bis(4-aminonaphthalene-1-sulphonate) (C.I. Direct Red 28)	573-58-0	0.050
X	148	Disodium 4-amino-3-[[4'-[(2,4-diaminophenyl)azo][1,1'-biphenyl]-4-yl]azo]-5-hydroxy-6-(phenylazo)naphthalene-2,7-disulphonate (C.I. Direct Black 38)	1937-37-7	0.050
X	149	Imidazolidine-2-thione; (2-imidazoline-2-thiol)	96-45-7	0.050
X	150	Lead di(acetate)*	301-04-2	0.005
X	151	Trixylyl phosphate	25155-23-1	0.050
XI	152	1,2-Benzenedicarboxylic acid, dihexyl ester, branched and linear	68515-50-4	0.050
XI	153	Cadmium chloride*	10108-64-2	0.005
XI	154	Sodium perborate; perboric acid, sodium salt*	-	0.005
XI	155	Sodium peroxometaborate*	7632-04-4	0.005
XII	156	2-(2H-benzotriazol-2-yl)-4,6-ditertpentylphenol (UV-328)	25973-55-1	0.050
XII	157	2-benzotriazol-2-yl-4,6-di-tert-butylphenol (UV-320)	3846-71-7	0.050
XII	158	2-ethylhexyl 10-ethyl-4,4-dioctyl-7-oxo-8-oxa-3,5-dithia-4-stannatetradecanoate (DOTE)	15571-58-1	0.050
XII	159	Cadmium fluoride*	7790-79-6	0.005
XII	160	Cadmium sulphate*	10124-36-4 /31119-53-6	0.005
XII	161	Reaction mass of 2-ethylhexyl 10-ethyl-4,4-dioctyl-7-oxo-8-oxa-3,5-dithia-4-stannatetradecanoate & 2-ethylhexyl 10-ethyl-4-[[2-[(2-ethylhexyl)oxy]-2-oxoethyl]thio]-4-octyl-7-oxo-8-oxa-3,5-dithia-4-stannatetradecanoate (reaction mass of DOTE & MOTE)	-	0.050
XIII	162	1,2-benzenedicarboxylic acid, di-C6-10-alkyl esters; 1,2-benzenedicarboxylic acid, mixed decyl and hexyl and octyl diesters with ≥ 0.3% of dihexyl phthalate	-	0.050
XIII	163	5-sec-butyl-2-(2,4-dimethylcyclohex-3-en-1-yl)-5-methyl-1,3-dioxane [1], 5-sec-butyl-2-(4,6-dimethylcyclohex-3-en-1-yl)-5-methyl-1,3-dioxane [2] [covering any of the individual isomers of [1] and [2] or any combination thereof]	-	0.050
XIV	164	1,3-propanesultone	1120-71-4	0.050
XIV	165	2,4-di-tert-butyl-6-(5-chlorobenzotriazol-2-yl)phenol (UV-327)	3864-99-1	0.050
XIV	166	2-(2H-benzotriazol-2-yl)-4-(tert-butyl)-6-(sec-butyl)phenol (UV-350)	36437-37-3	0.050



Unless otherwise agreed in writing, this document is issued by the Company subject to its General Conditions of Service printed overleaf, available on request or accessible at <http://www.sgs.com/en/Terms-and-Conditions.aspx> and, for electronic format documents, subject to Terms and Conditions for Electronic Documents at <http://www.sgs.com/en/Terms-and-Conditions/Terms-e-Documents.aspx>. Attention is drawn to the limitation of liability, indemnification and jurisdiction issues defined therein. Any holder of this document is advised that information contained hereon reflects the Company's findings at the time of its intervention only and within the limits of Client's instructions, if any. The Company's sole responsibility is to its Client and this document does not exonerate parties to a transaction from exercising all their rights and obligations under the transaction documents. This document cannot be reproduced except in full, without prior written approval of the Company. Any unauthorized alteration, forgery or falsification of the content or appearance of this document is unlawful and offenders may be prosecuted to the fullest extent of the law. Unless otherwise stated the results shown in this test report refer only to the sample(s) tested.

Attention: To check the authenticity of testing /inspection report & certificate, please contact us at telephone: (86-755) 8307 1443, or email: CN.Doccheck@sgs.com

SGS-CTC (Shenzhen) Technical Services Co., Ltd.
Shenzhen Branch Testing Center Chemical Laboratory

Room 101-901, Plant 4 & Room 101, Plant 2 & Room 101, Plant 3 & Room 301-501, Plant 3, Jianghao (Bantian) Industrial Plant Area, No. 430, Jihua Road, Bantian Community, Bantian Street, Longgang District, Shenzhen, Guangdong, China 518129 www.sgs.com
中国·广东·深圳市龙岗区坂田街道坂田社区吉华路430号江灞(坂田)工业区厂房4号101-901、2号101、3号101、3号301-501 邮编:518129 t(86-755) 25328888 sgs.china@sgs.com

Test Report (SVHC)

No.: SZXEC23000888005

Date: Jun 13, 2023

Page 10 of 14

Batch	No.	Substance Name	CAS No.	RL (%)
XIV	167	Nitrobenzene	98-95-3	0.050
XIV	168	Perfluorononan-1-oic-acid and its sodium and ammonium salts	-	0.050
XV	169	Benzo[def]chrysene (Benzo[a]pyrene)	50-32-8	0.050
XVI	170	4,4'-isopropylidenediphenol (bisphenol A)	80-05-7	0.050
XVI	171	4-Heptylphenol, branched and linear	-	0.050
XVI	172	Nonadecafluorodecanoic acid (PFDA) and its sodium and ammonium salts	-	0.050
XVI	173	p-(1,1-dimethylpropyl)phenol	80-46-6	0.050
XVII	174	Perfluorohexane-1-sulphonic acid and its salts	-	0.050
XVIII	175	1,6,7,8,9,14,15,16,17,17,18,18-Dodecachloropentacyclo[12.2.1.16,9.0.2,13.05,10]octadeca-7,15-diene ("Dechlorane Plus" TM) [covering any of its individual anti- and syn-isomers or any combination thereof]	-	0.050
XVIII	176	Benz[a]anthracene	56-55-3	0.050
XVIII	177	Cadmium nitrate*	10325-94-7	0.005
XVIII	178	Cadmium carbonate*	513-78-0	0.005
XVIII	179	Cadmium hydroxide*	21041-95-2	0.005
XVIII	180	Chrysene	218-01-9	0.050
XVIII	181	Reaction products of 1,3,4-thiadiazolidine-2,5-dithione, formaldehyde and 4-heptylphenol, branched and linear (RP-HP) [with ≥0.1% w/w 4-heptylphenol, branched and linear]	-	0.050
XIX	182	Benzene-1,2,4-tricarboxylic acid 1,2 anhydride (trimellitic anhydride) (TMA)	552-30-7	0.050
XIX	183	Benzo[ghi]perylene	191-24-2	0.050
XIX	184	Decamethylcyclotrisiloxane (D5)	541-02-6	0.050
XIX	185	Dicyclohexyl phthalate (DCHP)	84-61-7	0.050
XIX	186	Disodium octaborate*	12008-41-2	0.005
XIX	187	Dodecamethylcyclotrisiloxane (D6)	540-97-6	0.050
XIX	188	Ethylenediamine (EDA)	107-15-3	0.050
XIX	189	Lead	7439-92-1	0.005
XIX	190	Octamethylcyclotetrasiloxane (D4)	556-67-2	0.050
XIX	191	Terphenyl, hydrogenated	61788-32-7	0.050
XX	192	1,7,7-trimethyl-3-(phenylmethylene)bicyclo[2.2.1]heptan-2-one (3-benzylidene camphor)	15087-24-8	0.050
XX	193	2,2-bis(4'-hydroxyphenyl)-4-methylpentane	6807-17-6	0.050
XX	194	Benzo[k]fluoranthene	207-08-9	0.050
XX	195	Fluoranthene	206-44-0	0.050
XX	196	Phenanthrene	85-01-8	0.050
XX	197	Pyrene	129-00-0	0.050
XXI	198	2,3,3,3-tetrafluoro-2-(heptafluoropropoxy)propionic acid, its salts and its acyl halides (covering any of their individual isomers and combinations thereof)	-	0.050
XXI	199	2-methoxyethyl acetate	110-49-6	0.050



SGS-CSTC Standards Technical Services Co., Ltd.
Shenzhen Branch Testing Center Chemical Laboratory

Unless otherwise agreed in writing, this document is issued by the Company subject to its General Conditions of Service printed overleaf, available on request or accessible at <http://www.sgs.com/en/Terms-and-Conditions.aspx> and, for electronic format documents, subject to Terms and Conditions for Electronic Documents at <http://www.sgs.com/en/Terms-and-Conditions/Terms-e-Documents.aspx>. Attention is drawn to the limitation of liability, indemnification and jurisdiction issues defined therein. Any holder of this document is advised that information contained hereon reflects the Company's findings at the time of its intervention only and within the limits of Client's instructions, if any. The Company's sole responsibility is to its Client and this document does not exonerate parties to a transaction from exercising all their rights and obligations under the transaction documents. This document cannot be reproduced except in full, without prior written approval of the Company. Any unauthorized alteration, forgery or falsification of the content or appearance of this document is unlawful and offenders may be prosecuted to the fullest extent of the law. Unless otherwise stated the results shown in this test report refer only to the sample(s) tested.

Attention: To check the authenticity of testing / inspection report & certificate, please contact us at telephone: (86-755) 8307 1443, or email: CN.Doccheck@sgs.com

Room 101-901, Plant 4 & Room 101, Plant 2 & Room 101, Plant 3 & Room 301-501, Plant 3, Jianghao (Bantian) Industrial Plant Area, No. 430, Jihua Road, Bantian Community, Bantian Street, Longgang District, Shenzhen, Guangdong, China 518129 www.sgs.com
中国·广东·深圳市龙岗区坂田街道坂田社区吉华路430号江灏(坂田)工业区厂房4号101-901、2号101、3号101、3号301-501 邮编:518129 t:(86-755) 25328888 sgs.china@sgs.com

Test Report (SVHC)

No.: SZXEC23000888005

Date: Jun 13, 2023

Page 11 of 14

Batch	No.	Substance Name	CAS No.	RL (%)
XXI	200	4-tert-butylphenol (PTBP)	98-54-4	0.050
XXI	201	Tris(4-nonylphenyl, branched and linear) phosphite (TNPP) with ≥ 0.1% w/w of 4-nonylphenol, branched and linear (4-NP)	-	0.050
XXII	202	2-benzyl-2-dimethylamino-4'-morpholinobutyrophenone	119313-12-1	0.050
XXII	203	2-methyl-1-(4-methylthiophenyl)-2-morpholinopropan-1-one	71868-10-5	0.050
XXII	204	Diisohexyl phthalate	71850-09-4	0.050
XXII	205	Perfluorobutane sulfonic acid (PFBS) and its salts	-	0.050
XXIII	206	1-vinylimidazole	1072-63-5	0.050
XXIII	207	2-methylimidazole	693-98-1	0.050
XXIII	208	Butyl 4-hydroxybenzoate	94-26-8	0.050
XXIII	209	Dibutylbis(pentane-2,4-dionato-O,O')tin**	22673-19-4	0.050
XXIV	210	bis(2-(2-methoxyethoxy)ethyl) ether	143-24-8	0.050
XXIV	211	Diocetyl tin dilaurate, stannane, dioctyl-, bis(coco acyloxy) derivs., and any other stannane, dioctyl-, bis(fatty acyloxy) derivs. wherein C12 is the predominant carbon number of the fatty acyloxy moiety**	-	0.050
XXV	212	1,4-Dioxane	123-91-1	0.050
XXV	213	2,2-bis(bromomethyl)propane 1,3-diol (BMP); 2,2-dimethylpropan-1-ol, tribromo derivative/3-bromo-2,2-bis(bromomethyl)-1-propanol (TBNPA); 2,3-dibromo-1-propanol (2,3-DBPA)	-	0.050
XXV	214	2-(4-tert-butylbenzyl)propionaldehyde and its individual stereoisomers	-	0.050
XXV	215	4,4'-(1-methylpropylidene)bisphenol; (bisphenol B)	77-40-7	0.050
XXV	216	Glutaral	111-30-8	0.050
XXV	217	Medium-chain chlorinated paraffins (MCCP) [UVCB substances consisting of more than or equal to 80% linear chloroalkanes with carbon chain lengths within the range from C14 to C17]	-	0.050
XXV	218	Orthoboric acid, sodium salt*	13840-56-7	0.005
XXV	219	Phenol, alkylation products (mainly in para position) with C12-rich branched or linear alkyl chains from oligomerisation, covering any individual isomers and/ or combinations thereof (PDDP)	-	0.050
XXVI	220	(±)-1,7,7-trimethyl-3-[(4-methylphenyl)methylene]bicyclo[2.2.1]heptan-2-one covering any of the individual isomers and/or combinations thereof (4-MBC)	-	0.050
XXVI	221	6,6'-di-tert-butyl-2,2'-methylene-di-p-cresol (DBMC)	119-47-1	0.050



SGS-CTC Standards Technical Services Co., Ltd.
Shenzhen Branch Testing Center Chemical Laboratory

Unless otherwise agreed in writing, this document is issued by the Company subject to its General Conditions of Service printed overleaf, available on request or accessible at <http://www.sgs.com/en/Terms-and-Conditions.aspx> and, for electronic format documents, subject to Terms and Conditions for Electronic Documents at <http://www.sgs.com/en/Terms-and-Conditions/Terms-e-Document.aspx>. Attention is drawn to the limitation of liability, indemnification and jurisdiction issues defined therein. Any holder of this document is advised that information contained hereon reflects the Company's findings at the time of its intervention only and within the limits of Client's instructions, if any. The Company's sole responsibility is to its Client and this document does not exonerate parties to a transaction from exercising all their rights and obligations under the transaction documents. This document cannot be reproduced except in full, without prior written approval of the Company. Any unauthorized alteration, forgery or falsification of the content or appearance of this document is unlawful and offenders may be prosecuted to the fullest extent of the law. Unless otherwise stated the results shown in this test report refer only to the sample(s) tested.

Attention: To check the authenticity of testing /inspection report & certificate, please contact us at telephone: (86-755) 8307 1443, or email: CN.Doccheck@sgs.com

Room 101-901, Plant 4 & Room 101, Plant 2 & Room 101, Plant 3 & Room 301-501, Plant 3, Jianghao (Bantian) Industrial Plant Area, No. 430, Jihua Road, Bantian Community, Bantian Street, Loongang District, Shenzhen, Guangdong, China 518129 www.sgs.com
中国·广东·深圳市龙岗区坂田街道坂田社区吉华路430号江豪(坂田)工业区厂房4号101-901、2号101、3号301-501 邮编:518129 t:(86-755) 25328888 sgs.china@sgs.com

**Test Report
(SVHC)**

No.: SZXEC23000888005

Date: Jun 13, 2023

Page 12 of 14

Batch	No.	Substance Name	CAS No.	RL (%)
XXVI	222	S-(tricyclo[5.2.1.0'2,6]deca-3-en-8(or 9)-yl) O-(isopropyl or isobutyl or 2-ethylhexyl) O-(isopropyl or isobutyl or 2-ethylhexyl) phosphorodithioate	255881-94-8	0.050
XXVI	223	Tris(2-methoxyethoxy)vinylsilane	1067-53-4	0.050
XXVII	224	N-(hydroxymethyl)acrylamide	924-42-5	0.050
XXVIII	225	1,1'-[ethane-1,2-diylbis(oxy)]bis[2,4,6-tribromobenzene]	37853-59-1	0.050
XXVIII	226	2,2',6,6'-tetrabromo-4,4'-isopropylidenediphenol	79-94-7	0.050
XXVIII	227	4,4'-sulphonyldiphenol	80-09-1	0.050
XXVIII	228	Barium diboron tetraoxide*	13701-59-2	0.005
XXVIII	229	Bis(2-ethylhexyl) tetrabromophthalate covering any of the individual isomers and/or combinations thereof	26040-51-7	0.050
XXVIII	230	Isobutyl 4-hydroxybenzoate	4247-02-3	0.050
XXVIII	231	Melamine	108-78-1	0.050
XXVIII	232	Perfluoroheptanoic acid and its salts	-	0.050
XXVIII	233	reaction mass of 2,2,3,3,5,5,6,6-octafluoro-4-(1,1,1,2,3,3,3-heptafluoropropan-2-yl)morpholine and 2,2,3,3,5,5,6,6-octafluoro-4-(heptafluoropropyl)morpholine*	-	0.050
/	234	bis(4-chlorophenyl) sulphone	80-07-9	0.050
/	235	Diphenyl(2,4,6-trimethylbenzoyl)phosphine oxide	75980-60-8	0.050
/	236	Resorcinol	108-46-3	0.050



SGS-CSTC Standards Technical Services Co., Ltd.
Shenzhen Branch Testing Center Chemical Laboratory

Unless otherwise agreed in writing, this document is issued by the Company subject to its General Conditions of Service printed overleaf, available on request or accessible at <http://www.sgs.com/en/Terms-and-Conditions.aspx> and, for electronic format documents, subject to Terms and Conditions for Electronic Documents at <http://www.sgs.com/en/Terms-and-Conditions/Terms-e-Documents.aspx>. Attention is drawn to the limitation of liability, indemnification and jurisdiction issues defined therein. Any holder of this document is advised that information contained hereon reflects the Company's findings at the time of its intervention only and within the limits of Client's instructions, if any. The Company's sole responsibility is to its Client and this document does not exonerate parties to a transaction from exercising all their rights and obligations under the transaction documents. This document cannot be reproduced except in full, without prior written approval of the Company. Any unauthorized alteration, forgery or falsification of the content or appearance of this document is unlawful and offenders may be prosecuted to the fullest extent of the law. Unless otherwise stated the results shown in this test report refer only to the sample(s) tested.

Attention: To check the authenticity of testing /inspection report & certificate, please contact us at telephone: (86-755) 8307 1443, or email: CN.Doccheck@sgs.com

Room 101-901, Plant 4 & Room 101, Plant 2 & Room 101, Plant 3 & Room 301-501, Plant 3, Jianghao (Bantian) Industrial Plant Area, No. 430, Jihua Road, Bantian Community, Bantian Street, Longgang District, Shenzhen, Guangdong, China 518129 www.sgs.com.cn
中国·广东·深圳市龙岗区坂田街道坂田社区吉华路430号江灏(坂田)工业区厂房4号101-901、2号101、3号301-501 邮编:518129 t:(86-755) 25328888 sgs.china@sgs.com

Testing Flow Chart

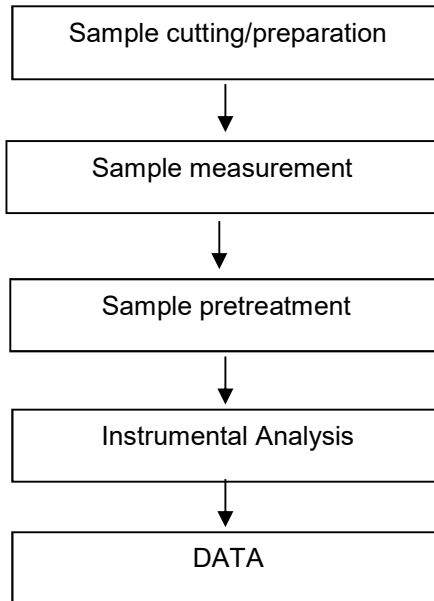

Unless otherwise agreed in writing, this document is issued by the Company subject to its General Conditions of Service printed overleaf, available on request or accessible at <http://www.sgs.com/en/Terms-and-Conditions.aspx> and, for electronic format documents, subject to Terms and Conditions for Electronic Documents at <http://www.sgs.com/en/Terms-and-Conditions/Terms-e-Documents.aspx>. Attention is drawn to the limitation of liability, indemnification and jurisdiction issues defined therein. Any holder of this document is advised that information contained hereon reflects the Company's findings at the time of its intervention only and within the limits of Client's instructions, if any. The Company's sole responsibility is to its Client and this document does not exonerate parties to a transaction from exercising all their rights and obligations under the transaction documents. This document cannot be reproduced except in full, without prior written approval of the Company. Any unauthorized alteration, forgery or falsification of the content or appearance of this document is unlawful and offenders may be prosecuted to the fullest extent of the law. Unless otherwise stated the results shown in this test report refer only to the sample(s) tested.

Attention: To check the authenticity of testing /inspection report & certificate, please contact us at telephone: (86-755) 8307 1443, or email: CN.Doccheck@sgs.com

Test Report (SVHC)

No.: SZXEC23000888005

Date: Jun 13, 2023

Page 14 of 14

Sample photos:



SGS authenticate the photo on original report only

*** End of Report ***



Unless otherwise agreed in writing, this document is issued by the Company subject to its General Conditions of Service printed overleaf, available on request or accessible at <http://www.sgs.com/en/Terms-and-Conditions.aspx> and, for electronic format documents, subject to Terms and Conditions for Electronic Documents at <http://www.sgs.com/en/Terms-and-Conditions/Terms-e-Document.aspx>. Attention is drawn to the limitation of liability, indemnification and jurisdiction issues defined therein. Any holder of this document is advised that information contained hereon reflects the Company's findings at the time of its intervention only and within the limits of Client's instructions, if any. The Company's sole responsibility is to its Client and this document does not exonerate parties to a transaction from exercising all their rights and obligations under the transaction documents. This document cannot be reproduced except in full, without prior written approval of the Company. Any unauthorized alteration, forgery or falsification of the content or appearance of this document is unlawful and offenders may be prosecuted to the fullest extent of the law. Unless otherwise stated the results shown in this test report refer only to the sample(s) tested.

Attention: To check the authenticity of testing /inspection report & certificate, please contact us at telephone: (86-755) 8307 1443, or email: CN.Doccheck@sgs.com

Room 101-901, Plant 4 & Room 101, Plant 2 & Room 101, Plant 3 & Room 301-501, Plant 3, Jianghao (Bantian) Industrial Plant Area, No. 430, Jihua Road, Bantian Community, Bantian Street, Longgang District, Shenzhen, Guangdong, China 518129 www.sgs.com

中国·广东·深圳市龙岗区坂田街道坂田社区吉华路430号江灏(坂田)工业区厂房4号101-901、2号101、3号101、3号301-501 邮编:518129 t:(86-755) 25328888 sgs.china@sgs.com

检测报告
(SVHC)

编号: SZXEC23000888006

日期: 2023年06月13日

第1页, 共13页

客户名称: 东莞市泛亚电子有限公司
客户地址: 广东省东莞市石碣镇科技东路194号

样品名称: 线圈

以上样品及信息由客户提供。

SGS 工作编号: SZP23-001370

样品接收时间: 2023年05月15日

检测周期: 2023年05月15日~2023年05月24日

检测要求: 根据客户要求,
(i) 基于欧洲化学品管理署截止2023年1月17日公布的供授权审议的高关注物质候选清单(根据欧盟第1907/2006号REACH法规), 对233种高关注物质(SVHC)进行筛分检测。
(ii) 基于WTO 2021年6月1日的通知, 对1种潜在的高关注物质(SVHC)进行筛分检测。
(iii) 基于欧洲化学品管理署截止2023年2月17日公布的潜在的高关注物质咨询清单(根据欧盟第1907/2006号REACH法规), 对2种高关注物质(SVHC)进行筛分检测。

检测方法: 见后续页。

检测结果: 见后续页。

总结:

根据具体的范围和筛分检测, 所提交样品中SVHC检测结果 $\leq 0.1\%$ (w/w)。

通过

通标标准技术服务有限公司深圳分公司
授权签名

范萍

Tina Fan 范萍
批准签署人

scan to see the report



9680409E



SGS-CSTC 通标标准技术服务有限公司深圳分公司
Shenzhen Branch Testing Center Chemical Laboratory

Unless otherwise agreed in writing, this document is issued by the Company subject to its General Conditions of Service printed overleaf, available on request or accessible at <http://www.sgs.com/en/Terms-and-Conditions.aspx> and, for electronic format documents, subject to Terms and Conditions for Electronic Documents at <http://www.sgs.com/en/Terms-and-Conditions/Terms-e-Documents.aspx>. Attention is drawn to the limitation of liability, indemnification and jurisdiction issues defined therein. Any holder of this document is advised that information contained hereon reflects the Company's findings at the time of its intervention only and within the limits of Client's instructions, if any. The Company's sole responsibility is to its Client and this document does not exonerate parties to a transaction from exercising all their rights and obligations under the transaction documents. This document cannot be reproduced except in full, without prior written approval of the Company. Any unauthorized alteration, forgery or falsification of the content or appearance of this document is unlawful and offenders may be prosecuted to the fullest extent of the law. Unless otherwise stated the results shown in this test report refer only to the sample(s) tested.

Attention: To check the authenticity of testing / inspection report & certificate, please contact us at telephone: (86-755) 8307 1443, or email: CN.Doccheck@sgs.com

Room 101-901, Plant 4 & Room 101, Plant 2 & Room 101, Plant 3 & Room 301-501, Plant 3, Jianghao (Bantian) Industrial Plant Area, No. 430, Jihua Road, Bantian Community, Bantian Street, Longgang District, Shenzhen, Guangdong, China 518129 www.sgs.com
中国·广东·深圳市龙岗区坂田街道坂田社区吉华路430号江豪(坂田)工业区厂房4号101-901、2号101、3号101、3号301-501 邮编:518129 t:(86-755)25328888 sgs.china@sgs.com

备注:

1. 本报告所涉及的关于特定高关注物质的化学分析是根据欧洲化学品管理署发布的下列文件, 利用现有的分析技术完成的。
<http://echa.europa.eu/web/guest/candidate-list-table>
这些文件清单由欧洲化学品管理署评估, 将来可能会有变化。

2. REACH 法规义务:

- 2.1 关于物品:

告知:

欧盟第 1907/2006 (EC) 号法规第 33 条规定, 含有满足第 57 条中的标准并根据第 59 条第一款被确定且质量分数大于 0.1% 的物质的物品的所有供应商应向物品接受者提供其可获取的充足信息, 以使物品使用安全, 这些信息至少包括含有的候选清单中物质的名称。

通报:

根据欧盟第 1907/2006 (EC) 号法规, 如果满足以下两个条件, 如果物质符合第 57 条中的标准并根据第 59 条第一款被确定, 物品的任何欧洲制造商或进口商应根据第 7 条第 4 款向欧盟化学品管理署进行通报: (a) 候选清单中的物质在物品中的总含量超过 1 吨/年/生产商或进口商; (b) 候选清单中的物质在物品中的总含量以质量分数计超过 0.1% 的浓度。

SGS 采用欧盟法院对 REACH 物品定义的裁定, 除非另有说明。详细的解释请见下列网址:

<http://www.sgs.com/-/media/global/documents/technical-documents/technical-bulletins/sgs-crs-position-statement-on-svhc-in-articles-a4-en-16-06.pdf?la=en>

- 2.2 关于材料:

报告中的检测结果是基于检测样品。如样品是均一材质, 当其构成成品时, 此结果不能代表成品中的 SVHC 浓度。如样品为均一材质等比例合测, 这些材质也可能来自不同的物品。

如果样品是一种物质或混合物, 并且直接出口到欧盟, 客户有责任遵守欧盟第 1907/2006 号 REACH 法规第 31 条供应链信息传递的义务和附件十四中的授权高关注物质授权的责任。

- 2.3 关于物质和配制品:

如果样品中高关注物质的浓度超过 0.1% (w/w) 和/或欧盟第 1272/2008 号 CLP 法规及其修订中设定的特殊浓度限值, 建议客户根据欧盟第 1907/2006 号 REACH 法规对有关高关注物质准备安全数据表 (SDS) 以符合供应链通信的义务, 如

-根据欧盟第 1272/2008 号 CLP 法规被列为有害物质。

-根据欧盟第 1272/2008 号 CLP 法规被列为有害混合物, 而当中物质的浓度大于或等于欧盟第 1272/2008 号 CLP 法规列出的浓度限值; 或

-根据欧盟第 1272/2008 号 CLP 法规并未列为有害混合物, 但包含:

(a) 对人类健康或环境有害的物质, 而在固体或液体混合物 (即非气体混合物) 中其浓度 $\geq 1\%$ (w/w) 或在气体混合物中占体积 $\geq 0.2\%$, 或

(b) PBT 或 vPvB 物质, 在固体或液体混合物 (即非气体混合物) 中个别浓度 $\geq 0.1\%$ (w/w), 或

(c) 授权审议的高关注物质候选清单上的物质 (除上述以外的原因) 在个别非气体混合物中的浓度 $\geq 0.1\%$ (w/w), 或

(d) 设有欧洲范围内工作场所接触限值的物质。

3. 如果样品中 SVHC 的检测结果超过报告限, 建议客户进一步定量分析检测含有 SVHC 的组分并且得到 SVHC 物质的准确浓度。



SGS-CTC (Shenzhen) Technical Services Co., Ltd.
Shenzhen Branch Testing Center-Chemical Laboratory

Unless otherwise agreed in writing, this document is issued by the Company subject to its General Conditions of Service printed overleaf, available on request or accessible at <http://www.sgs.com/en/Terms-and-Conditions.aspx> and, for electronic format documents, subject to Terms and Conditions for Electronic Documents at <http://www.sgs.com/en/Terms-and-Conditions/Terms-e-Documents.aspx>. Attention is drawn to the limitation of liability, indemnification and jurisdiction issues defined therein. Any holder of this document is advised that information contained hereon reflects the Company's findings at the time of its intervention only and within the limits of Client's instructions, if any. The Company's sole responsibility is to its Client and this document does not exonerate parties to a transaction from exercising all their rights and obligations under the transaction documents. This document cannot be reproduced except in full, without prior written approval of the Company. Any unauthorized alteration, forgery or falsification of the content or appearance of this document is unlawful and offenders may be prosecuted to the fullest extent of the law. Unless otherwise stated the results shown in this test report refer only to the sample(s) tested.

Attention: To check the authenticity of testing /inspection report & certificate, please contact us at telephone: (86-755) 8307 1443, or email: CN.Doccheck@sgs.com

Room 101-901, Plant 4 & Room 101, Plant 2 & Room 101, Plant 3 & Room 301-501, Plant 3, Jianghao (Bantian) Industrial Plant Area, No. 430, Jihua Road, Bantian Community, Banlan Street, Longgang District, Shenzhen, Guangdong, China 518129 www.sgs.com
中国·广东·深圳市龙岗区坂田街道坂田社区吉华路430号江灏(坂田)工业厂区厂房4号101-901、2号101、3号101、3号301-501 邮编:518129 t:(86-755) 25328888 sgs.china@sgs.com

检测报告
(SVHC)

编号: SZXEC23000888006

日期: 2023年06月13日

第3页, 共13页

检测样品:

检测组:

检测结果 ID	样品描述	检测部件 ID	SGS 样品 ID
001	带无色透明表层的铜色金属线 A#+带红色表层的银色金属线 B#+白色材料 C#+白色材料 D#+深灰色磁芯 E#	A7	SZX23-0008880-0001.C007

检测方法:

参考 SGS 内部方法, 采用 ICP-OES、UV-VIS、GC-MS、HPLC-DAD/MS 和比色法进行分析。



Unless otherwise agreed in writing, this document is issued by the Company subject to its General Conditions of Service printed overleaf, available on request or accessible at <http://www.sgs.com/en/Terms-and-Conditions.aspx> and, for electronic format documents, subject to Terms and Conditions for Electronic Documents at <http://www.sgs.com/en/Terms-and-Conditions/Terms-e-Documents.aspx>. Attention is drawn to the limitation of liability, indemnification and jurisdiction issues defined therein. Any holder of this document is advised that information contained hereon reflects the Company's findings at the time of its intervention only and within the limits of Client's instructions, if any. The Company's sole responsibility is to its Client and this document does not exonerate parties to a transaction from exercising all their rights and obligations under the transaction documents. This document cannot be reproduced except in full, without prior written approval of the Company. Any unauthorized alteration, forgery or falsification of the content or appearance of this document is unlawful and offenders may be prosecuted to the fullest extent of the law. Unless otherwise stated the results shown in this test report refer only to the sample(s) tested.

Attention: To check the authenticity of testing /inspection report & certificate, please contact us at telephone: (86-755) 8307 1443, or email: CN.Doccheck@sgs.com

SGS-CSTC Standards Technical Services Co., Ltd.
Shenzhen Branch Testing Center-Chemical Laboratory

Room 101-901, Plant 4 & Room 101, Plant 2 & Room 101, Plant 3 & Room 301-501, Plant 3, Jianghao (Bantian) Industrial Plant Area, No. 430, Jihua Road, Bantian Community, Bantian Street, Longgang District, Shenzhen, Guangdong, China 518129 www.sgs.com.cn
中国·广东·深圳市龙岗区坂田街道坂田社区吉华路430号江灏(坂田)工业区厂房4号101-901、2号101、3号101、3号301-501 邮编:518129 t:(86-755) 25328888 sgs.china@sgs.com

检测报告 (SVHC)

编号: SZXEC23000888006

日期: 2023年06月13日

第4页, 共13页

检测结果: (候选清单中的高关注物质)

批次	物质名称	CAS No.	001 浓度 (%)	RL (%)
-	所有检测的候选清单中的 SVHC	-	ND	-

检测结果: (潜在的 SVHC)

批次	物质名称	CAS No.	001 浓度 (%)	RL (%)
/	所有检测的潜在的 SVHC	-	ND	-

备注:

- (1) 上表仅显示检测到的 SVHC, 未报告 RL 以下的 SVHC。请参阅已检测 SVHC 的完整列表附录。
- (2) RL = 报告限制 (如果检测数据 \geq RL, 将显示检测数据。RL 不是监管限制。
- ND = 未检测到 (低于 RL), ND 表示在 SVHC 物质上。
- (3) * 检测结果基于所选元素的计算和最坏情况。
- ** 检测结果基于所选标记的计算和最坏情况。
- 硼化合物的结果由 ICP-OES 检测的水提取硼元素结果换算得出。
- 四氧化二硼钡的结果由 ICP-OES 检测的水提取硼和钡元素结果换算得出。
- RL = 0.005% 是针对元素 (例如钴、砷、铅、铬 (VI)、铝、锆、硼、锶、锌、铈、钛、钡、镉), 除了钨的 RL = 0.0005%, 硼的 RL = 0.0025% (仅对四氟硼酸铅), 氟的 RL = 0.050%。
- (4) § 只有当物质包含米氏酮 (CAS No.: 90-94-8) 或米氏碱 (CAS No.: 101-61-1) 的浓度 \geq 0.1% (w / w) 的情况下, 该物质才被提议定为 SVHC。
- (5) / = 潜在的 SVHC
- (6) 基于客户要求等进行等比混合测试, 检测结果基于最小样品质量计算。

除非另有说明, 参照 ILAC-G8:09/2019, 使用简单接受 (w=0) 的二元判定规则进行符合性判定。
 除非另有说明, 此报告结果仅对检测的样品负责。本报告未经本公司书面许可, 不可部分复制。
 检测报告仅用于客户科研、教学、内部质量控制、产品研发等目的, 仅供内部参考。



Unless otherwise agreed in writing, this document is issued by the Company subject to its General Conditions of Service printed overleaf, available on request or accessible at <http://www.sgs.com/en/Terms-and-Conditions.aspx> and, for electronic format documents, subject to Terms and Conditions for Electronic Documents at <http://www.sgs.com/en/Terms-and-Conditions/Terms-e-Documents.aspx>. Attention is drawn to the limitation of liability, indemnification and jurisdiction issues defined therein. Any holder of this document is advised that information contained hereon reflects the Company's findings at the time of its intervention only and within the limits of Client's instructions, if any. The Company's sole responsibility is to its Client and this document does not exonerate parties to a transaction from exercising all their rights and obligations under the transaction documents. This document cannot be reproduced except in full, without prior written approval of the Company. Any unauthorized alteration, forgery or falsification of the content or appearance of this document is unlawful and offenders may be prosecuted to the fullest extent of the law. Unless otherwise stated the results shown in this test report refer only to the sample(s) tested.

Attention: To check the authenticity of testing /inspection report & certificate, please contact us at telephone: (86-755) 8307 1443, or email: CN.Doccheck@sgs.com

Room 101-901, Plant 4 & Room 101, Plant 2 & Room 101, Plant 3 & Room 301-501, Plant 3, Jianghao (Bantian) Industrial Plant Area, No. 430, Jihua Road, Bantian Community, Bantian Street, Longgang District, Shenzhen, Guangdong, China 518129 www.sgs.com.cn
 中国·广东·深圳市龙岗区坂田街道坂田社区吉华路430号江灏(坂田)工业厂区厂房4号101-901、2号101、3号101、3号301-501 邮编:518129 t:(86-755) 25328888 sgs.china@sgs.com

检测报告 (SVHC)

编号: SZXEC23000888006

日期: 2023年06月13日

第5页, 共13页

附录

所有检测的 SVHC:

批次	序号	物质名称	CAS No.	RL (%)
I	1	4,4'-二氨基二苯甲烷(MDA)	101-77-9	0.050
I	2	2,4,6-三硝基-5-叔丁基间二甲苯(二甲苯麝香)	81-15-2	0.050
I	3	C10-13 氯代烃(短链氯化石蜡)	85535-84-8	0.050
I	4	葱	120-12-7	0.050
I	5	邻苯二甲酸丁苯酯(BBP)	85-68-7	0.050
I	6	邻苯二甲酸二(2-乙基己基)酯(DEHP)	117-81-7	0.050
I	7	氧化双三丁基锡(TBTO)	56-35-9	0.050
I	8	三氯化钴*	7646-79-9	0.005
I	9	五氧化二砷*	1303-28-2	0.005
I	10	三氧化二砷*	1327-53-3	0.005
I	11	邻苯二甲酸二丁酯(DBP)	84-74-2	0.050
I	12	六溴环十二烷(HBCDD) 及其非对映异构体(α -HBCDD, β -HBCDD, γ -HBCDD)	-	0.050
I	13	砷酸氢铅*	7784-40-9	0.005
I	14	重铬酸钠*	10588-01-9 /7789-12-0	0.005
I	15	三乙基砷酸酯*	15606-95-8	0.005
II	16	2,4-二硝基甲苯	121-14-2	0.050
II	17	丙烯酰胺	79-06-1	0.050
II	18	葱油**	90640-80-5	0.050
II	19	葱油, 葱糊**	90640-81-6	0.050
II	20	葱油, 葱糊, 葱馏分**	91995-15-2	0.050
II	21	葱油, 葱糊, 轻油**	91995-17-4	0.050
II	22	葱油, 含葱量少**	90640-82-7	0.050
II	23	邻苯二甲酸二异丁酯	84-69-5	0.050
II	24	钼铬红(C.I.颜料红 104)*	12656-85-8	0.005
II	25	铬酸铅*	7758-97-6	0.005
II	26	铅铬黄(C.I.颜料黄 34)*	1344-37-2	0.005
II	27	沥青, 煤焦油, 高温**	65996-93-2	0.050
II	28	磷酸三(2-氯乙基)酯	115-96-8	0.050
III	29	重铬酸铵*	7789-09-5	0.005
III	30	硼酸*	-	0.005
III	31	无水四硼酸钠*	12179-04-3 /1303-96-4 /1330-43-4	0.005
III	32	铬酸钾*	7789-00-6	0.005
III	33	重铬酸钾*	7778-50-9	0.005
III	34	铬酸钠*	7775-11-3	0.005
III	35	水合硼酸钠*	12267-73-1	0.005
III	36	三氯乙烯	79-01-6	0.050
IV	37	乙二醇乙醚	110-80-5	0.050



SGS-CTC (Shenzhen) Technical Services Co., Ltd.
Shenzhen Branch Testing Center Chemical Laboratory

Unless otherwise agreed in writing, this document is issued by the Company subject to its General Conditions of Service printed overleaf, available on request or accessible at <http://www.sgs.com/en/Terms-and-Conditions.aspx> and, for electronic format documents, subject to Terms and Conditions for Electronic Documents at <http://www.sgs.com/en/Terms-and-Conditions/Terms-e-Documents.aspx>. Attention is drawn to the limitation of liability, indemnification and jurisdiction issues defined therein. Any holder of this document is advised that information contained hereon reflects the Company's findings at the time of its intervention only and within the limits of Client's instructions, if any. The Company's sole responsibility is to its Client and this document does not exonerate parties to a transaction from exercising all their rights and obligations under the transaction documents. This document cannot be reproduced except in full, without prior written approval of the Company. Any unauthorized alteration, forgery or falsification of the content or appearance of this document is unlawful and offenders may be prosecuted to the fullest extent of the law. Unless otherwise stated the results shown in this test report refer only to the sample(s) tested.

Attention: To check the authenticity of testing / inspection report & certificate, please contact us at telephone: (86-755) 8307 1443, or email: CN.Doccheck@sgs.com

Room 101-901, Plant 4 & Room 101, Plant 2 & Room 101, Plant 3 & Room 301-501, Plant 3, Jianghao (Bantian) Industrial Plant Area, No. 430, Jihua Road, Bantian Community, Bantian Street, Longgang District, Shenzhen, Guangdong, China 518129 www.sgs.com
中国·广东·深圳市龙岗区坂田街道坂田社区吉华路430号江豪(坂田)工业区厂房4号101-901、2号101、3号101、3号301-501 邮编:518129 t:(86-755) 25328888 sgs.china@sgs.com

批次	序号	物质名称	CAS No.	RL (%)
IV	38	乙二醇单甲醚	109-86-4	0.050
IV	39	铬酸, 铬酸及重铬酸低聚物, 重铬酸*	-	0.005
IV	40	三氧化铬*	1333-82-0	0.005
IV	41	碳酸钴*	513-79-1	0.005
IV	42	乙酸钴*	71-48-7	0.005
IV	43	硝酸钴*	10141-05-6	0.005
IV	44	硫酸钴*	10124-43-3	0.005
V	45	1,2,3-三氯丙烷	96-18-4	0.050
V	46	1,2-苯二酸-二(C6-8支链)烷基酯(富C7)	71888-89-6	0.050
V	47	1,2-苯二酸-二(C7-11支链与直链)烷基(醇)酯	68515-42-4	0.050
V	48	1-甲基-2-吡咯烷酮	872-50-4	0.050
V	49	乙二醇乙醚醋酸酯	111-15-9	0.050
V	50	联氨	302-01-2 /7803-57-8	0.050
V	51	铬酸锶*	7789-06-2	0.005
VI	52	1,2-二氯乙烷	107-06-2	0.050
VI	53	4,4'-二氨基-3,3'-二氯二苯甲烷	101-14-4	0.050
VI	54	2-甲氧基苯胺	90-04-0	0.050
VI	55	对特辛基苯酚	140-66-9	0.050
VI	56	硅酸铝耐火陶瓷纤维*	-	0.005
VI	57	砷酸*	7778-39-4	0.005
VI	58	二乙二醇二甲醚	111-96-6	0.050
VI	59	邻苯二甲酸二甲氧基乙酯	117-82-8	0.050
VI	60	砷酸钙*	7778-44-1	0.005
VI	61	铬酸铬*	24613-89-6	0.005
VI	62	甲醛与苯胺的低聚物	25214-70-4	0.050
VI	63	叠氮化铅*	13424-46-9	0.005
VI	64	苦味酸铅*	6477-64-1	0.005
VI	65	史蒂芬酸铅*	15245-44-0	0.005
VI	66	N,N-二甲基乙酰胺	127-19-5	0.050
VI	67	氢氧化铬酸锌*	49663-84-5	0.005
VI	68	酚酞	77-09-8	0.050
VI	69	氢氧化铬酸钾*	11103-86-9	0.005
VI	70	砷酸铝*	3687-31-8	0.005
VI	71	氧化锆硅酸铝耐火陶瓷纤维*	-	0.005
VII	72	C.I.碱性蓝 26§	2580-56-5	0.050
VII	73	C.I.碱性紫 3§	548-62-9	0.050
VII	74	三乙二醇二甲醚(TEGDME)	112-49-2	0.050
VII	75	乙二醇二甲醚(EGDME)	110-71-4	0.050
VII	76	4,4'-二(二甲氨基)二苯甲酮(米氏酮)	90-94-8	0.050
VII	77	4,4'-二(二甲氨基)-4''-氨基三苯甲醇§	561-41-1	0.050
VII	78	三氧化二硼*	1303-86-2	0.005



Unless otherwise agreed in writing, this document is issued by the Company subject to its General Conditions of Service printed overleaf, available on request or accessible at <http://www.sgs.com/en/Terms-and-Conditions.aspx> and, for electronic format documents, subject to Terms and Conditions for Electronic Documents at <http://www.sgs.com/en/Terms-and-Conditions/Terms-e-Documents.aspx>. Attention is drawn to the limitation of liability, indemnification and jurisdiction issues defined therein. Any holder of this document is advised that information contained hereon reflects the Company's findings at the time of its intervention only and within the limits of Client's instructions, if any. The Company's sole responsibility is to its Client and this document does not exonerate parties to a transaction from exercising all their rights and obligations under the transaction documents. This document cannot be reproduced except in full, without prior written approval of the Company. Any unauthorized alteration, forgery or falsification of the content or appearance of this document is unlawful and offenders may be prosecuted to the fullest extent of the law. Unless otherwise stated the results shown in this test report refer only to the sample(s) tested.

Attention: To check the authenticity of testing / inspection report & certificate, please contact us at telephone: (86-755) 8307 1443, or email: CN.Doccheck@sgs.com

SGS-CSTC 圣斯达技术服务有限公司深圳分公司
Shenzhen Branch Testing Center Chemical Laboratory

Room 101-901, Plant 4 & Room 101, Plant 2 & Room 101, Plant 3 & Room 301-501, Plant 3, Jianghao (Bantian) Industrial Plant Area, No. 430, Jihua Road, Bantian Community, Bantian Street, Longgang District, Shenzhen, Guangdong, China 518129 www.sgs.com
中国·广东·深圳市龙岗区坂田街道坂田社区吉华路430号江豪(坂田)工业厂区厂房4号101-901、2号101、3号101、3号301-501 邮编:518129 t:(86-755) 25328888 sgs.china@sgs.com

批次	序号	物质名称	CAS No.	RL (%)
VII	79	甲酰胺	75-12-7	0.050
VII	80	甲基磺酸铅*	17570-76-2	0.005
VII	81	N,N,N',N'-四甲基-4,4'-二氨基二苯甲烷(米氏碱)	101-61-1	0.050
VII	82	1,3,5-三(环氧乙基甲基)-1,3,5-三嗪-2,4,6-(1H, 3H,5H)-三酮(TGIC)	2451-62-9	0.050
VII	83	C.I.溶剂蓝 4S	6786-83-0	0.050
VII	84	1,3,5-三-[(2S 和 2R)-2,3-环氧丙基]-1,3,5-三嗪-2,4,6-(1H, 3H, 5H)-三酮(β -TGIC)	59653-74-6	0.050
VIII	85	二盐基邻苯二甲酸铅*	69011-06-9	0.005
VIII	86	1,2-苯二酸-二(支链与直链)戊基酯	84777-06-0	0.050
VIII	87	乙二醇二乙醚	629-14-1	0.050
VIII	88	1-溴丙烷	106-94-5	0.050
VIII	89	3-乙基-2-甲基-2-(3-甲基丁基)-1,3-恶唑烷	143860-04-2	0.050
VIII	90	对特辛基苯酚乙氧基醚	-	0.050
VIII	91	4,4'-二氨基-3,3'-二甲基二苯甲烷	838-88-0	0.050
VIII	92	4,4'-二氨基二苯醚及其盐	101-80-4	0.050
VIII	93	4-氨基偶氮苯	60-09-3	0.050
VIII	94	2,4-二氨基甲苯	95-80-7	0.050
VIII	95	4-壬基(支链与直链)苯酚	-	0.050
VIII	96	2-甲氧基-5-甲基苯胺	120-71-8	0.050
VIII	97	碱式乙酸铅*	51404-69-4	0.005
VIII	98	4-氨基联苯	92-67-1	0.050
VIII	99	十溴二苯醚(DecaBDE)	1163-19-5	0.050
VIII	100	环己烷-1,2-二羧酸酐, 顺式-环己烷-1,2-二羧酸酐, 反式-环己烷-1,2-二羧酸酐	-	0.050
VIII	101	偶氮二甲酰胺	123-77-3	0.050
VIII	102	二丁基二氯化锡(DBTC)	683-18-1	0.050
VIII	103	硫酸二乙酯	64-67-5	0.050
VIII	104	邻苯二甲酸二异戊酯	605-50-5	0.050
VIII	105	硫酸二甲酯	77-78-1	0.050
VIII	106	地乐酚	88-85-7	0.050
VIII	107	双(十八烷基)二氧化三铅*	12578-12-0	0.005
VIII	108	C16-18-脂肪酸铅*	91031-62-8	0.005
VIII	109	呋喃	110-00-9	0.050
VIII	110	全氟十一烷酸	2058-94-8	0.050
VIII	111	全氟十四烷酸	376-06-7	0.050
VIII	112	甲基六氢邻苯二甲酸酐,4-甲基六氢邻苯二甲酸酐, 1-甲基六氢邻苯二甲酸酐,3-甲基六氢邻苯二甲酸酐	-	0.050
VIII	113	四氟硼酸铅*	13814-96-5	0.005
VIII	114	氨基氰铅盐*	20837-86-9	0.005
VIII	115	硝酸铅*	10099-74-8	0.005



SGS-CSTC 深圳技术服务有限公司
Shenzhen Branch Testing Center Chemical Laboratory

Unless otherwise agreed in writing, this document is issued by the Company subject to its General Conditions of Service printed overleaf, available on request or accessible at <http://www.sgs.com/en/Terms-and-Conditions.aspx> and, for electronic format documents, subject to Terms and Conditions for Electronic Documents at <http://www.sgs.com/en/Terms-and-Conditions/Terms-e-Documents.aspx>. Attention is drawn to the limitation of liability, indemnification and jurisdiction issues defined therein. Any holder of this document is advised that information contained hereon reflects the Company's findings at the time of its intervention only and within the limits of Client's instructions, if any. The Company's sole responsibility is to its Client and this document does not exonerate parties to a transaction from exercising all their rights and obligations under the transaction documents. This document cannot be reproduced except in full, without prior written approval of the Company. Any unauthorized alteration, forgery or falsification of the content or appearance of this document is unlawful and offenders may be prosecuted to the fullest extent of the law. Unless otherwise stated the results shown in this test report refer only to the sample(s) tested.

Attention: To check the authenticity of testing /inspection report & certificate, please contact us at telephone: (86-755) 8307 1443, or email: CN.Doccheck@sgs.com

Room 101-901, Plant 4 & Room 101, Plant 2 & Room 101, Plant 3 & Room 301-501, Plant 3, Jianghao (Bantian) Industrial Plant Area, No. 430, Jihua Road, Bantian Community, Bantian Street, Longgang District, Shenzhen, Guangdong, China 518129 www.sgs.com
中国·广东·深圳市龙岗区坂田街道坂田社区吉华路430号江豪(坂田)工业区厂房4号101-901、2号101、3号101、3号301-501 邮编:518129 t:(86-755) 25328888 sgs.china@sgs.com

批次	序号	物质名称	CAS No.	RL (%)
VIII	116	一氧化铅*	1317-36-8	0.005
VIII	117	碱式硫酸铅*	12036-76-9	0.005
VIII	118	四氧化三铅*	1314-41-6	0.005
VIII	119	钛酸铅*	12060-00-3	0.005
VIII	120	钛酸铅锆*	12626-81-2	0.005
VIII	121	甲氧基乙酸	625-45-6	0.050
VIII	122	1,2-环氧丙烷	75-56-9	0.050
VIII	123	N,N-二甲基甲酰胺	68-12-2	0.050
VIII	124	N-甲基乙酰胺	79-16-3	0.050
VIII	125	邻苯二甲酸正戊基异戊基酯	776297-69-9	0.050
VIII	126	邻-氨基偶氮甲苯	97-56-3	0.050
VIII	127	2-氨基甲苯	95-53-4	0.050
VIII	128	全氟十三烷酸	72629-94-8	0.050
VIII	129	硫酸四氧化五铅*	12065-90-6	0.005
VIII	130	铅锑黄*	8012-00-8	0.005
VIII	131	掺杂铅的硅酸钡*	68784-75-8	0.005
VIII	132	硅酸铅*	11120-22-2	0.005
VIII	133	二碱式亚硫酸铅*	62229-08-7	0.005
VIII	134	四乙基铅*	78-00-2	0.005
VIII	135	硫酸三氧化四铅*	12202-17-4	0.005
VIII	136	全氟十二烷酸	307-55-1	0.050
VIII	137	碱式碳酸铅*	1319-46-6	0.005
VIII	138	二碱式亚磷酸铅*	12141-20-7	0.005
IX	139	4-壬基(支链与直链)苯酚乙氧基醚	-	0.050
IX	140	全氟辛酸铵(APFO)**	3825-26-1	0.050
IX	141	氧化镉*	1306-19-0	0.005
IX	142	镉	7440-43-9	0.005
IX	143	邻苯二甲酸二正戊酯(DPP)	131-18-0	0.050
IX	144	全氟辛酸(PFOA)	335-67-1	0.050
X	145	硫化镉*	1306-23-6	0.005
X	146	邻苯二甲酸二正己酯	84-75-3	0.050
X	147	C.I.直接红 28	573-58-0	0.050
X	148	C.I.直接黑 38	1937-37-7	0.050
X	149	2-巯基咪唑啉	96-45-7	0.050
X	150	乙酸铅*	301-04-2	0.005
X	151	磷酸三二甲苯酯	25155-23-1	0.050
XI	152	邻苯二甲酸二(支链与直链)己基酯	68515-50-4	0.050
XI	153	氯化镉*	10108-64-2	0.005
XI	154	水合过硼酸钠*	-	0.005
XI	155	过硼酸钠*	7632-04-4	0.005
XII	156	2-(2H-苯并三唑-2-基)-4,6-二叔戊基苯酚 (UV-328)	25973-55-1	0.050



Unless otherwise agreed in writing, this document is issued by the Company subject to its General Conditions of Service printed overleaf, available on request or accessible at <http://www.sgs.com/en/Terms-and-Conditions.aspx> and, for electronic format documents, subject to Terms and Conditions for Electronic Documents at <http://www.sgs.com/en/Terms-and-Conditions/Terms-e-Documents.aspx>. Attention is drawn to the limitation of liability, indemnification and jurisdiction issues defined therein. Any holder of this document is advised that information contained hereon reflects the Company's findings at the time of its intervention only and within the limits of Client's instructions, if any. The Company's sole responsibility is to its Client and this document does not exonerate parties to a transaction from exercising all their rights and obligations under the transaction documents. This document cannot be reproduced except in full, without prior written approval of the Company. Any unauthorized alteration, forgery or falsification of the content or appearance of this document is unlawful and offenders may be prosecuted to the fullest extent of the law. Unless otherwise stated the results shown in this test report refer only to the sample(s) tested.

Attention: To check the authenticity of testing / inspection report & certificate, please contact us at telephone: (86-755) 8307 1443, or email: CN.Doccheck@sgs.com

Room 101-901, Plant 4 & Room 101, Plant 2 & Room 101, Plant 3 & Room 301-501, Plant 3, Jianghao (Bantian) Industrial Plant Area, No. 430, Jihua Road, Bantian Community, Bantian Street, Longgang District, Shenzhen, Guangdong, China 518129 www.sgs.com
 中国·广东·深圳市龙岗区坂田街道坂田社区吉华路430号江豪(坂田)工业区厂房4号101-901、2号101、3号101、3号301-501 邮编:518129 t:(86-755) 25328888 sgs.china@sgs.com

批次	序号	物质名称	CAS No.	RL (%)
XII	157	2-苯并三唑-2-基-4,6-二叔丁基苯酚(UV-320)	3846-71-7	0.050
XII	158	二正辛基-双(2-乙基己基巯基乙酸酯)锡(DOTE)	15571-58-1	0.050
XII	159	氟化镉*	7790-79-6	0.005
XII	160	硫酸镉*	10124-36-4 /31119-53-6	0.005
XII	161	二正辛基-双(2-乙基己基巯基乙酸酯)锡(DOTE)和单辛基-三(2-乙基己基巯基乙酸酯)锡(MOTE)的反应物	-	0.050
XIII	162	1,2-苯二甲酸, 二(C6-10)烷基酯 / 1,2-苯二甲酸, 混合二己二辛二癸酯, 其中邻苯二甲酸二己酯含量≥0.3%	-	0.050
XIII	163	5-二叔丁基-2-(2,4-二甲基环己-3-烯-1-基)-5-甲基-1,3-二恶烷[1], 5-二叔丁基-2-(4,6-二甲基环己-3-烯-1-基)-5-甲基-1,3-二恶烷[2] [任何[1]和[2]或者其任意组合的单独异构体或其任何组合]	-	0.050
XIV	164	1,3-丙磺酸内酯	1120-71-4	0.050
XIV	165	2,4-二叔丁基-6-(5-氯苯并三唑-2-基)苯酚(UV-327)	3864-99-1	0.050
XIV	166	2-(2H-苯并三唑-2-基)-4-(叔丁基)-6-(仲丁基)苯酚(UV-350)	36437-37-3	0.050
XIV	167	硝基苯	98-95-3	0.050
XIV	168	全氟壬酸及其钠盐和铵盐	-	0.050
XV	169	苯并(a)芘	50-32-8	0.050
XVI	170	4,4'-异亚丙基联苯酚(双酚 A)	80-05-7	0.050
XVI	171	4-庚基(支链与直链)苯酚	-	0.050
XVI	172	全氟癸酸(PFDA)及其钠盐和铵盐	-	0.050
XVI	173	对叔戊基苯酚	80-46-6	0.050
XVII	174	全氟己烷-1-磺酸及其盐	-	0.050
XVIII	175	双(六氯环戊二烯)环辛烷(包含任何顺式与反式同分异构体或其组合)	-	0.050
XVIII	176	苯并蒽(BaA)	56-55-3	0.050
XVIII	177	硝酸镉*	10325-94-7	0.005
XVIII	178	碳酸镉*	513-78-0	0.005
XVIII	179	氢氧化镉*	21041-95-2	0.005
XVIII	180	屈(CHR)	218-01-9	0.050
XVIII	181	1,3,4-噻二唑-2,5-二硫酮、甲醛与支链和直链4-庚基苯酚的反应产物(RP-HP)[含有支链和直链4-庚基苯酚重量比≥0.1%]	-	0.050
XIX	182	1,2,4-苯三酸酐(偏苯三酸酐)(TMA)	552-30-7	0.050
XIX	183	苯并(g,h,i)芘(二萘嵌苯)(BPE)	191-24-2	0.050
XIX	184	十甲基环五硅氧烷(D5)	541-02-6	0.050
XIX	185	邻苯二甲酸二环己酯(DCHP)	84-61-7	0.050
XIX	186	氧化硼钠*	12008-41-2	0.005



Unless otherwise agreed in writing, this document is issued by the Company subject to its General Conditions of Service printed overleaf, available on request or accessible at <http://www.sgs.com/en/Terms-and-Conditions.aspx> and, for electronic format documents, subject to Terms and Conditions for Electronic Documents at <http://www.sgs.com/en/Terms-and-Conditions/Terms-e-Documents.aspx>. Attention is drawn to the limitation of liability, indemnification and jurisdiction issues defined therein. Any holder of this document is advised that information contained hereon reflects the Company's findings at the time of its intervention only and within the limits of Client's instructions, if any. The Company's sole responsibility is to its Client and this document does not exonerate parties to a transaction from exercising all their rights and obligations under the transaction documents. This document cannot be reproduced except in full, without prior written approval of the Company. Any unauthorized alteration, forgery or falsification of the content or appearance of this document is unlawful and offenders may be prosecuted to the fullest extent of the law. Unless otherwise stated the results shown in this test report refer only to the sample(s) tested.

Attention: To check the authenticity of testing / inspection report & certificate, please contact us at telephone: (86-755) 8307 1443, or email: CN.Doccheck@sgs.com
 Room 101-901, Plant 4 & Room 101, Plant 2 & Room 101, Plant 3 & Room 301-501, Plant 3, Jianghao (Bantian) Industrial Plant Area, No. 430, Jihua Road, Bantian Community, Bantian Street, Longgang District, Shenzhen, Guangdong, China 518129 www.sgs.com
 中国·广东·深圳市龙岗区坂田街道坂田社区吉华路430号江豪(坂田)工业厂区4号101-901、2号101、3号101、3号301-501 邮编:518129 t:(86-755) 25328888 sgs.china@sgs.com

检测报告
(SVHC)

编号: SZXEC23000888006

日期: 2023年06月13日

第10页, 共13页

批次	序号	物质名称	CAS No.	RL (%)
XIX	187	十二甲基环六硅氧烷(D6)	540-97-6	0.050
XIX	188	乙二胺(EDA)	107-15-3	0.050
XIX	189	铅	7439-92-1	0.005
XIX	190	八甲基环四硅氧烷(D4)	556-67-2	0.050
XIX	191	氯化三联苯	61788-32-7	0.050
XX	192	1,7,7-三甲基-3-(苯基亚甲基)双环[2.2.1]庚-2-酮 (3-亚苄基樟脑)	15087-24-8	0.050
XX	193	4,4'-(1,3-二甲基丁基)二苯酚(1,3-DMBBP)	6807-17-6	0.050
XX	194	苯并(k)荧蒹(BkF)	207-08-9	0.050
XX	195	荧蒹(FLT)	206-44-0	0.050
XX	196	菲(PHE)	85-01-8	0.050
XX	197	芘(PYR)	129-00-0	0.050
XXI	198	2,3,3,3-四氟-2-(七氟丙氧基)丙酸及其盐和酰基 卤化物(包括单体和组合)(HFPO-DA)	-	0.050
XXI	199	2-甲氧基乙基乙酸酯	110-49-6	0.050
XXI	200	4-叔丁基苯酚(PTBP)	98-54-4	0.050
XXI	201	三(4-壬基苯基, 支链和直链)亚磷酸酯 (TNPP)(含≥0.1%的支链和直链 4-壬基苯酚)	-	0.050
XXII	202	2-苄基-2-二甲氨基-4'-吗啉基苯基丁酮	119313-12-1	0.050
XXII	203	2-甲基-1-(4-甲硫基苯基)-2-吗啉基-1-丙酮	71868-10-5	0.050
XXII	204	邻苯二甲酸二异己酯	71850-09-4	0.050
XXII	205	全氟丁烷磺酸及其盐	-	0.050
XXIII	206	1-乙基咪唑	1072-63-5	0.050
XXIII	207	2-甲基咪唑	693-98-1	0.050
XXIII	208	对羟基苯甲酸丁酯	94-26-8	0.050
XXIII	209	双(乙酰丙酮基)二丁基锡**	22673-19-4	0.050
XXIV	210	四乙二醇二甲醚	143-24-8	0.050
XXIV	211	二月桂酸二辛基锡及任何其他二辛基锡双(脂肪 酰氧基)衍生物**	-	0.050
XXV	212	1,4-二氧六环	123-91-1	0.050
XXV	213	二溴新戊二醇(BMP); 三溴新戊醇(TBNPA); 2,3-二溴-1-丙醇(2,3-DBPA)	-	0.050
XXV	214	铃兰醛及其立体异构体	-	0.050
XXV	215	双酚 B	77-40-7	0.050
XXV	216	戊二醛	111-30-8	0.050
XXV	217	中链氯化石蜡(MCCP)	-	0.050
XXV	218	原硼酸钠盐*	13840-56-7	0.005
XXV	219	对十二烷基苯酚及其异构体(PDDP)	-	0.050
XXVI	220	(±)-1,7,7-三甲基-3-[(4-甲基苯基)亚甲基]二环 [2.2.1]庚-2-酮, 包括各个异构体和/或其组合(4- MBC)	-	0.050
XXVI	221	2,2'-亚甲基双-(4-甲基-6-叔丁基苯酚) (DBMC)	119-47-1	0.050



SGS-CSTC Standards Technical Services Co., Ltd.
Shenzhen Branch Testing Center Chemical Laboratory

Unless otherwise agreed in writing, this document is issued by the Company subject to its General Conditions of Service printed overleaf, available on request or accessible at <http://www.sgs.com/en/Terms-and-Conditions.aspx> and, for electronic format documents, subject to Terms and Conditions for Electronic Documents at <http://www.sgs.com/en/Terms-and-Conditions/Terms-e-Documents.aspx>. Attention is drawn to the limitation of liability, indemnification and jurisdiction issues defined therein. Any holder of this document is advised that information contained hereon reflects the Company's findings at the time of its intervention only and within the limits of Client's instructions, if any. The Company's sole responsibility is to its Client and this document does not exonerate parties to a transaction from exercising all their rights and obligations under the transaction documents. This document cannot be reproduced except in full, without prior written approval of the Company. Any unauthorized alteration, forgery or falsification of the content or appearance of this document is unlawful and offenders may be prosecuted to the fullest extent of the law. Unless otherwise stated the results shown in this test report refer only to the sample(s) tested.

Attention: To check the authenticity of testing/inspection report & certificate, please contact us at telephone: (86-755) 8307 1443, or email: CN.Doccheck@sgs.com

Room 101-901, Plant 4 & Room 101, Plant 2 & Room 101, Plant 3 & Room 301-501, Plant 3, Jianghao (Bantian) Industrial Plant Area, No. 430, Jihua Road, Bantian Community, Bantian Street, Longgang District, Shenzhen, Guangdong, China 518129 www.sgs.com
中国·广东·深圳市龙岗区坂田街道坂田社区吉华路430号江豪(坂田)工业区厂房4号101-901、2号101、3号101、3号301-501 邮编:518129 t:(86-755) 25328888 sgs.china@sgs.com

检测报告
(SVHC)

编号: SZXEC23000888006

日期: 2023年06月13日

第11页, 共13页

批次	序号	物质名称	CAS No.	RL (%)
XXVI	222	S-(三环[5.2.1.0' ² .6]癸-3-烯-8(或9)-基) O-(异丙基或异丁基或2-乙基己基) O-(异丙基或异丁基或2-乙基己基)二硫代磷酸酯	255881-94-8	0.050
XXVI	223	乙烯基-三(2-甲氧基乙氧基)硅烷	1067-53-4	0.050
XXVII	224	N-羟甲基丙烯酰胺	924-42-5	0.050
XXVIII	225	1,2-双(2,4,6-三溴苯氧基)乙烷	37853-59-1	0.050
XXVIII	226	四溴双酚A	79-94-7	0.050
XXVIII	227	双酚S	80-09-1	0.050
XXVIII	228	四氧化二硼钡*	13701-59-2	0.005
XXVIII	229	四溴邻苯二甲酸双(2-乙基己基)酯	26040-51-7	0.050
XXVIII	230	对羟基苯甲酸异丁酯	4247-02-3	0.050
XXVIII	231	三聚氰胺	108-78-1	0.050
XXVIII	232	全氟庚酸及其盐类	-	0.050
XXVIII	233	全氟异丙基吗啉和全氟丙基吗啉混合物*	-	0.050
/	234	双(4-氯苯基)砒	80-07-9	0.050
/	235	二苯基(2,4,6-三甲基苯甲酰基)氧化膦	75980-60-8	0.050
/	236	间苯二酚	108-46-3	0.050



Unless otherwise agreed in writing, this document is issued by the Company subject to its General Conditions of Service printed overleaf, available on request or accessible at <http://www.sgs.com/en/Terms-and-Conditions.aspx> and, for electronic format documents, subject to Terms and Conditions for Electronic Documents at <http://www.sgs.com/en/Terms-and-Conditions/Terms-e-Documents.aspx>. Attention is drawn to the limitation of liability, indemnification and jurisdiction issues defined therein. Any holder of this document is advised that information contained hereon reflects the Company's findings at the time of its intervention only and within the limits of Client's instructions, if any. The Company's sole responsibility is to its Client and this document does not exonerate parties to a transaction from exercising all their rights and obligations under the transaction documents. This document cannot be reproduced except in full, without prior written approval of the Company. Any unauthorized alteration, forgery or falsification of the content or appearance of this document is unlawful and offenders may be prosecuted to the fullest extent of the law. Unless otherwise stated the results shown in this test report refer only to the sample(s) tested.

Attention: To check the authenticity of testing /inspection report & certificate, please contact us at telephone: (86-755) 8307 1443, or email: CN.Doccheck@sgs.com

SGS-CSTC Standards Technical Services Co., Ltd.
Shenzhen Branch Testing Center Chemical Laboratory

Room 101-901, Plant 4 & Room 101, Plant 2 & Room 101, Plant 3 & Room 301-501, Plant 3, Jianghao (Bantian) Industrial Plant Area, No. 430, Jihua Road, Bantian Community, Bantian Street, Longgang District, Shenzhen, Guangdong, China 518129 www.sgs.com.cn
中国·广东·深圳市龙岗区坂田街道坂田社区吉华路430号江灏(坂田)工业区厂房4号101-901、2号101、3号301-501 邮编:518129 t:(86-755) 25328888 sgs.china@sgs.com

附件

检测流程图

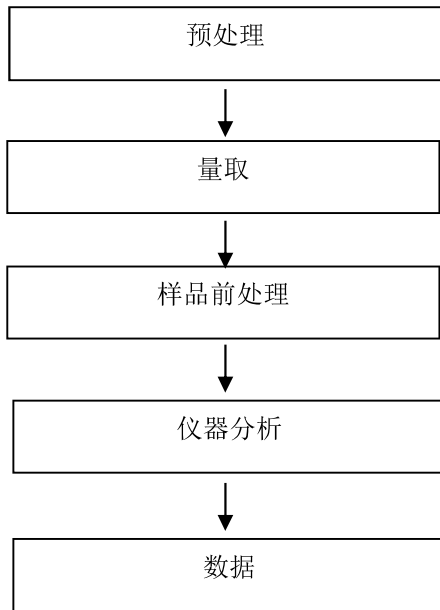

Unless otherwise agreed in writing, this document is issued by the Company subject to its General Conditions of Service printed overleaf, available on request or accessible at <http://www.sgs.com/en/Terms-and-Conditions.aspx> and, for electronic format documents, subject to Terms and Conditions for Electronic Documents at <http://www.sgs.com/en/Terms-and-Conditions/Terms-e-Documents.aspx>. Attention is drawn to the limitation of liability, indemnification and jurisdiction issues defined therein. Any holder of this document is advised that information contained hereon reflects the Company's findings at the time of its intervention only and within the limits of Client's instructions, if any. The Company's sole responsibility is to its Client and this document does not exonerate parties to a transaction from exercising all their rights and obligations under the transaction documents. This document cannot be reproduced except in full, without prior written approval of the Company. Any unauthorized alteration, forgery or falsification of the content or appearance of this document is unlawful and offenders may be prosecuted to the fullest extent of the law. Unless otherwise stated the results shown in this test report refer only to the sample(s) tested.

Attention: To check the authenticity of testing /inspection report & certificate, please contact us at telephone: (86-755) 8307 1443, or email: CN.Doccheck@sgs.com

SGS-CSTC Standards Technical Services Co., Ltd.
Shenzhen Branch Testing Center-Chemical Laboratory

Room 101-901, Plant 4 & Room 101, Plant 2 & Room 101, Plant 3 & Room 301-501, Plant 3, Jianghao (Bantian) Industrial Plant Area, No. 430, Jihua Road, Bantian Community, Bantian Street, Longgang District, Shenzhen, Guangdong, China 518129 [www.sgs.com.cn](http://www.sgs.com)
中国·广东·深圳市龙岗区坂田街道坂田社区吉华路430号江灏(坂田)工业厂区厂房4号101-901、2号101、3号101、3号301-501 邮编:518129 t:(86-755) 25328888 sgs.china@sgs.com

检测报告 (SVHC)

编号: SZXEC23000888006

日期: 2023年06月13日

第 13 页, 共 13 页

样品照片:



此照片仅限于随 SGS 正本报告使用
报告结束



Unless otherwise agreed in writing, this document is issued by the Company subject to its General Conditions of Service printed overleaf, available on request or accessible at <http://www.sgs.com/en/Terms-and-Conditions.aspx> and, for electronic format documents, subject to Terms and Conditions for Electronic Documents at <http://www.sgs.com/en/Terms-and-Conditions/Terms-e-Documents.aspx>. Attention is drawn to the limitation of liability, indemnification and jurisdiction issues defined therein. Any holder of this document is advised that information contained hereon reflects the Company's findings at the time of its intervention only and within the limits of Client's instructions, if any. The Company's sole responsibility is to its Client and this document does not exonerate parties to a transaction from exercising all their rights and obligations under the transaction documents. This document cannot be reproduced except in full, without prior written approval of the Company. Any unauthorized alteration, forgery or falsification of the content or appearance of this document is unlawful and offenders may be prosecuted to the fullest extent of the law. Unless otherwise stated the results shown in this test report refer only to the sample(s) tested.

Attention: To check the authenticity of testing /inspection report & certificate, please contact us at telephone: (86-755) 8307 1443, or email: CN.Doccheck@sgs.com

SGS-CSTC Standards Technical Services Co., Ltd.
Shenzhen Branch Testing Center-Chemical Laboratory

Room 101-901, Plant 4 & Room 101, Plant 2 & Room 101, Plant 3 & Room 301-501, Plant 3, Jianghao (Bantian) Industrial Plant Area, No. 430, Jihua Road, Bantian Community, Bantian Street, Longgang District, Shenzhen, Guangdong, China 518129 www.sgs.com
中国·广东·深圳市龙岗区坂田街道坂田社区吉华路430号江灏(坂田)工业区厂房4号101-901、2号101、3号101-501 邮编:518129 t:(86-755) 25328888 sgs.china@sgs.com