



TEST REPORT

FCC ID: 2AFJVHZ-9810

Applicant : Shenzhen Huazeng Technology Co.,Ltd
Address : Floor 2nd,Yinjin Building, District 71,
BaoAn,Shenzhen City,Guangdong,China.

Equipment Under Test (EUT):

Name : Bluetooth Music Bulb
Model : HZ-9810
Trade Name : N/A

Standards : FCC PART 15, SUBPART C : 2015 (Section 15.247)

Report No : T1850905 01

Date of Test : July 22- September 07, 2015

Date of Issue : September 14, 2015

Tset Result : **PASS**

In the configuration tested, the EUT complied with the standards specified above

Authorized Signature

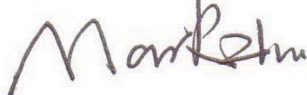

(Mark Zhu)
Manager

The manufacture should ensure that all the products in series production are in conformity with the product sample detailed in this report. If the product in this report is used in any configuration other than that detailed in the report, the manufacturer must ensure the new system complies with all relevant standards. Any mention of Shenzhen Alpha Product Testing Co., Ltd. Or test done by Shenzhen Alpha Product Testing Co., Ltd. Approvals in connection with, distribution or use of the product described in this report must be approved by Shenzhen Alpha Product Testing Co., Ltd. Approvals in writing.

Contents

1. General Information	4
1.1. Description of Device (EUT)	4
1.2. Accessories of device (EUT)	5
1.3. Test Lab information	5
2. Summary of test	6
2.1. Summary of test result	6
2.2. Assistant equipment used for test.....	6
2.3. Block Diagram	7
2.4. Test mode	7
2.5. Test Conditions.....	8
2.6. Measurement Uncertainty (95% confidence levels, k=2)	8
2.7. Test Equipment.....	9
3. Maximum Peak Output power	10
3.1. Limit.....	10
3.2. Test Procedure	10
3.3. Test Setup	10
3.4. Test Result	10
4. Bandwidth	11
4.1. Limit.....	11
4.2. Test Procedure	11
4.3. Test Result	11
5. Carrier Frequency Separation	17
5.1. Limit.....	17
5.2. Test Procedure	17
5.3. Test Result.....	17
6. Number Of Hopping Channel	20
6.1. Limit.....	20
6.2. Test Procedure	20
6.3. Test Result	20
7. Dwell Time	23
7.1. Test limit	23
7.2. Test Procedure.....	23
7.3. Test Results	23
8. Radiated emissions	30
8.1. Limit.....	30
8.2. Block Diagram of Test setup	31
8.3. Test Procedure	32
8.4. Test Result	32
9. Band Edge Compliance	44
9.1. Block Diagram of Test Setup	44
9.2. Limit.....	44
9.3. Test Procedure	44
9.4. Test Result	44

10. Power Line Conducted Emissions	63
10.1. Block Diagram of Test Setup	63
10.2. Limit.....	63
10.3. Test Procedure	63
10.4. Test Result.....	64
11. Antenna Requirements.....	66
11.1. Limit.....	66
11.2. Result.....	66
12. Test setup photo	67
12.1. Photos of Radiated emission	67
12.2. Photos of Conducted Emission test.....	68
13. Photos of EUT	69

1. General Information

1.1. Description of Device (EUT)

EUT	:	Bluetooth Music Bulb
Model No.	:	HZ-9810
DIFF	:	N/A
Trade mark	:	N/A
Power supply	:	AC 100-240V, 50/60Hz
Radio Technology	:	Bluetooth 2.1+EDR
Operation frequency	:	2402-2480MHz
Modulation	:	GFSK, $\pi/4$ DQPSK, 8- DPSK
Antenna Type	:	Integrated Antenna, max gain 0Bi.
Adapter	:	N/A
Applicant	:	Shenzhen Huazeng Technology Co.,Ltd
Address	:	Floor 2nd, Yinjin Building, District 71, BaoAn, Shenzhen City, Guangdong, China.
Manufacturer	:	Shenzhen Huazeng Technology Co.,Ltd
Address	:	Floor 2nd, Yinjin Building, District 71, BaoAn, Shenzhen City, Guangdong, China.

1.2. Accessories of device (EUT)

Accessories : NIL

Type : NIL

1.3. Test Lab information

Shenzhen Alpha Product Testing Co., Ltd.

2F, Building B, East Area of Nanchang Second Industrial Zone,
Gushu 2nd Road, Bao'an District, Shenzhen 518126, P.R. China

FCC Registered No.: 203110

2. Summary of test

2.1. Summary of test result

Description of Test Item	Standard	Results
Maximum Peak Output Power	FCC Part 15: 15.247(b)(1) ANSI C63.4 :2014	PASS
Bandwidth	FCC Part 15: 15.215 ANSI C63.4 :2014	PASS
Carrier Frequency Separation	FCC Part 15: 15.247(a)(1) ANSI C63.4 :2014	PASS
Number Of Hopping Channel	FCC Part 15: 15.247(a)(1)(iii) ANSI C63.4 :2014	PASS
Dwell Time	FCC Part 15: 15.247(a)(1)(iii) ANSI C63.4 :2014	PASS
Radiated Emission	FCC Part 15: 15.209 FCC Part 15: 15.247(d) ANSI C63.4 :2014	PASS
Band Edge Compliance	FCC Part 15: 15.247(d) ANSI C63.4 :2014	PASS
Power Line Conducted Emissions	FCC Part 15: 15.207 ANSI C63.4 :2014	PASS
Antenna requirement	FCC Part 15: 15.203	PASS
Note: Test with the test procedure Bluetool.		

2.2. Assistant equipment used for test

Description	:	Notebook
Manufacturer	:	ACER
Model No.	:	ZQT
Remark: FCC DOC approved		

2.3. Block Diagram

1, For radiated emissions test: EUT was placed on a turn table, which is 0.8 meter high above ground. EUT was be set into BT test mode by software before test.

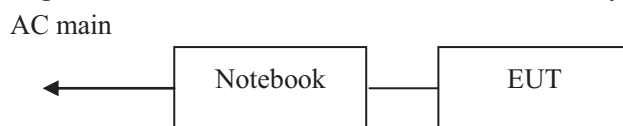

2, For Power Line Conducted Emissions Test: EUT was connected to notebook by 0.6m USB line

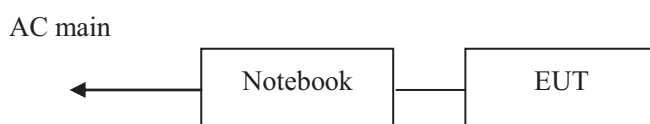

2.4. Test mode

The test software was used to control EUT work in Continuous TX mode, and select test channel, wireless mode.

Tested mode, channel, and data rate information		
Mode	Channel	Frequency (MHz)
GFSK	Low :CH1	2402
	Middle: CH40	2441
	High: CH79	2480

Tested mode, channel, and data rate information		
Mode	Channel	Frequency (MHz)
$\pi/4$ DQPSK	Low :CH1	2402
	Middle: CH40	2441
	High: CH79	2480

Tested mode, channel, and data rate information		
Mode	Channel	Frequency (MHz)
8- DPSK	Low :CH1	2402
	Middle: CH40	2441
	High: CH79	2480

2.5. Test Conditions

Temperature range	21-25°C
Humidity range	40-75%
Pressure range	86-106kPa

2.6. Measurement Uncertainty (95% confidence levels, k=2)

Item	MU	Remark
Uncertainty for Power point Conducted Emissions Test	2.42dB	
Uncertainty for Radiation Emission test in 3m chamber (below 30MHz)	2.13 dB	Polarize: V
	2.57dB	Polarize: H
Uncertainty for Radiation Emission test in 3m chamber (30MHz to 1GHz)	3.54dB	Polarize: V
	4.1dB	Polarize: H
Uncertainty for Radiation Emission test in 3m chamber (1GHz to 25GHz)	2.08dB	Polarize: H
	2.56dB	Polarize: V
Uncertainty for radio frequency	1×10^{-9}	
Uncertainty for conducted RF Power	0.65dB	
Uncertainty for temperature	0.2°C	
Uncertainty for humidity	1%	
Uncertainty for DC and low frequency voltages	0.06%	

2.7. Test Equipment

Equipment	Manufacture	Model No.	Serial No.	Cal. Due day	Cal Interval
3m Semi-Anechoic	ETS-LINDGREN	N/A	SEL0017	2016.01.19	1 Year
Spectrum analyzer	Agilent	E4407B	MY49510055	2016.01.19	1 Year
Receiver	R&S	ESCI	101165	2016.01.19	1 Year
Bilog Antenna	SCHWARZBECK	VULB 9168	9168-438	2017.01.21	2 Year
Horn Antenna	SCHWARZBECK	BBHA 9120 D	BBHA 9120 D(1201)	2017.01.21	2 Year
Horn Antenna	SCHWARZBECK	BBHA 9170	BBHA 9170 D(1432)	2017.01.21	2 Year
Active Loop Antenna	Beijing Daze	ZN30900A	SEL0097	2016.01.19	1 Year
Cable	Resenberger	SUCOFLEX 104	MY6562/4	2016.01.19	1 Year
Cable	Resenberger	SUCOFLEX 104	309972/4	2016.01.19	1 Year
Cable	Resenberger	SUCOFLEX 104	329112/4	2016.01.19	1 Year
L.I.S.N.#1	Schwarzbeck	NSLK8126	8126466	2016.01.19	1 Year
L.I.S.N.#2	ROHDE&SCHWARZ	ENV216	101043	2016.01.19	1 Year
Power Meter	Anritsu	ML2487A	6K00001491	2016.01.19	1 Year
Power sensor	Anritsu	ML2491A	32516	2016.01.19	1 Year
Pre-amplifier	SCHWARZBECK	BBV9743	9743-019	2016.01.19	1 Year
Pre-amplifier	Quietek	AP-180C	CHM-0602012	2016.01.19	1 Year

3. Maximum Peak Output power

3.1. Limit

Please refer section 15.247.

For frequency hopping systems operating in the 2400-2483.5 MHz band employing at least 75 non-overlapping hopping channels, and all frequency hopping systems in the 5725-5850 MHz band: 1 watt. For all other frequency hopping systems in the 2400-2483.5 MHz band: 0.125 watts, the e.i.r.p shall not exceed 4W

3.2. Test Procedure

The transmitter output is connected to the RF Power Meter. The RF Power Meter is set to the peak power detection.

3.3. Test Setup

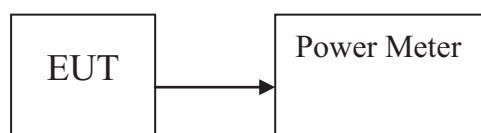

3.4. Test Result

EUT: Bluetooth Music Bulb		M/N: HZ-9810			
Test date: 2015-07-22		Test site: RF site		Tested by: Peter	
Mode	Freq (MHz)	PK Output Power (dBm)	PK Output Power (mW)	Limit (dBm)	Margin (dB)
GFSK	2402	3.65	2.317	21	17.350
	2441	3.54	2.259	21	17.460
	2480	3.57	2.275	21	17.430
$\pi/4$ DQPSK,	2402	2.83	1.919	21	18.170
	2441	2.61	1.824	21	18.390
	2480	2.81	1.910	21	18.190
8- DPSK	2402	2.91	1.954	21	18.090
	2441	2.79	1.901	21	18.210
	2480	2.93	1.963	21	18.070
Conclusion: PASS					

4. Bandwidth

4.1. Limit

Intentional radiators operating under the alternative provisions to the general emission limits, as contained in §§ 15.217 through 15.257 and in Subpart E of this part, must be designed to ensure that the 20 dB bandwidth of the emission, or whatever bandwidth may otherwise be specified in the specific rule section under which the equipment operates, is contained within the frequency band designated in the rule section under which the equipment is operated.

4.2. Test Procedure

Peak detector is used.

The transmitter output was coupled to a spectrum analyzer via a antenna. The bandwidth of the fundamental frequency was measured by spectrum analyzer with 30kHz RBW and 100kHz VBW. The 20dB bandwidth is defined as the total spectrum the power of which is higher than peak power minus 20dB.

4.3. Test Result

EUT: Bluetooth Music Bulb		M/N: HZ-9810		
Test date: 2015-07-22		Test site: RF site	Tested by: Peter	
Mode	Freq (MHz)	20dB Bandwidth (MHz)	Limit (kHz)	Conclusion
GFSK	2402	0.829	/	PASS
	2441	0.834	/	PASS
	2480	0.795	/	PASS
π /4 DQPSK	2402	1.111	/	PASS
	2441	1.110	/	PASS
	2480	1.108	/	PASS
8- DPSK	2402	1.153	/	PASS
	2441	1.160	/	PASS
	2480	1.163	/	PASS

Original Test data For 20dB bandwidth
GFSK:

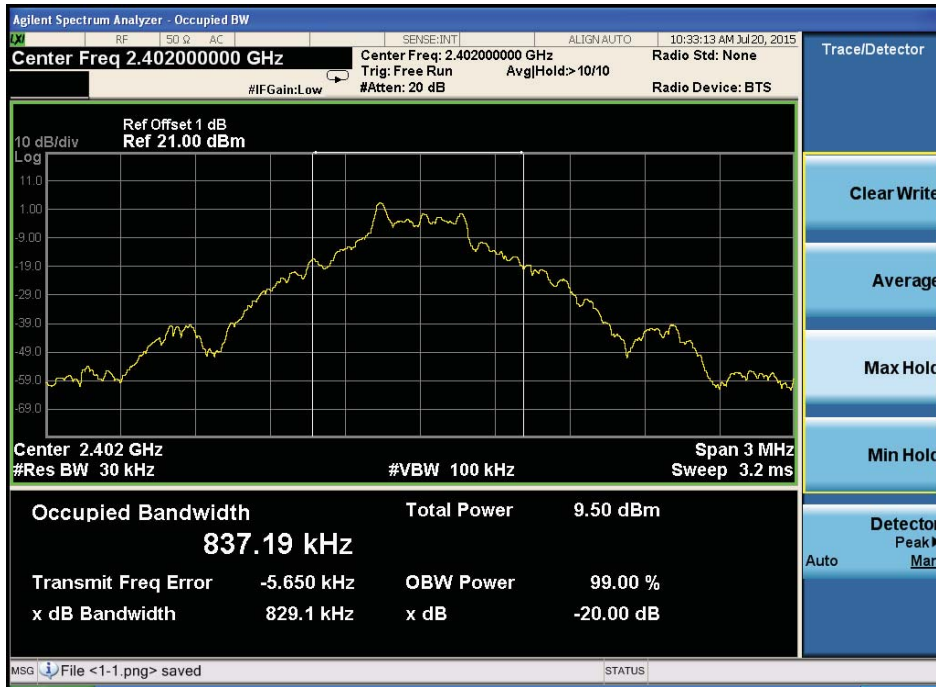



$\pi/4$ DQPSK:

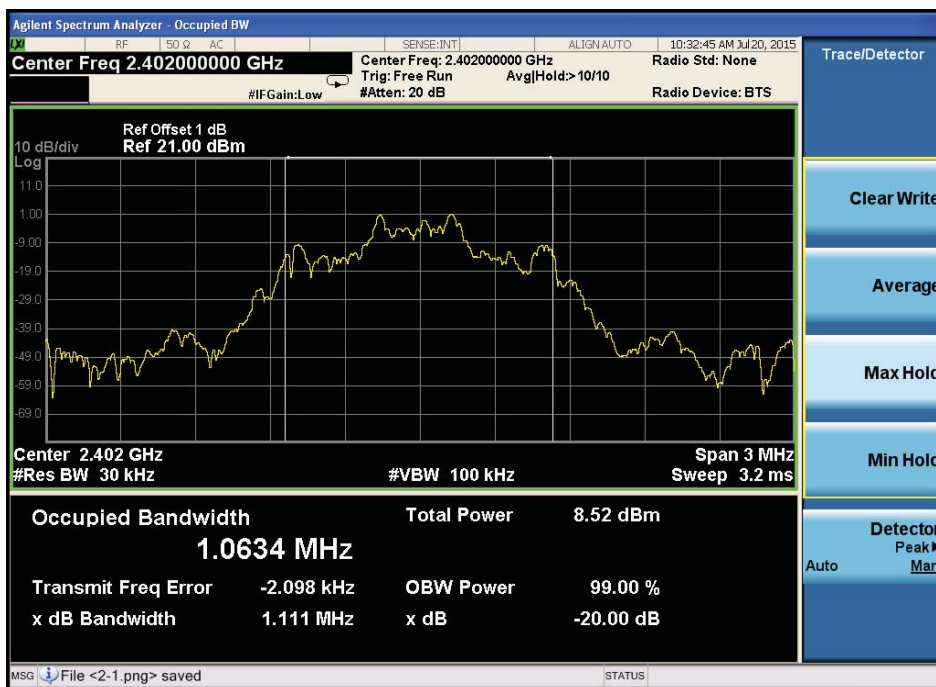

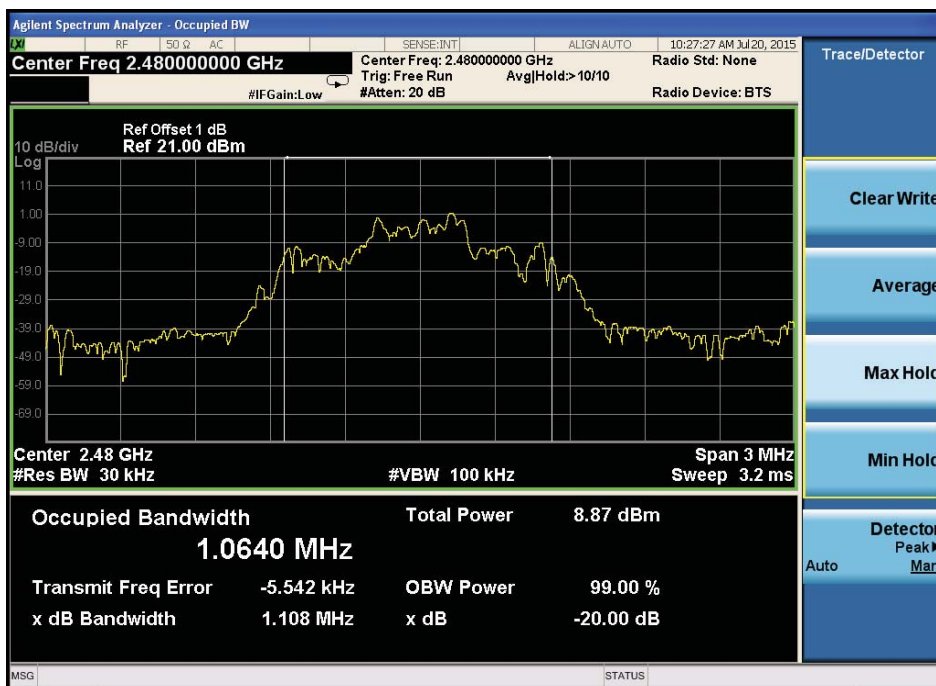
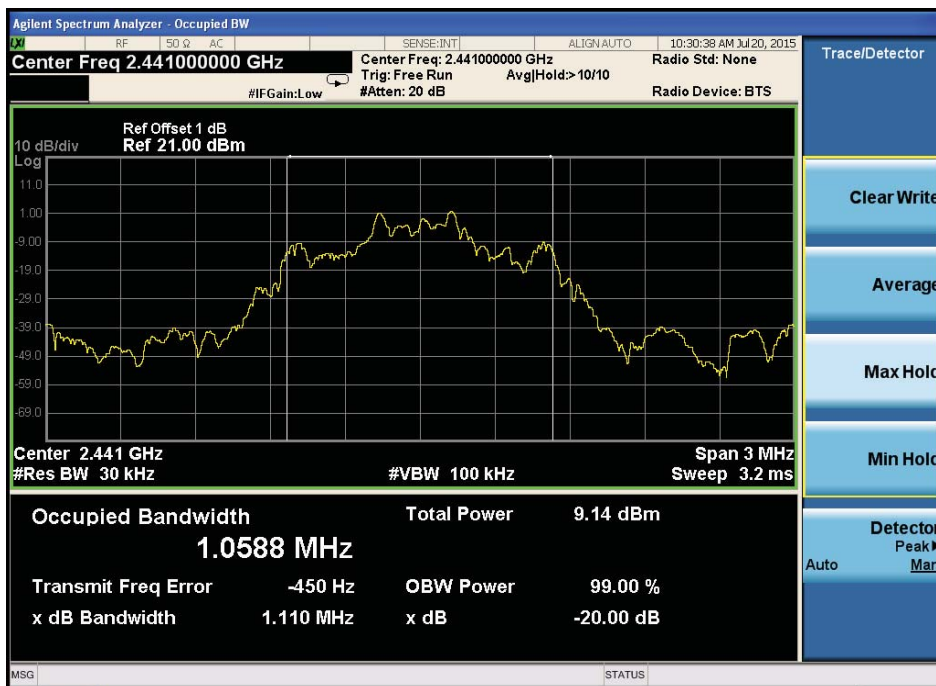

8- DPSK:

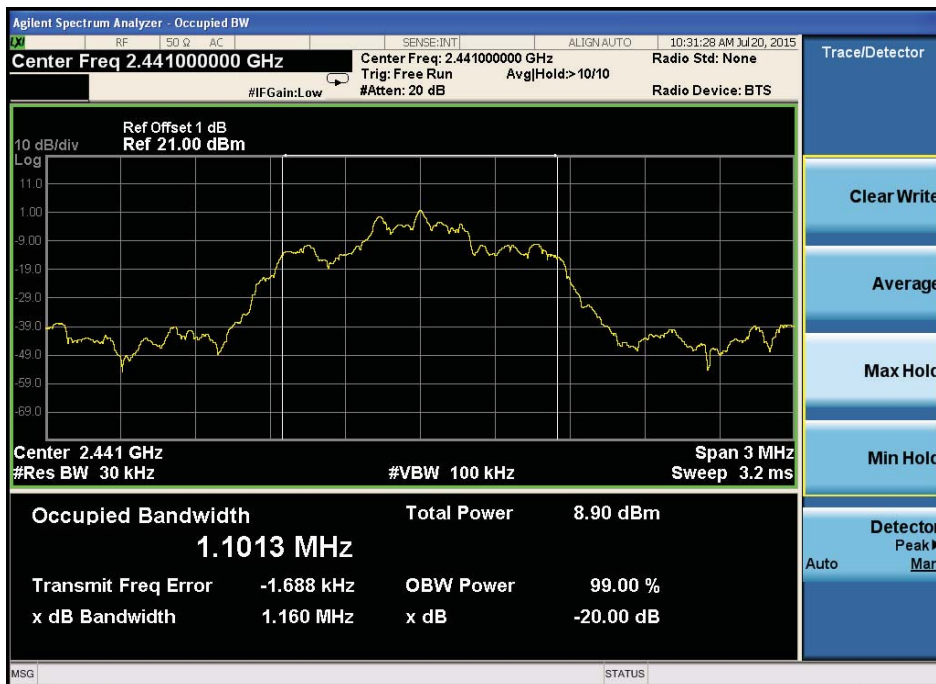
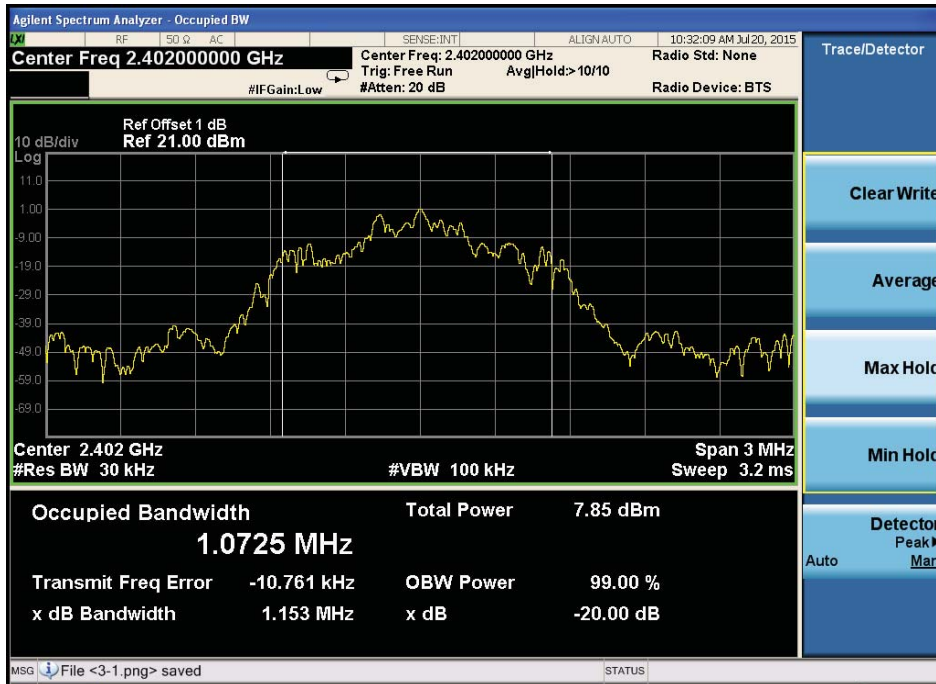

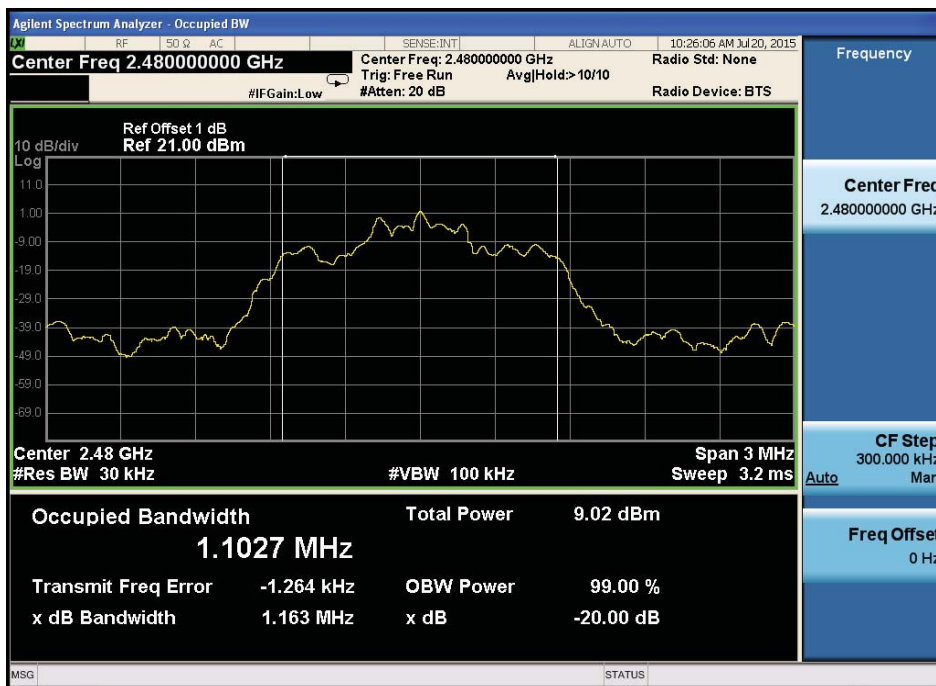

5. Carrier Frequency Separation

5.1. Limit

Frequency hopping systems shall have hopping channel carrier frequencies separated by a minimum of 25 kHz or the 20 dB bandwidth of the hopping channel, whichever is greater. Alternatively, frequency hopping systems operating in the 2400-2483.5 MHz band may have hopping channel carrier frequencies that are separated by 25 kHz or two-thirds of the 20 dB bandwidth of the hopping channel, whichever is greater, provided the systems operate with an output power no greater than 125 mW

5.2. Test Procedure

The transmitter output was coupled to a spectrum analyzer via a antenna. The carrier frequency was measured by spectrum analyzer with 100kHz RBW and 300kHz VBW.

5.3. Test Result

EUT: Bluetooth Music Bulb		M/N: HZ-9810		
Test date: 2015-07-22		Test site: RF site		Tested by: Peter
Mode/Channel	Channel separation (MHz)	20dB Bandwidth (MHz)	Limit (MHz) 2/3 20dB bandwidth	Conclusion
GFSK	1.002	0.834	0.556	PASS
π /4 DQPSK	1.002	1.110	0.740	PASS
8- DPSK	1.002	1.160	0.773	PASS

Original test data for channel separation
GFSK



$\pi/4$ DQPSK



8- DPSK:



6. Number Of Hopping Channel

6.1. Limit

Frequency hopping systems in the 2400-2483.5 MHz band shall use at least 15 channels

6.2. Test Procedure

The transmitter output was coupled to a spectrum analyzer via a antenna. The number of hopping channel was measured by spectrum analyzer with 300kHz RBW and 1MHz VBW.

6.3. Test Result

EUT: Bluetooth Music Bulb		M/N: HZ-9810	
Test date: 2015-07-22		Test site: RF site	Tested by: Peter
Mode	Number of hopping channel	Limit	Conclusion
GFSK	79	>15	PASS
$\pi/4$ DQPSK	79	>15	PASS
8- DPSK	79	>15	PASS

Original test data for hopping channel number
GFSK



$\pi/4$ DQPSK

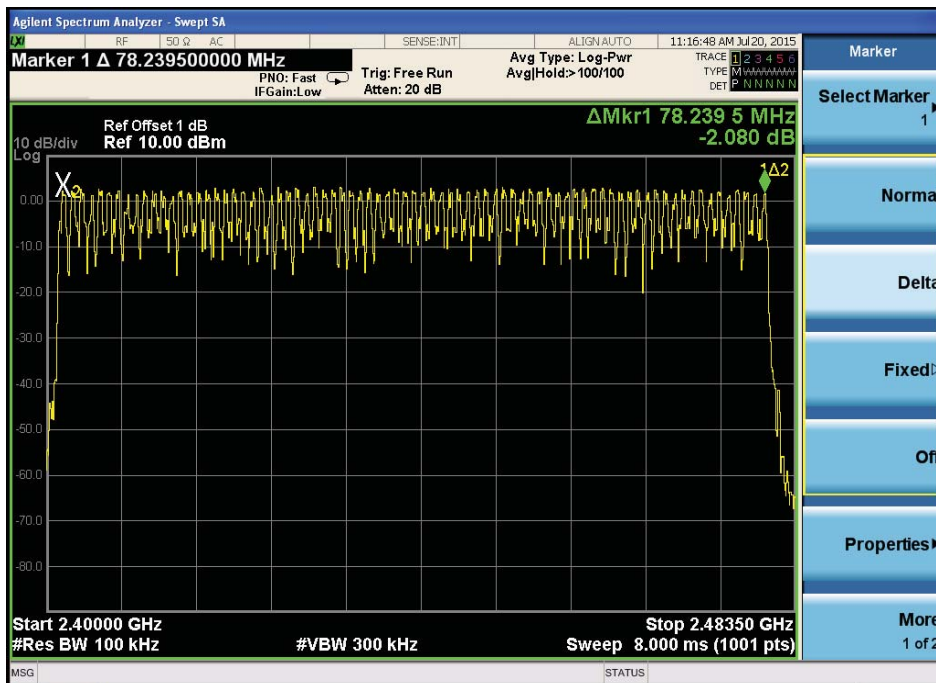

8- DPSK:

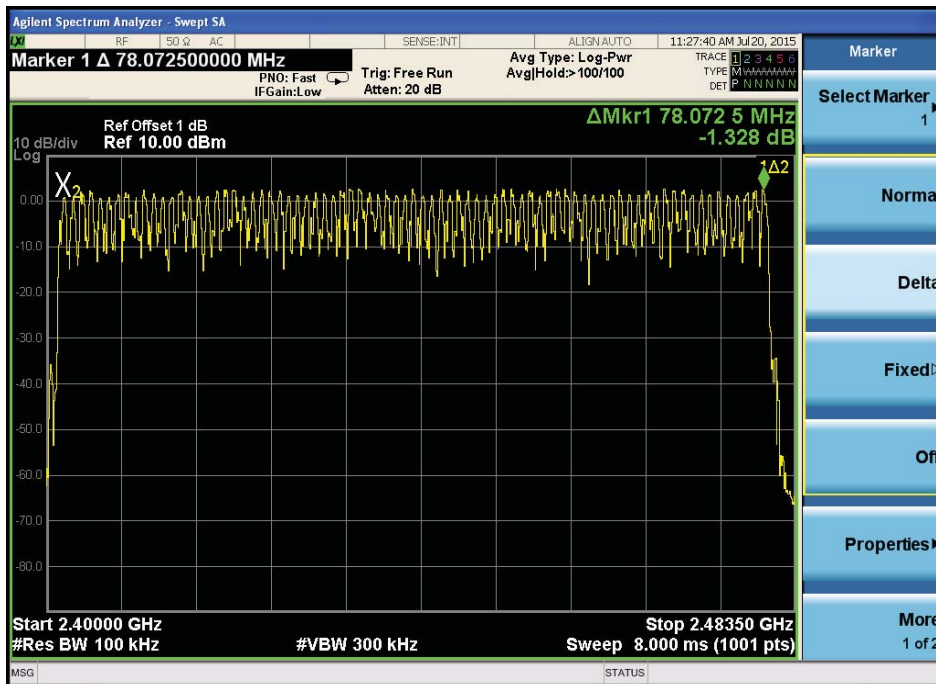

7. Dwell Time

7.1. Test limit

Please refer section 15.247

According to §15.247(a)(1)(iii), Frequency hopping systems operating in the 2400MHz-2483.5 MHz. The average time of occupancy on any frequency shall not greater than 0.4 s within period of 0.4 sec- onds multiplied by the number of hopping channel employed.

7.2. Test Procedure

7.2.1. Place the EUT on the table and set it in transmitting mode.

7.2.2. Remove the antenna from the EUT and then connect a low loss RF cable from the antenna port to the spectrum analyzer.

7.2.3. Set center frequency of spectrum analyzer = operating frequency.

7.2.4. Set the spectrum analyzer as RBW, VBW=1MHz, Span = 0Hz, Sweep = auto.

7.2.5. Repeat above procedures until all frequency measured were complete.

7.3. Test Results

PASS.

Detailed information please see the following page.

EUT: Bluetooth Music Bulb		M/N: HZ-9810				
Test date: 2015-07-22		Test site: RF site		Tested by: Peter		
Mode	Data Packet	Frequency (MHz)	Pulse Duration (ms)	Dwell Time (s)	Limit (s)	Conclusion
GFSK	DH1	2441	0.368	0.236	<0.4	PASS
	DH3	2441	1.624	0.346	<0.4	PASS
	DH5	2441	2.868	0.367	<0.4	PASS
π /4 DQPSK	DH1	2441	0.372	0.238	<0.4	PASS
	DH3	2441	1.628	0.347	<0.4	PASS
	DH5	2441	2.876	0.368	<0.4	PASS
8- DPSK	DH1	2441	0.376	0.241	<0.4	PASS
	DH3	2441	1.628	0.347	<0.4	PASS
	DH5	2441	2.876	0.368	<0.4	PASS

Note: 1 A period time = 0.4 (s) * 79 = 31.6(s)
 2 DH1 time slot = Pulse Duration * (1600/(1*79)) * A period time
 DH3 time slot = Pulse Duration * (1600/(3*79)) * A period time
 DH5 time slot = Pulse Duration * (1600/(5*79)) * A period time

GFSK

DH1:

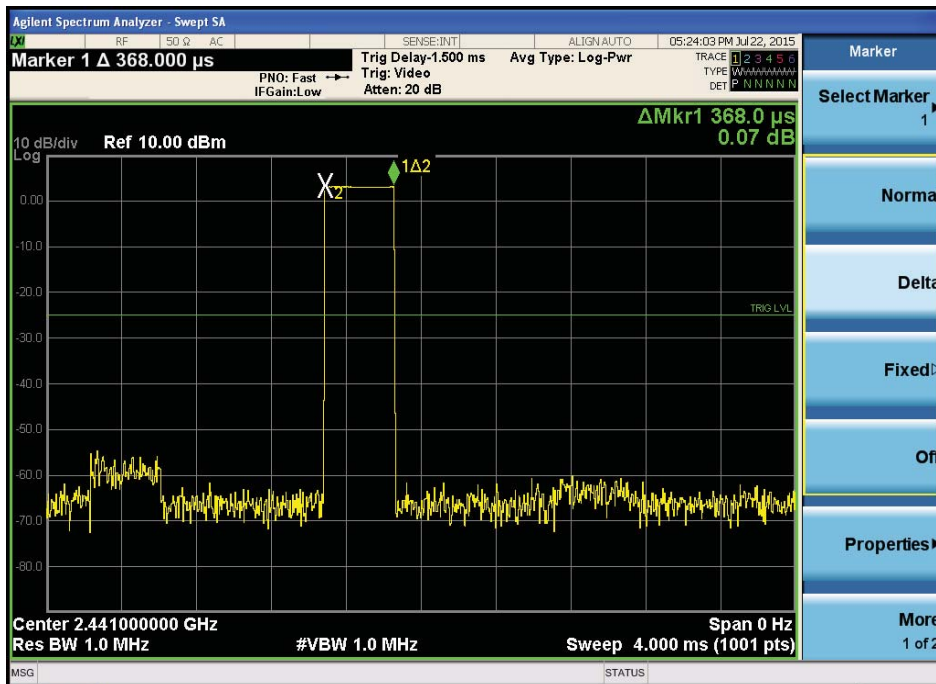

DH3:

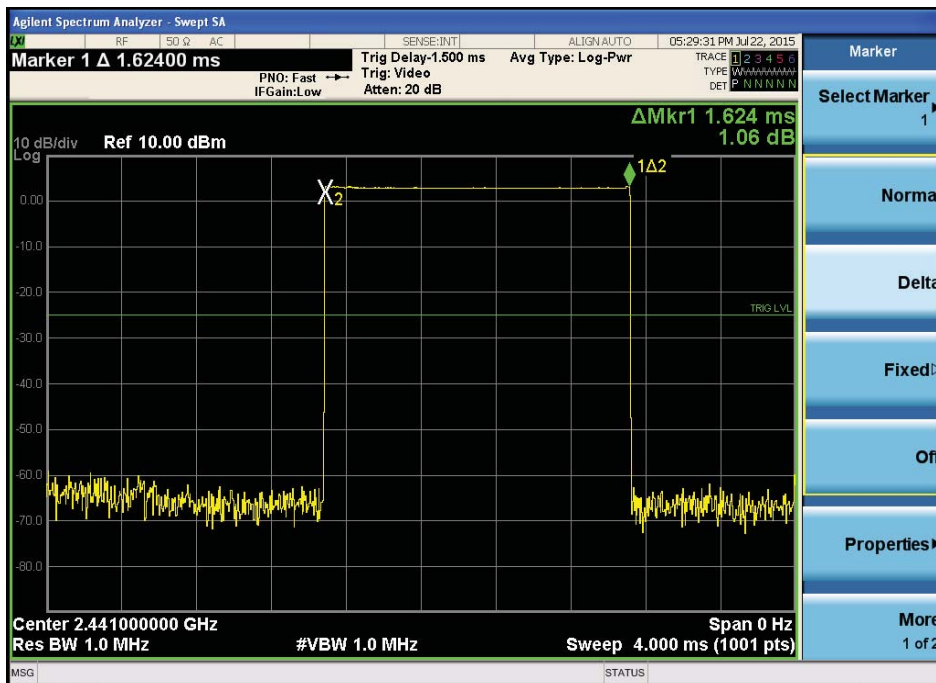

DH5

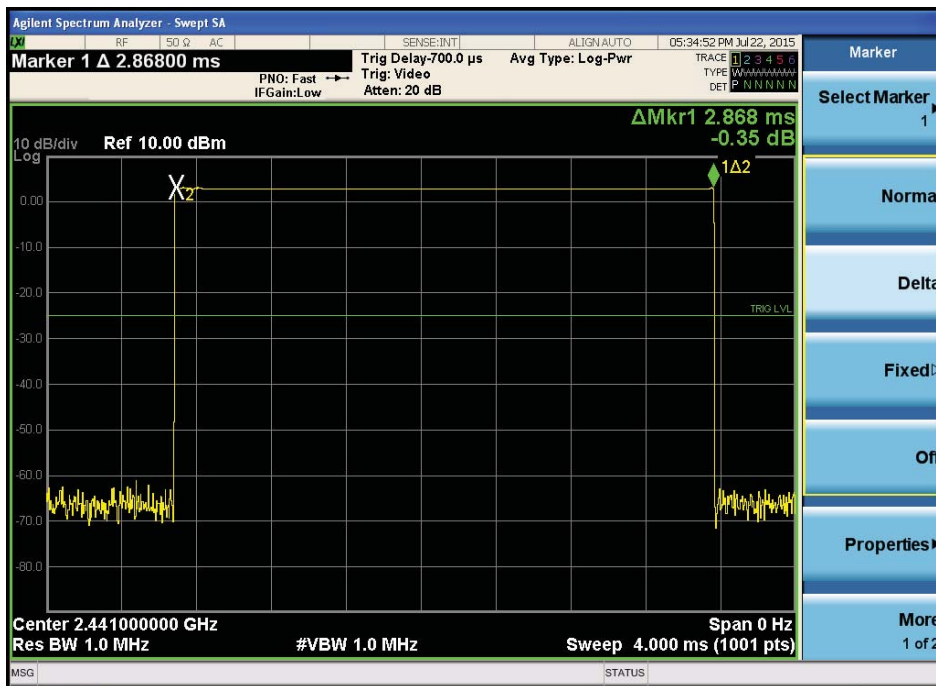

$\pi/4$ DQPSK
DH1

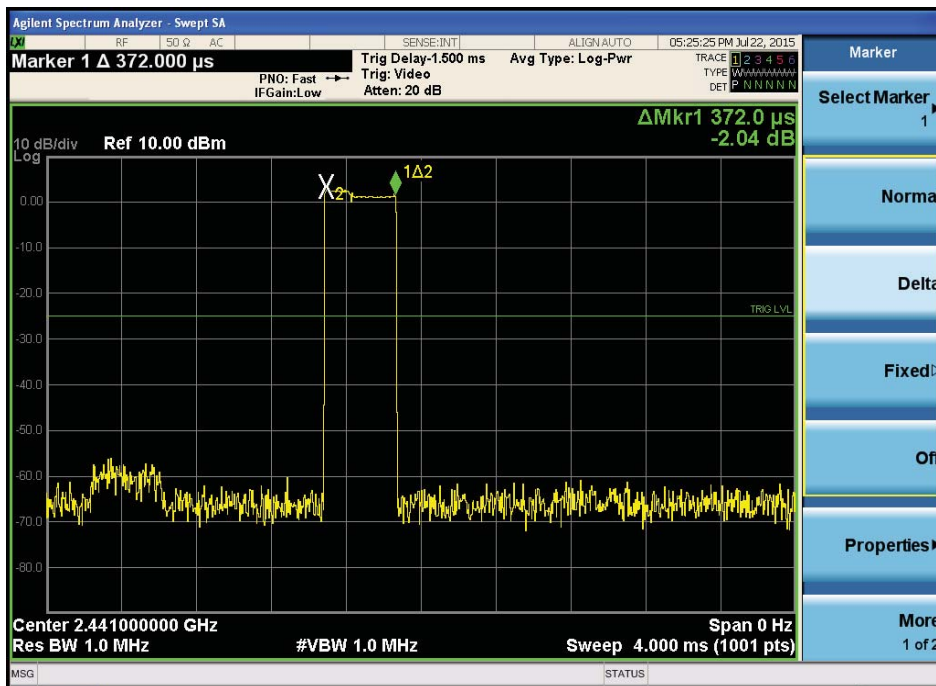

DH3

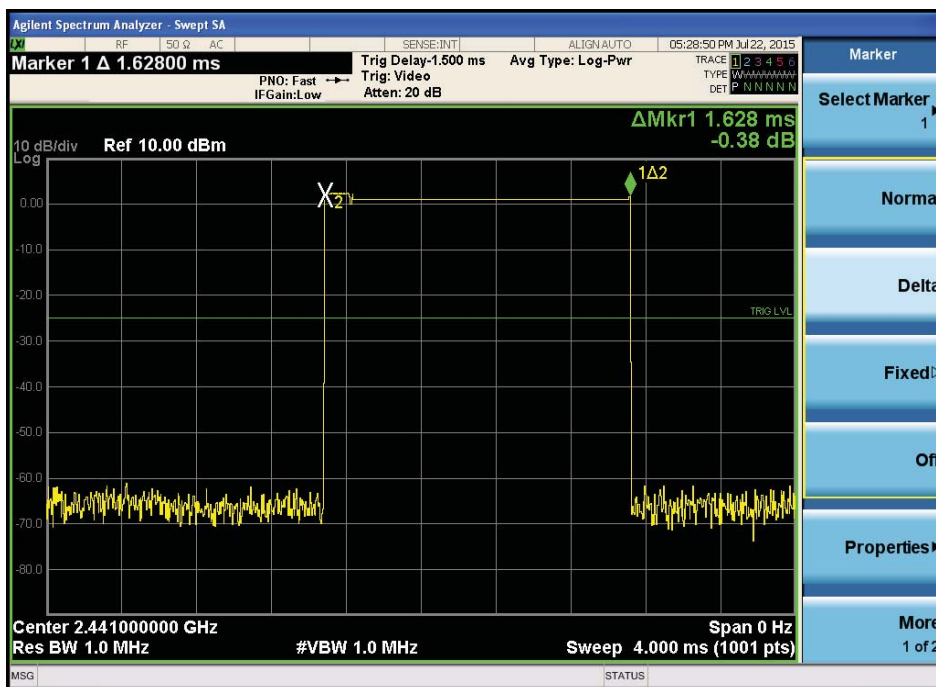

DH5

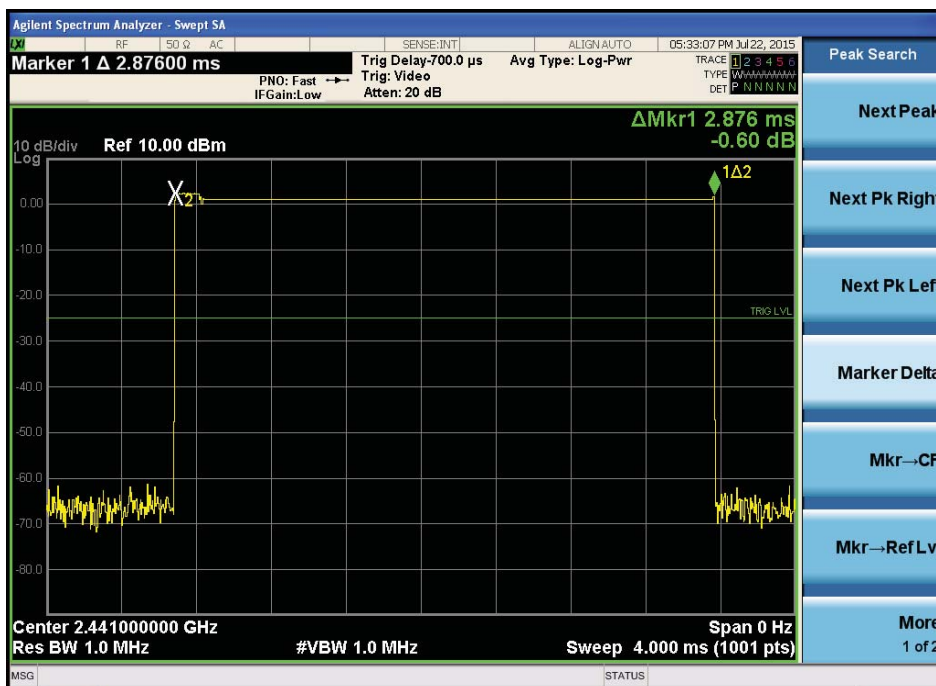

8- DPSK:
DH1

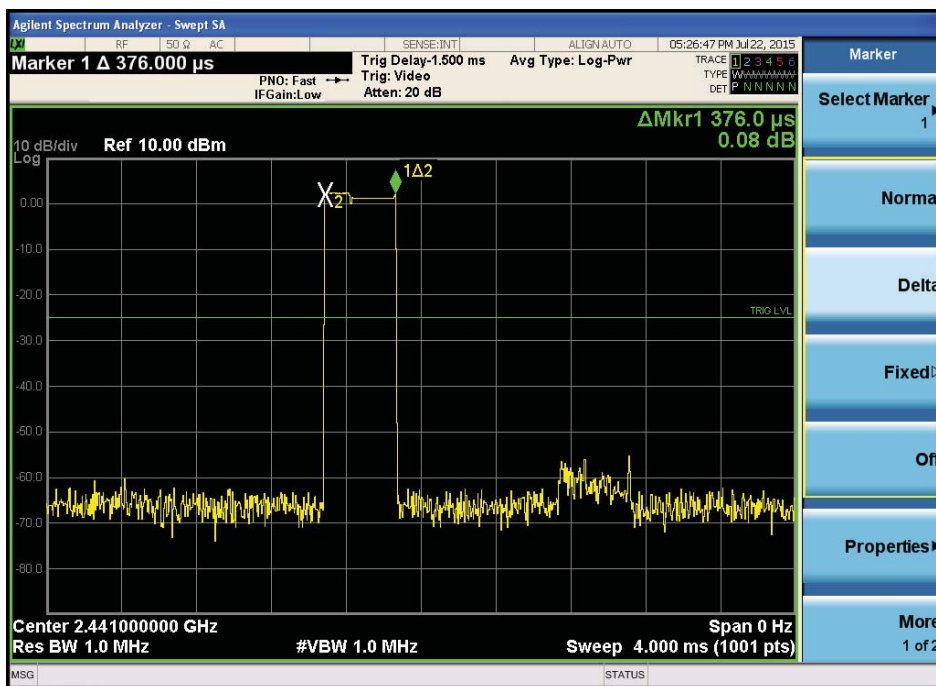

DH3

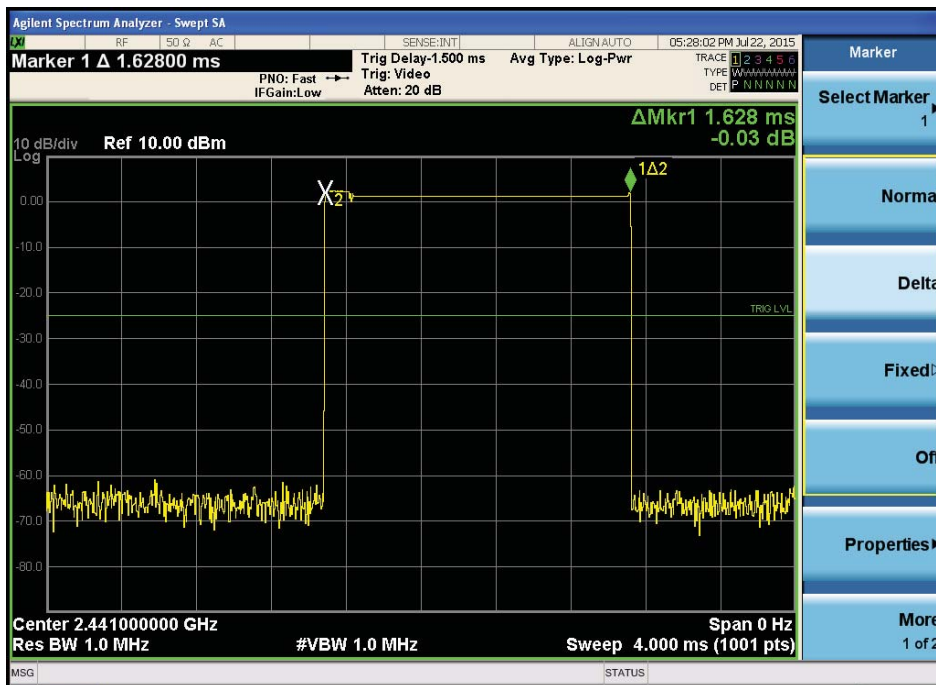

DH5

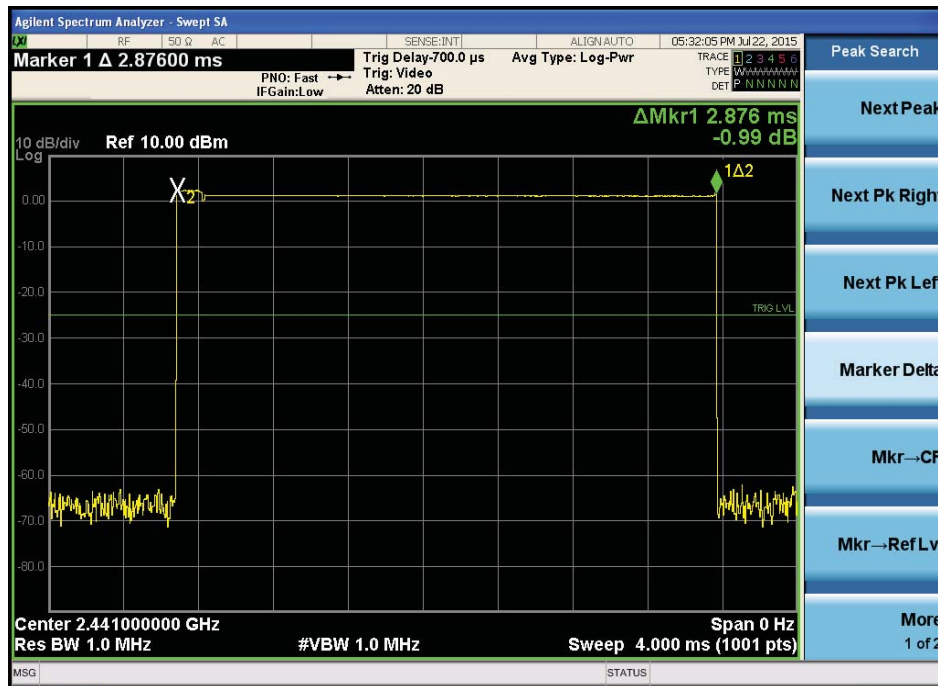

8. Radiated emissions

8.1. Limit

All the emissions appearing within 15.205 restricted frequency bands shall not exceed the limits shown in 15.209, all the other emissions shall be at least 20dB below the fundamental emissions, or comply with 15.209 limits.

15.205 Restricted frequency band

MHz	MHz	MHz	GHz
0.090 - 0.110	16.42 - 16.423	399.9 - 410	4.5 - 5.15
¹ 0.495 - 0.505	16.69475 - 16.69525	608 - 614	5.35 - 5.46
2.1735 - 2.1905	16.80425 - 16.80475	960 - 1240	7.25 - 7.75
4.125 - 4.128	25.5 - 25.67	1300 - 1427	8.025 - 8.5
4.17725 - 4.17775	37.5 - 38.25	1435 - 1626.5	9.0 - 9.2
4.20725 - 4.20775	73 - 74.6	1645.5 - 1646.5	9.3 - 9.5
6.215 - 6.218	74.8 - 75.2	1660 - 1710	10.6 - 12.7
6.26775 - 6.26825	108 - 121.94	1718.8 - 1722.2	13.25 - 13.4
6.31175 - 6.31225	123 - 138	2200 - 2300	14.47 - 14.5
8.291 - 8.294	149.9 - 150.05	2310 - 2390	15.35 - 16.2
8.362 - 8.366	156.52475 - 156.52525	2483.5 - 2500	17.7 - 21.4
8.37625 - 8.38675	156.7 - 156.9	2690 - 2900	22.01 - 23.12
8.41425 - 8.41475	162.0125 - 167.17	3260 - 3267	23.6 - 24.0
12.29 - 12.293	167.72 - 173.2	3332 - 3339	31.2 - 31.8
12.51975 - 12.52025	240 - 285	3345.8 - 3358	36.43 - 36.5
12.57675 - 12.57725	322 - 335.4	3600 - 4400	(²)

15.209 Limit

FREQUENCY MHz	DISTANCE Meters	FIELD STRENGTHS LIMIT	
		$\mu\text{V}/\text{m}$	$\text{dB}(\mu\text{V})/\text{m}$
0.009-0.490	300	2400/F(KHz)	/
0.490-1.705	30	24000/F(KHz)	/
1.705-30	30	30	29.5
30 ~ 88	3	100	40.0
88 ~ 216	3	150	43.5
216 ~ 960	3	200	46.0
960 ~ 1000	3	500	54.0
Above 1000	3	74.0 dB(μV)/m (Peak) 54.0 dB(μV)/m (Average)	

8.2. Block Diagram of Test setup

8.2.1 In 3m Anechoic Chamber Test Setup Diagram for below 1GHz

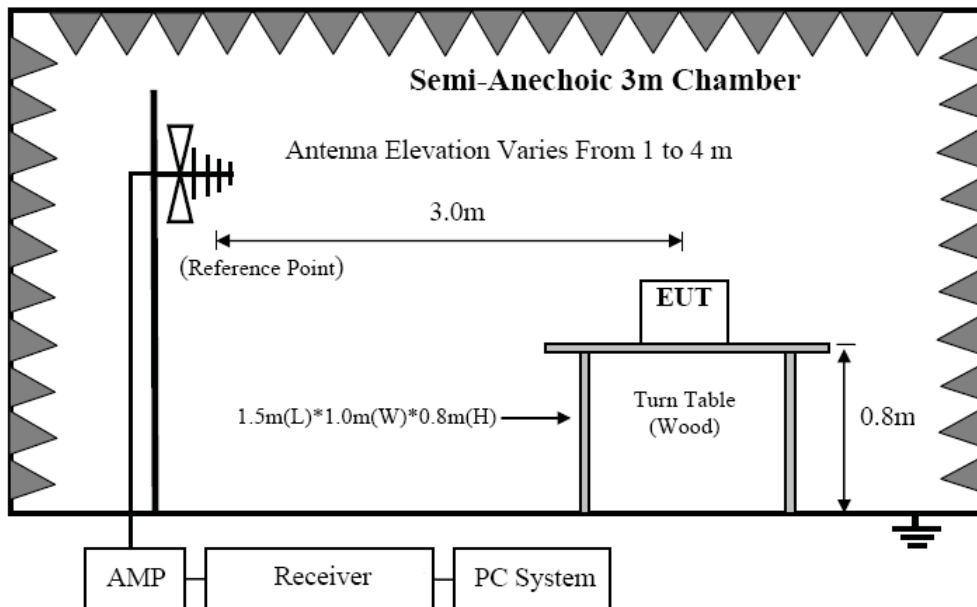

8.2.2 In 3m Anechoic Chamber Test Setup Diagram for frequency above 1GHz

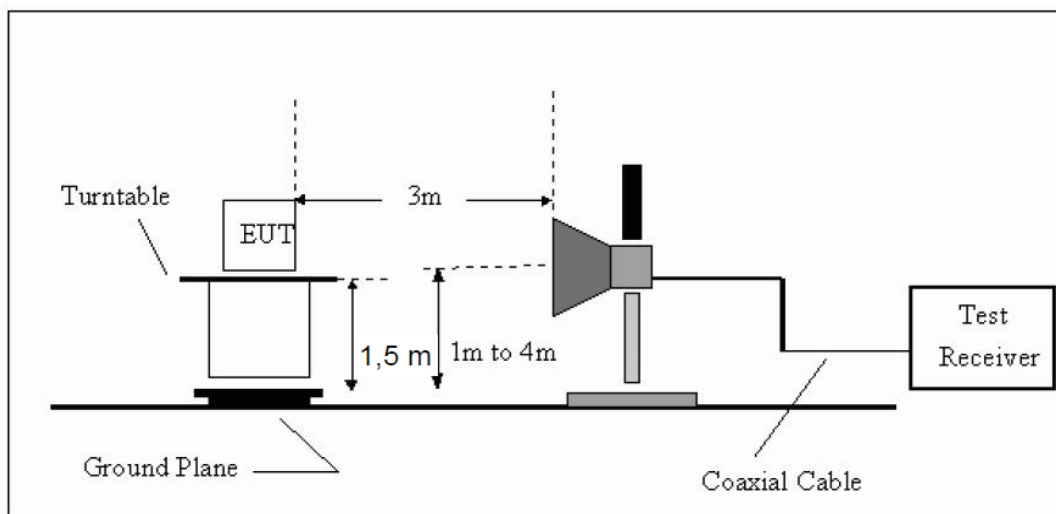

Note: For harmonic emissions test a appropriate high pass filter was inserted in the input port of AMP.

8.3. Test Procedure

- (1) EUT was placed on a non-metallic table, 80 cm above the ground plane inside a semi-anechoic chamber for below 1GHz test, and 150cm above the ground plane for above 1GHz test.
- (2) Setup EUT and simulator as shown in section 1.4 and 6.1
- (3) Test antenna was located 3m from the EUT on an adjustable mast. Below pre-scan procedure was first performed in order to find prominent radiated emissions.
 - (a) Change work frequency or channel of device if practicable.
 - (b) Change modulation type of device if practicable.
 - (c) Rotated EUT though three orthogonal axes to determine the attitude of EUT arrangement produces highest emissions
- (4) Spectrum frequency from 9KHz to 25GHz (tenth harmonic of fundamental frequency) was investigated
- (5) For final emissions measurements at each frequency of interest, the EUT were rotated and the antenna height was varied between 1m and 4m in order to maximize the emission. Measurements in both horizontal and vertical polarities were made and the data was recorded. In order to find the maximum emission, the relative positions of equipments and all of the interface cables were changed according to ANSI C63.4 2014 on Radiated Emission test.
- (6) For emissions above 1GHz, both Peak and Average level were measured with Spectrum Analyzer, and the RBW is set at 1MHz, VBW is set at 3MHz for Peak measure; RBW is set at 1MHz, VBW is set at 10Hz for Average measure.

8.4. Test Result

We have scanned the 10th harmonic from 9KHz to the EUT.
Detailed information please see the following page.

From 9KHz to 30MHz: Conclusion: PASS

Note: The amplitude of spurious emissions which are attenuated by more than 20dB below the permissible value has no need to be reported.

From 30MHz to 1000MHz: Conclusion: PASS

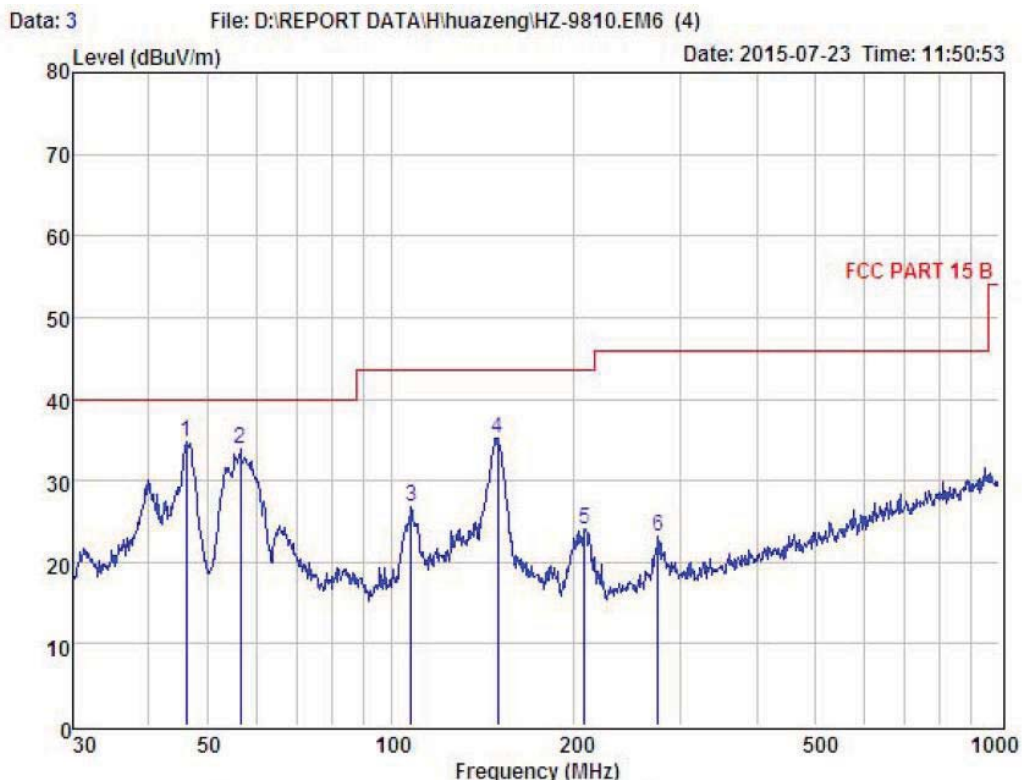

Condition : FCC PART 15 B 3m POL: HORIZONTAL
 EUT :
 Model No : HZ-9810
 Test Mode :
 Power : AC 120V/60Hz
 Test Engineer :
 Remark :
 Temp :
 Hum :

Item	Freq MHz	Read Level dBuV	Antenna Factor dB	Preamp Factor dB	Cable Loss dB	Level dBuV	Limit dBuV	Margin dBuV	Remark
1	46.02	52.86	13.65	31.85	0.06	34.72	40.00	-5.28	Peak
2	56.59	52.46	13.07	31.77	0.16	33.92	40.00	-6.08	Peak
3	107.89	46.83	10.93	31.35	0.44	26.85	43.50	-16.65	Peak
4	150.01	51.86	14.16	31.19	0.39	35.22	43.50	-8.28	Peak
5	207.85	44.52	10.04	30.92	0.49	24.13	43.50	-19.37	Peak
6	275.16	40.96	12.26	30.65	0.53	23.10	46.00	-22.90	Peak

Remark: Level = Read Level + Antenna Factor - Preamp Factor + Cable Loss

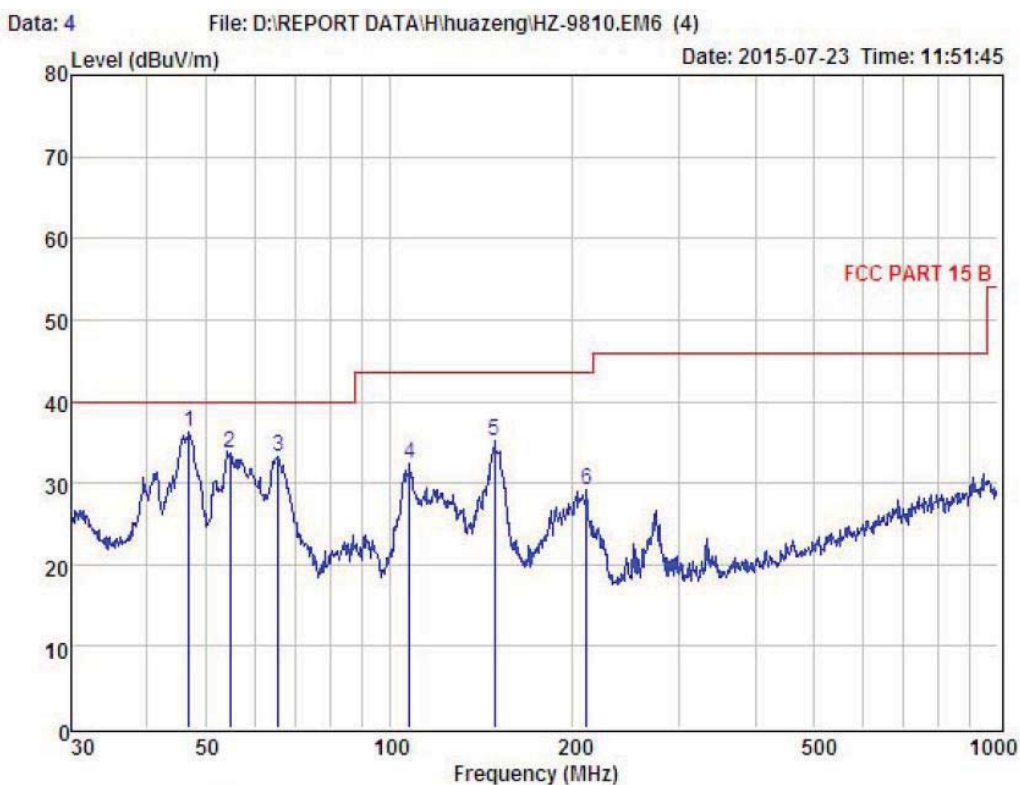

Condition : FCC PART 15 B 3m POL: VERTICAL
 EUI :
 Model No : HZ-9810
 Test Mode :
 Power : AC 120V/60Hz
 Test Engineer :
 Remark :
 Temp :
 Hum :

Item	Freq MHz	Read Level dBuV	Antenna Factor dB	Preamp Factor dB	Cable Loss dB	Level dBuV	Limit dBuV	Margin dBuV	Remark
1	46.83	54.50	13.59	31.83	0.06	36.32	40.00	-3.68	Peak
2	54.83	52.22	13.07	31.79	0.18	33.68	40.00	-6.32	Peak
3	65.80	53.17	11.59	31.73	0.26	33.29	40.00	-6.71	Peak
4	107.89	52.40	10.93	31.35	0.44	32.42	43.50	-11.08	Peak
5	148.96	51.98	14.03	31.19	0.35	35.17	43.50	-8.33	Peak
6	210.79	49.43	10.07	30.91	0.62	29.21	43.50	-14.29	Peak

Remark: Level = Read Level + Antenna Factor - Preamp Factor + Cable Loss

Remark: All modes have been tested, and only worst data of GFSK mode, Channel 2402MHz was listed in this report.

1GHz—25GHz Radiated emission Test result									
EUT: Bluetooth Music Bulb					M/N: HZ-9810				
Power: AC 120V/60Hz									
Test date: 2015-07-22 Test site: 3m Chamber Tested by: Peter									
Test mode: GFSK Tx CH1 2402MHz									
Antenna polarity: Vertical									
No	Freq (MHz)	Read Level (dBuV/m)	Antenna Factor (dB/m)	Cable loss(dB)	Amp Factor (dB)	Result (dBuV/m)	Limit (dBuV/m)	Margin (dB)	Remark
1	4804	42.42	33.95	10.18	34.26	52.29	74	21.71	PK
2	4804	33.04	33.95	10.18	34.26	42.91	54	11.09	AV
3	7206	/							
4	9608	/							
5	12010	/							
Antenna Polarity: Horizontal									
1	4804	43.31	33.95	10.18	34.26	53.18	74	20.82	PK
2	4804	32.25	33.95	10.18	34.26	42.12	54	11.88	AV
3	7206	/							
4	9608	/							
5	12010	/							
Note:									
1, Measuring frequency from 1GHz to 25GHz									
2, Spectrum Set for PK measure: RBW=1MHz, VBW=1MHz, Sweep time=Auto, Detector: PK									
2, Spectrum Set for AV measure: RBW=1MHz, VBW=10Hz, Sweep time=Auto, Detector: PK									
3, Result = Read level + Antenna factor + cable loss-Amp factor									
4, All the other emissions not reported were too low to read and deemed to comply with FCC limit.									

1GHz—25GHz Radiated emission Test result									
EUT: Bluetooth Music Bulb					M/N: HZ-9810				
Power: AC 120V/60Hz									
Test date: 2015-07-22 Test site: 3m Chamber Tested by: Peter									
Test mode: GFSK Tx CH40 2441MHz									
Antenna polarity: Vertical									
No	Freq (MHz)	Read Level (dBuV/m)	Antenna Factor (dB/m)	Cable loss(dB)	Amp Factor (dB)	Result (dBuV/m)	Limit (dBuV/m)	Margin (dB)	Remark
1	4882	43.07	33.93	10.2	34.29	52.91	74	21.09	PK
2	4882	32.87	33.93	10.2	34.29	42.71	54	11.29	AV
3	7323	/							
4	9764	/							
5	12205	/							
Antenna Polarity: Horizontal									
1	4882	42.9	33.93	10.2	34.29	52.74	74	21.26	PK
2	4882	32.45	33.93	10.2	34.29	42.29	54	11.71	AV
3	7323	/							
4	9764	/							
5	12205	/							
Note:									
1, Measuring frequency from 1GHz to 25GHz									
2, Spectrum Set for PK measure: RBW=1MHz, VBW=1MHz, Sweep time=Auto, Detector: PK									
2, Spectrum Set for AV measure: RBW=1MHz, VBW=10Hz, Sweep time=Auto, Detector: PK									
3, Result = Read level + Antenna factor + cable loss-Amp factor									
4, All the other emissions not reported were too low to read and deemed to comply with FCC limit.									

1GHz—25GHz Radiated emission Test result									
EUT: Bluetooth Music Bulb					M/N: HZ-9810				
Power: AC 120V/60Hz									
Test date: 2015-07-22 Test site: 3m Chamber Tested by: Peter									
Test mode: GFSK Tx CH79 2480MHz									
Antenna polarity: Vertical									
No	Freq (MHz)	Read Level (dBuV/m)	Antenna Factor (dB/m)	Cable loss(dB)	Amp Factor (dB)	Result (dBuV/m)	Limit (dBuV/m)	Margin (dB)	Remark
1	4960	43.35	33.98	10.22	34.25	53.3	74	20.7	PK
2	4960	32.57	33.98	10.22	34.25	42.52	54	11.48	AV
3	7440	/							
4	9920	/							
5	12400	/							
Antenna Polarity: Horizontal									
1	4960	43.38	33.98	10.22	34.25	53.33	74	20.67	PK
2	4960	32.8	33.98	10.22	34.25	42.75	54	11.25	AV
3	7440	/							
4	9920	/							
5	12400	/							
Note:									
1, Measuring frequency from 1GHz to 25GHz									
2, Spectrum Set for PK measure: RBW=1MHz, VBW=1MHz, Sweep time=Auto, Detector: PK									
2, Spectrum Set for AV measure: RBW=1MHz, VBW=10Hz, Sweep time=Auto, Detector: PK									
3, Result = Read level + Antenna factor + cable loss-Amp factor									
4, All the other emissions not reported were too low to read and deemed to comply with FCC limit.									

1GHz—25GHz Radiated emission Test result									
EUT: Bluetooth Music Bulb					M/N: HZ-9810				
Power: AC 120V/60Hz									
Test date: 2015-07-22 Test site: 3m Chamber Tested by: Peter									
Test mode: π /4 DQPSK Tx CH1 2402MHz									
Antenna polarity: Vertical									
No	Freq (MHz)	Read Level (dBuV/m)	Antenna Factor (dB/m)	Cable loss(dB)	Amp Factor (dB)	Result (dBuV/m)	Limit (dBuV/m)	Margin (dB)	Remark
1	4804	42.96	33.95	10.18	34.26	52.83	74	21.17	PK
2	4804	32.45	33.95	10.18	34.26	42.32	54	11.68	AV
3	7206	/							
4	9608	/							
5	12010	/							
Antenna Polarity: Horizontal									
1	4804	42.98	33.95	10.18	34.26	52.85	74	21.15	PK
2	4804	32.73	33.95	10.18	34.26	42.6	54	11.4	AV
3	7206	/							
4	9608	/							
5	12010	/							
Note:									
1, Measuring frequency from 1GHz to 25GHz									
2, Spectrum Set for PK measure: RBW=1MHz, VBW=1MHz, Sweep time=Auto, Detector: PK									
2, Spectrum Set for AV measure: RBW=1MHz, VBW=10Hz, Sweep time=Auto, Detector: PK									
3, Result = Read level + Antenna factor + cable loss-Amp factor									
4, All the other emissions not reported were too low to read and deemed to comply with FCC limit.									

1GHz—25GHz Radiated emission Test result									
EUT: Bluetooth Music Bulb					M/N: HZ-9810				
Power: AC 120V/60Hz									
Test date: 2015-07-22 Test site: 3m Chamber Tested by: Peter									
Test mode: $\pi/4$ DQPSK Tx CH40 2441MHz									
Antenna polarity: Vertical									
No	Freq (MHz)	Read Level (dBuV/m)	Antenna Factor (dB/m)	Cable loss(dB)	Amp Factor (dB)	Result (dBuV/m)	Limit (dBuV/m)	Margin (dB)	Remark
1	4882	43.15	33.93	10.2	34.29	52.99	74	21.01	PK
2	4882	32.73	33.93	10.2	34.29	42.57	54	11.43	AV
3	7323	/							
4	9764	/							
5	12205	/							
Antenna Polarity: Horizontal									
1	4882	43.15	33.93	10.2	34.29	52.99	74	21.01	PK
2	4882	32.52	33.93	10.2	34.29	42.36	54	11.64	AV
3	7323	/							
4	9764	/							
5	12205	/							
Note:									
1, Measuring frequency from 1GHz to 25GHz									
2, Spectrum Set for PK measure: RBW=1MHz, VBW=1MHz, Sweep time=Auto, Detector: PK									
2, Spectrum Set for AV measure: RBW=1MHz, VBW=10Hz, Sweep time=Auto, Detector: PK									
3, Result = Read level + Antenna factor + cable loss-Amp factor									
4, All the other emissions not reported were too low to read and deemed to comply with FCC limit.									

1GHz—25GHz Radiated emission Test result									
EUT: Bluetooth Music Bulb					M/N: HZ-9810				
Power: AC 120V/60Hz									
Test date: 2015-07-22 Test site: 3m Chamber Tested by: Peter									
Test mode: $\pi/4$ DQPSK Tx CH79 2480MHz									
Antenna polarity: Vertical									
No	Freq (MHz)	Read Level (dBuV/m)	Antenna Factor (dB/m)	Cable loss(dB)	Amp Factor (dB)	Result (dBuV/m)	Limit (dBuV/m)	Margin (dB)	Remark
1	4960	43.05	33.98	10.22	34.25	53	74	21	PK
2	4960	32.9	33.98	10.22	34.25	42.85	54	11.15	AV
3	7440	/							
4	9920	/							
5	12400	/							
Antenna Polarity: Horizontal									
1	4960	43.43	33.98	10.22	34.25	53.38	74	20.62	PK
2	4960	33	33.98	10.22	34.25	42.95	54	11.05	AV
3	7440	/							
4	9920	/							
5	12400	/							
Note:									
1, Measuring frequency from 1GHz to 25GHz									
2, Spectrum Set for PK measure: RBW=1MHz, VBW=1MHz, Sweep time=Auto, Detector: PK									
2, Spectrum Set for AV measure: RBW=1MHz, VBW=10Hz, Sweep time=Auto, Detector: PK									
3, Result = Read level + Antenna factor + cable loss-Amp factor									
4, All the other emissions not reported were too low to read and deemed to comply with FCC limit.									

1GHz—25GHz Radiated emission Test result									
EUT: Bluetooth Music Bulb					M/N: HZ-9810				
Power: AC 120V/60Hz									
Test date: 2015-07-22 Test site: 3m Chamber Tested by: Peter									
Test mode: 8- DQPSK Tx CH1 2402MHz									
Antenna polarity: Vertical									
No	Freq (MHz)	Read Level (dBuV/m)	Antenna Factor (dB/m)	Cable loss(dB)	Amp Factor (dB)	Result (dBuV/m)	Limit (dBuV/m)	Margin (dB)	Remark
1	4804	43.04	33.95	10.18	34.26	52.91	74	21.09	PK
2	4804	32.43	33.95	10.18	34.26	42.3	54	11.7	AV
3	7206	/							
4	9608	/							
5	12010	/							
Antenna Polarity: Horizontal									
1	4804	42.72	33.95	10.18	34.26	52.59	74	21.41	PK
2	4804	32.09	33.95	10.18	34.26	41.96	54	12.04	AV
3	7206	/							
4	9608	/							
5	12010	/							
Note:									
1, Measuring frequency from 1GHz to 25GHz									
2, Spectrum Set for PK measure: RBW=1MHz, VBW=1MHz, Sweep time=Auto, Detector: PK									
2, Spectrum Set for AV measure: RBW=1MHz, VBW=10Hz, Sweep time=Auto, Detector: PK									
3, Result = Read level + Antenna factor + cable loss-Amp factor									
4, All the other emissions not reported were too low to read and deemed to comply with FCC limit.									

1GHz—25GHz Radiated emission Test result									
EUT: Bluetooth Music Bulb					M/N: HZ-9810				
Power: AC 120V/60Hz									
Test date: 2015-07-22 Test site: 3m Chamber Tested by: Peter									
Test mode: 8- DQPSK Tx CH40 2441MHz									
Antenna polarity: Vertical									
No	Freq (MHz)	Read Level (dBuV/m)	Antenna Factor (dB/m)	Cable loss(dB)	Amp Factor (dB)	Result (dBuV/m)	Limit (dBuV/m)	Margin (dB)	Remark
1	4882	42.85	33.93	10.2	34.29	52.69	74	21.31	PK
2	4882	32.52	33.93	10.2	34.29	42.36	54	11.64	AV
3	7323	/							
4	9764	/							
5	12205	/							
Antenna Polarity: Horizontal									
1	4882	43.03	33.93	10.2	34.29	52.87	74	21.13	PK
2	4882	32.64	33.93	10.2	34.29	42.48	54	11.52	AV
3	7323	/							
4	9764	/							
5	12205	/							
Note:									
1, Measuring frequency from 1GHz to 25GHz									
2, Spectrum Set for PK measure: RBW=1MHz, VBW=1MHz, Sweep time=Auto, Detector: PK									
2, Spectrum Set for AV measure: RBW=1MHz, VBW=10Hz, Sweep time=Auto, Detector: PK									
3, Result = Read level + Antenna factor + cable loss-Amp factor									
4, All the other emissions not reported were too low to read and deemed to comply with FCC limit.									

1GHz—25GHz Radiated emission Test result									
EUT: Bluetooth Music Bulb					M/N: HZ-9810				
Power: AC 120V/60Hz									
Test date: 2015-07-22 Test site: 3m Chamber Tested by: Peter									
Test mode: 8- DQPSK Tx CH79 2480MHz									
Antenna polarity: Vertical									
No	Freq (MHz)	Read Level (dBuV/m)	Antenna Factor (dB/m)	Cable loss(dB)	Amp Factor (dB)	Result (dBuV/m)	Limit (dBuV/m)	Margin (dB)	Remark
1	4960	42.83	33.98	10.22	34.25	52.78	74	21.22	PK
2	4960	32.56	33.98	10.22	34.25	42.51	54	11.49	AV
3	7440	/							
4	9920	/							
5	12400	/							
Antenna Polarity: Horizontal									
1	4960	43.15	33.98	10.22	34.25	53.1	74	20.9	PK
2	4960	32.52	33.98	10.22	34.25	42.47	54	11.53	AV
3	7440	/							
4	9920	/							
5	12400	/							
Note:									
1, Measuring frequency from 1GHz to 25GHz									
2, Spectrum Set for PK measure: RBW=1MHz, VBW=1MHz, Sweep time=Auto, Detector: PK									
2, Spectrum Set for AV measure: RBW=1MHz, VBW=10Hz, Sweep time=Auto, Detector: PK									
3, Result = Read level + Antenna factor + cable loss-Amp factor									
4, All the other emissions not reported were too low to read and deemed to comply with FCC limit.									

9. Band Edge Compliance

9.1. Block Diagram of Test Setup

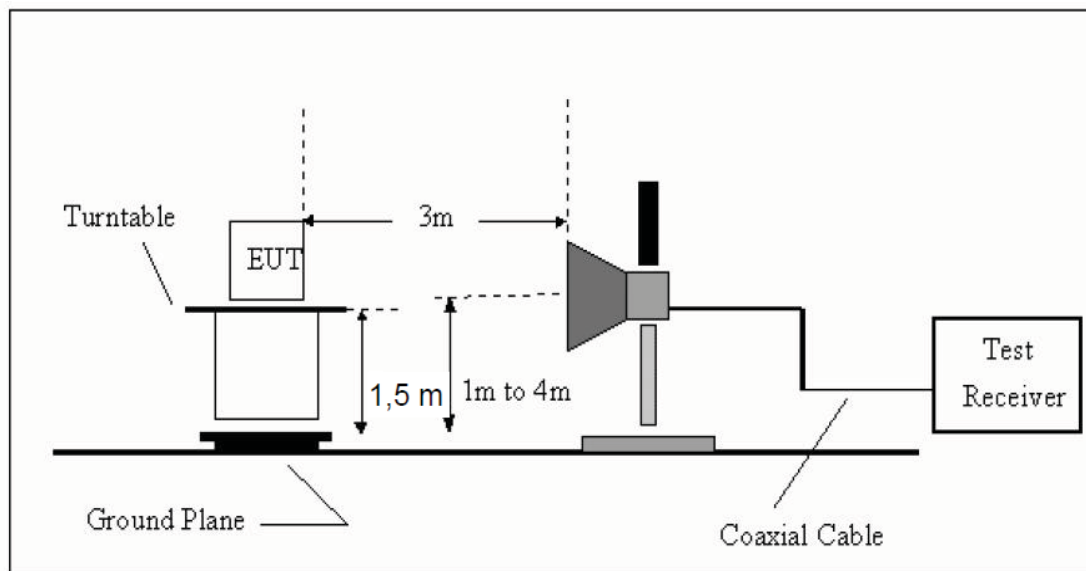

9.2. Limit

All the lower and upper band-edges emissions appearing within restricted frequency bands shall not exceed the limits shown in 15.209, all the other emissions outside operation shall be at least 20dB below the fundamental emissions, or comply with 15.209 limits.

9.3. Test Procedure

All restriction band and non- restriction band have been tested , only worse case is reported.

9.4. Test Result

PASS. (See below detailed test data)

Radiated Method

GFSK (CH Low)

Band Edge Test result								
EUT: Bluetooth Music Bulb					M/N: HZ-9810			
Power: AC 120V/60Hz								
Test date: 2015-07-22 Test site: 3m Chamber Tested by: Peter								
Test mode: Tx CH Low 2402MHz								
Antenna polarity: Vertical								
Freq (MHz)	Read Level (dBuV/m)	Antenna Factor (dB/m)	Cable loss(dB)	Amp Factor (dB)	Result (dBuV/m)	Limit (dBuV/m)	Margin (dB)	Remark
2390	43.58	27.62	3.92	34.97	40.15	74	33.85	PK
2390	--	27.62	3.92	34.97	--	54	--	AV
2400	42.91	27.62	3.94	34.97	39.5	74	34.5	PK
2400	--	27.62	3.94	34.97	--	54	--	AV
Antenna Polarity: Horizontal								
2390	43.07	27.62	3.92	34.97	39.64	74	34.36	PK
2390	--	27.62	3.92	34.97	--	54	--	AV
2400	43.28	27.62	3.94	34.97	39.87	74	34.13	PK
2400	--	27.62	3.94	34.97	--	54	--	AV
Note:								
1, Spectrum Set for PK measure: RBW=1MHz, VBW=1MHz, Sweep time=Auto, Detector: PK								
2, Spectrum Set for AV measure: RBW=1MHz, VBW=10Hz, Sweep time=Auto, Detector: PK								
3, Result = Read level + Antenna factor + cable loss-Amp factor								
4, All the other emissions not reported were too low to read and deemed to comply with FCC limit.								

GFSK (CH High)

Band Edge Test result								
EUT: Bluetooth Music Bulb					M/N: HZ-9810			
Power: AC 120V/60Hz								
Test date: 2015-07-22 Test site: 3m Chamber Tested by: Peter								
Test mode: Tx CH High 2480MHz								
Antenna polarity: Vertical								
Freq (MHz)	Read Level (dBuV/m)	Antenna Factor (dB/m)	Cable loss(dB)	Amp Factor (dB)	Result (dBuV/m)	Limit (dBuV/m)	Margin (dB)	Remark
2483.5	42.91	27.89	4	34.97	39.83	74	34.17	PK
2483.5	--	--	--	--	--	54	--	AV
Antenna Polarity: Horizontal								
2483.5	43.1	27.89	4	34.97	40.02	74	33.98	PK
2483.5	--	--	--	--	--	54	--	AV
Note:								
1, Spectrum Set for PK measure: RBW=1MHz, VBW=1MHz, Sweep time=Auto, Detector: PK								
2, Spectrum Set for AV measure: RBW=1MHz, VBW=10Hz, Sweep time=Auto, Detector: PK								
3, Result = Read level + Antenna factor + cable loss-Amp factor								
4, All the other emissions not reported were too low to read and deemed to comply with FCC limit.								

GFSK (Hopping Low)

Band Edge Test result								
EUT: Bluetooth Music Bulb					M/N: HZ-9810			
Power: AC 120V/60Hz								
Test date: 2015-07-22 Test site: 3m Chamber Tested by: Peter								
Test mode: Tx Hopping								
Antenna polarity: Vertical								
Freq (MHz)	Read Level (dBuV/m)	Antenna Factor (dB/m)	Cable loss(dB)	Amp Factor (dB)	Result (dBuV/m)	Limit (dBuV/m)	Margin (dB)	Remark
2390	41.76	27.62	3.92	34.97	38.33	74	35.67	PK
2390	--	27.62	3.92	34.97	--	54	--	AV
Antenna Polarity: Horizontal								
2390	42.71	27.62	3.92	34.97	39.28	74	34.72	PK
2390	--	27.62	3.92	34.97	--	54	--	AV
Note:								
1, Spectrum Set for PK measure: RBW=1MHz, VBW=1MHz, Sweep time=Auto, Detector: PK								
2, Spectrum Set for AV measure: RBW=1MHz, VBW=10Hz, Sweep time=Auto, Detector: PK								
3, Result = Read level + Antenna factor + cable loss-Amp factor								
4, All the other emissions not reported were too low to read and deemed to comply with FCC limit.								

GFSK (Hopping High)

Band Edge Test result								
EUT: Bluetooth Music Bulb					M/N: HZ-9810			
Power: AC 120V/60Hz								
Test date: 2015-07-22 Test site: 3m Chamber Tested by: Peter								
Test mode: Tx Hopping								
Antenna polarity: Vertical								
Freq (MHz)	Read Level (dBuV/m)	Antenna Factor (dB/m)	Cable loss(dB)	Amp Factor (dB)	Result (dBuV/m)	Limit (dBuV/m)	Margin (dB)	Remark
2483.5	42.23	27.89	4	34.97	39.15	74	34.85	PK
2483.5	--	--	--	--	--	54	--	AV
Antenna Polarity: Horizontal								
2483.5	42.45	27.89	4	34.97	39.37	74	34.63	PK
2483.5	--	--	--	--	--	54	--	AV
Note:								
1, Spectrum Set for PK measure: RBW=1MHz, VBW=1MHz, Sweep time=Auto, Detector: PK								
2, Spectrum Set for AV measure: RBW=1MHz, VBW=10Hz, Sweep time=Auto, Detector: PK								
3, Result = Read level + Antenna factor + cable loss-Amp factor								
4, All the other emissions not reported were too low to read and deemed to comply with FCC limit.								

$\pi/4$ DQPSK (CH Low)

Band Edge Test result								
EUT: Bluetooth Music Bulb					M/N: HZ-9810			
Power: AC 120V/60Hz								
Test date: 2015-07-22 Test site: 3m Chamber Tested by: Peter								
Test mode: Tx CH Low 2402MHz								
Antenna polarity: Vertical								
Freq (MHz)	Read Level (dBuV/m)	Antenna Factor (dB/m)	Cable loss(dB)	Amp Factor (dB)	Result (dBuV/m)	Limit (dBuV/m)	Margin (dB)	Remark
2390	42.53	27.62	3.92	34.97	39.1	74	34.9	PK
2390	--	27.62	3.92	34.97	--	54	--	AV
Antenna Polarity: Horizontal								
2390	42.85	27.62	3.92	34.97	39.42	74	34.58	PK
2390	--	27.62	3.92	34.97	--	54	--	AV
Note:								
1, Spectrum Set for PK measure: RBW=1MHz, VBW=1MHz, Sweep time=Auto, Detector: PK								
2, Spectrum Set for AV measure: RBW=1MHz, VBW=10Hz, Sweep time=Auto, Detector: PK								
3, Result = Read level + Antenna factor + cable loss-Amp factor								
4, All the other emissions not reported were too low to read and deemed to comply with FCC limit.								

π /4 DQPSK (CH High)

Band Edge Test result								
EUT: Bluetooth Music Bulb					M/N: HZ-9810			
Power: AC 120V/60Hz								
Test date: 2015-07-22 Test site: 3m Chamber Tested by: Peter								
Test mode: Tx CH High 2480MHz								
Antenna polarity: Vertical								
Freq (MHz)	Read Level (dBuV/m)	Antenna Factor (dB/m)	Cable loss(dB)	Amp Factor (dB)	Result (dBuV/m)	Limit (dBuV/m)	Margin (dB)	Remark
2483.5	41.94	27.89	4	34.97	38.86	74	35.14	PK
2483.5	--	--	--	--	--	54	--	AV
Antenna Polarity: Horizontal								
2483.5	42.38	27.89	4	34.97	39.3	74	34.7	PK
2483.5	--	--	--	--	--	54	--	AV
Note:								
1, Spectrum Set for PK measure: RBW=1MHz, VBW=1MHz, Sweep time=Auto, Detector: PK								
2, Spectrum Set for AV measure: RBW=1MHz, VBW=10Hz, Sweep time=Auto, Detector: PK								
3, Result = Read level + Antenna factor + cable loss-Amp factor								
4, All the other emissions not reported were too low to read and deemed to comply with FCC limit.								

$\pi/4$ DQPSK (Hopping Low)

Band Edge Test result								
EUT: Bluetooth Music Bulb					M/N: HZ-9810			
Power: AC 120V/60Hz								
Test date: 2015-07-22 Test site: 3m Chamber Tested by: Peter								
Test mode: Tx Hopping								
Antenna polarity: Vertical								
Freq (MHz)	Read Level (dBuV/m)	Antenna Factor (dB/m)	Cable loss(dB)	Amp Factor (dB)	Result (dBuV/m)	Limit (dBuV/m)	Margin (dB)	Remark
2390	42.59	27.62	3.92	34.97	39.16	74	34.84	PK
2390	--	27.62	3.92	34.97	--	54	--	AV
Antenna Polarity: Horizontal								
2390	42.55	27.62	3.92	34.97	39.12	74	34.88	PK
2390	--	27.62	3.92	34.97	--	54	--	AV
Note:								
1, Spectrum Set for PK measure: RBW=1MHz, VBW=1MHz, Sweep time=Auto, Detector: PK								
2, Spectrum Set for AV measure: RBW=1MHz, VBW=10Hz, Sweep time=Auto, Detector: PK								
3, Result = Read level + Antenna factor + cable loss-Amp factor								
4, All the other emissions not reported were too low to read and deemed to comply with FCC limit.								

π /4 DQPSK (Hopping High)

Band Edge Test result								
EUT: Bluetooth Music Bulb					M/N: HZ-9810			
Power: AC 120V/60Hz								
Test date: 2015-07-22 Test site: 3m Chamber Tested by: Peter								
Test mode: Tx Hopping								
Antenna polarity: Vertical								
Freq (MHz)	Read Level (dBuV/m)	Antenna Factor (dB/m)	Cable loss(dB)	Amp Factor (dB)	Result (dBuV/m)	Limit (dBuV/m)	Margin (dB)	Remark
2483.5	41.84	27.89	4	34.97	38.76	74	35.24	PK
2483.5	--	--	--	--	--	54	--	AV
Antenna Polarity: Horizontal								
2483.5	43.09	27.89	4	34.97	40.01	74	33.99	PK
2483.5	--	--	--	--	--	54	--	AV
Note:								
1, Spectrum Set for PK measure: RBW=1MHz, VBW=1MHz, Sweep time=Auto, Detector: PK								
2, Spectrum Set for AV measure: RBW=1MHz, VBW=10Hz, Sweep time=Auto, Detector: PK								
3, Result = Read level + Antenna factor + cable loss-Amp factor								
4, All the other emissions not reported were too low to read and deemed to comply with FCC limit.								

8- DPSK (CH Low)

Band Edge Test result								
EUT: Bluetooth Music Bulb				M/N: HZ-9810				
Power: AC 120V/60Hz								
Test date: 2015-07-22 Test site: 3m Chamber Tested by: Peter								
Test mode: Tx CH Low 2402MHz								
Antenna polarity: Vertical								
Freq (MHz)	Read Level (dBuV/m)	Antenna Factor (dB/m)	Cable loss(dB)	Amp Factor (dB)	Result (dBuV/m)	Limit (dBuV/m)	Margin (dB)	Remark
2390	42.77	27.62	3.92	34.97	39.34	74	34.66	PK
2390	--	27.62	3.92	34.97	--	54	--	AV
Antenna Polarity: Horizontal								
2390	42.98	27.62	3.92	34.97	39.55	74	34.45	PK
2390	--	27.62	3.92	34.97	--	54	--	AV
Note:								
1, Spectrum Set for PK measure: RBW=1MHz, VBW=1MHz, Sweep time=Auto, Detector: PK								
2, Spectrum Set for AV measure: RBW=1MHz, VBW=10Hz, Sweep time=Auto, Detector: PK								
3, Result = Read level + Antenna factor + cable loss-Amp factor								
4, All the other emissions not reported were too low to read and deemed to comply with FCC limit.								

8- DPSK (CH High)

Band Edge Test result								
EUT: Bluetooth Music Bulb				M/N: HZ-9810				
Power: AC 120V/60Hz								
Test date: 2015-07-22 Test site: 3m Chamber Tested by: Peter								
Test mode: Tx CH High 2480MHz								
Antenna polarity: Vertical								
Freq (MHz)	Read Level (dBuV/m)	Antenna Factor (dB/m)	Cable loss(dB)	Amp Factor (dB)	Result (dBuV/m)	Limit (dBuV/m)	Margin (dB)	Remark
2483.5	41.82	27.89	4	34.97	38.74	74	35.26	PK
2483.5	--	--	--	--	--	54	--	AV
Antenna Polarity: Horizontal								
2483.5	43.17	27.89	4	34.97	40.09	74	33.91	PK
2483.5	--	--	--	--	--	54	--	AV
Note:								
1, Spectrum Set for PK measure: RBW=1MHz, VBW=1MHz, Sweep time=Auto, Detector: PK								
2, Spectrum Set for AV measure: RBW=1MHz, VBW=10Hz, Sweep time=Auto, Detector: PK								
3, Result = Read level + Antenna factor + cable loss-Amp factor								
4, All the other emissions not reported were too low to read and deemed to comply with FCC limit.								

8- DPSK (Hopping Low)

Band Edge Test result								
EUT: Bluetooth Music Bulb				M/N: HZ-9810				
Power: AC 120V/60Hz								
Test date: 2015-07-22 Test site: 3m Chamber Tested by: Peter								
Test mode: Tx Hopping								
Antenna polarity: Vertical								
Freq (MHz)	Read Level (dBuV/m)	Antenna Factor (dB/m)	Cable loss(dB)	Amp Factor (dB)	Result (dBuV/m)	Limit (dBuV/m)	Margin (dB)	Remark
2390	42.49	27.62	3.92	34.97	39.06	74	34.94	PK
2390	--	27.62	3.92	34.97	--	54	--	AV
Antenna Polarity: Horizontal								
2390	43.02	27.62	3.92	34.97	39.59	74	34.41	PK
2390	--	27.62	3.92	34.97	--	54	--	AV
Note:								
1, Spectrum Set for PK measure: RBW=1MHz, VBW=1MHz, Sweep time=Auto, Detector: PK								
2, Spectrum Set for AV measure: RBW=1MHz, VBW=10Hz, Sweep time=Auto, Detector: PK								
3, Result = Read level + Antenna factor + cable loss-Amp factor								
4, All the other emissions not reported were too low to read and deemed to comply with FCC limit.								

8- DPSK (Hopping High)

Band Edge Test result								
EUT: Bluetooth Music Bulb				M/N: HZ-9810				
Power: AC 120V/60Hz								
Test date: 2015-07-22 Test site: 3m Chamber Tested by: Peter								
Test mode: Tx Hopping								
Antenna polarity: Vertical								
Freq (MHz)	Read Level (dBuV/m)	Antenna Factor (dB/m)	Cable loss(dB)	Amp Factor (dB)	Result (dBuV/m)	Limit (dBuV/m)	Margin (dB)	Remark
2483.5	41.91	27.89	4	34.97	38.83	74	35.17	PK
2483.5	--	--	--	--	--	54	--	AV
Antenna Polarity: Horizontal								
2483.5	42.62	27.89	4	34.97	39.54	74	34.46	PK
2483.5	--	--	--	--	--	54	--	AV
Note:								
1, Spectrum Set for PK measure: RBW=1MHz, VBW=1MHz, Sweep time=Auto, Detector: PK								
2, Spectrum Set for AV measure: RBW=1MHz, VBW=10Hz, Sweep time=Auto, Detector: PK								
3, Result = Read level + Antenna factor + cable loss-Amp factor								
4, All the other emissions not reported were too low to read and deemed to comply with FCC limit.								

Conducted Method

GFSK

CH LOW :

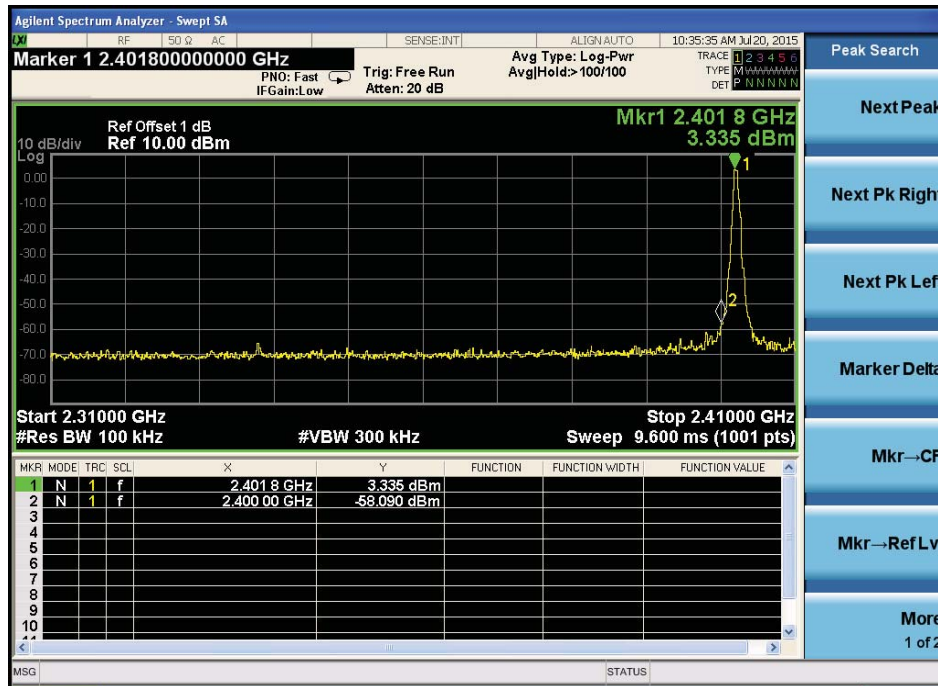

CH High :

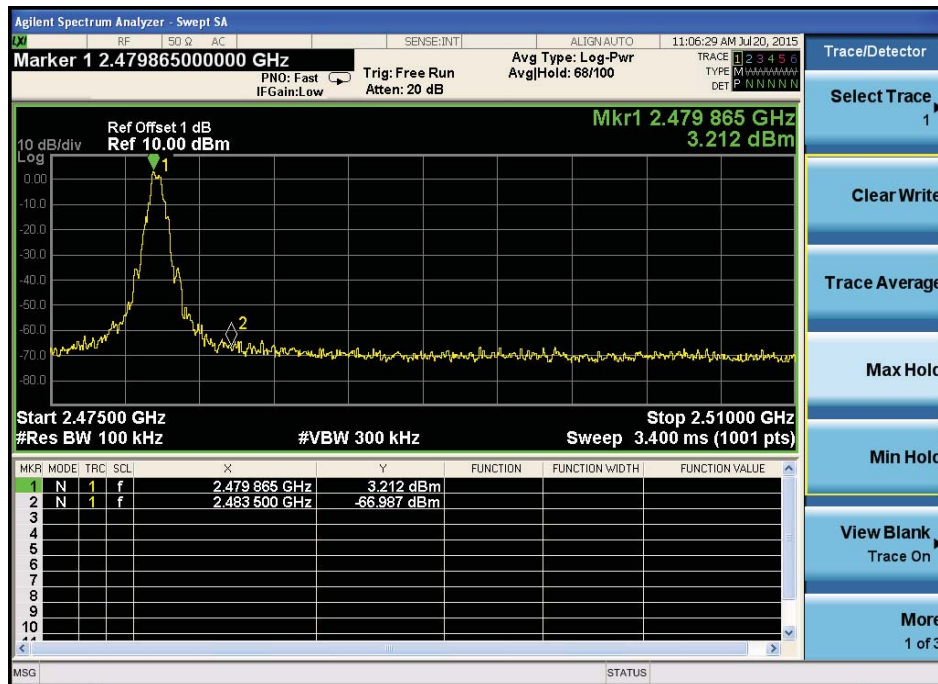

Hopping
Low

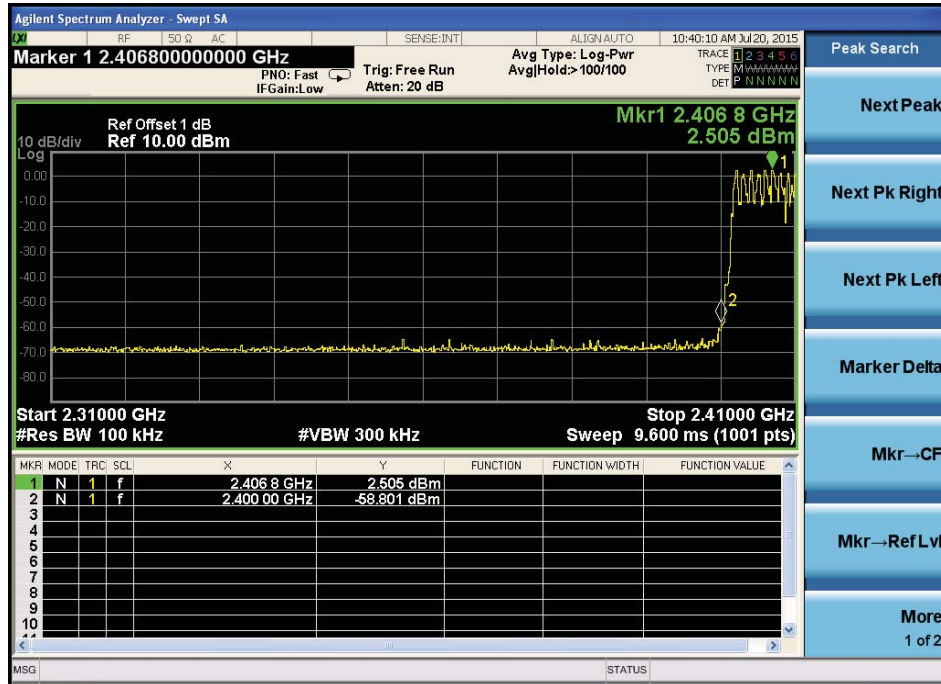

High

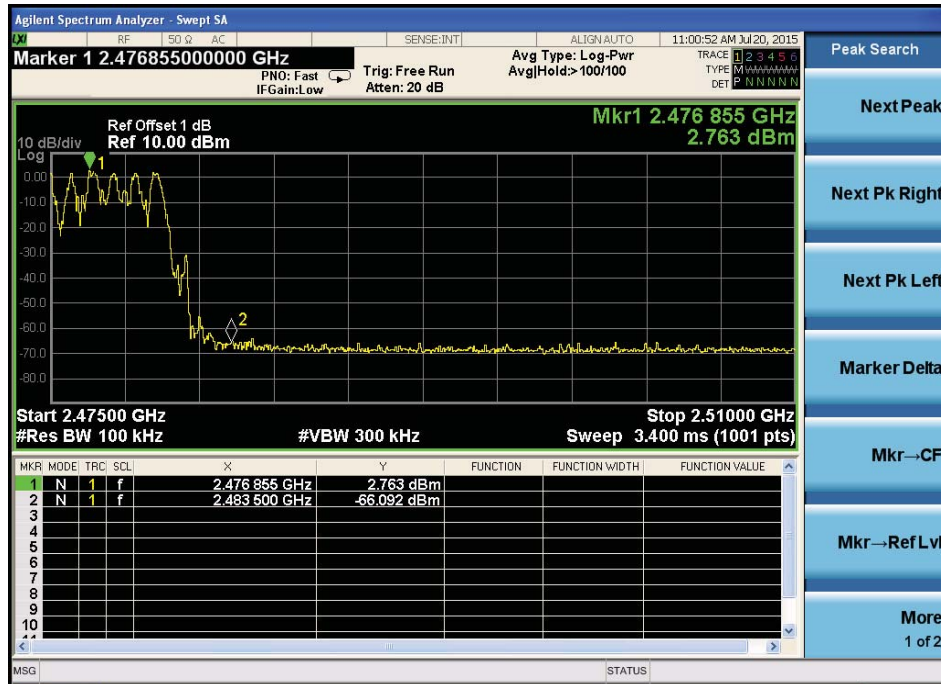

10. Power Line Conducted Emissions

10.1. Block Diagram of Test Setup

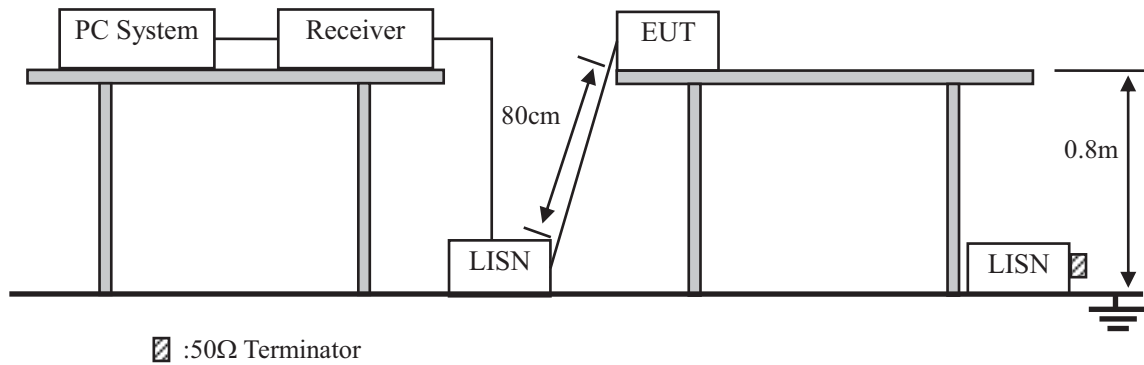

10.2. Limit

Frequency	Maximum RF Line Voltage	
	Quasi-Peak Level dB(μV)	Average Level dB(μV)
150kHz ~ 500kHz	66 ~ 56*	56 ~ 46*
500kHz ~ 5MHz	56	46
5MHz ~ 30MHz	60	50

- Notes: 1. * Decreasing linearly with logarithm of frequency.
 2. The lower limit shall apply at the transition frequencies.

10.3. Test Procedure

- (1) The EUT was placed on a non-metallic table, 80cm above the ground plane.
- (2) Setup the EUT and simulator as shown in 10.1
- (3) The EUT Power connected to the power mains through a power adapter and a line impedance stabilization network (L.I.S.N1). The other peripheral devices power cord connected to the power mains through a line impedance stabilization network (L.I.S.N2), this provided a 50-ohm coupling impedance for the EUT (Please refer to the block diagram of the test setup and photographs). Both sides of power line were checked for maximum conducted interference. In order to find the maximum emission, the relative positions of equipments and all of the interface cables were changed according to ANSI C63.4 2014 on conducted Emission test.
- (4) The bandwidth of test receiver is set at 10KHz.
- (5) The frequency range from 150 KHz to 30MHz is checked.

10.4. Test Result

PASS. (See below detailed test data)

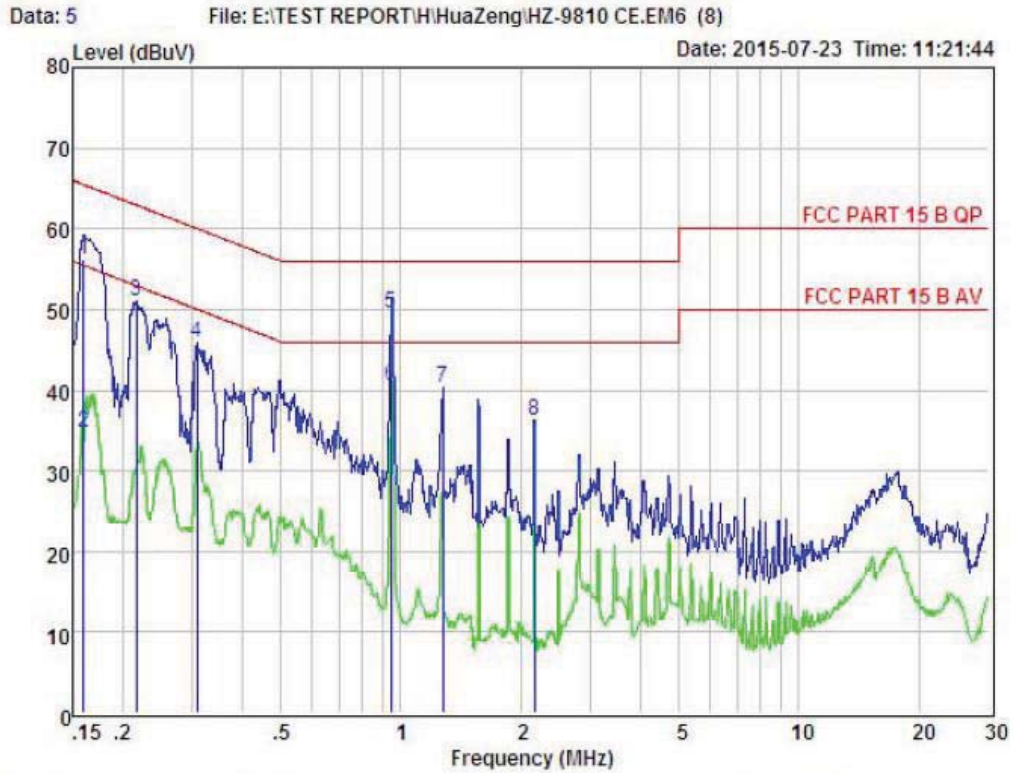

Condition : FCC PART 15 B QP POL: LINE Temp:20.1 °C Hum:45 %
 EUI :
 Model No : HZ-9810
 Test Mode :
 Power : AC 120V/60Hz
 Test Engineer:
 Remark :

Item	Freq MHz	Read dBuV	LISN Factor dB	Attenuator Factor dB	Cable Loss dB	Level dBuV	Limit dBuV	Margin dBuV	Remark
1	0.160	46.30	0.03	-9.72	0.10	56.15	65.47	-9.32	QP
2	0.160	25.00	0.03	-9.72	0.10	34.85	55.47	-20.62	Average
3	0.216	41.10	0.03	-9.72	0.10	50.95	62.96	-12.01	Peak
4	0.308	36.03	0.03	-9.72	0.10	45.88	60.02	-14.14	Peak
5	0.943	39.71	0.04	-9.71	0.10	49.56	56.00	-6.44	QP
6	0.943	30.59	0.04	-9.71	0.10	40.44	46.00	-5.56	Average
7	1.276	30.36	0.05	-9.71	0.10	40.22	56.00	-15.78	Peak
8	2.167	26.33	0.06	-9.70	0.10	36.19	56.00	-19.81	Peak

Remarks: Level = Read + LISN Factor - Attenuator Factor + Cable loss

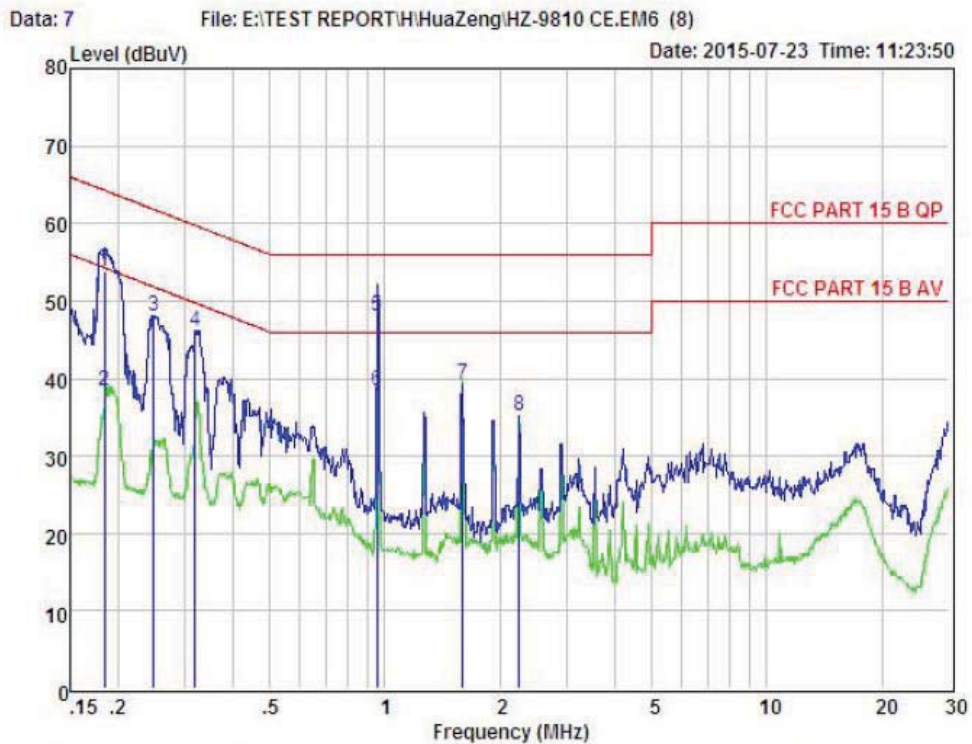

Condition : FCC PART 15 B QP POL: NEUTRAL Temp:20.1 °C Hum:45 %
 EUT :
 Model No : HZ-9810
 Test Mode :
 Power : AC 120V/60Hz
 Test Engineer:
 Remark :

Item	Freq MHz	Read dBuV	LISN Factor dB	Attenuator Factor dB	Cable Loss dB	Level dBuV	Limit dBuV	Margin dBuV	Remark
1	0.184	43.88	0.03	-9.72	0.10	53.73	64.28	-10.55	QP
2	0.184	28.59	0.03	-9.72	0.10	38.44	54.28	-15.84	Average
3	0.248	38.27	0.03	-9.72	0.10	48.12	61.82	-13.70	Peak
4	0.318	36.34	0.03	-9.72	0.10	46.19	59.75	-13.56	Peak
5	0.953	38.18	0.04	-9.71	0.10	48.03	56.00	-7.97	QP
6	0.953	28.54	0.04	-9.71	0.10	38.39	46.00	-7.61	Average
7	1.602	29.44	0.05	-9.71	0.10	39.30	56.00	-16.70	Peak
8	2.249	25.39	0.06	-9.70	0.11	35.26	56.00	-20.74	Peak

Remarks: Level = Read + LISN Factor - Attenuator Factor + Cable loss

Note: If QP Result comply with AV limit, AV Result is deemed to comply with AV limit

11. Antenna Requirements

11.1. Limit

For intentional device, according to FCC 47 CFR Section 15.203, an intentional radiator shall be designed to ensure that no antenna other than that furnished by the responsible party shall be used with the device. And according to FCC 47 CFR Section 15.247 (b), if transmitting antennas of directional gain greater than 6dBi are used, the power shall be reduced by the amount in dB that the directional gain of the antenna exceeds 6dBi.

11.2. Result

The antennas used for this product are PCB Antenna for Bluetooth, no antenna other than that furnished by the responsible party shall be used with the device, the maximum peak gain of the transmit antenna is only 0dBi for Bluetooth.

12. Test setup photo

12.1. Photos of Radiated emission

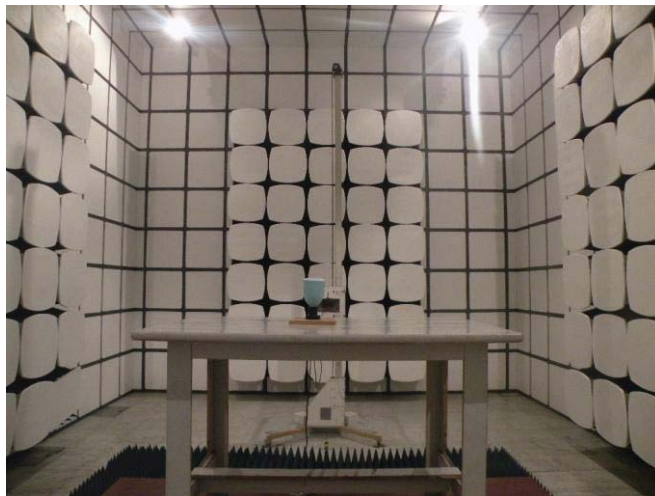
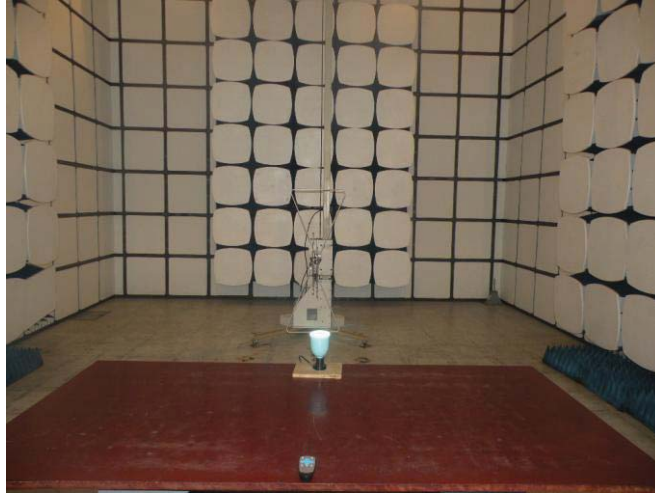

12.2.Photos of Conducted Emission test



13. Photos of EUT



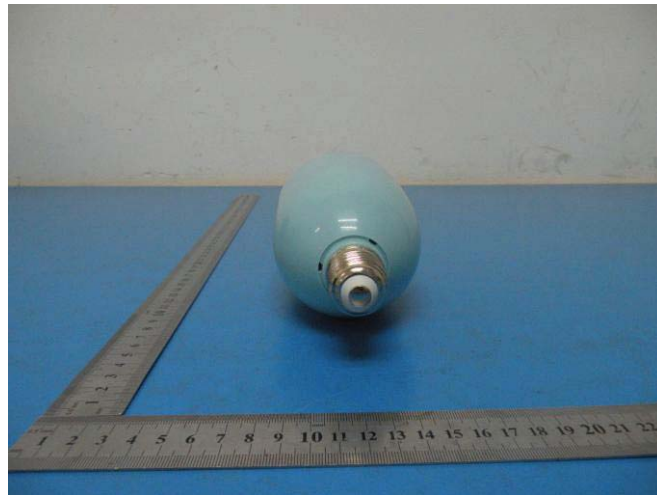



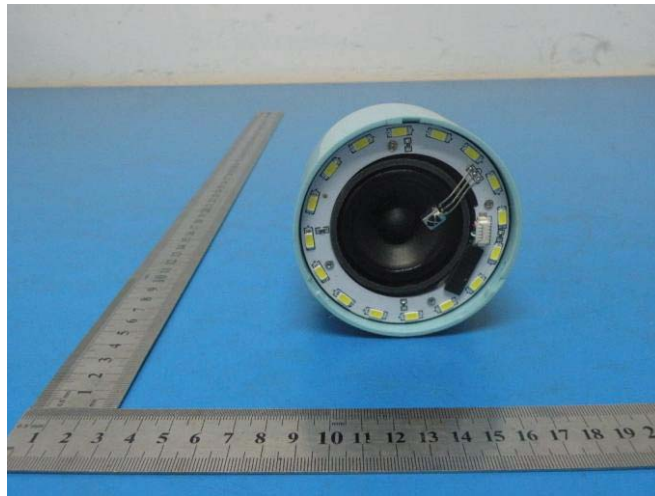

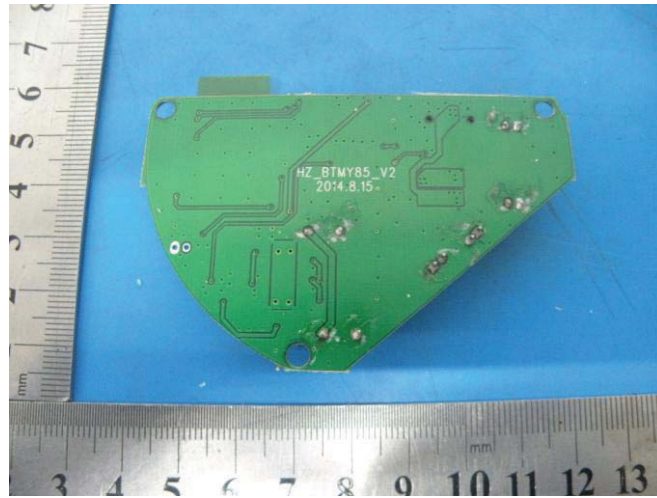

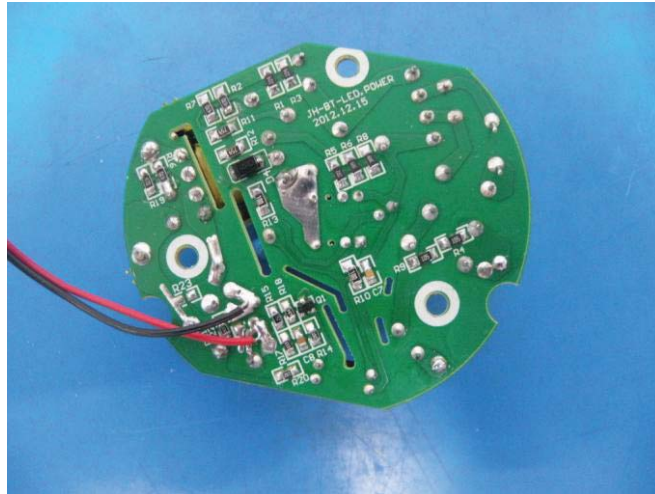

-----END OF THE REPORT-----