



FCC TEST REPORT

FCC ID: 2AFJV-X9D

On Behalf of

Shenzhen HuaZeng Technology Co., Ltd.

LED Desk Lamp with 15W Wireless Charger

Model No.: X9D

Prepared for : Shenzhen HuaZeng Technology Co., Ltd.
Address : 2nd Floor, Fenghua cloud valley, Complex Building, No. 2,Phase 2,
Chuangxin Industrial Park, First Industrial Zone, Loucun Community,
Xinhu Street, Guangming District, Shenzhen

Prepared By : Shenzhen Alpha Product Testing Co., Ltd.
Address : Building i, No.2, Lixin Road, Fuyong Street, Bao'an District,
518103, Shenzhen, Guangdong, China

Report Number : A2210192-C01-R01
Date of Receipt : October 27, 2022
Date of Test : October 27, 2022- November 9, 2022
Date of Report : November 9, 2022
Version Number : V0

TABLE OF CONTENTS

Description	Page
1. Test Result Summary	5
2. General Information	6
2.1. DESCRIPTION OF DEVICE (EUT).....	6
2.2. ACCESSORIES OF DEVICE (EUT).....	7
2.3. TESTED SUPPORTING SYSTEM DETAILS	7
2.4. BLOCK DIAGRAM OF CONNECTION BETWEEN EUT AND SIMULATORS	7
2.5. DESCRIPTION OF TEST MODES.....	7
2.6. TEST CONDITIONS	7
2.7. TEST FACILITY	8
2.8. MEASUREMENT UNCERTAINTY	8
2.9. TEST EQUIPMENT LIST.....	9
3. Test Results and Measurement Data	10
3.1. CONDUCTED EMISSION	10
3.2. RADIATED SPURIOUS EMISSION MEASUREMENT	14
3.3. TEST SPECIFICATION	23
4. Photos of test setup	25
5. Photographs of EUT	27

TEST REPORT DECLARATION

Applicant : Shenzhen HuaZeng Technology Co., Ltd.
 Address : 2nd Floor, Fenghua cloud valley, Complex Building, No. 2,Phase 2, Chuangxin Industrial Park, First Industrial Zone, Loucun Community, Xihu Street, Guangming District, Shenzhen

Manufacturer : Shenzhen HuaZeng Technology Co., Ltd.
 Address : 2nd Floor, Fenghua cloud valley, Complex Building, No. 2,Phase 2, Chuangxin Industrial Park, First Industrial Zone, Loucun Community, Xihu Street, Guangming District, Shenzhen

EUT Description : LED Desk Lamp with 15W Wireless Charger
 (A) Model No. : X9D
 (B) Trademark : /

Measurement Standard Used:
FCC CFR Title 47 Part 15 Subpart C Section 15.209

The device described above is tested by Shenzhen Alpha Product Testing Co., Ltd. to determine the maximum emission levels emanating from the device and the severe levels of the device can endure and its performance criterion. The test results are contained in this test report and Shenzhen Alpha Product Testing Co., Ltd. is assumed full responsibility for the accuracy and completeness of test. Also, this report shows that the EUT is technically compliant with the FCC CFR Title 47 Part 15 Subpart C Section 15.209 requirements.

This report applies to above tested sample only. This report shall not be reproduced in parts without written approval of Shenzhen Alpha Product Testing Co., Ltd.

Tested by (name + signature).....: Yannis Wen
 Project Engineer 

Approved by (name + signature).....: Jack Xu
 Project Manager 

Date of issue.....: November 9, 2022

Revision History

Revision	Issue Date	Revisions	Revised By
V0	November 9, 2022	Initial released Issue	Yannis Wen

1. Test Result Summary

Requirement	CFR 47 Section	Result
Antenna requirement	§15.203	PASS
AC Power Line Conducted Emission	§15.207	PASS
Spurious Emission	§15.209(a)(f)	PASS
Occupied Bandwidth	§15.215 (c)	PASS

Note:

1. *PASS: Test item meets the requirement.*
2. *Fail: Test item does not meet the requirement.*
3. *N/A: Test case does not apply to the test object.*
4. *The test result judgment is decided by the limit of test standard.*
5. Decision rules for the conclusion of this test report: decision by actual test data without considering measurement uncertainty.

2. General Information

2.1. Description of Device (EUT)

EUT Name	:	LED Desk Lamp with 15W Wireless Charger
Model No.	:	X9D
DIFF.	:	N/A
Trademark	:	/
Power supply	:	Input: DC 12V/2A from adapter Output: Mobile phone magnetic wireless charging: 5W, 7.5W, 10W, 15W USB port: 5V/1A(5W)
Radio Technology	:	Wireless power transmission systems
Operation frequency	:	115-205KHz
Modulation	:	MSK
Antenna Type	:	Coil Antenna, Maximum Gain is 0dBi(This value is supplied by applicant).
Connector cable loss	:	0.5dB (This value is supplied by applicant).
Software version	:	V1.0
Hardware version	:	V1.0

2.2. Accessories of Device (EUT)

Accessories	:	AC Adapter
Manufacturer	:	XING YUAN ELECTRONICS CO., LTD
Model	:	XY24SE-120200VQ-UW
Input	:	100-240V~ 50/60Hz 0.5A
Output	:	12.0V=2.0A

2.3. Tested Supporting System Details

No.	Description	Manufacturer	Model	Serial Number	Certification or SDoC
1	Load	N/A	N/A	N/A	N/A
2	Load	N/A	N/A	N/A	N/A
3	N/A	N/A	N/A	N/A	N/A
4	N/A	N/A </td <td>N/A</td> <td>N/A</td> <td>N/A</td>	N/A	N/A	N/A

2.4. Block Diagram of connection between EUT and simulators

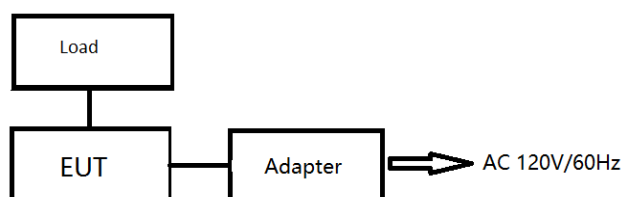

2.5. Description of Test Modes

Channel	Frequency (KHz)
1	146

2.6. Test Conditions

Items	Required	Actual
Temperature range:	15-35°C	24°C
Humidity range:	25-75%	56%
Pressure range:	86-106kPa	98kPa

2.7. Test Facility

Shenzhen Alpha Product Testing Co., Ltd

Building i, No.2, Lixin Road, Fuyong Street, Bao'an District, 518103, Shenzhen, Guangdong, China

June 21, 2018 File on Federal Communication Commission

Registration Number: 293961

July 15, 2019 Certificated by IC

Registration Number: CN0085

2.8. Measurement Uncertainty

(95% confidence levels, k=2)

Item	Uncertainty
Uncertainty for Power point Conducted Emissions Test	1.63dB
Uncertainty for Radiation Emission test in 3m chamber (below 30MHz)	3.5dB
Uncertainty for Radiation Emission test in 3m chamber (30MHz to 1GHz)	3.74dB(Polarize: V)
	3.76dB(Polarize: H)
Uncertainty for Radiation Emission test in 3m chamber (1GHz to 25GHz)	3.77dB(Polarize: V)
	3.80dB(Polarize: H)
Uncertainty for radio frequency	5.06×10^{-8} GHz
Uncertainty for conducted RF Power	0.40dB
Uncertainty for temperature	0.2°C
Uncertainty for humidity	1%
Uncertainty for DC and low frequency voltages	0.06%

2.9. Test Equipment List

Equipment	Manufacture	Model No.	Firmware version	Serial No.	Last cal.	Cal Interval
9*6*6 anechoic chamber	CHENYU	9*6*6	/	N/A	2022.05.17	3Year
Spectrum analyzer	ROHDE&SCHWARZ	FSV40-N	2.3	102137	2022.08.22	1Year
Spectrum analyzer	Agilent	N9020A	A.14.16	MY499100060	2022.08.22	1Year
Receiver	ROHDE&SCHWARZ	ESR	2.28 SP1	1316.3003K03-10 2082-Wa	2022.08.22	1Year
Receiver	R&S	ESCI	4.42 SP1	101165	2022.08.22	1Year
Bilog Antenna	Schwarzbeck	VULB 9168	/	VULB 9168#627	2021.08.30	2Year
Horn Antenna	SCHWARZBECK	BBHA 9120 D	/	2106	2021.08.30	2Year
Active Loop Antenna	SCHWARZBECK	FMZB 1519B	/	00059	2021.08.30	2Year
RF Cable	Resenberger	Cable 1	/	RE1	2022.08.22	1Year
RF Cable	Resenberger	Cable 2	/	RE2	2022.08.22	1Year
RF Cable	Resenberger	Cable 3	/	CE1	2022.08.22	1Year
Pre-amplifier	HP	HP8347A	/	2834A00455	2022.08.22	1Year
Pre-amplifier	Agilent	8449B	/	3008A02664	2022.08.22	1Year
L.I.S.N.#1	Schwarzbeck	NSLK8126	/	8126-466	2022.08.22	1Year
L.I.S.N.#2	ROHDE&SCHWARZ	ENV216	/	101043	2022.08.23	1 Year
Horn Antenna	SCHWARZBECK	BBHA9170	/	00946	2021.08.30	2 Year
Preamplifier	SKET	LNPA_1840 -50	/	SK2018101801	2022.08.22	1 Year
Power Meter	Agilent	E9300A	/	MY41496628	2022.08.22	1 Year
Power Sensor	DARE	RPR3006W	/	15100041SNO91	2022.08.22	1 Year
Temp. & Humid. Chamber	Weihuang	WHTH-1000 -40-880	/	100631	2022.08.22	1 Year
Switching Mode Power Supply	JUNKE	JK12010S	/	20140927-6	2022.08.22	1 Year
Adjustable attenuator	MWRFtest	N/A	/	N/A	N/A	N/A
10dB Attenuator	Mini-Circuits	DC-6G	/	N/A	N/A	N/A

Software Information			
Test Item	Software Name	Manufacturer	Version
RE	EZ-EMC	farad	Alpha-3A1
CE	EZ-EMC	farad	Alpha-3A1
RF-CE	MTS 8310	MWRFtest	2.0.0.0

3. Test Results and Measurement Data

3.1. Conducted Emission

3.1.1. Test Specification

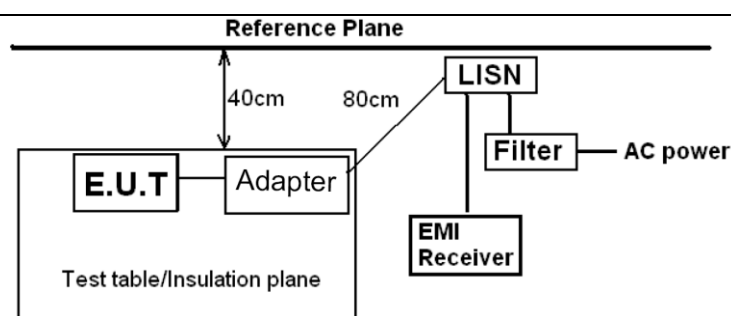
Test Requirement:	FCC Part15 C Section 15.207														
Test Method:	ANSI C63.10:2013														
Frequency Range:	150 kHz to 30 MHz														
Receiver setup:	RBW=9 kHz, VBW=30 kHz, Sweep time=auto														
Limits:	<table border="1"> <thead> <tr> <th rowspan="2">Frequency range (MHz)</th> <th colspan="2">Limit (dBuV)</th> </tr> <tr> <th>Quasi-peak</th> <th>Average</th> </tr> </thead> <tbody> <tr> <td>0.15-0.5</td> <td>66 to 56*</td> <td>56 to 46*</td> </tr> <tr> <td>0.5-5</td> <td>56</td> <td>46</td> </tr> <tr> <td>5-30</td> <td>60</td> <td>50</td> </tr> </tbody> </table>	Frequency range (MHz)	Limit (dBuV)		Quasi-peak	Average	0.15-0.5	66 to 56*	56 to 46*	0.5-5	56	46	5-30	60	50
Frequency range (MHz)	Limit (dBuV)														
	Quasi-peak	Average													
0.15-0.5	66 to 56*	56 to 46*													
0.5-5	56	46													
5-30	60	50													
Test Setup:	 <p><i>Remark:</i> E.U.T: Equipment Under Test LISN: Line Impedance Stabilization Network Test table height=0.8m</p>														
Test Mode:	Transmitting Mode														
Test Procedure:	<ol style="list-style-type: none"> 1. The E.U.T is connected to an adapter through a line impedance stabilization network (L.I.S.N.). This provides a 50ohm/50uH coupling impedance for the measuring equipment. 2. The peripheral devices are also connected to the main power through a LISN that provides a 50ohm/50uH coupling impedance with 50ohm termination. (Please refer to the block diagram of the test setup and photographs). 3. Both sides of A.C. line are checked for maximum conducted interference. In order to find the maximum emission, the relative positions of equipment and all of the interface cables must be changed according to ANSI C63.10: 2013 on conducted measurement. 														
Test Result:	PASS														

3.1.2. Test data

Please refer to following diagram for individual

Test Mode	: Full Load
Test Results	: PASS
Note:	<p>The test results are listed in next pages.</p> <p>All test modes has been tested, this report only reflected the worst mode.</p> <p>If the limits for the measurement with the average detector are met when using a receiver with a peak detector, the test unit shall be deemed to meet both limits and the measurement with the average detector and quasi-peak detector need not be carried out.</p> <p>If the limits for the measurement with the average detector are met when using a receiver with a quasi-peak detector, the test unit shall be deemed to meet both limits and the measurement with the average detector need not be carried out.</p>

EUT Description	LED Desk Lamp with 15W Wireless Charger	Model No.	X9D
Temperature	24°C	Humidity	56%
Test Voltage	AC 120V/60Hz		
Pol	Line		

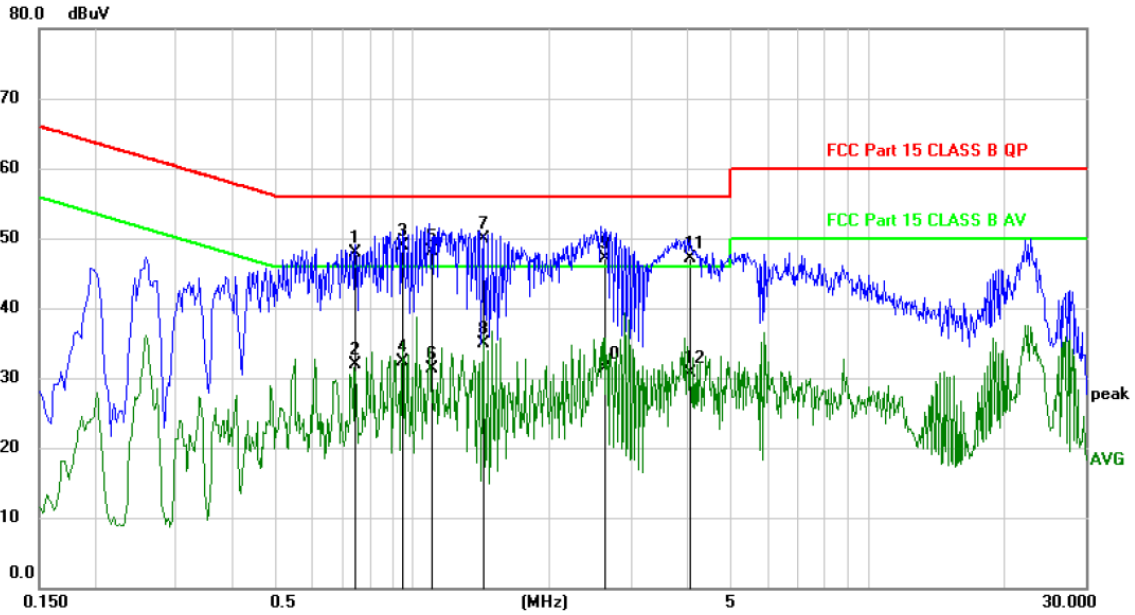

No.	Mk.	Freq. MHz	Reading Level dBuV	Correct Factor dB	Measure- ment dBuV	Limit dBuV	Margin dB	Detector	Comment
1		0.7445	37.90	9.93	47.83	56.00	-8.17	QP	
2		0.7445	21.93	9.93	31.86	46.00	-14.14	AVG	
3		0.9446	38.97	9.95	48.92	56.00	-7.08	QP	
4		0.9446	22.41	9.95	32.36	46.00	-13.64	AVG	
5		1.0907	38.12	9.91	48.03	56.00	-7.97	QP	
6		1.0907	21.44	9.91	31.35	46.00	-14.65	AVG	
7	*	1.4187	39.92	9.90	49.82	56.00	-6.18	QP	
8		1.4187	24.96	9.90	34.86	46.00	-11.14	AVG	
9		2.6347	37.15	9.92	47.07	56.00	-8.93	QP	
10		2.6347	21.40	9.92	31.32	46.00	-14.68	AVG	
11		4.0478	37.12	9.97	47.09	56.00	-8.91	QP	
12		4.0478	20.71	9.97	30.68	46.00	-15.32	AVG	

*:Maximum data x:Over limit !:over margin

(Reference Only)

Note: Measurement=Reading Level+Correc Factor. Factor=(LISN or ISN or PLC or Current Probe)Factor+Cable

Pol	Neutral
------------	---------

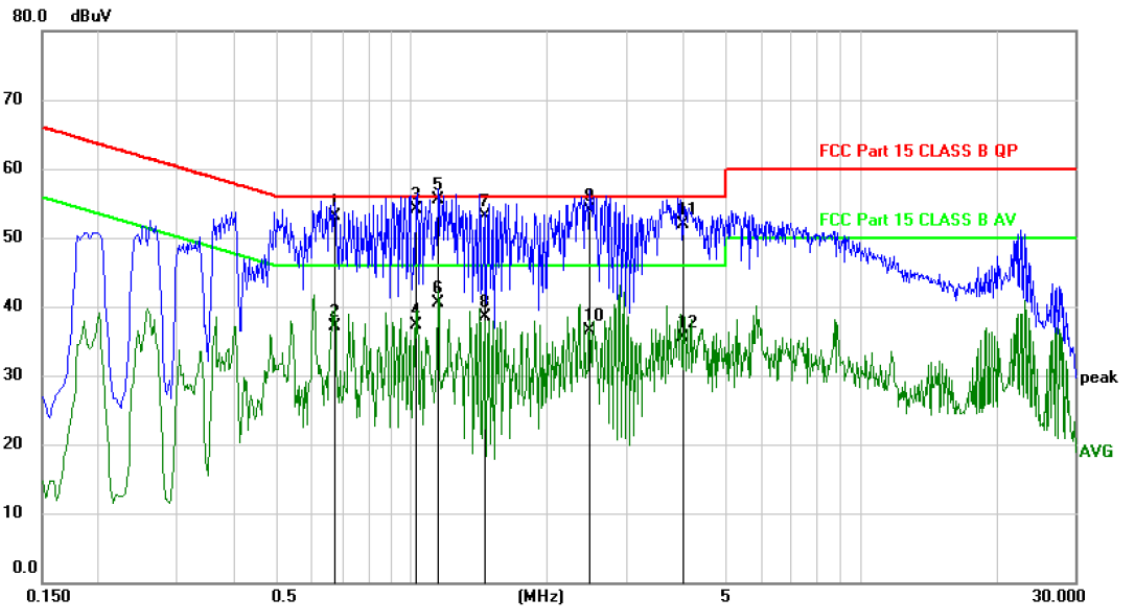

No.	Mk.	Freq. MHz	Reading Level dBuV	Correct Factor dB	Measure- ment dBuV	Limit dBuV	Margin dB	Detector	Comment
1		0.6722	43.11	9.93	53.04	56.00	-2.96	QP	
2		0.6722	27.21	9.93	37.14	46.00	-8.86	AVG	
3		1.0256	44.09	9.92	54.01	56.00	-1.99	QP	
4		1.0256	27.29	9.92	37.21	46.00	-8.79	AVG	
5	*	1.1446	45.62	9.90	55.52	56.00	-0.48	QP	
6		1.1446	30.59	9.90	40.49	46.00	-5.51	AVG	
7		1.4484	43.21	9.89	53.10	56.00	-2.90	QP	
8		1.4484	28.69	9.89	38.58	46.00	-7.42	AVG	
9		2.4863	44.02	9.91	53.93	56.00	-2.07	QP	
10		2.4863	26.62	9.91	36.53	46.00	-9.47	AVG	
11		4.0304	41.88	9.97	51.85	56.00	-4.15	QP	
12		4.0304	25.63	9.97	35.60	46.00	-10.40	AVG	

*:Maximum data x:Over limit !:over margin

⟨Reference Only

Note: Measurement=Reading Level+Correc Factor. Factor=(LISN or ISN or PLC or Current Probe)Factor+Cable

3.2. Radiated Spurious Emission Measurement

3.2.1. Test Specification

Test Requirement:	FCC Part15 C Section 15.209				
Test Method:	ANSI C63.10: 2013				
Frequency Range:	9 kHz to 25 GHz				
Measurement Distance:	3 m				
Antenna Polarization:	Horizontal & Vertical				
Operation mode:	Refer to item 4.1				
Receiver Setup:	Frequency	Detector	RBW	VBW	Remark
	9kHz-150kHz	Quasi-peak	200Hz	1kHz	Quasi-peak Value
	150kHz-30MHz	Quasi-peak	9kHz	30kHz	Quasi-peak Value
	30MHz-1GHz	Quasi-peak	100kHz	300kHz	Quasi-peak Value
	Above 1GHz	Peak	1MHz	3MHz	Peak Value
		Peak	1MHz	10Hz	Average Value
Limit:	Frequency		Field Strength (microvolts/meter)		Measurement Distance (meters)
	0.009-0.490		2400/F(KHz)		300
	0.490-1.705		24000/F(KHz)		30
	1.705-30		30		30
	30-88		100		3
	88-216		150		3
	216-960		200		3
	Above 960		500		3
	Frequency		Field Strength (microvolts/meter)	Measurement Distance (meters)	Detector
	Above 1GHz		500	3	Average
		5000	3	Peak	
Test setup:	For radiated emissions below 30MHz				
	<p>30MHz to 1GHz</p>				

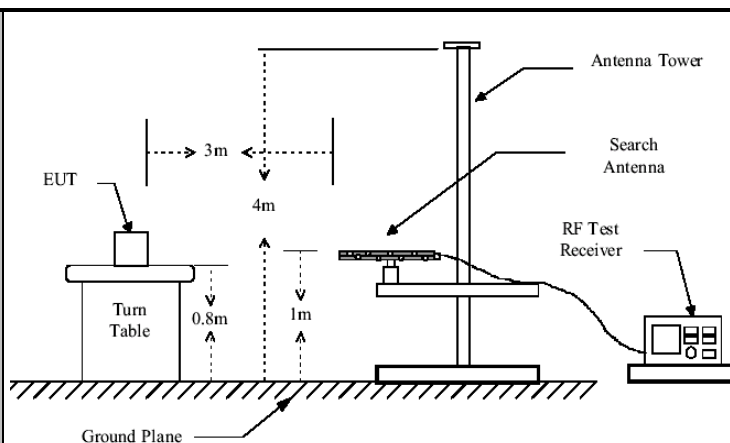

Above 1GHz

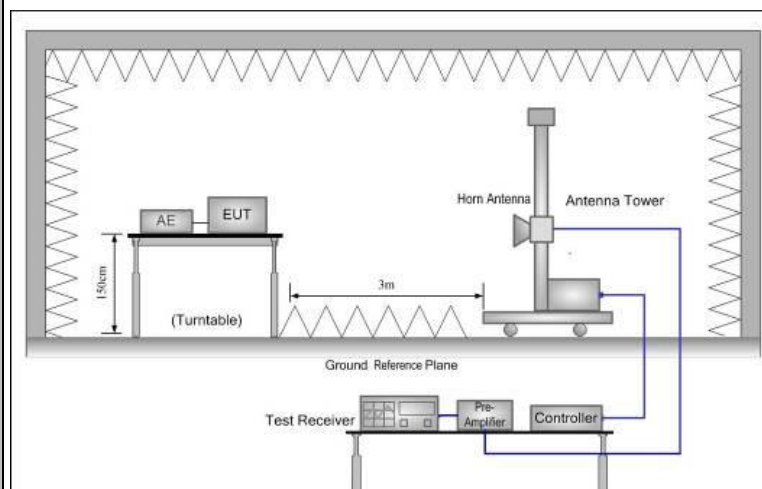
**Test Procedure:****1. For the radiated emission test below 1GHz:**

The EUT was placed on a turntable with 0.8 meter above ground. The EUT was set 3 meters from the interference receiving antenna, which was mounted on the top of a variable height antenna tower. The EUT was arranged to its worst case and then tune the antenna tower (from 1 m to 4 m) and turntable (from 0 degree to 360 degrees) to find the maximum reading. A pre-amp and a high PASS filter are used for the test in order to get better signal level.

For the radiated emission test above 1GHz:

Place the measurement antenna on a turntable with 1.5 meter above ground, which is away from each area of the EUT determined to be a source of emissions at the specified measurement distance, while keeping the measurement antenna aimed at the source of emissions at each frequency of significant emissions, with polarization oriented for maximum response. The measurement antenna may have to be higher or lower than the EUT, depending on the radiation pattern of the emission and staying aimed at the emission source for receiving the maximum signal. The final measurement antenna elevation shall be that which maximizes the emissions. The measurement antenna elevation for maximum emissions shall be restricted to a range of heights of from 1 m to 4 m above the ground or reference ground plane.

2. Corrected Reading: Antenna Factor + Cable Loss + Read Level - Preamp Factor = Level
3. For measurement below 1GHz, If the emission level of the EUT measured by the peak detector is 3 dB lower than the applicable limit, the peak emission level will be reported.

	<p>Otherwise, the emission measurement will be repeated using the quasi-peak detector and reported.</p> <p>4. Use the following spectrum analyzer settings:</p> <p>(1) Span shall wide enough to fully capture the emission being measured;</p> <p>(2) Set RBW=100 kHz for $f < 1$ GHz; $VBW \geq RBW$; Sweep = auto; Detector function = peak; Trace = max hold;</p> <p>(3) Set RBW = 1 MHz, $VBW = 3$ MHz for $f \geq 1$ GHz for peak measurement.</p> <p>For average measurement: $VBW = 10$ Hz, when duty cycle is no less than 98 percent. $VBW \geq 1/T$, when duty cycle is less than 98 percent where T is the minimum transmission duration over which the transmitter is on and is transmitting at its maximum power control level for the tested mode of operation.</p>
Test mode:	Refer to section 4.1 for details
Test results:	PASS

3.2.2. Test Data

Please refer to following diagram for individual

Frequency Range	: 9KHz~30MHz
Test Mode	: TX: 146kHz
Test Results	: PASS
Note:	<ol style="list-style-type: none">1. The test results are listed in next pages.2. This mode is worst case mode, so this report only reflected the worst mode.3. If the limits for the measurement with the average detector are met when using a receiver with a peak detector, the test unit shall be deemed to meet both limits and the measurement with the quasi-peak detector need not be carried out.

For signal coil:

Polarity: X axis

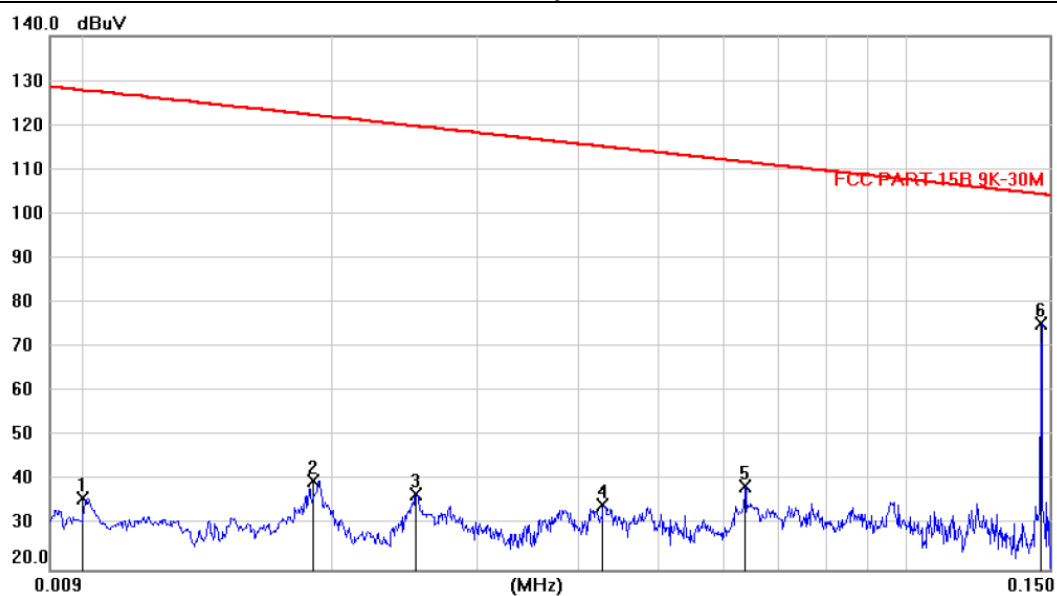

No.	Mk.	Freq. MHz	Reading Level dBuV	Correct Factor dB	Measure- ment dBuV	Limit dBuV	Margin dB	Detector	Antenna Height cm	Table Degree	Comment
1		0.0100	14.56	21.50	36.06	127.6	-91.63	peak			
2		0.0189	18.58	21.27	39.85	122.1	-82.33	peak			
3		0.0252	15.84	21.12	36.96	119.6	-82.73	peak			
4		0.0427	14.11	20.30	34.41	115.1	-80.72	peak			
5		0.0637	18.75	20.11	38.86	111.6	-72.80	peak			
6	*	0.1466	55.31	20.15	75.46	104.4	-28.99	peak			

Note:1. *:Maximum data; x:Over limit; !:over margin.

2.Measurement=Reading Level+Correct Factor; Correct Factor=Antenna Factor+Cable Loss.

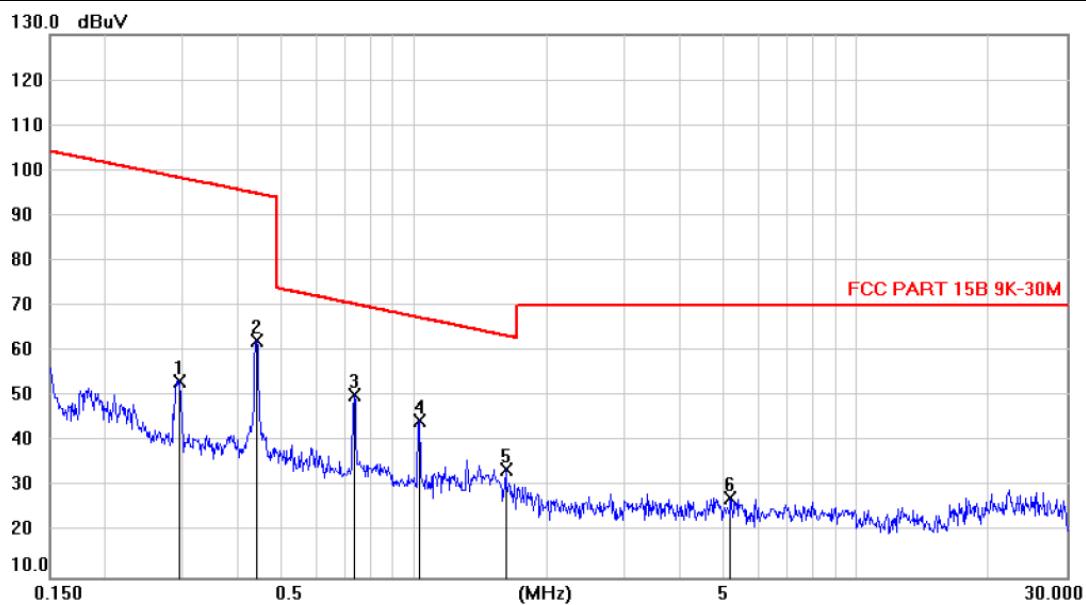

No.	Mk.	Freq. MHz	Reading Level dBuV	Correct Factor dB	Measure- ment dBuV	Limit dBuV	Margin dB	Detector	Antenna Height cm	Table Degree	Comment
1		0.2943	33.34	19.99	53.33	98.41	-45.08	peak			
2		0.4400	42.67	19.79	62.46	94.93	-32.47	peak			
3	*	0.7335	30.52	19.84	50.36	70.44	-20.08	peak			
4		1.0281	24.74	20.01	44.75	67.46	-22.71	peak			
5		1.6133	13.82	20.15	33.97	63.49	-29.52	peak			
6		5.2046	5.79	21.71	27.50	70.00	-42.50	peak			

Note:1. *:Maximum data; x:Over limit; !:over margin.

2.Measurement=Reading Level+Correct Factor; Correct Factor=Antenna Factor+Cable Loss.

Frequency Range	: 30MHz~1000MHz
Test Mode	: Full Load
Test Results	: PASS
Note:	<p>1. The test results are listed in next pages.</p> <p>2. All test modes has been tested, this report only reflected the worst mode.</p> <p>3. If the limits for the measurement with the average detector are met when using a receiver with a peak detector, the test unit shall be deemed to meet both limits and the measurement with the quasi-peak detector need not be carried out.</p>

Frequency Range	: Above 1GHz		
EUT	: /	Test Date	: /
M/N	: /	Temperature	: /
Test Engineer	: /	Humidity	: /
Test Mode	: /		
Test Results	: N/A		
Note:	<p>1. The highest frequency of the internal sources of the EUT is less than 108 MHz, the measurement shall only be made up to 1 GHz. So the frequency rang above 1GHz radiation test not applicable.</p>		

30MHz-1GHz

EUT Description	LED Desk Lamp with 15W Wireless Charger	Model No.	X9D
Temperature	24°C	Humidity	56%
Test Voltage	AC 120V/60Hz		
Pol	Vertical		

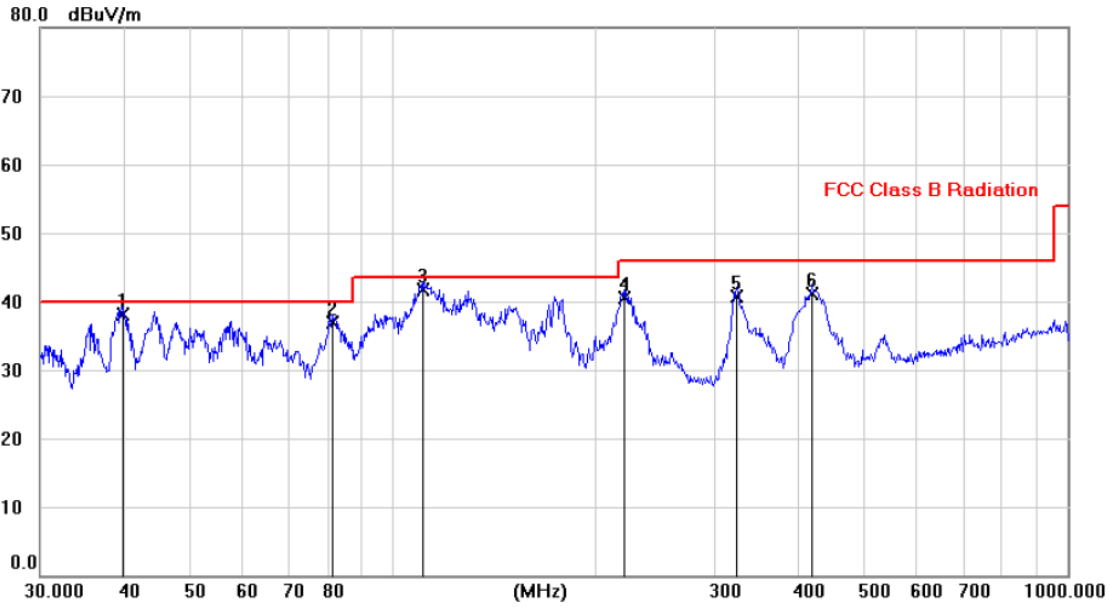

No.	Mk.	Freq.	Reading Level	Correct Factor	Measurement	Limit	Margin	Antenna Height	Table Degree	
		MHz	dBuV	dB	dBuV/m	dBuV/m	dB	cm	degree	Comment
1		39.7796	22.98	15.03	38.01	40.00	-1.99	QP		
2		81.3352	26.24	10.63	36.87	40.00	-3.13	QP		
3	*	111.2686	29.01	12.76	41.77	43.50	-1.73	QP		
4		220.6428	27.72	12.84	40.56	46.00	-5.44	QP		
5		323.8498	24.86	15.89	40.75	46.00	-5.25	QP		
6		418.6673	23.12	17.94	41.06	46.00	-4.94	QP		

Note:1. *:Maximum data; x:Over limit; !:over margin.

2.Measurement=Reading Level+Correct Factor; Correct Factor=Antenna Factor+Cable Loss.

Pol	Horizontal
------------	------------

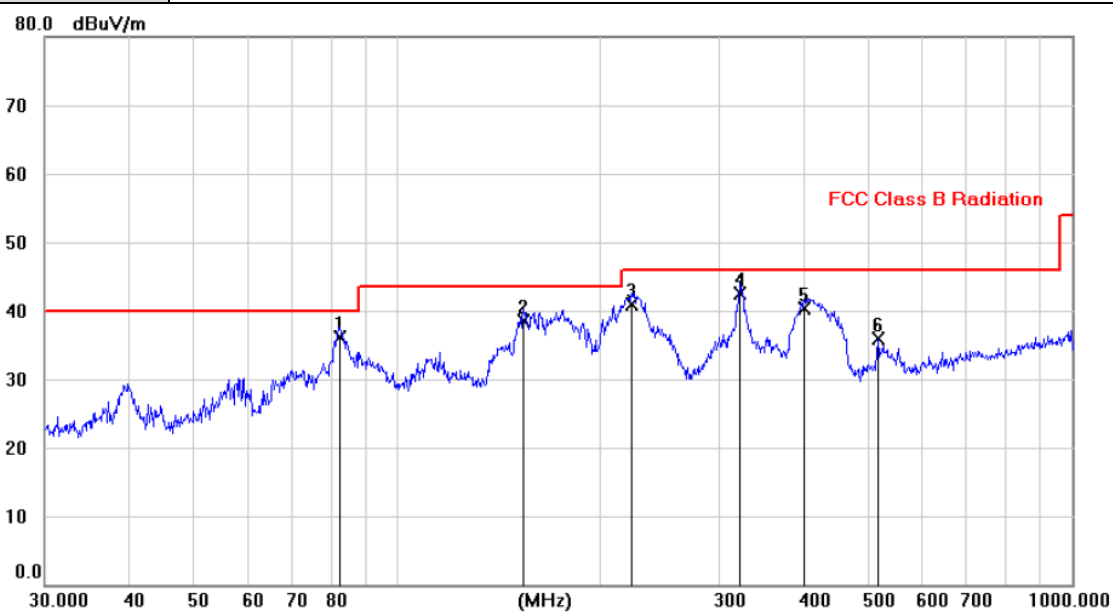

No.	Mk.	Freq. MHz	Reading Level dBuV	Correct Factor dB	Measure- ment dBuV/m	Limit dBuV/m	Margin dB	Antenna Height cm	Table Degree degree	Comment
1		82.1856	25.41	10.64	36.05	40.00	-3.95	QP		
2		153.8103	22.43	16.02	38.45	43.50	-5.05	QP		
3		222.9241	27.88	12.99	40.87	46.00	-5.13	QP		
4	*	322.6408	26.58	15.87	42.45	46.00	-3.55	QP		
5		401.2751	22.80	17.50	40.30	46.00	-5.70	QP		
6		517.1875	15.91	19.91	35.82	46.00	-10.18	peak		

Note:1. *:Maximum data; x:Over limit; !:over margin.

2.Measurement=Reading Level+Correct Factor; Correct Factor=Antenna Factor+Cable Loss.

3.3. Test Specification

Test Requirement:	FCC Part15 C Section 15.215(c)
Test Method:	ANSI C63.10: 2013
Limit:	N/A
Test Procedure:	<ol style="list-style-type: none"> 1. According to the follow Test-setup, keep the relative position between the artificial antenna and the EUT. 2. Set to the maximum power setting and enable the EUT transmit continuously. 3. Use the following spectrum analyzer settings for 20dB Bandwidth measurement. Span = approximately 2 to 3 times the 20 dB bandwidth, centered on a hopping channel; RBW\geq1% of the 20 dB bandwidth; VBW\geqRBW; Sweep = auto; Detector function = peak; Trace = max hold. 4. Measure and record the results in the test report.
Test setup:	 <p>The diagram illustrates the test setup. On the left is a Spectrum Analyzer, represented by a green rectangle with a blue screen and two red dots. A black cable connects the Spectrum Analyzer to a yellow rectangle on the right, which is labeled 'EUT'. A small white square is positioned in the middle of the cable, representing a connector or adapter. Below the Spectrum Analyzer is the text 'Spectrum Analyzer' and below the EUT is the text 'EUT'.</p>
Test Mode:	Refer to section 4.1 for details
Test results:	PASS

4. Photos of test setup

Radiated Emission

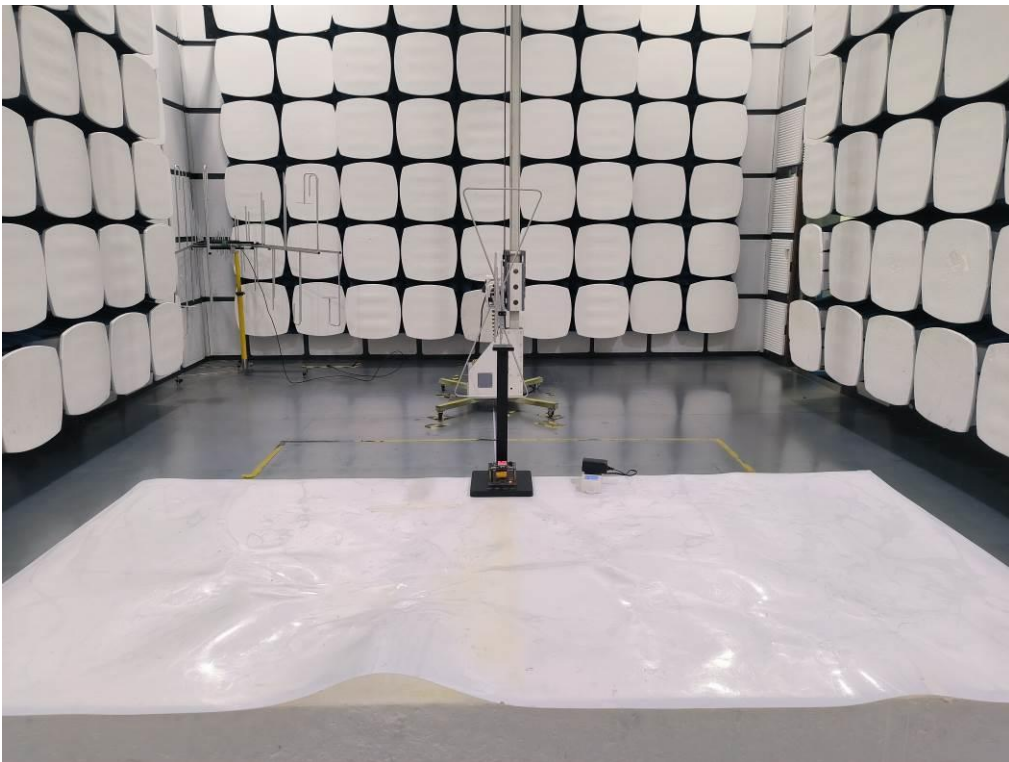
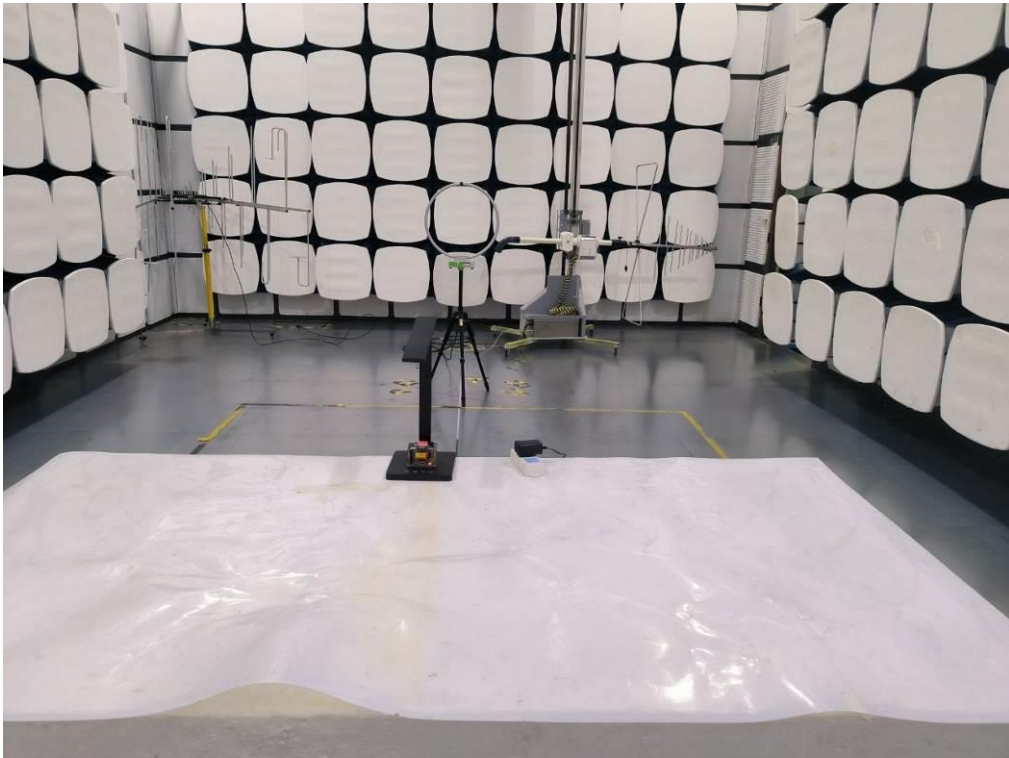

Conducted Emission

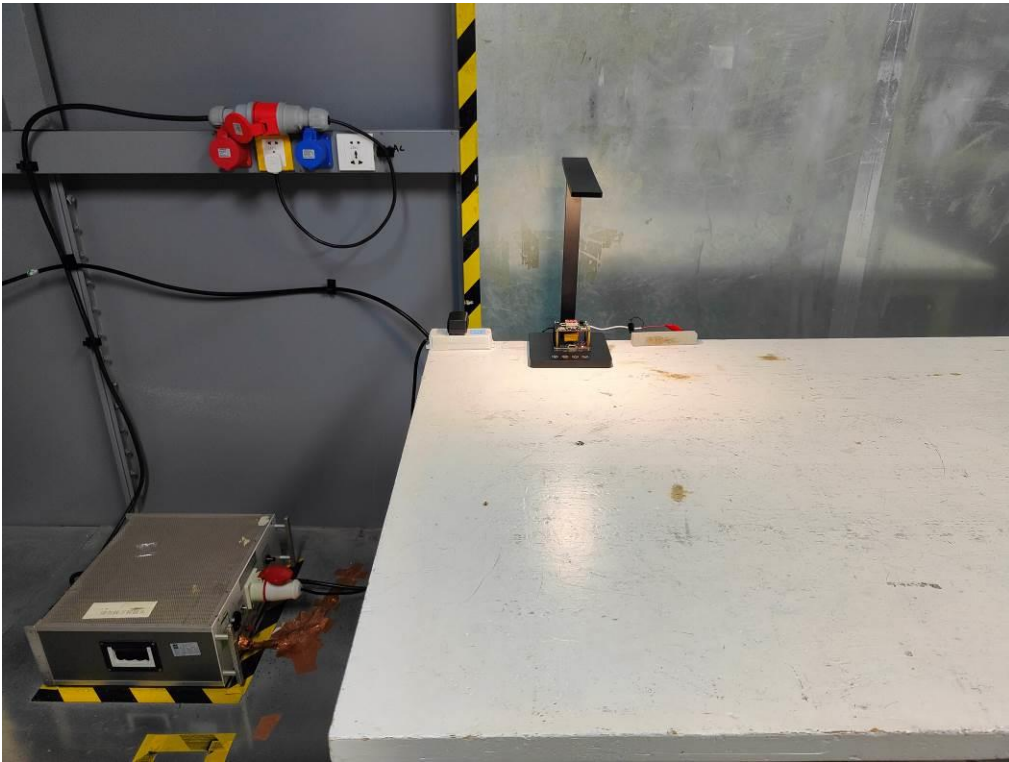

5. Photographs of EUT

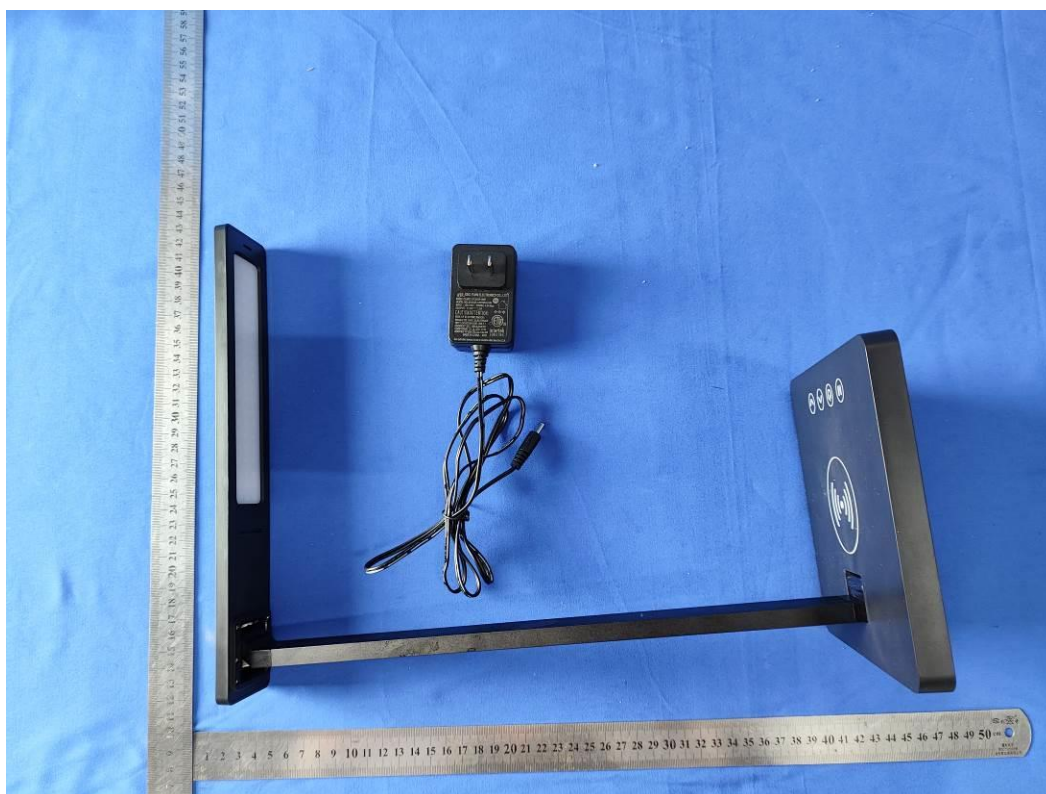

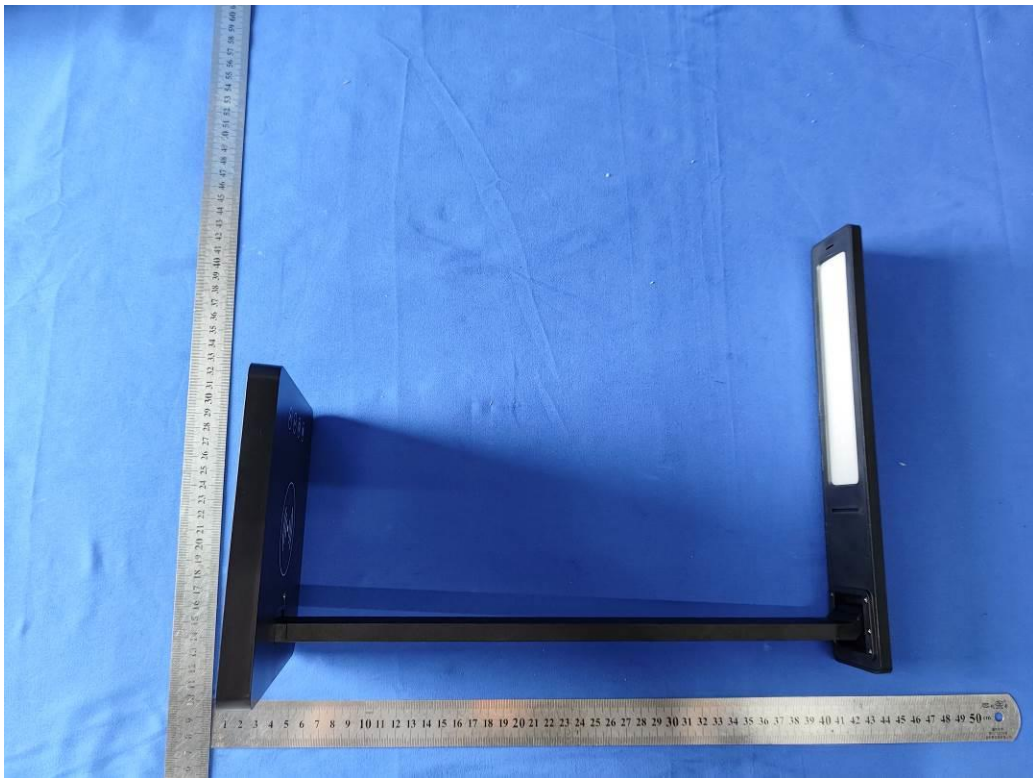
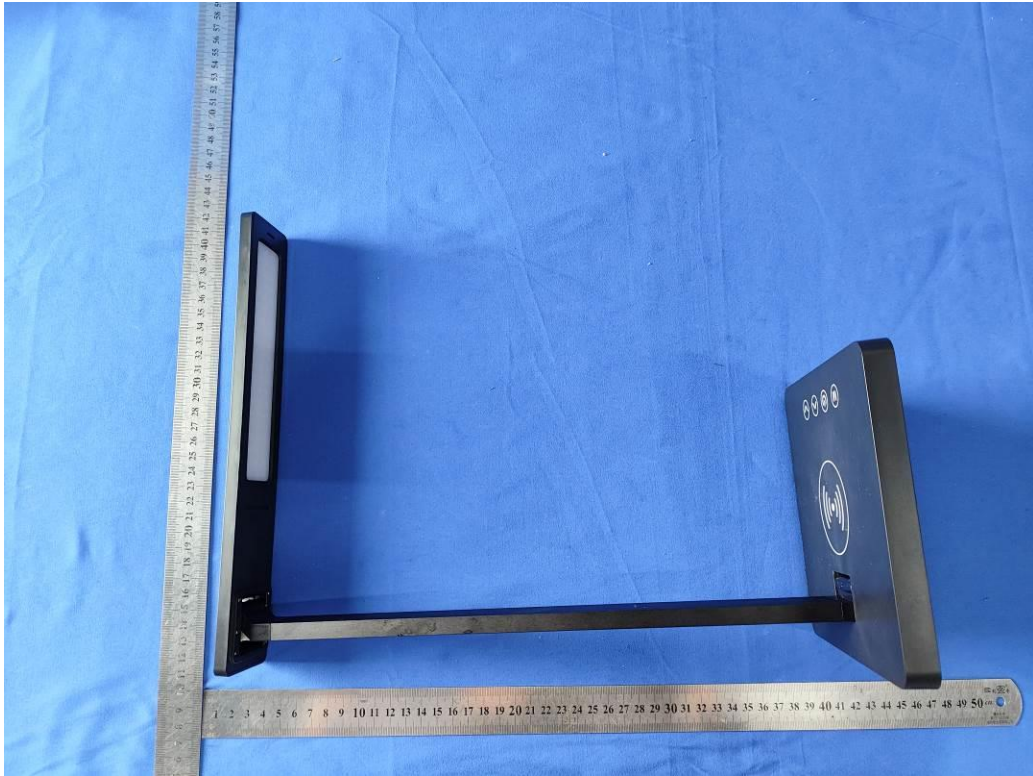

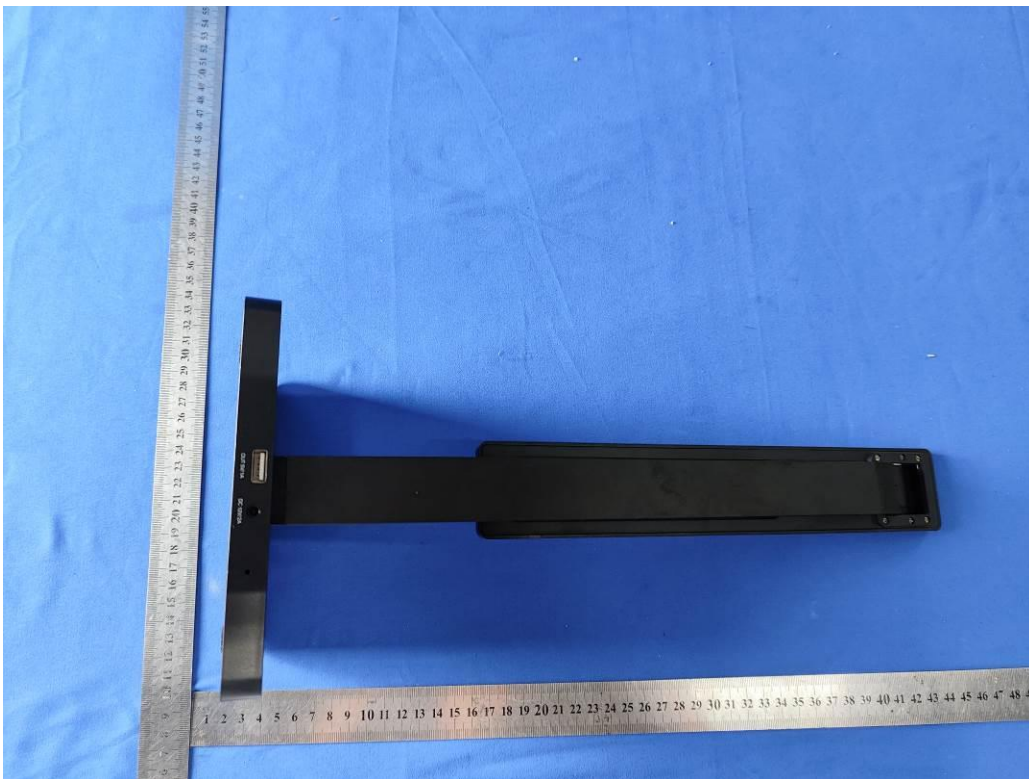

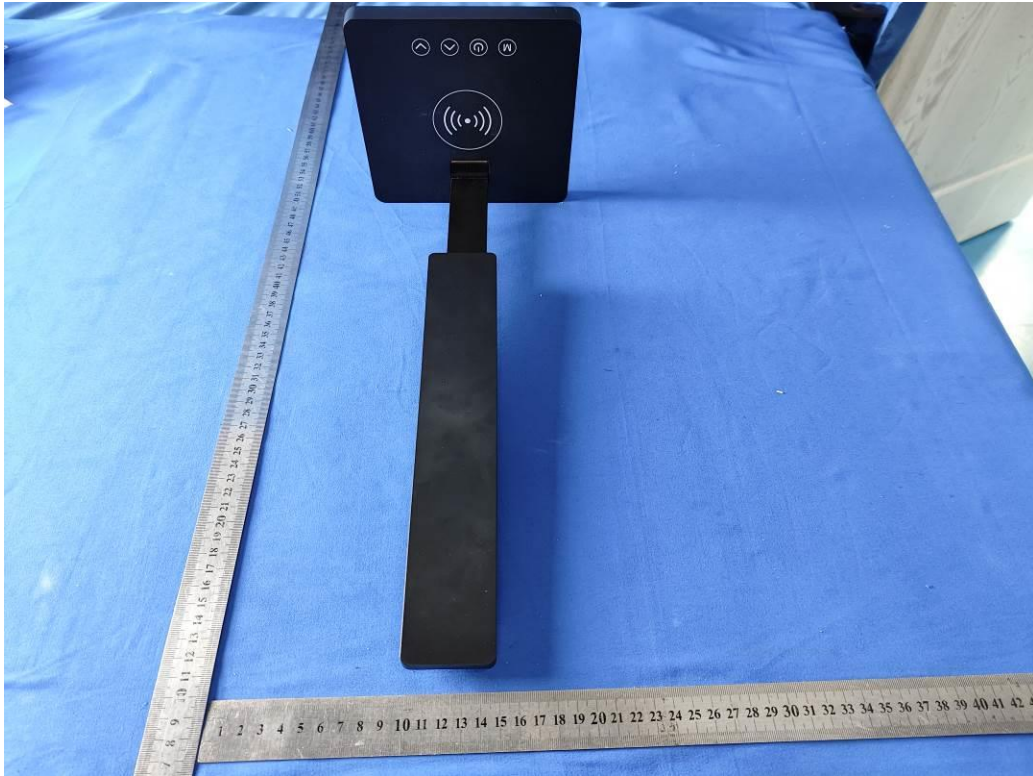

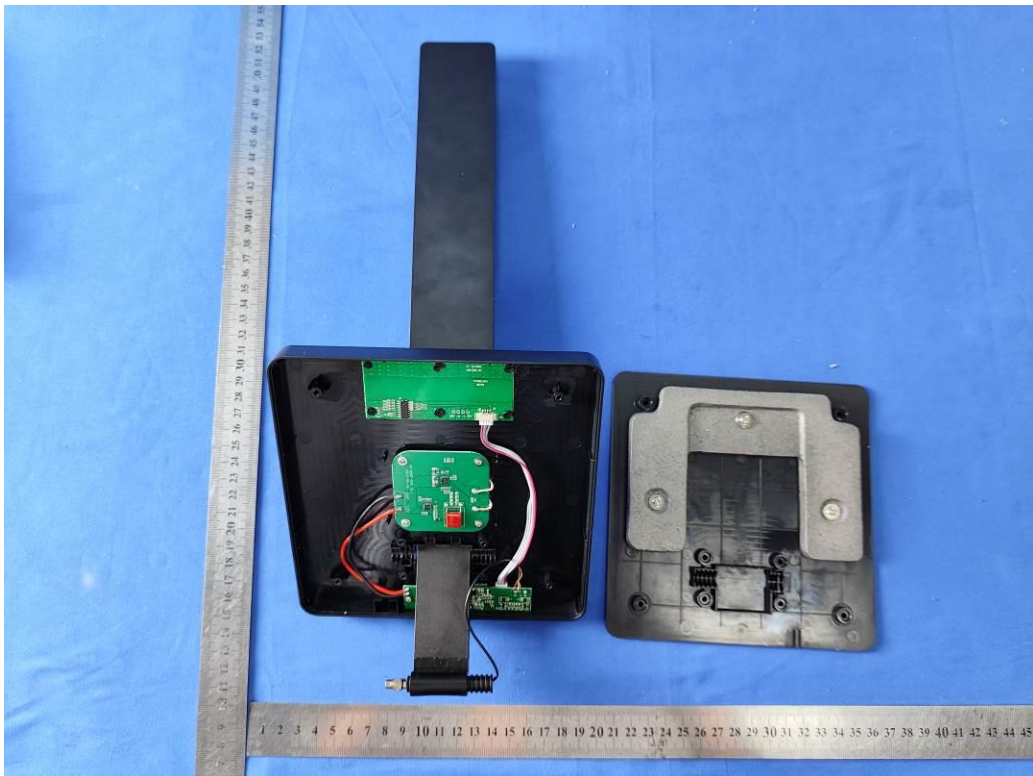

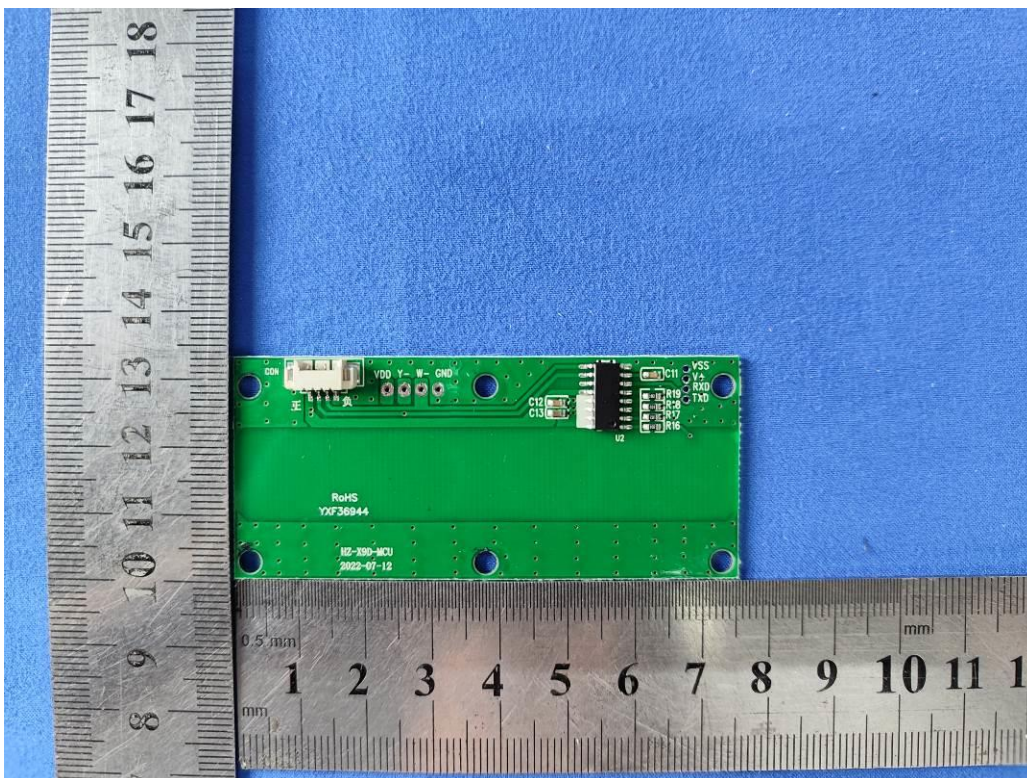
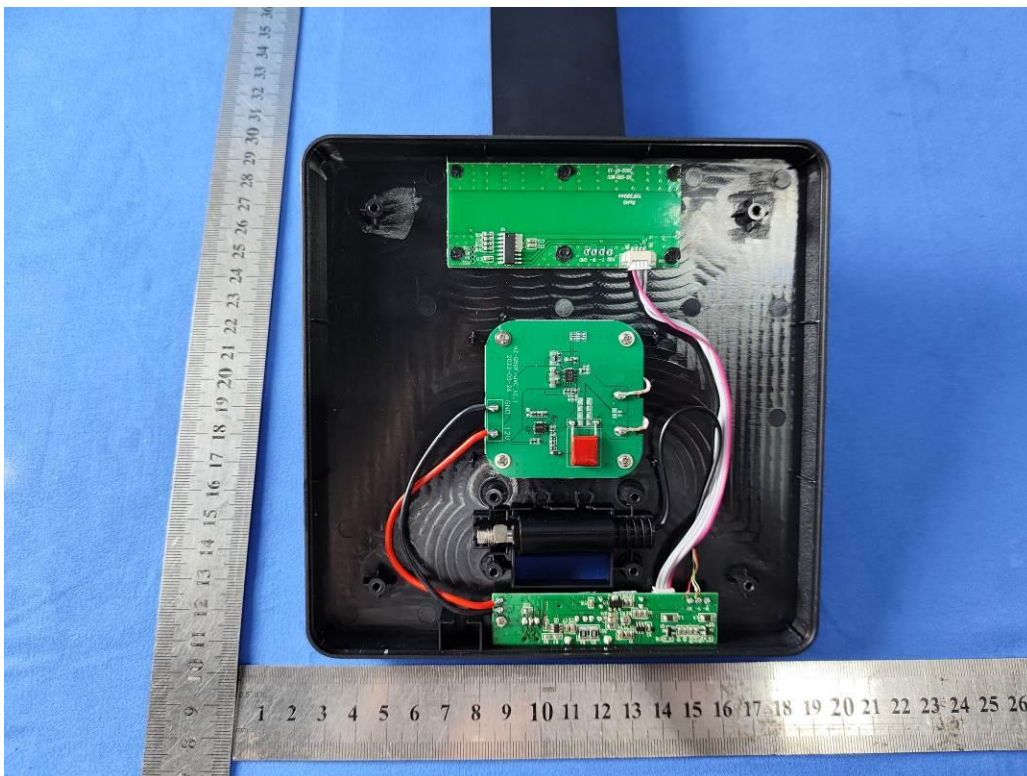

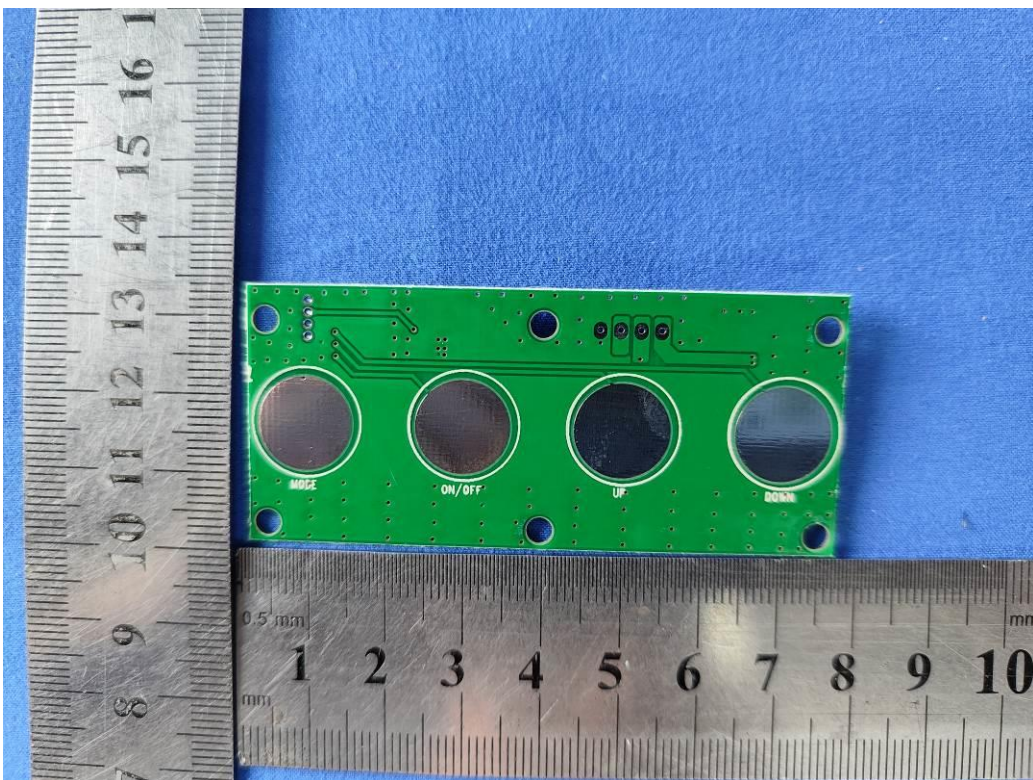
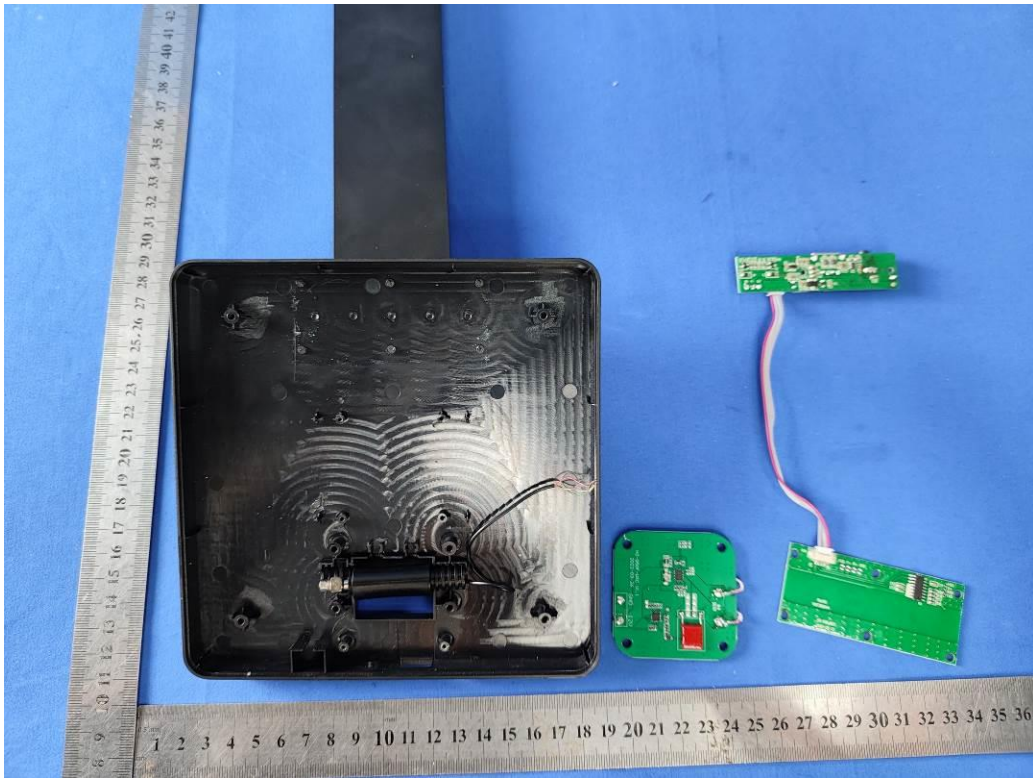

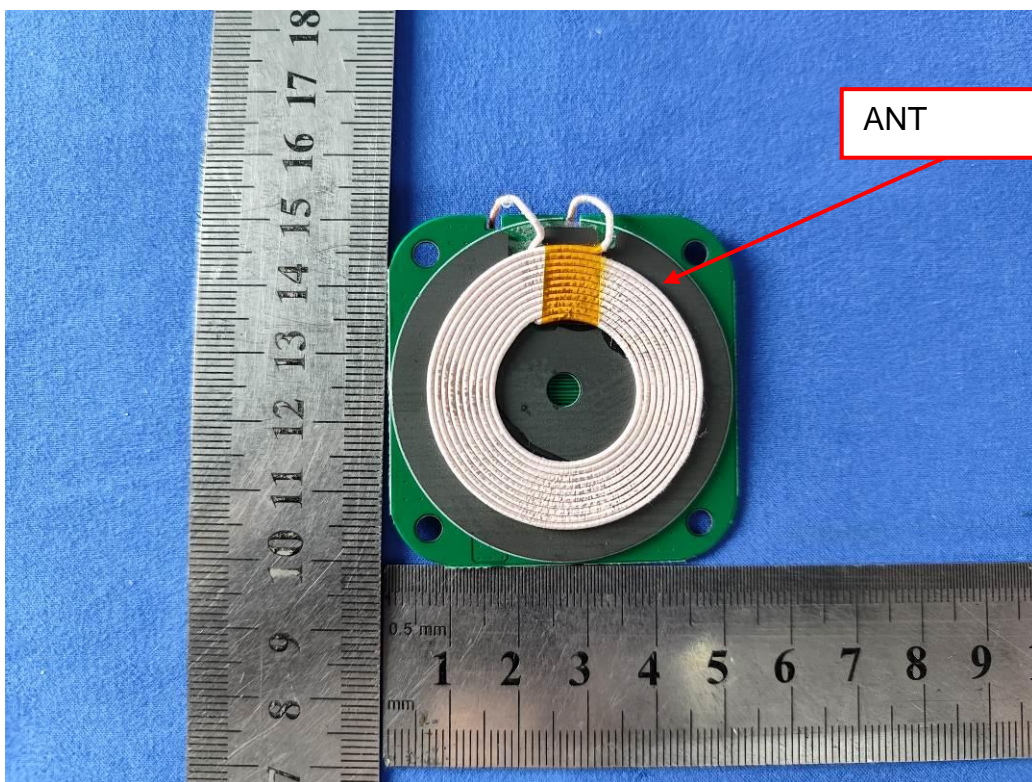
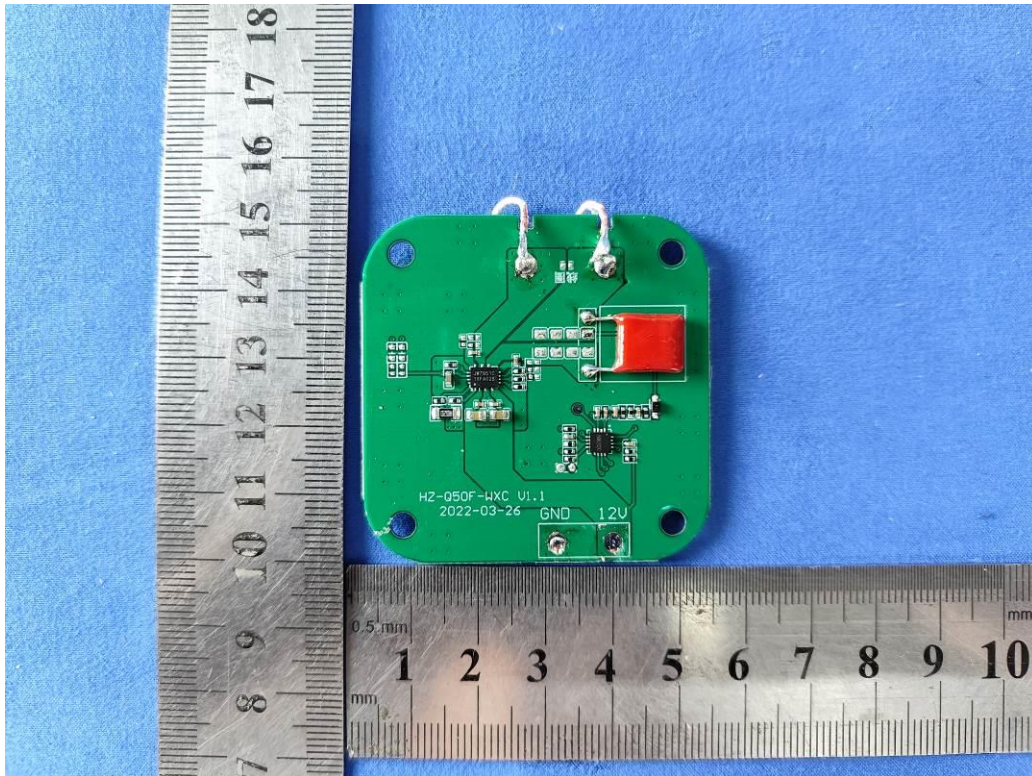

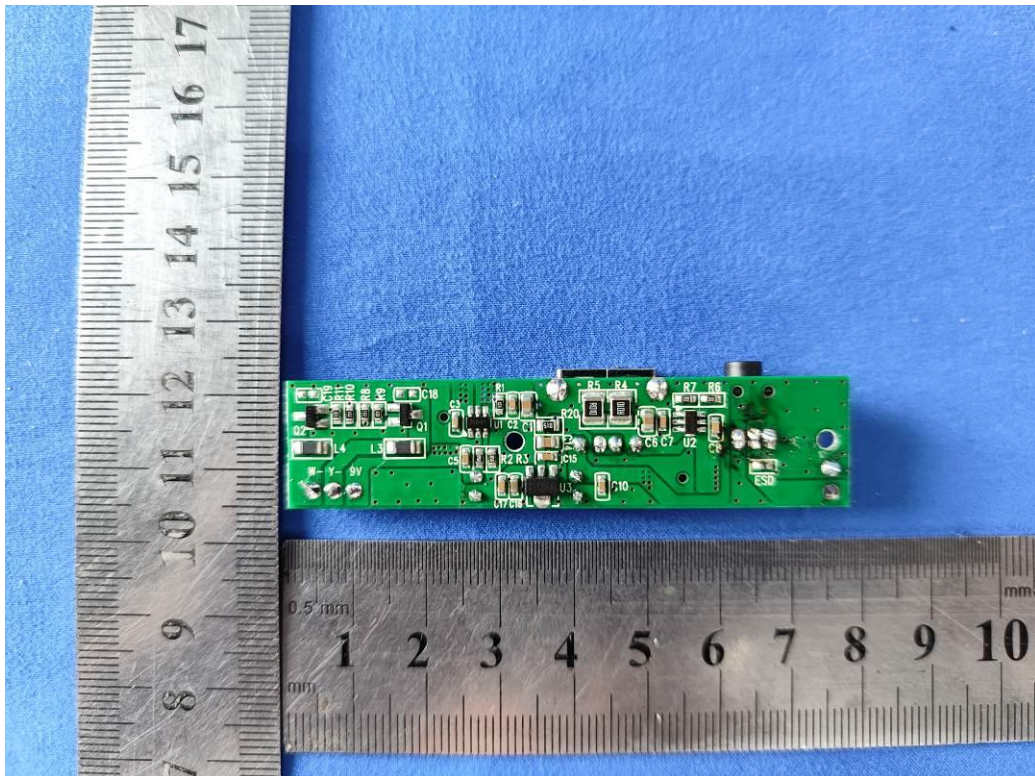
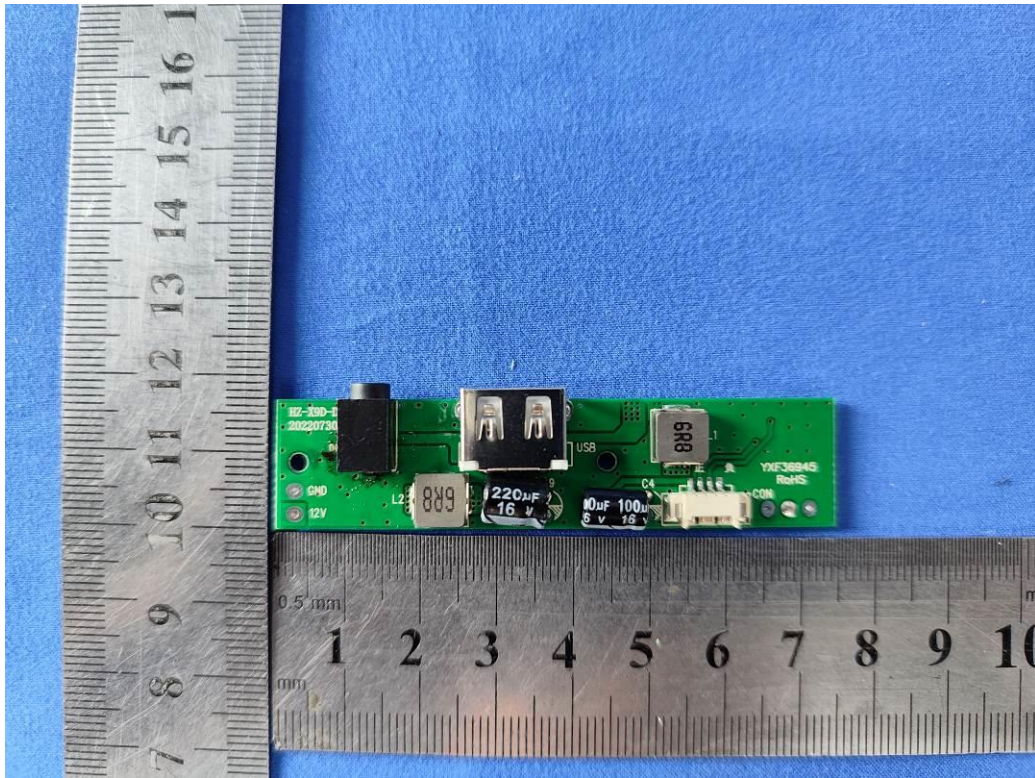

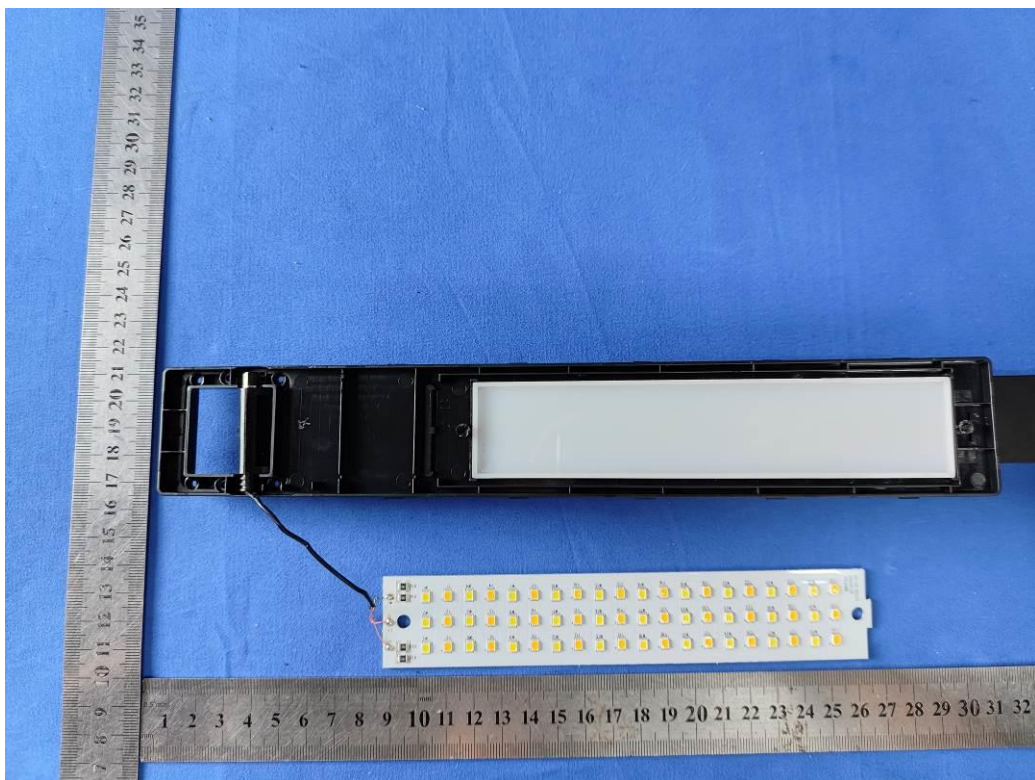

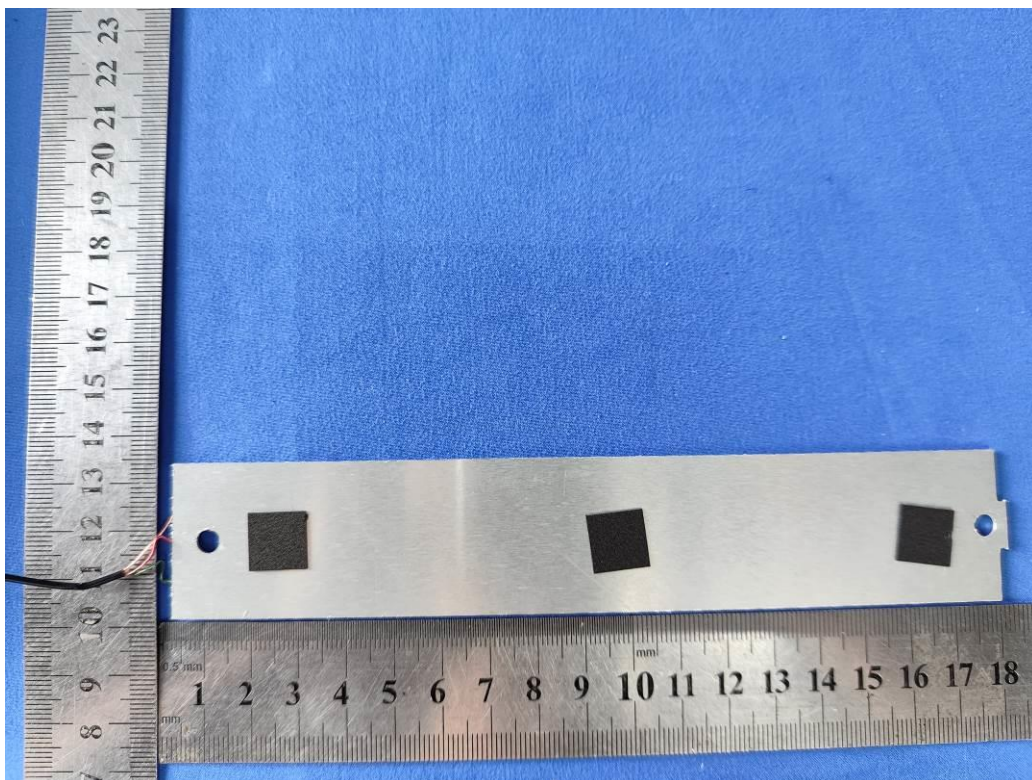
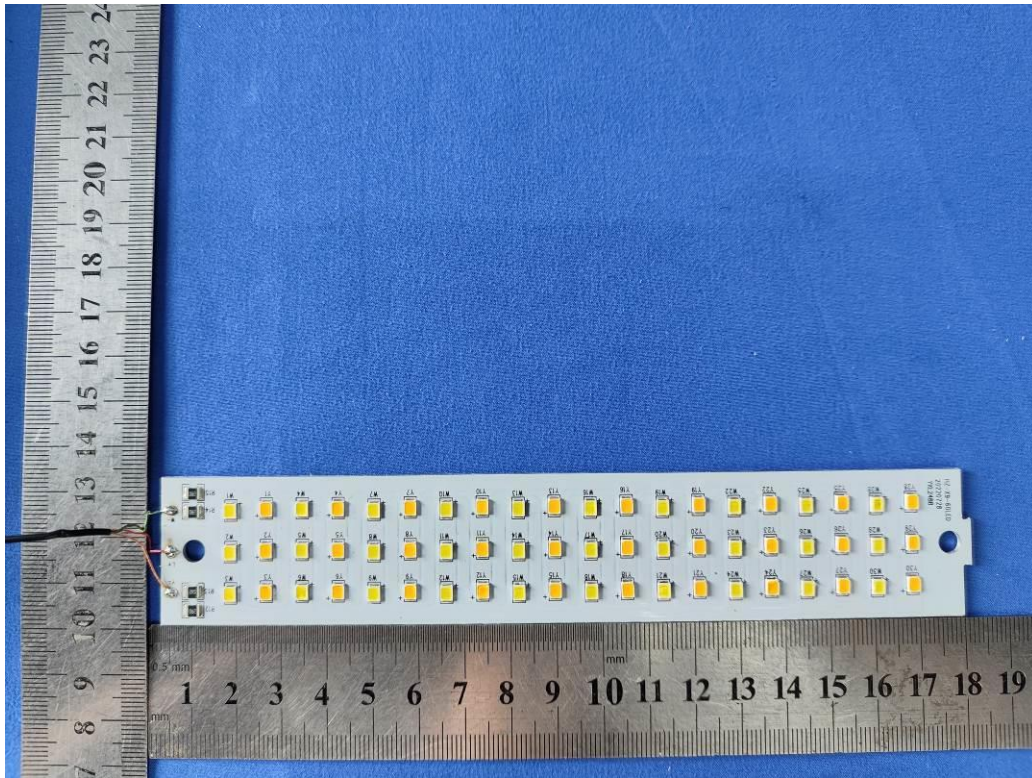

----- END OF REPORT-----