

TEST REPORT (Bluetooth)

Applicant: Quantum Creations LLC.

Address of Applicant: 15705 NW 13th Ave, Miami Gardens, Miami Beach, Florida, United States 33169

Manufacturer/Factory: QUTHC Limited

Address of Manufacturer/Factory: 7th Floor, Building C, Longsheng Industrial Park, Huiyang District, Huizhou City, Guangdong province (516211) P.R.China

Equipment Under Test (EUT)

Product Name: Access4

Model No.: AG3221, AG3111, AG3112, AG3113, AG3222, AG3223, AG3211, AG3212, AG3213, AG3121, AG3122, AG3123

Trade Mark: AZULLE

FCC ID: 2AFJI-ACCESS4

Applicable standards: FCC CFR Title 47 Part 15 Subpart C Section 15.247

Date of sample receipt: April 27, 2020

Date of Test: April 27, 2020-May 07, 2020

Date of report issued: May 07, 2020

Test Result : PASS *

* In the configuration tested, the EUT complied with the standards specified above.

Authorized Signature:



Robinson Lo

Laboratory Manager

This results shown in this test report refer only to the sample(s) tested, this test report cannot be reproduced, except in full, without prior written permission of the company. The report would be invalid without specific stamp of test institute and the signatures of compiler and approver.

2 Version

| Version No. | Date | Description |
|-------------|--------------|-------------|
| 00 | May 07, 2020 | Original |
| | | |
| | | |
| | | |
| | | |

Prepared By: Tiger Chen **Date:** May 07, 2020
Project Engineer

Check By: Robinson **Date:** May 07, 2020
Reviewer

3 Contents

| | Page |
|---|-----------|
| 1 COVER PAGE | 1 |
| 2 VERSION | 2 |
| 3 CONTENTS | 3 |
| 4 TEST SUMMARY | 4 |
| 5 GENERAL INFORMATION | 5 |
| 5.1 GENERAL DESCRIPTION OF EUT | 5 |
| 5.2 TEST MODE | 7 |
| 5.3 DESCRIPTION OF SUPPORT UNITS | 7 |
| 5.4 DEVIATION FROM STANDARDS | 7 |
| 5.5 ABNORMALITIES FROM STANDARD CONDITIONS | 7 |
| 5.6 TEST FACILITY | 7 |
| 5.7 TEST LOCATION | 7 |
| 5.8 ADDITIONAL INSTRUCTIONS | 7 |
| 6 TEST INSTRUMENTS LIST | 8 |
| 7 TEST RESULTS AND MEASUREMENT DATA | 10 |
| 7.1 ANTENNA REQUIREMENT | 10 |
| 7.2 CONDUCTED EMISSIONS | 11 |
| 7.3 CONDUCTED PEAK OUTPUT POWER | 14 |
| 7.4 20dB EMISSION BANDWIDTH | 18 |
| 7.5 CARRIER FREQUENCIES SEPARATION | 22 |
| 7.6 HOPPING CHANNEL NUMBER | 26 |
| 7.7 DWELL TIME | 27 |
| 7.8 PSEUDORANDOM FREQUENCY HOPPING SEQUENCE | 29 |
| 7.9 BAND EDGE | 30 |
| 7.9.1 <i>Conducted Emission Method</i> | 30 |
| 7.9.2 <i>Radiated Emission Method</i> | 34 |
| 7.10 SPURIOUS EMISSION | 36 |
| 7.10.1 <i>Conducted Emission Method</i> | 36 |
| 7.10.2 <i>Radiated Emission Method</i> | 40 |
| 8 TEST SETUP PHOTO | 48 |
| 9 EUT CONSTRUCTIONAL DETAILS | 48 |

4 Test Summary

| Test Item | Section in CFR 47 | Result |
|---|-------------------|--------|
| Antenna Requirement | 15.203/15.247 (c) | Pass |
| AC Power Line Conducted Emission | 15.207 | Pass |
| Conducted Peak Output Power | 15.247 (b)(1) | Pass |
| 20dB Occupied Bandwidth | 15.247 (a)(1) | Pass |
| Carrier Frequencies Separation | 15.247 (a)(1) | Pass |
| Hopping Channel Number | 15.247 (a)(1) | Pass |
| Dwell Time | 15.247 (a)(1) | Pass |
| Pseudorandom Frequency Hopping Sequence | 15.247(b)(4) | Pass |
| Radiated Emission | 15.205/15.209 | Pass |
| Band Edge | 15.247(d) | Pass |

Remarks:

1. Pass: The EUT complies with the essential requirements in the standard.
2. Test according to ANSI C63.10:2013

Measurement Uncertainty

| Test Item | Frequency Range | Measurement Uncertainty | Notes |
|----------------------------------|-----------------|-------------------------|-------|
| Radiated Emission | 30MHz-200MHz | 3.8039dB | (1) |
| Radiated Emission | 200MHz-1GHz | 3.9679dB | (1) |
| Radiated Emission | 1GHz-18GHz | 4.29dB | (1) |
| Radiated Emission | 18GHz-40GHz | 3.30dB | (1) |
| AC Power Line Conducted Emission | 0.15MHz ~ 30MHz | 3.44dB | (1) |

Note (1): The measurement uncertainty is for coverage factor of k=2 and a level of confidence of 95%.

5 General Information

5.1 General Description of EUT

| Product Name: | Access4 | | | |
|--|---|--------------|---------------|----------------|
| Model No.: | AG3221, AG3111, AG3112, AG3113, AG3222, AG3223, AG3211, AG3212, AG3213, AG3121, AG3122, AG3123 | | | |
| Test Model No: | AG3221 | | | |
| Remark: All models have the same motherboard and wifi module, the difference between different model is DDR capacity, EMMC capacity and OS, the following table illustrates these differences. | | | | |
| Model | Processor | DDR capacity | eMMC capacity | OS |
| AG3111 | Gemini Lake | 2 | 32 | Windows 10 Pro |
| AG3112 | Gemini Lake | 2 | 32 | Windows IOT |
| AG3113 | Gemini Lake | 2 | 32 | NO OS |
| AG3221 | Gemini Lake | 4 | 64 | Windows 10 Pro |
| AG3222 | Gemini Lake | 4 | 64 | Windows IOT |
| AG3223 | Gemini Lake | 4 | 64 | NO OS |
| AG3211 | Gemini Lake | 4 | 32 | Windows 10 Pro |
| AG3212 | Gemini Lake | 4 | 32 | Windows IOT |
| AG3213 | Gemini Lake | 4 | 32 | NO OS |
| AG3121 | Gemini Lake | 2 | 64 | Windows 10 Pro |
| AG3122 | Gemini Lake | 2 | 64 | Windows IOT |
| AG3123 | Gemini Lake | 2 | 64 | NO OS |
| Test sample(s) ID: | GTS202004000210-1 | | | |
| Sample(s) Status: | Engineer sample | | | |
| Serial No.: | ACCESS4-2004200001 | | | |
| Hardware Version: | V30 | | | |
| Software Version: | V1.10 | | | |
| Operation Frequency: | 2402MHz~2480MHz | | | |
| Channel numbers: | 79 | | | |
| Channel separation: | 1MHz | | | |
| Modulation type: | GFSK, $\pi/4$ -DQPSK, 8-DPSK | | | |
| Antenna Type: | FPCB Antenna | | | |
| Antenna gain: | 0.5dBi | | | |
| Power supply: | SWITCHING ADAPTOR Model No.:FJ-SW126G0503000N Input: AC 100-240V 50/60Hz 0.6A Max Output: DC 5.0V 3.0A 15.0W | | | |

| Operation Frequency each of channel | | | | | | | |
|-------------------------------------|-----------|---------|-----------|---------|-----------|---------|-----------|
| Channel | Frequency | Channel | Frequency | Channel | Frequency | Channel | Frequency |
| 1 | 2402MHz | 21 | 2422MHz | 41 | 2442MHz | 61 | 2462MHz |
| 2 | 2403MHz | 22 | 2423MHz | 42 | 2443MHz | 62 | 2463MHz |
| 3 | 2404MHz | 23 | 2424MHz | 43 | 2444MHz | 63 | 2464MHz |
| 4 | 2405MHz | 24 | 2425MHz | 44 | 2445MHz | 64 | 2465MHz |
| 5 | 2406MHz | 25 | 2426MHz | 45 | 2446MHz | 65 | 2466MHz |
| 6 | 2407MHz | 26 | 2427MHz | 46 | 2447MHz | 66 | 2467MHz |
| 7 | 2408MHz | 27 | 2428MHz | 47 | 2448MHz | 67 | 2468MHz |
| 8 | 2409MHz | 28 | 2429MHz | 48 | 2449MHz | 68 | 2469MHz |
| 9 | 2410MHz | 29 | 2430MHz | 49 | 2450MHz | 69 | 2470MHz |
| 10 | 2411MHz | 30 | 2431MHz | 50 | 2451MHz | 70 | 2471MHz |
| 11 | 2412MHz | 31 | 2432MHz | 51 | 2452MHz | 71 | 2472MHz |
| 12 | 2413MHz | 32 | 2433MHz | 52 | 2453MHz | 72 | 2473MHz |
| 13 | 2414MHz | 33 | 2434MHz | 53 | 2454MHz | 73 | 2474MHz |
| 14 | 2415MHz | 34 | 2435MHz | 54 | 2455MHz | 74 | 2475MHz |
| 15 | 2416MHz | 35 | 2436MHz | 55 | 2456MHz | 75 | 2476MHz |
| 16 | 2417MHz | 36 | 2437MHz | 56 | 2457MHz | 76 | 2477MHz |
| 17 | 2418MHz | 37 | 2438MHz | 57 | 2458MHz | 77 | 2478MHz |
| 18 | 2419MHz | 38 | 2439MHz | 58 | 2459MHz | 78 | 2479MHz |
| 19 | 2420MHz | 39 | 2440MHz | 59 | 2460MHz | 79 | 2480MHz |
| 20 | 2421MHz | 40 | 2441MHz | 60 | 2461MHz | | |

Note:

In section 15.31(m), regards to the operating frequency range over 10 MHz, the Lowest frequency, the middle frequency, and the highest frequency of channel were selected to perform the test, and the selected channel see below:

| Channel | Frequency |
|---------------------|-----------|
| The lowest channel | 2402MHz |
| The middle channel | 2441MHz |
| The Highest channel | 2480MHz |

5.2 Test mode

| | |
|--|---|
| Transmitting mode | Keep the EUT in continuously transmitting mode. |
| <i>Remark: During the test, the test voltage was tuned from 85% to 115% of the nominal rated supply voltage, and found that the worst case was under the nominal rated supply condition. So the report just shows that condition's data.</i> | |

5.3 Description of Support Units

| |
|-------|
| None. |
|-------|

5.4 Deviation from Standards

| |
|-------|
| None. |
|-------|

5.5 Abnormalities from Standard Conditions

| |
|-------|
| None. |
|-------|

5.6 Test Facility

| |
|---|
| <p>The test facility is recognized, certified, or accredited by the following organizations:</p> <ul style="list-style-type: none"> ● FCC —Registration No.: 381383 Global United Technology Services Co., Ltd., Shenzhen EMC Laboratory has been registered and fully described in a report filed with the (FCC) Federal Communications Commission. The acceptance letter from the FCC is maintained in files. Registration 381383. ● IC —Registration No.: 9079A The 3m Semi-anechoic chamber of Global United Technology Services Co., Ltd. has been registered by Certification and Engineering Bureau of Industry Canada for radio equipment testing with Registration No.: 9079A ● NVLAP (LAB CODE:600179-0) Global United Technology Services Co., Ltd., is accredited by the National Voluntary Laboratory Accreditation Program (NVLAP). LAB CODE:600179-0 |
|---|

5.7 Test Location

| |
|---|
| All tests were performed at: |
| <p>Global United Technology Services Co., Ltd. Address: No. 123-128, Tower A, Jinyuan Business Building, No.2, Laodong Industrial Zone, Xixiang Road, Baoan District, Shenzhen, Guangdong, China 518102 Tel: 0755-27798480 Fax: 0755-27798960</p> |

5.8 Additional Instructions

| | |
|-------------------|---|
| Test Software | Special test command provided by manufacturer |
| Power level setup | Default |

6 Test Instruments list

| Radiated Emission: | | | | | | |
|--------------------|-------------------------------------|--------------------------------|-----------------------------|---------------|---------------------|-------------------------|
| Item | Test Equipment | Manufacturer | Model No. | Inventory No. | Cal.Date (mm-dd-yy) | Cal.Due date (mm-dd-yy) |
| 1 | 3m Semi- Anechoic Chamber | ZhongYu Electron | 9.2(L)*6.2(W)* 6.4(H) | GTS250 | July. 03 2015 | July. 02 2020 |
| 2 | Control Room | ZhongYu Electron | 6.2(L)*2.5(W)* 2.4(H) | GTS251 | N/A | N/A |
| 3 | EMI Test Receiver | Rohde & Schwarz | ESU26 | GTS203 | June. 26 2019 | June. 25 2020 |
| 4 | BiConiLog Antenna | SCHWARZBECK MESS-ELEKTRONIK | VULB9163 | GTS214 | June. 26 2019 | June. 25 2020 |
| 5 | Double -ridged waveguide horn | SCHWARZBECK MESS-ELEKTRONIK | BBHA 9120 D | GTS208 | June. 26 2019 | June. 25 2020 |
| 6 | Horn Antenna | ETS-LINDGREN | 3160 | GTS217 | June. 26 2019 | June. 25 2020 |
| 7 | EMI Test Software | AUDIX | E3 | N/A | N/A | N/A |
| 8 | Coaxial Cable | GTS | N/A | GTS213 | June. 26 2019 | June. 25 2020 |
| 9 | Coaxial Cable | GTS | N/A | GTS211 | June. 26 2019 | June. 25 2020 |
| 10 | Coaxial cable | GTS | N/A | GTS210 | June. 26 2019 | June. 25 2020 |
| 11 | Coaxial Cable | GTS | N/A | GTS212 | June. 26 2019 | June. 25 2020 |
| 12 | Amplifier(100kHz-3GHz) | HP | 8347A | GTS204 | June. 26 2019 | June. 25 2020 |
| 13 | Amplifier(2GHz-20GHz) | HP | 84722A | GTS206 | June. 26 2019 | June. 25 2020 |
| 14 | Amplifier (18-26GHz) | Rohde & Schwarz | AFS33-18002 650-30-8P-44 | GTS218 | June. 26 2019 | June. 25 2020 |
| 15 | Band filter | Amindeon | 82346 | GTS219 | June. 26 2019 | June. 25 2020 |
| 16 | Power Meter | Anritsu | ML2495A | GTS540 | June. 26 2019 | June. 25 2020 |
| 17 | Power Sensor | Anritsu | MA2411B | GTS541 | June. 26 2019 | June. 25 2020 |
| 18 | Wideband Radio Communication Tester | Rohde & Schwarz | CMW500 | GTS575 | June. 26 2019 | June. 25 2020 |
| 19 | Splitter | Agilent | 11636B | GTS237 | June. 26 2019 | June. 25 2020 |
| 20 | Loop Antenna | ZHINAN | ZN30900A | GTS534 | June. 26 2019 | June. 25 2020 |
| 21 | Breitband hornantenne | SCHWARZBECK | BBHA 9170 | GTS579 | Oct. 19 2019 | Oct. 18 2020 |
| 22 | Amplifier | TDK | PA-02-02 | GTS574 | Oct. 19 2019 | Oct. 18 2020 |
| 23 | Amplifier | TDK | PA-02-03 | GTS576 | Oct. 19 2019 | Oct. 18 2020 |
| 24 | PSA Series Spectrum Analyzer | Rohde & Schwarz | FSP | GTS578 | June. 26 2019 | June. 25 2020 |

| Conducted Emission | | | | | | |
|---------------------------|-------------------------------|-----------------------------|----------------------|---------------|---------------------|-------------------------|
| Item | Test Equipment | Manufacturer | Model No. | Inventory No. | Cal.Date (mm-dd-yy) | Cal.Due date (mm-dd-yy) |
| 1 | Shielding Room | ZhongYu Electron | 7.3(L)x3.1(W)x2.9(H) | GTS252 | May.15 2019 | May.14 2022 |
| 2 | EMI Test Receiver | R&S | ESCI 7 | GTS552 | June. 26 2019 | June. 25 2020 |
| 3 | Coaxial Switch | ANRITSU CORP | MP59B | GTS225 | June. 26 2019 | June. 25 2020 |
| 4 | ENV216 2-L-V- NETZNACHB.DE | ROHDE&SCHWARZ | ENV216 | GTS226 | June. 26 2019 | June. 25 2020 |
| 5 | Coaxial Cable | GTS | N/A | GTS227 | N/A | N/A |
| 6 | EMI Test Software | AUDIX | E3 | N/A | N/A | N/A |
| 7 | Thermo meter | KTJ | TA328 | GTS233 | June. 26 2019 | June. 25 2020 |
| 8 | Absorbing clamp | Elektronik- Feinmechanik | MDS21 | GTS229 | June. 26 2019 | June. 25 2020 |
| 9 | ISN | SCHWARZBECK | NTFM 8158 | GTD565 | June. 26 2019 | June. 25 2020 |

| RF Conducted Test: | | | | | | |
|---------------------------|--|--------------|------------------|------------|---------------------|-------------------------|
| Item | Test Equipment | Manufacturer | Model No. | Serial No. | Cal.Date (mm-dd-yy) | Cal.Due date (mm-dd-yy) |
| 1 | MXA Signal Analyzer | Agilent | N9020A | GTS566 | June. 26 2019 | June. 25 2020 |
| 2 | EMI Test Receiver | R&S | ESCI 7 | GTS552 | June. 26 2019 | June. 25 2020 |
| 3 | Spectrum Analyzer | Agilent | E4440A | GTS533 | June. 26 2019 | June. 25 2020 |
| 4 | MXG vector Signal Generator | Agilent | N5182A | GTS567 | June. 26 2019 | June. 25 2020 |
| 5 | ESG Analog Signal Generator | Agilent | E4428C | GTS568 | June. 26 2019 | June. 25 2020 |
| 6 | USB RF Power Sensor | DARE | RPR3006W | GTS569 | June. 26 2019 | June. 25 2020 |
| 7 | RF Switch Box | Shongyi | RFSW3003328 | GTS571 | June. 26 2019 | June. 25 2020 |
| 8 | Programmable Constant Temp & Humi Test Chamber | WEWON | WHTH-150L-40-880 | GTS572 | June. 26 2019 | June. 25 2020 |

| General used equipment: | | | | | | |
|--------------------------------|------------------------------------|--------------|-----------|---------------|---------------------|-------------------------|
| Item | Test Equipment | Manufacturer | Model No. | Inventory No. | Cal.Date (mm-dd-yy) | Cal.Due date (mm-dd-yy) |
| 1 | Humidity/ Temperature Indicator | KTJ | TA328 | GTS243 | June. 26 2019 | June. 25 2020 |
| 2 | Barometer | ChangChun | DYM3 | GTS255 | June. 26 2019 | June. 25 2020 |

7 Test results and Measurement Data

7.1 Antenna requirement

| | |
|--|-------------------------------------|
| Standard requirement: | FCC Part15 C Section 15.203 /247(c) |
| 15.203 requirement: An intentional radiator shall be designed to ensure that no antenna other than that furnished by the responsible party shall be used with the device. The use of a permanently attached antenna or of an antenna that uses a unique coupling to the intentional radiator, the manufacturer may design the unit so that a broken antenna can be replaced by the user, but the use of a standard antenna jack or electrical connector is prohibited. | |
| 15.247(c) (1)(i) requirement: (i) Systems operating in the 2400-2483.5 MHz band that is used exclusively for fixed. Point-to-point operations may employ transmitting antennas with directional gain greater than 6dBi provided the maximum conducted output power of the intentional radiator is reduced by 1 dB for every 3 dB that the directional gain of the antenna exceeds 6dBi. | |
| E.U.T Antenna: <i>The antenna is FPCB antenna, the best case gain of the antenna is 0.5dBi, reference to the appendix II for details</i> | |

7.2 Conducted Emissions

| | | | | | | |
|--|--|-------|--------------|-----|-----------|----------|
| Test Requirement: | FCC Part15 C Section 15.207 | | | | | |
| Test Method: | ANSI C63.10:2013 | | | | | |
| Test Frequency Range: | 150KHz to 30MHz | | | | | |
| Class / Severity: | Class B | | | | | |
| Receiver setup: | RBW=9KHz, VBW=30KHz, Sweep time=auto | | | | | |
| Limit: | Frequency range (MHz) | | Limit (dBuV) | | | |
| | | | Quasi-peak | | Average | |
| | 0.15-0.5 | | 66 to 56* | | 56 to 46* | |
| | 0.5-5 | | 56 | | 46 | |
| | 5-30 | | 60 | | 50 | |
| * Decreases with the logarithm of the frequency. | | | | | | |
| Test setup: | | | | | | |
| | <p><i>Remark</i> E.U.T: Equipment Under Test LISN: Line Impedance Stabilization Network Test table height=0.8m</p> | | | | | |
| Test procedure: | <ol style="list-style-type: none"> 1. The E.U.T and simulators are connected to the main power through a line impedance stabilization network (L.I.S.N.). This provides a 50ohm/50uH coupling impedance for the measuring equipment. 2. The peripheral devices are also connected to the main power through a LISN that provides a 50ohm/50uH coupling impedance with 50ohm termination. (Please refer to the block diagram of the test setup and photographs). 3. Both sides of A.C. line are checked for maximum conducted interference. In order to find the maximum emission, the relative positions of equipment and all of the interface cables must be changed according to ANSI C63.10:2013 on conducted measurement. | | | | | |
| Test Instruments: | Refer to section 6.0 for details | | | | | |
| Test mode: | Refer to section 5.2 for details | | | | | |
| Test environment: | Temp.: | 25 °C | Humid.: | 52% | Press.: | 1012mbar |
| Test voltage: | AC 120V, 60Hz | | | | | |
| Test results: | Pass | | | | | |

Remark: Both high and low voltages have been tested to show only the worst low voltage test data.

Measurement data:

Line:

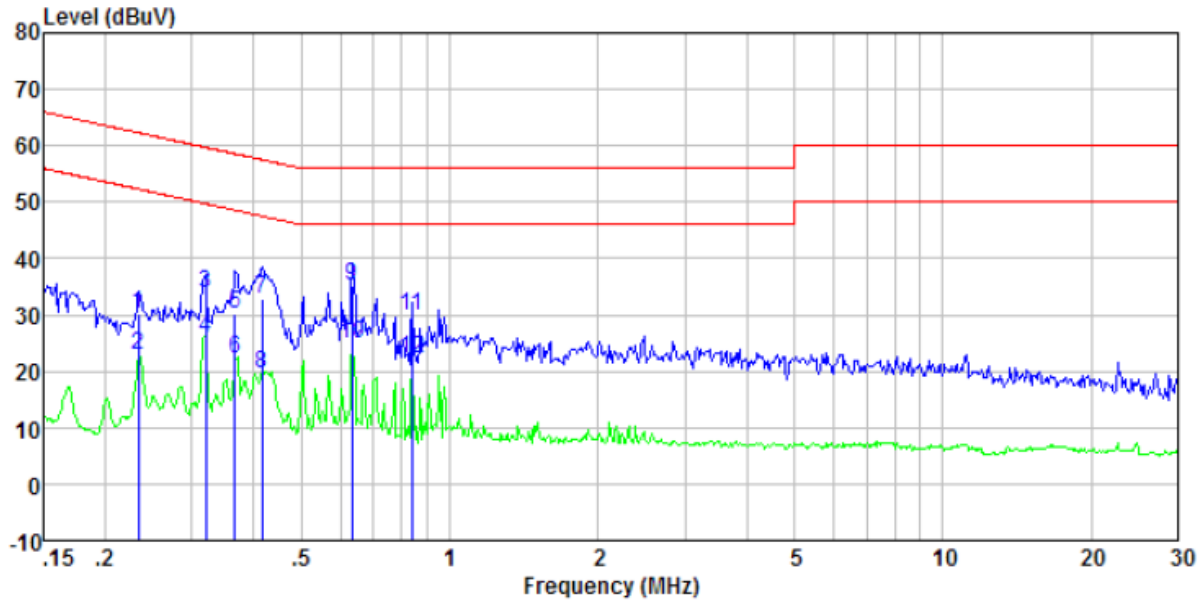

| Freq MHz | Reading level dBuV | LISN/ISN factor dB/m | Cable loss dB | Level dBuV | Limit level dBuV | Over limit dB | Remark |
|-------------|--------------------------|----------------------------|---------------------|---------------|------------------------|---------------------|---------|
| 0.23 | 9.67 | 20.40 | 0.11 | 30.18 | 62.30 | -32.12 | QP |
| 0.23 | 2.28 | 20.40 | 0.11 | 22.79 | 52.30 | -29.51 | Average |
| 0.32 | 13.26 | 20.39 | 0.10 | 33.75 | 59.71 | -25.96 | QP |
| 0.32 | 5.41 | 20.39 | 0.10 | 25.90 | 49.71 | -23.81 | Average |
| 0.37 | 9.79 | 20.37 | 0.10 | 30.26 | 58.56 | -28.30 | QP |
| 0.37 | 1.71 | 20.37 | 0.10 | 22.18 | 48.56 | -26.38 | Average |
| 0.42 | 12.50 | 20.35 | 0.11 | 32.96 | 57.51 | -24.55 | QP |
| 0.42 | -0.92 | 20.35 | 0.11 | 19.54 | 47.51 | -27.97 | Average |
| 0.63 | 14.74 | 20.28 | 0.12 | 35.14 | 56.00 | -20.86 | QP |
| 0.63 | 4.33 | 20.28 | 0.12 | 24.73 | 46.00 | -21.27 | Average |
| 0.84 | 9.45 | 20.23 | 0.14 | 29.82 | 56.00 | -26.18 | QP |
| 0.84 | 1.84 | 20.23 | 0.14 | 22.21 | 46.00 | -23.79 | Average |

Neutral:

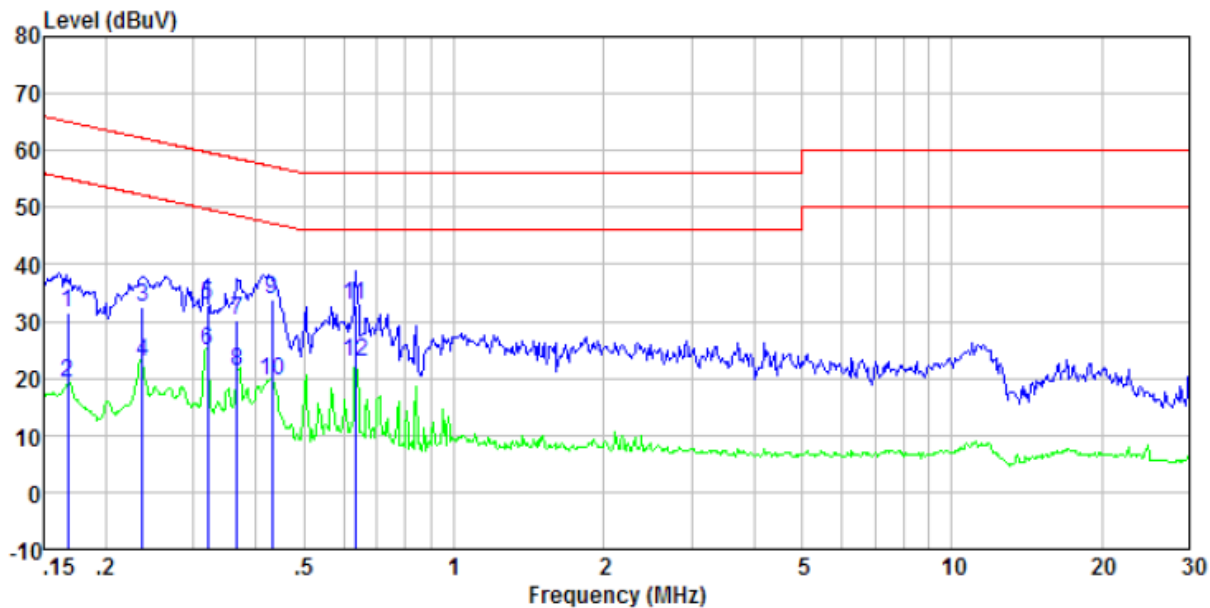

| Freq MHz | Reading level dBuV | LISN/ISN factor dB/m | Cable loss dB | Level dBuV | Limit level dBuV | Over limit dB | Remark |
|-------------|--------------------------|----------------------------|---------------------|---------------|------------------------|---------------------|---------|
| 0.17 | 10.93 | 20.40 | 0.09 | 31.42 | 65.08 | -33.66 | QP |
| 0.17 | -1.19 | 20.40 | 0.09 | 19.30 | 55.08 | -35.78 | Average |
| 0.24 | 11.87 | 20.40 | 0.11 | 32.38 | 62.22 | -29.84 | QP |
| 0.24 | 2.22 | 20.40 | 0.11 | 22.73 | 52.22 | -29.49 | Average |
| 0.32 | 12.22 | 20.39 | 0.10 | 32.71 | 59.71 | -27.00 | QP |
| 0.32 | 4.34 | 20.39 | 0.10 | 24.83 | 49.71 | -24.88 | Average |
| 0.37 | 9.66 | 20.37 | 0.10 | 30.13 | 58.56 | -28.43 | QP |
| 0.37 | 0.73 | 20.37 | 0.10 | 21.20 | 48.56 | -27.36 | Average |
| 0.43 | 13.27 | 20.34 | 0.11 | 33.72 | 57.24 | -23.52 | QP |
| 0.43 | -0.78 | 20.34 | 0.11 | 19.67 | 47.24 | -27.57 | Average |
| 0.63 | 12.56 | 20.28 | 0.12 | 32.96 | 56.00 | -23.04 | QP |
| 0.63 | 2.33 | 20.28 | 0.12 | 22.73 | 46.00 | -23.27 | Average |

Notes:

1. An initial pre-scan was performed on the line and neutral lines with peak detector.
2. Quasi-Peak and Average measurement were performed at the frequencies with maximized peak emission.
3. Final Level = Receiver Read level + LISN Factor + Cable Loss

7.3 Conducted Peak Output Power

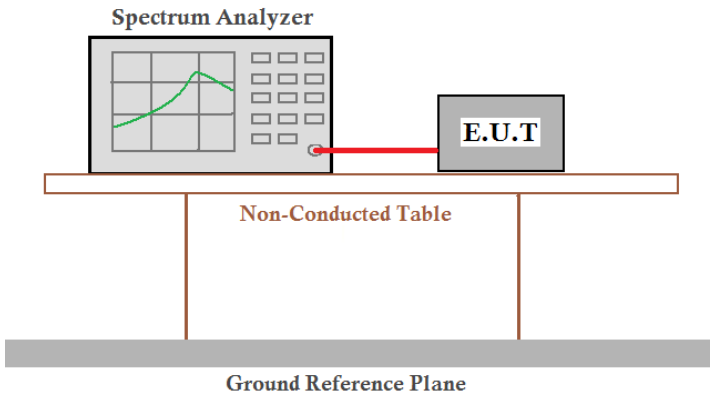
| | |
|-------------------|--|
| Test Requirement: | FCC Part15 C Section 15.247 (b)(3) |
| Test Method: | ANSI C63.10:2013 |
| Limit: | 20.97dBm |
| Test setup: |  |
| Test Instruments: | Refer to section 6.0 for details |
| Test mode: | Refer to section 5.2 for details |
| Test results: | Pass |

Measurement Data

| Mode | Test channel | Peak Output Power (dBm) | Limit (dBm) | Result |
|----------------|--------------|-------------------------|-------------|--------|
| GFSK | Lowest | -1.50 | 20.97 | Pass |
| | Middle | -1.63 | | |
| | Highest | -0.09 | | |
| $\pi/4$ -DQPSK | Lowest | -4.08 | 20.97 | Pass |
| | Middle | -4.51 | | |
| | Highest | -2.75 | | |
| 8-DPSK | Lowest | -5.10 | 20.97 | Pass |
| | Middle | -5.56 | | |
| | Highest | -3.87 | | |

Test plot as follows:

| | |
|------------|-----------|
| Test mode: | GFSK mode |
|------------|-----------|

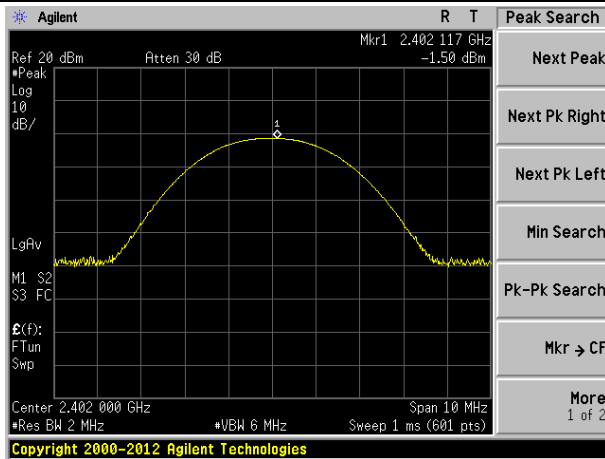

Lowest channel

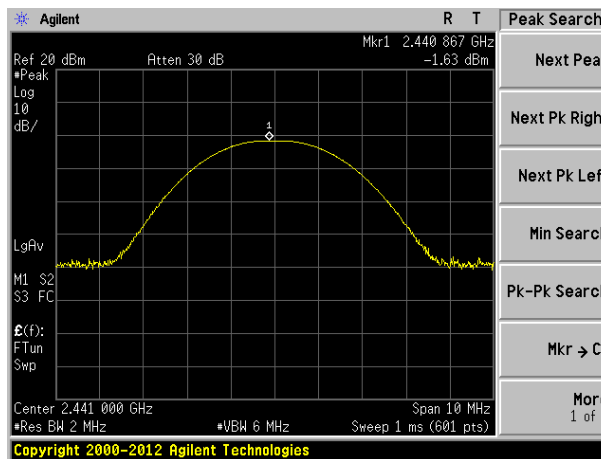

Middle channel

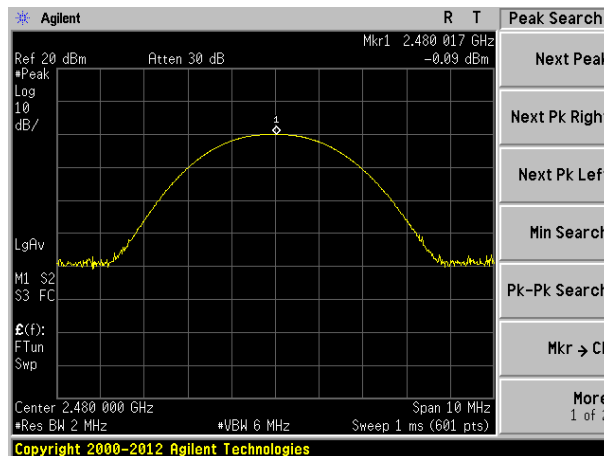

Highest channel

Test mode: π/4-DQPSK mode

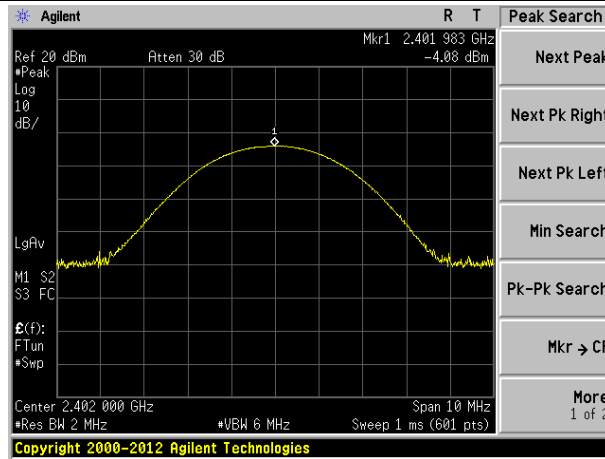

Lowest channel

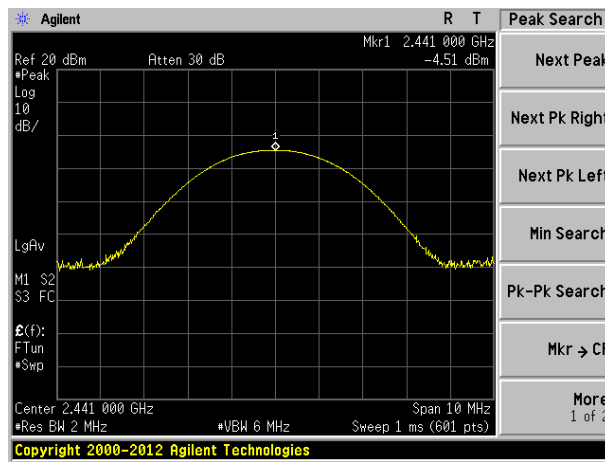

Middle channel

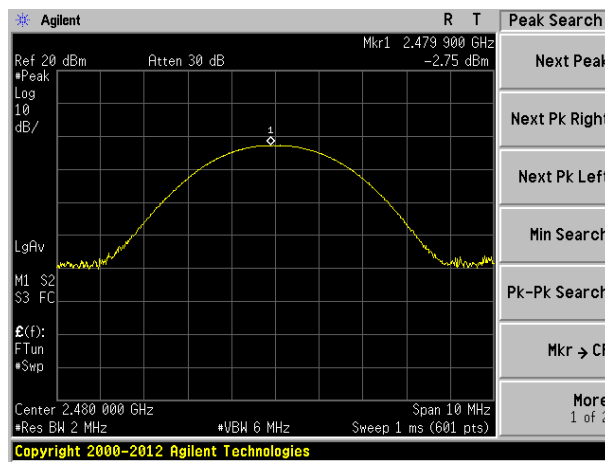

Highest channel

Test mode: 8-DPSK mode

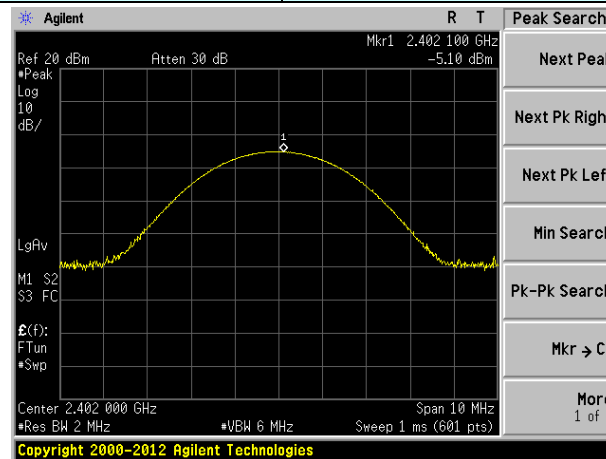

Lowest channel

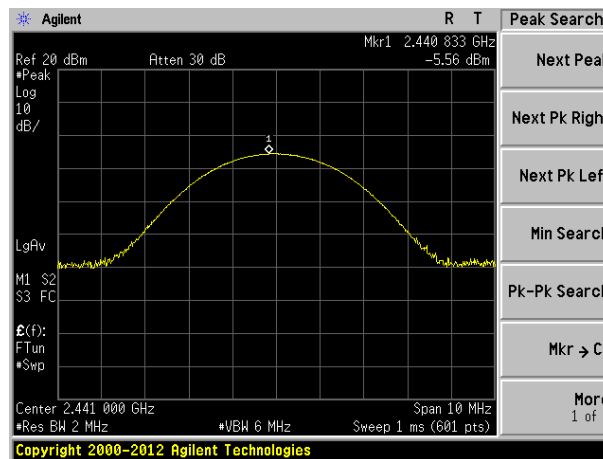

Middle channel

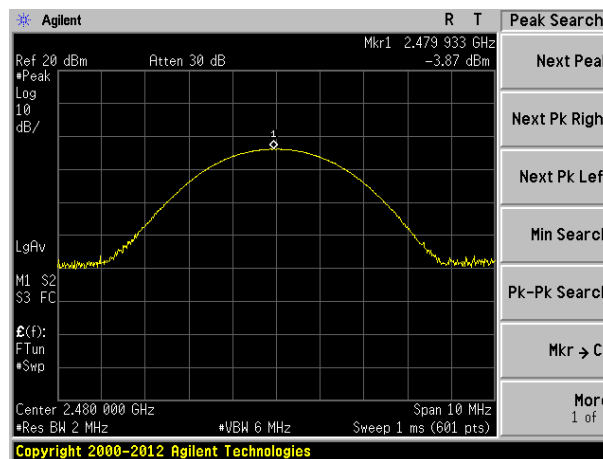

Highest channel

7.4 20dB Emission Bandwidth

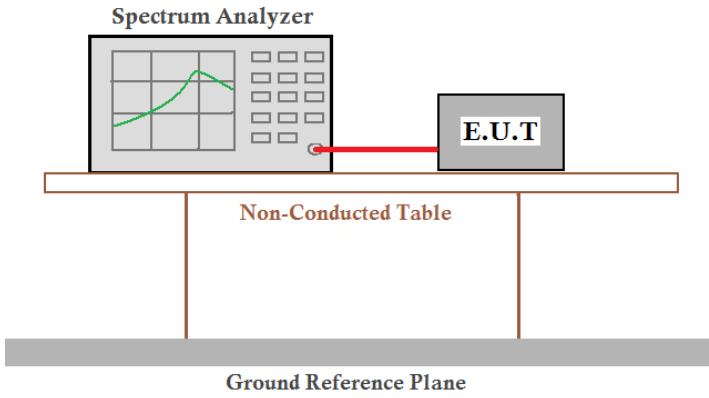
| | |
|-------------------|---|
| Test Requirement: | FCC Part15 C Section 15.247 (a)(2) |
| Test Method: | ANSI C63.10:2013 |
| Limit: | N/A |
| Test setup: |  <p>The diagram illustrates the test setup. A Spectrum Analyzer is connected to an E.U.T. (Equipment Under Test) via a red cable. Both are placed on a Non-Conducted Table, which is supported by a Ground Reference Plane.</p> |
| Test Instruments: | Refer to section 6.0 for details |
| Test mode: | Refer to section 5.2 for details |
| Test results: | Pass |

Measurement Data

| Mode | Test channel | 20dB Emission Bandwidth (MHz) | Result |
|----------------|--------------|-------------------------------|--------|
| GFSK | Lowest | 0.981 | Pass |
| | Middle | 0.980 | |
| | Highest | 0.986 | |
| $\pi/4$ -DQPSK | Lowest | 1.475 | Pass |
| | Middle | 1.480 | |
| | Highest | 1.479 | |
| 8-DPSK | Lowest | 1.485 | Pass |
| | Middle | 1.491 | |
| | Highest | 1.488 | |

Test plot as follows:

| | |
|------------|-----------|
| Test mode: | GFSK mode |
|------------|-----------|

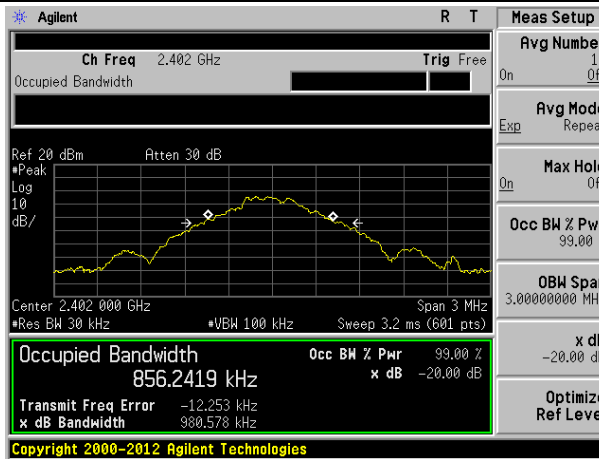

Lowest channel

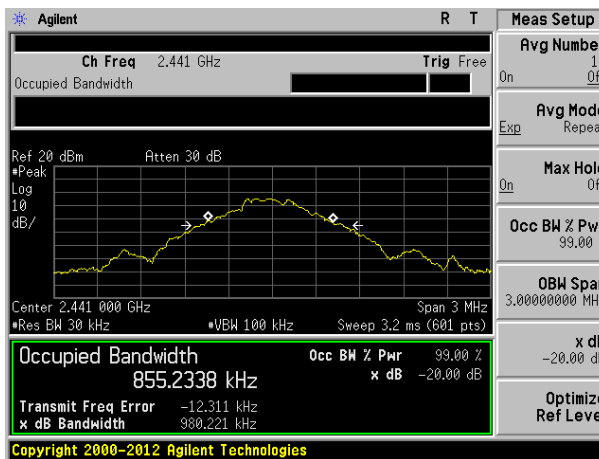

Middle channel

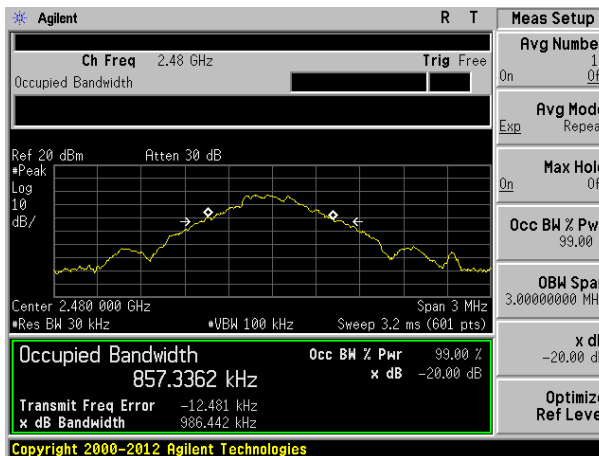

Highest channel

Test mode: π/4-DQPSK mode

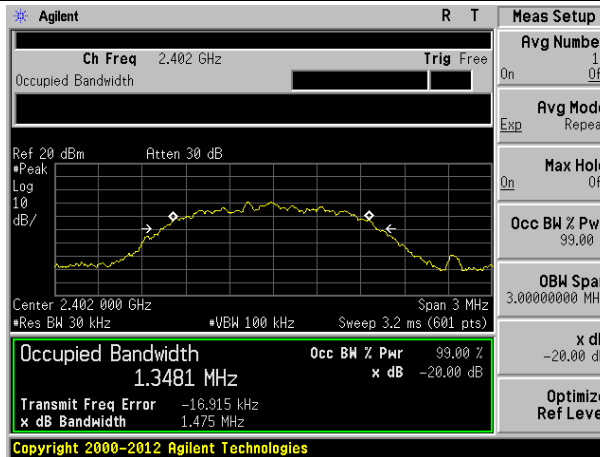

Lowest channel

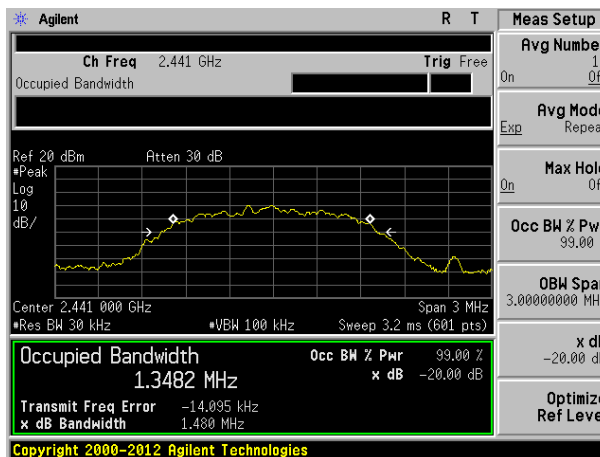

Middle channel

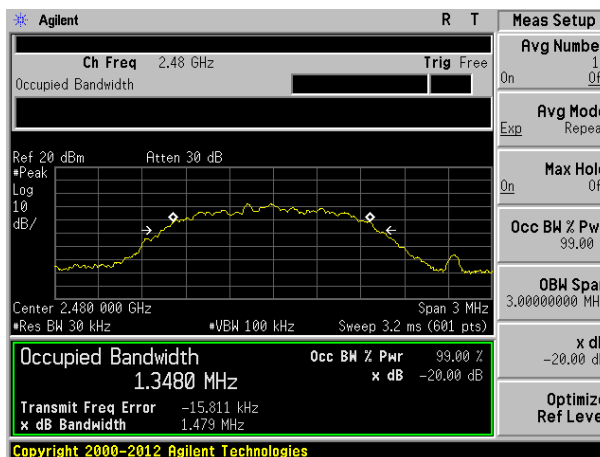

Highest channel

Test mode: 8-DPSK mode

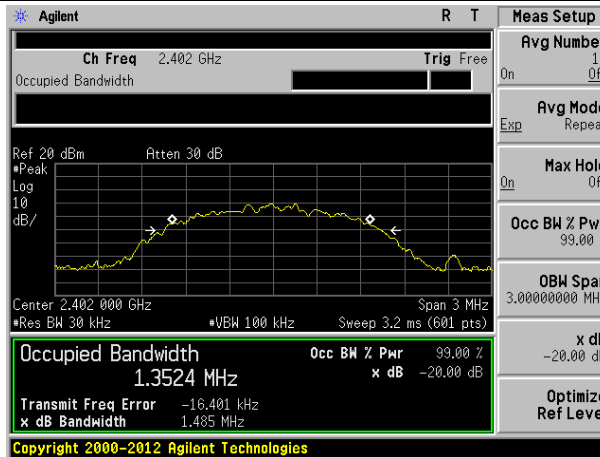

Lowest channel

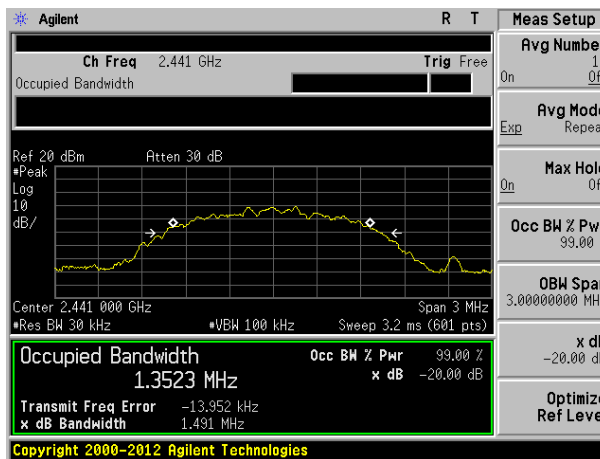

Middle channel

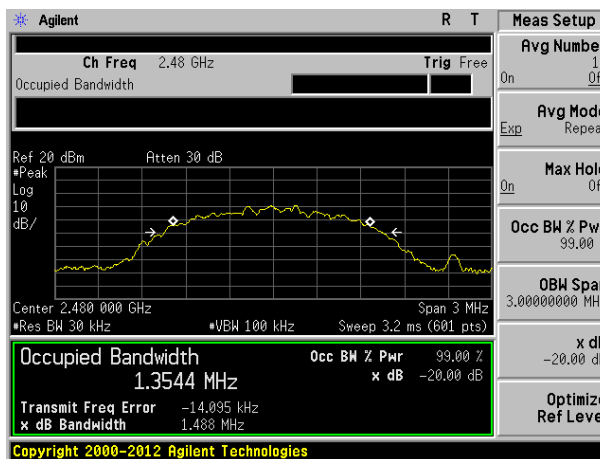

Highest channel

7.5 Carrier Frequencies Separation

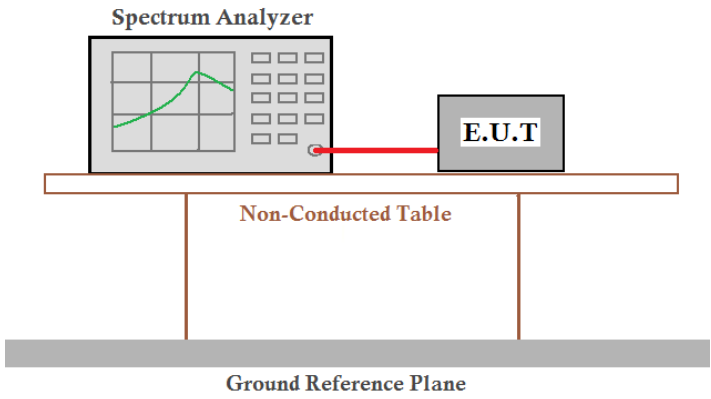
| | |
|-------------------|--|
| Test Requirement: | FCC Part15 C Section 15.247 (a)(1) |
| Test Method: | ANSI C63.10:2013 |
| Receiver setup: | RBW=100KHz, VBW=300KHz, detector=Peak |
| Limit: | 0.025MHz or 2/3 of the 20dB bandwidth (whichever is greater) |
| Test setup: |  |
| Test Instruments: | Refer to section 6.0 for details |
| Test mode: | Refer to section 5.2 for details |
| Test results: | Pass |

Measurement Data

| Mode | Test channel | Carrier Frequencies Separation (kHz) | Limit (kHz) | Result |
|----------------|--------------|--------------------------------------|-------------|--------|
| GFSK | Lowest | 1005 | 986 | Pass |
| | Middle | 1005 | 986 | Pass |
| | Highest | 1005 | 986 | Pass |
| $\pi/4$ -DQPSK | Lowest | 1005 | 987 | Pass |
| | Middle | 1005 | 987 | Pass |
| | Highest | 1005 | 987 | Pass |
| 8-DPSK | Lowest | 1005 | 994 | Pass |
| | Middle | 1005 | 994 | Pass |
| | Highest | 1005 | 994 | Pass |

Note: According to section 7.4

| Mode | 20dB bandwidth (kHz) (worse case) | Limit (kHz) (Carrier Frequencies Separation) |
|----------------|--------------------------------------|---|
| GFSK | 986 | 986 |
| $\pi/4$ -DQPSK | 1480 | 987 |
| 8-DPSK | 1491 | 994 |

Test plot as follows:

| | |
|------------------|------|
| Modulation mode: | GFSK |
|------------------|------|

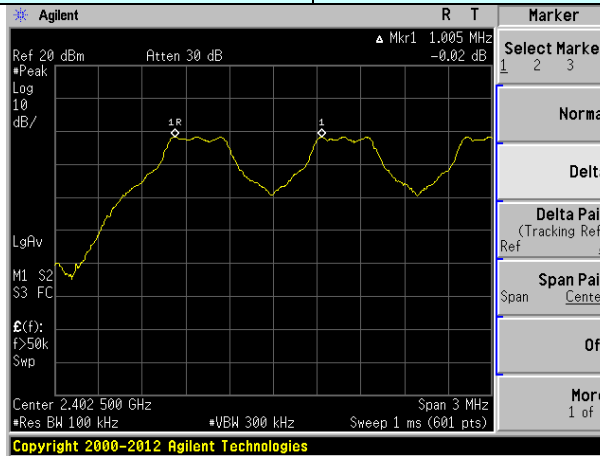

Lowest channel

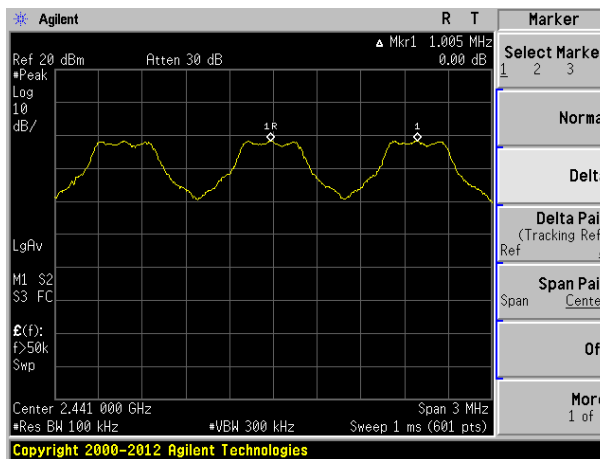

Middle channel

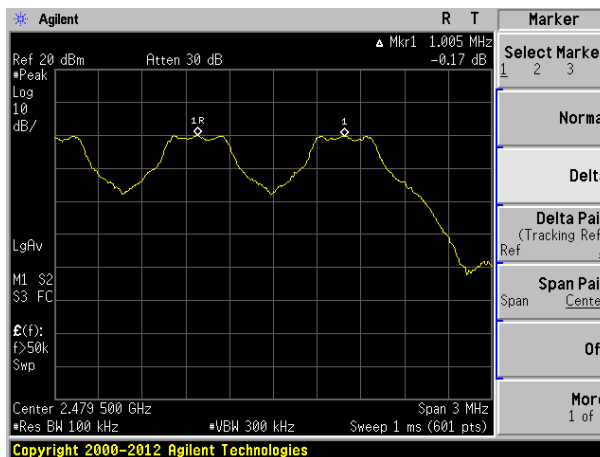

Highest channel

Test mode: π/4-DQPSK mode

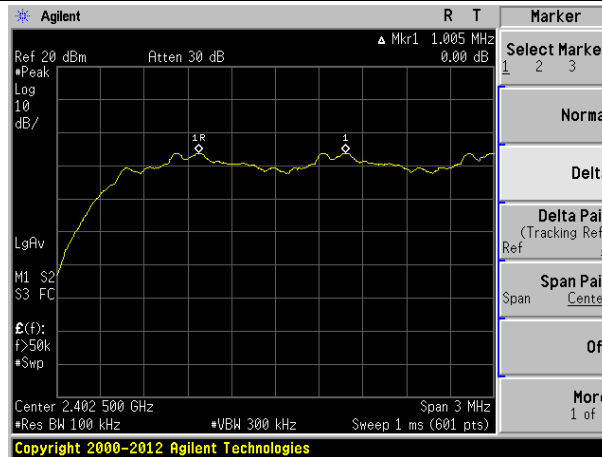

Lowest channel

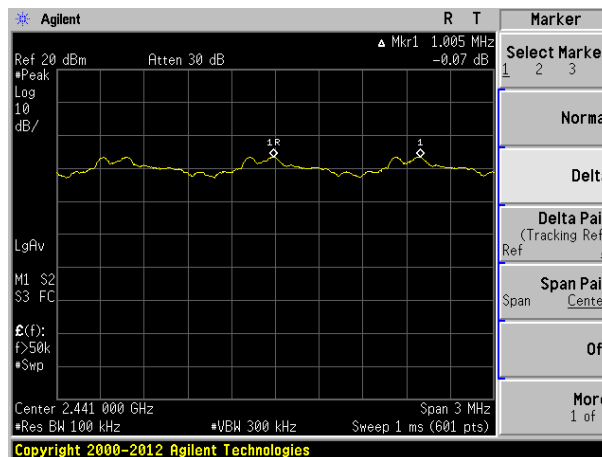

Middle channel

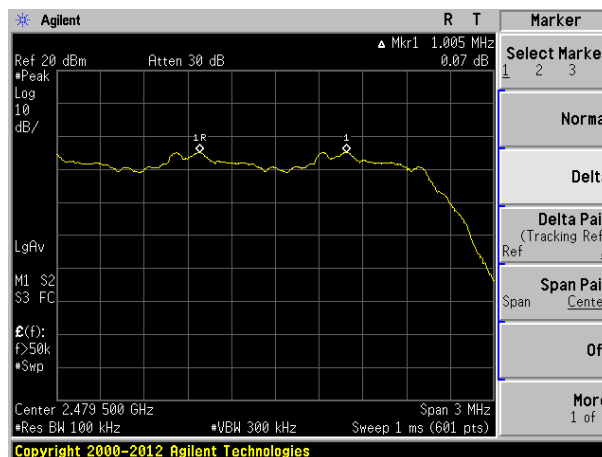

Highest channel

Test mode: 8-DPSK mode

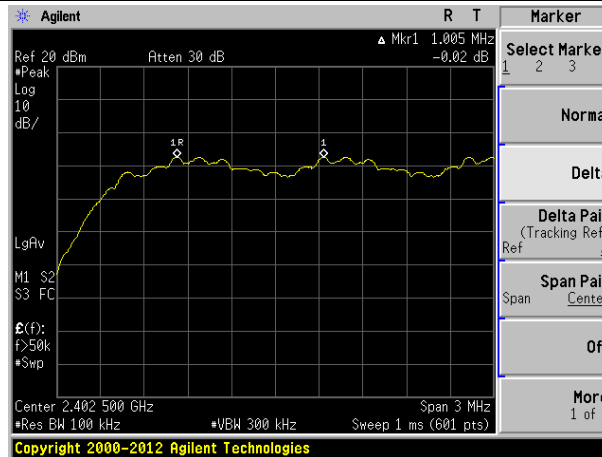

Lowest channel

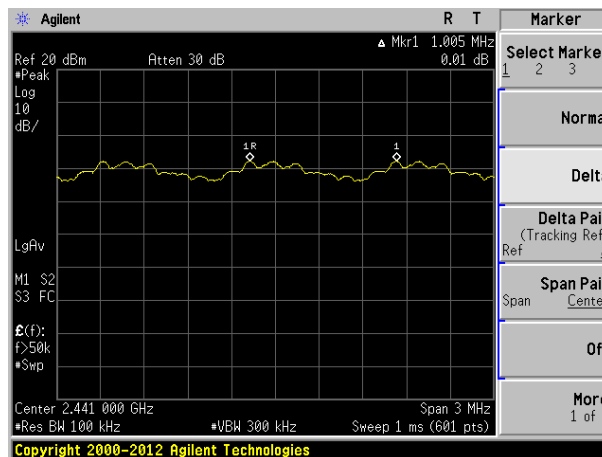

Middle channel

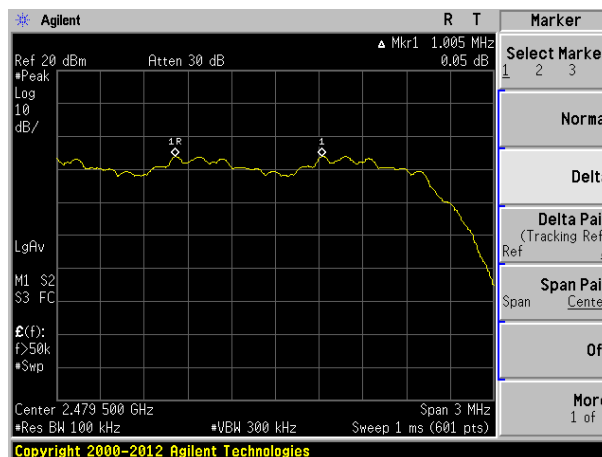

Highest channel

7.6 Hopping Channel Number

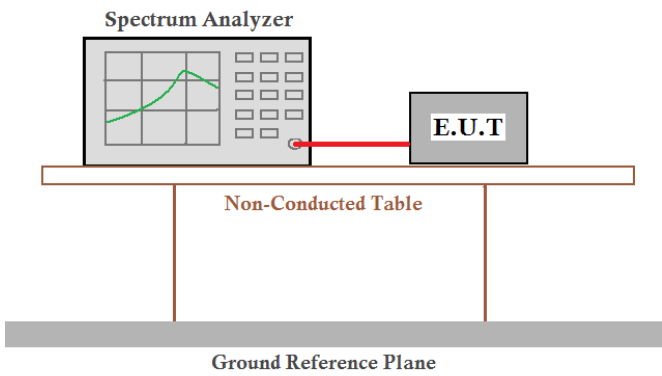
| | |
|-------------------|--|
| Test Requirement: | FCC Part15 C Section 15.247 (a)(1) |
| Test Method: | ANSI C63.10:2013 |
| Receiver setup: | RBW=100kHz, VBW=300kHz, Frequency range=2400MHz-2483.5MHz, Detector=Peak |
| Limit: | 15 channels |
| Test setup: |  |
| Test Instruments: | Refer to section 6.0 for details |
| Test mode: | Refer to section 5.2 for details |
| Test results: | Pass |

Measurement Data:

| Mode | Hopping channel numbers | Limit | Result |
|----------------|-------------------------|-------|--------|
| GFSK | 79 | 15 | Pass |
| $\pi/4$ -DQPSK | 79 | 15 | Pass |
| 8-DPSK | 79 | 15 | Pass |

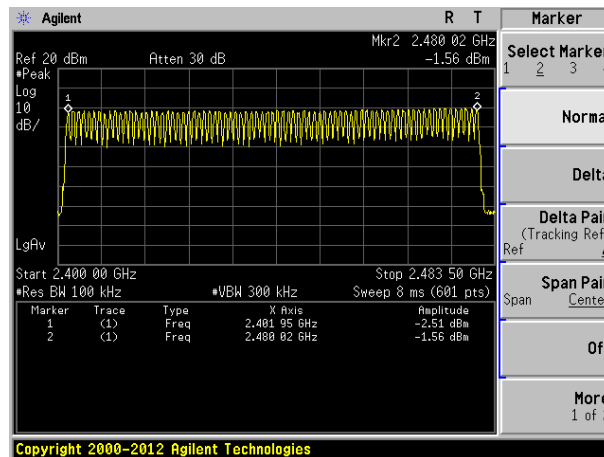

7.7 Dwell Time

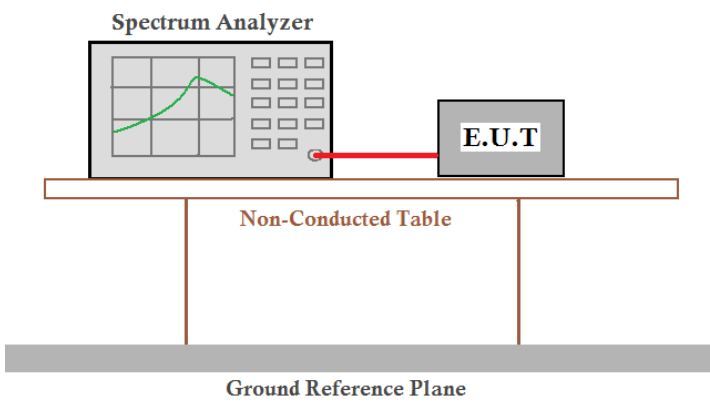
| | |
|-------------------|--|
| Test Requirement: | FCC Part15 C Section 15.247 (a)(1) |
| Test Method: | ANSI C63.10:2013 |
| Receiver setup: | RBW=1MHz, VBW=1MHz, Span=0Hz, Detector=Peak |
| Limit: | 0.4 Second |
| Test setup: |  |
| Test Instruments: | Refer to section 6.0 for details |
| Test mode: | Refer to section 5.2 for details |
| Test results: | Pass |

Measurement Data

| Frequency | Packet | Dwell time(ms) | Limit(ms) | Result |
|-----------|-----------------|----------------|-----------|--------|
| 2441MHz | DH1/2-DH1/3-DH1 | 120.00 | 400 | Pass |
| 2441MHz | DH3/2-DH3/3-DH3 | 261.60 | 400 | Pass |
| 2441MHz | DH5/2-DH5/3-DH5 | 307.52 | 400 | Pass |

The test period: $T = 0.4 \text{ Second/Channel} \times 79 \text{ Channel} = 31.6 \text{ s}$

Test channel: 2441MHz as blow

DH1/2-DH1/3-DH1 time slot = $0.375(\text{ms}) \times (1600 / (2 \times 79)) \times 31.6 = 120.00\text{ms}$

DH3/2-DH3/3-DH3 time slot = $1.635(\text{ms}) \times (1600 / (4 \times 79)) \times 31.6 = 261.60\text{ms}$

DH5/2-DH5/3-DH5 time slot = $2.883(\text{ms}) \times (1600 / (6 \times 79)) \times 31.6 = 307.52\text{ms}$

Test plot as follows:

| | |
|---------------|---------|
| Test channel: | 2441MHz |
|---------------|---------|

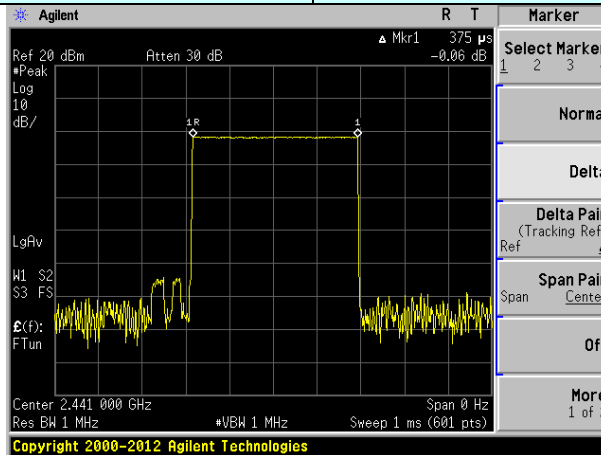

DH1/2-DH1/3-DH1

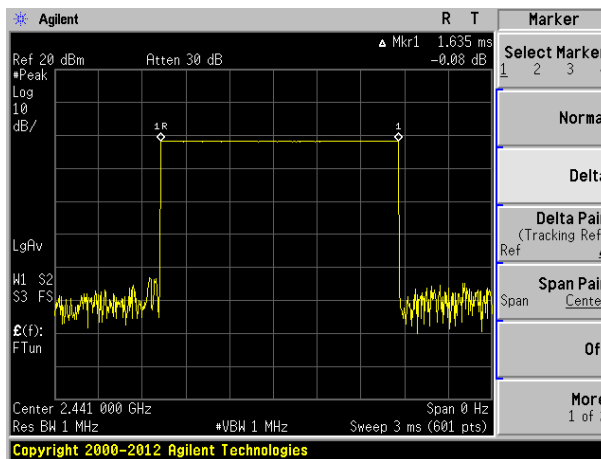

DH3/2-DH3/3-DH3

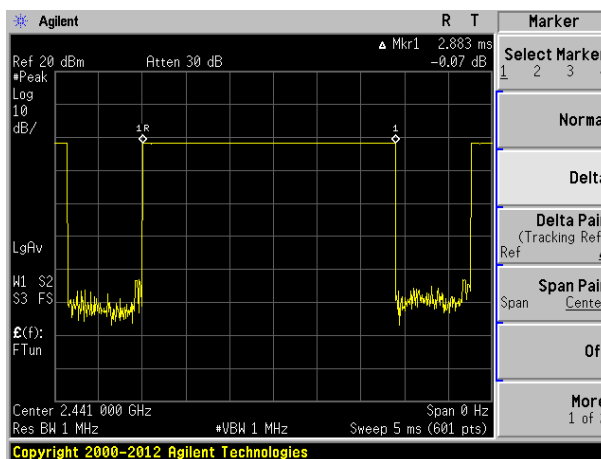

DH5/2-DH5/3-DH5

7.8 Pseudorandom Frequency Hopping Sequence

| Test Requirement: | FCC Part15 C Section 15.247 (a)(1)/g/h requirement: |
|---|---|
| <p><i>a(1): Frequency hopping systems shall have hopping channel carrier frequencies separated by a minimum of 25 kHz or the 20 dB bandwidth of the hopping channel, whichever is greater.</i></p> <p><i>Alternatively. Frequency hopping systems operating in the 2400-2483.5 MHz band may have hopping channel carrier frequencies that are separated by 25 kHz or two-thirds of the 20 dB bandwidth of the hopping channel, whichever is greater, provided the systems operate with an output power no greater than 125 mW. The system shall hop to channel frequencies that are selected at the system hopping rate from a Pseudorandom ordered list of hopping frequencies. Each frequency must be used equally on the average by each transmitter. The system receivers shall have input bandwidths that match the hopping channel bandwidths of their corresponding transmitters and shall shift frequencies in synchronization with the transmitted signals.</i></p> <p><i>(g) Frequency hopping spread spectrum systems are not required to employ all available hopping channels during each transmission. However, the system, consisting of both the transmitter and the receiver, must be designed to comply with all of the regulations in this section should the transmitter be presented with a continuous data (or information) stream. In addition, a system employing short transmission bursts must comply with the definition of a frequency hopping system and must distribute its transmissions over the minimum number of hopping channels specified in this section.</i></p> <p><i>(h) The incorporation of intelligence within a frequency hopping spread spectrum system that permits the system to recognize other users within the spectrum band so that it individually and independently chooses and adapts its hopsets to avoid hopping on occupied channels is permitted. The coordination of frequency hopping systems in any other manner for the express purpose of avoiding the simultaneous occupancy of individual hopping frequencies by multiple transmitters is not permitted.</i></p> | |
| <h3>EUT Pseudorandom Frequency Hopping Sequence</h3> | |
| <p><i>The pseudorandom sequence may be generated in a nine-stage shift register whose 5th and 9th stage outputs are added in a modulo-two addition stage. And the result is fed back to the input of the first stage. The sequence begins with the first ONE of 9 consecutive ONES; i.e. the shift register is initialized with nine ones.</i></p> <ul style="list-style-type: none"> • Number of shift register stages: 9 • Length of pseudo-random sequence: $2^9 - 1 = 511$ bits • Longest sequence of zeros: 8 (non-inverted signal) <div data-bbox="236 1227 1289 1375" style="text-align: center;"> </div> <p style="text-align: center;"><i>Linear Feedback Shift Register for Generation of the PRBS sequence</i></p> <p><i>An example of Pseudorandom Frequency Hopping Sequence as follow:</i></p> <div data-bbox="245 1473 1238 1626" style="text-align: center;"> </div> <p><i>Each frequency used equally on the average by each transmitter.</i></p> <p><i>The system receivers have input bandwidths that match the hopping channel bandwidths of their corresponding transmitters and shift frequencies in synchronization with the transmitted signals.</i></p> <p><i>it permits the system to recognize other users within the spectrum band so that it individually and independently chooses and adapts its hopsets to avoid hopping on occupied channels is permitted.</i></p> | |

7.9 Band Edge

7.9.1 Conducted Emission Method

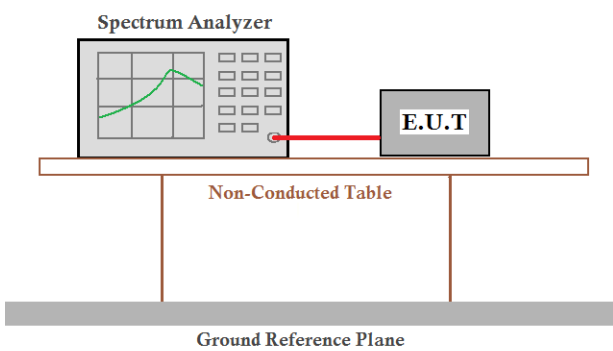
| | |
|-------------------|---|
| Test Requirement: | FCC Part15 C Section 15.247 (d) |
| Test Method: | ANSI C63.10:2013 |
| Receiver setup: | RBW=100kHz, VBW=300kHz, Detector=Peak |
| Limit: | In any 100 kHz bandwidth outside the frequency band in which the spread spectrum intentional radiator is operating, the radio frequency power that is produced by the intentional radiator shall be at least 20 dB below that in the 100 kHz bandwidth within the band that contains the highest level of the desired power, based on either an RF conducted or a radiated measurement. |
| Test setup: |  <p>The diagram illustrates the test setup. A Spectrum Analyzer is connected to an E.U.T. (Equipment Under Test) via a red cable. Both are placed on a Non-Conducted Table, which is supported by two legs. Below the table is a Ground Reference Plane.</p> |
| Test Instruments: | Refer to section 6.0 for details |
| Test mode: | Refer to section 5.2 for details |
| Test results: | Pass |

Test plot as follows:

GFSK Mode:

Test channel: Lowest channel

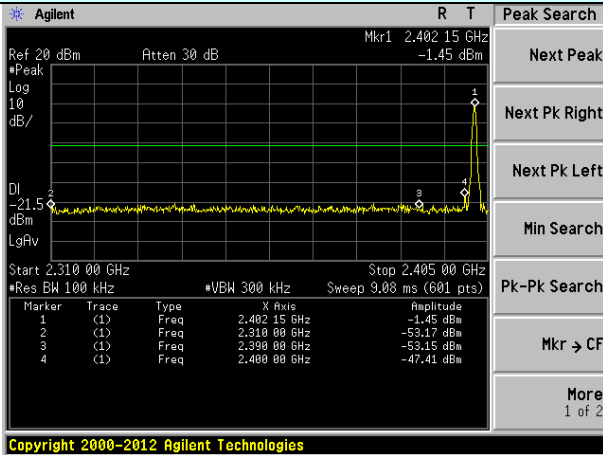

No-hopping mode

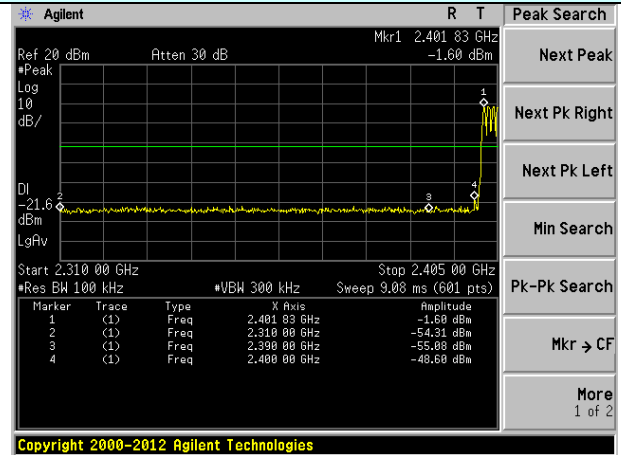

Hopping mode

Test channel: Highest channel

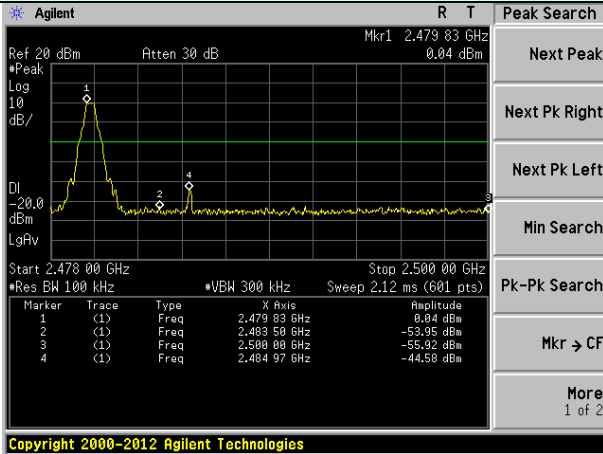

No-hopping mode

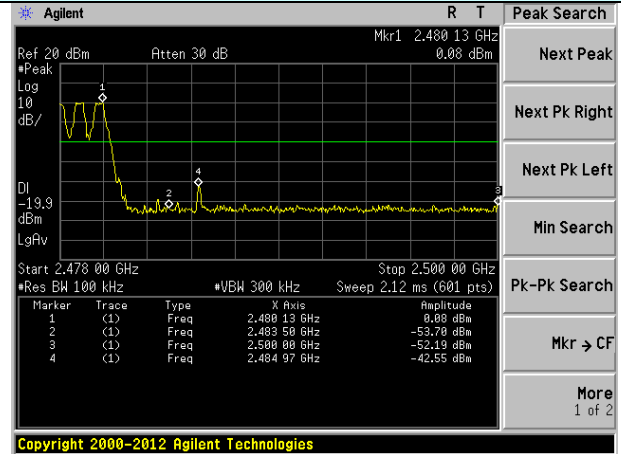

Hopping mode

$\pi/4$ -DQPSK Mode:

Test channel: Lowest channel

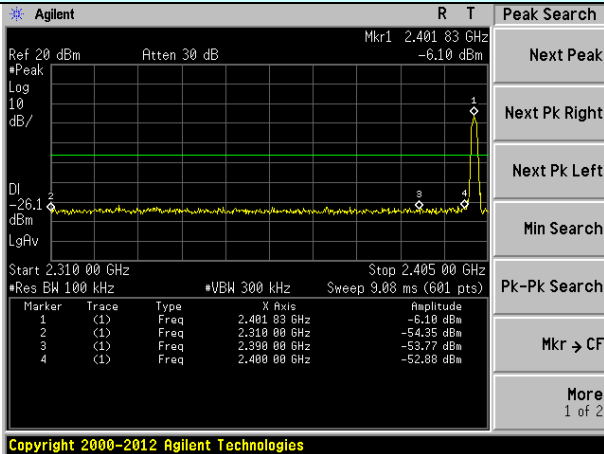

No-hopping mode

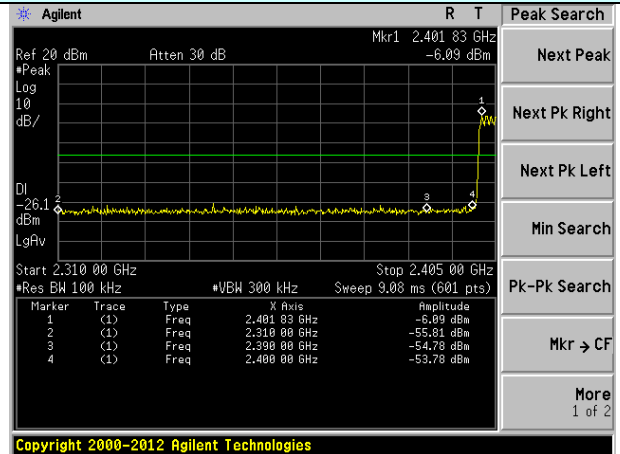

Hopping mode

Test channel: Highest channel

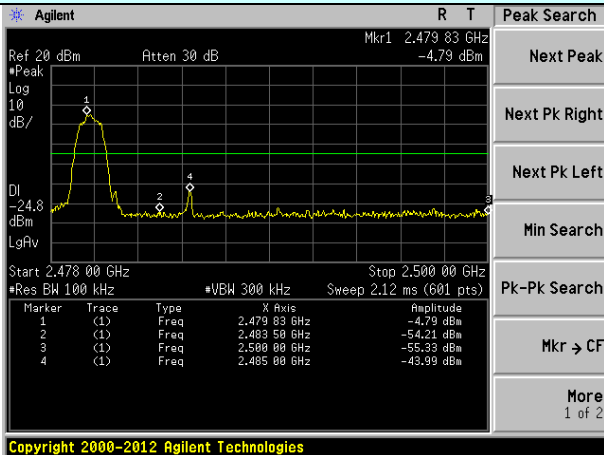

No-hopping mode

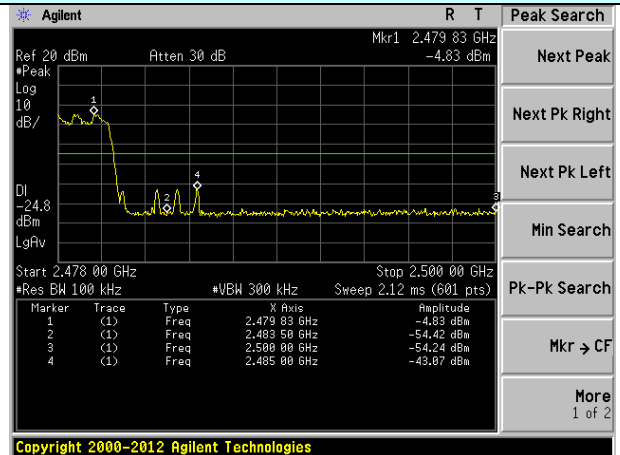

Hopping mode

8-DPSK Mode:

| | |
|---------------|----------------|
| Test channel: | Lowest channel |
|---------------|----------------|

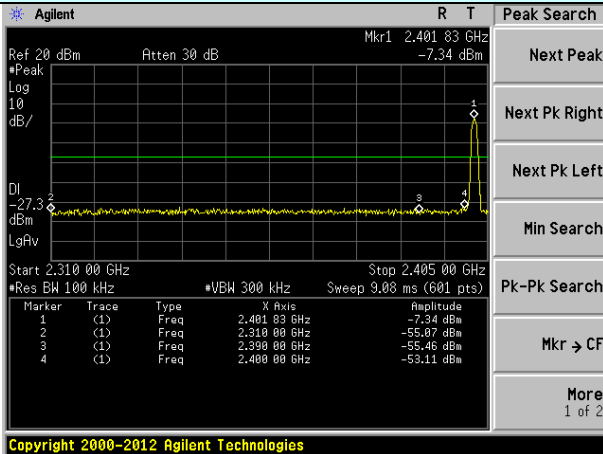

No-hopping mode

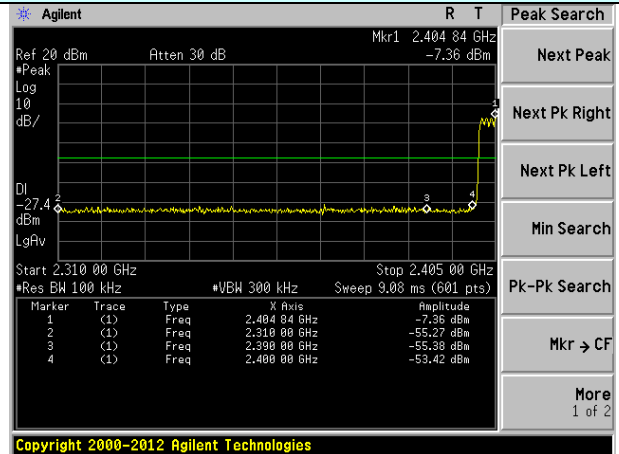

Hopping mode

| | |
|---------------|-----------------|
| Test channel: | Highest channel |
|---------------|-----------------|

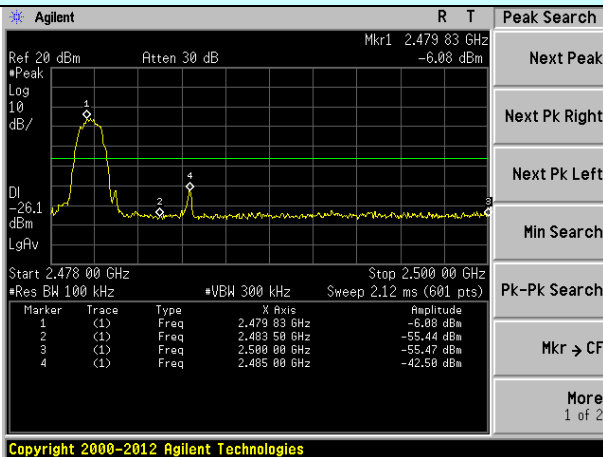

No-hopping mode

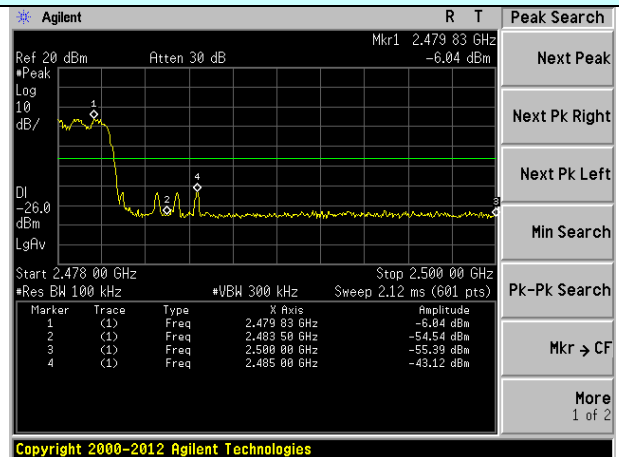

Hopping mode

7.9.2 Radiated Emission Method

| | | | | | |
|-----------------------|---|--------------------|------|---------------|------------|
| Test Requirement: | FCC Part15 C Section 15.209 and 15.205 | | | | |
| Test Method: | ANSI C63.10:2013 | | | | |
| Test Frequency Range: | All of the restrict bands were tested, only the worst band's (2310MHz to 2500MHz) data was showed. | | | | |
| Test site: | Measurement Distance: 3m | | | | |
| Receiver setup: | Frequency | Detector | RBW | VBW | Remark |
| | Above 1GHz | Peak | 1MHz | 3MHz | Peak Value |
| Limit: | Frequency | Limit (dBuV/m @3m) | | Remark | |
| | Above 1GHz | 54.00 | | Average Value | |
| Limit: | Above 1GHz | 74.00 | | Peak Value | |
| | | | | | |
| Test setup: | | | | | |
| Test Procedure: | <ol style="list-style-type: none"> 1. The EUT was placed on the top of a rotating table 1.5 meters above the ground at a 3 meter camber. The table was rotated 360 degrees to determine the position of the highest radiation. 2. The EUT was set 3 meters away from the interference-receiving antenna, which was mounted on the top of a variable-height antenna tower. 3. The antenna height is varied from one meter to four meters above the ground to determine the maximum value of the field strength. Both horizontal and vertical polarizations of the antenna are set to make the measurement. 4. For each suspected emission, the EUT was arranged to its worst case and then the antenna was tuned to heights from 1 meter to 4 meters and the rota table was turned from 0 degrees to 360 degrees to find the maximum reading. 5. The test-receiver system was set to Peak Detect Function and Specified Bandwidth with Maximum Hold Mode. 6. If the emission level of the EUT in peak mode was 10dB lower than the limit specified, then testing could be stopped and the peak values of the EUT would be reported. Otherwise the emissions that did not have 10dB margin would be re-tested one by one using peak, quasi-peak or average method as specified and then reported in a data sheet. | | | | |
| Test Instruments: | Refer to section 6.0 for details | | | | |
| Test mode: | Refer to section 5.2 for details | | | | |
| Test results: | Pass | | | | |

Measurement Data

| | |
|---------------|--------|
| Test channel: | Lowest |
|---------------|--------|

Peak value:

| Frequency (MHz) | Read Level (dBuV) | Antenna Factor (dB/m) | Cable Loss (dB) | Preamp Factor (dB) | Level (dBuV/m) | Limit Line (dBuV/m) | Over Limit (dB) | Polarization |
|-----------------|-------------------|-----------------------|-----------------|--------------------|----------------|---------------------|-----------------|--------------|
| 2390.00 | 44.13 | 27.59 | 5.38 | 30.18 | 46.92 | 74.00 | -27.08 | Horizontal |
| 2400.00 | 45.10 | 27.58 | 5.39 | 30.18 | 63.89 | 74.00 | -26.11 | Horizontal |
| 2390.00 | 44.80 | 27.59 | 5.38 | 30.18 | 47.59 | 74.00 | -26.41 | Vertical |
| 2400.00 | 43.27 | 27.58 | 5.39 | 30.18 | 66.06 | 74.00 | -27.94 | Vertical |

Average value:

| Frequency (MHz) | Read Level (dBuV) | Antenna Factor (dB/m) | Cable Loss (dB) | Preamp Factor (dB) | Level (dBuV/m) | Limit Line (dBuV/m) | Over Limit (dB) | Polarization |
|-----------------|-------------------|-----------------------|-----------------|--------------------|----------------|---------------------|-----------------|--------------|
| 2390.00 | 34.40 | 27.59 | 5.38 | 30.18 | 37.19 | 54.00 | -16.81 | Horizontal |
| 2400.00 | 35.71 | 27.58 | 5.39 | 30.18 | 48.50 | 54.00 | -15.50 | Horizontal |
| 2390.00 | 34.43 | 27.59 | 5.38 | 30.18 | 37.22 | 54.00 | -16.78 | Vertical |
| 2400.00 | 37.48 | 27.58 | 5.39 | 30.18 | 50.27 | 54.00 | -13.73 | Vertical |

| | |
|---------------|---------|
| Test channel: | Highest |
|---------------|---------|

Peak value:

| Frequency (MHz) | Read Level (dBuV) | Antenna Factor (dB/m) | Cable Loss (dB) | Preamp Factor (dB) | Level (dBuV/m) | Limit Line (dBuV/m) | Over Limit (dB) | Polarization |
|-----------------|-------------------|-----------------------|-----------------|--------------------|----------------|---------------------|-----------------|--------------|
| 2483.50 | 46.39 | 27.53 | 5.47 | 29.93 | 49.46 | 74.00 | -24.54 | Horizontal |
| 2500.00 | 45.32 | 27.55 | 5.49 | 29.93 | 48.43 | 74.00 | -25.57 | Horizontal |
| 2483.50 | 47.44 | 27.53 | 5.47 | 29.93 | 50.51 | 74.00 | -23.49 | Vertical |
| 2500.00 | 46.44 | 27.55 | 5.49 | 29.93 | 49.55 | 74.00 | -24.45 | Vertical |

Average value:

| Frequency (MHz) | Read Level (dBuV) | Antenna Factor (dB/m) | Cable Loss (dB) | Preamp Factor (dB) | Level (dBuV/m) | Limit Line (dBuV/m) | Over Limit (dB) | Polarization |
|-----------------|-------------------|-----------------------|-----------------|--------------------|----------------|---------------------|-----------------|--------------|
| 2483.50 | 37.24 | 27.53 | 5.47 | 29.93 | 40.31 | 54.00 | -13.69 | Horizontal |
| 2500.00 | 35.06 | 27.55 | 5.49 | 29.93 | 38.17 | 54.00 | -15.83 | Horizontal |
| 2483.50 | 38.56 | 27.53 | 5.47 | 29.93 | 41.63 | 54.00 | -12.37 | Vertical |
| 2500.00 | 35.09 | 27.55 | 5.49 | 29.93 | 38.20 | 54.00 | -15.80 | Vertical |

Remarks:

1. Final Level = Receiver Read level + Antenna Factor + Cable Loss - Pre-amplifier Factor
2. The emission levels of other frequencies are very lower than the limit and not show in test report.
3. The pre-test were performed on lowest, middle and highest frequencies, only the worst case's (lowest and highest frequencies) data was showed.
4. During the test, pre-scan the GFSK, $\pi/4$ -DQPSK, 8-DPSK modulation, and found the GFSK modulation which it is worse case.

7.10 Spurious Emission

7.10.1 Conducted Emission Method

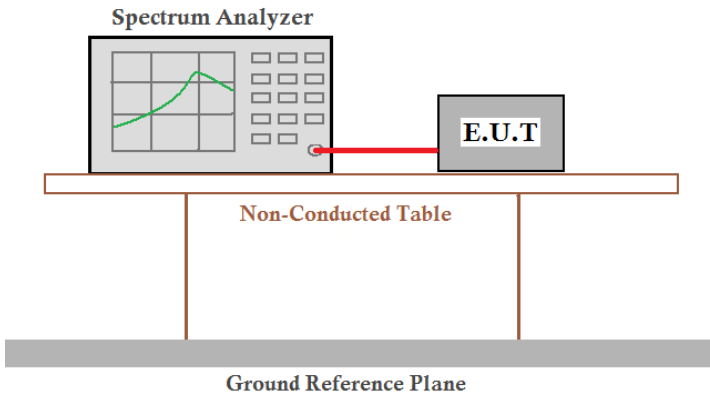
| | |
|-------------------|---|
| Test Requirement: | FCC Part15 C Section 15.247 (d) |
| Test Method: | ANSI C63.10:2013 |
| Limit: | In any 100 kHz bandwidth outside the frequency band in which the spread spectrum intentional radiator is operating, the radio frequency power that is produced by the intentional radiator shall be at least 20 dB below that in the 100 kHz bandwidth within the band that contains the highest level of the desired power, based on either an RF conducted or a radiated measurement. |
| Test setup: |  <p>The diagram illustrates the test setup. A Spectrum Analyzer is connected to an E.U.T. (Equipment Under Test) via a red cable. Both are placed on a Non-Conducted Table, which is supported by two legs. Below the table is a Ground Reference Plane.</p> |
| Test Instruments: | Refer to section 6.0 for details |
| Test mode: | Refer to section 5.2 for details |
| Test results: | Pass |

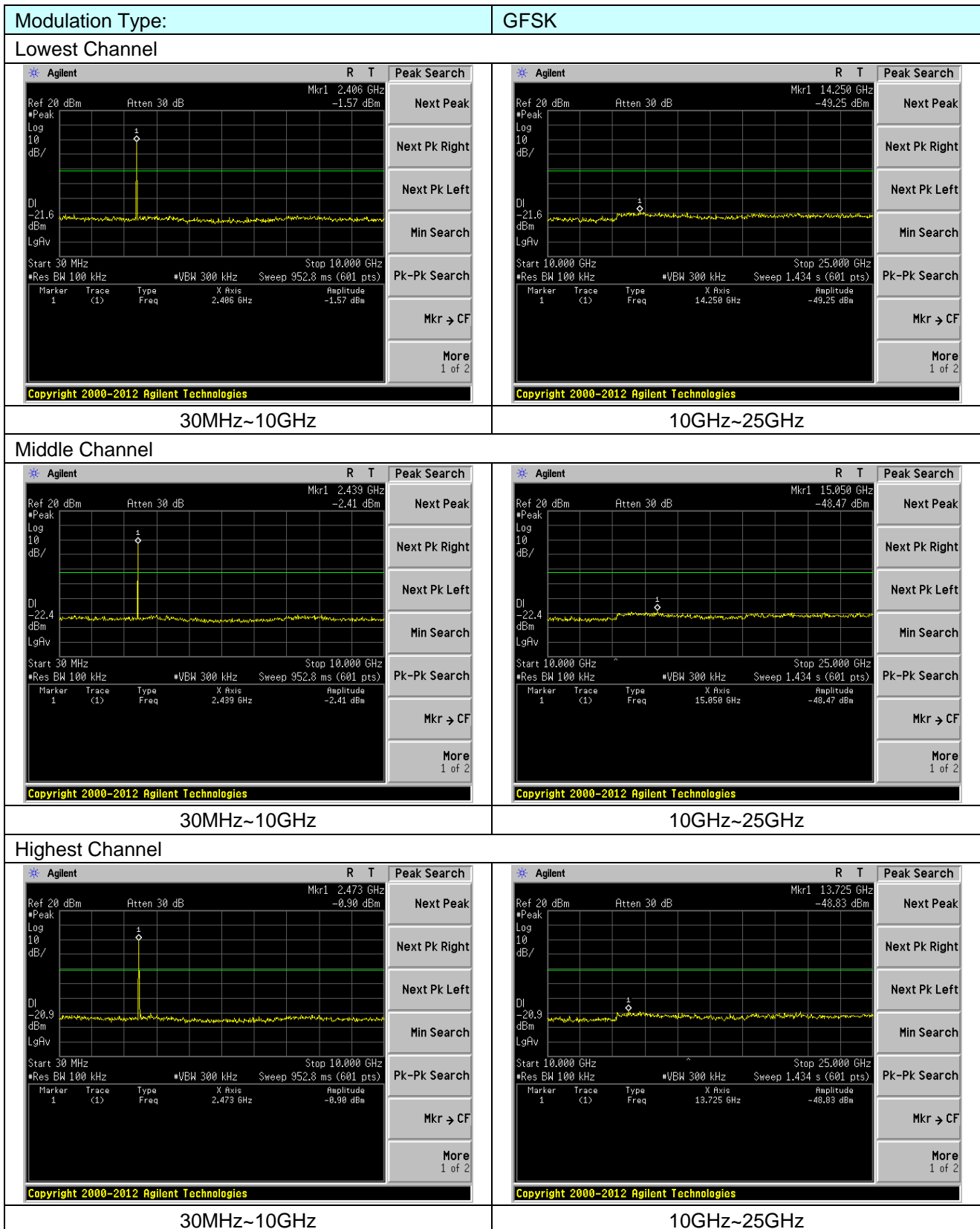

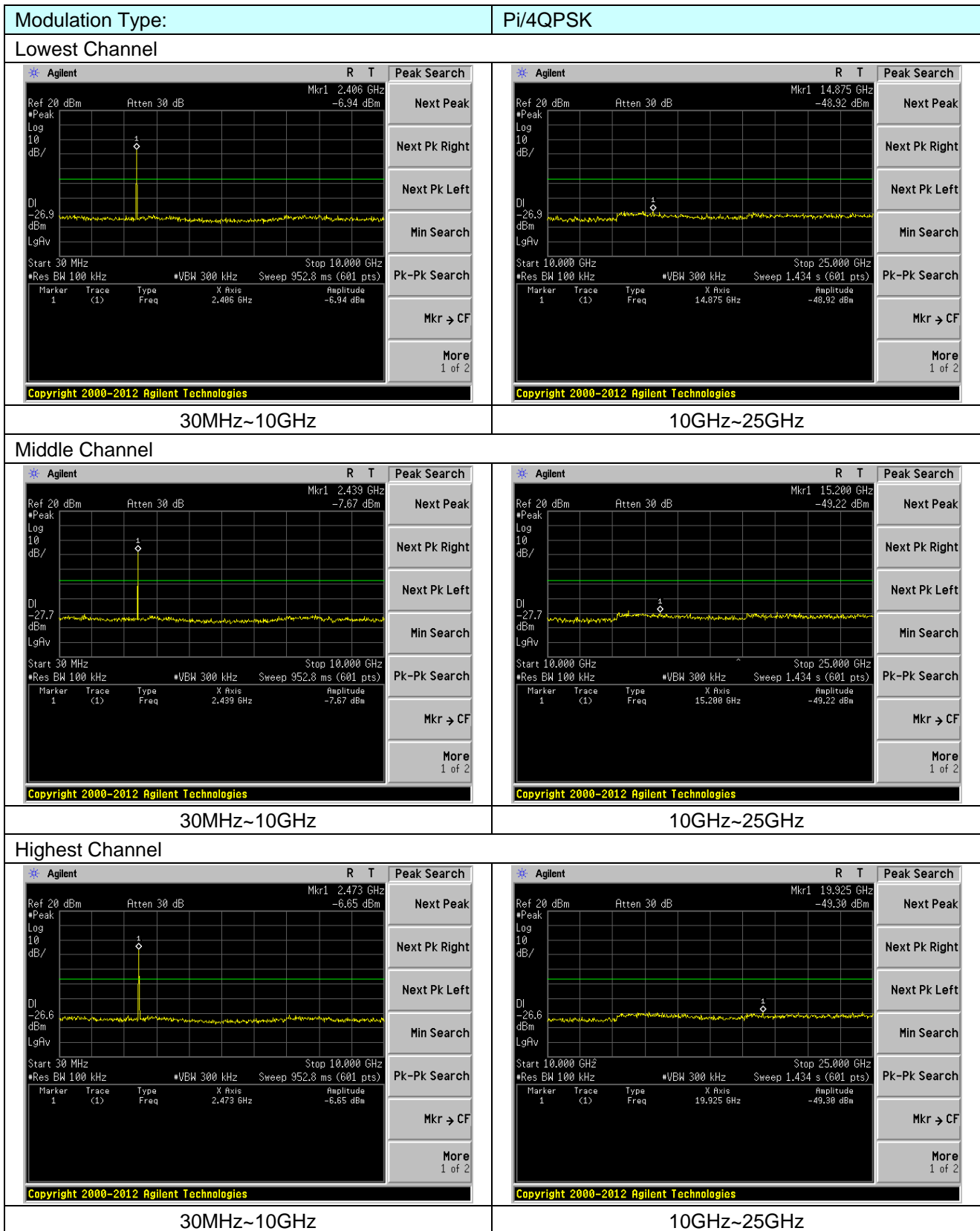

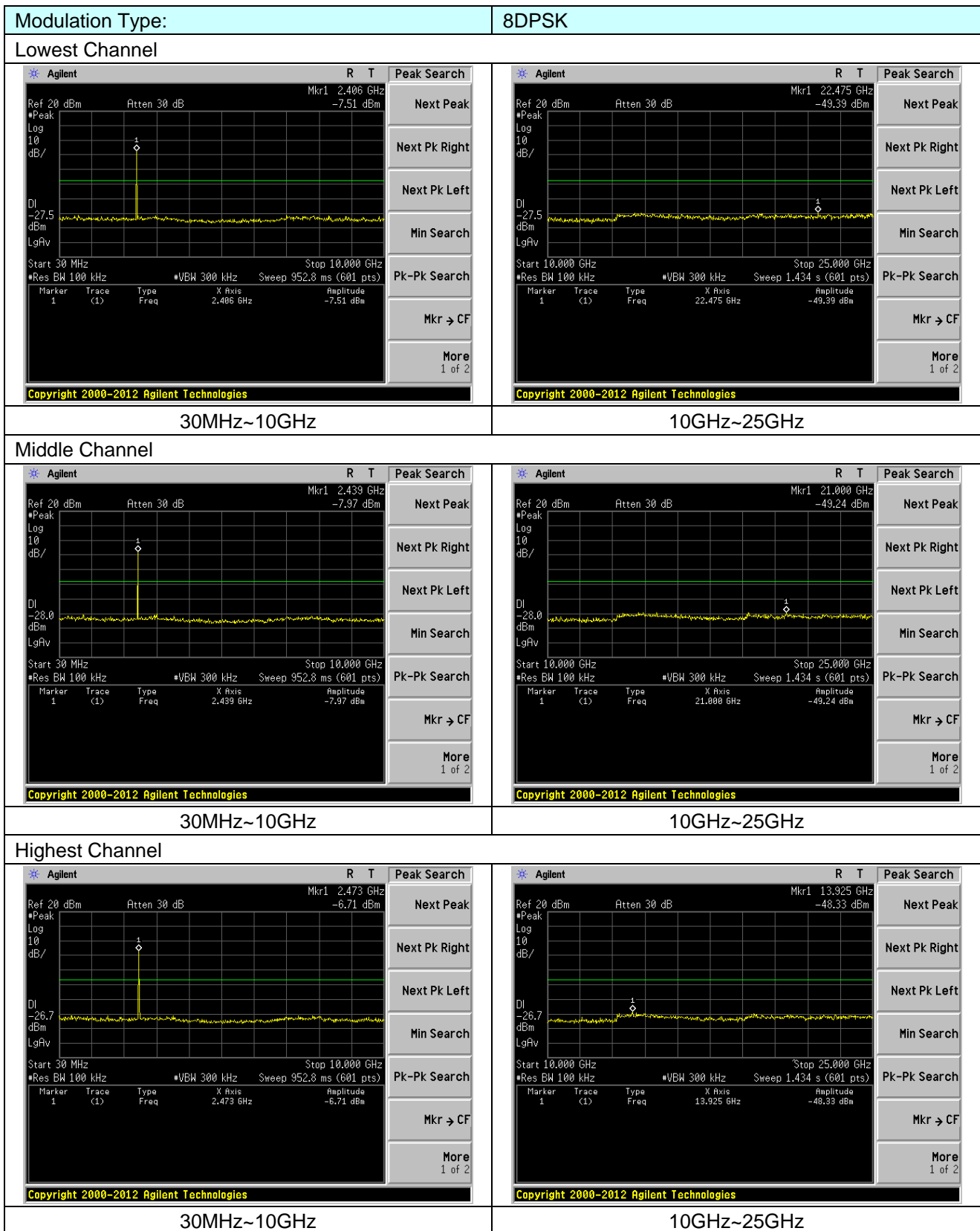

7.10.2 Radiated Emission Method

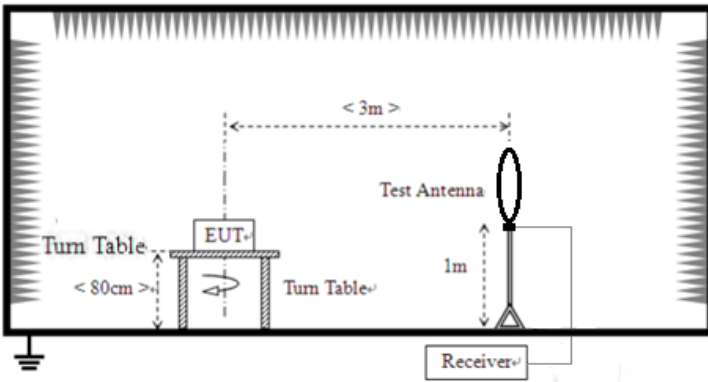
| | | | | | |
|-----------------------|---|--------------|---------|----------------------|------------|
| Test Requirement: | FCC Part15 C Section 15.209 | | | | |
| Test Method: | ANSI C63.10:2013 | | | | |
| Test Frequency Range: | 9kHz to 25GHz | | | | |
| Test site: | Measurement Distance: 3m | | | | |
| Receiver setup: | Frequency | Detector | RBW | VBW | Value |
| | 9KHz-150KHz | Quasi-peak | 200Hz | 600Hz | Quasi-peak |
| | 150KHz-30MHz | Quasi-peak | 9KHz | 30KHz | Quasi-peak |
| | 30MHz-1GHz | Quasi-peak | 120KHz | 300KHz | Quasi-peak |
| | Above 1GHz | Peak | 1MHz | 3MHz | Peak |
| Peak | | 1MHz | 10Hz | Average | |
| Limit: | Frequency | Limit (uV/m) | Value | Measurement Distance | |
| | 0.009MHz-0.490MHz | 2400/F(KHz) | QP | 300m | |
| | 0.490MHz-1.705MHz | 24000/F(KHz) | QP | 30m | |
| | 1.705MHz-30MHz | 30 | QP | 30m | |
| | 30MHz-88MHz | 100 | QP | 3m | |
| | 88MHz-216MHz | 150 | QP | | |
| | 216MHz-960MHz | 200 | QP | | |
| | 960MHz-1GHz | 500 | QP | | |
| | Above 1GHz | 500 | Average | | |
| 5000 | | Peak | | | |
| Test setup: | <p>For radiated emissions from 9kHz to 30MHz</p>  <p>The diagram illustrates the test setup for radiated emissions. An Equipment Under Test (EUT) is placed on a turn table with a diameter less than 80cm. The EUT is positioned at a distance of 3m from a test antenna. The test antenna is mounted on a stand that is 1m high. A receiver is connected to the test antenna. The entire setup is enclosed in a shielded chamber, indicated by the hatched walls.</p> | | | | |

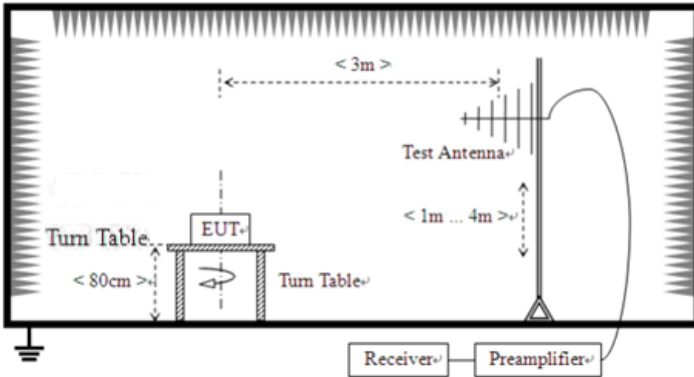
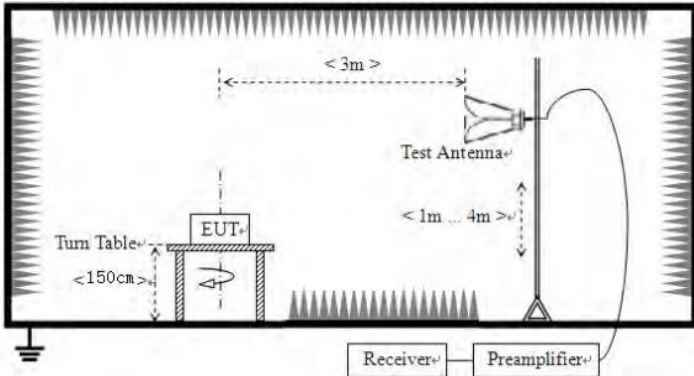
| | |
|--------------------------|--|
| | <p>For radiated emissions from 30MHz to 1GHz</p>  <p>For radiated emissions above 1GHz</p>  |
| <p>Test Procedure:</p> | <ol style="list-style-type: none"> 1. The EUT was placed on the top of a rotating table (0.8m for below 1G and 1.5m for above 1G) above the ground at a 3 meter camber. The table was rotated 360 degrees to determine the position of the highest radiation. 2. The EUT was set 3 meters away from the interference-receiving antenna, which was mounted on the top of a variable-height antenna tower. 3. The antenna height is varied from one meter to four meters above the ground to determine the maximum value of the field strength. Both horizontal and vertical polarizations of the antenna are set to make the measurement. 4. For each suspected emission, the EUT was arranged to its worst case and then the antenna was tuned to heights from 1 meter to 4 meters and the rota table was turned from 0 degrees to 360 degrees to find the maximum reading. 5. The test-receiver system was set to Peak Detect Function and Specified Bandwidth with Maximum Hold Mode. 6. If the emission level of the EUT in peak mode was 10dB lower than the limit specified, then testing could be stopped and the peak values of the EUT would be reported. Otherwise the emissions that did not have 10dB margin would be re-tested one by one using peak, quasi-peak or average method as specified and then reported in a data sheet. |
| <p>Test Instruments:</p> | <p>Refer to section 6.0 for details</p> |
| <p>Test mode:</p> | <p>Refer to section 5.2 for details</p> |

| | | | | | | |
|-------------------|---------------|-------|---------|-----|---------|----------|
| Test environment: | Temp.: | 25 °C | Humid.: | 52% | Press.: | 1012mbar |
| Test voltage: | AC 120V, 60Hz | | | | | |
| Test results: | Pass | | | | | |

Measurement data:*Remarks:*

1. *During the test, pre-scan the GFSK, $\pi/4$ -DQPSK, 8-DPSK modulation, and found the GFSK modulation which it is worse case.*
2. *Pre-scan all kind of the place mode (X-axis, Y-axis, Z-axis), and found the Y-axis which it is worse case.*

■ 9kHz~30MHz

The low frequency, which started from 9 kHz to 30 MHz, was pre-scanned and the result which was 20 dB lower than the limit line per 15.31(o) was not reported.

■ Below 1GHz

Pre-scan all test modes, found worst case at 8-DPSK 2441MHz, and so only show the test result of 8-DPSK 2441MHz

Horizontal:

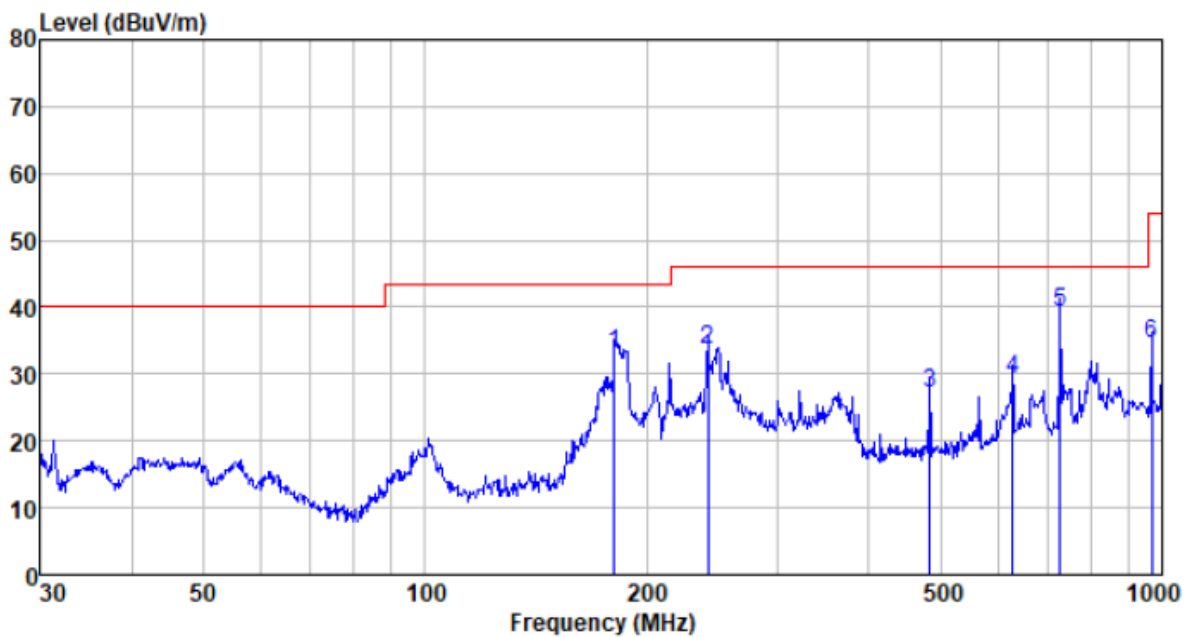

| Freq MHz | Reading level dBuV | Antenna factor dB/m | Cable loss dB | Preamp factor dB | level dBuV/m | Limit level dBuV/m | Over limit dB | Remark |
|-------------|--------------------------|---------------------------|---------------------|------------------------|-----------------|--------------------------|---------------------|--------|
| 180.649 | 59.50 | 8.98 | 1.74 | 37.24 | 32.98 | 43.50 | -10.52 | QP |
| 241.676 | 57.15 | 11.89 | 2.08 | 37.37 | 33.75 | 46.00 | -12.25 | QP |
| 483.910 | 44.45 | 17.01 | 3.23 | 37.51 | 27.18 | 46.00 | -18.82 | QP |
| 627.274 | 43.36 | 19.53 | 3.83 | 37.57 | 29.15 | 46.00 | -16.85 | QP |
| 726.805 | 52.55 | 20.10 | 4.19 | 37.63 | 39.21 | 46.00 | -6.79 | QP |
| 968.934 | 44.25 | 22.59 | 5.11 | 37.54 | 34.41 | 54.00 | -19.59 | QP |

Vertical:

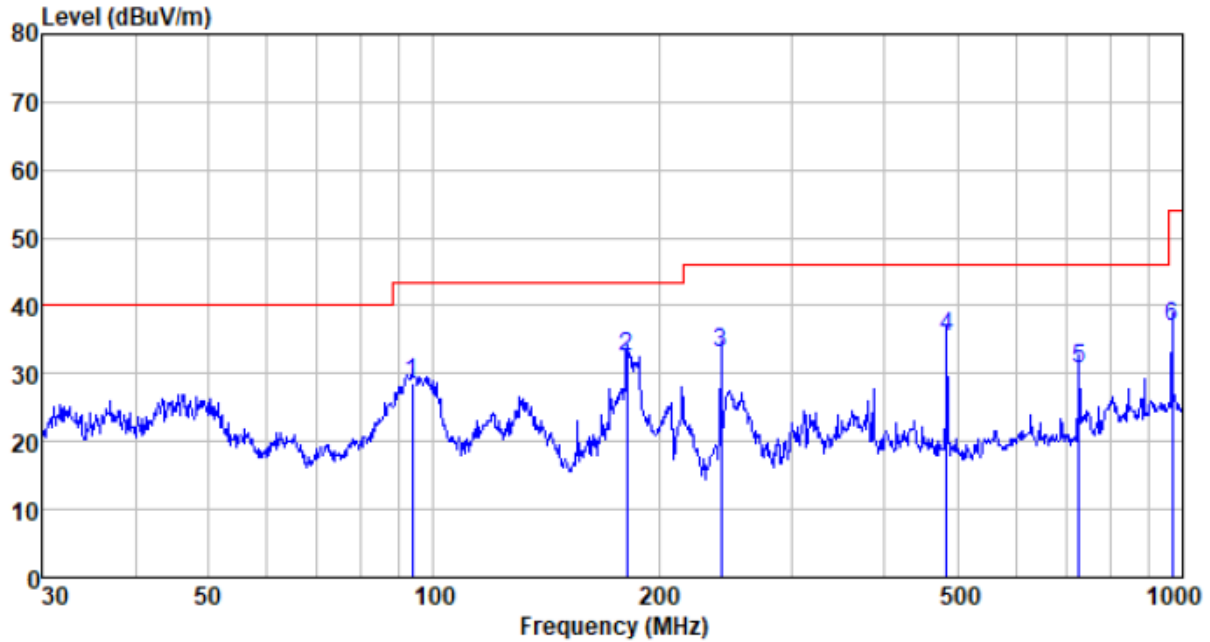

| Freq MHz | Reading level dBuV | Antenna factor dB/m | Cable loss dB | Preamp factor dB | level dBuV/m | Limit level dBuV/m | Over limit dB | Remark |
|-------------|--------------------------|---------------------------|---------------------|------------------------|-----------------|--------------------------|---------------------|--------|
| 93.768 | 53.00 | 11.25 | 1.14 | 36.67 | 28.72 | 43.50 | -14.78 | QP |
| 181.283 | 58.78 | 9.07 | 1.75 | 37.24 | 32.36 | 43.50 | -11.14 | QP |
| 241.676 | 56.36 | 11.89 | 2.08 | 37.37 | 32.96 | 46.00 | -13.04 | QP |
| 483.910 | 52.57 | 17.01 | 3.23 | 37.51 | 35.30 | 46.00 | -10.70 | QP |
| 726.805 | 44.10 | 20.10 | 4.19 | 37.63 | 30.76 | 46.00 | -15.24 | QP |
| 968.934 | 46.78 | 22.59 | 5.11 | 37.54 | 36.94 | 54.00 | -17.06 | QP |

■ Above 1GHz

| | |
|---------------|--------|
| Test channel: | Lowest |
|---------------|--------|

Peak value:

| Frequency (MHz) | Read Level (dBuV) | Antenna Factor (dB/m) | Cable Loss (dB) | Preamp Factor (dB) | Level (dBuV/m) | Limit Line (dBuV/m) | Over Limit (dB) | polarization |
|-----------------|-------------------|-----------------------|-----------------|--------------------|----------------|---------------------|-----------------|--------------|
| 4804.00 | 38.42 | 31.78 | 8.60 | 32.09 | 46.71 | 74.00 | -27.29 | Vertical |
| 7206.00 | 32.57 | 36.15 | 11.65 | 32.00 | 48.37 | 74.00 | -25.63 | Vertical |
| 9608.00 | 32.13 | 37.95 | 14.14 | 31.62 | 52.60 | 74.00 | -21.40 | Vertical |
| 12010.00 | * | | | | | 74.00 | | Vertical |
| 14412.00 | * | | | | | 74.00 | | Vertical |
| 4804.00 | 42.93 | 31.78 | 8.60 | 32.09 | 51.22 | 74.00 | -22.78 | Horizontal |
| 7206.00 | 34.42 | 36.15 | 11.65 | 32.00 | 50.22 | 74.00 | -23.78 | Horizontal |
| 9608.00 | 31.65 | 37.95 | 14.14 | 31.62 | 52.12 | 74.00 | -21.88 | Horizontal |
| 12010.00 | * | | | | | 74.00 | | Horizontal |
| 14412.00 | * | | | | | 74.00 | | Horizontal |

Average value:

| Frequency (MHz) | Read Level (dBuV) | Antenna Factor (dB/m) | Cable Loss (dB) | Preamp Factor (dB) | Level (dBuV/m) | Limit Line (dBuV/m) | Over Limit (dB) | polarization |
|-----------------|-------------------|-----------------------|-----------------|--------------------|----------------|---------------------|-----------------|--------------|
| 4804.00 | 27.02 | 31.78 | 8.60 | 32.09 | 35.31 | 54.00 | -18.69 | Vertical |
| 7206.00 | 21.13 | 36.15 | 11.65 | 32.00 | 36.93 | 54.00 | -17.07 | Vertical |
| 9608.00 | 20.14 | 37.95 | 14.14 | 31.62 | 40.61 | 54.00 | -13.39 | Vertical |
| 12010.00 | * | | | | | 54.00 | | Vertical |
| 14412.00 | * | | | | | 54.00 | | Vertical |
| 4804.00 | 31.37 | 31.78 | 8.60 | 32.09 | 39.66 | 54.00 | -14.34 | Horizontal |
| 7206.00 | 23.37 | 36.15 | 11.65 | 32.00 | 39.17 | 54.00 | -14.83 | Horizontal |
| 9608.00 | 19.96 | 37.95 | 14.14 | 31.62 | 40.43 | 54.00 | -13.57 | Horizontal |
| 12010.00 | * | | | | | 54.00 | | Horizontal |
| 14412.00 | * | | | | | 54.00 | | Horizontal |

Remark:

1. *Final Level = Receiver Read level + Antenna Factor + Cable Loss – Preamplifier Factor*
2. *The emission levels of other frequencies are very lower than the limit and not show in test report.*
3. *“*” means this data is the too weak instrument of signal is unable to test.*

| | |
|---------------|----------------|
| Test channel: | Middle channel |
|---------------|----------------|

Peak value:

| Frequency (MHz) | Read Level (dBuV) | Antenna Factor (dB/m) | Cable Loss (dB) | Preamp Factor (dB) | Level (dBuV/m) | Limit Line (dBuV/m) | Over Limit (dB) | polarization |
|-----------------|-------------------|-----------------------|-----------------|--------------------|----------------|---------------------|-----------------|--------------|
| 4882.00 | 38.02 | 31.85 | 8.67 | 32.12 | 46.42 | 74.00 | -27.58 | Vertical |
| 7323.00 | 32.31 | 36.37 | 11.72 | 31.89 | 48.51 | 74.00 | -25.49 | Vertical |
| 9764.00 | 31.89 | 38.35 | 14.25 | 31.62 | 52.87 | 74.00 | -21.13 | Vertical |
| 12205.00 | * | | | | | 74.00 | | Vertical |
| 14646.00 | * | | | | | 74.00 | | Vertical |
| 4882.00 | 42.46 | 31.85 | 8.67 | 32.12 | 50.86 | 74.00 | -23.14 | Horizontal |
| 7323.00 | 34.13 | 36.37 | 11.72 | 31.89 | 50.33 | 74.00 | -23.67 | Horizontal |
| 9764.00 | 31.38 | 38.35 | 14.25 | 31.62 | 52.36 | 74.00 | -21.64 | Horizontal |
| 12205.00 | * | | | | | 74.00 | | Horizontal |
| 14646.00 | * | | | | | 74.00 | | Horizontal |

Average value:

| Frequency (MHz) | Read Level (dBuV) | Antenna Factor (dB/m) | Cable Loss (dB) | Preamp Factor (dB) | Level (dBuV/m) | Limit Line (dBuV/m) | Over Limit (dB) | polarization |
|-----------------|-------------------|-----------------------|-----------------|--------------------|----------------|---------------------|-----------------|--------------|
| 4882.00 | 26.72 | 31.85 | 8.67 | 32.12 | 35.12 | 54.00 | -18.88 | Vertical |
| 7323.00 | 20.92 | 36.37 | 11.72 | 31.89 | 37.12 | 54.00 | -16.88 | Vertical |
| 9764.00 | 19.95 | 38.35 | 14.25 | 31.62 | 40.93 | 54.00 | -13.07 | Vertical |
| 12205.00 | * | | | | | 54.00 | | Vertical |
| 14646.00 | * | | | | | 54.00 | | Vertical |
| 4882.00 | 31.03 | 31.85 | 8.67 | 32.12 | 39.43 | 54.00 | -14.57 | Horizontal |
| 7323.00 | 23.15 | 36.37 | 11.72 | 31.89 | 39.35 | 54.00 | -14.65 | Horizontal |
| 9764.00 | 19.75 | 38.35 | 14.25 | 31.62 | 40.73 | 54.00 | -13.27 | Horizontal |
| 12205.00 | * | | | | | 54.00 | | Horizontal |
| 14646.00 | * | | | | | 54.00 | | Horizontal |

Remark:

1. *Final Level = Receiver Read level + Antenna Factor + Cable Loss – Pre-amplifier Factor*
2. *The emission levels of other frequencies are very lower than the limit and not show in test report.*
3. *“*”, means this data is the too weak instrument of signal is unable to test.*

| | |
|---------------|-----------------|
| Test channel: | Highest channel |
|---------------|-----------------|

Peak value:

| Frequency (MHz) | Read Level (dBUV) | Antenna Factor (dB/m) | Cable Loss (dB) | Preamp Factor (dB) | Level (dBUV/m) | Limit Line (dBUV/m) | Over Limit (dB) | polarization |
|-----------------|-------------------|-----------------------|-----------------|--------------------|----------------|---------------------|-----------------|--------------|
| 4960.00 | 37.29 | 31.93 | 8.73 | 32.16 | 45.79 | 74.00 | -28.21 | Vertical |
| 7440.00 | 31.82 | 36.59 | 11.79 | 31.78 | 48.42 | 74.00 | -25.58 | Vertical |
| 9920.00 | 31.46 | 38.81 | 14.38 | 31.88 | 52.77 | 74.00 | -21.23 | Vertical |
| 12400.00 | * | | | | | 74.00 | | Vertical |
| 14880.00 | * | | | | | 74.00 | | Vertical |
| 4960.00 | 41.57 | 31.93 | 8.73 | 32.16 | 50.07 | 74.00 | -23.93 | Horizontal |
| 7440.00 | 33.58 | 36.59 | 11.79 | 31.78 | 50.18 | 74.00 | -23.82 | Horizontal |
| 9920.00 | 30.88 | 38.81 | 14.38 | 31.88 | 52.19 | 74.00 | -21.81 | Horizontal |
| 12400.00 | * | | | | | 74.00 | | Horizontal |
| 14880.00 | * | | | | | 74.00 | | Horizontal |

Average value:

| Frequency (MHz) | Read Level (dBUV) | Antenna Factor (dB/m) | Cable Loss (dB) | Preamp Factor (dB) | Level (dBUV/m) | Limit Line (dBUV/m) | Over Limit (dB) | polarization |
|-----------------|-------------------|-----------------------|-----------------|--------------------|----------------|---------------------|-----------------|--------------|
| 4960.00 | 26.20 | 31.93 | 8.73 | 32.16 | 34.70 | 54.00 | -19.30 | Vertical |
| 7440.00 | 20.57 | 36.59 | 11.79 | 31.78 | 37.17 | 54.00 | -16.83 | Vertical |
| 9920.00 | 19.64 | 38.81 | 14.38 | 31.88 | 40.95 | 54.00 | -13.05 | Vertical |
| 12400.00 | * | | | | | 54.00 | | Vertical |
| 14880.00 | * | | | | | 54.00 | | Vertical |
| 4960.00 | 30.43 | 31.93 | 8.73 | 32.16 | 38.93 | 54.00 | -15.07 | Horizontal |
| 7440.00 | 22.75 | 36.59 | 11.79 | 31.78 | 39.35 | 54.00 | -14.65 | Horizontal |
| 9920.00 | 19.38 | 38.81 | 14.38 | 31.88 | 40.69 | 54.00 | -13.31 | Horizontal |
| 12400.00 | * | | | | | 54.00 | | Horizontal |
| 14880.00 | * | | | | | 54.00 | | Horizontal |

Remarks:

1. Final Level = Receiver Read level + Antenna Factor + Cable Loss – Pre-amplifier Factor
2. “*”, means this data is too weak instrument of signal is unable to test.
3. The emission levels of other frequencies are very lower than the limit and not show in test report.
4. The test data shows only the worst case GFSK mode

8 Test Setup Photo

Reference to the **appendix I** for details.

9 EUT Constructional Details

Reference to the **appendix II** for details.

-----End-----