



FCC 47 CFR PART 15 SUBPART C

for

750M Gigabit Travel Router

Model: GL-AR750S, GL-AR750S-EXT

Brand: GL-iNet

Test Report Number:
C180408Z03-RP1-1

Issued Date: August 17, 2018

Issued for

GL Technologies (HongKong) Limited

Unit 210D, 2/F Enterprise Place HongKong Science Park Shatin,N.T.

Issued by:

Compliance Certification Services (Shenzhen) Inc.

No.10-1 Mingkeda Logistics park, No.18, Huanguan South Rd.,
Guan Lan Town, Baoan District, Shenzhen, China

TEL: 86-755-28055000

FAX: 86-755-28055221



Certificate Number: 2861.01

Note: This report shall not be reproduced except in full, without the written approval of Compliance Certification Services (Shenzhen) Inc. This document may be altered or revised by Compliance Certification Services (Shenzhen) Inc. personnel only, and shall be noted in the revision section of the document. The client should not use it to claim product endorsement by TAF, A2LA, NVLAP, NIST or any government agencies. The test results in the report only apply to the tested sample.



Revision History

Rev.	Issue Date	Revisions	Effect Page	Revised By
00	August 17, 2018	Initial Issue	ALL	Sinphy Xie



TABLE OF CONTENTS

1 TEST CERTIFICATION..... 4

2 TEST RESULT SUMMARY..... 5

3 EUT DESCRIPTION 6

4 TEST METHODOLOGY 8

 4.1. DESCRIPTION OF TEST MODES 8

5 SETUP OF EQUIPMENT UNDER TEST..... 9

 5.1. DESCRIPTION OF SUPPORT UNITS..... 9

 5.2. CONFIGURATION OF SYSTEM UNDER TEST 9

 5.3. TEST INSTRUMENTS 10

6 FACILITIES AND ACCREDITATIONS 12

 6.1. FACILITIES 12

 6.2. ACCREDITATIONS 12

 6.3. MEASUREMENT UNCERTAINTY 12

7 FCC PART 15.247 REQUIREMENTS..... 13

 7.1. POWER LINE CONDUCTED EMISSIONS MEASUREMENT 13

 7.2. SPURIOUS EMISSIONS MEASUREMENT 19

 7.3. 6dB BANDWIDTH MEASUREMENT 92

 7.4. ANTENNA GAIN 106

 7.5. PEAK OUTPUT POWER 108

 7.6. BAND EDGES MEASUREMENT 111

 7.7. PEAK POWER SPECTRAL DENSITY MEASUREMENT 160



1 TEST CERTIFICATION

Product	750M Gigabit Travel Router
Model	GL-AR750S, GL-AR750S-EXT
Brand	GL-iNet
Tested	April 8~August 14, 2018
Applicant	GL Technologies (HongKong) Limited Unit 210D, 2/F Enterprise Place HongKong Science Park Shatin,N.T.
Manufacturer	GL Technologies (HongKong) Limited Unit 210D, 2/F Enterprise Place HongKong Science Park Shatin,N.T.

APPLICABLE STANDARDS			
Standard	Test Type	Standard	Test Type
15.207(a)	Power Line Conducted Emissions	15.247(d) 15.209(a)	<ul style="list-style-type: none"> ● Spurious Emissions ● Conducted Measurement ● Radiated Emissions
15.247(a)(2)	6dB Bandwidth Measurement	15.247(b)(3) 15.247(b)(4)	Peak Power Measurement
15.247(d)	Band Edges Measurement	15.247(e)	Peak Power Spectral Density

We hereby certify that:

The above equipment was tested by Compliance Certification Services (Shenzhen) Inc. The test data, data evaluation, test procedures, and equipment configurations shown in this report were made in accordance with the procedures given in **ANSI C63.10: 2013** and the energy emitted by the sample EUT tested as described in this report is in compliance with the requirements of FCC Rules Part 15.207, 15.209, 15.247. The test results of this report relate only to the tested sample EUT identified in this report.

Approved by:

Reviewed by:

Eve Wang
 Supervisor of EMC Dept.
 Compliance Certification Services (Shenzhen) Inc.

Nancy Fu
 Supervisor of Report Dept.
 Compliance Certification Services (Shenzhen) Inc.



2 TEST RESULT SUMMARY

APPLICABLE STANDARDS			
Standard	Test Type	Result	Remark
15.247(a)(2)	6dB Bandwidth Measurement	Pass	Meet the requirement of limit.
15.247(b)(3) 15.247(b)(4)	Peak Power Measurement	Pass	Meet the requirement of limit.
15.247(d)	Band Edges Measurement	Pass	Meet the requirement of limit.
15.247(e)	Peak Power Spectral Density	Pass	Meet the requirement of limit.
15.247(d) 15.209(a)	<ul style="list-style-type: none">● Spurious Emissions● Conducted Measurement● Radiated Emissions	Pass	Meet the requirement of limit.
15.207(a)	Power line Conducted Emissions	Pass	Meet the requirement of limit.

- Note:
1. The statements of test result on the above are decided by the request of test standard only; the measurement uncertainties are not factored into this compliance determination.
 2. The information of measurement uncertainty is available upon the customer's request.



3 EUT DESCRIPTION

Product	750M Gigabit Travel Router
Model Number	GL-AR750S, GL-AR750S-EXT
Brand	GL-iNet
Model Discrepancy	"GL-AR750S" is internal antenna, "GL-AR750S-EXT" is external antenna.
Identify Number	C180408Z03-RP1-1
Received Date	April 8, 2018
EUT Power Rating	DC5V supplied by the adapter
Adapter Manufacturer & Model	SHENZHEN KEYU POWER SUPPLY TECHNOLOGY CO., LTD. Model: KA1517-0502000USU Input: 100-240Vac 50/60Hz 0.35A Max. Output: 5.0Vdc 2000mA
USB Cable	Unshielded, 0.80m
Transmit Power	IEEE 802.11b mode: 14.50dBm (Antenna 0) IEEE 802.11b mode: 14.35dBm (Antenna 1) IEEE 802.11g mode: 18.71dBm (Antenna 0) IEEE 802.11g mode: 18.93dBm (Antenna 1) IEEE 802.11n HT20 MHz mode: 21.24dBm(Combine with Antenna 0 and Antenna 1) IEEE 802.11n HT40 MHz mode: 20.71dBm(Combine with Antenna 0 and Antenna 1)
Modulation Technique	IEEE 802.11b mode: DSSS(CCK,QPSK, BPSK) IEEE 802.11g mode: OFDM (BPSK/QPSK/16QAM/64QAM) IEEE 802.11n HT20 MHz mode: OFDM (BPSK/QPSK/16QAM/64QAM) IEEE 802.11n HT40 MHz mode: OFDM (BPSK/QPSK/16QAM/64QAM)
Transmit Data Rate	IEEE 802.11b: 11Mbps(CCK) with fall back rates of 5.5/2/1Mbps IEEE 802.11g: 54Mbps with fall back rates of 48/36/24/18/12/9 /6Mbps IEEE 802.11n HT20: 130Mbps with fall back rates of 130/117/104/ 78/52/39/26/13Mbps IEEE 802.11n HT40: 270Mbps with fall back rates of 270/243/216/ 162/108/81/54/27Mbps
Number of Channels	IEEE 802.11b mode: 11 Channels IEEE 802.11g mode: 11 Channels IEEE 802.11n HT20 MHz mode: 11 Channels IEEE 802.11n HT40 MHz mode: 7 Channels
Antenna Specification	GL-AR750S: Internal antenna 0 with 4.68dBi gain (Max) Internal antenna 1 with 3.64dBi gain (Max) GL-AR750S-EXT: External antenna 0 with 3.98dBi gain (Max) External antenna 1 with 3.98dBi gain (Max)
Channels Spacing	IEEE 802.11b/g ,802.11n HT20/HT40 : 5MHz
Temperature Range	-20°C ~ +40°C
Hardware Version	V1.2
Software Version	V3.001



- Note:**
1. The sample selected for test was engineering sample that approximated to production product and was provided by manufacturer.
 2. This submittal(s) (test report) is intended for FCC ID: **2AFIWGL-AR750S** filing to comply with Section 15.207, 15.209 and 15.247 of the FCC Part 15, Subpart C Rules.



4 TEST METHODOLOGY

4.1. DESCRIPTION OF TEST MODES

The EUT has been tested under operating condition.

Use “Atheros Radio Test 2” to control the EUT for staying in continuous transmitting and receiving mode.

Test Item	Test mode	Worse mode
Conducted Emission	Mode 1: Full system 1000Mbps 20% (AC120V/60Hz)	<input checked="" type="checkbox"/>
	Mode 2: Full system 1000Mbps 20% (AC240V/50Hz)	<input checked="" type="checkbox"/>
Radiated Emission	Mode 1: Continuously Transmitting	<input checked="" type="checkbox"/>

After verification, all tests were carried out with the worst case test modes as shown below except radiated spurious emission below 1GHz, which worst case was in normal link mode only, and power line conducted emission below 30MHz, which worst case was in normal link mode.

IEEE802.11b mode: Channel Low (2412MHz), Channel Mid (2437MHz) and Channel High (2462MHz) with 1Mbps data rate were chosen for full testing.

IEEE802.11g mode: Channel Low (2412MHz), Channel Mid (2437MHz) and Channel High (2462MHz) with 6Mbps data rate were chosen for full testing.

IEEE 802.11n HT20 MHz mode: Channel Low (2412MHz), Channel Mid (2437MHz) and Channel High (2462MHz) with 13Mbps data rate were chosen for full testing.

IEEE 802.11n HT40 MHz mode: Channel Low (2422MHz), Channel Mid (2437MHz) and Channel High (2452MHz) with 27Mbps data rate were chosen for full testing.



5 SETUP OF EQUIPMENT UNDER TEST

5.1. DESCRIPTION OF SUPPORT UNITS

The EUT has been tested as an independent unit together with other necessary accessories or support units. The following support units or accessories were used to form a representative test configuration during the tests.

No.	Equipment	Model No.	Serial No.	FCC ID	Brand	Data Cable	Power Cord
1	Notebook 1#	Thinkpad E335	N/A	DoC	LENOVO	Unshielded 3.00m	Unshielded 1.50m (AC Cable) Shielded 1.80m (DC Cable)
2	Notebook 2#	Z8B	N/A	DoC	acer	Unshielded 3.00m	Unshielded 1.50m (AC Cable) Shielded 1.80m (DC Cable)
3	U disk	DTSE9G2 16GB	N/A	DoC	Kingston	Unshielded 0.20m	N/A
4	TF card	MB-MP16D	N/A	DoC	SANSUNG	N/A	N/A
5	Notebook (RF)	MS2392	NXMPGCN015503 11F8C6600	N/A	Acer	Shielded 1.50m	Unshielded 1.00m (AC Cable) Shielded 1.80m (DC Cable)

Note:

Grounding was established in accordance with the manufacturer's requirements and conditions for the intended use.

5.2. CONFIGURATION OF SYSTEM UNDER TEST

See test photographs attached in Appendix II for the actual connections between EUT and support equipment.

**5.3. TEST INSTRUMENTS**

Conducted Emission Test Site					
Name of Equipment	Manufacturer	Model Number	Serial Number	Last Calibration	Due Calibration
EMI TEST RECEIVER	ROHDE&SCHWARZ	ESCI	100783	01/27/2018	01/26/2019
LISN(EUT)	ROHDE&SCHWARZ	ENV216	101543-WX	01/27/2018	01/26/2019
LISN	EMCO	3825/2	8901-1459	01/27/2018	01/26/2019
Temp. / Humidity Meter	VICTOR	HTC-1	N/A	01/29/2018	01/28/2019
Test S/W	FARAD	EZ-EMC/ CCS-3A1-CE			

Radiated Emission Test Site 966 (2)					
Name of Equipment	Manufacturer	Model Number	Serial Number	Last Calibration	Due Calibration
Spectrum Analyzer	Agilent	N9010A	MY52221469	01/27/2018	01/26/2019
EMI TEST RECEIVER	ROHDE&SCHWARZ	ESCI	100783	01/27/2018	01/26/2019
Amplifier	EMEC	EM330	060661	01/27/2018	01/26/2019
High Noise Amplifier	Agilent	8449B	3008A01838	01/27/2018	01/26/2019
Loop Antenna	COM-POWER	AL-130	121044	01/30/2018	01/29/2019
Bilog Antenna	SCHAFFNER	CBL6143	5082	02/21/2018	02/20/2019
Horn Antenna	SCHWARZBECK	BBHA9120	D286	01/27/2018	01/26/2019
Board-Band Horn Antenna	Schwarzbeck	BBHA 9170	9170-497	01/24/2018	01/23/2019
Turn Table	N/A	N/A	N/A	N.C.R	N.C.R
Antenna Tower	SUNOL	TLT2	N/A	N.C.R	N.C.R
Controller	Sunol Sciences	SC104V	022310-1	N.C.R	N.C.R
Controller	CT	N/A	N/A	N.C.R	N.C.R
Temp. / Humidity Meter	Anymetre	JR913	N/A	01/29/2018	01/28/2019
Test S/W	FARAD	LZ-RF / CCS-SZ-3A2			

Antenna Conducted Spurious Emission					
Name of Equipment	Manufacturer	Model Number	Serial Number	Last Calibration	Due Calibration
Spectrum Analyzer	Agilent	N9010A	MY52221469	01/27/2018	01/26/2019

6dB Bandwidth					
Name of Equipment	Manufacturer	Model Number	Serial Number	Last Calibration	Due Calibration
Spectrum Analyzer	Agilent	N9010A	MY52221469	01/27/2018	01/26/2019



Antenna Gain					
Name of Equipment	Manufacturer	Model Number	Serial Number	Last Calibration	Due Calibration
Spectrum Analyzer	Agilent	N9010A	MY52221469	01/27/2018	01/26/2019

Peak Output Power					
Name of Equipment	Manufacturer	Model Number	Serial Number	Last Calibration	Due Calibration
Power Meter	Anritsu	ML2495A	1204003	01/27/2018	01/26/2019
Power Sensor	Anritsu	MA2411B	1126150	01/27/2018	01/26/2019

Band edges					
Name of Equipment	Manufacturer	Model Number	Serial Number	Last Calibration	Due Calibration
Spectrum Analyzer	Agilent	N9010A	MY52221469	01/27/2018	01/26/2019

Peak Power Spectral Density					
Name of Equipment	Manufacturer	Model Number	Serial Number	Last Calibration	Due Calibration
Spectrum Analyzer	Agilent	N9010A	MY52221469	01/27/2018	01/26/2019

- Note: 1. The calibration interval of the above test instruments is 12 months and the calibrations are traceable to NML/ROC and NIST/USA.
2. N.C.R = No Calibration Request.



6 FACILITIES AND ACCREDITATIONS

6.1. FACILITIES

All measurement facilities used to collect the measurement data are located at **No.10-1 Mingkeda Logistics park, No.18, Huanguan South Rd., Guan Lan Town, Baoan District, Shenzhen, China**

The sites are constructed in conformance with the requirements of ANSI C63.10, ANSI C63.7 and CISPR Publication 22. All receiving equipment conforms to CISPR Publication 16-1, "Radio Interference Measuring Apparatus and Measurement Methods."

6.2. ACCREDITATIONS

Our laboratories are accredited and approved by the following accreditation body according to ISO/IEC 17025.

USA	A2LA
China	CNAS

The measuring facility of laboratories has been authorized or registered by the following approval agencies.

USA	FCC
Japan	VCCI (C-4815,R-4320,T-2317, G-10624)
Canada	INDUSTRY CANADA

Copies of granted accreditation certificates are available for downloading from our web site, <http://www.ccssz.com>

6.3. MEASUREMENT UNCERTAINTY

Where relevant, the following measurement uncertainty levels have been estimated for tests performed on the EUT as specified in CISPR 16-4-2:

Parameter	Uncertainty
Radiated Emission, 30 to 200 MHz Test Site : 966(2)	+/-3.6880dB
Radiated Emission, 200 to 1000 MHz Test Site : 966(2)	+/-3.6695dB
Radiated Emission, 1 to 8 GHz	+/-5.1782dB
Radiated Emission, 8 to 18 GHz	+/-5.2173dB
Conducted Emissions	+/-3.6836dB
Band Width	178kHz
Peak Output Power MU	+/-1.906dB
Band Edge MU	+/-0.182dB
Channel Separation MU	416.178Hz
Duty Cycle MU	0.054ms
Frequency Stability MU	226Hz

This uncertainty represents an expanded uncertainty expressed at approximately the 95% confidence level using a coverage factor of k=2.

The measured result is above (below) the specification limit by a margin less than the measurement uncertainty; it is therefore not possible to state compliance based on the 95% level of confidence. However, the result indicates that compliance (non-compliance) is more probable than non-compliance) with the specification limit.



7 FCC PART 15.247 REQUIREMENTS

7.1. POWER LINE CONDUCTED EMISSIONS MEASUREMENT

7.1.1. LIMITS OF CONDUCTED EMISSIONS MEASUREMENT

According to §15.207(a), except as shown in paragraphs (b) and (c) of this section, for an intentional radiator that is designed to be connected to the public utility (AC) power line, the radio frequency voltage that is conducted back onto the AC power line on any frequency or frequencies within the band 150 kHz to 30 MHz shall not exceed the limits in the following table, as measured using a 50 μ H/50 ohms line impedance stabilization network (LISN). Compliance with the provisions of this paragraph shall be based on the measurement of the radio frequency voltage between each power line and ground at the power terminal. The lower limit applies at the boundary between the frequency ranges.

Frequency Range (MHz)	Limits (dB μ V)	
	Quasi-peak	Average
0.15 to 0.50	66 to 56*	56 to 46*
0.50 to 5	56	46
5 to 30	60	50

NOTE:

- (1) The lower limit shall apply at the transition frequencies.
- (2) The limit decreases in line with the logarithm of the frequency in the range of 0.15 to 0.50 MHz.
- (3) All emanations from a class A/B digital device or system, including any network of conductors and apparatus connected thereto, shall not exceed the level of field strengths specified above.

7.1.2. TEST PROCEDURES (please refer to measurement standard)

- The EUT and Support equipment, if needed, was placed on a non-conducted table, which is 0.8m above the ground plane and 0.4m away from the conducted wall.
- The test equipment EUT installed received AC main power, through a Line Impedance Stabilization Network (LISN), which supplied power source and was grounded to the ground plane. All support equipment power received from a second LISN. The two LISNs provide 50 ohm/ 50uH of coupling impedance for the measuring instrument.
- The EUT test program was started. Emissions were measured on each current carrying line of the EUT using an EMI Test Receiver connected to the LISN powering the EUT.
- The frequency range from 150 kHz to 30 MHz was searched. The test data of the worst-case condition(s) was recorded. Emission levels under limit 20dB were not recorded.



7.1.3. TEST SETUP

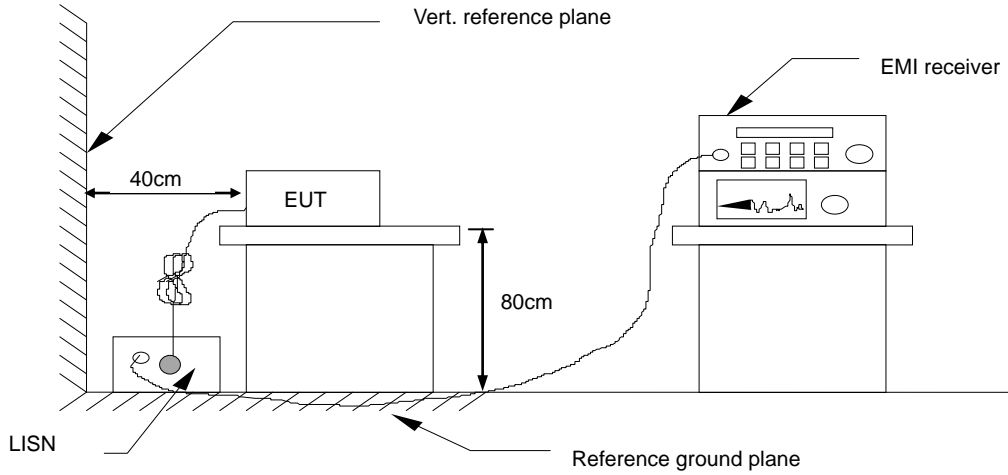

For the actual test configuration, please refer to the related item - Photographs of the Test Configuration.

7.1.4. DATA SAMPLE

Frequency (MHz)	QuasiPeak Reading (dBuV)	Average Reading (dBuV)	Correction Factor (dB)	QuasiPeak Result (dBuV)	Average Result (dBuV)	QuasiPeak Limit (dBuV)	Average Limit (dBuV)	QuasiPeak Margin (dB)	Average Margin (dB)	Remark (Pass/Fail)
XXX.XXXX	32.69	25.65	11.52	44.21	37.17	65.78	55.79	-21.57	-18.62	Pass

- Factor = Insertion loss of LISN + Cable Loss
- Result = Quasi-peak Reading/ Average Reading + Factor
- Limit = Limit stated in standard
- Margin = Result (dBuV) – Limit (dBuV)



7.1.5. TEST RESULTS

Model No.	GL-AR750S	RBW,VBW	9 kHz
Environmental Conditions	22°C, 45% RH	Test Mode	Mode 1
Tested by	Eason Nie	Line	L
Test Date	June 27, 2018	Test Voltage	AC120V/60Hz

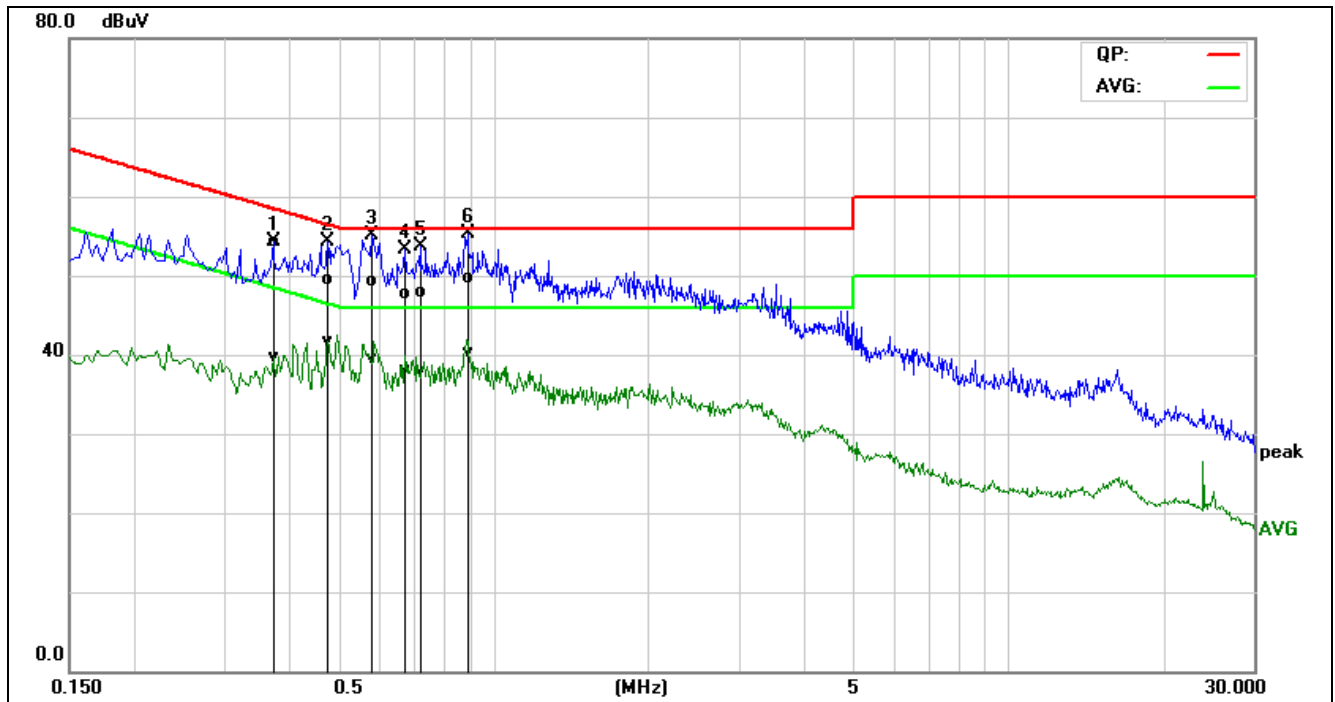

Frequency (MHz)	QuasiPeak Reading (dBuV)	Average Reading (dBuV)	Correction Factor (dB)	QuasiPeak Result (dBuV)	Average Result (dBuV)	QuasiPeak Limit (dBuV)	Average Limit (dBuV)	QuasiPeak Margin (dB)	Average Margin (dB)	Remark (Pass/Fail)	Line
0.3740	34.64	20.08	19.57	54.21	39.65	58.41	48.41	-4.20	-8.76	Pass	L
0.4780	30.06	22.08	19.54	49.60	41.62	56.37	46.37	-6.77	-4.75	Pass	L
0.5820	29.84	19.94	19.56	49.40	39.50	56.00	46.00	-6.60	-6.50	Pass	L
0.6740	28.20	18.50	19.60	47.80	38.10	56.00	46.00	-8.20	-7.90	Pass	L
0.7220	28.29	18.39	19.61	47.90	38.00	56.00	46.00	-8.10	-8.00	Pass	L
0.8940	30.13	20.73	19.57	49.70	40.30	56.00	46.00	-6.30	-5.70	Pass	L

REMARKS: L = Live Line



Model No.	GL-AR750S	RBW,VBW	9 kHz
Environmental Conditions	22°C, 45% RH	Test Mode	Mode 1
Tested by	Eason Nie	Line	N
Test Date	June 27, 2018	Test Voltage	AC120V/60Hz

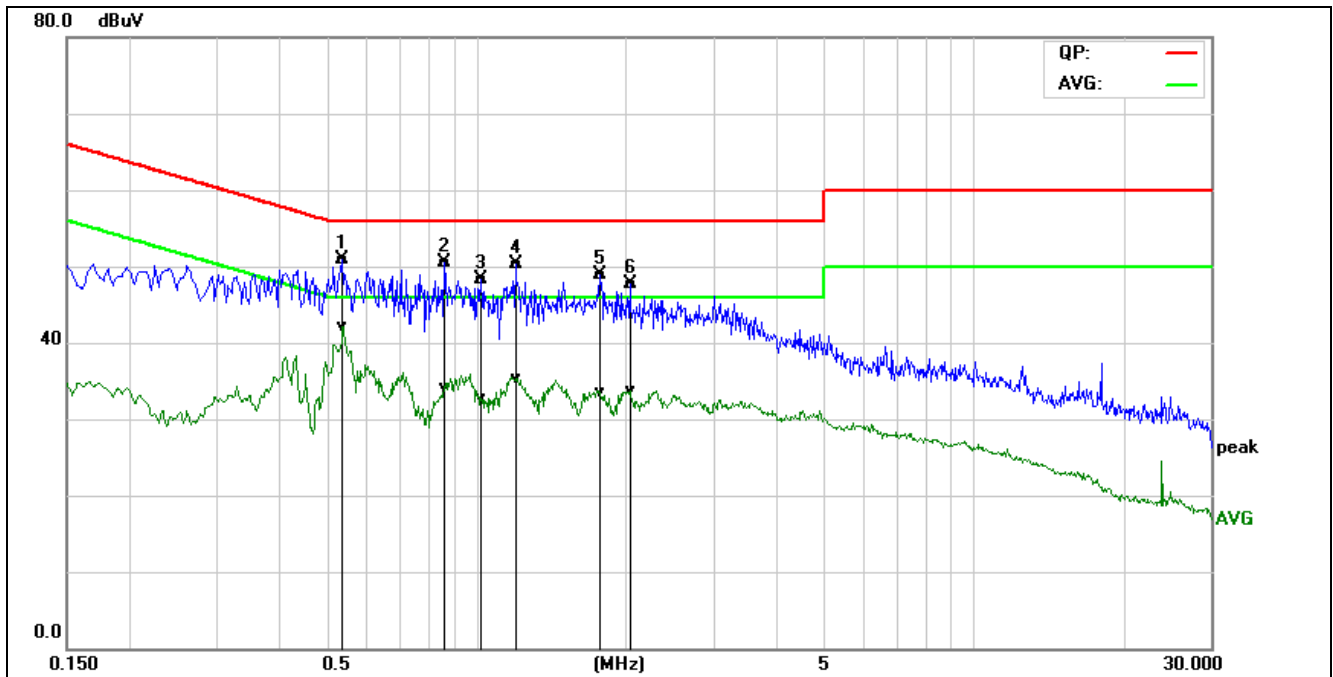

Frequency (MHz)	QuasiPeak Reading (dBuV)	Average Reading (dBuV)	Correction Factor (dB)	QuasiPeak Result (dBuV)	Average Result (dBuV)	QuasiPeak Limit (dBuV)	Average Limit (dBuV)	QuasiPeak Margin (dB)	Average Margin (dB)	Remark (Pass/Fail)	Line
0.5380	31.27	22.53	19.55	50.82	42.08	56.00	46.00	-5.18	-3.92	Pass	N
0.8660	30.87	14.54	19.58	50.45	34.12	56.00	46.00	-5.55	-11.88	Pass	N
1.0220	28.71	13.17	19.55	48.26	32.72	56.00	46.00	-7.74	-13.28	Pass	N
1.1980	30.68	15.76	19.58	50.26	35.34	56.00	46.00	-5.74	-10.66	Pass	N
1.7740	29.22	13.83	19.68	48.90	33.51	56.00	46.00	-7.10	-12.49	Pass	N
2.0380	27.90	14.07	19.72	47.62	33.79	56.00	46.00	-8.38	-12.21	Pass	N

REMARKS: N = Neutral Line



Model No.	GL-AR750S	RBW,VBW	9 kHz
Environmental Conditions	22°C, 45% RH	Test Mode	Mode 2
Tested by	Eason Nie	Line	L
Test Date	June 27, 2018	Test Voltage	AC240V/50Hz

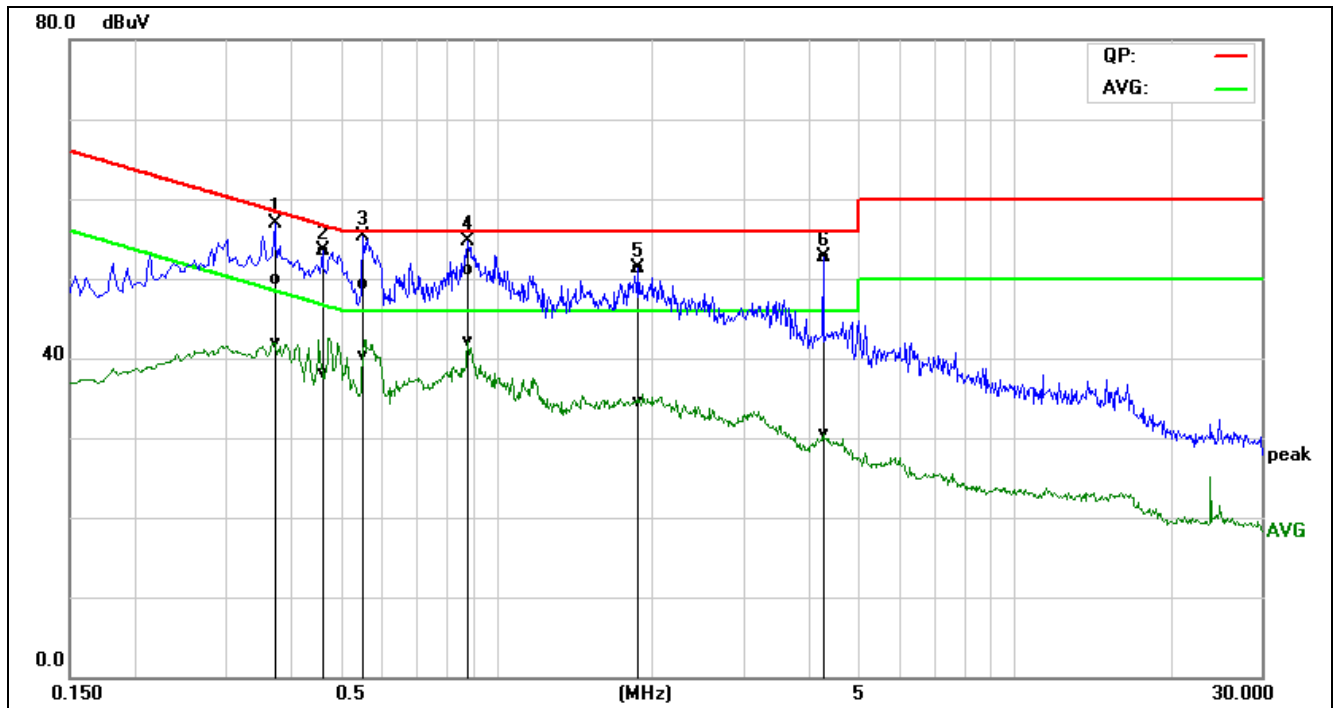

Frequency (MHz)	QuasiPeak Reading (dBuV)	Average Reading (dBuV)	Correction Factor (dB)	QuasiPeak Result (dBuV)	Average Result (dBuV)	QuasiPeak Limit (dBuV)	Average Limit (dBuV)	QuasiPeak Margin (dB)	Average Margin (dB)	Remark (Pass/Fail)	Line
0.3740	30.33	22.38	19.57	49.90	41.95	58.41	48.41	-8.51	-6.46	Pass	L
0.4620	33.97	18.49	19.54	53.51	38.03	56.66	46.66	-3.15	-8.63	Pass	L
0.5540	29.85	20.85	19.55	49.40	40.40	56.00	46.00	-6.60	-5.60	Pass	L
0.8820	31.53	22.58	19.57	51.10	42.15	56.00	46.00	-4.90	-3.85	Pass	L
1.8780	31.62	14.86	19.70	51.32	34.56	56.00	46.00	-4.68	-11.44	Pass	L
4.2700	33.05	10.71	19.73	52.78	30.44	56.00	46.00	-3.22	-15.56	Pass	L

REMARKS: L= Live Line



Model No.	GL-AR750S	RBW,VBW	9 kHz
Environmental Conditions	22°C, 45% RH	Test Mode	Mode 2
Tested by	Eason Nie	Line	N
Test Date	June 27, 2018	Test Voltage	AC240V/50Hz

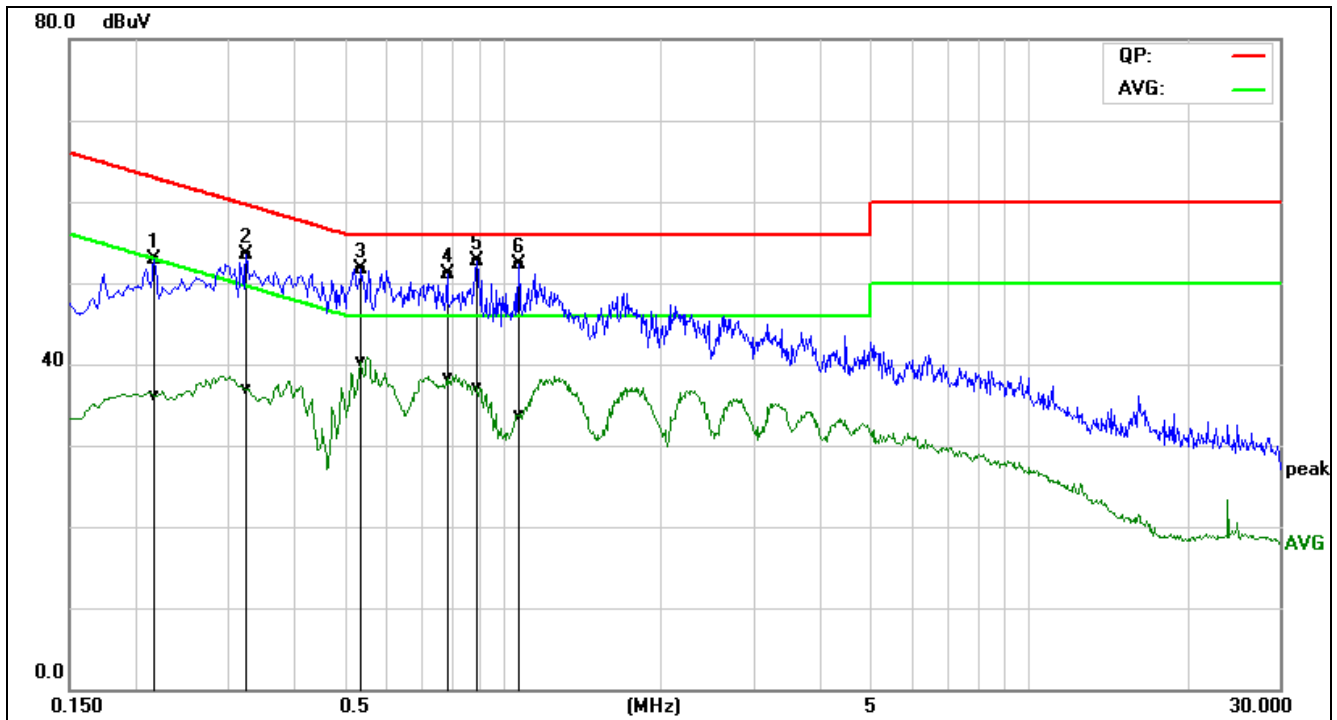

Frequency (MHz)	QuasiPeak Reading (dBuV)	Average Reading (dBuV)	Correction Factor (dB)	QuasiPeak Result (dBuV)	Average Result (dBuV)	QuasiPeak Limit (dBuV)	Average Limit (dBuV)	QuasiPeak Margin (dB)	Average Margin (dB)	Remark (Pass/Fail)	Line
0.2180	33.30	16.52	19.54	52.84	36.06	62.89	52.89	-10.05	-16.83	Pass	N
0.3260	33.88	17.28	19.54	53.42	36.82	59.55	49.55	-6.13	-12.73	Pass	N
0.5380	32.23	20.75	19.55	51.78	40.30	56.00	46.00	-4.22	-5.70	Pass	N
0.7860	31.54	18.65	19.59	51.13	38.24	56.00	46.00	-4.87	-7.76	Pass	N
0.8900	33.19	17.47	19.57	52.76	37.04	56.00	46.00	-3.24	-8.96	Pass	N
1.0740	32.80	14.11	19.57	52.37	33.68	56.00	46.00	-3.63	-12.32	Pass	N

REMARKS: N = Neutral Line



7.2. SPURIOUS EMISSIONS MEASUREMENT

7.2.1. CONDUCTED EMISSIONS MEASUREMENT

7.2.1.1. LIMITS OF CONDUCTED EMISSIONS MEASUREMENT

§15.247(d) specifies that in any 100 kHz bandwidth outside of the authorized frequency band, the power shall be attenuated according to the following conditions:

If the peak output power procedure is used to measure the fundamental emission power to demonstrate compliance to 15.247(b)(3) requirements, then the peak conducted output power measured within any 100 kHz outside the authorized frequency band shall be attenuated by at least 20 dB relative to the maximum measured in-band peak PSD level.

If the average output power procedure is used to measure the fundamental emission power to demonstrate compliance to 15.247(b) (3) requirements, then the power in any 100 kHz outside of the authorized frequency band shall be attenuated by at least 30 dB relative to the maximum measured in-band average PSD level.

In addition, radiated emissions which fall in the restricted bands, as defined in §15.205(a), must also comply with the radiated emission limits specified in 15.209(a) (see Section 15.205(c)).

7.2.1.2. TEST PROCEDURE (please refer to measurement standard)

Conducted RF measurements of the transmitter output were made to confirm that the EUT antenna port conducted emissions meet the specified limit and to identify any spurious signals that require further investigation or measurements on the radiated emissions site.

The transmitter output is connected to the spectrum analyzer. The resolution bandwidth is set to 100 kHz. The video bandwidth is set to 300 kHz.

Measurements are made over the 9 kHz to 26GHz range with the transmitter set to the lowest, middle, and highest channels. No emission found between lowest internal used/generated frequency to 10MHz, it is only recorded 10MHz to 26GHz.



7.2.1.3. TEST RESULTS

Test Plot

IEEE 802.11b mode (Antenna 0)

CH Low (10MHz ~26.5GHz)

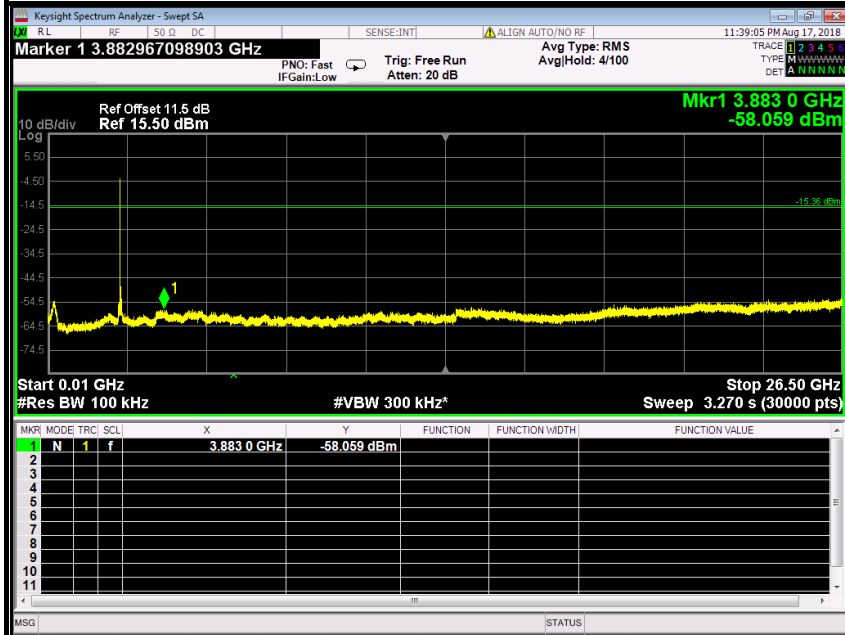

CH Low (2.31GHz ~2.43GHz)

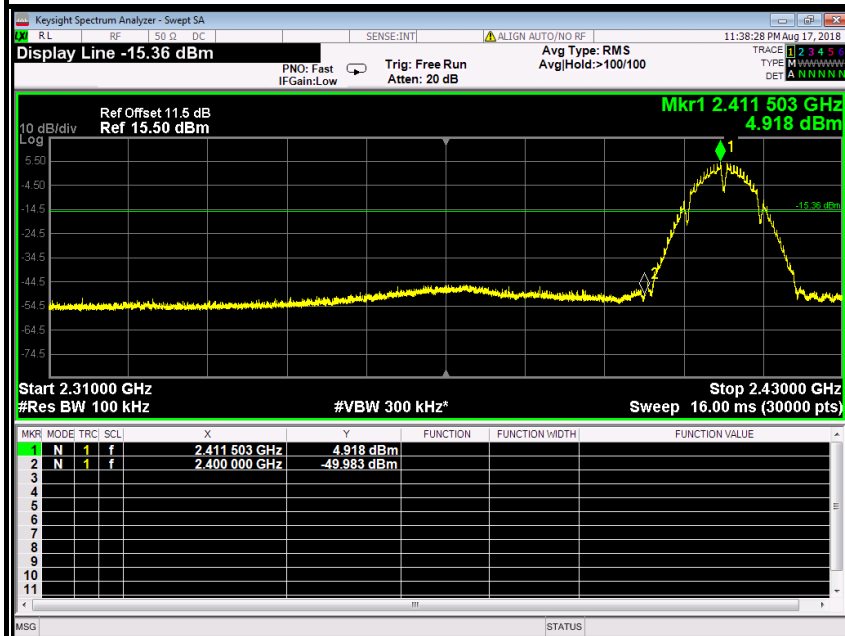

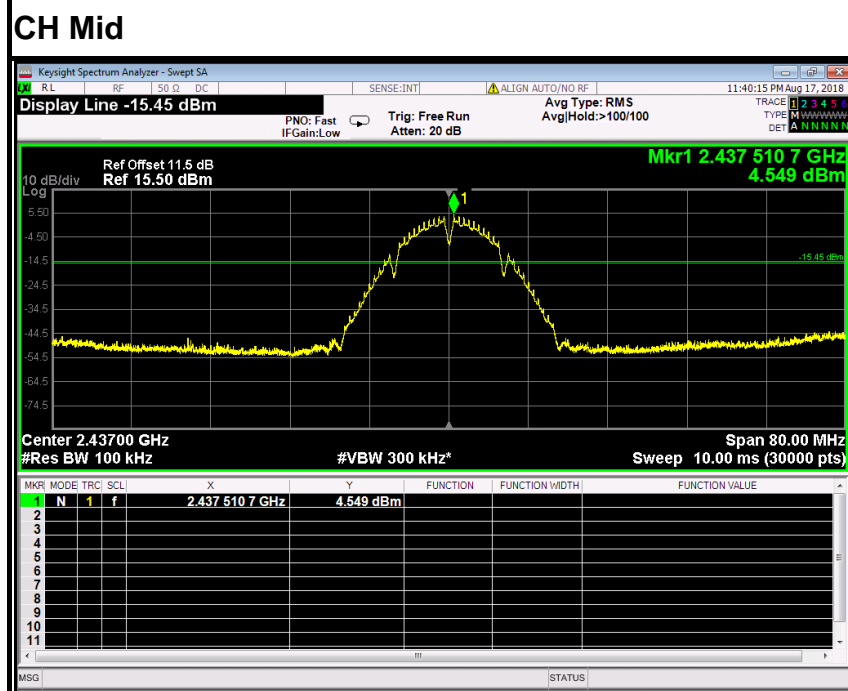
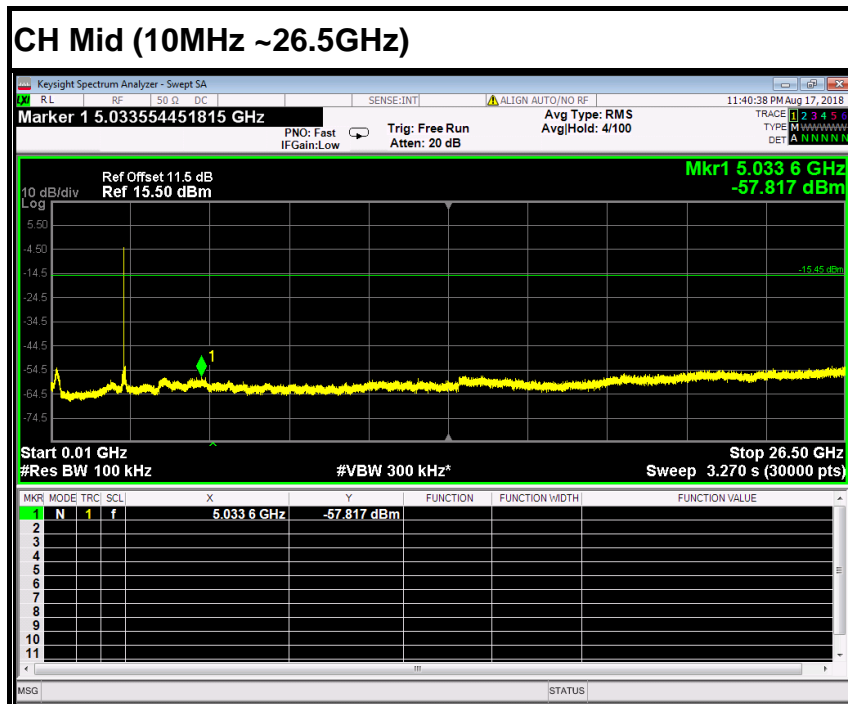

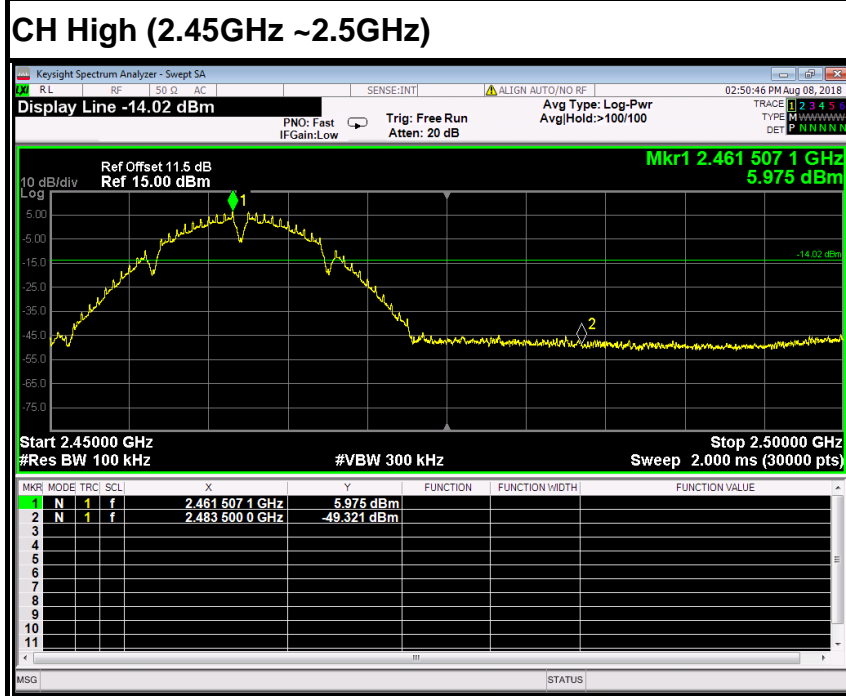
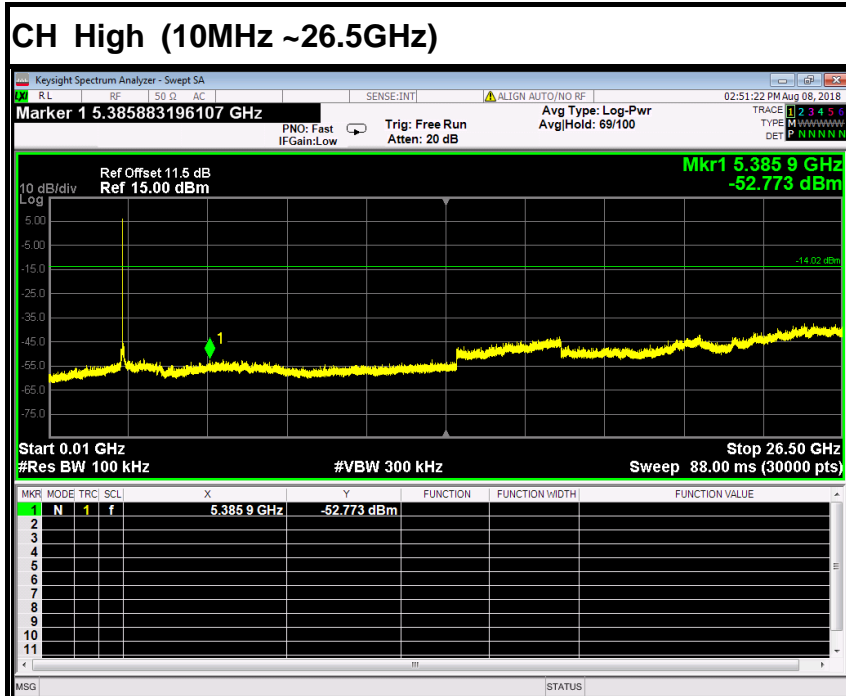



IEEE 802.11b mode (Antenna 1)

CH Low (10MHz ~26.5GHz)

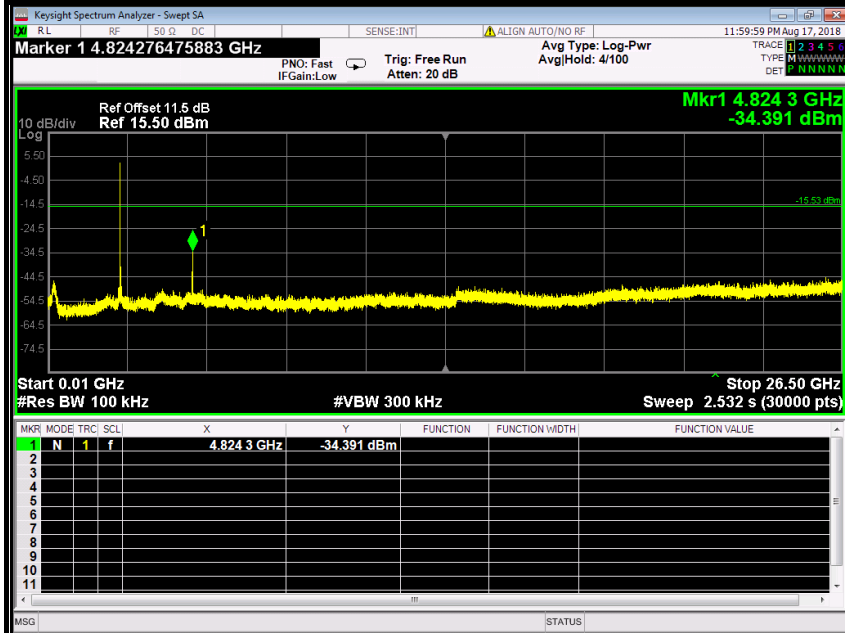

CH Low (2.31GHz ~2.43GHz)

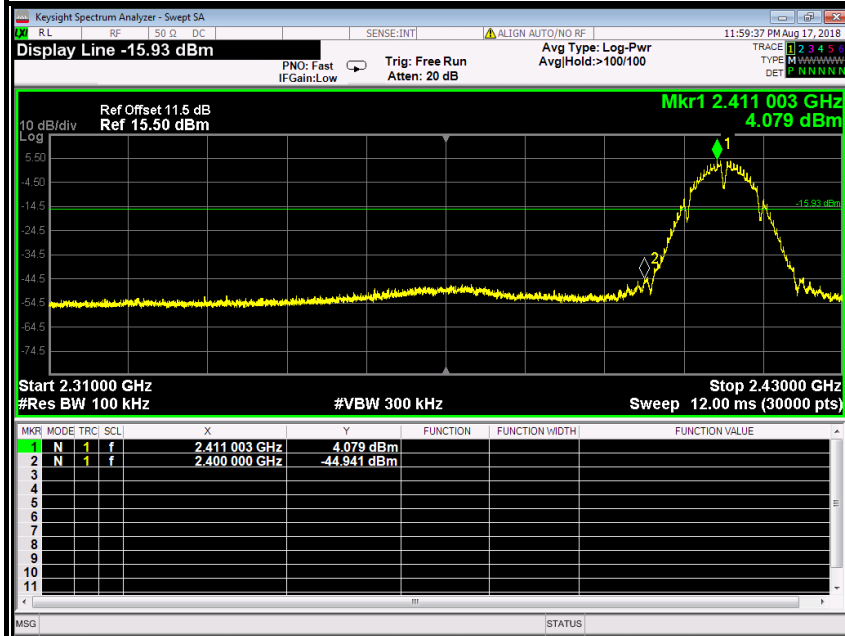

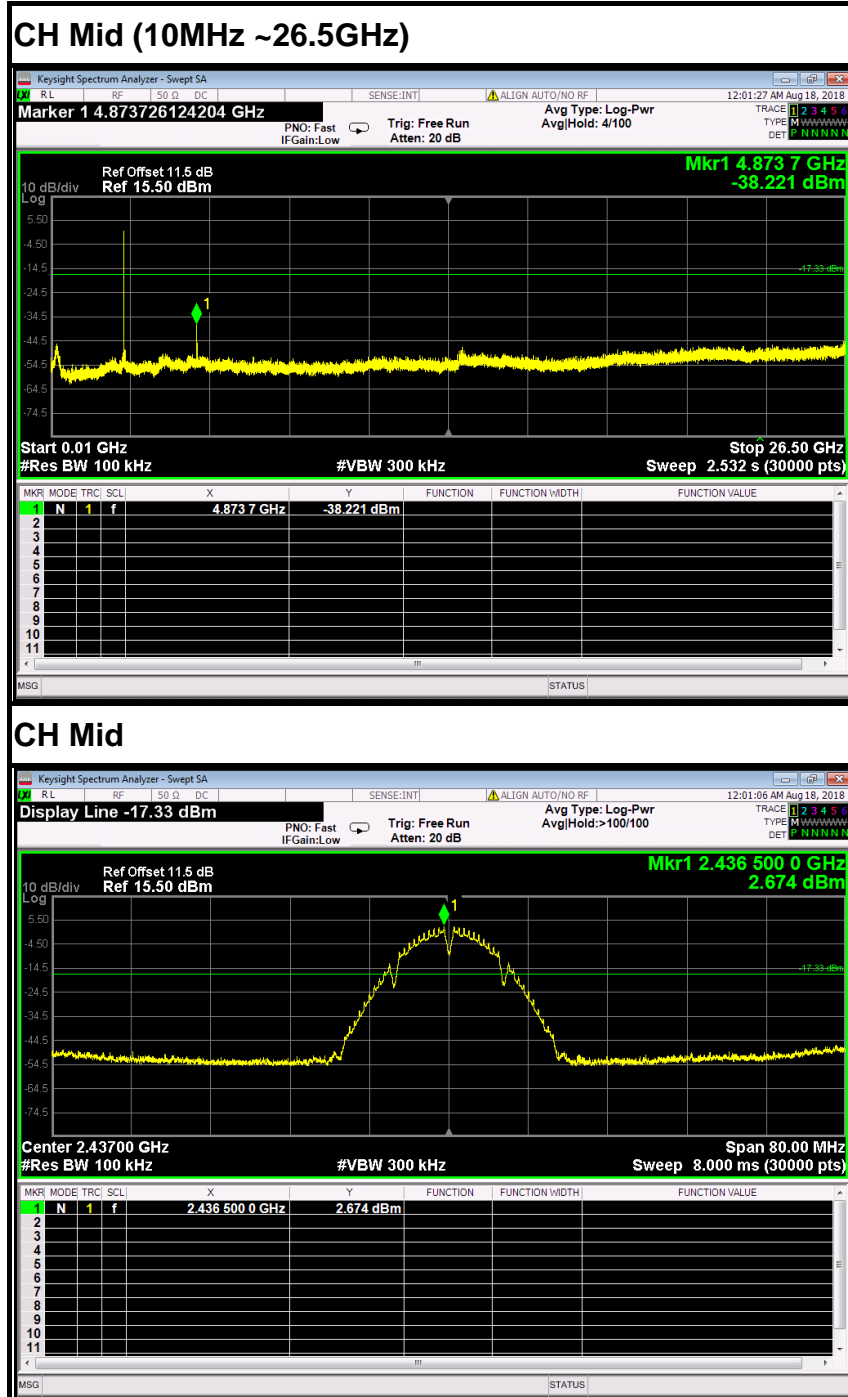

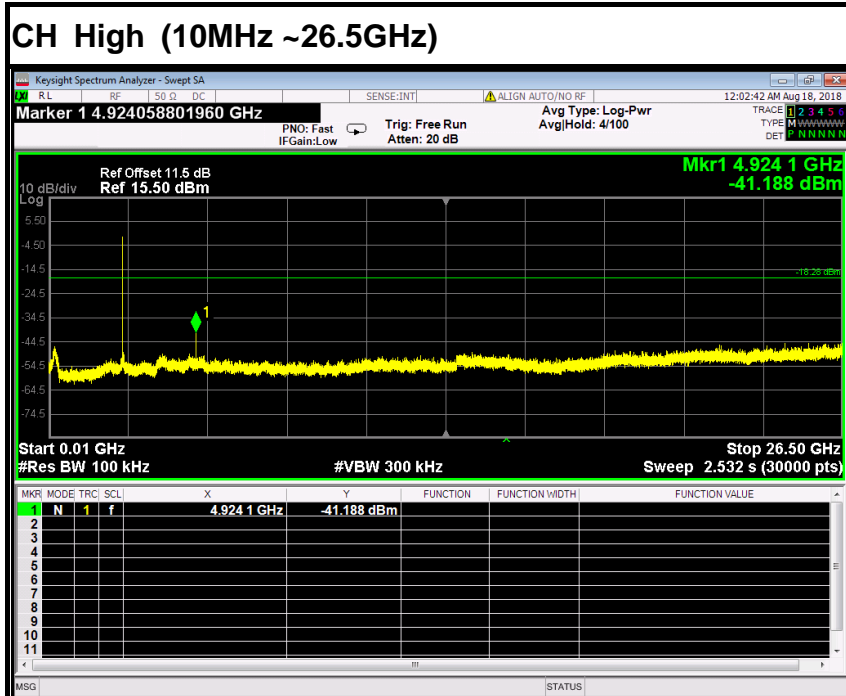



IEEE 802.11g mode (Antenna 0)

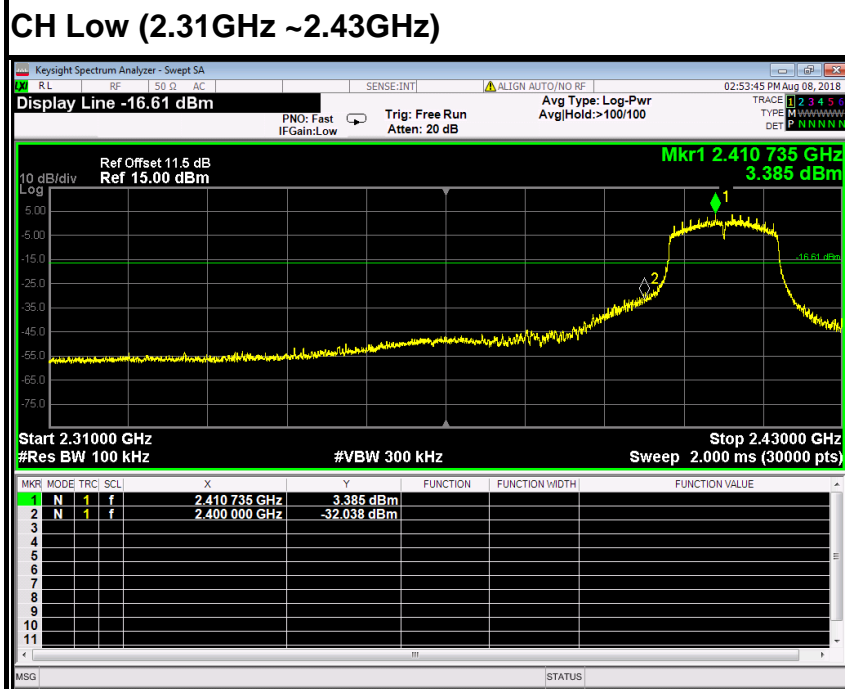
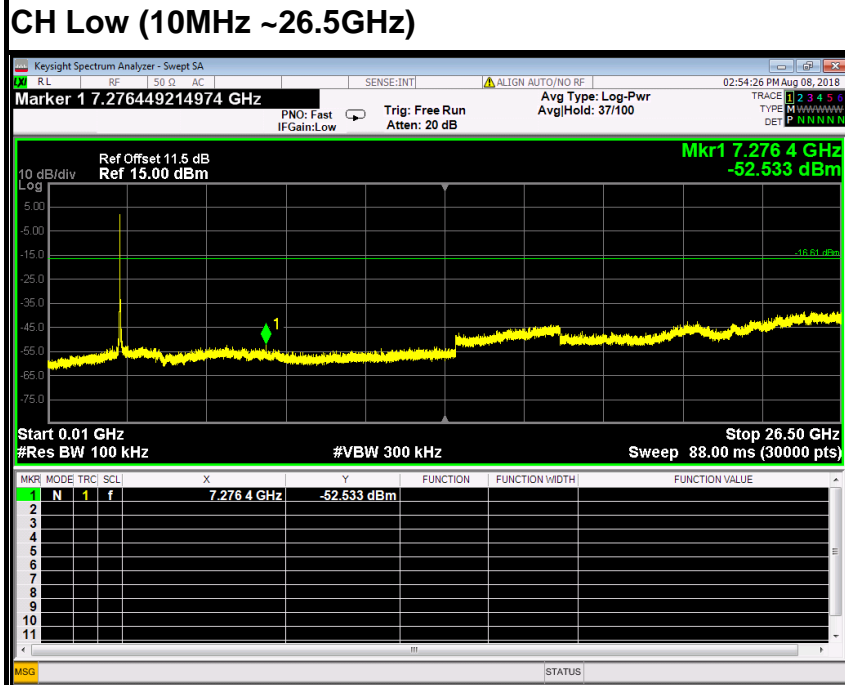

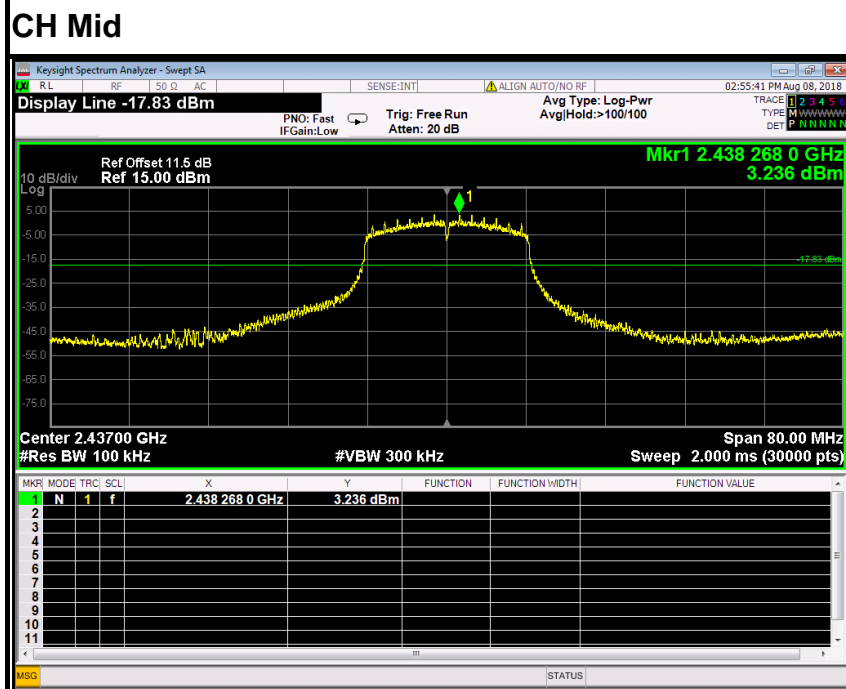
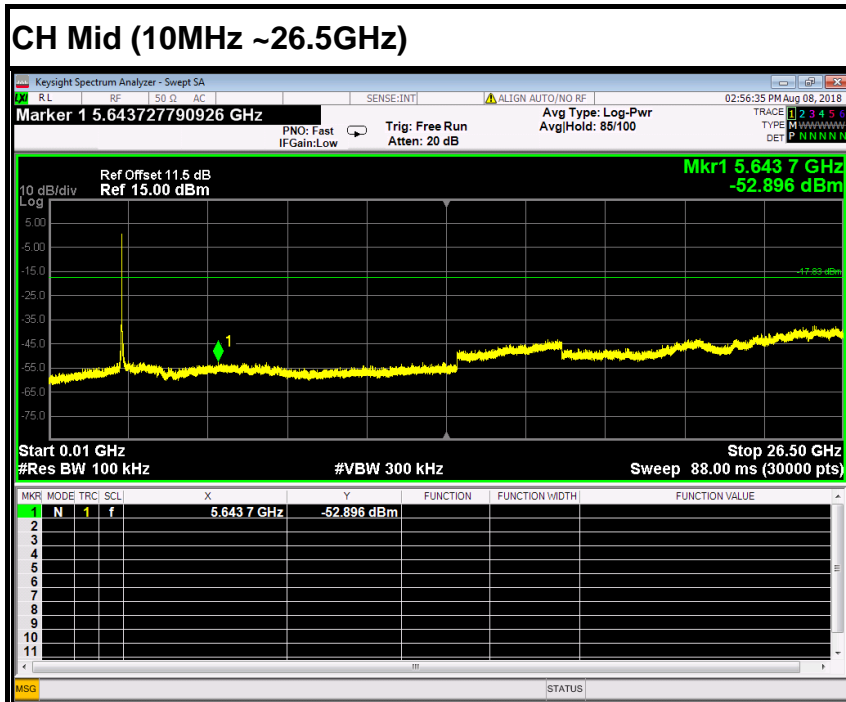

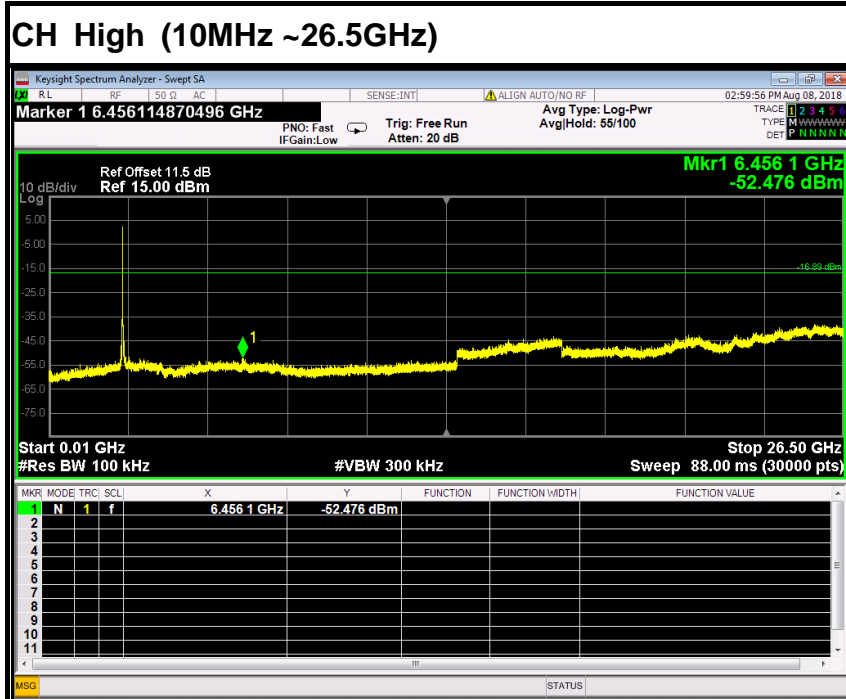



IEEE 802.11g mode (Antenna 1)

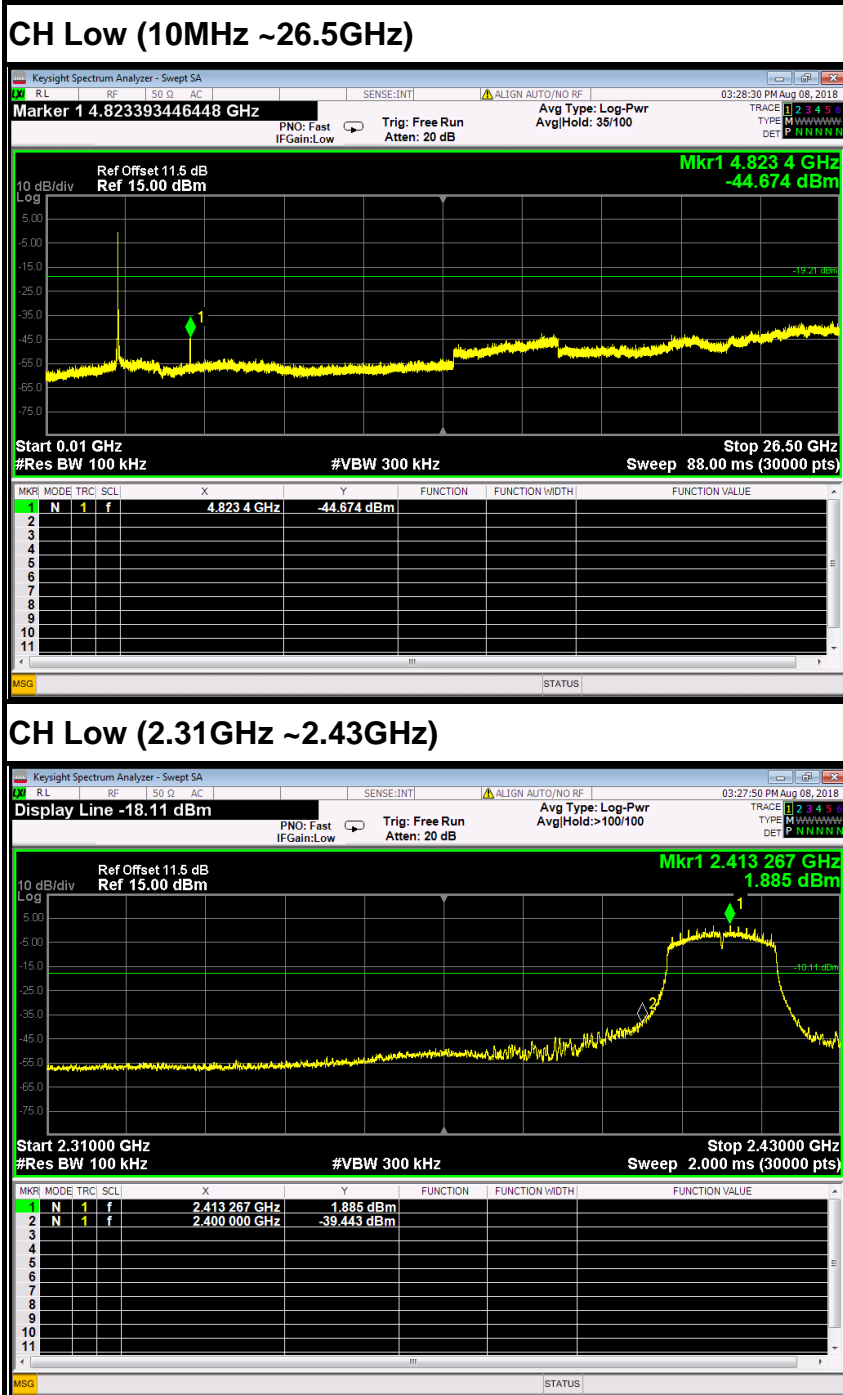

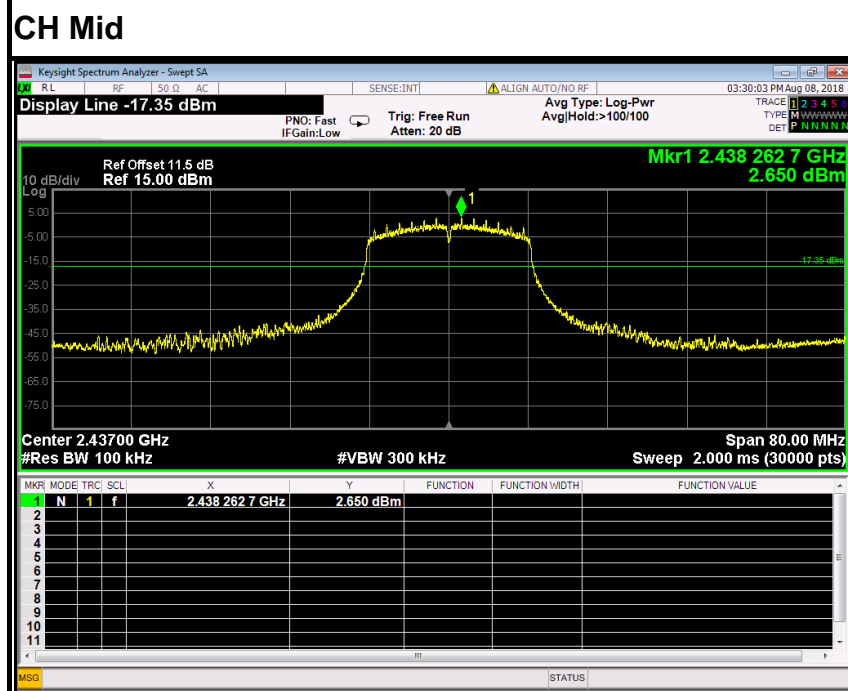
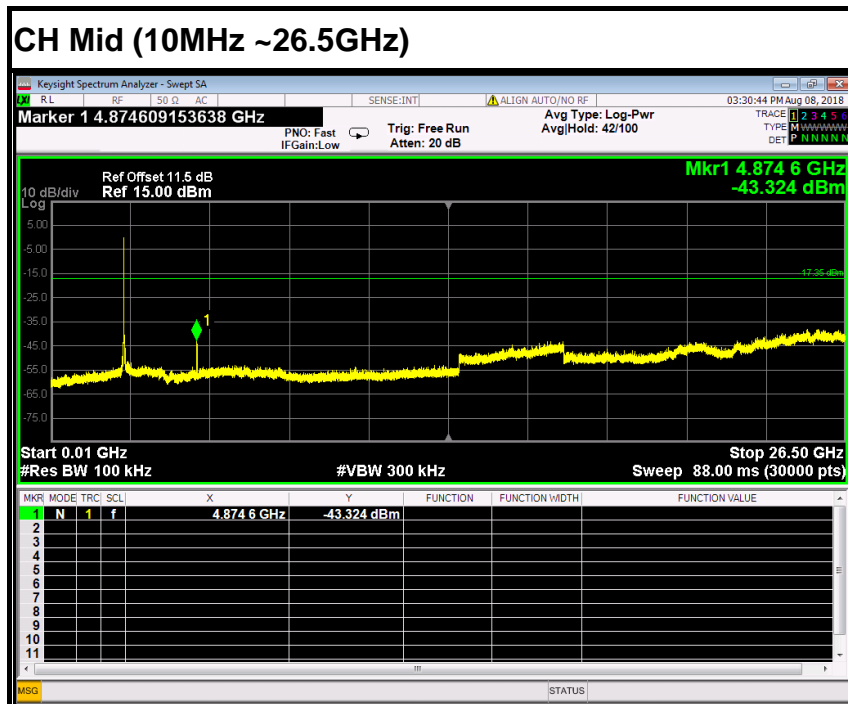

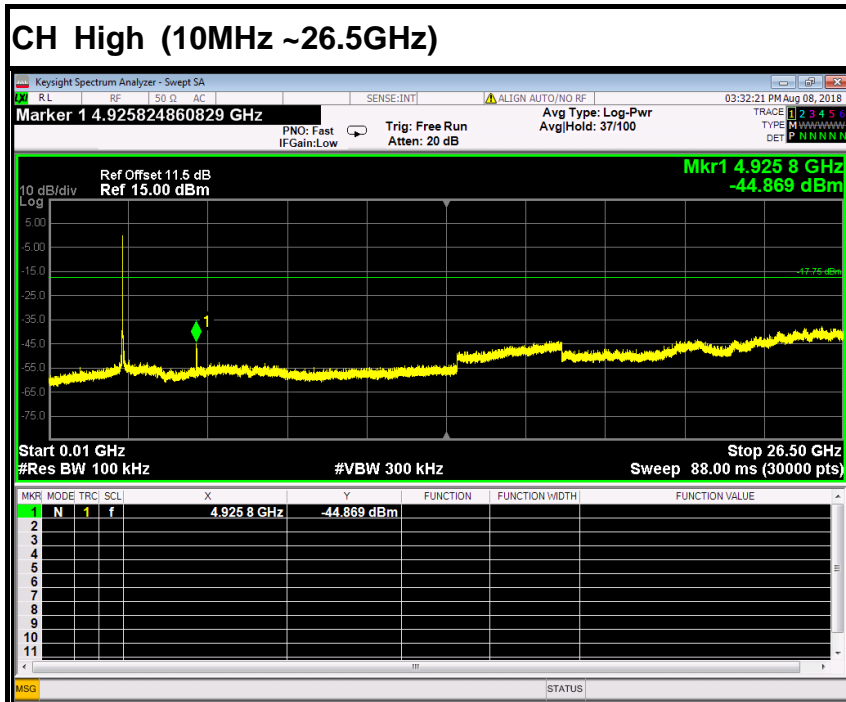



IEEE 802.11n HT20 MHz mode (Antenna 0)

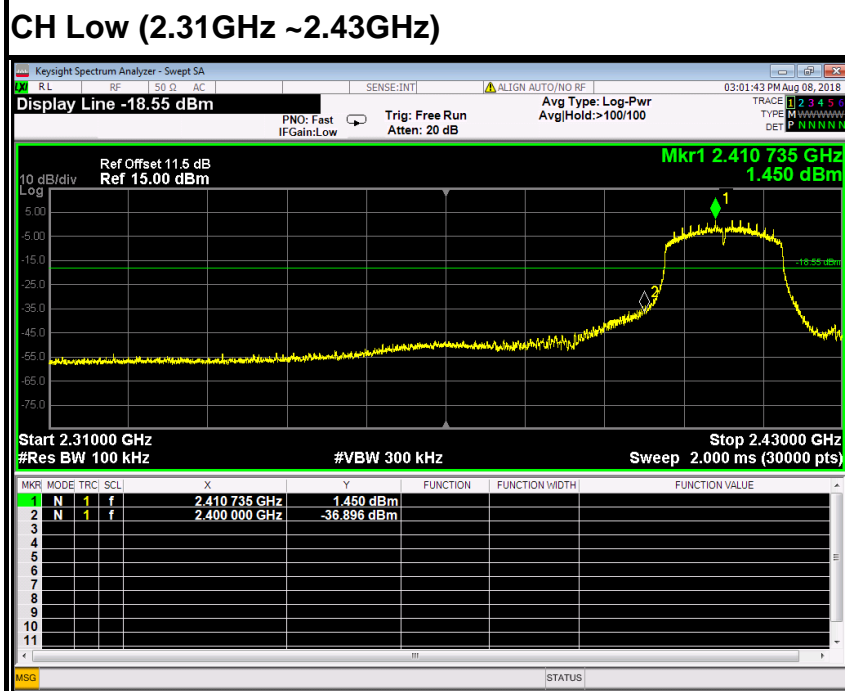
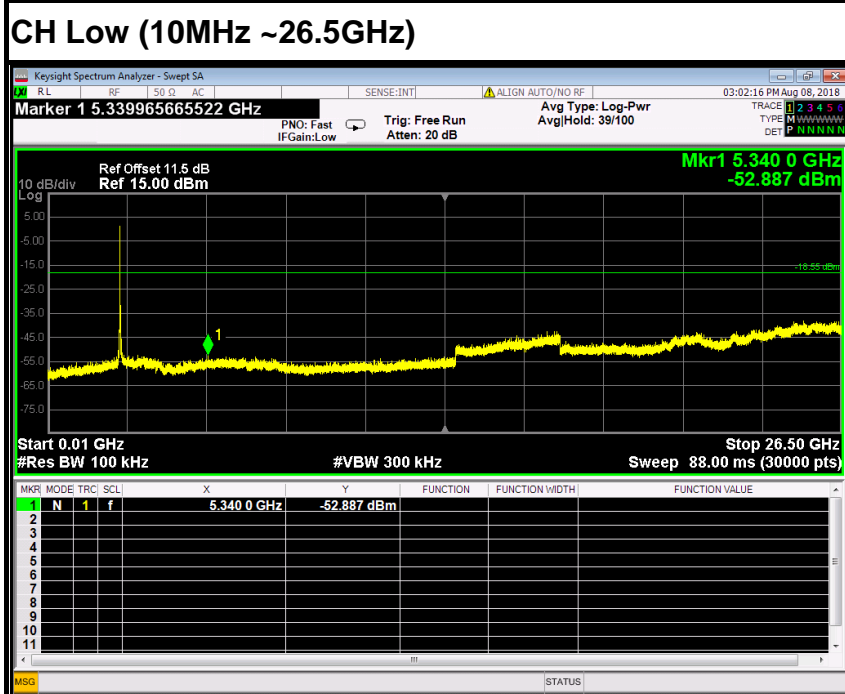

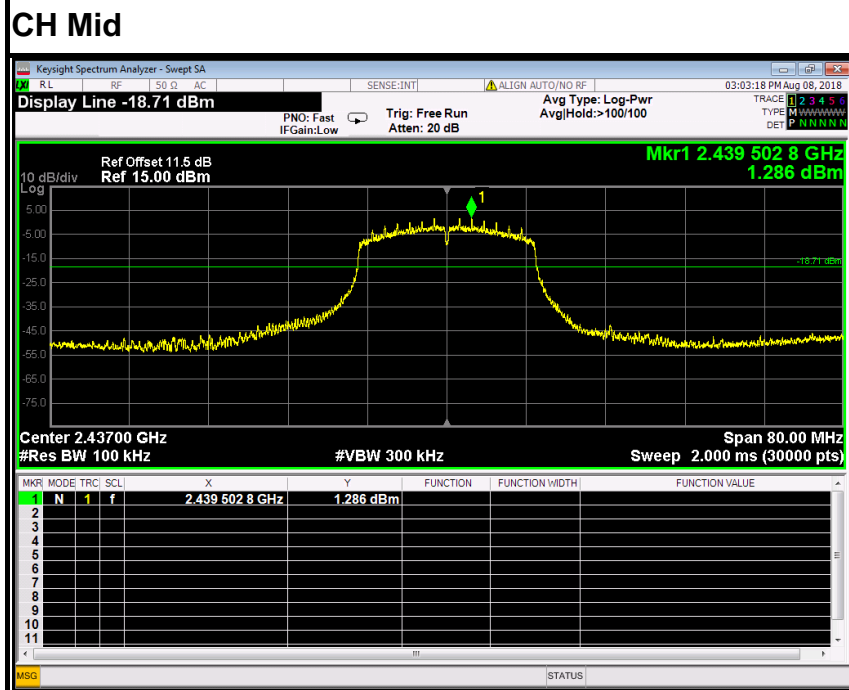
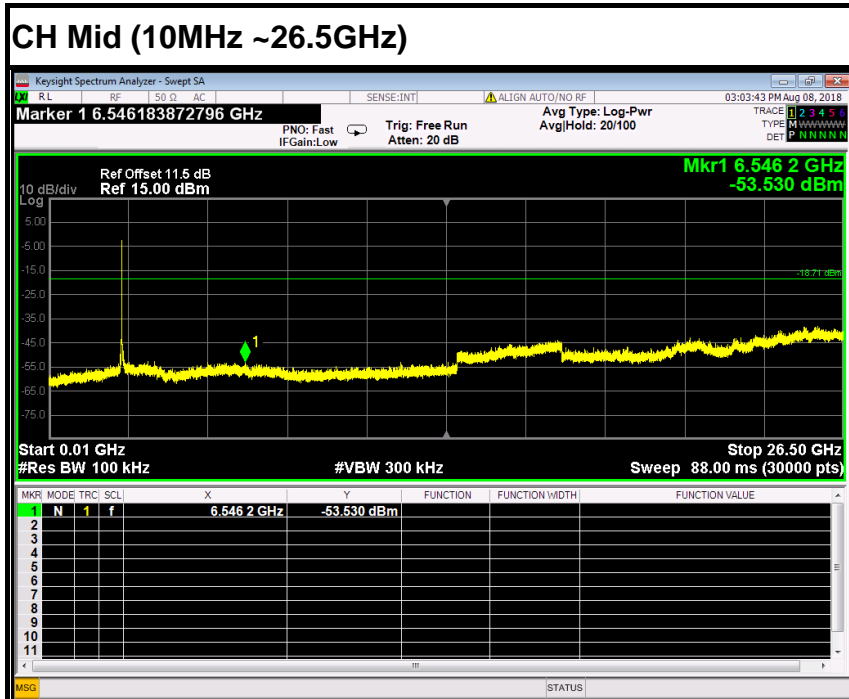

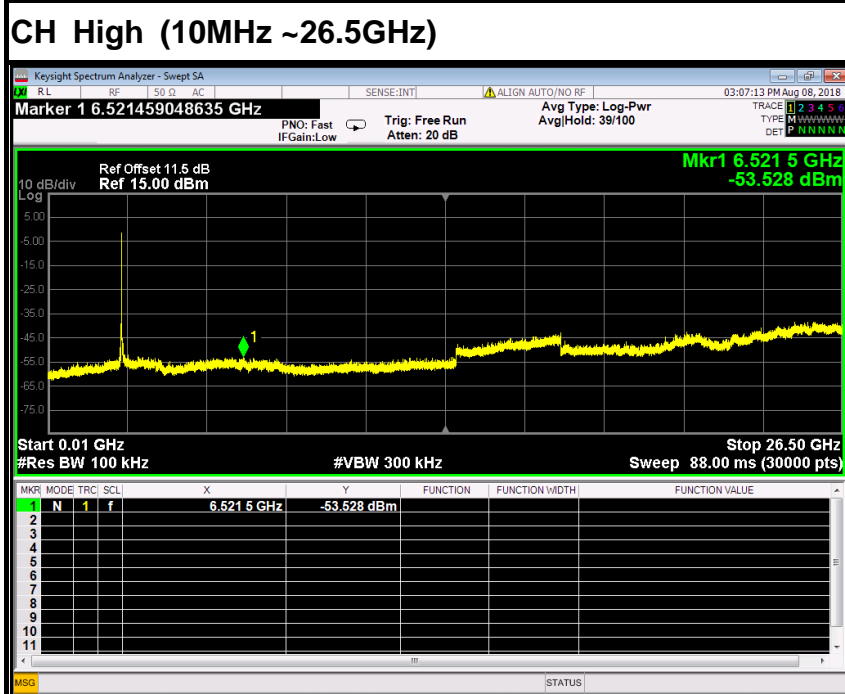



IEEE 802.11n HT20 MHz mode (Antenna 1)

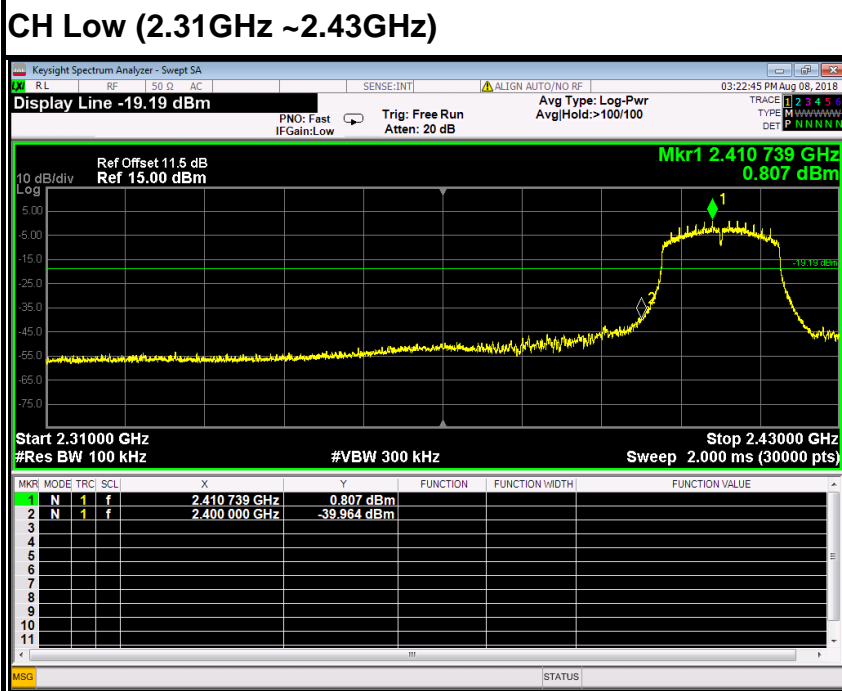
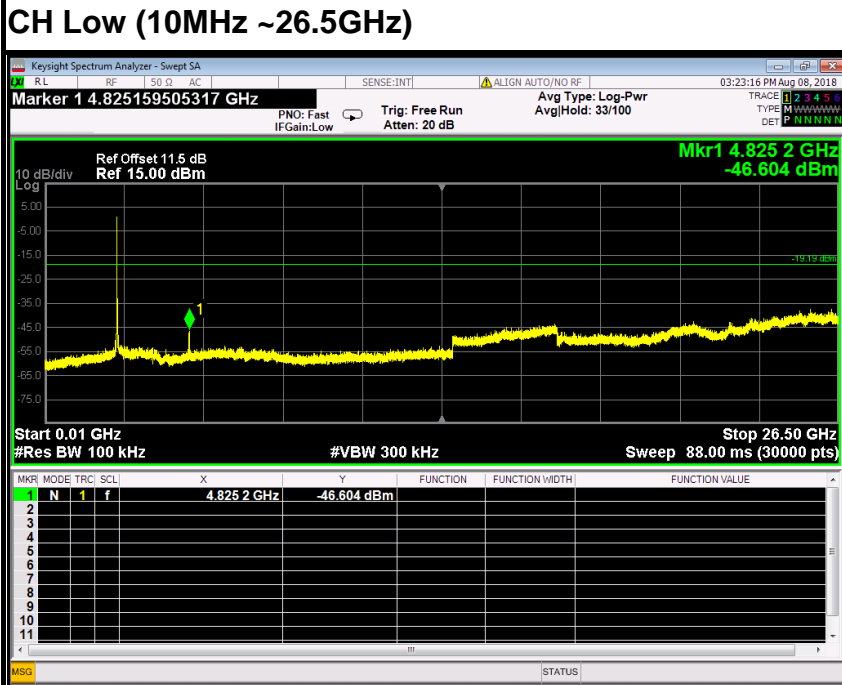

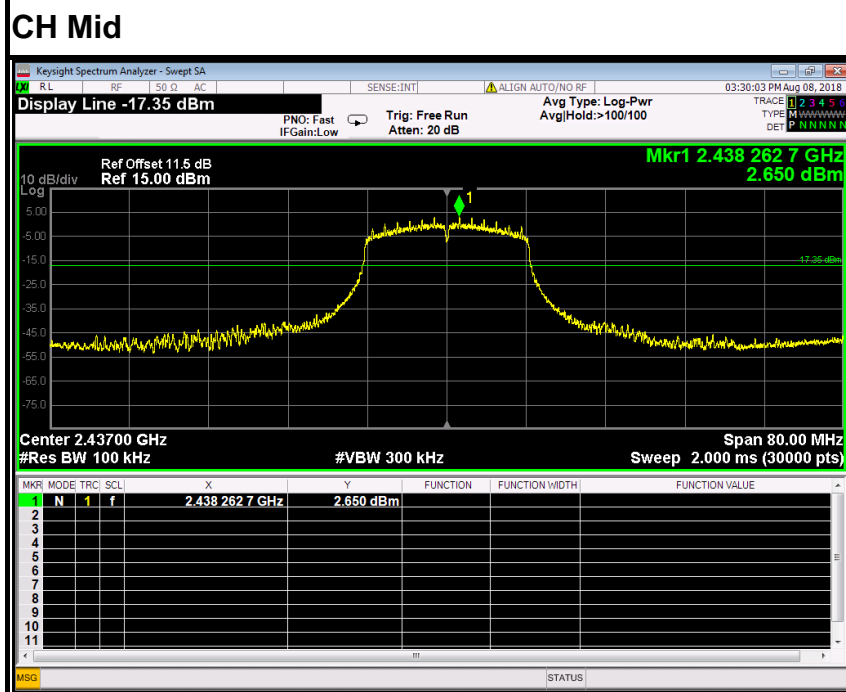
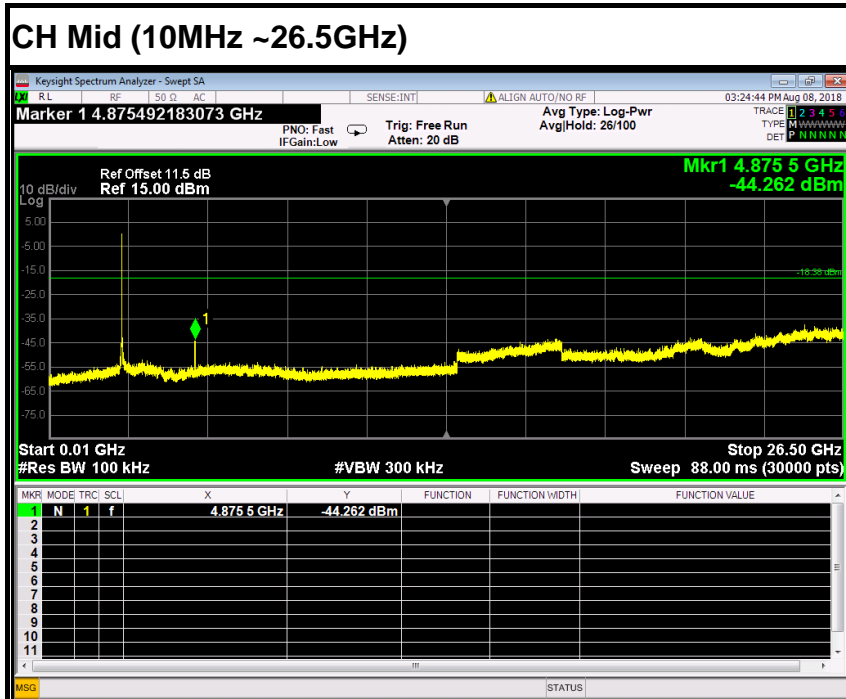

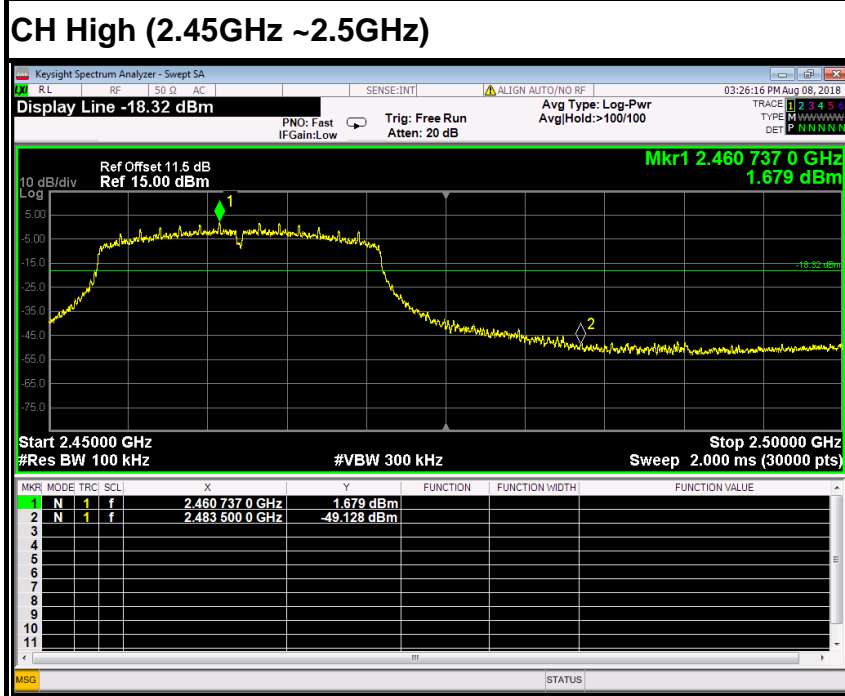
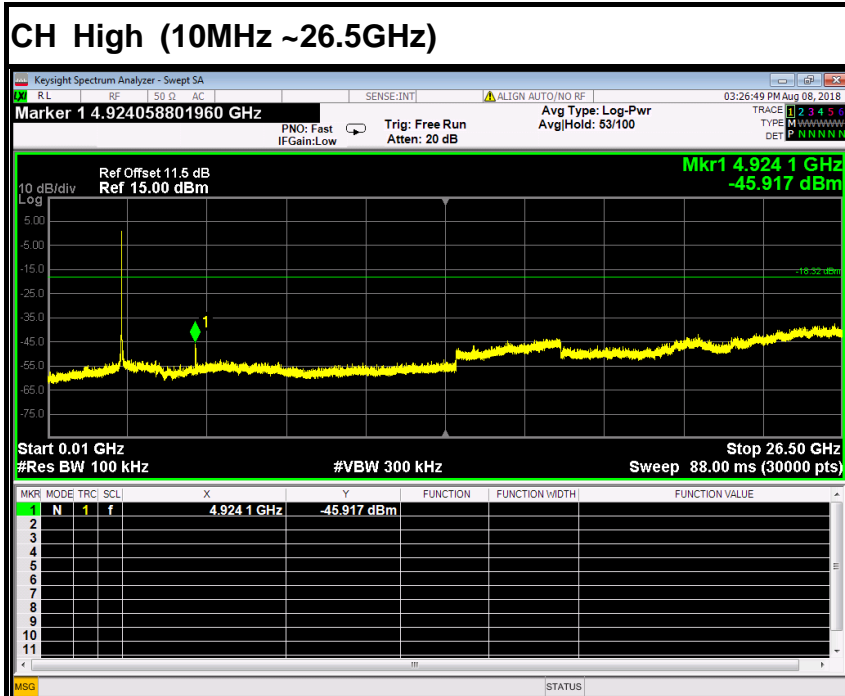



IEEE 802.11n HT40 MHz mode (Antenna 0)

CH Low (10MHz ~26.5GHz)

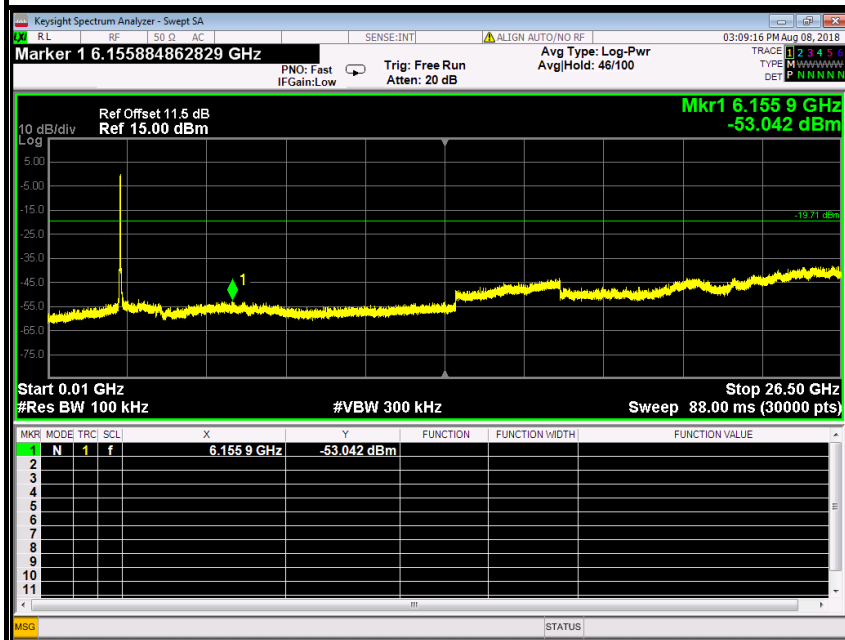

CH Low (2.31GHz ~2.45GHz)

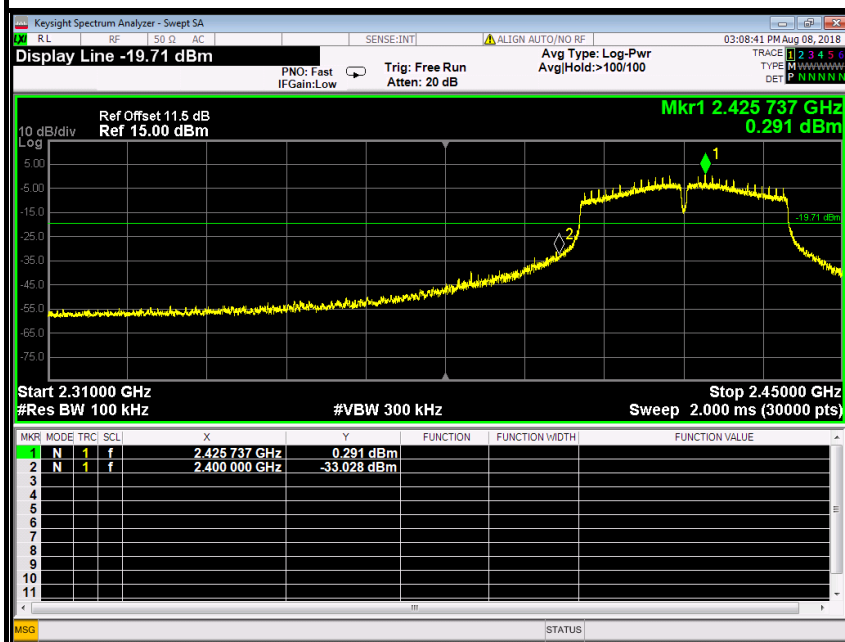

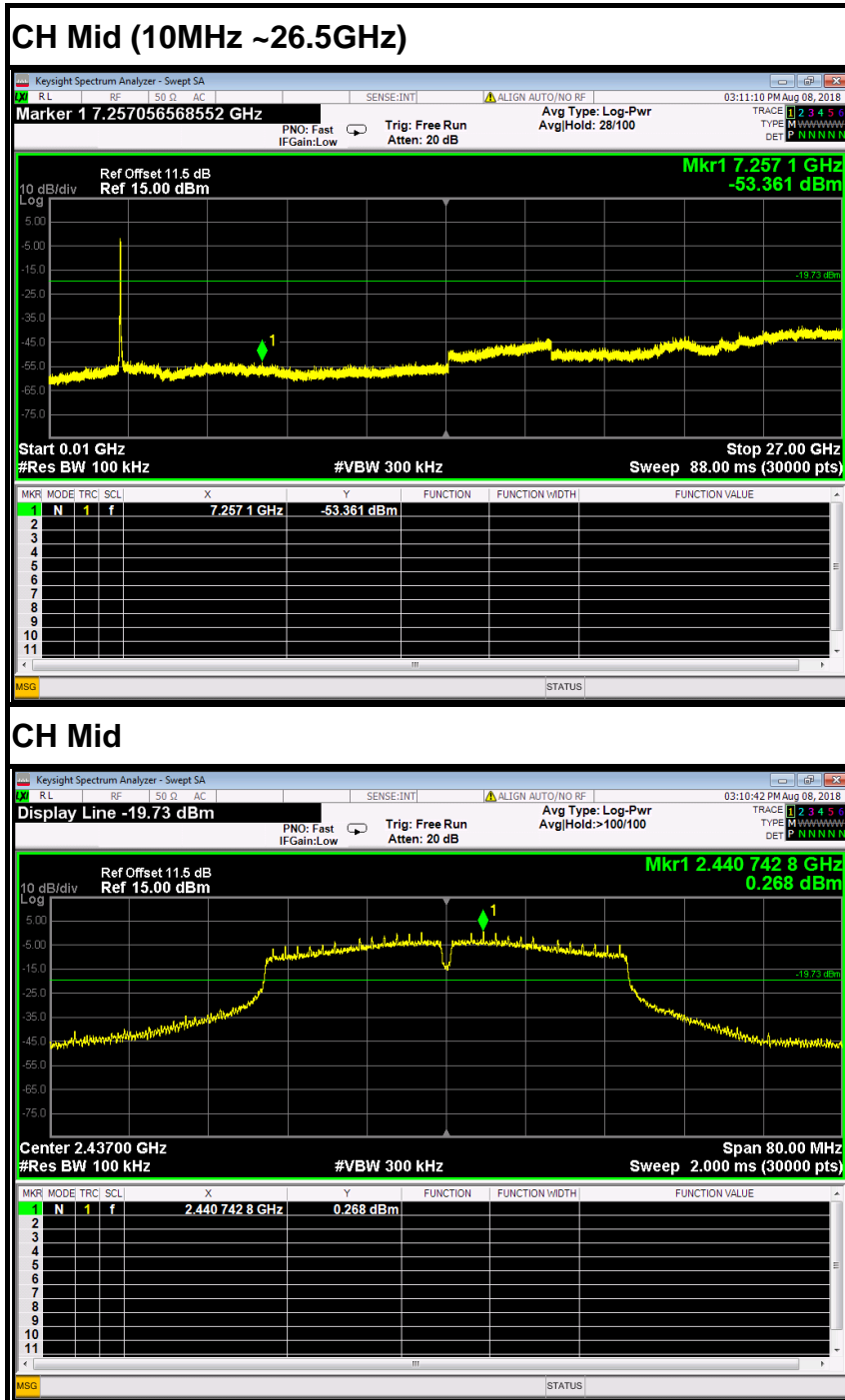

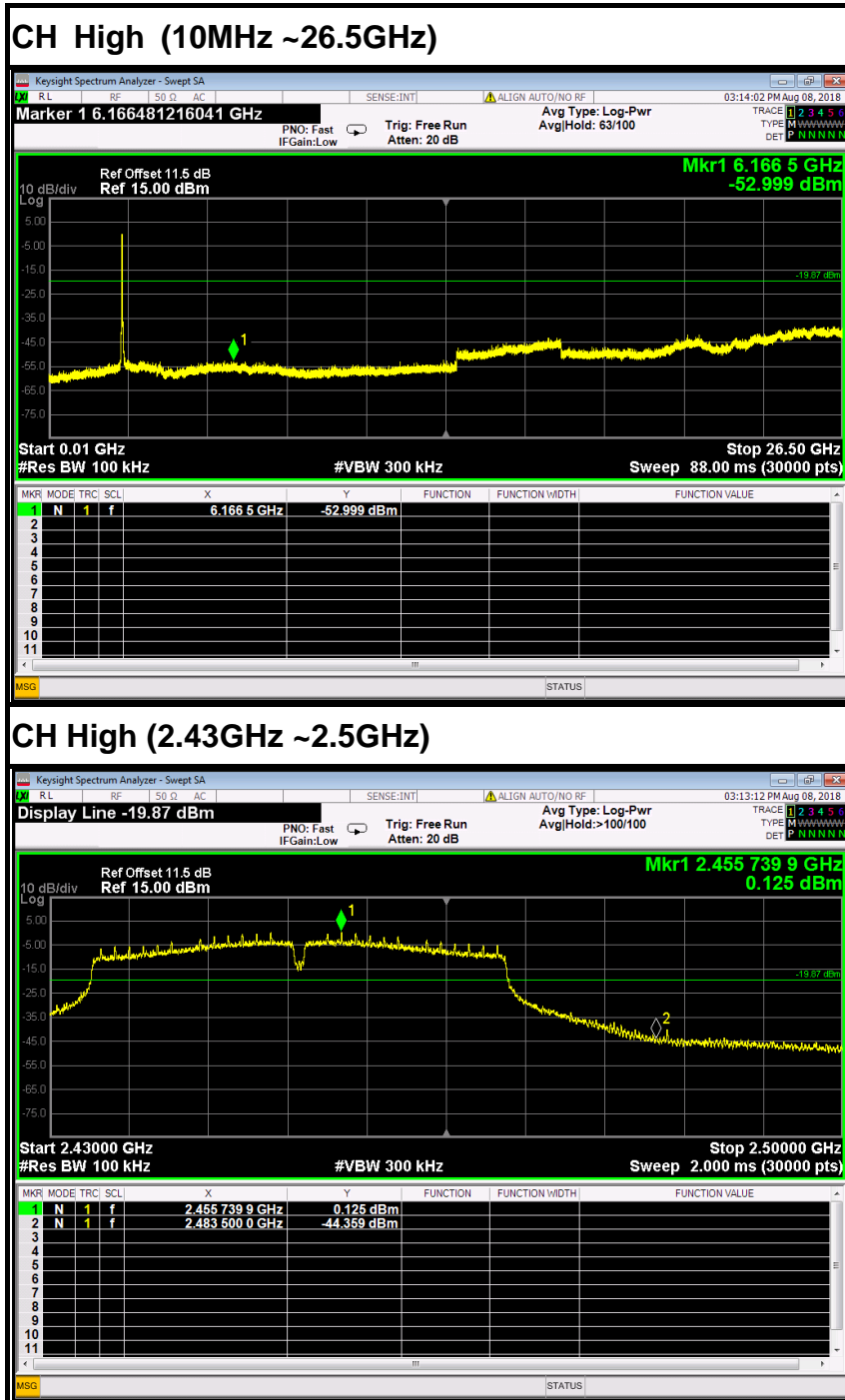



IEEE 802.11n HT40 MHz mode (Antenna 1)

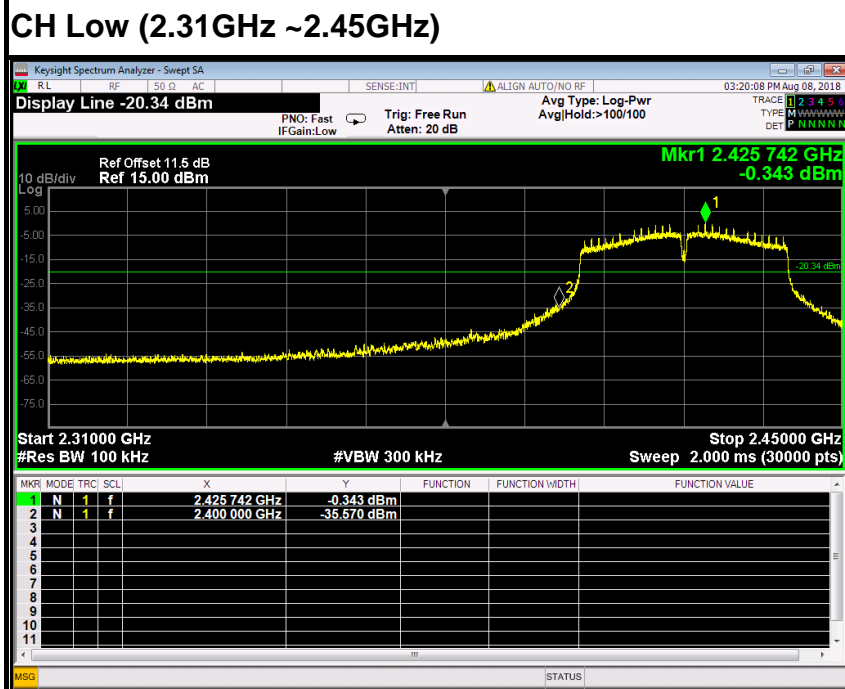
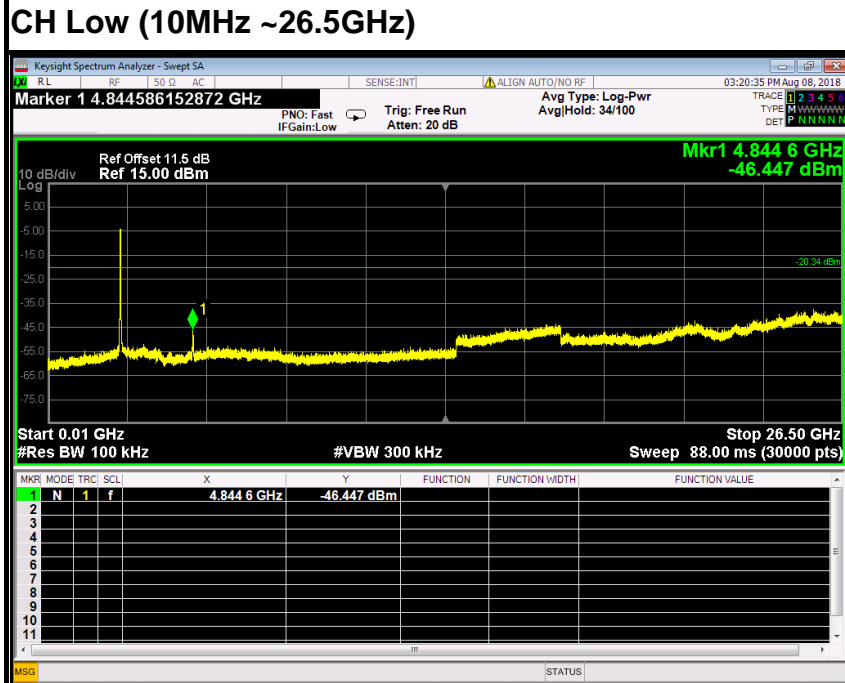

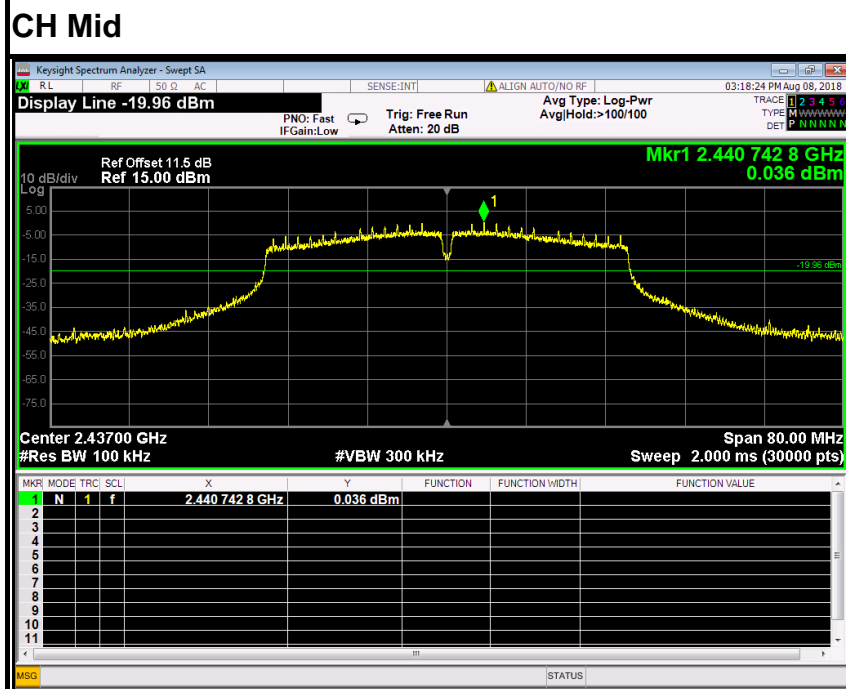
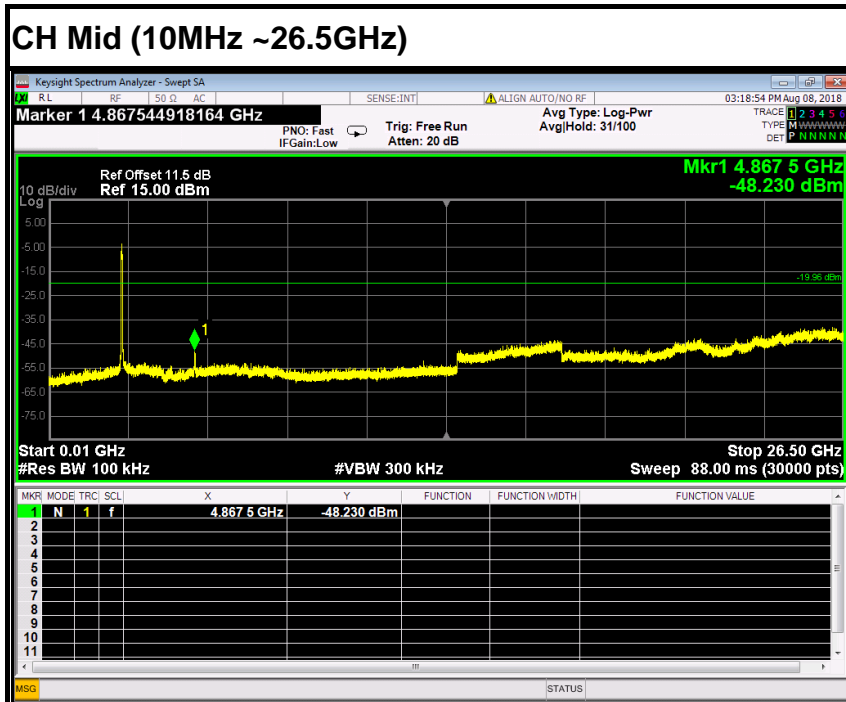

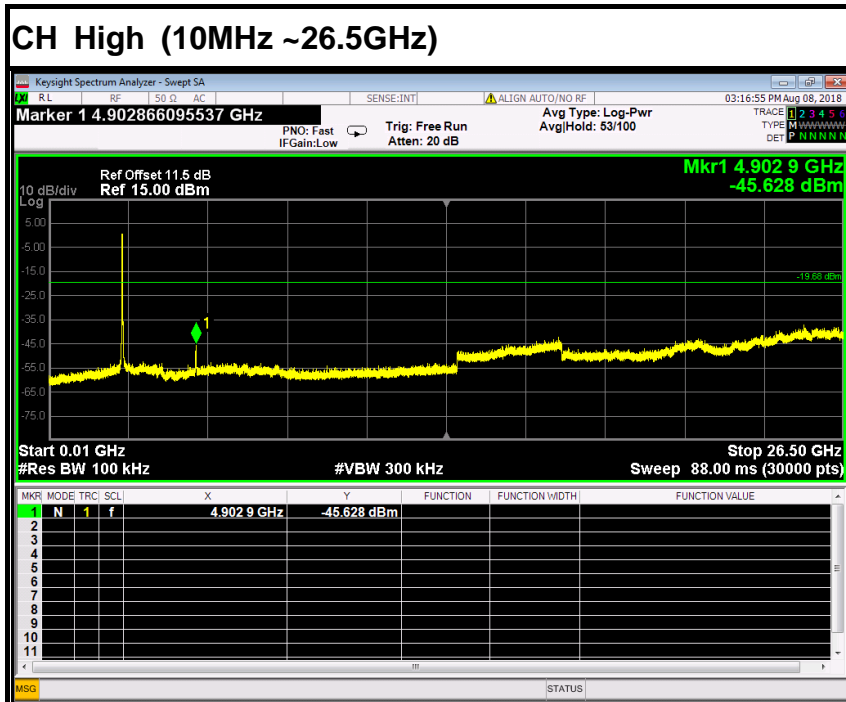

**7.2.2. RADIATED EMISSIONS MEASUREMENT****7.2.2.1. LIMITS OF RADIATED EMISSIONS MEASUREMENT**

According to §15.209(a), except as provided elsewhere in this Subpart, the emissions from an intentional radiator shall not exceed the field strength levels specified in the following table:

Frequency (MHz)	Field Strength (mV/m)	Measurement Distance (m)
0.009-0.490	2400/F(kHz)	300
0.490-1.705	24000/F(kHz)	30
1.705-30.0	30	30
30-88	100*	3
88-216	150*	3
216-960	200*	3
Above 960	500	3

Remark: Except as provided in paragraph (g), fundamental emissions from intentional radiators operating under this Section shall not be located in the frequency bands 54-72 MHz, 76-88 MHz, 174-216 MHz or 470-806 MHz. However, operation within these frequency bands is permitted under other sections of this Part, e.g., Sections 15.231 and 15.241.

1. In the emission table above, the tighter limit applies at the band edges.

Frequency (MHz)	Field Strength ($\mu\text{V}/\text{m}$ at 3-meter)	Field Strength ($\text{dB}\mu\text{V}/\text{m}$ at 3-meter)
30-88	100	40
88-216	150	43.5
216-960	200	46
Above 960	500	54

NOTE: (1) The lower limit shall apply at the transition frequencies.
(2) Emission level ($\text{dB}\mu\text{V}/\text{m}$) = 20 log Emission level ($\mu\text{V}/\text{m}$).



7.2.2.2. Measuring Instruments and Setting

The following table is the setting of spectrum analyzer and receiver.

Spectrum Parameter	Setting
Attenuation	Auto
Start Frequency	1000 MHz
Stop Frequency	10th carrier harmonic
RB / VB (Emission in restricted band)	1MHz / 1MHz for Peak, 1 MHz / 10Hz for Average
RB / VB (Emission in non-restricted band)	1MHz / 1MHz for Peak, 1 MHz / 10Hz for Average

Receiver Parameter	Setting
Attenuation	Auto
Start ~ Stop Frequency	9kHz~150kHz / RB 200Hz for QP/AVG
Start ~ Stop Frequency	150kHz~30MHz / RB 9kHz for QP/AVG
Start ~ Stop Frequency	30MHz~1000MHz / RB 100kHz for QP

7.2.2.3. TEST PROCEDURE (please refer to measurement standard)

1) Sequence of testing 9 kHz to 30 MHz

Setup:

- The equipment was set up to simulate a typical usage like described in the user manual or described by manufacturer.
- If the EUT is a tabletop system, a rotatable table with 0.8 m height is used.
- If the EUT is a floor standing device, it is placed on the ground.
- Auxiliary equipment and cables were positioned to simulate normal operation conditions.
- The AC power port of the EUT (if available) is connected to a power outlet below the turntable.
- The measurement distance is 3 meter.
- The EUT was set into operation.

Pre measurement:

- The turntable rotates from 0° to 315° using 45° steps.
- The antenna height is 0.8 meter.
- At each turntable position the analyzer sweeps with peak detection to find the maximum of all emissions



Final measurement:

--- Identified emissions during the pre measurement the software maximizes by rotating the turntable position (0° to 360°) and by rotating the elevation axes (0° to 360°).

--- The final measurement will be done in the position (turntable and elevation) causing the highest emissions with QPK detector.

--- The final levels, frequency, measuring time, bandwidth, turntable position, correction factor, margin to the limit and limit will be recorded. Also a plot with the graph of the pre measurement and the limit will be stored.

2) Sequence of testing 30 MHz to 1 GHz

Setup:

--- The equipment was set up to simulate a typical usage like described in the user manual or described by manufacturer.

--- If the EUT is a tabletop system, a table with 0.8 m height is used, which is placed on the ground plane.

--- If the EUT is a floor standing device, it is placed on the ground plane with insulation between both.

--- Auxiliary equipment and cables were positioned to simulate normal operation conditions

--- The AC power port of the EUT (if available) is connected to a power outlet below the turntable.

--- The measurement distance is 3 meter.

--- The EUT was set into operation.

Pre measurement:

--- The turntable rotates from 0° to 315° using 45° steps.

--- The antenna is polarized vertical and horizontal.

--- The antenna height changes from 1 to 3 meter.

--- At each turntable position, antenna polarization and height the analyzer sweeps three times in peak to find the maximum of all emissions.



Final measurement:

- The final measurement will be performed with minimum the six highest peaks.
- According to the maximum antenna and turntable positions of premeasurement the software maximize the peaks by changing turntable position ($\pm 45^\circ$) and antenna movement between 1 and 4 meter.
- The final measurement will be done with QP detector with an EMI receiver.
- The final levels, frequency, measuring time, bandwidth, antenna height, antenna polarization, turntable angle, correction factor, margin to the limit and limit will be recorded. Also a plot with the graph of the premeasurement with marked maximum final measurements and the limit will be stored.

3) Sequence of testing 1 GHz to 18 GHz

Setup:

- The equipment was set up to simulate a typical usage like described in the user manual or described by manufacturer.
- If the EUT is a tabletop system, a rotatable table with 1.5 m height is used.
- If the EUT is a floor standing device, it is placed on the ground plane with insulation between both.
- Auxiliary equipment and cables were positioned to simulate normal operation conditions
- The AC power port of the EUT (if available) is connected to a power outlet below the turntable.
- The measurement distance is 3 meter.
- The EUT was set into operation.

Pre measurement:

- The turntable rotates from 0° to 315° using 45° steps.
- The antenna is polarized vertical and horizontal.
- The antenna height scan range is 1 meter to 2.5 meter.
- At each turntable position and antenna polarization the analyzer sweeps with peak detection to find the maximum of all emissions.



Final measurement:

- The final measurement will be performed with minimum the six highest peaks.
- According to the maximum antenna and turntable positions of premeasurement the software maximize the peaks by changing turntable position ($\pm 45^\circ$) and antenna movement between 1 and 4 meter. This procedure is repeated for both antenna polarizations.
- The final measurement will be done in the position (turntable, EUT-table and antenna polarization) causing the highest emissions with Peak and Average detector.
- The final levels, frequency, measuring time, bandwidth, turntable position, EUT-table position, antenna polarization, correction factor, margin to the limit and limit will be recorded. Also a plot with the graph of the pre measurement with marked maximum final measurements and the limit will be stored.

4) Sequence of testing above 18 GHz

Setup:

- The equipment was set up to simulate a typical usage like described in the user manual or described by manufacturer.
- If the EUT is a tabletop system, a rotatable table with 1.5 m height is used.
- If the EUT is a floor standing device, it is placed on the ground plane with insulation between both.
- Auxiliary equipment and cables were positioned to simulate normal operation conditions
- The AC power port of the EUT (if available) is connected to a power outlet below the turntable.
- The measurement distance is 1 meter.
- The EUT was set into operation.

Pre measurement:

- The antenna is moved spherical over the EUT in different polarisations of the antenna.

Final measurement:

- The final measurement will be performed at the position and antenna orientation for all detected emissions that were found during the premeasurements with Peak and Average detector.
- The final levels, frequency, measuring time, bandwidth, correction factor, margin to the limit and limit will be recorded. Also a plot with the graph of the premeasurement and the limit will be stored.



7.2.2.4. TEST SETUP

Below 30MHz

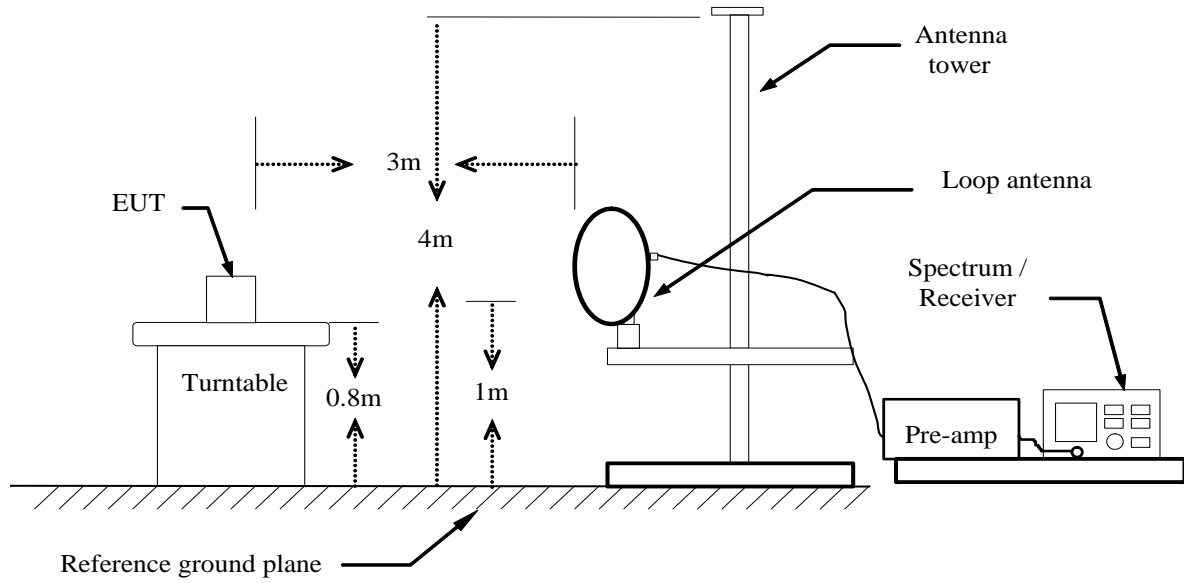

Below 1 GHz

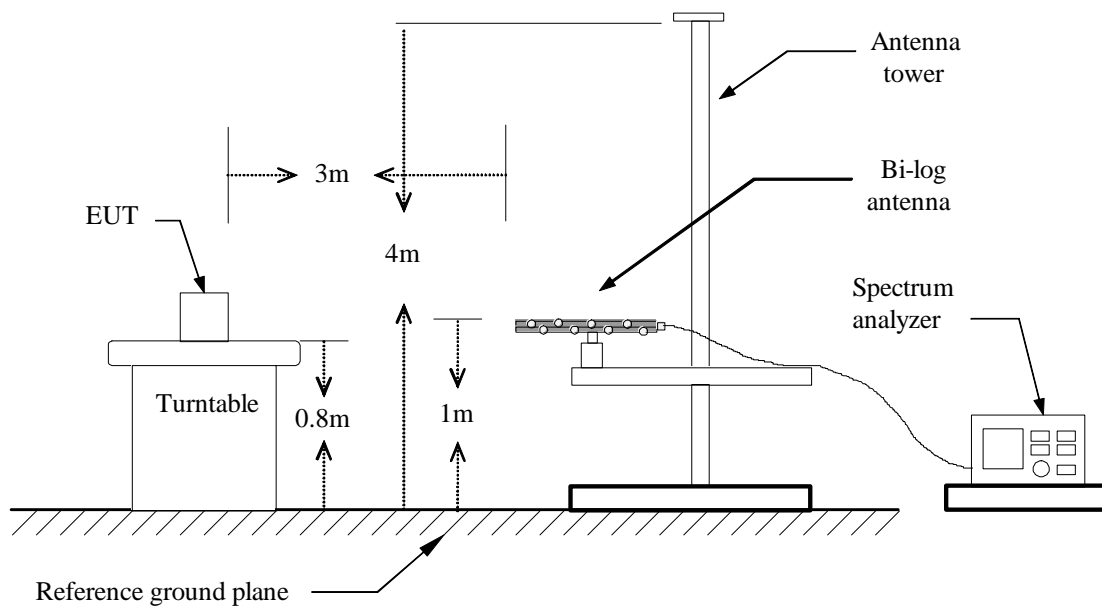



Above 1 GHz

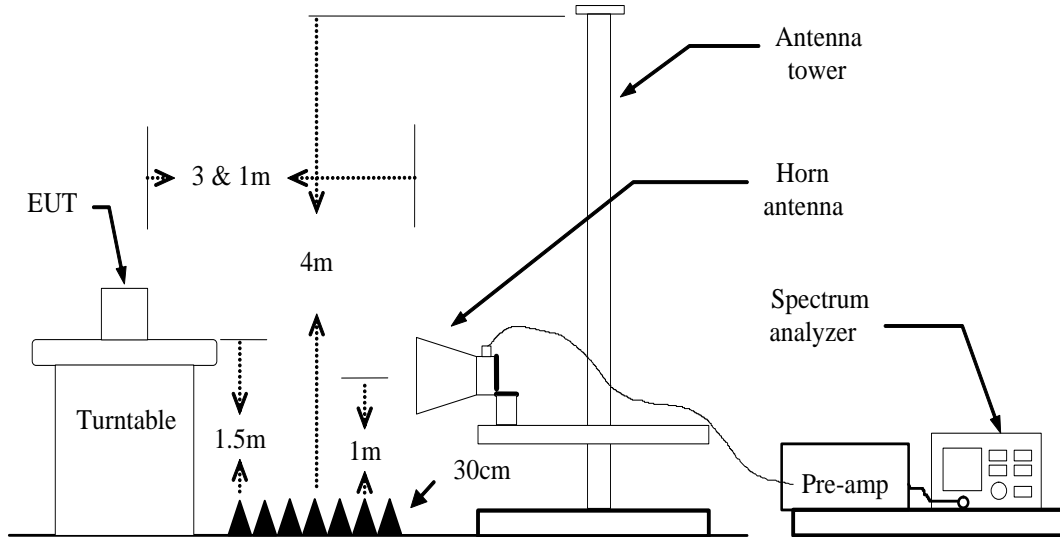

For the actual test configuration, please refer to the related item – Photographs of the Test Configuration.



7.2.2.5. DATA SAPLE

Below 1GHz

Frequency (MHz)	Reading (dBuV)	Correct Factor (dB/m)	Result (dBuV/m)	Limit (dBuV/m)	Margin (dB)	Antenna Pole (V/H)	Remark
XXXX	36.37	-12.20	24.17	40.00	-15.83	V	QP

Frequency (MHz) = Emission frequency in MHz
 Reading (dBuV) = Uncorrected Analyzer / Receiver reading
 Correct Factor (dB/m) = Antenna factor + Cable loss – Amplifier gain
 Result (dBuV/m) = Reading (dBuV) + Corr. Factor (dB/m)
 Limit (dBuV/m) = Limit stated in standard
 Margin (dB) = Result (dBuV/m) – Limit (dBuV/m)
 Q.P. = Quasi-peak Reading

Above 1GHz

Frequency (MHz)	Reading (dBuV)	Correction Factor (dB/m)	Result (dBuV/m)	Limit (dBuV/m)	Margin (dB)	Antenna Pole (V/H)	Remark
XXXX	62.09	-11.42	50.67	74.00	-23.33	V	Peak
XXXX	49.78	-11.42	38.36	54.00	-15.64	V	AVG

Frequency (MHz) = Emission frequency in MHz
 Reading (dBuV) = Uncorrected Analyzer / Receiver reading
 Correction Factor (dB/m) = Antenna factor + Cable loss – Amplifier gain
 Result (dBuV/m) = Reading (dBuV) + Corr. Factor (dB/m)
 Limit (dBuV/m) = Limit stated in standard
 Margin (dB) = Result (dBuV/m) – Limit (dBuV/m)
 Peak = Peak Reading
 AVG = Average Reading

Calculation Formula

Margin (dB) = Result (dBuV/m) – Limits (dBuV/m)
 Result (dBuV/m) = Reading (dBuV) + Correction Factor



7.2.2.6. TEST RESULTS

GL-AR750S

Below 1 GHz

Test Mode: TX / IEEE 802.11b(CH Low)

Tested by: Sam Zeng

Ambient temperature: 24°C

Relative humidity: 52% RH

Date: August 17, 2018

Frequency (MHz)	Reading (dBuV)	Correction Factor (dB/m)	Result (dBuV/m)	Limit (dBuV/m)	Margin (dB)	Antenna Pole (V/H)	Remark
30.9700	46.47	-12.22	34.25	40.00	-5.75	V	QP
125.0600	50.26	-20.94	29.32	43.50	-14.18	V	QP
250.1900	45.77	-21.06	24.71	46.00	-21.29	V	QP
324.8800	41.92	-18.67	23.25	46.00	-22.75	V	QP
624.6100	39.01	-12.73	26.28	46.00	-19.72	V	QP
879.7200	39.64	-9.98	29.66	46.00	-16.34	V	QP
98.8700	55.95	-23.80	32.15	43.50	-11.35	H	QP
125.0600	52.60	-20.94	31.66	43.50	-11.84	H	QP
649.8300	41.03	-12.52	28.51	46.00	-17.49	H	QP
749.7400	40.18	-11.19	28.99	46.00	-17.01	H	QP
874.8700	42.39	-10.14	32.25	46.00	-13.75	H	QP
960.2300	44.92	-8.69	36.23	54.00	-17.77	H	QP

Pre-scan all mode and recorded the worst case results in this report (802.11b (Low Mid))

Remark:

- No emission found between lowest internal used/generated frequency to 30MHz (9kHz~30MHz)
- Radiated emissions measured in frequency range from 9kHz to 1GHz were made with an instrument using Quasi-peak detector mode.
- Data of measurement within this frequency range shown “ --- ” in the table above means the reading of emissions are attenuated more than 20dB below the permissible limits or the field strength is too small to be measured.
- The IF bandwidth of Receiver between 30MHz to 1GHz was 120kHz.
- | | |
|------------------------|--|
| Frequency (MHz) | = Emission frequency in MHz |
| Reading (dBuV/m) | = Receiver reading |
| Correction Factor (dB) | = Antenna factor + Cable loss – Amplifier gain |
| Limit (dBuV/m) | = Limit stated in standard |
| Margin (dB) | = Measured (dBuV/m) – Limits (dBuV/m) |
| Antenna Pole (H/V) | = Current carrying line of reading |



Vertical

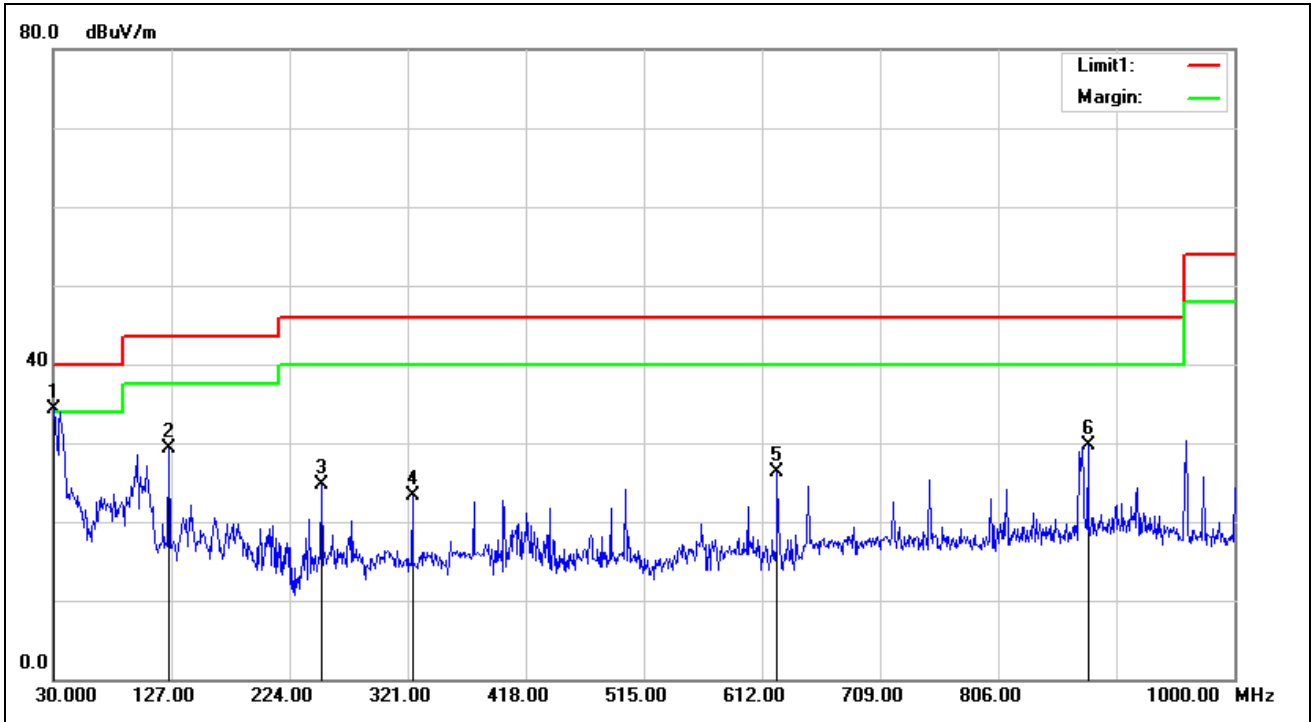

Horizontal

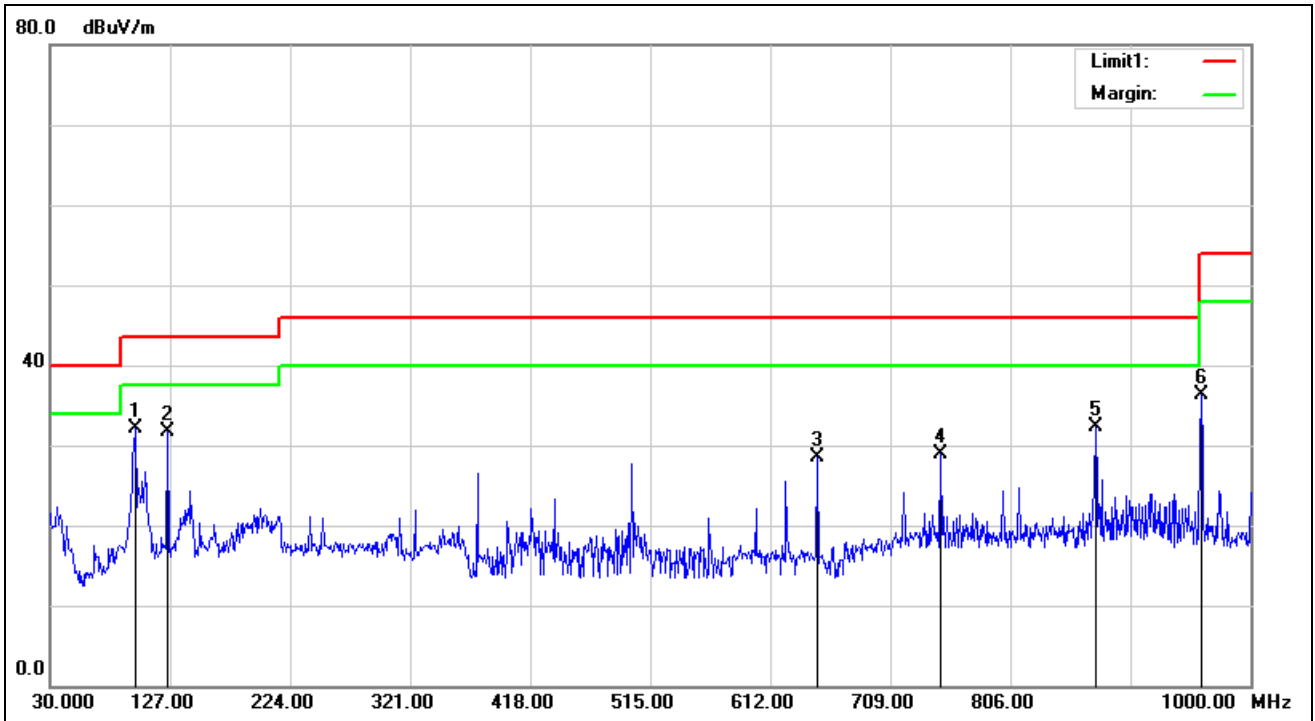

**GL-AR750S-EXT****Below 1 GHz****Test Mode:** TX / IEEE 802.11b(CH Low)**Tested by:** Sam Zeng**Ambient temperature:** 24°C**Relative humidity:** 52% RH**Date:** August 14, 2018

Frequency (MHz)	Reading (dBuV)	Correction Factor (dB/m)	Result (dBuV/m)	Limit (dBuV/m)	Margin (dB)	Antenna Pole (V/H)	Remark
30.9700	47.47	-12.22	35.25	40.00	-4.75	V	QP
125.0600	51.26	-20.94	30.32	43.50	-13.18	V	QP
250.1900	47.77	-21.06	26.71	46.00	-19.29	V	QP
324.8800	43.92	-18.67	25.25	46.00	-20.75	V	QP
500.4500	39.39	-14.35	25.04	46.00	-20.96	V	QP
624.6100	40.01	-12.73	27.28	46.00	-18.72	V	QP
98.8700	56.95	-23.80	33.15	43.50	-10.35	H	QP
125.0600	53.60	-20.94	32.66	43.50	-10.84	H	QP
375.3200	44.27	-16.82	27.45	46.00	-18.55	H	QP
500.4500	42.99	-14.35	28.64	46.00	-17.36	H	QP
874.8700	43.39	-10.14	33.25	46.00	-12.75	H	QP
960.2300	45.92	-8.69	37.23	54.00	-16.77	H	QP

Pre-scan all mode and recorded the worst case results in this report (802.11b (Low Mid))

Remark:

- No emission found between lowest internal used/generated frequency to 30MHz (9kHz~30MHz)
- Radiated emissions measured in frequency range from 9kHz to 1GHz were made with an instrument using Quasi-peak detector mode.
- Data of measurement within this frequency range shown " --- " in the table above means the reading of emissions are attenuated more than 20dB below the permissible limits or the field strength is too small to be measured.
- The IF bandwidth of Receiver between 30MHz to 1GHz was 120kHz.
- | | |
|------------------------|--|
| Frequency (MHz) | = Emission frequency in MHz |
| Reading (dBuV/m) | = Receiver reading |
| Correction Factor (dB) | = Antenna factor + Cable loss – Amplifier gain |
| Limit (dBuV/m) | = Limit stated in standard |
| Margin (dB) | = Measured (dBuV/m) – Limits (dBuV/m) |
| Antenna Pole (H/V) | = Current carrying line of reading |



Vertical

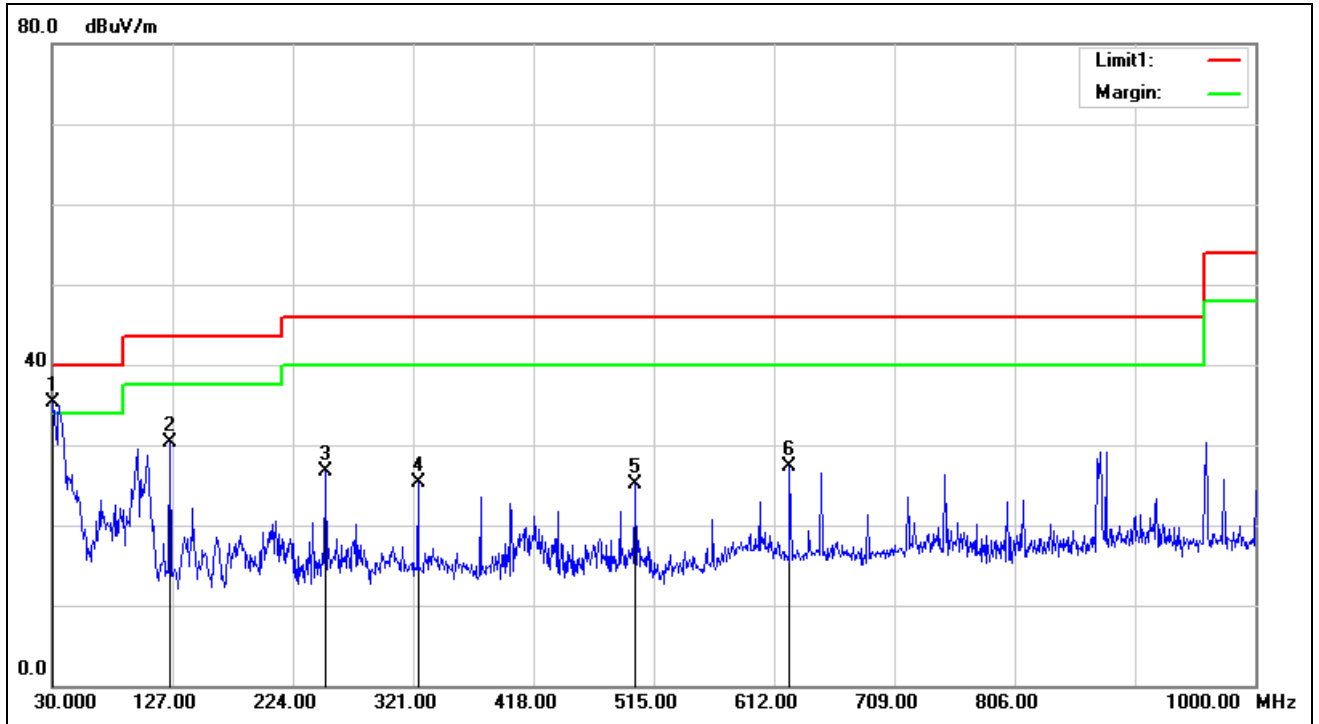

Horizontal

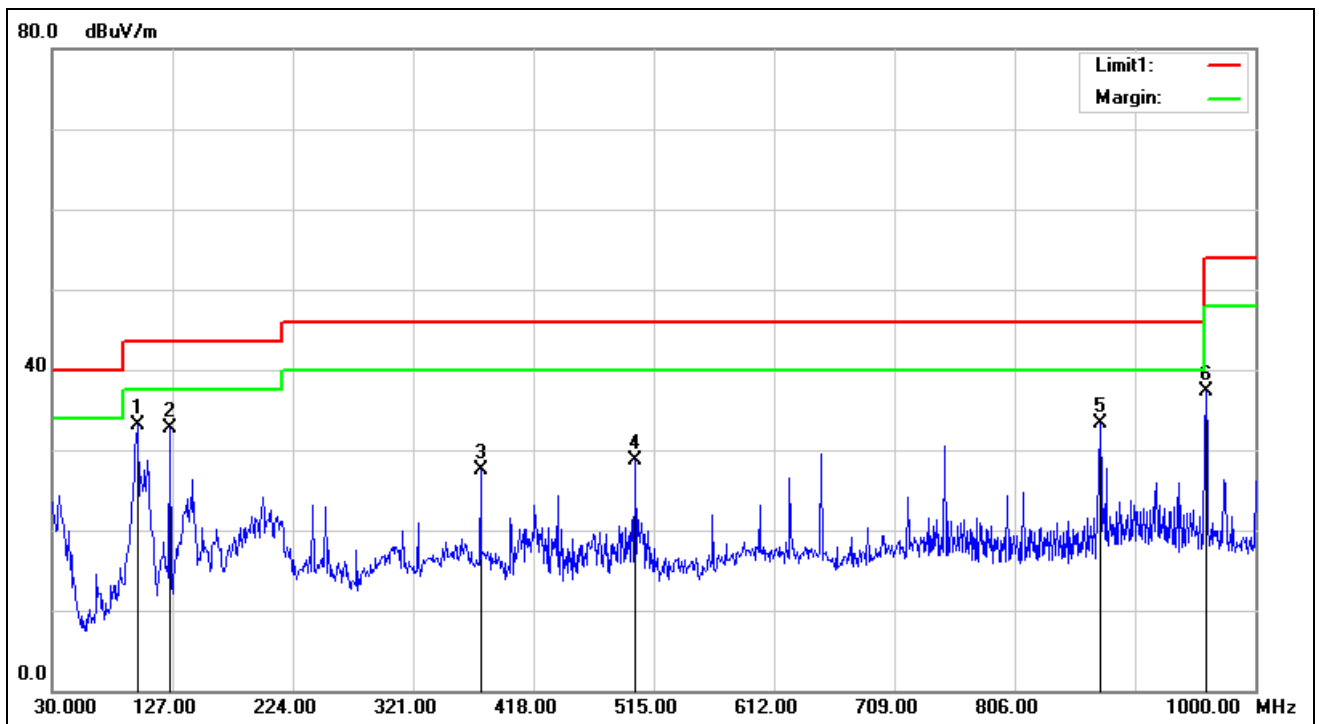

**GL-AR750S****Above 1 GHz****Antenna 0****Test Mode:** TX / IEEE 802.11b(CH Low)**Tested by:** Sam Zeng**Ambient temperature:** 24°C **Relative humidity:** 52% RH**Date:** July 31, 2018

Frequency (MHz)	Reading (dBuV)	Correction Factor (dB/m)	Result (dBuV/m)	Limit (dBuV/m)	Margin (dB)	Antenna Pole (V/H)	Remark
1297.000	50.04	-7.44	42.60	74.00	-31.40	V	peak
3709.000	43.49	0.36	43.85	74.00	-30.15	V	peak
4276.000	42.61	2.56	45.17	74.00	-28.83	V	peak
4825.000	50.72	4.41	55.13	74.00	-18.87	V	peak
4825.000	48.39	4.41	52.80	54.00	-1.20	V	AVG
5617.000	41.28	5.92	47.20	74.00	-26.80	V	peak
6319.000	42.12	6.60	48.72	74.00	-25.28	V	peak
3727.000	42.76	0.44	43.20	74.00	-30.80	H	Peak
4042.000	42.73	1.74	44.47	74.00	-29.53	H	Peak
4825.000	48.41	4.41	52.82	74.00	-21.18	H	Peak
5608.000	41.75	5.92	47.67	74.00	-26.33	H	peak
6535.000	41.42	6.95	48.37	74.00	-25.63	H	peak
6796.000	41.15	7.37	48.52	74.00	-25.48	H	Peak

Remark:

1. Measuring frequencies from 1 GHz to the 10th harmonic of highest fundamental frequency.
2. Radiated emissions measured in frequency above 1000MHz were made with an instrument using peak/average detector mode.
3. Average test would be performed if the peak result were greater than the average limit or as required by the applicant.
4. Data of measurement within this frequency range shown " --- " in the table above means the reading of emissions are attenuated more than 20dB below the permissible limits or the field strength is too small to be measured.
5. Measurements above show only up to 6 maximum emissions noted, or would be lesser, with " N/A " remark, if no specific emissions from the EUT are recorded (ie: margin>20dB from the applicable limit) and considered that's already beyond the background noise floor.
6. Margin (dB) = Remark result (dBuV/m) – Average limit (dBuV/m).



Test Mode: TX / IEEE 802.11b (CH Mid)

Tested by: Sam Zeng

Ambient temperature: 24°C Relative humidity: 52% RH

Date: July 31, 2018

Frequency (MHz)	Reading (dBuV)	Correction Factor (dB/m)	Result (dBuV/m)	Limit (dBuV/m)	Margin (dB)	Antenna Pole (V/H)	Remark
1297.000	49.21	-7.44	41.77	74.00	-32.23	V	Peak
2656.000	44.85	-1.98	42.87	74.00	-31.13	V	Peak
3952.000	43.04	1.39	44.43	74.00	-29.57	V	Peak
4429.000	42.20	3.10	45.30	74.00	-28.70	V	Peak
4870.000	48.08	4.56	52.64	74.00	-21.36	V	Peak
5707.000	41.09	5.96	47.05	74.00	-26.95	V	Peak
2503.000	46.68	-2.25	44.43	74.00	-29.57	H	Peak
4087.000	42.38	1.90	44.28	74.00	-29.72	H	Peak
4762.000	42.94	4.20	47.14	74.00	-26.86	H	Peak
5023.000	42.81	5.02	47.83	74.00	-26.17	H	Peak
5518.000	42.39	5.88	48.27	74.00	-25.73	H	Peak
5815.000	41.93	6.00	47.93	74.00	-26.07	H	Peak

Remark:

1. Measuring frequencies from 1 GHz to the 10th harmonic of highest fundamental frequency.
2. Radiated emissions measured in frequency above 1000MHz were made with an instrument using peak/average detector mode.
3. Average test would be performed if the peak result were greater than the average limit or as required by the applicant.
4. Data of measurement within this frequency range shown " --- " in the table above means the reading of emissions are attenuated more than 20dB below the permissible limits or the field strength is too small to be measured.
5. Measurements above show only up to 6 maximum emissions noted, or would be lesser, with " N/A " remark, if no specific emissions from the EUT are recorded (ie: margin>20dB from the applicable limit) and considered that's already beyond the background noise floor.
6. Margin (dB) = Remark result (dBuV/m) – Average limit (dBuV/m).



Test Mode: TX / IEEE 802.11b (CH High)

Tested by: Sam Zeng

Ambient temperature: 24°C Relative humidity: 52% RH

Date: July 31, 2018

Frequency (MHz)	Reading (dBuV)	Correction Factor (dB/m)	Result (dBuV/m)	Limit (dBuV/m)	Margin (dB)	Antenna Pole (V/H)	Remark
2539.000	47.51	-2.19	45.32	74.00	-28.68	V	Peak
3835.000	43.61	0.89	44.50	74.00	-29.50	V	Peak
4312.000	42.31	2.69	45.00	74.00	-29.00	V	Peak
4924.000	47.90	4.73	52.63	74.00	-21.37	V	Peak
5905.000	41.55	6.04	47.59	74.00	-26.41	V	Peak
6724.000	41.41	7.25	48.66	74.00	-25.34	V	Peak
1918.000	51.38	-5.52	45.86	74.00	-28.14	H	Peak
3061.000	44.25	-1.26	42.99	74.00	-31.01	H	Peak
3754.000	43.99	0.55	44.54	74.00	-29.46	H	Peak
4924.000	51.04	4.73	55.77	74.00	-18.23	H	Peak
4924.000	48.25	4.73	52.98	54.00	-1.02	H	AVG
6220.000	41.43	6.44	47.87	74.00	-26.13	H	Peak
7129.000	41.45	7.95	49.40	74.00	-24.60	H	Peak

Remark:

1. Measuring frequencies from 1 GHz to the 10th harmonic of highest fundamental frequency.
2. Radiated emissions measured in frequency above 1000MHz were made with an instrument using peak/average detector mode.
3. Average test would be performed if the peak result were greater than the average limit or as required by the applicant.
4. Data of measurement within this frequency range shown " --- " in the table above means the reading of emissions are attenuated more than 20dB below the permissible limits or the field strength is too small to be measured.
5. Measurements above show only up to 6 maximum emissions noted, or would be lesser, with " N/A " remark, if no specific emissions from the EUT are recorded (ie: margin>20dB from the applicable limit) and considered that's already beyond the background noise floor.
6. Margin (dB) = Remark result (dBuV/m) – Average limit (dBuV/m).

**Antenna 1****Test Mode:** TX / IEEE 802.11b(CH Low)**Tested by:** Sam Zeng**Ambient temperature:** 24°C **Relative humidity:** 52% RH**Date:** July 31, 2018

Frequency (MHz)	Reading (dBuV)	Correction Factor (dB/m)	Result (dBuV/m)	Limit (dBuV/m)	Margin (dB)	Antenna Pole (V/H)	Remark
2548.000	46.26	-2.17	44.09	74.00	-29.91	V	peak
3763.000	44.76	0.59	45.35	74.00	-28.65	V	peak
4636.000	42.79	3.79	46.58	74.00	-27.42	V	peak
4825.000	50.76	4.41	55.17	74.00	-18.83	V	peak
4825.000	46.85	4.41	51.26	54.00	-2.74	V	AVG
4996.000	48.66	4.97	53.63	74.00	-20.37	V	peak
4996.000	44.58	4.97	49.55	54.00	-4.45	V	AVG
6004.000	41.37	6.09	47.46	74.00	-26.54	V	peak
3358.000	44.17	-0.76	43.41	74.00	-30.59	H	Peak
4159.000	42.25	2.15	44.40	74.00	-29.60	H	Peak
4825.000	51.07	4.41	55.48	74.00	-18.52	H	Peak
4825.000	46.92	4.41	51.33	54.00	-2.67	H	AVG
4996.000	46.26	4.97	51.23	74.00	-22.77	H	peak
5752.000	41.57	5.98	47.55	74.00	-26.45	H	peak
6490.000	41.03	6.87	47.90	74.00	-26.10	H	peak

Remark:

1. Measuring frequencies from 1 GHz to the 10th harmonic of highest fundamental frequency.
2. Radiated emissions measured in frequency above 1000MHz were made with an instrument using peak/average detector mode.
3. Average test would be performed if the peak result were greater than the average limit or as required by the applicant.
4. Data of measurement within this frequency range shown " --- " in the table above means the reading of emissions are attenuated more than 20dB below the permissible limits or the field strength is too small to be measured.
5. Measurements above show only up to 6 maximum emissions noted, or would be lesser, with " N/A " remark, if no specific emissions from the EUT are recorded (ie: margin>20dB from the applicable limit) and considered that's already beyond the background noise floor.
6. Margin (dB) = Remark result (dBuV/m) – Average limit (dBuV/m).



Test Mode: TX / IEEE 802.11b (CH Mid)

Tested by: Sam Zeng

Ambient temperature: 24°C Relative humidity: 52% RH

Date: July 31, 2018

Frequency (MHz)	Reading (dBuV)	Correction Factor (dB/m)	Result (dBuV/m)	Limit (dBuV/m)	Margin (dB)	Antenna Pole (V/H)	Remark
2548.000	45.85	-2.17	43.68	74.00	-30.32	V	Peak
3043.000	44.81	-1.29	43.52	74.00	-30.48	V	Peak
4330.000	43.27	2.75	46.02	74.00	-27.98	V	Peak
4996.000	49.74	4.97	54.71	74.00	-19.29	V	Peak
4996.000	47.47	4.97	52.44	54.00	-1.56	V	AVG
5671.000	42.23	5.94	48.17	74.00	-25.83	V	Peak
6400.000	41.62	6.73	48.35	74.00	-25.65	V	Peak
1918.000	48.61	-5.52	43.09	74.00	-30.91	H	Peak
3349.000	44.15	-0.77	43.38	74.00	-30.62	H	Peak
4312.000	42.69	2.69	45.38	74.00	-28.62	H	Peak
4879.000	50.14	4.59	54.73	74.00	-19.27	H	Peak
4879.000	48.07	4.59	52.66	54.00	-1.34	H	AVG
5734.000	41.16	5.97	47.13	74.00	-26.87	H	Peak
6508.000	41.81	6.90	48.71	74.00	-25.29	H	Peak

Remark:

1. Measuring frequencies from 1 GHz to the 10th harmonic of highest fundamental frequency.
2. Radiated emissions measured in frequency above 1000MHz were made with an instrument using peak/average detector mode.
3. Average test would be performed if the peak result were greater than the average limit or as required by the applicant.
4. Data of measurement within this frequency range shown " --- " in the table above means the reading of emissions are attenuated more than 20dB below the permissible limits or the field strength is too small to be measured.
5. Measurements above show only up to 6 maximum emissions noted, or would be lesser, with " N/A " remark, if no specific emissions from the EUT are recorded (ie: margin>20dB from the applicable limit) and considered that's already beyond the background noise floor.
6. Margin (dB) = Remark result (dBuV/m) – Average limit (dBuV/m).