



FCC PART 15.407

TEST REPORT

For

GL Technologies (Hong Kong) Limited

FLAT/RM 203 2/F BUILDING 19W 19 SCIENCE PARK WEST AVENUE SHATIN NT,
Shatin, Hong Kong

FCC ID: 2AFIW-X750V2

Report Type: Original Report	Product Name: 4G LTE Wireless Gateway
Report Number:	DG1210518-17777E-00B
Report Date:	2021-06-30
Reviewed By:	Ivan Cao  Assistant Manager
Test Laboratory:	Bay Area Compliance Laboratories Corp. (Dongguan) No.12, Pulong East 1 st Road, Tangxia Town, Dongguan, Guangdong, China Tel: +86-769-86858888 Fax: +86-769-86858891 www.baclcorp.com.cn

TABLE OF CONTENTS

GENERAL INFORMATION.....	4
PRODUCT DESCRIPTION FOR EQUIPMENT UNDER TEST (EUT).....	4
OBJECTIVE	4
TEST METHODOLOGY	4
MEASUREMENT UNCERTAINTY	5
TEST FACILITY	5
DECLARATIONS.....	5
SYSTEM TEST CONFIGURATION.....	6
DESCRIPTION OF TEST CONFIGURATION	6
EQUIPMENT MODIFICATIONS	6
EUT EXERCISE SOFTWARE	6
SUPPORT EQUIPMENT LIST AND DETAILS	9
SUPPORT CABLE LIST AND DETAILS	9
BLOCK DIAGRAM OF TEST SETUP	10
SUMMARY OF TEST RESULTS.....	11
FCC §15.407 (f) & §1.1310 & §2.1091- MAXIMUM PERMISSIBLE EXPOSURE (MPE)	12
APPLICABLE STANDARD	12
FCC §15.203- ANTENNA REQUIREMENT.....	14
APPLICABLE STANDARD	14
ANTENNA CONNECTOR CONSTRUCTION	14
FCC §15.207(a)– CONDUCTED EMISSIONS.....	15
APPLICABLE STANDARD	15
EUT SETUP.....	15
EMI TEST RECEIVER SETUP.....	15
CORRECTED AMPLITUDE & MARGIN CALCULATION	16
TEST EQUIPMENT LIST AND DETAILS.....	16
TEST PROCEDURE	16
TEST DATA	17
FCC §15.209, §15.205 , §15.407(b) –UNWANTED EMISSION.....	19
APPLICABLE STANDARD	19
EUT SETUP.....	20
EMI TEST RECEIVER & SPECTRUM ANALYZER SETUP	21
TEST PROCEDURE	21
CORRECTED AMPLITUDE & MARGIN CALCULATION	22
TEST EQUIPMENT LIST AND DETAILS.....	23
TEST DATA	23
FCC §15.407(a)(e)–EMISSION BANDWIDTH AND OCCUPIED BANDWIDTH.....	37
APPLICABLE STANDARD	37
TEST EQUIPMENT LIST AND DETAILS.....	37
TEST PROCEDURE	37
TEST DATA	37
FCC §15.407(a) –MAXIMUM CONDUCTED OUTPUT POWER.....	59
APPLICABLE STANDARD	59
TEST EQUIPMENT LIST AND DETAILS.....	60

TEST PROCEDURE	60
TEST DATA	60
FCC §15.407(a) - POWER SPECTRAL DENSITY	62
APPLICABLE STANDARD	62
TEST PROCEDURE	63
TEST EQUIPMENT LIST AND DETAILS.....	63
TEST DATA	63

GENERAL INFORMATION

Product Description for Equipment under Test (EUT)

EUT Name:	4G LTE Wireless Gateway
EUT Model:	GL-X750V2C6
Multiple Model:	GL-X750V2
Model Difference:	Refer to the DOS letter for details
Operation Frequency:	5180-5240 MHz (802.11a/n ht20/ac vht20) 5190-5230 MHz(802.11n ht40/ac vht40) 5210 MHz(802.11ac vht80) 5745-5825 MHz (802.11a/n ht20/ac vht20) 5755-5795 MHz(802.11n ht40/ac vht40) 5775 MHz(802.11ac vht80)
Maximum Output Power (Conducted):	5150-5250 MHz:19.85 dBm 5725-5850 MHz:19.19dBm
Antenna Gain[▲]:	5.96 dBi(Max.)
Modulation Type:	OFDM
Rated Input Voltage:	DC 12V from Adapter
Adapter Information:	Model: ICP30A-120-1500
	Input: AC 100-240V, 50/60Hz, 0.8A
	Output: DC 12.0V, 1.5A, 18.0W
Serial Number:	DG1210518-17777E-RF -S1
EUT Received Date:	2021-05-18
EUT Received Status:	Good

Objective

This type approval report is prepared on behalf of *GL Technologies (Hong Kong) Limited* in accordance with Part 2-Subpart J, Part 15-Subparts A, and E of the Federal Communications Commission's rules.

The tests were performed in order to determine compliance with FCC Rules Part 15, Subpart E, section 15.203, 15.205, 15.207, 15.209 and 15.407 rules.

Test Methodology

All measurements contained in this report were conducted with ANSI C63.10-2013, American National Standard of Procedures for Compliance Testing of Unlicensed Wireless Devices. And KDB 789033 D02 General U-NII Test Procedures New Rules v02r01.

All emissions measurement was performed and Bay Area Compliance Laboratories Corp. (Dongguan).

Measurement Uncertainty

Parameter	Measurement Uncertainty
Occupied Channel Bandwidth	±5 %
RF output power, conducted	±0.61dB
Power Spectral Density, conducted	±0.61 dB
Unwanted Emissions, radiated	30M~200MHz: 4.55 dB,200M~1GHz: 5.92 dB,1G~6GHz: 4.98 dB, 6G~18GHz: 5.89 dB,18G~26.5G:5.47 dB,26.5G~40G:5.63 dB
Unwanted Emissions,conducted	±1.5 dB
Temperature	±1 °C
Humidity	±5%
DC and low frequency voltages	±0.4%
Duty Cycle	1%
AC Power Lines Conducted Emission	3.12 dB (150 kHz to 30 MHz)

Note: Otherwise required by the applicant or Product Regulations, Decision Rule in this report did not consider the uncertainty. The extended uncertainty given in this report is obtained by combining the standard uncertainty times the coverage Factor K with the 95% confidence interval.

Test Facility

The Test site used by Bay Area Compliance Laboratories Corp. (Dongguan) to collect test data is located on the No.12, Pulong East 1st Road, Tangxia Town, Dongguan, Guangdong, China.

The lab has been recognized as the FCC accredited lab under the KDB 974614 D01 and is listed in the FCC Public Access Link (PAL) database, FCC Registration No. : 897218, the FCC Designation No. : CN1220.

The lab has been recognized by Innovation, Science and Economic Development Canada to test to Canadian radio equipment requirements, the CAB identifier: CN0022.

Declarations

BACL is not responsible for the authenticity of any test data provided by the applicant. Data included from the applicant that may affect test results are marked with a triangle symbol “▲”. Customer model name, addresses, names, trademarks etc. are not considered data.

Unless otherwise stated the results shown in this test report refer only to the sample(s) tested.

This report cannot be reproduced except in full, without prior written approval of the Company.

This report is valid only with a valid digital signature. The digital signature may be available only under the Adobe software above version 7.0.

This report may contain data that are not covered by the accreditation scope and shall be marked with an asterisk “★”.

SYSTEM TEST CONFIGURATION

Description of Test Configuration

The system support 802.11a/n ht20/n ht40/ac vht20/ac vht40/ac vht80, the vht20/vht40 were reduced since the identical parameters with 802.11n ht20 and ht40.

For 5150~5250 MHz band, 7 channels are provided:

Channel	Frequency (MHz)	Channel	Frequency (MHz)
36	5180	44	5220
38	5190	46	5230
40	5200	48	5240
42	5210	/	/

For 802.11a, 802.11n ht20,802.11ac vht20 channel 36, 40 and 48 was tested, for 802.11n ht40, 802.11ac vht40 channel 38, 46 were tested, for 802.11ac vht80, channel 42 was tested.

For 5725~5850MHz band, 8 channels are provided to testing:

Channel	Frequency (MHz)	Channel	Frequency (MHz)
149	5745	157	5785
151	5755	159	5795
153	5765	161	5805
155	5775	165	5825

For 802.11a, 802.11n ht20, 802.11ac vht20 channel 149, 157 and 165 was tested, for 802.11n ht40, 802.11ac vht40 channel 151, 159 were tested, for 802.11ac vht80, channel 155 was tested.

Equipment Modifications

No modification was made to the EUT.

EUT Exercise Software

The software “argui.exe” was used for testing, which was provided by Manufacturer. The worst-case data rates are determined to be as follows for each mode based upon investigations by measuring the average power and PSD across all data rates, bandwidths, and modulations. The maximum power was configured as below table, that provided by the Manufacturer▲:

Band	Mode	Channel	Frequency (MHz)	Data Rate	Power level Setting
5150 - 5250 MHz	802.11a	Low	5180	6Mbps	15
		Middle	5200	6Mbps	19
		High	5240	6Mbps	19
	802.11n ht20	Low	5180	MCS0	15
		Middle	5200	MCS0	17
		High	5240	MCS0	20
	802.11n ht40	Low	5190	MCS0	20
		High	5230	MCS0	17
	802.11ac vht80	Middle	5210	MCS0	15
5725 - 5850 MHz	802.11a	Low	5745	6Mbps	15
		Middle	5785	6Mbps	12
		High	5825	6Mbps	18
	802.11n ht20	Low	5745	MCS0	18
		Middle	5785	MCS0	18
		High	5825	MCS0	17
	802.11n ht40	Low	5755	MCS0	17
		High	5795	MCS0	17
	802.11ac vht80	Middle	5775	MCS0	17

The duty cycle as below:

Mode	T _{on} (ms)	T _{on+off} (ms)	Duty Cycle (%)
802.11 a	2.098	2.2409	93.62
802.11n ht20	1.9539	2.0362	95.96
802.11n ht40	0.9610	1.0217	94.06
802.11ac vht80	0.0771	0.1431	53.88

802.11a

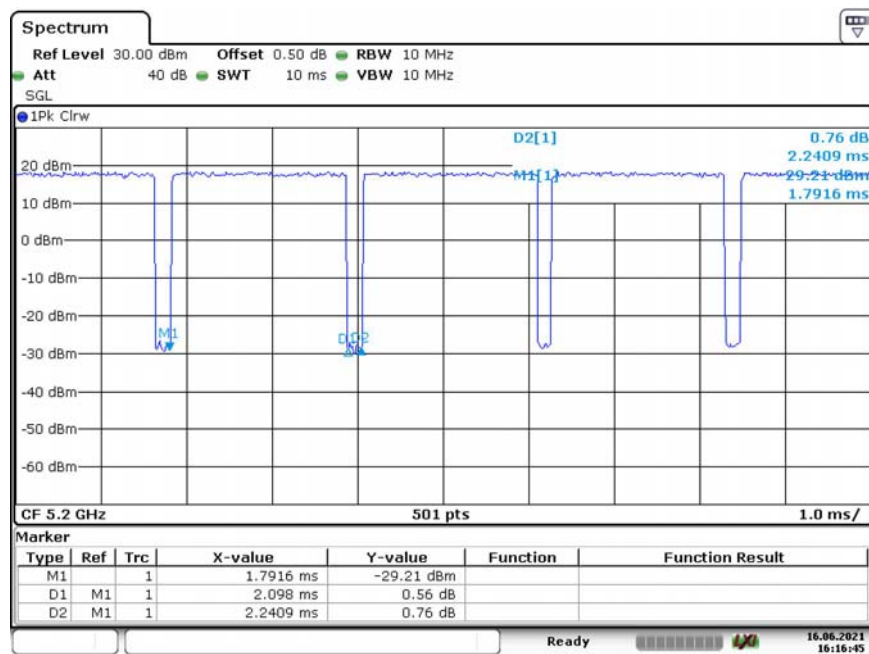

Date: 16.JUN.2021 16:16:45

802.11n ht20

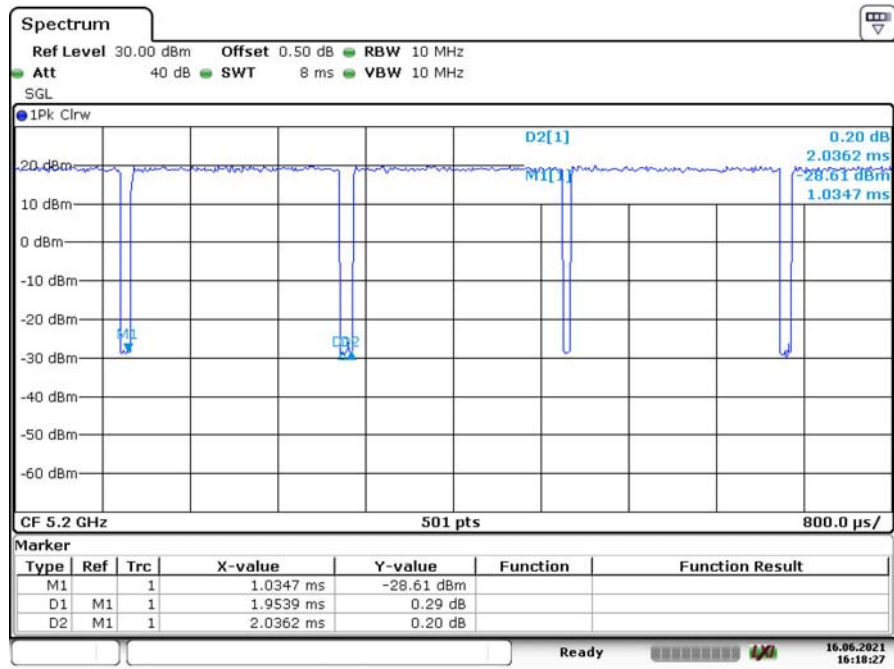

Date: 16.JUN.2021 16:18:27

802.11n ht40

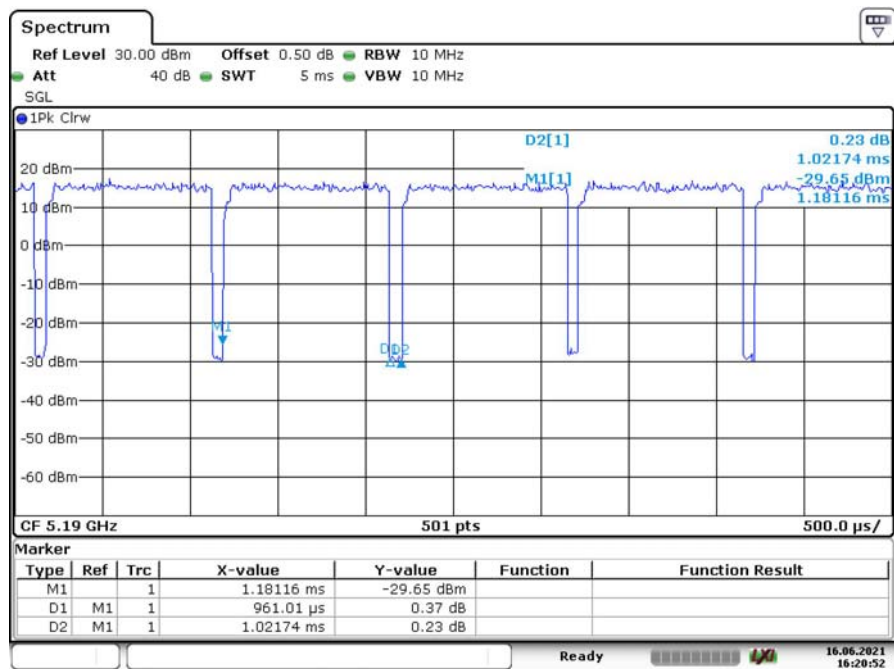

Date: 16.JUN.2021 16:20:52

802.11ac vht80

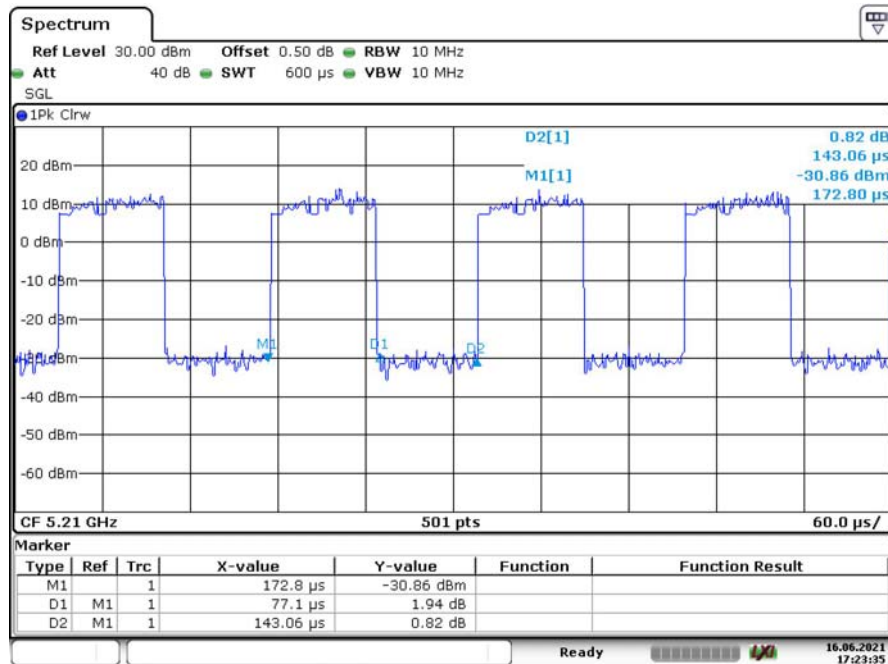

Date: 16.JUN.2021 17:23:35

Support Equipment List and Details

Manufacturer	Description	Model	Serial Number
ThinkPad	Laptop	E450	PF-0MR8KV 16/08
DELL	Laptop	PP11L	QDS-BRCM1017
Huawei	router	WS5200	2017011608000660
SanDisk	USB Flash Disk	UHS-I-16G	9292DVDSV0XZ

Support Cable List and Details

Cable Description	Shielding Type	Ferrite Core	Length (m)	From Port	To
RJ45 Cable	No	No	10	EUT	Router
Power Cable	No	No	1.5	Adapter	EUT
RJ45 Cable	No	No	10	EUT	Laptop

Block Diagram of Test Setup

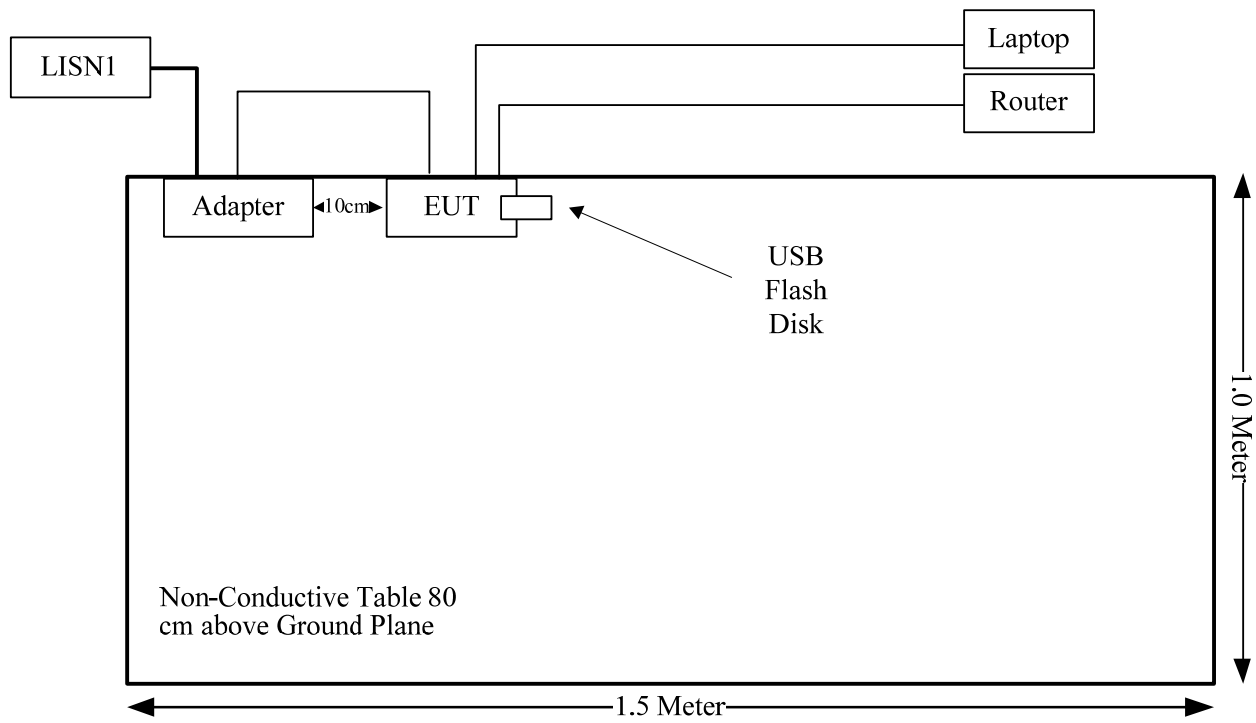

SUMMARY OF TEST RESULTS

Rules	Description of Test	Result
FCC §15.407 (f) & §1.1310 & §2.1091	Maximum Permissible Exposure (MPE)	Compliance
FCC§15.203	Antenna Requirement	Compliance
FCC§15.407(b)(6)& §15.207(a)	Conducted Emissions	Compliance
FCC§15.205& §15.209 &§15.407(b)	Undesirable Emission& Restricted Bands	Compliance
FCC§15.407(b)	Out Of Band Emissions	Compliance
FCC§15.407(a) (e)	Emission Bandwidth	Compliance
FCC§15.407(a)	Conducted Transmitter Output Power	Compliance
FCC§15.407 (a)	Power Spectral Density	Compliance

FCC §15.407 (f) & §1.1310 & §2.1091- MAXIMUM PERMISSIBLE EXPOSURE (MPE)

Applicable Standard

According to subpart 15.407(f) and subpart §1.1310, systems operating under the provisions of this section shall be operated in a manner that ensures that the public is not exposed to radio frequency energy level in excess of the Commission’s guidelines.

Limits for Maximum Permissible Exposure (MPE) (§1.1310, §2.1091)

(B) Limits for General Population/Uncontrolled Exposure				
Frequency Range (MHz)	Electric Field Strength (V/m)	Magnetic Field Strength (A/m)	Power Density (mW/cm²)	Averaging Time (minutes)
0.3–1.34	614	1.63	*(100)	30
1.34–30	824/f	2.19/f	*(180/f ²)	30
30–300	27.5	0.073	0.2	30
300–1500	/	/	f/1500	30
1500–100,000	/	/	1.0	30

f = frequency in MHz; * = Plane-wave equivalent power density;

According to §1.1310 and §2.1091 RF exposure is calculated.

Calculation formula:

Prediction of power density at the distance of the applicable MPE limit

$S = PG/4\pi R^2$ = power density (in appropriate units, e.g. mW/cm²);

P = power input to the antenna (in appropriate units, e.g., mW);

G = power gain of the antenna in the direction of interest relative to an isotropic radiator, the power gain Factor, is normally numeric gain;

R = distance to the center of radiation of the antenna (appropriate units, e.g., cm);

For simultaneously transmit system, the calculated power density should comply with:

$$\sum_i \frac{S_i}{S_{Limit,i}} \leq 1$$

Calculated Data:

Mode	Frequency (MHz)	Antenna Gain		Conducted output power including Tune-up Tolerance		Evaluation Distance (cm)	Power Density (mW/cm ²)	MPE Limit (mW/cm ²)
		(dBi)	(numeric)	(dBm)	(mW)			
WLAN	2412-2462	2.86	1.93	20	100.00	20.00	0.04	1.0
WLAN	5150-5250	5.96	3.94	20	100.00	20.00	0.08	1.0
WLAN	5725-5850	5.96	3.94	20	100.00	20.00	0.08	1.0
BLE	2402-2480	0	1.00	1	1.26	20.00	0.0003	1.0
WCDMA B2	1850-1910	-1.7	0.68	24	251.19	20.00	0.03	1.0
WCDMA B4	1710-1755	-1.9	0.65	24	251.19	20.00	0.03	1.0
WCDMA B5	824-849	-1.6	0.69	24	251.19	20.00	0.03	0.55
LTE B2	1850-1910	-1.7	0.68	24	251.19	20.00	0.03	1.0
LTE B4	1710-1755	-1.9	0.65	24	251.19	20.00	0.03	1.0
LTE B5	824-849	-1.6	0.69	24	251.19	20.00	0.03	0.55
LTE B7	2500-2570	2	1.58	24	251.19	20.00	0.08	1.0
LTE B12	699-716	0.5	1.12	24	251.19	20.00	0.06	0.47
LTE B13	777-787	0.7	1.17	24	251.19	20.00	0.06	0.52
LTE B25	1850-1915	-1.7	0.68	24	251.19	20.00	0.03	1.0
LTE B26	814-849	-1.6	0.69	24	251.19	20.00	0.04	0.54
LTE B30	2305-2315	2.3	1.70	24	251.19	20.00	0.08	1.0
LTE B66	1710-1780	-1.9	0.65	24	251.19	20.00	0.03	1.0

Note: The device build in a certified WWAN Module, FCC ID: XMR201807EP06A, the WLAN 2.4G, WLAN 5G, BLE and WWAN can transmit simultaneously:

$$\sum_i \frac{S_i}{S_{Limit,i}}$$

$$=S_{2.4}/S_{limit-2.4} + S_5/S_{limit-5} + S_{BLE}/S_{limit-BLE} + S_{WWAN}/S_{limit-WWAN}$$

$$=0.04/1+0.08/1+0.0003/1+0.06/0.47$$

$$=0.25$$

$$< 1.0$$

Result: The device meet FCC MPE at **20 cm** distance

FCC §15.203- ANTENNA REQUIREMENT

Applicable Standard

According to FCC§ 15.203, an intentional radiator shall be designed to ensure that no antenna other than that furnished by the responsible party shall be used with the device. The use of a permanently attached antenna or of an antenna that uses a unique coupling to the intentional radiator shall be considered sufficient to comply with the provisions of this section. The manufacturer may design the unit so that a broken antenna can be replaced by the user, but the user of a standard antenna jack or electrical connector is prohibited. The structure and application of the EUT were analyzed to determine compliance with section §15.203 of the rules. §15.203 state that the subject device must meet the following criteria:

- a. Antenna must be permanently attached to the unit.
- b. Antenna must use a unique type of connector to attach to the EUT.
- c. Unit must be professionally installed, and installer shall be responsible for verifying that the correct antenna is employed with the unit.

Immediately following the above notice, the manufacturer shall provide a list of all antenna types which can be used with the transmitter, indicating the maximum permissible antenna gain (in dBi) and the required impedance for each antenna type.

Antenna Connector Construction

The EUT has two internal PCB antennas for 2.4GHz WLAN, one internal PCB antennas for BLE, and one internal PCB antennas for 5GHz WLAN, all of them permanently attached to the unit, fulfill the requirement of this section. Please refer to the EUT photos.

Usage	Antenna Type	input impedance (Ohm)	Antenna Gain /Frequency Range
2.4GHz WLAN Chain 0	PCB	50	2.78 dBi/2.4~2.5GHz
2.4GHz WLAN Chain 1	PCB	50	2.86 dBi/2.4~2.5GHz
BLE	PCB	50	0 dBi/2.4~2.5GHz
5GHz WLAN	PCB	50	5.96 dBi/5.15~5.85GHz

Result: Compliance.

FCC §15.207(a)– CONDUCTED EMISSIONS

Applicable Standard

FCC §15.207(a), §15.407(b) (6).

EUT Setup

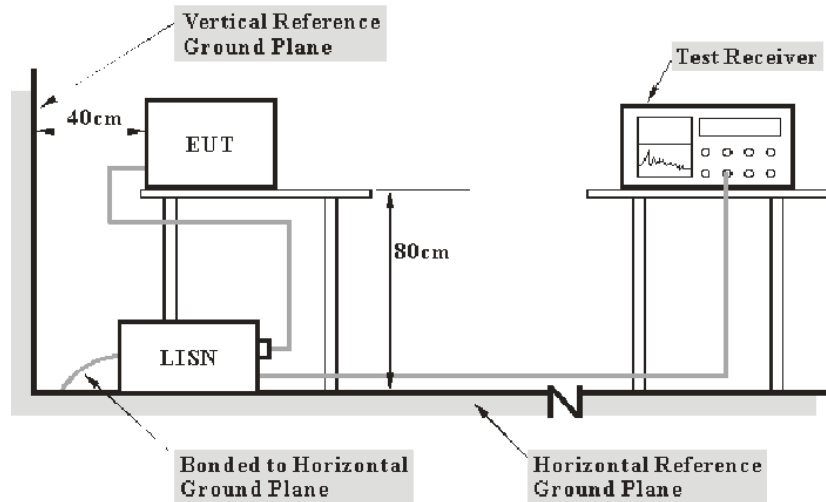

- Note: 1. Support units were connected to second LISN.
 2. Both of LISNs (AMN) 80 cm from EUT and at the least 80 cm from other units and other metal planes support units.

The setup of EUT is according with per ANSI C63.10-2013 measurement procedure. The specification used was with the FCC Part 15.207 limits.

The spacing between the peripherals was 10 cm.

The adapter was connected to the main lisen with a 120 V/60 Hz AC power source.

EMI Test Receiver Setup

The EMI test receiver was set to investigate the spectrum from 150 kHz to 30 MHz.

During the conducted emission test, the EMI test receiver was set with the following configurations:

Frequency Range	IF B/W
150 kHz – 30 MHz	9 kHz

Corrected Amplitude & Margin Calculation

The basic equation is as follows:

$$V_C = V_R + A_C + VDF$$

$$C_f = A_C + VDF$$

Herein,

V_C (cord. Reading): corrected voltage amplitude

V_R : reading voltage amplitude

A_c : attenuation caused by cable loss

VDF: voltage division Factor of AMN

C_f : Correction Factor

The “**Margin**” column of the following data tables indicates the degree of compliance within the applicable limit. For example, a margin of 7dB means the emission is 7dB below the limit. The equation for margin calculation is as follows:

$$\text{Margin} = \text{Limit} - \text{Corrected Amplitude}$$

Test Equipment List and Details

Manufacturer	Description	Model	Serial Number	Calibration Date	Calibration Due Date
R&S	LISN	ENV 216	101614	2020-09-12	2021-09-12
R&S	EMI Test Receiver	ESCI	101121	2020-07-07	2021-07-07
MICRO-COAX	Coaxial Cable	C-NJNJ-50	C-0200-01	2020-09-05	2021-09-05
R&S	Test Software	EMC32	Version 9.10.00	N/A	N/A

* **Statement of Traceability:** Bay Area Compliance Laboratories Corp. (Dongguan) attests that all calibrations have been performed, traceable to National Primary Standards and International System of Units (SI).

Test Procedure

During the conducted emission test, the adapter was connected to the first LISN.

The frequency and amplitude of the six highest ac power-line conducted emissions relative to the limit, measured over all the current-carrying conductors of the EUT power cords, and the operating frequency or frequency to which the EUT is tuned (if appropriate), should be reported, unless such emissions are more than 20 dB below the limit. AC power-line conducted emissions measurements are to be separately carried out only on each of the phase (“hot”) line(s) and (if used) on the neutral line(s), but not on the ground [protective earth] line(s). If less than six emission frequencies are within 20 dB of the limit, then the noise level of the measuring instrument at representative frequencies should be reported. The specific conductor of the power-line cord for each of the reported emissions should be identified. Measure the six highest emissions with respect to the limit on each current-carrying conductor of each power cord associated with the EUT (but not the power cords of associated or peripheral equipment that are part of the test configuration). Then, report the six highest emissions with respect to the limit from among all the measurements identifying the frequency and specific current-carrying conductor identified with the emission. The six highest emissions should be reported for each of the current-carrying conductors, or the six highest emissions may be reported over all the current-carrying conductors.

Test Data

Environmental Conditions

Temperature:	24.4 °C
Relative Humidity:	63 %
ATM Pressure:	100 kPa
Tester:	Walker Chen
Test Date:	2021-06-11

Test Result: Compliance.

Test Mode: Transmitting (802.11a 5200MHz chain 1 was the worst)

AC120 V, 60 Hz, Line:

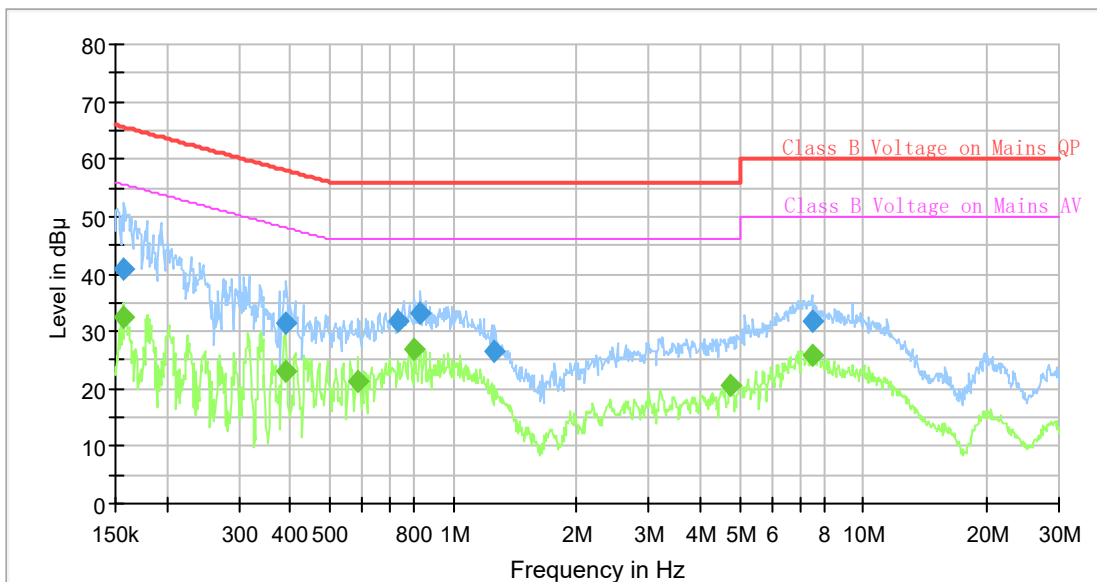

Final Result

Frequency (MHz)	QuasiPeak (dB µV)	Average (dB µV)	Limit (dB µV)	Margin (dB)	Bandwidth (kHz)	Line	Corr. (dB)
0.156106	---	32.42	55.67	23.25	9.000	L1	9.6
0.157671	41.00	---	65.59	24.59	9.000	L1	9.6
0.388874	---	23.02	48.09	25.07	9.000	L1	9.6
0.390819	31.47	---	58.05	26.58	9.000	L1	9.6
0.585364	---	21.38	46.00	24.62	9.000	L1	9.6
0.732654	31.69	---	56.00	24.31	9.000	L1	9.7
0.805479	---	27.06	46.00	18.94	9.000	L1	9.7
0.829947	33.19	---	56.00	22.81	9.000	L1	9.7
1.261826	26.68	---	56.00	29.32	9.000	L1	9.7
4.755236	---	20.53	46.00	25.47	9.000	L1	9.7
7.486584	31.89	---	60.00	28.11	9.000	L1	9.8
7.561637	---	26.00	50.00	24.00	9.000	L1	9.8

AC120 V, 60 Hz, Neutral:

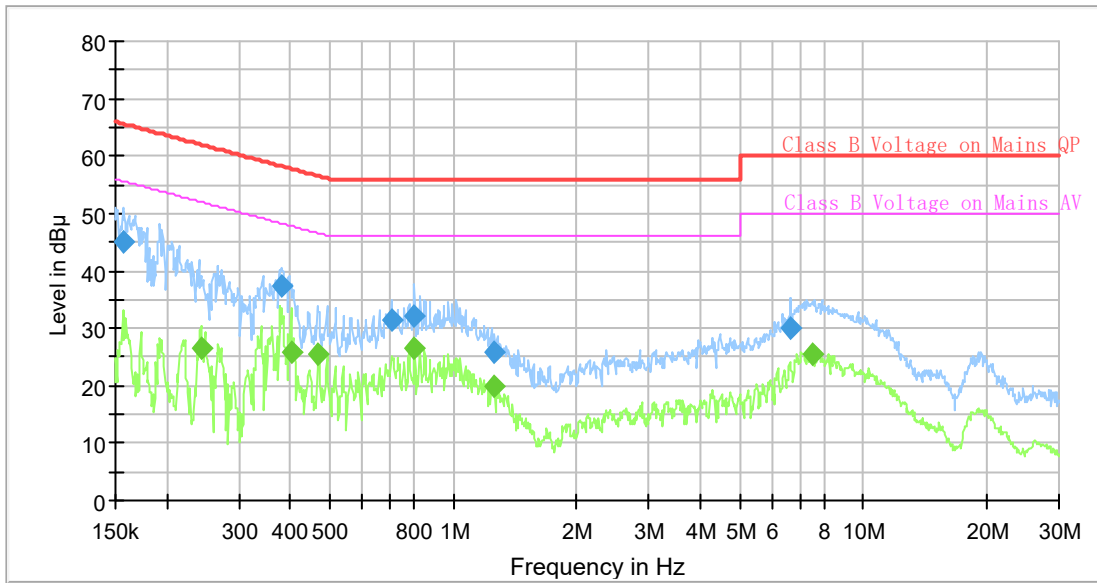

Final Result

Frequency (MHz)	QuasiPeak (dB µ V)	Average (dB µ V)	Limit (dB µ V)	Margin (dB)	Bandwidth (kHz)	Line	Corr. (dB)
0.156106	45.21	---	65.67	20.46	9.000	N	9.6
0.243332	---	26.47	51.98	25.51	9.000	N	9.6
0.381193	37.52	---	58.25	20.73	9.000	N	9.6
0.402691	---	25.82	47.80	21.98	9.000	N	9.6
0.467685	---	25.37	46.55	21.18	9.000	N	9.6
0.707516	31.40	---	56.00	24.60	9.000	N	9.6
0.805479	32.22	---	56.00	23.78	9.000	N	9.6
0.805479	---	26.38	46.00	19.62	9.000	N	9.6
1.261826	25.81	---	56.00	30.19	9.000	N	9.6
1.261826	---	19.96	46.00	26.04	9.000	N	9.6
6.641990	30.18	---	60.00	29.82	9.000	N	9.6
7.524016	---	25.56	50.00	24.44	9.000	N	9.6

FCC §15.209, §15.205 , §15.407(b) –UNWANTED EMISSION

Applicable Standard

FCC §15.407; §15.209; §15.205;

(b) Undesirable emission limits. Except as shown in paragraph (b)(7) of this section, the maximum emissions outside of the frequency bands of operation shall be attenuated in accordance with the following limits:

(1) For transmitters operating in the 5.15-5.25 GHz band: All emissions outside of the 5.15-5.35 GHz band shall not exceed an e.i.r.p. of -27 dBm/MHz.

(2) For transmitters operating in the 5.25-5.35 GHz band: All emissions outside of the 5.15-5.35 GHz band shall not exceed an e.i.r.p. of -27 dBm/MHz.

(3) For transmitters operating in the 5.47-5.725 GHz band: All emissions outside of the 5.47-5.725 GHz band shall not exceed an e.i.r.p. of -27 dBm/MHz.

(4) For transmitters operating in the 5.725-5.85 GHz band:

(i) All emissions shall be limited to a level of -27 dBm/MHz at 75 MHz or more above or below the band edge increasing linearly to 10 dBm/MHz at 25 MHz above or below the band edge, and from 25 MHz above or below the band edge increasing linearly to a level of 15.6 dBm/MHz at 5 MHz above or below the band edge, and from 5 MHz above or below the band edge increasing linearly to a level of 27 dBm/MHz at the band edge.

(ii) Devices certified before March 2, 2017 with antenna gain greater than 10 dBi may demonstrate compliance with the emission limits in §15.247(d), but manufac vhturing, marketing and importing of devices certified under this alternative must cease by March 2, 2018. Devices certified before March 2, 2018 with antenna gain of 10 dBi or less may demonstrate compliance with the emission limits in §15.247(d), but manufac vhturing, marketing and importing of devices certified under this alternative must cease before March 2, 2020.

(5) The emission measurements shall be performed using a minimum resolution bandwidth of 1 MHz. A lower resolution bandwidth may be employed near the band edge, when necessary, provided the measured energy is integrated to show the total power over 1 MHz.

(6) Unwanted emissions below 1 GHz must comply with the general field strength limits set forth in §15.209. Further, any U-NII devices using an AC power line are required to comply also with the conducted limits set forth in §15.207.

(7) The provisions of §15.205 apply to intentional radiators operating under this section.

EUT Setup

Below 1 GHz:

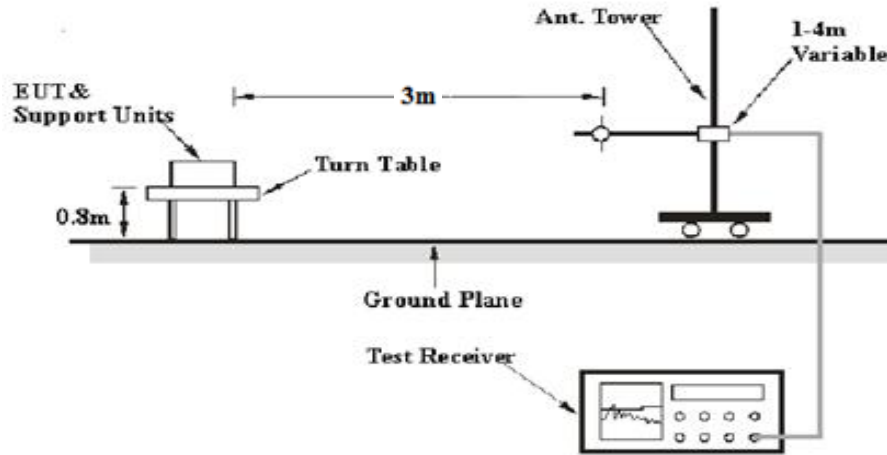

1-26.5 GHz:

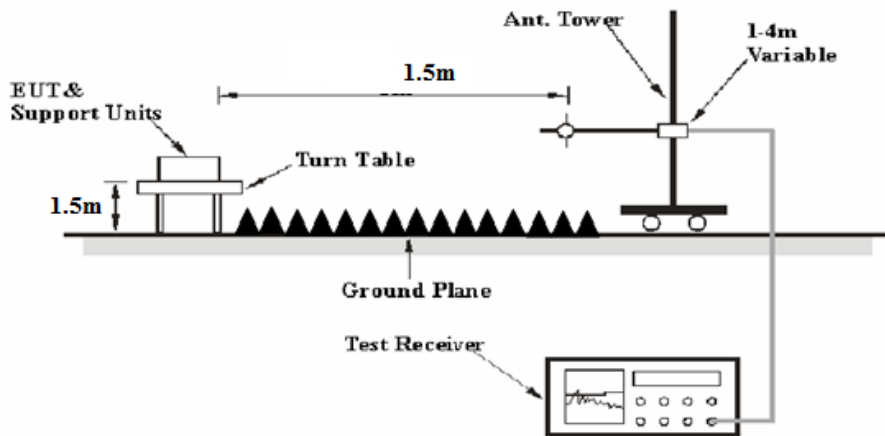

26.5-40 GHz:

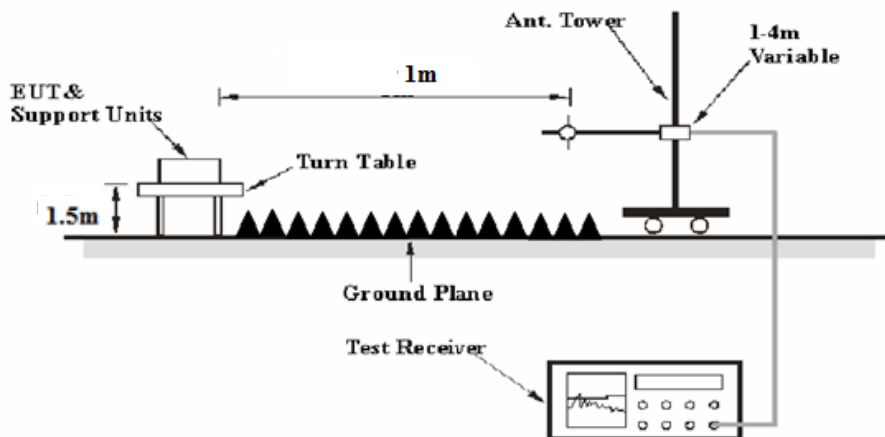

The radiated emission Below 1GHz tests were performed in the 10 meters chamber test site, above 1GHz tests were performed in the 3 meters chamber test site B, using the setup accordance with the ANSI C63.10-2013. The specification used was the FCC 15.209, and FCC 15.407 limits.

The external I/O cables were draped along the test table and formed a bundle 30 to 40 cm long in the middle.

The spacing between the peripherals was 10 cm.

EMI Test Receiver & Spectrum Analyzer Setup

The system was investigated from 30 MHz to 40 GHz.

During the radiated emission test, the EMI test receiver & Spectrum Analyzer Setup were set with the following configurations:

30-1000MHz:

Measurement	RBW	Video B/W	IF B/W
QP	120 kHz	300 kHz	120kHz

1GHz- 40GHz:

Measurement	Duty cycle	RBW	Video B/W
PK	Any	1MHz	3 MHz
Ave.	>98%	1MHz	10 Hz
	<98%	1MHz	1/T

If the maximized peak measured value complies with under the QP/Average limit more than 6dB, then it is unnecessary to perform an QP/Average measurement.

Test Procedure

During the radiated emission test, the adapter was connected to the first AC floor outlet.

Data was recorded in Quasi-peak detection mode for frequency range of 30 MHz-1GHz, peak and Average detection modes for frequencies above 1GHz.

According to KDB 789033 D02 General UNII Test Procedures New Rules v02r01, emission shall be computed as: $E [dB\mu V/m] = EIRP[dBm] + 95.2$, for $d = 3$ meters.

According to C63.10, the above 1G test result shall be extrapolated to the specified distance using an extrapolation Factor of 20dB/decade from 3m to 1.5m or 1m

Distance extrapolation Factor = $20 \log(\text{specific distance [3m]}/\text{test distance [1.5m]})$ dB= 6.02 dB

or

Distance extrapolation Factor = $20 \log(\text{specific distance [3m]}/\text{test distance [1m]})$ dB= 9.54 dB

All emissions under the average limit and under the noise floor have not recorded in the report.

Corrected Amplitude & Margin Calculation

For the range 30MHz-1GHz, the Corrected Amplitude is calculated by adding the Antenna Factor and Cable Loss, and subtracting the Amplifier Gain from the Meter Reading. The basic equation is as follows:

$$\text{Corrected Amplitude} = \text{Meter Reading} + \text{Antenna Factor} + \text{Cable Loss} - \text{Amplifier Gain}$$

The “**Margin**” column of the following data tables indicates the degree of compliance with the applicable limit. For example, a margin of 7dB means the emission is 7dB below the limit. The equation for margin calculation is as follows:

$$\text{Margin} = \text{Limit} - \text{Corrected Amplitude}$$

For the range 1GHz-40GHz, Test performed at 1.5m or 1m, the Corrected Amplitude is calculated by adding the Antenna Factor and Cable Loss, and subtracting the Amplifier Gain from the Meter Reading and the Distance extrapolation Factor. The basic equation is as follows:

$$\begin{aligned} &\text{Corrected Amplitude} \\ &= \text{Meter Reading} + \text{Antenna Factor} + \text{Cable Loss} - \text{Amplifier Gain} - \text{Distance extrapolation factor} \end{aligned}$$

The “**Margin**” column of the following data tables indicates the degree of compliance with the applicable limit. For example, a margin of 7dB means the emission is 7dB below the limit. The equation for margin calculation is as follows:

$$\text{Margin} = \text{Limit} - \text{Corrected Amplitude}$$

Test Equipment List and Details

Manufacturer	Description	Model	Serial Number	Calibration Date	Calibration Due Date
Radiation Below 1GHz Test					
Sunol Sciences	Antenna	JB3	A060611-2	2020-08-25	2023-08-25
R&S	EMI Test Receiver	ESCI	100224	2020-09-12	2021-09-12
Unknown	Coaxial Cable	C-NJNJ-50	C-1000-01	2020-09-05	2021-09-05
Unknown	Coaxial Cable	C-NJNJ-50	C-0400-02	2020-09-05	2021-09-05
Unknown	Coaxial Cable	C-NJNJ-50	C-0530-01	2020-09-24	2021-09-24
Sonoma	Amplifier	310N	185914	2020-10-13	2021-10-13
Farad	Test Software	EZ-EMC	V1.1.4.2	N/A	N/A
Radiation Above 1GHz Test					
ETS-Lindgren	Horn Antenna	3115	000 527 35	2018-10-12	2021-10-12
Ducommun Technologies	Horn Antenna	ARH-4223-02	1007726-01 1304	2020-12-05	2023-12-04
Ducommun Technologies	Horn Antenna	ARH-2823-02	1007726-01 1302	2020-12-05	2023-12-04
R&S	Spectrum Analyzer	FSV40	101474	2020-07-07	2021-07-07
Agilent	Spectrum Analyzer	E4440A	SG43360054	2020-07-07	2021-07-07
Unknown	Coaxial Cable	C-SJSJ-50	C-0800-01	2020-09-05	2021-09-05
Unknown	Coaxial Cable	C-2.4J2.4J-50	C-0700-02	2020-06-27	2021-06-27
Mini-Circuit	Amplifier	ZVA-213-S+	54201245	2020-09-05	2021-09-05
Quinstar	Amplifier	QLW-18405536-JO	15964001001	2020-06-27	2021-06-27
Farad	Test Software	EZ-EMC	V1.1.4.2	N/A	N/A
Sinoscite	Bandstop Filters	BSF5150-5850MN- 0899-003	0899003	2021-05-06	2022-05-06
Mini Circuits	High Pass Filter	VHF-6010+	31118	2020-06-16	2021-06-16

* **Statement of Traceability:** Bay Area Compliance Laboratories Corp. (Dongguan) attests that all calibrations have been performed, traceable to National Primary Standards and International System of Units (SI).

Test Data

Environmental Conditions

Test Items	Radiation Below 1GHz	Radiation Above 1GHz
Temperature:	23.5 °C	27.6°C
Relative Humidity:	50 %	42 %
ATM Pressure:	100.3kPa	100.3kPa
Tester:	Burt Hu	Lee Li
Test Date:	2021-06-03	2021-06-03

Test Mode: Transmitting

1) Below 1GHz(802.11a chain 0 5745 MHz was the worst):

Horizontal:

80.0 dBuV/m

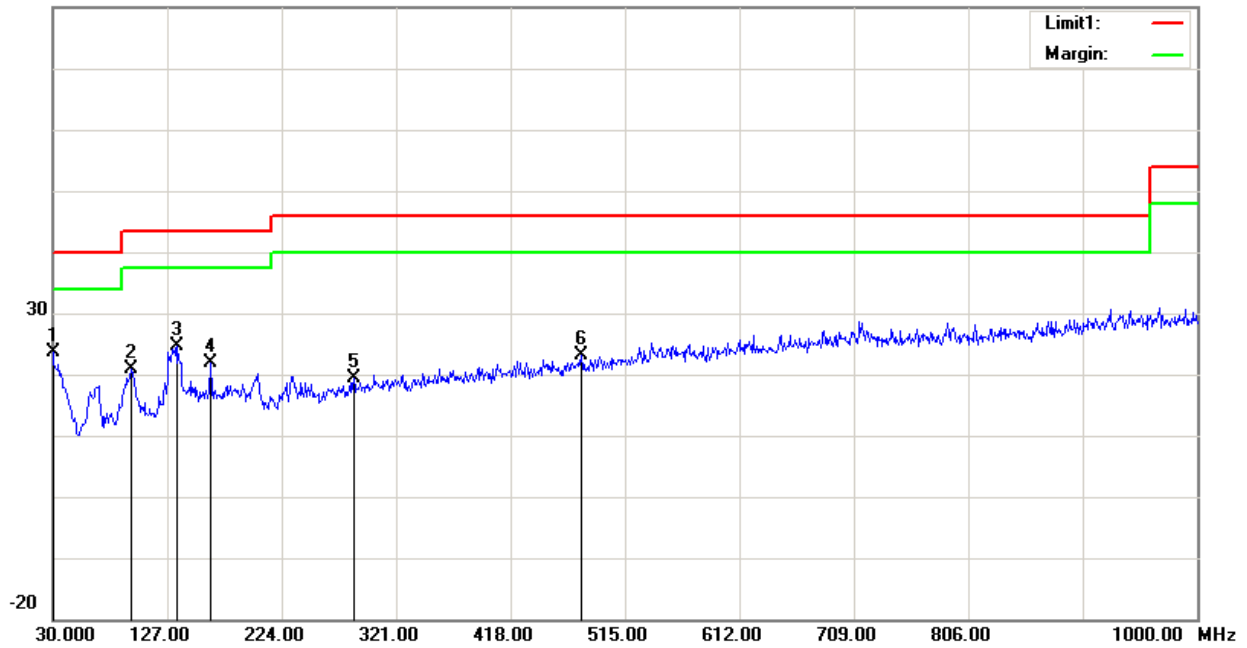

Frequency (MHz)	Receiver Reading (dBuV)	Detector	Correction Factor (dB/m)	Cord. Amp. (dBuV/m)	Limit (dBuV/m)	Margin (dB)
30.0000	27.65	peak	-4.10	23.55	40.00	16.45
95.9600	35.28	peak	-14.40	20.88	43.50	22.62
135.7300	34.02	peak	-9.31	24.71	43.50	18.79
163.8600	31.20	peak	-9.28	21.92	43.50	21.58
285.1100	27.73	peak	-8.33	19.40	46.00	26.60
478.1400	26.89	peak	-3.80	23.09	46.00	22.91

Vertical:

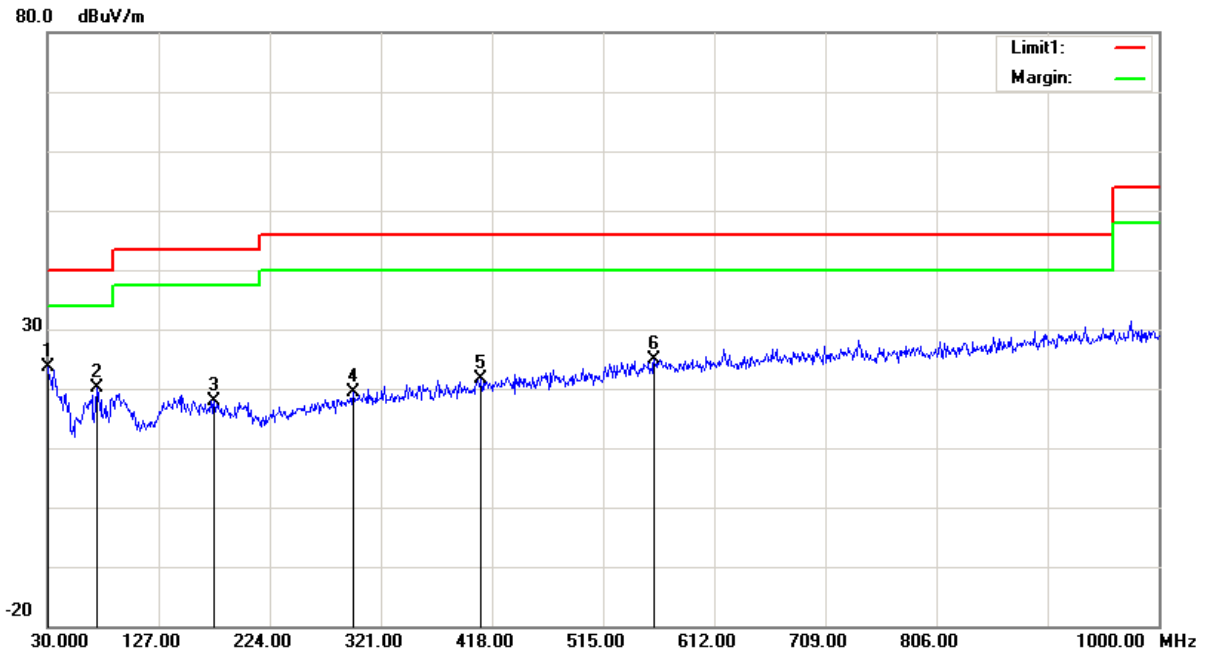

Frequency (MHz)	Receiver Reading (dBµV)	Detector	Correction Factor (dB/m)	Cord. Amp. (dBµV/m)	Limit (dBµV/m)	Margin (dB)
30.9700	28.33	peak	-4.66	23.67	40.00	16.33
73.6500	36.36	peak	-16.18	20.18	40.00	19.82
175.5000	27.74	peak	-9.78	17.96	43.50	25.54
296.7500	26.95	peak	-7.60	19.35	46.00	26.65
408.3000	26.49	peak	-4.92	21.57	46.00	24.43
559.6200	26.38	peak	-1.53	24.85	46.00	21.15

**2) 1GHz-40GHz:
5150-5250MHz
802.11a**

Frequency (MHz)	Receiver		Rx Antenna		Cable loss (dB)	Amplifier Gain (dB)	Corrected Amplitude (dBµV/m)	Extrapolation result (dBµV/m)	Limit (dBµV/m)	Margin (dB)
	Reading (dBµV)	Detector	Polar (H/V)	Factor (dB/m)						
Low Channel: 5180 MHz										
5180.00	78.18	PK	H	33.59	3.58	0.00	115.35	109.33	N/A	N/A
5180.00	69.36	AV	H	33.59	3.58	0.00	106.53	100.51	N/A	N/A
5180.00	68.21	PK	V	33.59	3.58	0.00	105.38	99.36	N/A	N/A
5180.00	59.58	AV	V	33.59	3.58	0.00	96.75	90.73	N/A	N/A
5150.00	32.33	PK	H	33.54	3.56	0.00	69.43	63.41	74.00	10.59
5150.00	21.80	AV	H	33.54	3.56	0.00	58.90	52.88	54.00	1.12
10360.00	39.15	PK	H	38.17	6.29	25.46	58.15	52.13	68.20	16.07
15540.00	37.52	PK	H	38.06	8.85	24.27	60.16	54.14	74.00	19.86
15540.00	26.34	AV	H	38.06	8.85	24.27	48.98	42.96	54.00	11.04
Middle Channel: 5200 MHz										
5200.00	81.86	PK	H	33.62	3.60	0.00	119.08	113.06	N/A	N/A
5200.00	73.75	AV	H	33.62	3.60	0.00	110.97	104.95	N/A	N/A
5200.00	72.36	PK	V	33.62	3.60	0.00	109.58	103.56	N/A	N/A
5200.00	63.20	AV	V	33.62	3.60	0.00	100.42	94.4	N/A	N/A
5150.00	26.54	PK	H	33.54	3.56	0.00	63.64	57.62	74.00	16.38
5150.00	15.87	AV	H	33.54	3.56	0.00	52.97	46.95	54.00	7.05
10400.00	42.61	PK	H	38.18	6.32	25.46	61.65	55.63	68.20	12.57
15600.00	41.11	PK	H	38.00	8.83	24.31	63.63	57.61	74.00	16.39
15600.00	29.92	AV	H	38.00	8.83	24.31	52.44	46.42	54.00	7.58
High Channel: 5240 MHz										
5240.00	79.02	PK	H	33.68	3.52	0.00	116.22	110.2	N/A	N/A
5240.00	70.01	AV	H	33.68	3.52	0.00	107.21	101.19	N/A	N/A
5240.00	69.52	PK	V	33.68	3.52	0.00	106.72	100.7	N/A	N/A
5240.00	60.23	AV	V	33.68	3.52	0.00	97.43	91.41	N/A	N/A
5350.00	32.67	PK	H	33.86	3.52	0.00	70.05	64.03	74.00	9.97
5350.00	21.60	AV	H	33.86	3.52	0.00	58.98	52.96	54.00	1.04
10480.00	37.48	PK	H	38.20	6.37	25.47	56.58	50.56	68.20	17.64
15720.00	36.03	PK	H	37.88	8.79	24.39	58.31	52.29	74.00	21.71
15720.00	24.06	AV	H	37.88	8.79	24.39	46.34	40.32	54.00	13.68

802.11n ht20:

Frequency (MHz)	Receiver		Rx Antenna		Cable loss (dB)	Amplifier Gain (dB)	Corrected Amplitude (dBµV/m)	Extrapolation result (dBµV/m)	Limit (dBµV/m)	Margin (dB)
	Reading (dBµV)	Detector	Polar (H/V)	Factor (dB/m)						
Low Channel: 5180 MHz										
5180.00	80.06	PK	H	33.59	3.58	0.00	117.23	111.21	N/A	N/A
5180.00	71.00	AV	H	33.59	3.58	0.00	108.17	102.15	N/A	N/A
5180.00	70.85	PK	V	33.59	3.58	0.00	108.02	102	N/A	N/A
5180.00	61.55	AV	V	33.59	3.58	0.00	98.72	92.7	N/A	N/A
5150.00	33.63	PK	H	33.54	3.56	0.00	70.73	64.71	74.00	9.29
5150.00	22.12	AV	H	33.54	3.56	0.00	59.22	53.2	54.00	0.80
10360.00	36.66	PK	H	38.17	6.29	25.46	55.66	49.64	68.20	18.56
15540.00	37.58	PK	H	38.06	8.85	24.27	60.22	54.2	74.00	19.80
15540.00	26.39	AV	H	38.06	8.85	24.27	49.03	43.01	54.00	10.99
Middle Channel: 5200 MHz										
5200.00	83.87	PK	H	33.62	3.60	0.00	121.09	115.07	N/A	N/A
5200.00	75.27	AV	H	33.62	3.60	0.00	112.49	106.47	N/A	N/A
5200.00	72.56	PK	V	33.62	3.60	0.00	109.78	103.76	N/A	N/A
5200.00	63.48	AV	V	33.62	3.60	0.00	100.70	94.68	N/A	N/A
5150.00	27.14	PK	H	33.54	3.56	0.00	64.24	58.22	74.00	15.78
5150.00	16.34	AV	H	33.54	3.56	0.00	53.44	47.42	54.00	6.58
10400.00	40.34	PK	H	38.18	6.32	25.46	59.38	53.36	68.20	14.84
15600.00	41.63	PK	H	38.00	8.83	24.31	64.15	58.13	74.00	15.87
15600.00	30.55	AV	H	38.00	8.83	24.31	53.07	47.05	54.00	6.95
High Channel: 5240 MHz										
5240.00	82.57	PK	H	33.68	3.52	0.00	119.77	113.75	N/A	N/A
5240.00	74.37	AV	H	33.68	3.52	0.00	111.57	105.55	N/A	N/A
5240.00	71.48	PK	V	33.68	3.52	0.00	108.68	102.66	N/A	N/A
5240.00	62.82	AV	V	33.68	3.52	0.00	100.02	94	N/A	N/A
5350.00	30.52	PK	H	33.86	3.52	0.00	67.90	61.88	74.00	12.12
5350.00	19.26	AV	H	33.86	3.52	0.00	56.64	50.62	54.00	3.38
10480.00	40.00	PK	H	38.20	6.37	25.47	59.10	53.08	68.20	15.12
15720.00	38.88	PK	H	37.88	8.79	24.39	61.16	55.14	74.00	18.86
15720.00	27.88	AV	H	37.88	8.79	24.39	50.16	44.14	54.00	9.86

802.11n ht40:

Frequency (MHz)	Receiver		Rx Antenna		Cable loss (dB)	Amplifier Gain (dB)	Corrected Amplitude (dB μ V/m)	Extrapolation result (dB μ V/m)	Limit (dB μ V/m)	Margin (dB)
	Reading (dB μ V)	Detector	Polar (H/V)	Factor (dB/m)						
Low Channel: 5190 MHz										
5190.00	75.52	PK	H	33.60	3.59	0.00	112.71	106.69	N/A	N/A
5190.00	66.77	AV	H	33.60	3.59	0.00	103.96	97.94	N/A	N/A
5190.00	64.49	PK	V	33.60	3.59	0.00	101.68	95.66	N/A	N/A
5190.00	55.99	AV	V	33.60	3.59	0.00	93.18	87.16	N/A	N/A
5150.00	32.34	PK	H	33.54	3.56	0.00	69.44	63.42	74.00	10.58
5150.00	21.66	AV	H	33.54	3.56	0.00	58.76	52.74	54.00	1.26
10380.00	36.35	PK	H	38.18	6.31	25.46	55.38	49.36	68.20	18.84
15570.00	37.55	PK	H	38.03	8.84	24.29	60.13	54.11	74.00	19.89
15570.00	26.14	AV	H	38.03	8.84	24.29	48.72	42.7	54.00	11.30
High Channel: 5230 MHz										
5230.00	77.70	PK	H	33.67	3.54	0.00	114.91	108.89	N/A	N/A
5230.00	69.42	AV	H	33.67	3.54	0.00	106.63	100.61	N/A	N/A
5230.00	66.22	PK	V	33.67	3.54	0.00	103.43	97.41	N/A	N/A
5230.00	57.07	AV	V	33.67	3.54	0.00	94.28	88.26	N/A	N/A
5350.00	35.05	PK	H	33.86	3.52	0.00	72.43	66.41	74.00	7.59
5350.00	20.64	AV	H	33.86	3.52	0.00	58.02	52	54.00	2.00
10460.00	38.79	PK	H	38.19	6.36	25.47	57.87	51.85	68.20	16.35
15690.00	38.51	PK	H	37.91	8.80	24.37	60.85	54.83	74.00	19.17
15690.00	27.16	AV	H	37.91	8.80	24.37	49.50	43.48	54.00	10.52

802.11ac vht80:

Frequency (MHz)	Receiver		Rx Antenna		Cable loss (Db)	Amplifier Gain (Db)	Corrected Amplitude (dB μ V/m)	Extrapolation result (dB μ V/m)	Limit (dB μ V/m)	Margin (Db)
	Reading (dB μ V)	Detector	Polar (H/V)	Factor (Db/m)						
Middle Channel: 5210 MHz										
5210.00	70.26	PK	H	33.64	3.58	0.00	107.48	101.46	N/A	N/A
5210.00	61.29	AV	H	33.64	3.58	0.00	98.51	92.49	N/A	N/A
5210.00	59.21	PK	V	33.64	3.58	0.00	96.43	90.41	N/A	N/A
5210.00	50.01	AV	V	33.64	3.58	0.00	87.23	81.21	N/A	N/A
5150.00	33.51	PK	H	33.54	3.56	0.00	70.61	64.59	74.00	9.41
5150.00	21.69	AV	H	33.54	3.56	0.00	58.79	52.77	54.00	1.23
5350.00	32.16	PK	H	33.86	3.52	0.00	69.54	63.52	74.00	10.48
5350.00	20.16	AV	H	33.86	3.52	0.00	57.54	51.52	54.00	2.48
10420.00	35.26	PK	H	38.18	6.33	25.47	54.30	48.28	68.20	19.92
15630.00	34.14	PK	H	37.97	8.82	24.33	56.60	50.58	74.00	23.42
15630.00	22.17	AV	H	37.97	8.82	24.33	44.63	38.61	54.00	15.39

5725-5850MHz

802.11a

Frequency (MHz)	Receiver		Rx Antenna		Cable loss (dB)	Amplifier Gain (dB)	Corrected Amplitude (dB μ V/m)	Extrapolation result (dB μ V/m)	Limit (dB μ V/m)	Margin (dB)
	Reading (dB μ V)	Detector	Polar (H/V)	Factor (dB/m)						
Low Channel: 5745 MHz										
5745.00	83.10	PK	H	34.20	3.69	0.00	120.99	114.97	N/A	N/A
5745.00	74.01	AV	H	34.20	3.69	0.00	111.90	105.88	N/A	N/A
5745.00	76.36	PK	V	34.20	3.69	0.00	114.25	108.23	N/A	N/A
5745.00	65.27	AV	V	34.20	3.69	0.00	103.16	97.14	N/A	N/A
5725.00	55.00	PK	H	34.19	3.69	0.00	92.88	86.86	122.20	35.34
5720.00	41.42	PK	H	34.19	3.69	0.00	79.30	73.28	110.80	37.52
5700.00	33.22	PK	H	34.18	3.68	0.00	71.08	65.06	105.20	40.14
5650.00	32.91	PK	H	34.16	3.63	0.00	70.70	64.68	68.20	3.52
11490.00	48.26	PK	H	38.99	6.59	25.51	68.33	62.31	74.00	11.69
11490.00	36.86	AV	H	38.99	6.59	25.51	56.93	50.91	54.00	3.09
17235.00	36.67	PK	H	41.56	8.78	23.72	63.29	57.27	68.20	10.93
Middle Channel: 5785 MHz										
5785.00	80.62	PK	H	34.21	3.71	0.00	118.54	112.52	N/A	N/A
5785.00	71.53	AV	H	34.21	3.71	0.00	109.45	103.43	N/A	N/A
5785.00	73.88	PK	V	34.21	3.71	0.00	111.80	105.78	N/A	N/A
5785.00	62.79	AV	V	34.21	3.71	0.00	100.71	94.69	N/A	N/A
11570.00	44.83	PK	H	39.00	6.61	25.46	64.98	58.96	74.00	15.04
11570.00	33.04	AV	H	39.00	6.61	25.46	53.19	47.17	54.00	6.83
17355.00	38.11	PK	H	42.26	8.81	23.60	65.58	59.56	68.20	8.64
High Channel: 5825 MHz										
5825.00	76.43	PK	H	34.23	3.73	0.00	114.39	108.37	N/A	N/A
5825.00	67.50	AV	H	34.23	3.73	0.00	105.46	99.44	N/A	N/A
5825.00	66.08	PK	V	34.23	3.73	0.00	104.04	98.02	N/A	N/A
5825.00	57.16	AV	V	34.23	3.73	0.00	95.12	89.1	N/A	N/A
5850.00	33.94	PK	H	34.24	3.75	0.00	71.93	65.91	122.20	56.29
5855.00	33.65	PK	H	34.24	3.75	0.00	71.64	65.62	110.80	45.18
5875.00	33.50	PK	H	34.25	3.77	0.00	71.52	65.5	105.20	39.70
5925.00	32.62	PK	H	34.27	3.80	0.00	70.69	64.67	68.20	3.53
11650.00	42.35	PK	H	39.00	6.64	25.41	62.58	56.56	74.00	17.44
11650.00	30.56	AV	H	39.00	6.64	25.41	50.79	44.77	54.00	9.23
17475.00	35.63	PK	H	42.96	8.84	23.48	63.95	57.93	68.20	10.27

802.11n ht20:

Frequency (MHz)	Receiver		Rx Antenna		Cable loss (dB)	Amplifier Gain (dB)	Corrected Amplitude (dBµV/m)	Extrapolation result (dBµV/m)	Limit (dBµV/m)	Margin (dB)
	Reading (dBµV)	Detector	Polar (H/V)	Factor (dB/m)						
Low Channel: 5745 MHz										
5745.00	81.46	PK	H	34.20	3.69	0.00	119.35	113.33	N/A	N/A
5745.00	72.78	AV	H	34.20	3.69	0.00	110.67	104.65	N/A	N/A
5745.00	71.69	PK	V	34.20	3.69	0.00	109.58	103.56	N/A	N/A
5745.00	62.49	AV	V	34.20	3.69	0.00	100.38	94.36	N/A	N/A
5725.00	52.48	PK	H	34.19	3.69	0.00	90.36	84.34	122.20	37.86
5720.00	41.21	PK	H	34.19	3.69	0.00	79.09	73.07	110.80	37.73
5700.00	34.52	PK	H	34.18	3.68	0.00	72.38	66.36	105.20	38.84
5650.00	33.12	PK	H	34.16	3.63	0.00	70.91	64.89	68.20	3.31
11490.00	43.25	PK	H	38.99	6.59	25.51	63.32	57.3	74.00	16.70
11490.00	32.04	AV	H	38.99	6.59	25.51	52.11	46.09	54.00	7.91
17235.00	36.02	PK	H	41.56	8.78	23.72	62.64	56.62	68.20	11.58
Middle Channel: 5785 MHz										
5785.00	79.62	PK	H	34.21	3.71	0.00	117.54	111.52	N/A	N/A
5785.00	70.92	AV	H	34.21	3.71	0.00	108.84	102.82	N/A	N/A
5785.00	69.83	PK	V	34.21	3.71	0.00	107.75	101.73	N/A	N/A
5785.00	60.65	AV	V	34.21	3.71	0.00	98.57	92.55	N/A	N/A
11570.00	41.26	PK	H	39.00	6.61	25.46	61.41	55.39	74.00	18.61
11570.00	29.35	AV	H	39.00	6.61	25.46	49.50	43.48	54.00	10.52
17355.00	35.94	PK	H	42.26	8.81	23.60	63.41	57.39	68.20	10.81
High Channel: 5825 MHz										
5825.00	75.21	PK	H	34.23	3.73	0.00	113.17	107.15	N/A	N/A
5825.00	66.92	AV	H	34.23	3.73	0.00	104.88	98.86	N/A	N/A
5825.00	64.58	PK	V	34.23	3.73	0.00	102.54	96.52	N/A	N/A
5825.00	55.61	AV	V	34.23	3.73	0.00	93.57	87.55	N/A	N/A
5850.00	33.89	PK	H	34.24	3.75	0.00	71.88	65.86	122.20	56.34
5855.00	33.74	PK	H	34.24	3.75	0.00	71.73	65.71	110.80	45.09
5875.00	33.56	PK	H	34.25	3.77	0.00	71.58	65.56	105.20	39.64
5925.00	33.42	PK	H	34.27	3.80	0.00	71.49	65.47	68.20	2.73
11650.00	37.62	PK	H	39.00	6.64	25.41	57.85	51.83	74.00	22.17
11650.00	26.58	AV	H	39.00	6.64	25.41	46.81	40.79	54.00	13.21
17475.00	35.66	PK	H	42.96	8.84	23.48	63.98	57.96	68.20	10.24

802.11n ht40:

Frequency (MHz)	Receiver		Rx Antenna		Cable loss (dB)	Amplifier Gain (dB)	Corrected Amplitude (dB μ V/m)	Extrapolation result (dB μ V/m)	Limit (dB μ V/m)	Margin (dB)
	Reading (dB μ V)	Detector	Polar (H/V)	Factor (dB/m)						
Low Channel: 5755 MHz										
5755.00	78.45	PK	H	34.20	3.70	0.00	116.35	110.33	N/A	N/A
5755.00	69.42	AV	H	34.20	3.70	0.00	107.32	101.3	N/A	N/A
5755.00	68.56	PK	V	34.20	3.70	0.00	106.46	100.44	N/A	N/A
5755.00	59.62	AV	V	34.20	3.70	0.00	97.52	91.5	N/A	N/A
5725.00	53.02	PK	H	34.19	3.69	0.00	90.90	84.88	122.20	37.32
5720.00	51.03	PK	H	34.19	3.69	0.00	88.91	82.89	110.80	27.91
5700.00	35.48	PK	H	34.18	3.68	0.00	73.34	67.32	105.20	37.88
5650.00	33.17	PK	H	34.16	3.63	0.00	70.96	64.94	68.20	3.26
11510.00	40.25	PK	H	39.00	6.59	25.50	60.34	54.32	74.00	19.68
11510.00	28.21	AV	H	39.00	6.59	25.50	48.30	42.28	54.00	11.72
17265.00	35.68	PK	H	41.74	8.79	23.69	62.52	56.5	68.20	11.70
High Channel: 5795 MHz										
5795.00	78.79	PK	H	34.22	3.71	0.00	116.72	110.7	N/A	N/A
5795.00	69.36	AV	H	34.22	3.71	0.00	107.29	101.27	N/A	N/A
5795.00	68.59	PK	V	34.22	3.71	0.00	106.52	100.5	N/A	N/A
5795.00	59.74	AV	V	34.22	3.71	0.00	97.67	91.65	N/A	N/A
5850.00	36.69	PK	H	34.24	3.75	0.00	74.68	68.66	122.20	53.54
5855.00	35.17	PK	H	34.24	3.75	0.00	73.16	67.14	110.80	43.66
5875.00	34.11	PK	H	34.25	3.77	0.00	72.13	66.112	105.20	39.09
5925.00	33.36	PK	H	34.27	3.80	0.00	71.43	65.41	68.20	2.79
11590.00	39.21	PK	H	39.00	6.62	25.45	59.38	53.36	74.00	20.64
11590.00	27.16	AV	H	39.00	6.62	25.45	47.33	41.31	54.00	12.69
17385.00	36.24	PK	H	42.43	8.82	23.57	63.92	57.9	68.20	10.30

802.11ac vht80:

Frequency (MHz)	Receiver		Rx Antenna		Cable loss (dB)	Amplifier Gain (dB)	Corrected Amplitude (dBμV/m)	Extrapolation result (dBμV/m)	Limit (dBμV/m)	Margin (dB)
	Reading (dBμV)	Detector	Polar (H/V)	Factor (dB/m)						
Middle Channel: 5775 MHz										
5775.00	74.47	PK	H	34.21	3.70	0.00	112.38	106.36	N/A	N/A
5775.00	66.77	AV	H	34.21	3.70	0.00	104.68	98.66	N/A	N/A
5775.00	65.17	PK	V	34.21	3.70	0.00	103.08	97.06	N/A	N/A
5775.00	56.97	AV	V	34.21	3.70	0.00	94.88	88.86	N/A	N/A
5725.00	50.42	PK	H	34.19	3.69	0.00	88.30	82.28	122.20	39.92
5720.00	49.32	PK	H	34.19	3.69	0.00	87.20	81.18	110.80	29.62
5700.00	46.25	PK	H	34.18	3.68	0.00	84.11	78.09	105.20	27.11
5650.00	33.12	PK	H	34.16	3.63	0.00	70.91	64.89	68.20	3.31
5850.00	48.23	PK	H	34.24	3.75	0.00	86.22	80.2	122.20	42.00
5855.00	47.02	PK	H	34.24	3.75	0.00	85.01	78.99	110.80	31.81
5875.00	41.25	PK	H	34.25	3.77	0.00	79.27	73.25	105.20	31.95
5925.00	33.94	PK	H	34.27	3.80	0.00	72.01	65.99	68.20	2.21
11550.00	36.15	PK	H	39.00	6.61	25.48	56.28	50.26	74.00	23.74
11550.00	24.16	AV	H	39.00	6.61	25.48	44.29	38.27	54.00	15.73
17325.00	36.25	PK	H	42.09	8.80	23.63	63.51	57.49	68.20	10.71

Test Plots(802.11a mode 5745MHz was the worst)

Horizontal

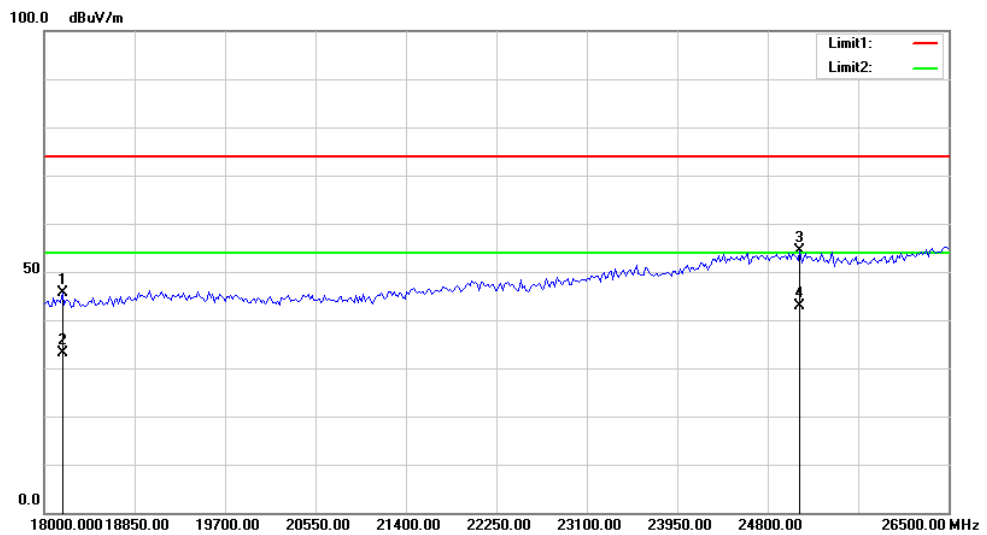
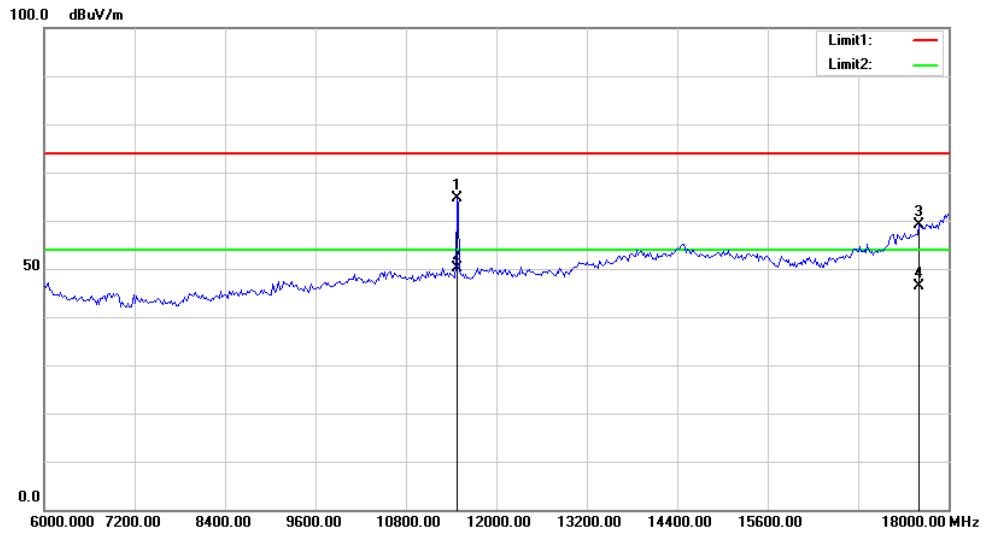
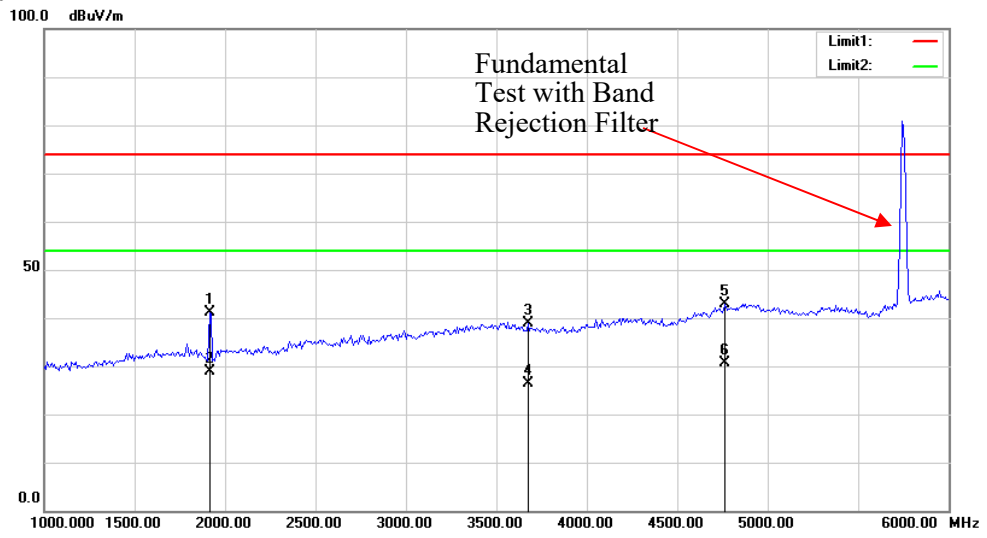

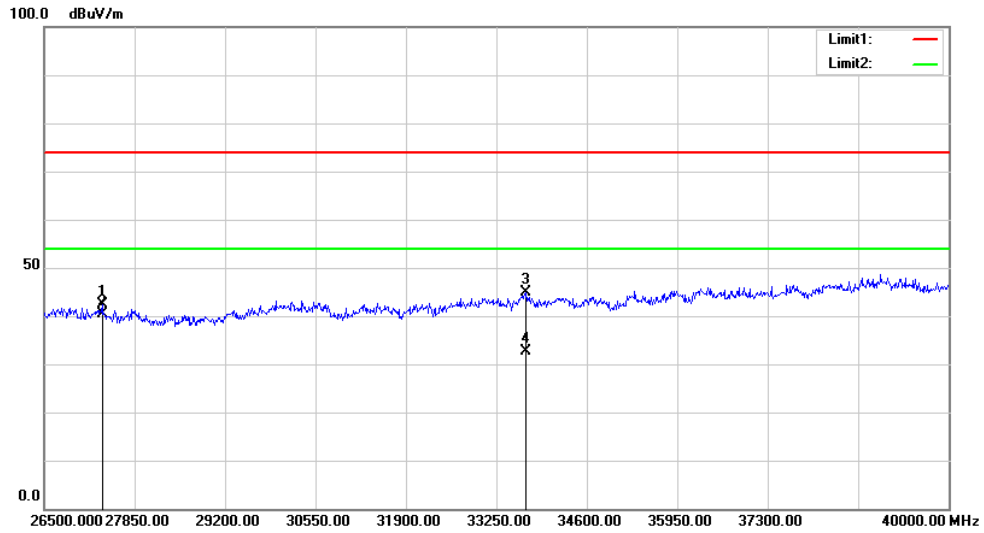

Vertical

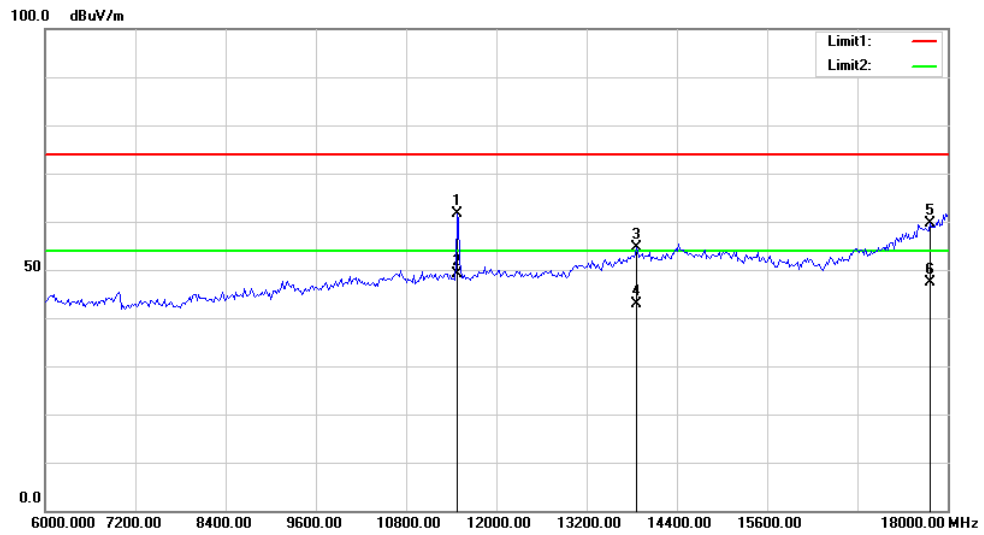
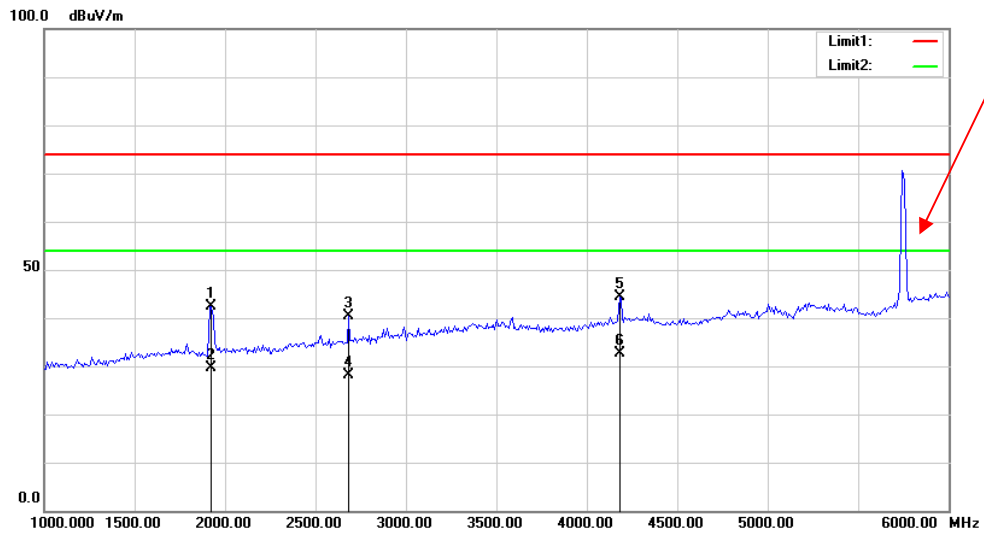

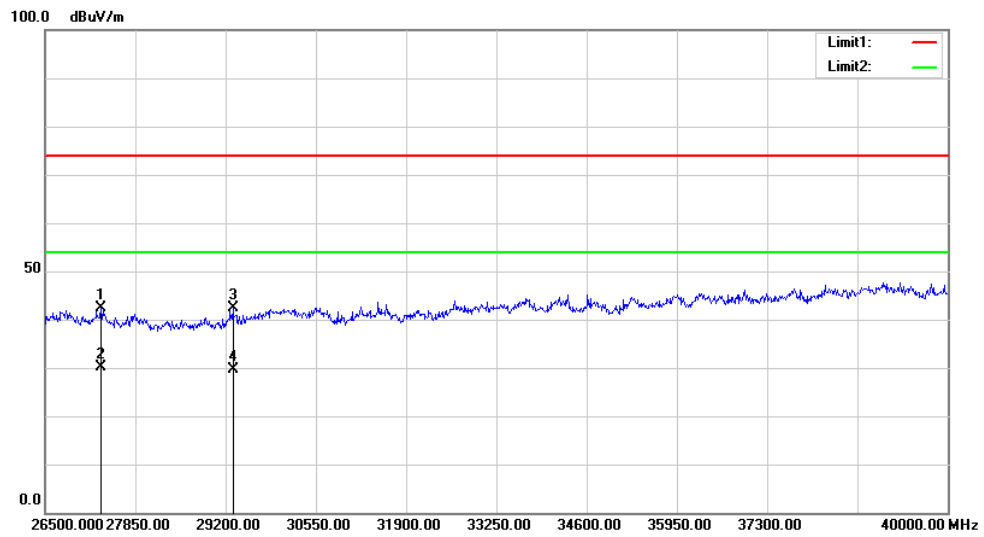
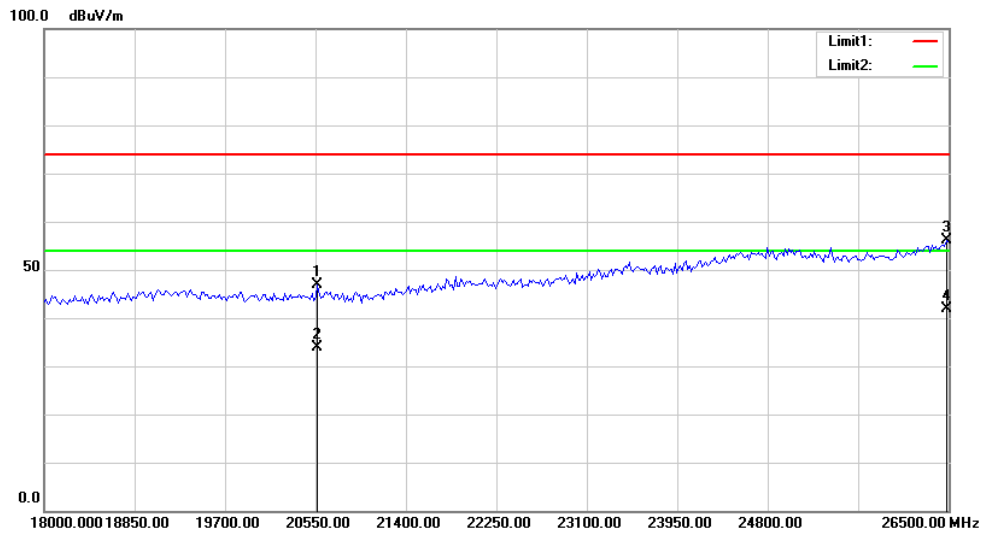

FCC §15.407(a)(e)–EMISSION BANDWIDTH AND OCCUPIED BANDWIDTH

Applicable Standard

15.407(a) (e).

Test Equipment List and Details

Manufacturer	Description	Model	Serial Number	Calibration Date	Calibration Due Date
R&S	Spectrum Analyzer	FSV40	101474	2020-07-07	2021-07-07
Unknown	Coaxial Cable	C-SJ00-0010	C0010/01	Each time	N/A

* **Statement of Traceability:** Bay Area Compliance Laboratories Corp. (Dongguan) attests that all calibrations have been performed, traceable to National Primary Standards and International System of Units (SI).

Test Procedure

According to KDB 789033 D02 General UNII Test Procedures New Rules v02r01

Test Data

Environmental Conditions

Temperature:	26.9 °C
Relative Humidity:	46 %
ATM Pressure:	100.2~100.3 kPa
Test by:	JOE Qiao
Test Date:	2021-06-16~2021-06-30

Test Result: Pass.

Please refer to the following tables and plots.

Test mode: Transmitting (test was only performed at chain 0)

5150-5250MHz:

Mode	Frequency (MHz)	26 dB Emission Bandwidth (MHz)	99% Occupied Bandwidth (MHz)
802.11 a	5180	25.283	17.405
	5200	25.839	17.246
	5240	25.985	17.246
802.11n ht20	5180	27.445	18.363
	5200	26.895	18.363
	5240	27.988	18.363
802.11n ht40	5190	49.381	37.206
	5230	48.280	37.046
802.11ac vht80	5210	96.271	77.285

5725-5850MHz:

Mode	Frequency (MHz)	6 dB Emission Bandwidth (MHz)	6 dB Emission Bandwidth Limits (MHz)	99% Occupied Bandwidth (MHz)
802.11 a	5745	16.489	≥0.5	19.401
	5785	17.66	≥0.5	19.721
	5825	17.53	≥0.5	17.246
802.11n ht20	5745	17.638	≥0.5	18.762
	5785	17.652	≥0.5	18.842
	5825	17.486	≥0.5	18.363
802.11n ht40	5755	36.37	≥0.5	37.206
	5795	36.36	≥0.5	37.046
802.11ac vht80	5775	76.41	≥0.5	79.202

Note: the 99% Occupied Bandwidth have not fall into the band 5250-5350MHz or 5470-5725MHz, please refer to the test plots of 99% Occupied Bandwidth.

**5150-5250MHz:
26dB Emission Bandwidth:**

802.11a Low Channel



Date: 16.JUN.2021 13:41:55

802.11a Middle Channel

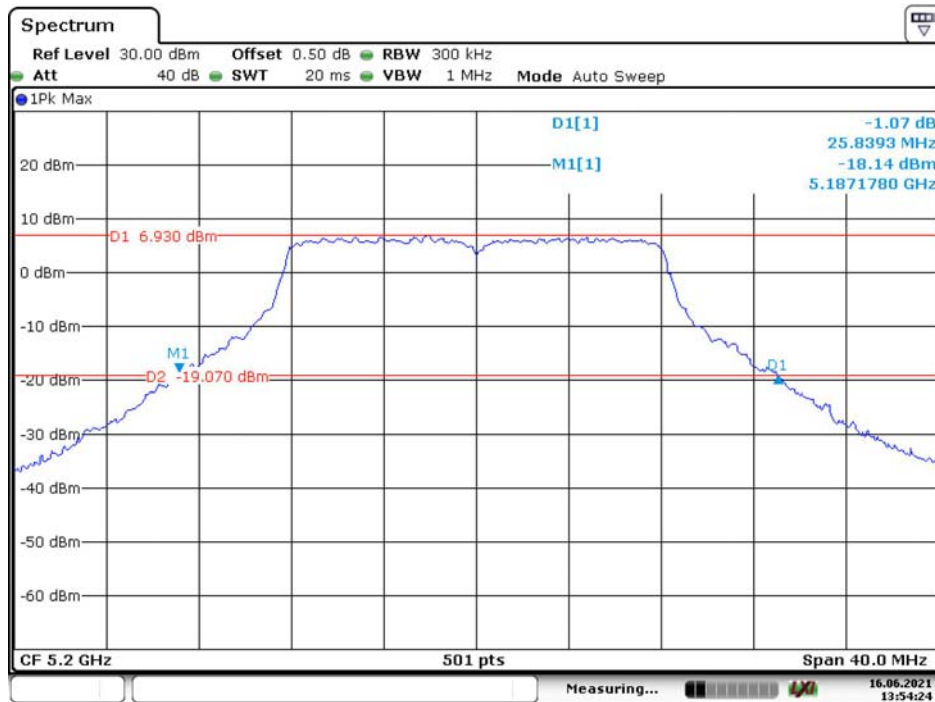

Date: 16.JUN.2021 13:54:25

802.11a High Channel

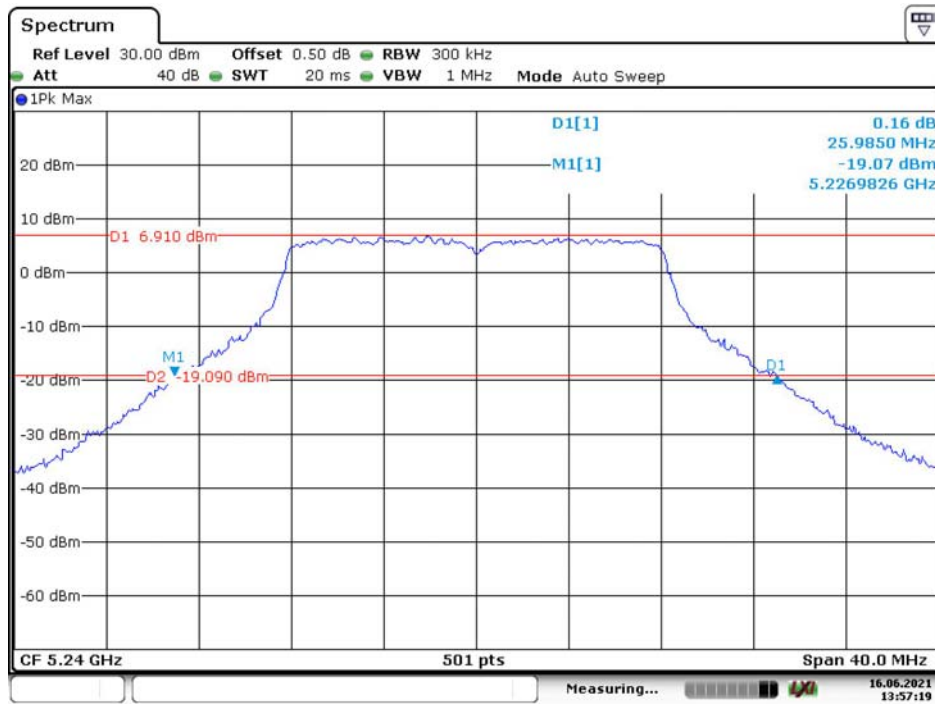

802.11n ht20 Low Channel

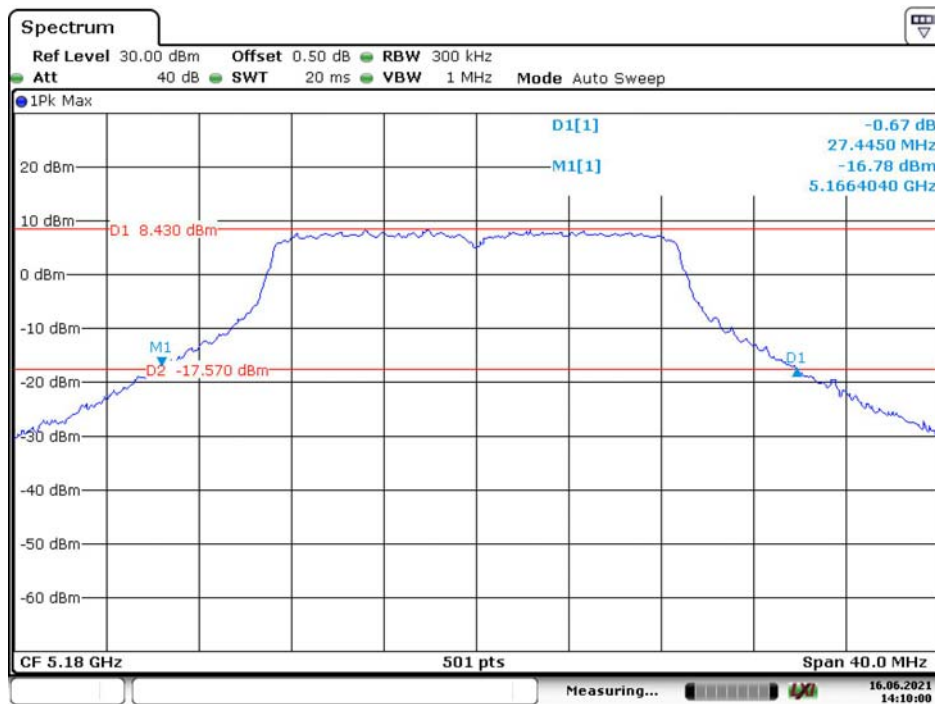

802.11n ht20 Middle Channel

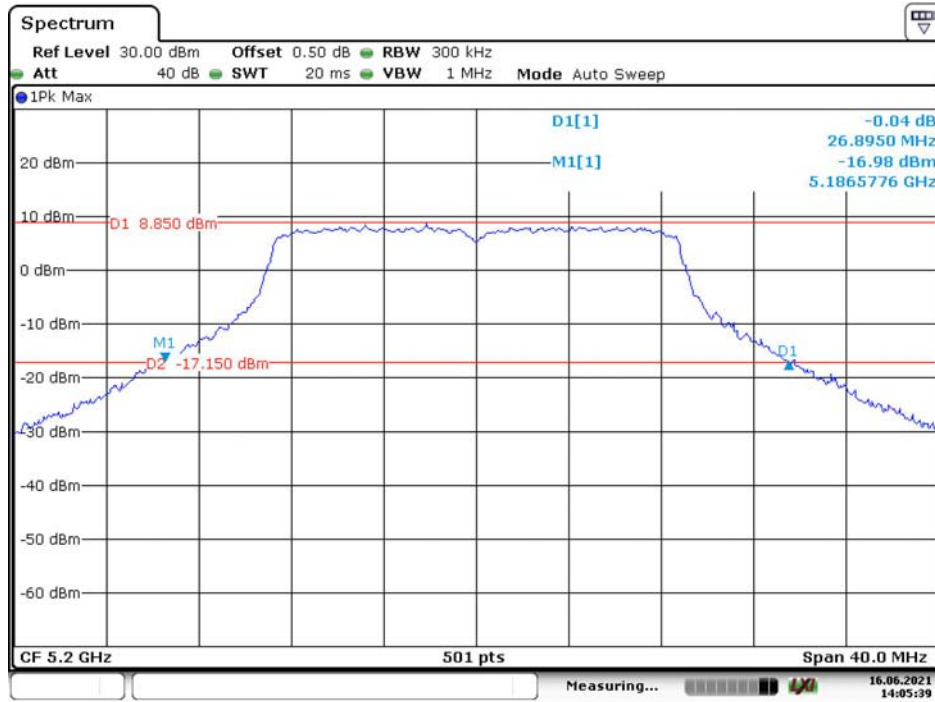

Date: 16.JUN.2021 14:05:39

802.11n ht20 High Channel

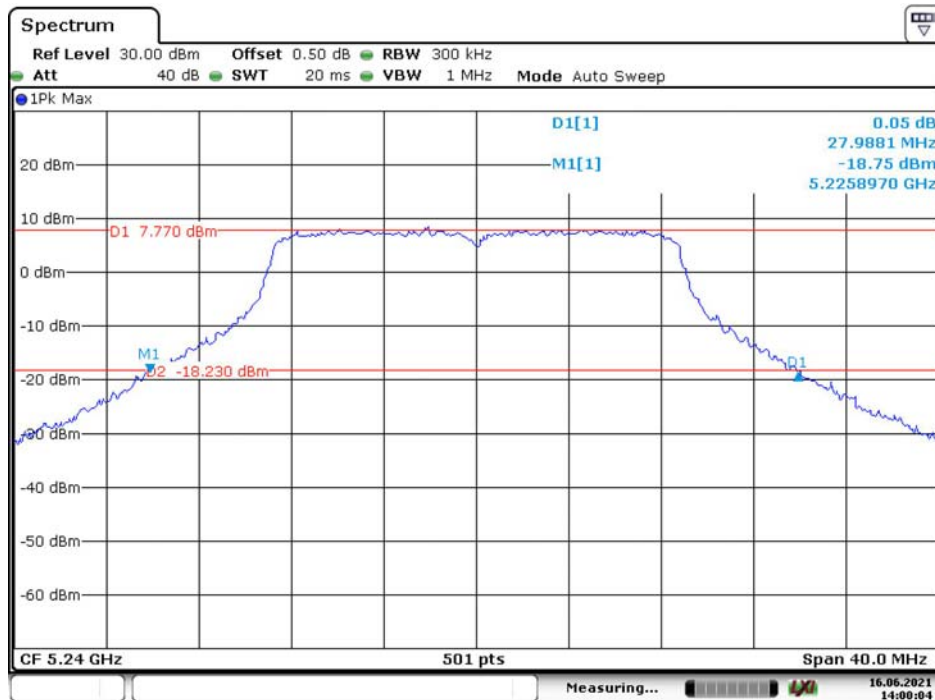

Date: 16.JUN.2021 14:00:04

802.11n ht40 Low Channel



Date: 16.JUN.2021 14:19:16

802.11n ht40 High Channel

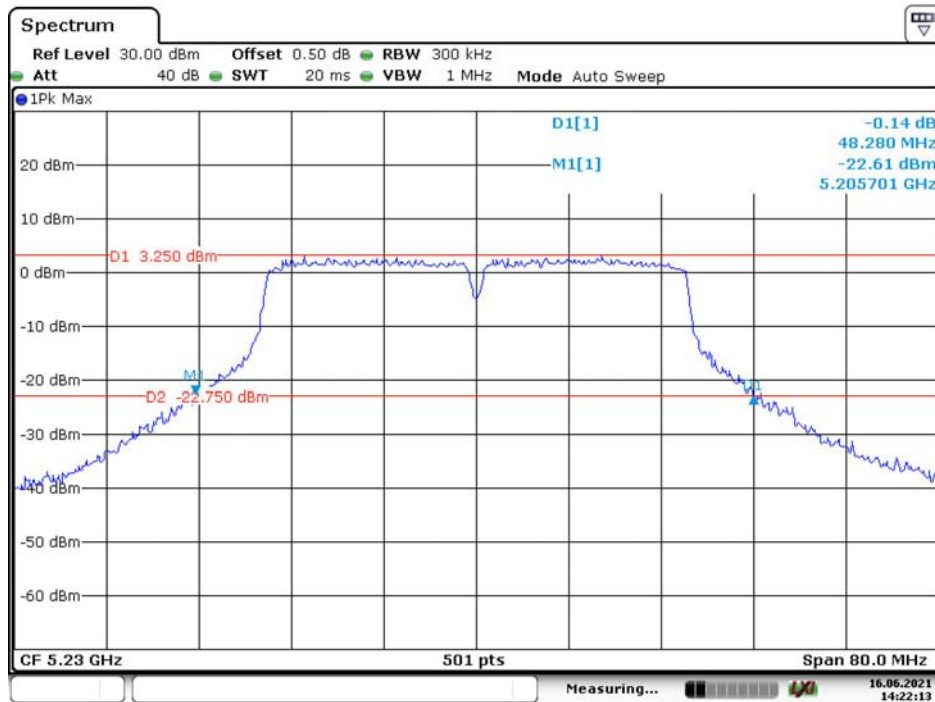

Date: 16.JUN.2021 14:22:13

802.11ac vht80 Middle Channel

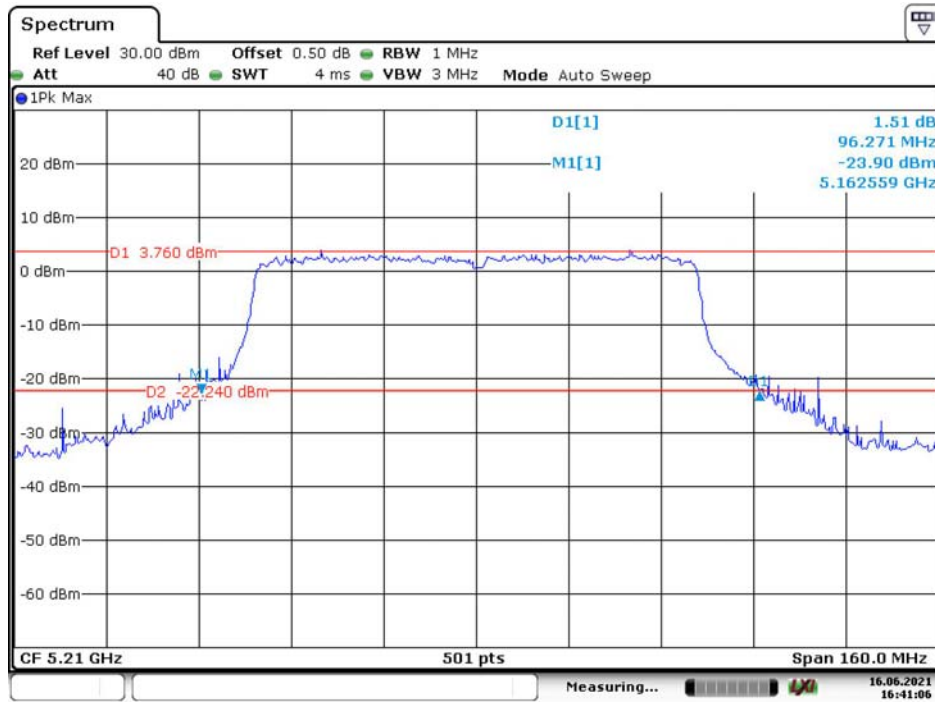

Date: 16.JUN.2021 16:41:06

99% Occupied Bandwidth:

802.11a Low Channel



Date: 16.JUN.2021 15:55:00

802.11a Middle Channel



Date: 16.JUN.2021 15:55:45

802.11a High Channel

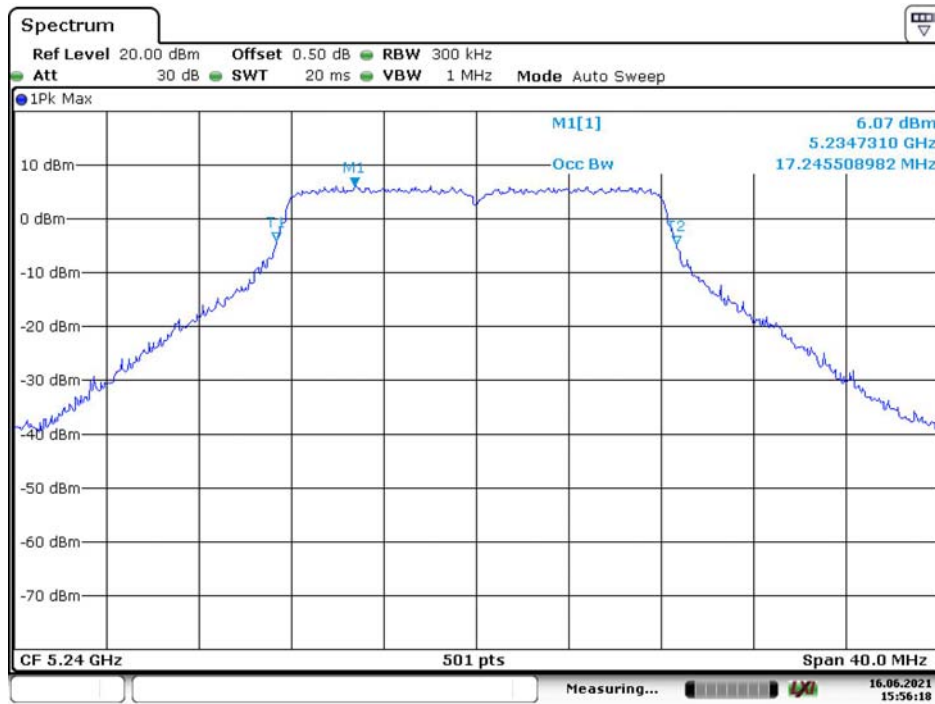

Date: 16.JUN.2021 15:56:18

802.11n ht20 Low Channel

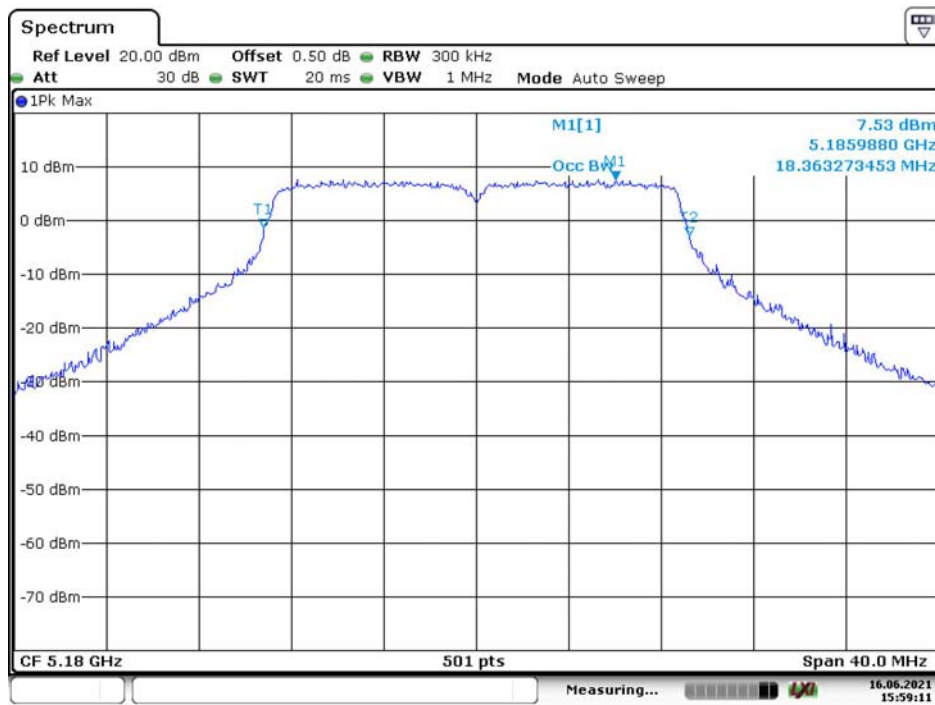

Date: 16.JUN.2021 15:59:10

802.11n ht20 Middle Channel

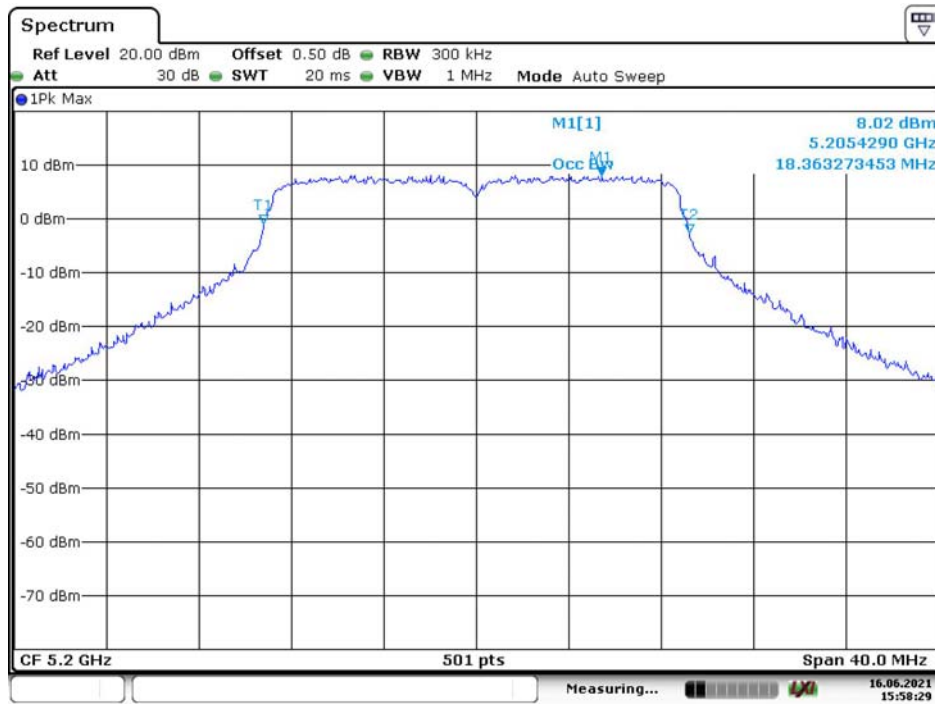

Date: 16.JUN.2021 15:58:29

802.11n ht20 High Channel

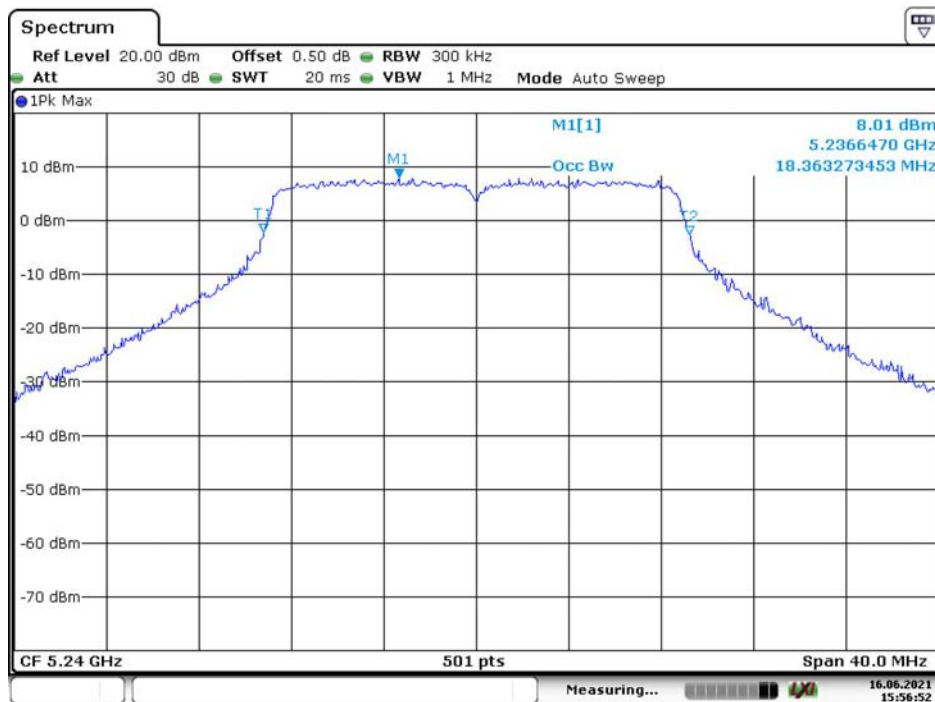

Date: 16.JUN.2021 15:56:52

802.11n ht40 Low Channel

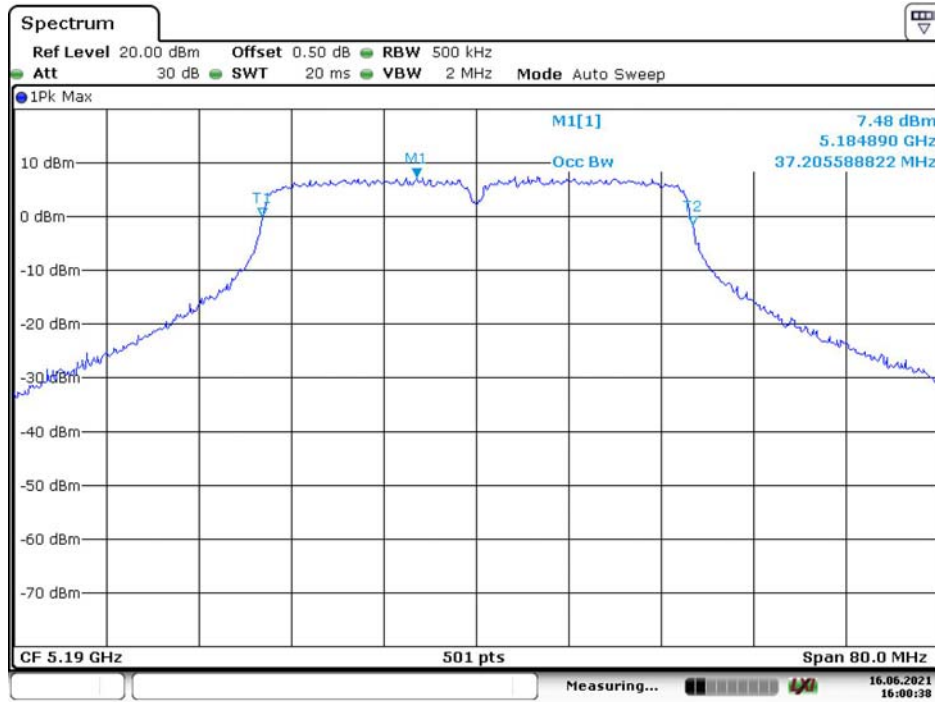

802.11n ht40 High Channel

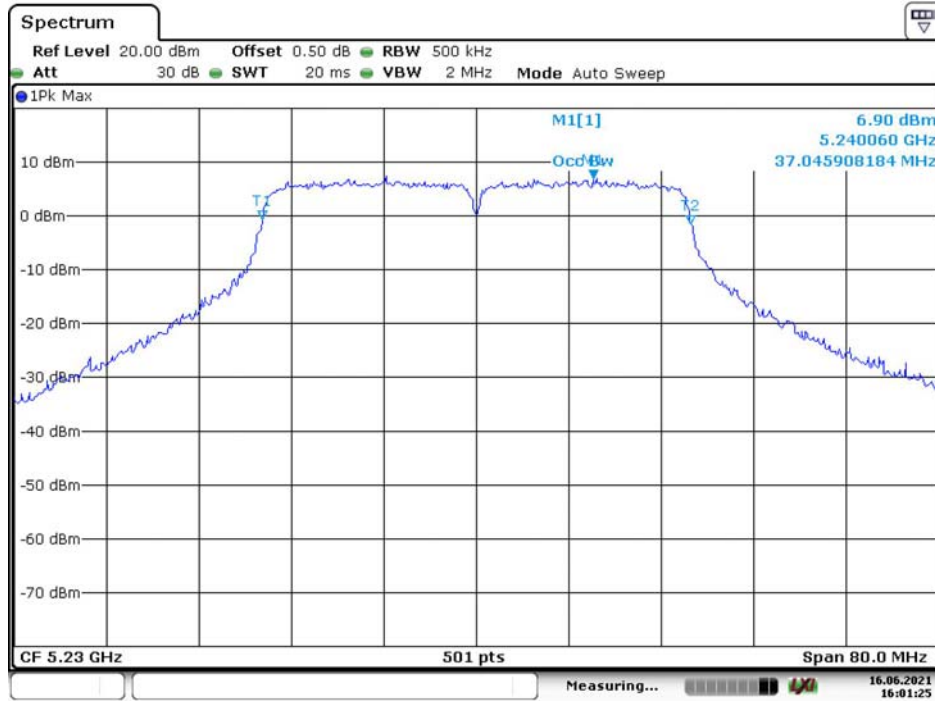

802.11ac vht80 Middle Channel

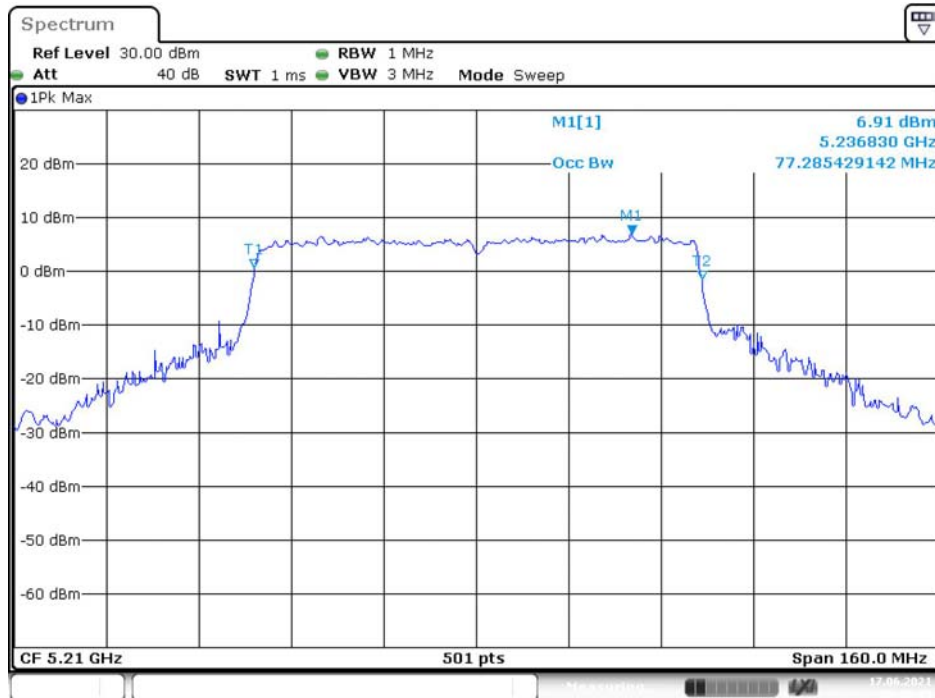

Date: 17.JUN.2021 09:30:35

5725-5850MHz:
6dB Emission Bandwidth:

802.11a Low Channel

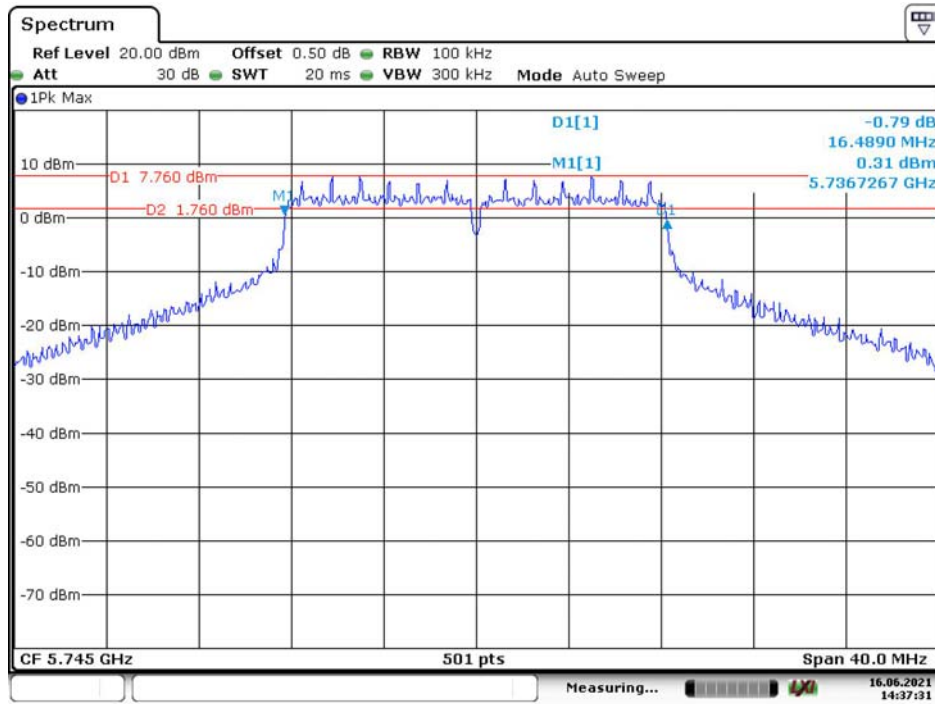

Date: 16.JUN.2021 14:37:30

802.11a Middle Channel

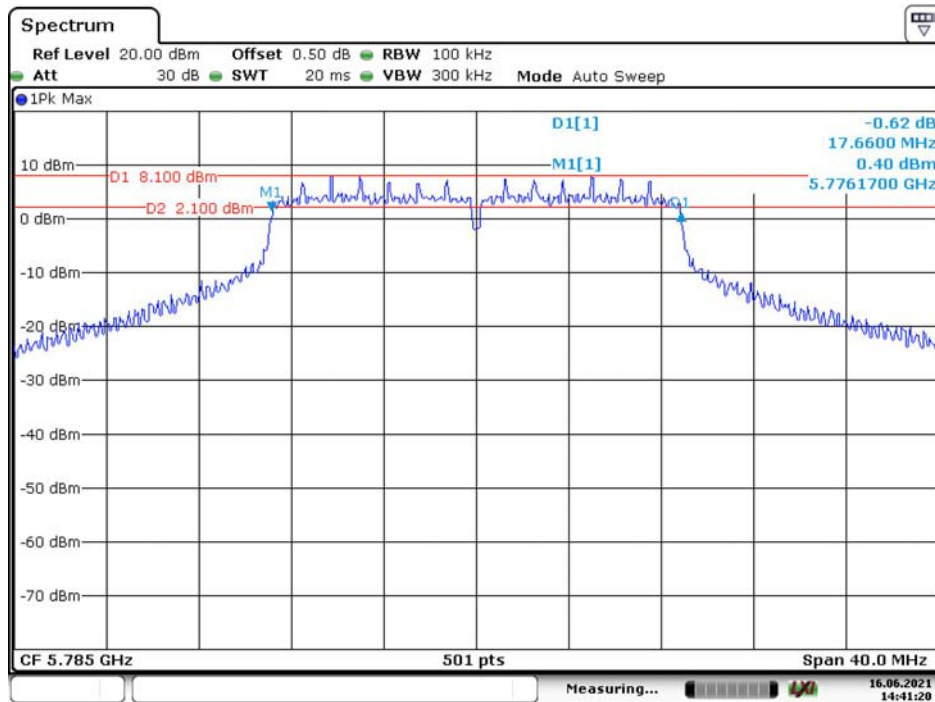

Date: 16.JUN.2021 14:41:20

802.11a High Channel

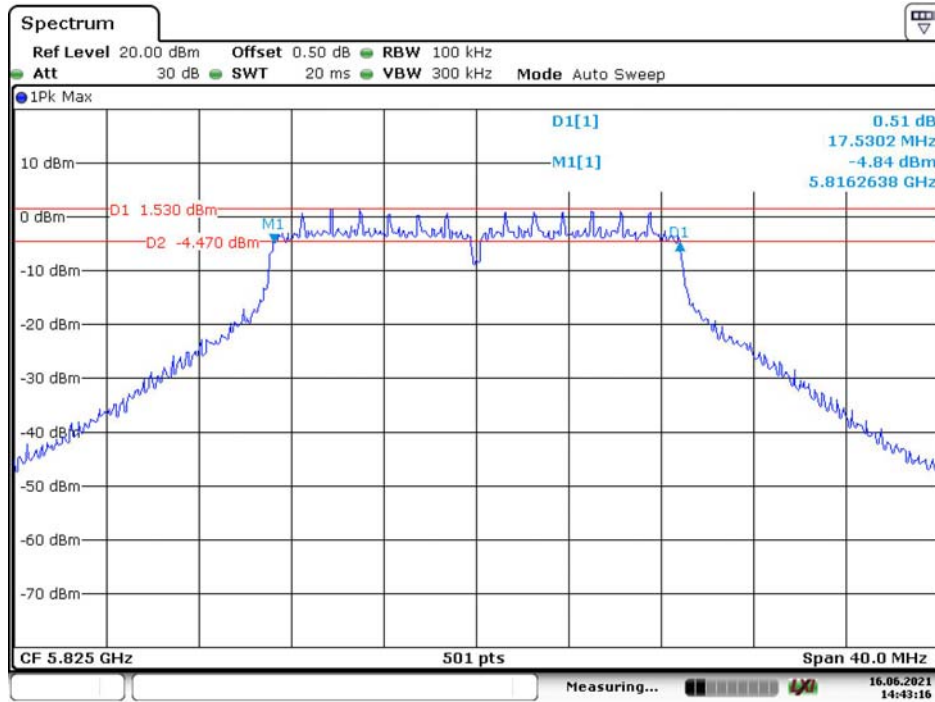

Date: 16.JUN.2021 14:43:16

802.11n ht20 Low Channel

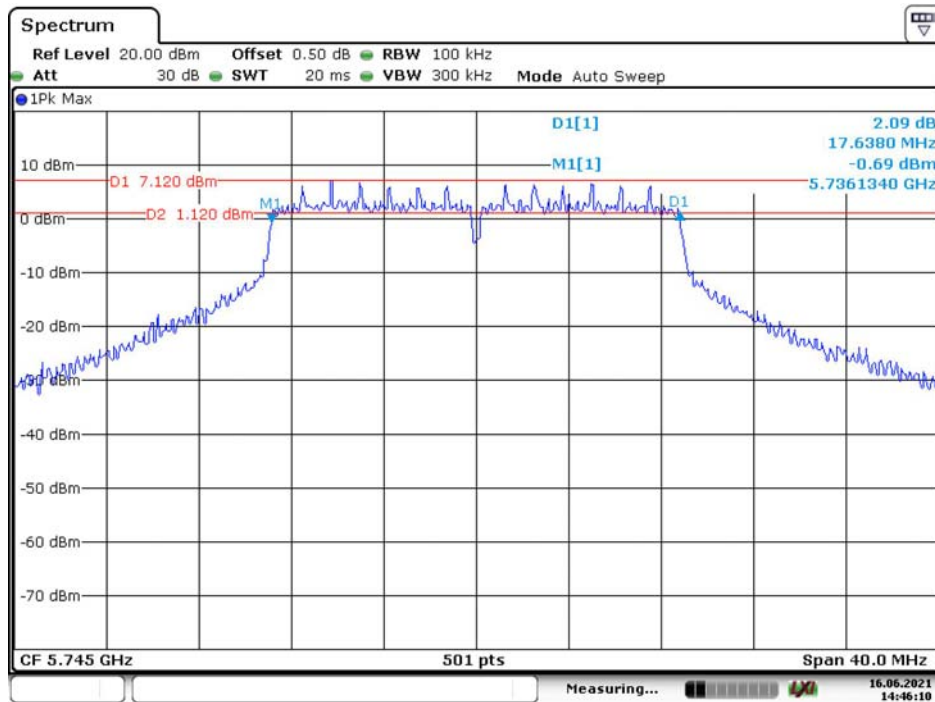

Date: 16.JUN.2021 14:46:10

802.11n ht20 Middle Channel

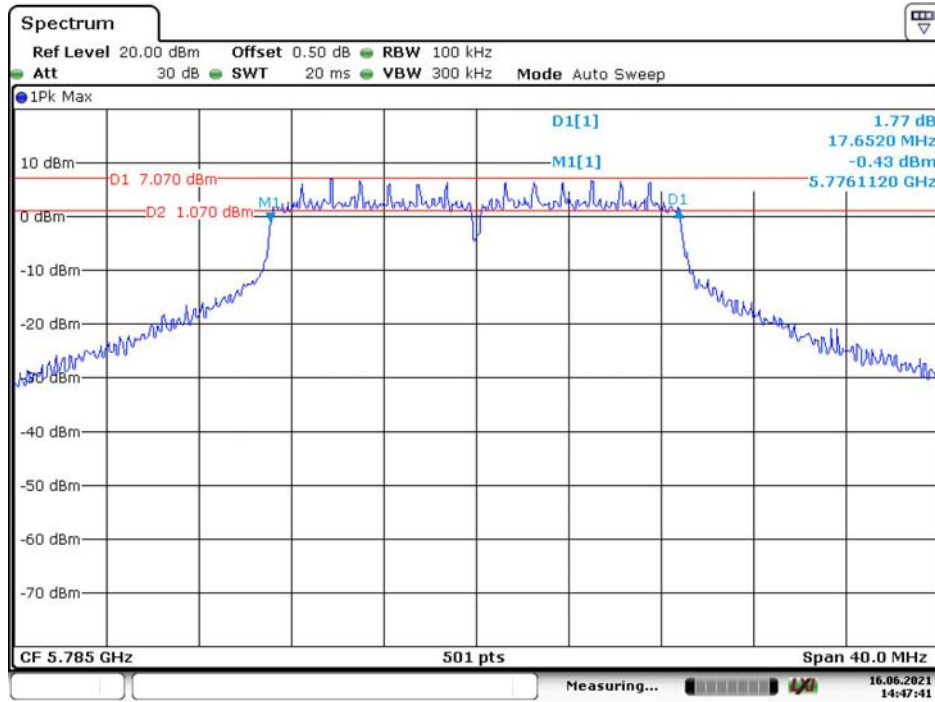

Date: 16.JUN.2021 14:47:41

802.11n ht20 High Channel

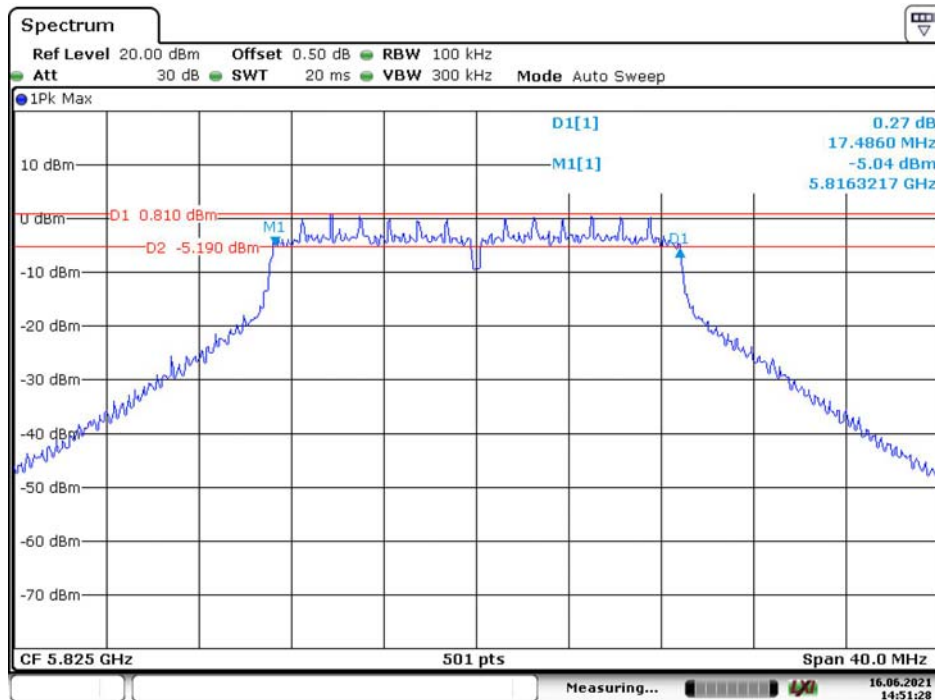

Date: 16.JUN.2021 14:51:28

802.11n ht40 Low Channel

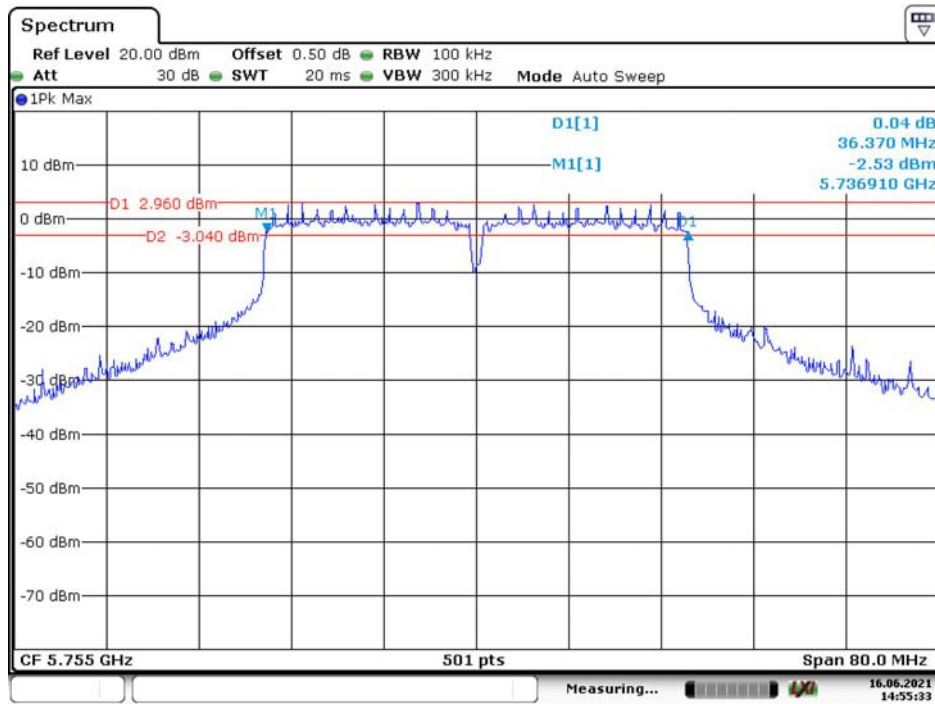

Date: 16.JUN.2021 14:55:33

802.11n ht40 High Channel

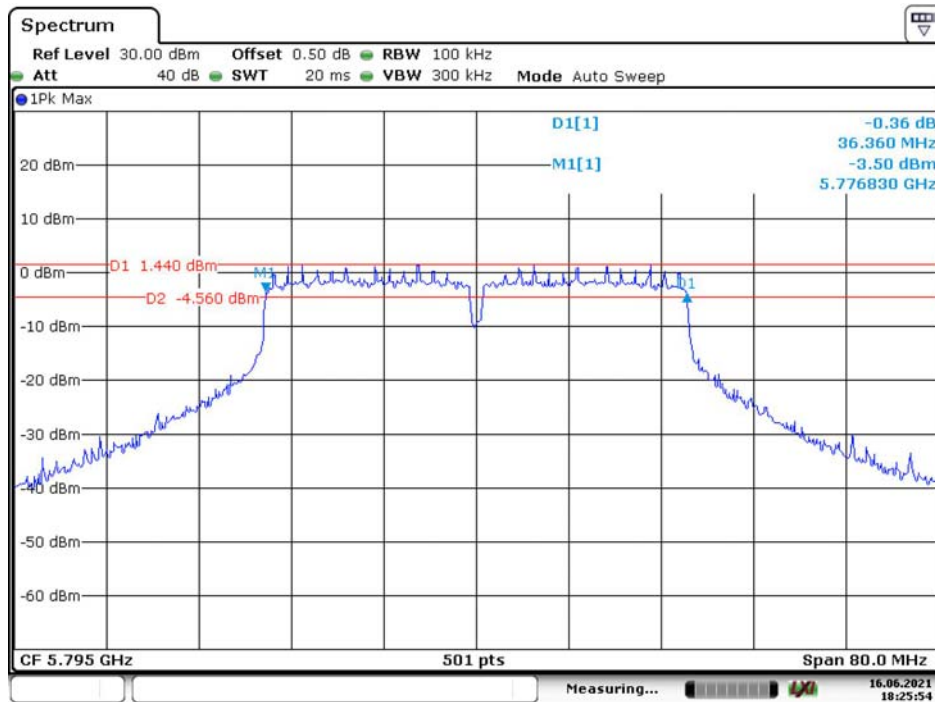

Date: 16.JUN.2021 18:25:54

802.11ac vht80 Middle Channel

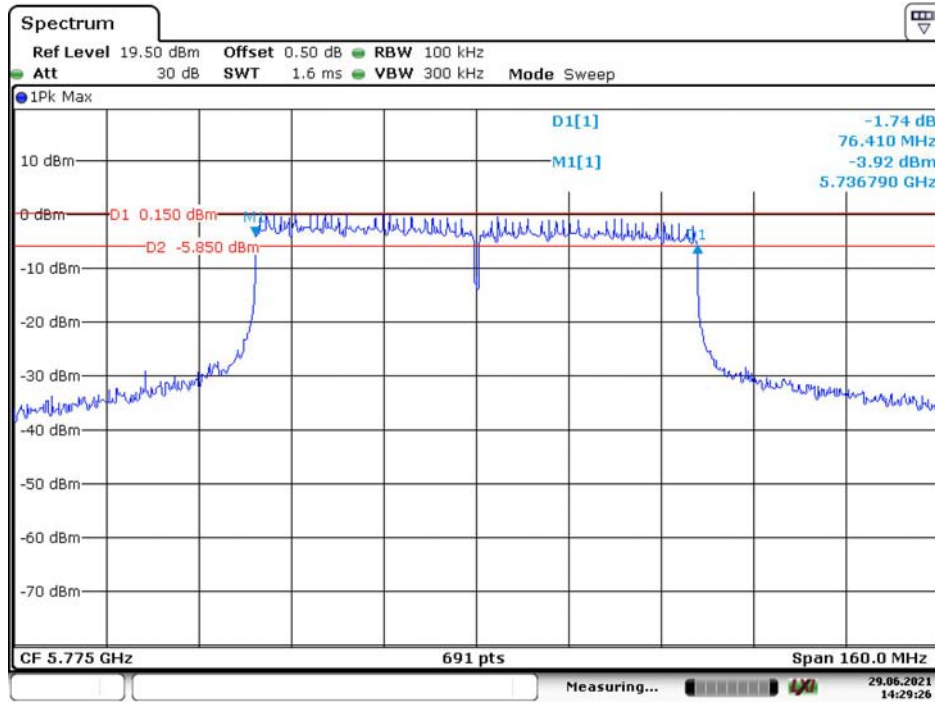

Date: 29.JUN.2021 14:29:25

99% Occupied Bandwidth:

802.11a Low Channel



Date: 16.JUN.2021 16:02:40

802.11a Middle Channel

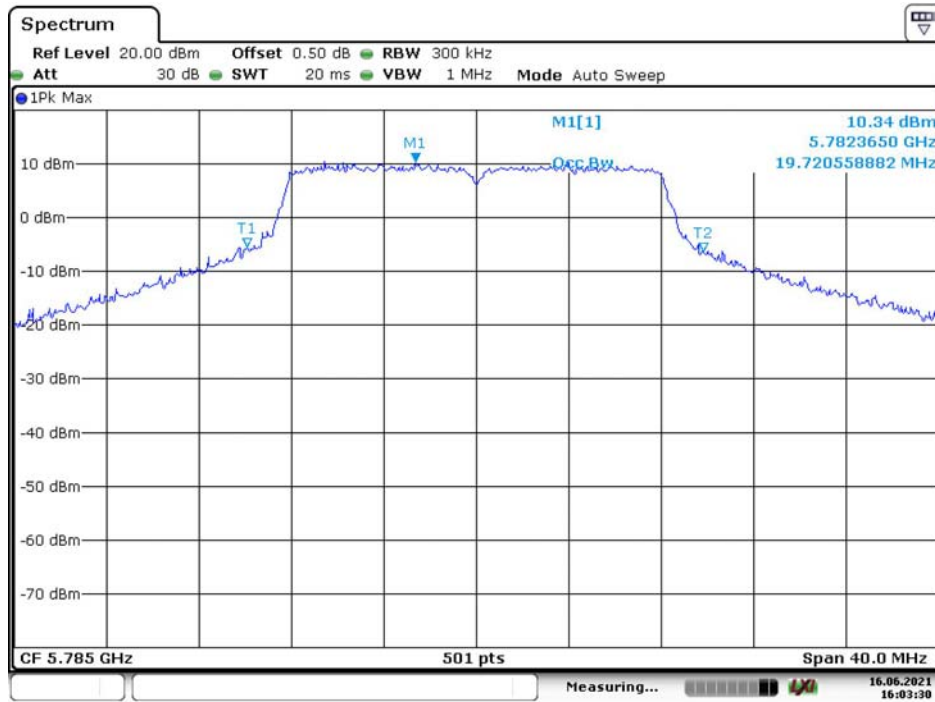

Date: 16.JUN.2021 16:03:30

802.11a High Channel



Date: 16.JUN.2021 16:04:22

802.11n ht20 Low Channel



Date: 16.JUN.2021 16:08:10

802.11n ht20 Middle Channel

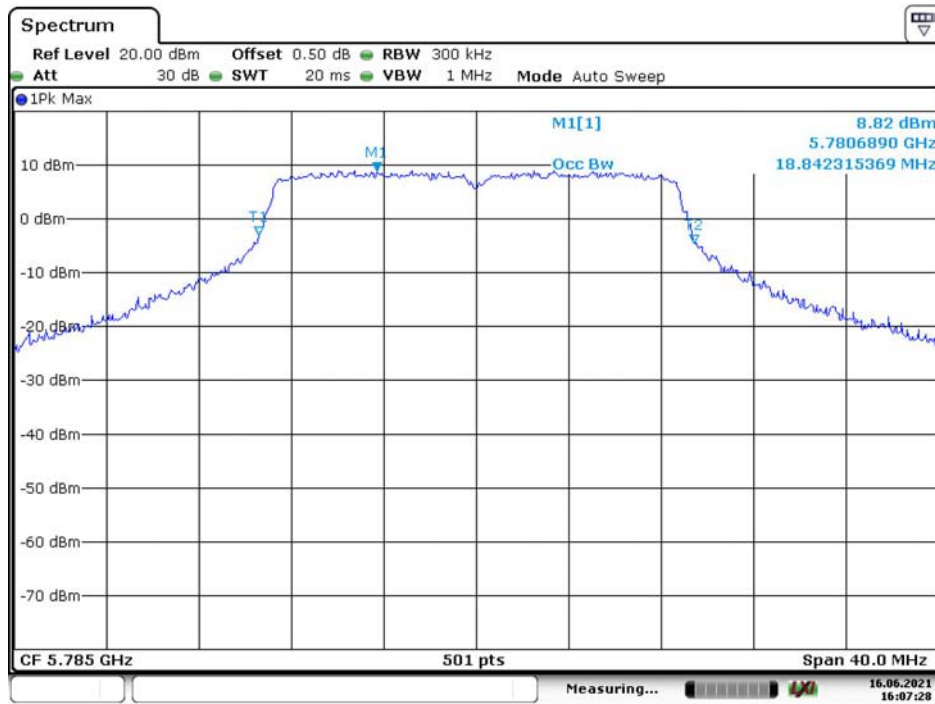

Date: 16.JUN.2021 16:07:28

802.11n ht20 High Channel

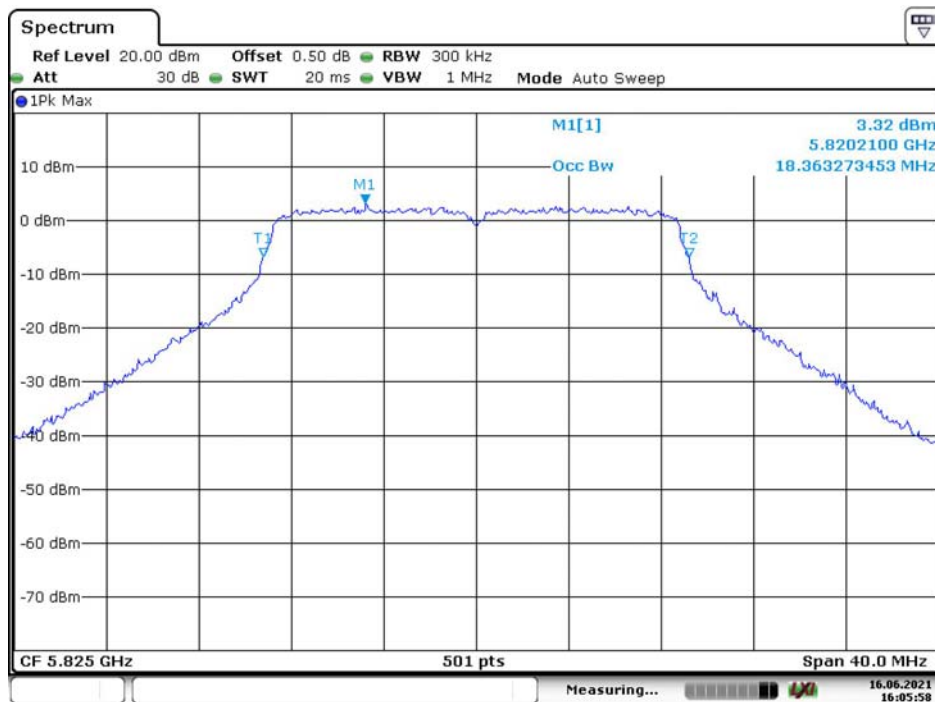

Date: 16.JUN.2021 16:05:58

802.11n ht40 Low Channel



Date: 16.JUN.2021 17:51:18

802.11n ht40 High Channel

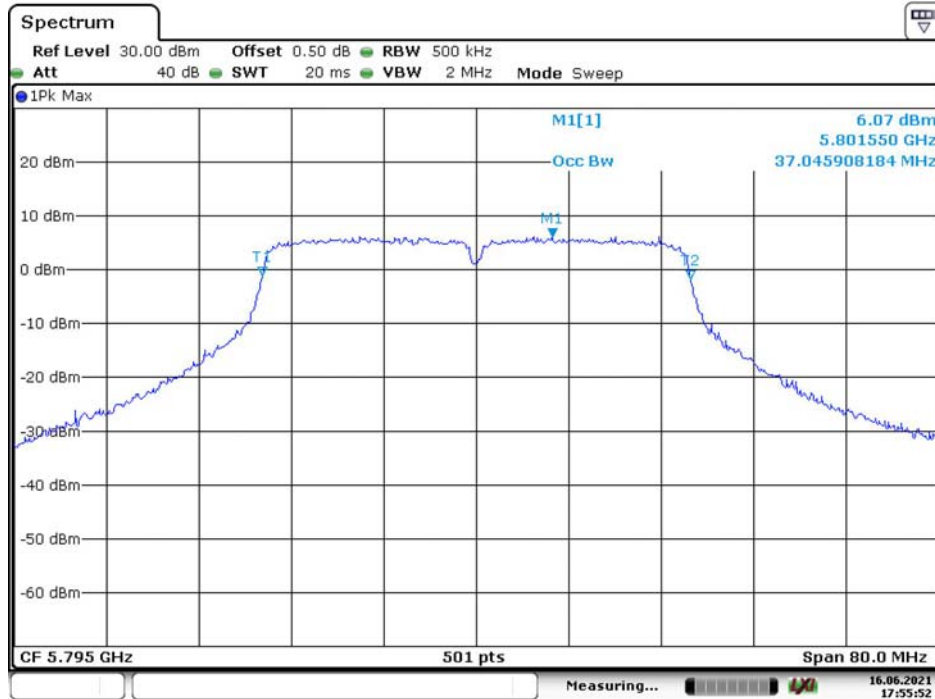

Date: 16.JUN.2021 17:55:53

802.11ac vht80 Middle Channel

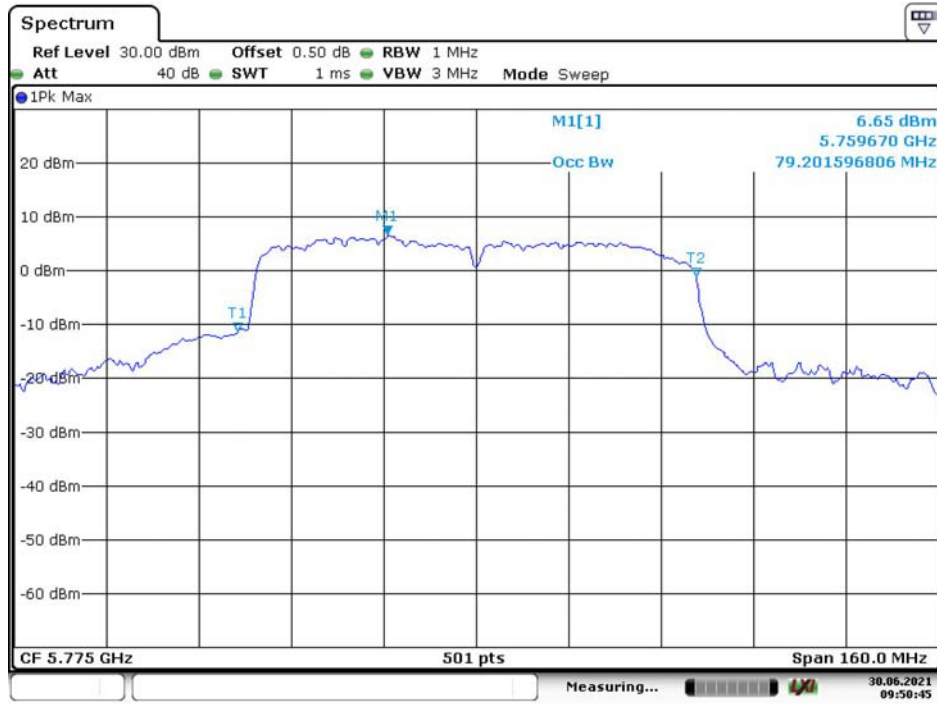

Date: 30.JUN.2021 09:50:45

FCC §15.407(a) –MAXIMUM CONDUCTED OUTPUT POWER

Applicable Standard

According to FCC §15.407(a)

(a) Power limits:

(1) For the band 5.15-5.25 GHz.

(i) For an outdoor access point operating in the band 5.15-5.25 GHz, the maximum conducted output power over the frequency band of operation shall not exceed 1 W provided the maximum antenna gain does not exceed 6 dBi. In addition, the maximum power spectral density shall not exceed 17 dBm in any 1 megahertz band. If transmitting antennas of directional gain greater than 6 dBi are used, both the maximum conducted output power and the maximum power spectral density shall be reduced by the amount in dB that the directional gain of the antenna exceeds 6 dBi. The maximum e.i.r.p. at any elevation angle above 30 degrees as measured from the horizon must not exceed 125 mW (21 dBm).

(ii) For an indoor access point operating in the band 5.15-5.25 GHz, the maximum conducted output power over the frequency band of operation shall not exceed 1 W provided the maximum antenna gain does not exceed 6 dBi. In addition, the maximum power spectral density shall not exceed 17 dBm in any 1 megahertz band. If transmitting antennas of directional gain greater than 6 dBi are used, both the maximum conducted output power and the maximum power spectral density shall be reduced by the amount in dB that the directional gain of the antenna exceeds 6 dBi.

(iii) For fixed point-to-point access points operating in the band 5.15-5.25 GHz, the maximum conducted output power over the frequency band of operation shall not exceed 1 W. Fixed point-to-point U-NII devices may employ antennas with directional gain up to 23 dBi without any corresponding reduction in the maximum conducted output power or maximum power spectral density. For fixed point-to-point transmitters that employ a directional antenna gain greater than 23 dBi, a 1 dB reduction in maximum conducted output power and maximum power spectral density is required for each 1 dB of antenna gain in excess of 23 dBi. Fixed, point-to-point operations exclude the use of point-to-multipoint systems, omnidirectional applications, and multiple collocated transmitters transmitting the same information. The operator of the U-NII device, or if the equipment is professionally installed, the installer, is responsible for ensuring that systems employing high gain directional antennas are used exclusively for fixed, point-to-point operations.

(iv) For mobile and portable client devices in the 5.15-5.25 GHz band, the maximum conducted output power over the frequency band of operation shall not exceed 250 mW provided the maximum antenna gain does not exceed 6 dBi. In addition, the maximum power spectral density shall not exceed 11 dBm in any 1 megahertz band. If transmitting antennas of directional gain greater than 6 dBi are used, both the maximum conducted output power and the maximum power spectral density shall be reduced by the amount in dB that the directional gain of the antenna exceeds 6 dBi.

(2) For the 5.25-5.35 GHz and 5.47-5.725 GHz bands, the maximum conducted output power over the frequency bands of operation shall not exceed the lesser of 250 mW or 11 dBm 10 log B, where B is the 26 dB emission bandwidth in megahertz. In addition, the maximum power spectral density shall not exceed 11 dBm in any 1 megahertz band. If transmitting antennas of directional gain greater than 6 dBi are used, both the maximum conducted output power and the maximum power spectral density shall be reduced by the amount in dB that the directional gain of the antenna exceeds 6 dBi.

(3) For the band 5.725-5.85 GHz, the maximum conducted output power over the frequency band of operation shall not exceed 1 W. In addition, the maximum power spectral density shall not exceed 30 dBm in any 500-kHz band. If transmitting antennas of directional gain greater than 6 dBi are used, both the maximum conducted output power and the maximum power spectral density shall be reduced by the amount in dB that the directional gain of the antenna exceeds 6 dBi. However, fixed point-to-point U-NII devices operating in this band may employ transmitting antennas with directional gain greater than 6 dBi without any corresponding reduction in transmitter conducted power. Fixed, point-to-point operations exclude the use of point-to-multipoint systems, omnidirectional applications, and multiple collocated transmitters transmitting the same information. The operator of the U-NII device, or if the equipment is professionally installed, the installer, is responsible for ensuring that systems employing high gain directional antennas are used exclusively for fixed, point-to-point operations.

(4) The maximum conducted output power must be measured over any interval of continuous transmission using instrumentation calibrated in terms of an rms-equivalent voltage.

Test Equipment List and Details

Manufacturer	Description	Model	Serial Number	Calibration Date	Calibration Due Date
Unknown	Coaxial Cable	C-SJ00-0010	C0010/01	Each time	N/A
E-Microwave	Coaxial Attenuators	EMCA10-5RN-6	OE01203239	Each time	N/A
Agilent	USB Wideband Power Sensor	U2022XA	MY5417006	2020-09-12	2021-09-12

* **Statement of Traceability:** Bay Area Compliance Laboratories Corp. (Dongguan) attests that all calibrations have been performed, traceable to National Primary Standards and International System of Units (SI).

Test Procedure

According to KDB 789033 D02 General UNII Test Procedures New Rules v02r01

Test Data

Environmental Conditions

Temperature:	26.9 °C
Relative Humidity:	46 %
ATM Pressure:	100.3 kPa
Test by:	JOE Qiao
Test Date:	2021-06-16

Test Mode: Transmitting

Band	Mode	Channel	Frequency (MHz)	Maximum Average Conducted Output Power (dBm)	Limit (dBm)
5150-5250 MHz	802.11 a	Low	5180	14.72	30
		Middle	5200	19.85	
		High	5240	18.24	
	802.11 n20	Low	5180	15.33	
		Middle	5200	19.29	
		High	5240	18.62	
	802.11 n40	Low	5190	14.45	
		High	5230	18.78	
	802.11 ac80	Middle	5210	13.76	
5725-5850 MHz	802.11 a	Low	5745	18.71	30
		Middle	5785	19.19	
		High	5825	18.83	
	802.11 n20	Low	5745	18.79	
		Middle	5785	18.76	
		High	5825	18.35	
	802.11 n40	Low	5755	11.9	
		High	5795	17.81	
	802.11 ac80	Middle	5775	17.32	

Note:

The device is an Indoor AP.

The duty cycle factor has been calculated into the test data.

FCC §15.407(a) - POWER SPECTRAL DENSITY

Applicable Standard

According to FCC §15.407(a)

(a) Power limits:

(1) For the band 5.15-5.25 GHz.

(i) For an outdoor access point operating in the band 5.15-5.25 GHz, the maximum conducted output power over the frequency band of operation shall not exceed 1 W provided the maximum antenna gain does not exceed 6 dBi. In addition, the maximum power spectral density shall not exceed 17 dBm in any 1 megahertz band. If transmitting antennas of directional gain greater than 6 dBi are used, both the maximum conducted output power and the maximum power spectral density shall be reduced by the amount in dB that the directional gain of the antenna exceeds 6 dBi. The maximum e.i.r.p. at any elevation angle above 30 degrees as measured from the horizon must not exceed 125 mW (21 dBm).

(ii) For an indoor access point operating in the band 5.15-5.25 GHz, the maximum conducted output power over the frequency band of operation shall not exceed 1 W provided the maximum antenna gain does not exceed 6 dBi. In addition, the maximum power spectral density shall not exceed 17 dBm in any 1 megahertz band. If transmitting antennas of directional gain greater than 6 dBi are used, both the maximum conducted output power and the maximum power spectral density shall be reduced by the amount in dB that the directional gain of the antenna exceeds 6 dBi.

(iii) For fixed point-to-point access points operating in the band 5.15-5.25 GHz, the maximum conducted output power over the frequency band of operation shall not exceed 1 W. Fixed point-to-point U-NII devices may employ antennas with directional gain up to 23 dBi without any corresponding reduction in the maximum conducted output power or maximum power spectral density. For fixed point-to-point transmitters that employ a directional antenna gain greater than 23 dBi, a 1 dB reduction in maximum conducted output power and maximum power spectral density is required for each 1 dB of antenna gain in excess of 23 dBi. Fixed, point-to-point operations exclude the use of point-to-multipoint systems, omnidirectional applications, and multiple collocated transmitters transmitting the same information. The operator of the U-NII device, or if the equipment is professionally installed, the installer, is responsible for ensuring that systems employing high gain directional antennas are used exclusively for fixed, point-to-point operations.

(iv) For mobile and portable client devices in the 5.15-5.25 GHz band, the maximum conducted output power over the frequency band of operation shall not exceed 250 mW provided the maximum antenna gain does not exceed 6 dBi. In addition, the maximum power spectral density shall not exceed 11 dBm in any 1 megahertz band. If transmitting antennas of directional gain greater than 6 dBi are used, both the maximum conducted output power and the maximum power spectral density shall be reduced by the amount in dB that the directional gain of the antenna exceeds 6 dBi.

(2) For the 5.25-5.35 GHz and 5.47-5.725 GHz bands, the maximum conducted output power over the frequency bands of operation shall not exceed the lesser of 250 mW or 11 dBm $10 \log B$, where B is the 26 dB emission bandwidth in megahertz. In addition, the maximum power spectral density shall not exceed 11 dBm in any 1 megahertz band. If transmitting antennas of directional gain greater than 6 dBi are used, both the maximum conducted output

power and the maximum power spectral density shall be reduced by the amount in dB that the directional gain of the antenna exceeds 6 dBi.

(3) For the band 5.725-5.85 GHz, the maximum conducted output power over the frequency band of operation shall not exceed 1 W. In addition, the maximum power spectral density shall not exceed 30 dBm in any 500-kHz band. If transmitting antennas of directional gain greater than 6 dBi are used, both the maximum conducted output power and the maximum power spectral density shall be reduced by the amount in dB that the directional gain of the antenna exceeds 6 dBi. However, fixed point-to-point U-NII devices operating in this band may employ transmitting antennas with directional gain greater than 6 dBi without any corresponding reduction in transmitter conducted power. Fixed, point-to-point operations exclude the use of point-to-multipoint systems, omnidirectional applications, and multiple collocated transmitters transmitting the same information. The operator of the U-NII device, or if the equipment is professionally installed, the installer, is responsible for ensuring that systems employing high gain directional antennas are used exclusively for fixed, point-to-point operations.

Test Procedure

According to KDB 789033 D02 General UNII Test Procedures New Rules v02r01

Test Equipment List and Details

Manufacturer	Description	Model	Serial Number	Calibration Date	Calibration Due Date
R&S	Spectrum Analyzer	FSV40	101474	2020-07-07	2021-07-07
Unknown	Coaxial Cable	C-SJ00-0010	C0010/01	Each time	N/A

* **Statement of Traceability:** Bay Area Compliance Laboratories Corp. (Dongguan) attests that all calibrations have been performed, traceable to National Primary Standards and International System of Units (SI).

Test Data

Environmental Conditions

Temperature:	26.9 °C
Relative Humidity:	46 %
ATM Pressure:	100.3 kPa
Test by:	JOE Qiao
Test Date:	2021-06-16~2021-6-30

Test Mode: Transmitting

Test Result: Compliance. Please refer to the following table and plot.

5150-5250MHz:

Mode	Frequency (MHz)	Maximum Power Spectral Density (dBm/MHz)	Limit (dBm/MHz)
802.11a	5180	4.34	17
	5200	3.9	17
	5240	3.7	17
802.11n ht20	5180	5.61	15.8
	5200	5.5	15.8
	5240	5.66	15.8
802.11n ht40	5190	0.11	15.8
	5230	0.37	15.8
802.11ac vht80	5210	3.53	15.8

5725-5850 MHz:

Mode	Frequency (MHz)	Reading (dBm/300kHz)	Maximum Power Spectral Density (dBm/500kHz)	Limit (dBm/500kHz)
802.11a	5745	4.15	6.37	30
	5785	4.19	6.41	30
	5825	4.49	6.71	30
802.11n ht20	5745	3.45	5.67	30
	5785	3.59	5.81	30
	5825	3.13	5.35	30
802.11n ht40	5755	2.59	4.81	30
	5795	4.93	7.15	30
802.11ac vht80	5775	2.4	4.62	30

Note:

The device is an Indoor AP.

For 5.8GHz band, If measurement bandwidth of Maximum PSD is specified in 500 kHz, add $10\log(500\text{kHz}/\text{RBW})$ to the measured result, whereas $\text{RBW} (< 500 \text{ KHz})$ is the reduced resolution bandwidth of the spectrum analyzer set during measurement.

Method SA-3 in KDB 789033 D02 General UNII Test Procedures New Rules v02r01 was used for PSD test.

5150-5250MHz

802.11a Low Channel

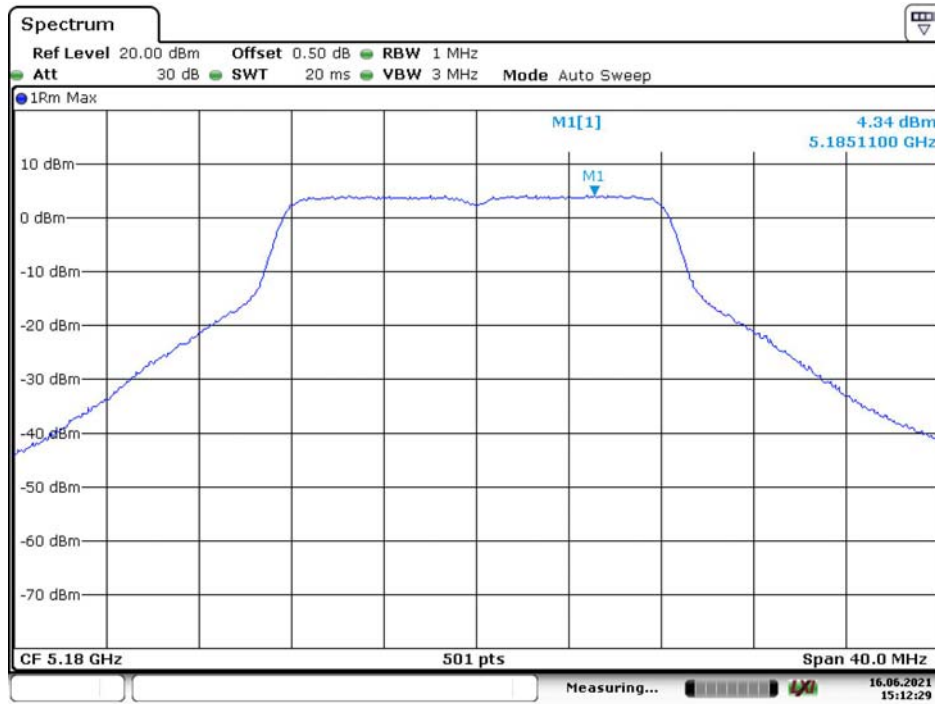

Date: 16.JUN.2021 15:12:29

802.11a Middle Channel

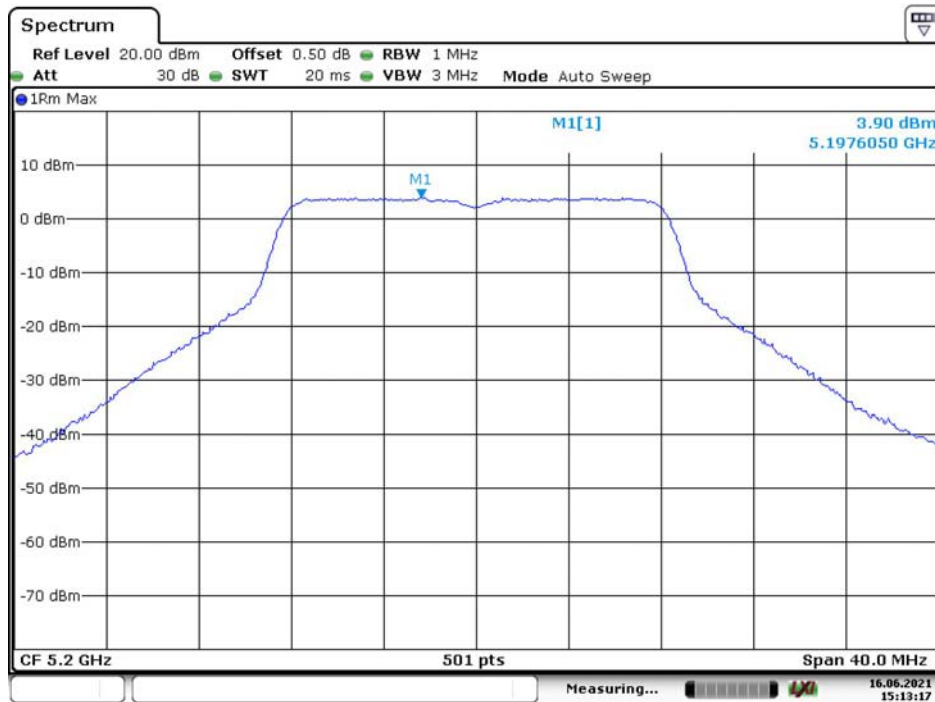

Date: 16.JUN.2021 15:13:17

802.11a High Channel

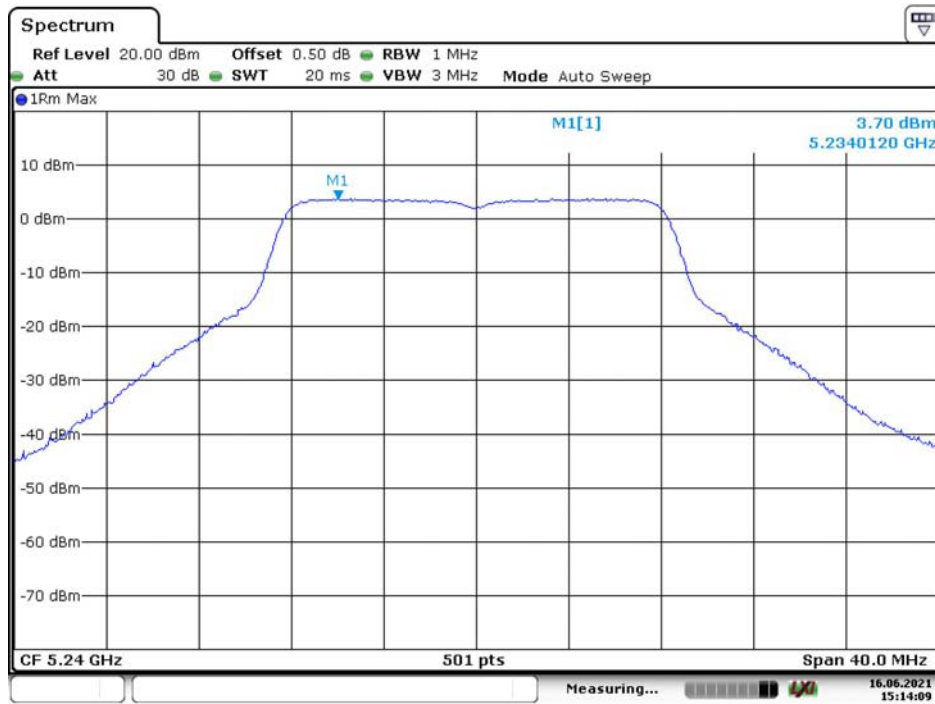

Date: 16.JUN.2021 15:14:09

802.11n ht20 Low Channel



Date: 16.JUN.2021 15:15:07

802.11n ht20 Middle Channel

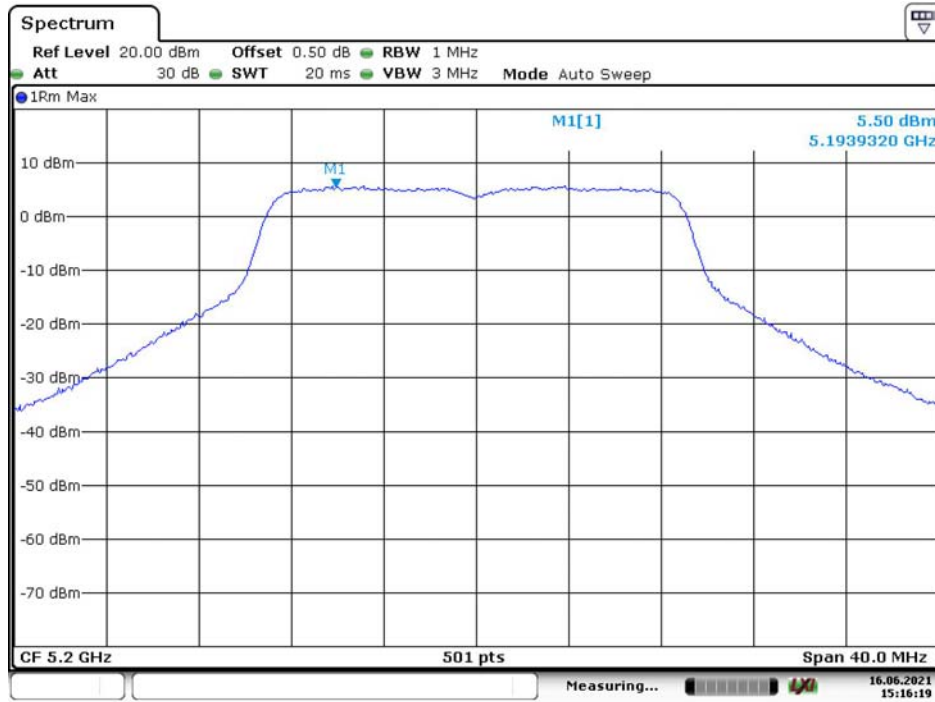

Date: 16.JUN.2021 15:16:19

802.11n ht20 High Channel

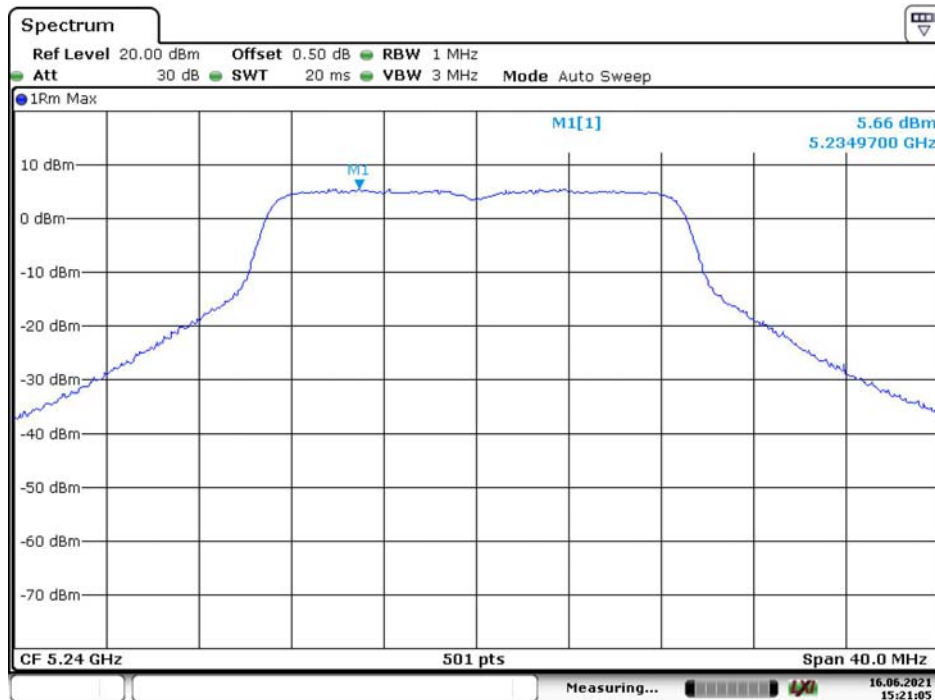

Date: 16.JUN.2021 15:21:05

802.11n ht40 Low Channel



Date: 16.JUN.2021 15:22:05

802.11n ht40 High Channel



Date: 16.JUN.2021 15:22:54

802.11ac vht80 Middle Channel

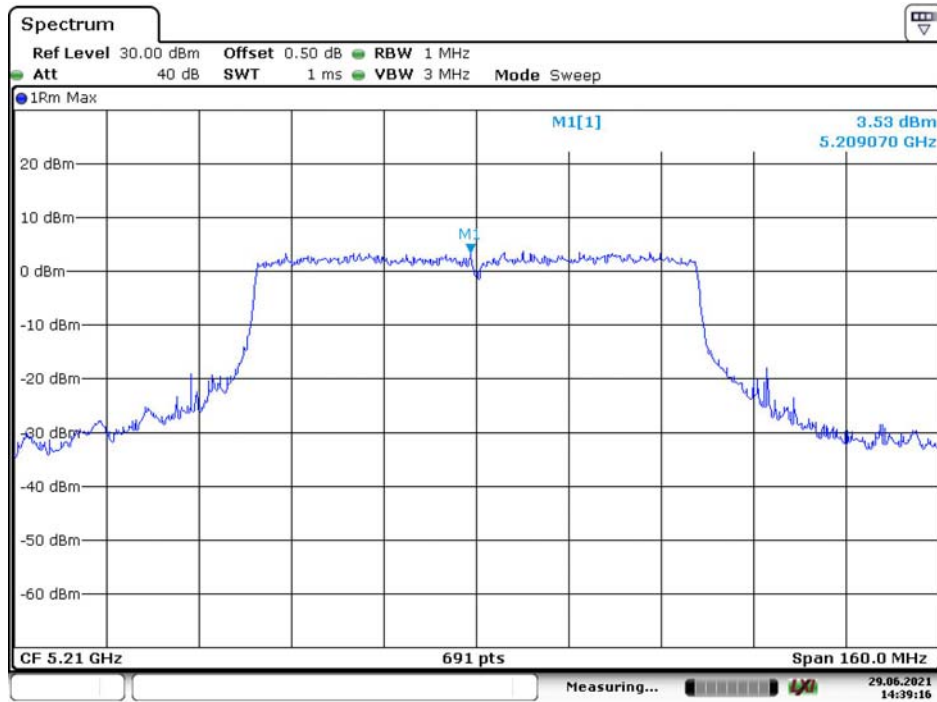

Date: 29.JUN.2021 14:39:16

802.11a High Channel

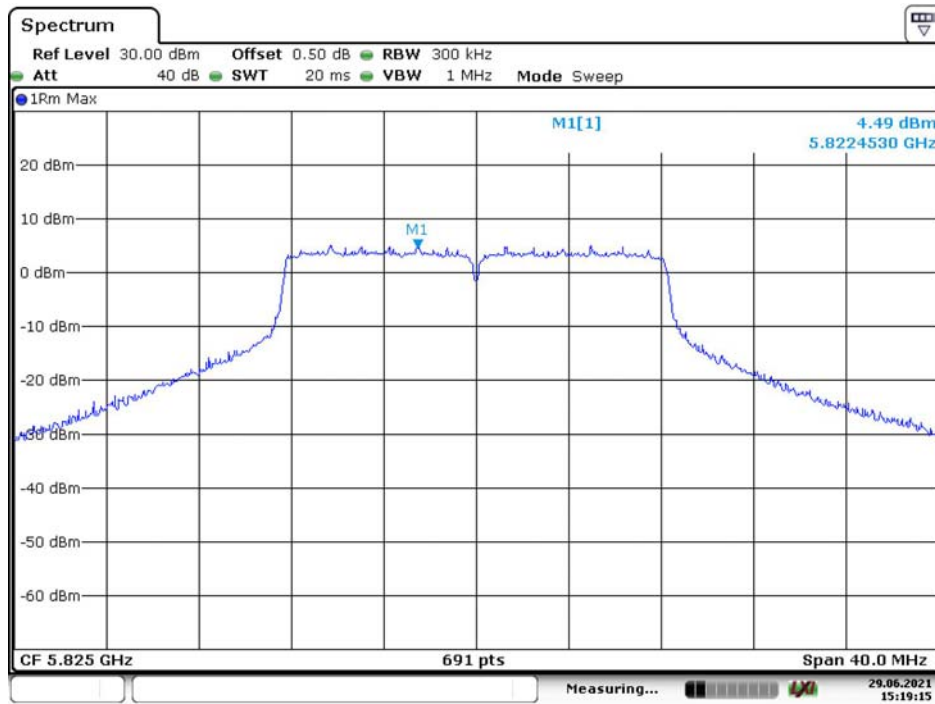

Date: 29.JUN.2021 15:19:15

802.11n ht20 Low Channel

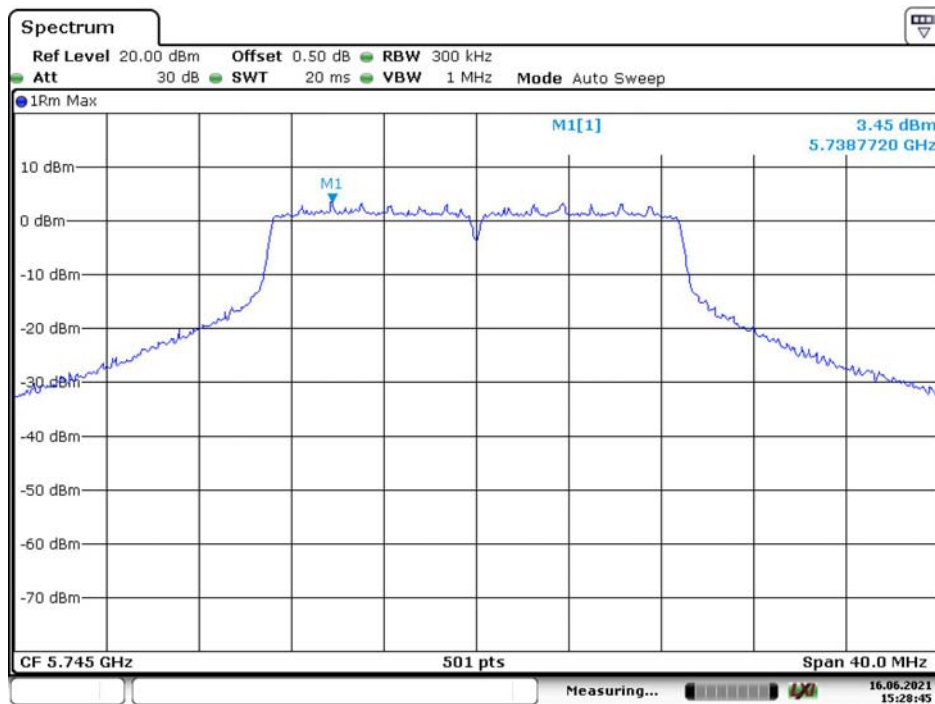

Date: 16.JUN.2021 15:28:45

802.11n ht20 Middle Channel

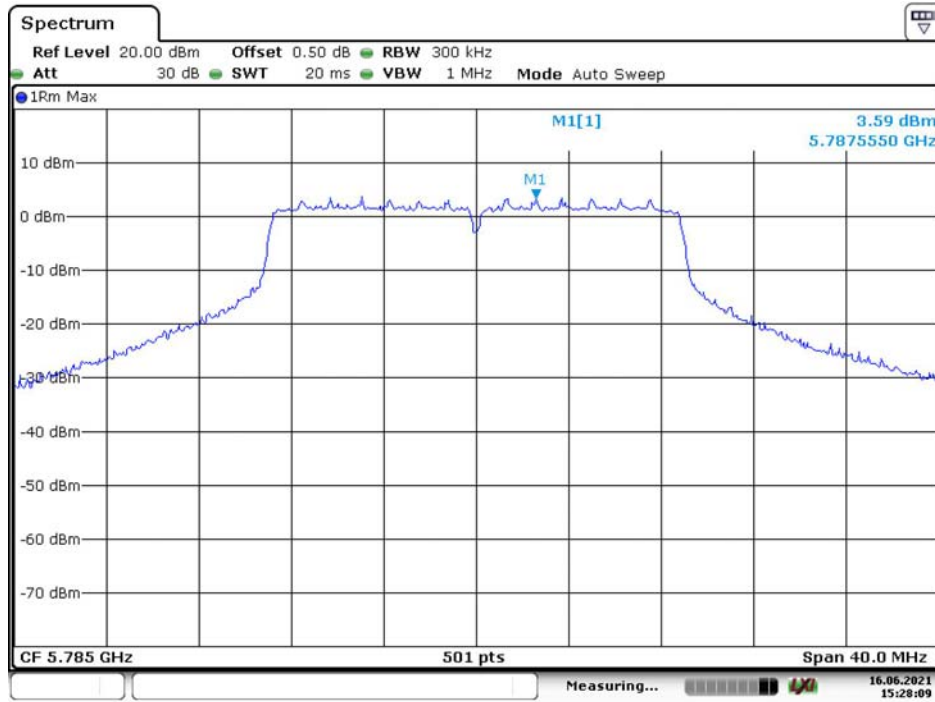

Date: 16.JUN.2021 15:28:09

802.11n ht20 High Channel

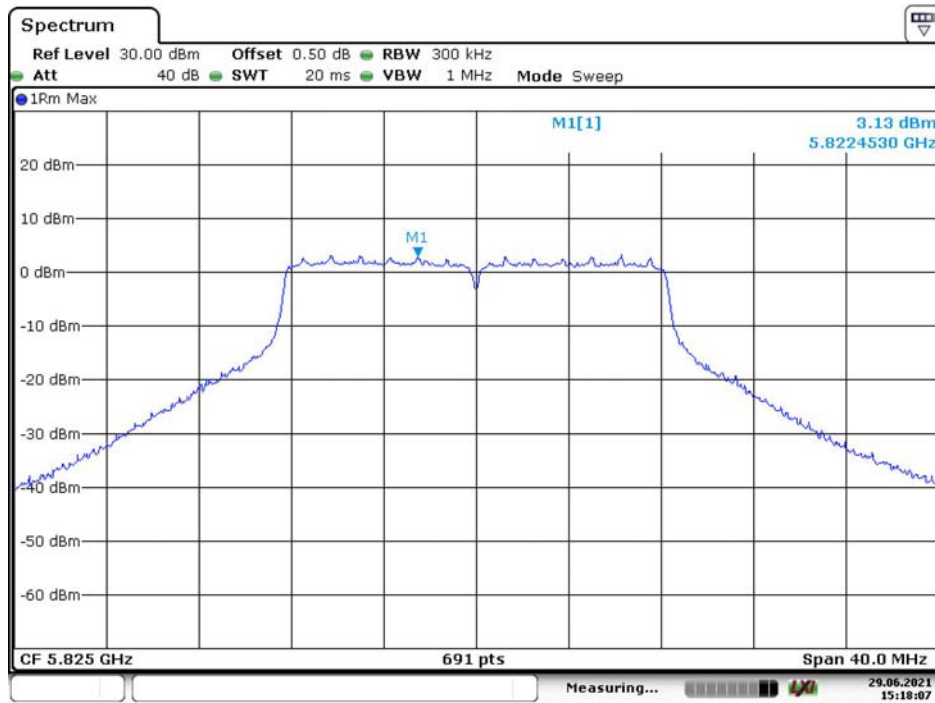

Date: 29.JUN.2021 15:18:07

802.11n ht40 Low Channel

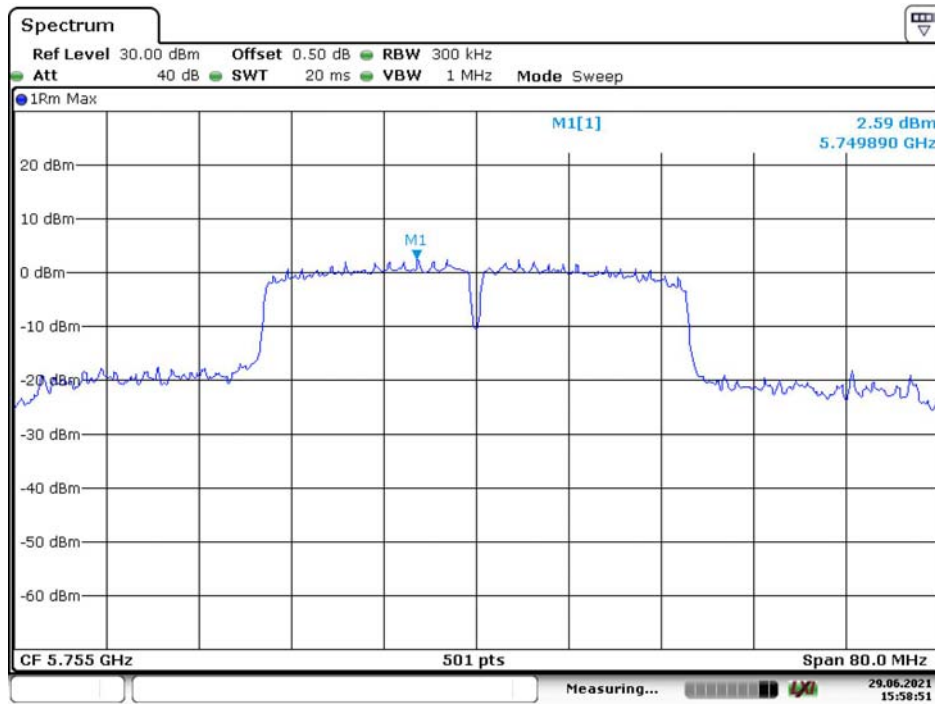

802.11n ht40 High Channel



802.11ac vht80 Middle Channel

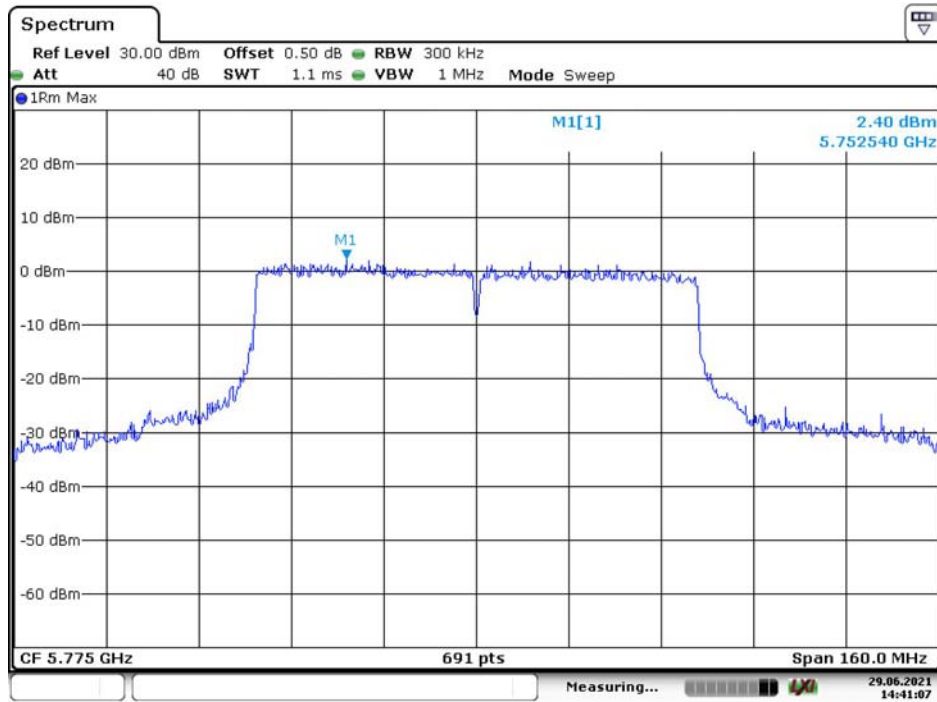

Date: 29.JUN.2021 14:41:07

***** END OF REPORT *****