



CTC Laboratories, Inc.

1-2/F., Building 2, Jiaquan Building, Guanlan High-Tech Park, Shenzhen, Guangdong, China
Tel: +86-755- 27521059 Fax: +86-755- 27521011 Http://www.sz-ctc.org.cn

TEST REPORT

Report No.: **CTC20211682E02**

FCC ID.....: **2AFIW-SF1200**

Applicant.....: **GL TECHNOLOGIES (HONG KONG) LIMITED**

Address.....: **FLAT/RM 203 2/F BUILDING 19W 19 SCIENCE PARK WEST AVENUE SHATIN NT SHATIN HONG KONG**

Manufacturer.....: **Shenzhen Guanglianzhitong Tech Co., Ltd**

Address.....: **Room 305-306, Skyworth Digital Building, Shiyuan Street, Baoan District, Shenzhen, China**

Product Name.....: **AC1200 Gigabit Wireless Router**

Trade Mark.....: **GL.iNET**

Model/Type reference.....: **GL-SF1200**

Listed Model(s): **/**

Standard.....: **FCC CFR Title 47 Part 15 Subpart C Section 15.247**

Date of receipt of test sample...: **Oct. 27, 2021**

Date of testing.....: **Oct. 28, 2021 ~ Nov. 22, 2021**

Date of issue.....: **Nov. 23, 2021**

Result.....: **PASS**

Compiled by:		
(Printed name+signature)	Terry Su	
Supervised by:		
(Printed name+signature)	Miller Ma	
Approved by:		
(Printed name+signature)	Totti Zhao	

Testing Laboratory Name.....: **CTC Laboratories, Inc.**

Address.....: **1-2/F., Building 2, Jiaquan Building, Guanlan High-Tech Park, Shenzhen, Guangdong, China**

This test report may be duplicated completely for legal use with the approval of the applicant. It should not be reproduced except in full, without the written approval of our laboratory. The client should not use it to claim product endorsement by CTC. The test results in the report only apply to the tested sample. The test report shall be invalid without all the signatures of testing engineers, reviewer and approver. Any objections must be raised to CTC within 15 days since the date when the report is received. It will not be taken into consideration beyond this limit. The test report merely correspond to the test sample.



Table of Contents

Page

1. TEST SUMMARY..... 3

1.1. TEST STANDARDS.....3

1.2. REPORT VERSION.....3

1.3. TEST DESCRIPTION.....4

1.4. TEST FACILITY5

1.5. MEASUREMENT UNCERTAINTY5

1.6. ENVIRONMENTAL CONDITIONS6

2. GENERAL INFORMATION..... 7

2.1. CLIENT INFORMATION7

2.2. GENERAL DESCRIPTION OF EUT8

2.3. ACCESSORY EQUIPMENT INFORMATION9

2.4. OPERATION STATE.....10

2.5. MEASUREMENT INSTRUMENTS LIST11

3. TEST ITEM AND RESULTS 12

3.1. CONDUCTED EMISSION.....12

3.2. RADIATED EMISSION17

3.3. BAND EDGE EMISSIONS (RADIATED)47

3.4. BAND EDGE AND SPURIOUS EMISSIONS (CONDUCTED)64

3.5. DTS BANDWIDTH.....98

3.6. PEAK OUTPUT POWER108

3.7. POWER SPECTRAL DENSITY110

3.8. DUTY CYCLE120

3.9. ANTENNA REQUIREMENT130



1. TEST SUMMARY

1.1. Test Standards

The tests were performed according to following standards:

[FCC Rules Part 15.247](#): Operation within the bands of 902-928MHz, 2400-2483.5MHz, and 5725-5850MHz.

[RSS 247 Issue 2](#): Standard Specifications for Frequency Hopping Systems (FHSs) and Digital Transmission Systems (DTSs) Operating in the Bands 902-928MHz, 2400-2483.5MHz and 5725-5850MHz.

[ANSI C63.10-2013](#): American National Standard for Testing Unlicensed Wireless Devices.

[KDB 662911 D01](#): Multiple Transmitter Output v02r01.

1.2. Report version

Revised No.	Date of issue	Description
01	Nov. 23, 2021	Original



1.3. Test Description

FCC Part 15 Subpart C (15.247) / RSS 247 Issue 2				
Test Item	Standard Section		Result	Test Engineer
	FCC	IC		
Antenna Requirement	15.203	/	Pass	Alicia Liu
Conducted Emission	15.207	RSS-Gen 8.8	Pass	Ice Lu
Radiated Band Edge and Spurious Emissions	15.205&15.209&15.247(d)	RSS 247 5.5	Pass	Alicia Liu
Conducted Band Edge and Spurious Emissions	15.247(d)	RSS 247 5.5	Pass	Alicia Liu
6dB Bandwidth	15.247(a)(2)	RSS 247 5.2 (a)	Pass	Alicia Liu
Conducted Max Output Power	15.247(b)(3)	RSS 247 5.4 (d)	Pass	Alicia Liu
Power Spectral Density	15.247(e)	RSS 247 5.2 (b)	Pass	Alicia Liu
Transmitter Radiated Spurious	15.209&15.247(d)	RSS 247 5.5&RSS-Gen 8.9	Pass	Alicia Liu

Note: The measurement uncertainty is not included in the test result.



1.4. Test Facility

CTC Laboratories, Inc.

Add: 1-2/F., Building 2, Jiaquan Building, Guanlan High-Tech Park, Shenzhen, Guangdong, China

Laboratory accreditation

The test facility is recognized, certified, or accredited by the following organizations:

CNAS-Lab Code: L5365

CTC Laboratories, Inc. has been assessed and proved to be in compliance with CNAS-CL01 Accreditation. Criteria for Testing and Calibration Laboratories (identical to ISO/IEC 17025:2017 General Requirements) for the Competence of Testing and Calibration Laboratories.

A2LA-Lab Cert. No.: 4340.01

CTC Laboratories, Inc. EMC Laboratory has been accredited by A2LA for technical competence in the field of electrical testing, and proved to be in compliance with ISO/IEC 17025:2017 General Requirements for the Competence of Testing and Calibration Laboratories and any additional program requirements in the identified field of testing.

Industry Canada (Registration No.: 9783A, CAB Identifier: CN0029)

CTC Laboratories, Inc. EMC Laboratory has been registered by Certification and Engineer Bureau of Industry Canada for the performance of with Registration NO.: 9783A on Jan, 2016.

FCC (Registration No.: 951311, Designation Number CN1208)

CTC Laboratories, Inc. EMC Laboratory has been registered and fully described in a report filed with the (FCC) Federal Communications Commission. The acceptance letter from the FCC is maintained in our files. Registration 951311, Aug 26, 2017.

1.5. Measurement Uncertainty

The data and results referenced in this document are true and accurate. The reader is cautioned that there may be errors within the calibration limits of the equipment and facilities. The measurement uncertainty was calculated for all measurements listed in this test report acc. to TR-100028-01 "Electromagnetic compatibility and Radio spectrum Matters (ERM); Uncertainties in the measurement of mobile radio equipment characteristics; Part 1" and TR-100028-02 "Electromagnetic compatibility and Radio spectrum Matters (ERM); Uncertainties in the measurement of mobile radio equipment characteristics; Part 2" and is documented in the CTC Laboratories, Inc. quality system acc. to DIN EN ISO/IEC 17025. Furthermore, component and process variability of devices similar to that tested may result in additional deviation. The manufacturer has the sole responsibility of continued compliance of the device.

Below is the best measurement capability for CTC Laboratories, Inc.



Test Items	Measurement Uncertainty	Notes
Transmitter power conducted	0.42 dB	(1)
Transmitter power Radiated	2.14 dB	(1)
Conducted spurious emissions 9kHz~40GHz	1.60 dB	(1)
Radiated spurious emissions 9kHz~40GHz	2.20 dB	(1)
Conducted Emissions 9kHz~30MHz	3.08 dB	(1)
Radiated Emissions 30~1000MHz	4.51 dB	(1)
Radiated Emissions 1~18GHz	5.84 dB	(1)
Radiated Emissions 18~40GHz	6.12 dB	(1)
Occupied Bandwidth	-----	(1)

Note (1): This uncertainty represents an expanded uncertainty expressed at approximately the 95% confidence level using a coverage factor of $k=1.96$.

1.6. Environmental conditions

During the measurement the environmental conditions were within the listed ranges:

Temperature:	21°C ~ 27°C
Relative Humidity:	40% ~ 60%
Air Pressure:	101kPa



2. GENERAL INFORMATION

2.1. Client Information

Applicant:	GL TECHNOLOGIES (HONG KONG) LIMITED
Address:	FLAT/RM 203 2/F BUILDING 19W 19 SCIENCE PARK WEST AVENUE SHATIN NT SHATIN HONG KONG
Manufacturer:	Shenzhen Guanglianzhitong Tech Co., Ltd
Address:	Room 305-306, Skyworth Digital Building, Shiyan Street, Baoan District, Shenzhen, China



2.2. General Description of EUT

Product Name:	AC1200 Gigabit Wireless Router
Trade Mark:	GL.iNET
Model/Type reference:	GL-SF1200
Listed Model(s):	/
Power supply:	12Vdc/1A from AC/DC Adapter
Adapter model:	GLH1201000 Input: 100-240V~ 50/60Hz 0.4A Max Output: 12Vdc/1A
Hardware version:	SF1200_V22, SF1200_V23
Software version:	sf1200-3.204
WIFI 802.11b/ g/ n(HT20)/ n(HT40)	
Modulation:	802.11b: DSSS(CCK, DQPSK, DBPSK) 802.11g/n: OFDM(BPSK, QPSK, 16QAM, 64QAM)
Operation frequency:	802.11b/g/n(HT20): 2412MHz~2462MHz 802.11n(HT40): 2422MHz~2452MHz
Channel number:	802.11b/g/n(HT20):11channels 802.11n(HT40):7channels
Channel separation:	5MHz
Antenna 1 and 2 type:	External Antenna
Antenna 1 and 2 gain:	5.80dBi Max
Antenna 1 + 2 Directional gain:	8.81dBi Max

Note: GL-SF1200 contains two types of network transformers: separate and integrated.



2.3. Accessory Equipment information

Equipment Information			
Name	Model	S/N	Manufacturer
Notebook	X220	R9-NCMYL 12/04	Lenovo
/	/	/	/
Cable Information			
Name	Shielded Type	Ferrite Core	Length
DC Output line	Without	Without	1M
Lan line	Without	Without	1.2M
Test Software Information			
Name	Versions	/	/
SecureCRT.exe	8.7.1	/	/





2.4. Operation state

Operation Frequency List: The EUT has been tested under typical operating condition. The Applicant provides communication tools software to control the EUT for staying in continuous transmitting and receiving mode for testing.

Operation Frequency List:

Channel	Frequency (MHz)
01	2412
02	2417
03	2422
04	2427
05	2432
06	2437
07	2442
08	2447
09	2452
10	2457
11	2462

Note: CH 01~CH 11 for 802.11b/g/n(HT20), CH 03~CH 09 for 802.11n(HT40)

Data Rated

Preliminary tests were performed in different data rate, and found which the below bit rate is worst case mode, so only show data which it is a worst case mode.

Mode	Data rate (worst mode)
802.11b	1Mbps
802.11g	6Mbps
802.11n(HT20)	HT-MCS0
802.11n(HT40)	HT-MCS0

Test mode

For RF test items:
The engineering test program was provided and enabled to make EUT continuous transmit.
For AC power line conducted emissions:
The EUT was set to connect with the WLAN AP under large package sizes transmission.
For Radiated spurious emissions test item:
The engineering test program was provided and enabled to make EUT continuous transmit. The EUT in each of three orthogonal axis emissions had been tested, but only the worst case (X axis) data Recorded in the report.



2.5. Measurement Instruments List

Tonscend JS0806-2 Test system					
Item	Test Equipment	Manufacturer	Model No.	Serial No.	Calibrated until
1	Spectrum Analyzer	KEYSIGHT	N9020A	100231	Dec. 25, 2021
2	Spectrum Analyzer	Rohde & Schwarz	FUV40-N	101331	Mar. 15, 2022
3	MXG Vector Signal Generator	Agilent	N5182A	MY47420864	Dec. 25, 2021
4	Signal Generator	Agilent	E8257D	MY46521908	Dec. 25, 2021
5	Power Sensor	Agilent	U2021XA	MY5365004	Mar. 15, 2022
6	Power Sensor	Agilent	U2021XA	MY5365006	Mar. 15, 2022
7	High and low temperature box	ESPEC	MT3035	N/A	Mar. 24, 2022
8	Wideband Radio Communication Tester	Rohde & Schwarz	CMW500	102414	Dec. 25, 2021
9	300328 v2.2.2 test system	TONSCEND	v2.6	/	/

Radiated emission(3m chamber 2)					
Item	Test Equipment	Manufacturer	Model No.	Serial No.	Calibrated Until
1	Trilog-Broadband Antenna	Schwarzbeck	VULB 9168	9168-1013	Jan. 12, 2022
2	Horn Antenna	Schwarzbeck	BBHA 9120D	9120D-647	Dec. 24, 2021
3	Spectrum Analyzer	R&S	FSU26	100105	Dec. 25, 2021
4	Spectrum Analyzer	R&S	FSV40-N	101331	Mar. 15, 2022
5	Pre-Amplifier	SONOMA	310	186194	Dec. 25, 2021
6	Low Noise Pre-Amplifier	EMCI	EMC051835	980075	Dec. 25, 2021
7	Test Receiver	R&S	ESC17	100967	Dec. 25, 2021

Radiated emission(3m chamber 3)					
Item	Test Equipment	Manufacturer	Model No.	Serial No.	Calibrated Until
1	Trilog-Broadband Antenna	Schwarzbeck	VULB 9168	9168-759	Nov. 09, 2022
2	Horn Antenna	Schwarzbeck	BBHA 9120D	9120D-647	Dec. 24, 2021
3	Test Receiver	Keysight	N9038A	MY56400071	Dec. 25, 2021
4	Broadband Premplifier	SCHWARZBECK	BBV9743B	259	Dec. 25, 2021
5	Mirowave Broadband Amplifier	SCHWARZBECK	BBV9718C	111	Dec. 25, 2021

Conducted Emission					
Item	Test Equipment	Manufacturer	Model No.	Serial No.	Calibrated until
1	LISN	R&S	ENV216	101112	Dec. 25, 2021
2	LISN	R&S	ENV216	101113	Dec. 25, 2021
3	EMI Test Receiver	R&S	ESCS30	100353	Dec. 25, 2021

Note:1. The Cal. Interval was one year.

2. The cable loss has calculated in test result which connection between each test instruments.

CTC Laboratories, Inc.

1-2/F., Building 2, Jiaquan Building, Guanlan High-Tech Park, Shenzhen, Guangdong, China
Tel.: (86)755-27521059 Fax: (86)755-27521011 Http://www.sz-ctc.org.cn



For anti-fake verification, please visit the official website of Certification and Accreditation Administration of the People's Republic of China : yz.cnca.cn

3. TEST ITEM AND RESULTS

3.1. Conducted Emission

Limit

FCC CFR Title 47 Part 15 Subpart C Section 15.207/ RSS - Gen 8.8:

Frequency range (MHz)	Limit (dBuV)	
	Quasi-peak	Average
0.15-0.5	66 to 56*	56 to 46*
0.5-5	56	46
5-30	60	50

* Decreases with the logarithm of the frequency.

Test Configuration

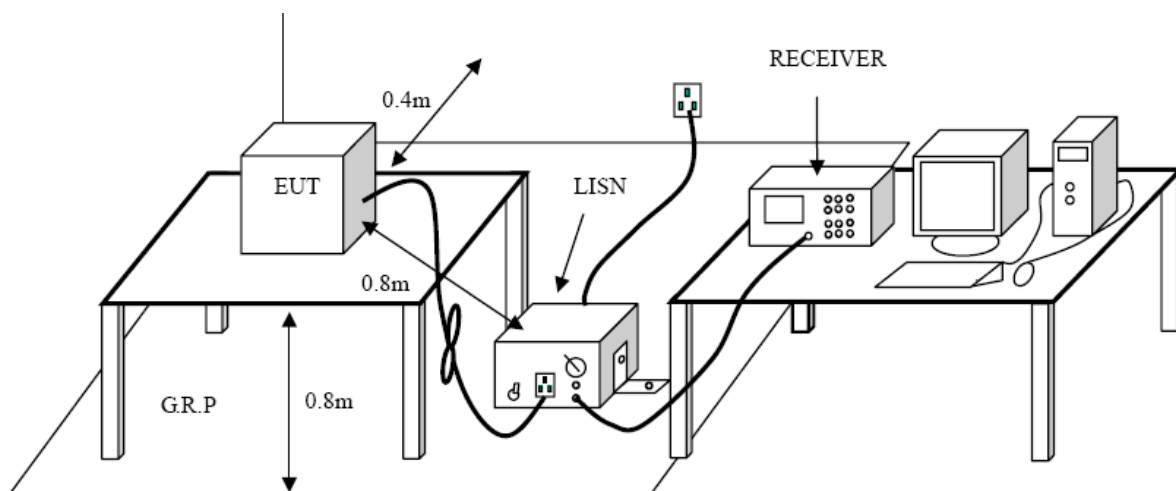

Test Procedure

1. The EUT was setup according to ANSI C63.10:2013 requirements.
2. The EUT was placed on a platform of nominal size, 1 m by 1.5 m, raised 80 cm above the conducting ground plane. The vertical conducting plane was located 40 cm to the rear of the EUT. All other surfaces of EUT were at least 80 cm from any other grounded conducting surface.
3. The EUT and simulators are connected to the main power through a line impedances stabilization network (LISN). The LISN provides a 50ohm /50uH coupling impedance for the measuring equipment. The peripheral devices are also connected to the main power through a LISN. (Please refer to the block diagram of the test setup and photographs)
4. Each current-carrying conductor of the EUT power cord, except the ground (safety) conductor, was individually connected through a LISN to the input power source.
5. The excess length of the power cord between the EUT and the LISN receptacle were folded back and forth at the center of the lead to form a bundle not exceeding 40 cm in length.
6. Conducted Emissions were investigated over the frequency range from 0.15MHz to 30MHz using a receiver bandwidth of 9 kHz.
7. During the above scans, the emissions were maximized by cable manipulation.



Test Mode:

Please refer to the clause 2.4.

Test Results

Transformer type:	Integrated transformer
Test Voltage:	AC 120V/60 Hz
Terminal:	Line

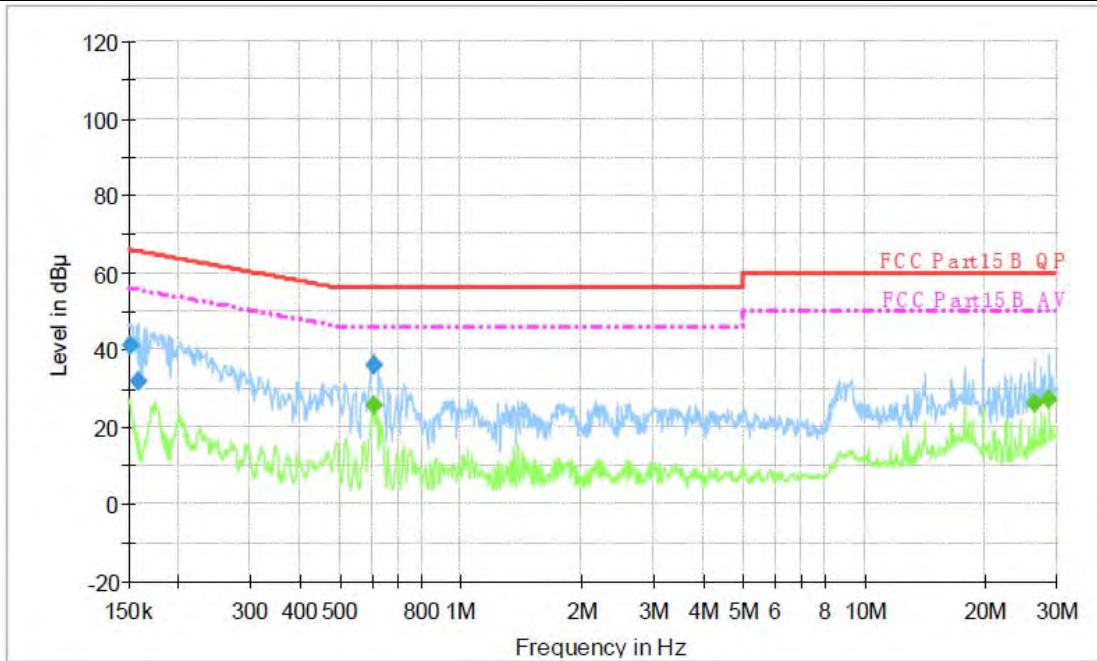

Final Measurement Detector 1

Frequency (MHz)	QuasiPeak (dBµ V)	Meas. Time (ms)	Bandwidth (kHz)	Filter	Line	Corr. (dB)	Margin (dB)	Limit (dBµ V)	Comment
0.151810	41.4	1000.00	9.000	On	L1	9.7	24.5	65.9	
0.159260	31.6	1000.00	9.000	On	L1	9.7	33.9	65.5	
0.606580	35.9	1000.00	9.000	On	L1	9.7	20.1	56.0	

Final Measurement Detector 2

Frequency (MHz)	Average (dBµ V)	Meas. Time (ms)	Bandwidth (kHz)	Filter	Line	Corr. (dB)	Margin (dB)	Limit (dBµ V)	Comment
0.606580	25.7	1000.00	9.000	On	L1	9.7	20.3	46.0	
26.483990	26.0	1000.00	9.000	On	L1	10.0	24.0	50.0	
28.685180	27.4	1000.00	9.000	On	L1	9.9	22.6	50.0	

Emission Level= Read Level+ Correct Factor



Transformer type:	Integrated transformer
Test Voltage:	AC 120V/60 Hz
Terminal:	Neutral

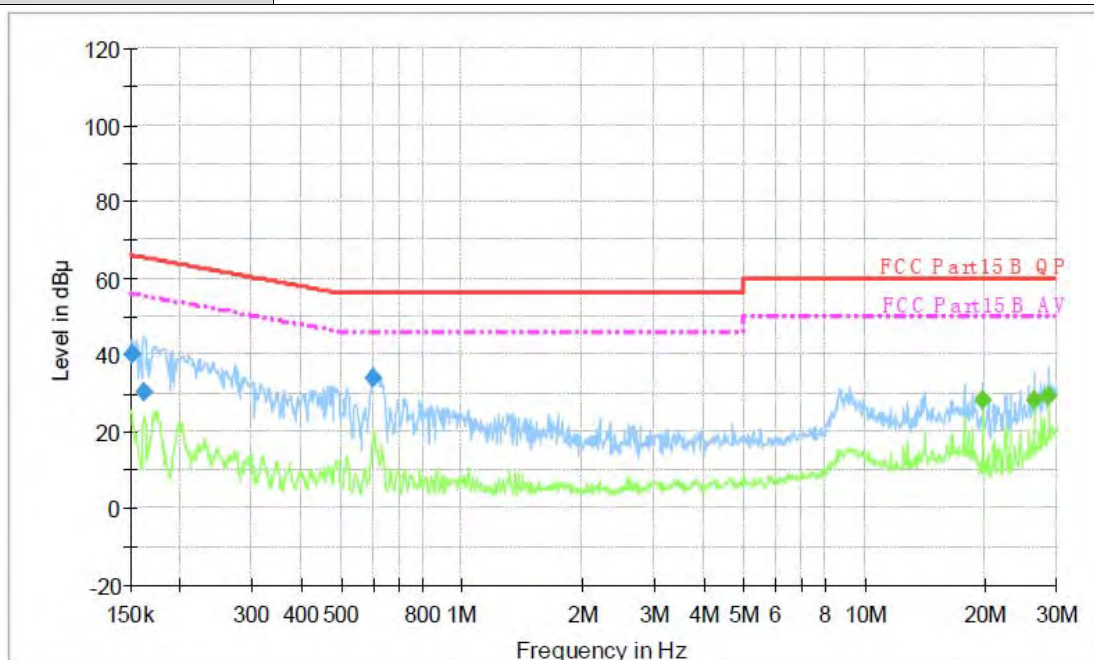

Final Measurement Detector 1

Frequency (MHz)	QuasiPeak (dBμ V)	Meas. Time (ms)	Bandwidth (kHz)	Filter	Line	Corr. (dB)	Margin (dB)	Limit (dBμ V)	Comment
0.151810	40.1	1000.00	9.000	On	N	10.0	25.8	65.9	
0.163120	30.3	1000.00	9.000	On	N	10.0	35.0	65.3	
0.604170	34.2	1000.00	9.000	On	N	10.0	21.8	56.0	

Final Measurement Detector 2

Frequency (MHz)	Average (dBμ V)	Meas. Time (ms)	Bandwidth (kHz)	Filter	Line	Corr. (dB)	Margin (dB)	Limit (dBμ V)	Comment
19.710090	28.5	1000.00	9.000	On	N	10.0	21.5	50.0	
26.483990	28.1	1000.00	9.000	On	N	10.0	21.9	50.0	
28.685180	29.4	1000.00	9.000	On	N	10.0	20.6	50.0	

Emission Level= Read Level+ Correct Factor



Transformer type:	Separate transformer
Test Voltage:	AC 120V/60 Hz
Terminal:	Line

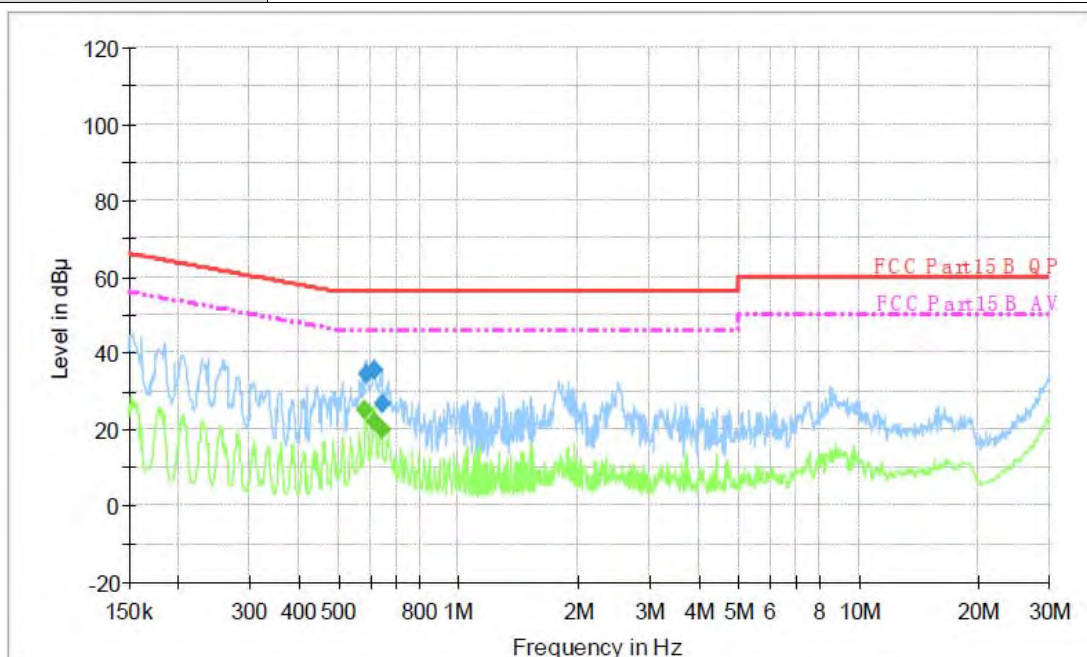

Final Measurement Detector 1

Frequency (MHz)	QuasiPeak (dBµ V)	Meas. Time (ms)	Bandwidth (kHz)	Filter	Line	Corr. (dB)	Margin (dB)	Limit (dBµ V)	Comment
0.587520	34.7	1000.00	9.000	On	L1	9.7	21.3	56.0	
0.613890	35.3	1000.00	9.000	On	L1	9.7	20.7	56.0	
0.641450	26.7	1000.00	9.000	On	L1	9.7	29.3	56.0	

Final Measurement Detector 2

Frequency (MHz)	Average (dBµ V)	Meas. Time (ms)	Bandwidth (kHz)	Filter	Line	Corr. (dB)	Margin (dB)	Limit (dBµ V)	Comment
0.585180	25.2	1000.00	9.000	On	L1	9.7	20.8	46.0	
0.618810	22.0	1000.00	9.000	On	L1	9.7	24.0	46.0	
0.641450	19.9	1000.00	9.000	On	L1	9.7	26.1	46.0	

Emission Level= Read Level+ Correct Factor



Transformer type:	Separate transformer
Test Voltage:	AC 120V/60 Hz
Terminal:	Neutral

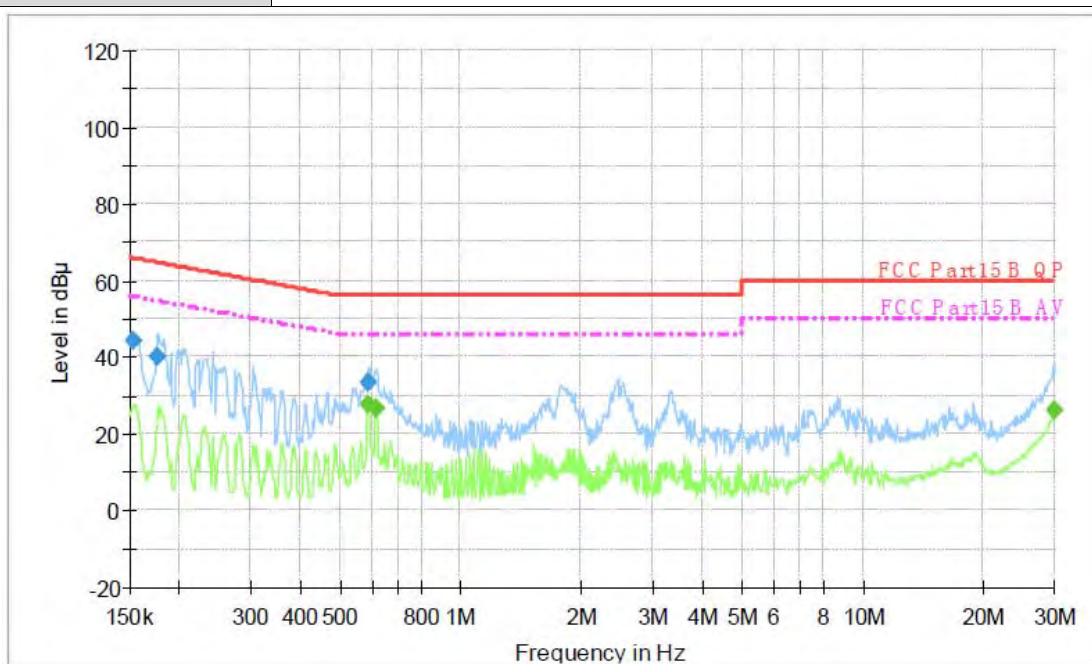

Final Measurement Detector 1

Frequency (MHz)	QuasiPeak (dBμ V)	Meas. Time (ms)	Bandwidth (kHz)	Filter	Line	Corr. (dB)	Margin (dB)	Limit (dBμ V)	Comment
0.154250	44.4	1000.00	9.000	On	N	10.0	21.4	65.8	
0.175970	40.1	1000.00	9.000	On	N	10.0	24.7	64.7	
0.589870	33.2	1000.00	9.000	On	N	10.0	22.8	56.0	

Final Measurement Detector 2

Frequency (MHz)	Average (dBμ V)	Meas. Time (ms)	Bandwidth (kHz)	Filter	Line	Corr. (dB)	Margin (dB)	Limit (dBμ V)	Comment
0.587520	27.5	1000.00	9.000	On	N	10.0	18.5	46.0	
0.616350	26.8	1000.00	9.000	On	N	10.0	19.2	46.0	
30.000000	26.2	1000.00	9.000	On	N	10.0	23.8	50.0	

Emission Level= Read Level+ Correct Factor

3.2. Radiated Emission

Limit

FCC CFR Title 47 Part 15 Subpart C Section 15.209/ RSS – Gen 8.9:

Frequency	Limit (dBuV/m @3m)	Value
30 MHz ~ 88 MHz	40.00	Quasi-peak
88 MHz ~ 216 MHz	43.50	Quasi-peak
216 MHz ~ 960 MHz	46.00	Quasi-peak
960 MHz ~ 1 GHz	54.00	Quasi-peak
Above 1 GHz	54.00	Average
	74.00	Peak

Note:

- (1) The tighter limit applies at the band edges.
- (2) Emission Level (dBuV/m)=20log Emission Level (uV/m).

Test Configuration

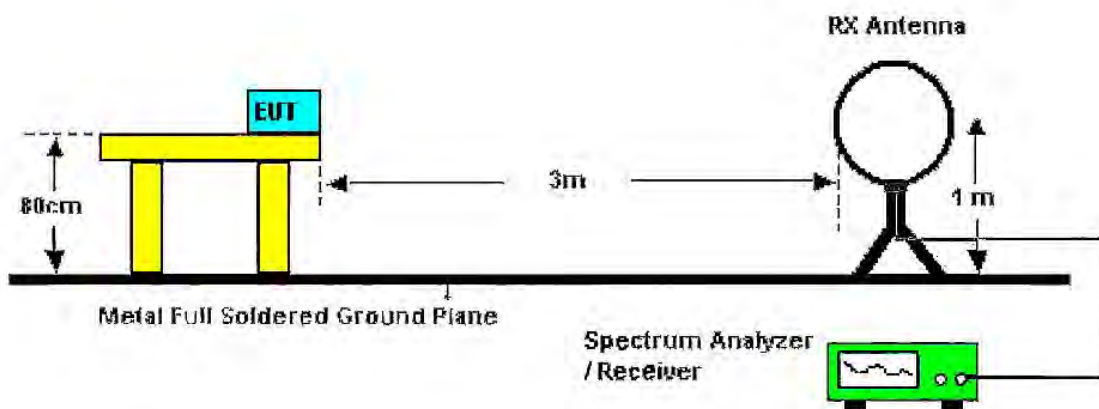

Below 30MHz Test Setup

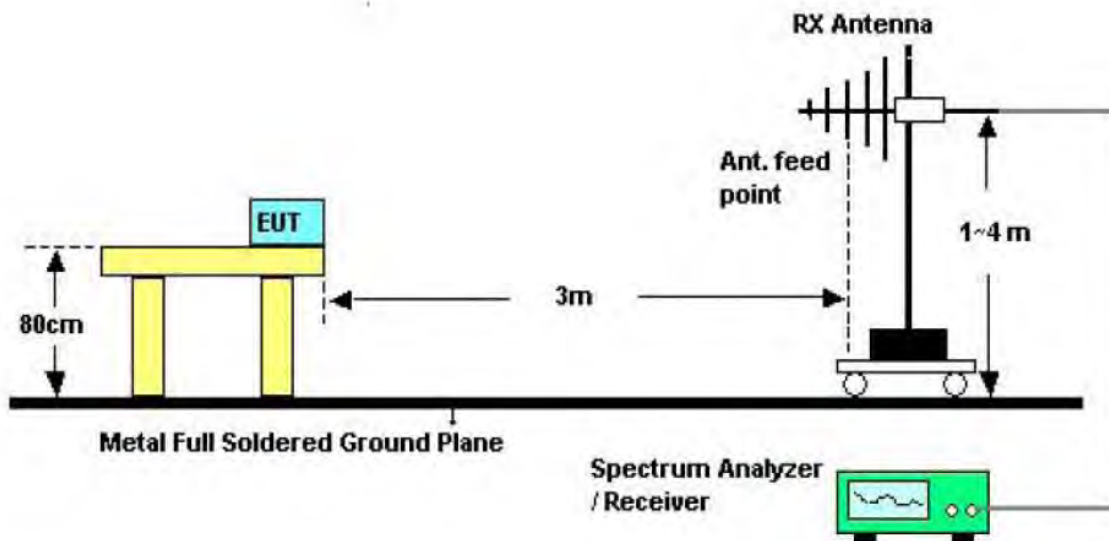

Below 1000MHz Test Setup

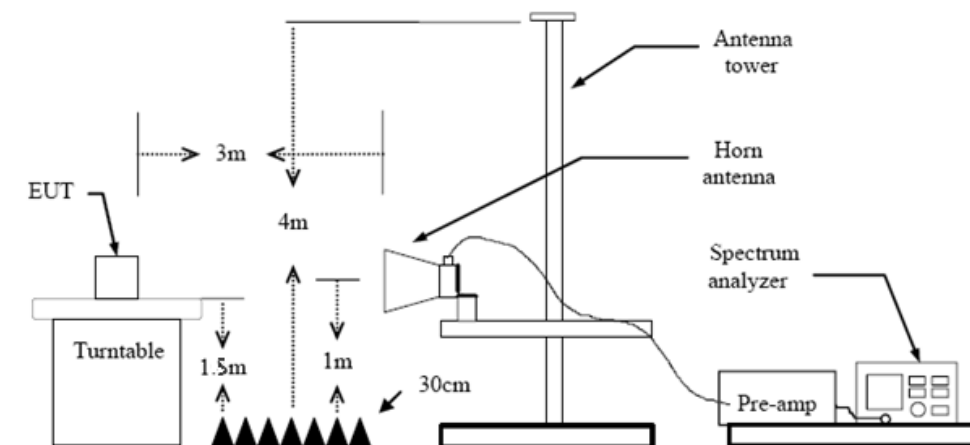

Above 1GHz Test Setup

Test Procedure

1. The EUT was setup and tested according to ANSI C63.10:2013
 2. The EUT is placed on a turn table which is 0.8 meter above ground for below 1 GHz, and 1.5 m for above 1 GHz. The turn table is rotated 360 degrees to determine the position of the maximum emission level.
 3. The EUT was set 3 meters from the receiving antenna, which was mounted on the top of a variable height antenna tower.
 4. For each suspected emission, the EUT was arranged to its worst case and then tune the Antenna tower (from 1 m to 4 m) and turntable (from 0 degree to 360 degrees) to find the maximum reading. A pre-amp and a high pass filter are used for the test in order to get better signal level to comply with the guidelines.
 5. Set to the maximum power setting and enable the EUT transmit continuously.
 6. Use the following spectrum analyzer settings
 - (1) Span shall wide enough to fully capture the emission being measured;
 - (2) Below 1 GHz:
RBW=120 kHz, VBW=300 kHz, Sweep=auto, Detector function=peak, Trace=max hold;
If the emission level of the EUT measured by the peak detector is 3 dB lower than the applicable limit, the peak emission level will be reported. Otherwise, the emission measurement will be repeated using the quasi-peak detector and reported.
 - (3) From 1 GHz to 10th harmonic:
RBW=1MHz, VBW=3MHz Peak detector for Peak value.
RBW=1MHz, VBW \geq 1/T Peak detector for Average value.
- Note 1: For the 1/T & Duty Cycle please refer to clause 3.8 Duty Cycle.

Test Mode

Please refer to the clause 2.4.

Test Result

9 KHz~30 MHz

From 9 KHz to 30 MHz: Conclusion: PASS

Note: The amplitude of spurious emissions which are attenuated by more than 20dB below the permissible value has no need to be reported.

Pre-scan all antenna, only show the test data for worse case antenna on the test report.



30MHz-1GHz

Transformer type:	Integrated transformer
Ant. Pol.	Horizontal
Test Mode:	Ant 1 + Ant 2 802.11b Mode 2412MHz
Remark:	Only worse case is reported



No.	Frequency (MHz)	Reading (dBuV)	Factor (dB/m)	Level (dBuV/m)	Limit (dBuV/m)	Margin (dB)	Detector
1	249.8667	56.00	-16.19	39.81	46.00	-6.19	QP
2 *	374.9967	53.39	-12.29	41.10	46.00	-4.90	QP
3	500.1267	47.98	-9.57	38.41	46.00	-7.59	QP
4	750.0633	41.93	-3.62	38.31	46.00	-7.69	QP
5	799.8567	38.46	-2.78	35.68	46.00	-10.32	QP
6 !	874.8700	42.31	-2.02	40.29	46.00	-5.71	QP

Remarks:

- 1. Factor (dB/m) = Antenna Factor (dB/m)+Cable Factor (dB)-Pre-amplifier Factor
- 2. Margin value = Level -Limit value



Transformer type:	Integrated transformer
Ant. Pol.	Vertical
Test Mode:	Ant 1 + Ant 2 802.11b Mode 2412MHz
Remark:	Only worse case is reported



No.	Frequency (MHz)	Reading (dBuV)	Factor (dB/m)	Level (dBuV/m)	Limit (dBuV/m)	Margin (dB)	Detector
1 !	33.2333	49.60	-14.78	34.82	40.00	-5.18	QP
2	64.2733	50.20	-16.49	33.71	40.00	-6.29	QP
3 !	148.9866	53.49	-14.42	39.07	43.50	-4.43	QP
4 !	374.9967	52.71	-12.29	40.42	46.00	-5.58	QP
5	500.1267	48.05	-9.57	38.48	46.00	-7.52	QP
6 *	874.8700	44.60	-2.02	42.58	46.00	-3.42	QP

Remarks:

- Factor (dB/m) = Antenna Factor (dB/m)+Cable Factor (dB)-Pre-amplifier Factor
- Margin value = Level -Limit value



Transformer type:	Separate transformer
Ant. Pol.	Horizontal
Test Mode:	Ant 1 + Ant 2 802.11b Mode 2412MHz
Remark:	Only worse case is reported



No.	Frequency (MHz)	Reading (dBuV)	Factor (dB/m)	Level (dBuV/m)	Limit (dBuV/m)	Margin (dB)	Detector
1	146.0767	39.29	-14.68	24.61	43.50	-18.89	QP
2	163.8600	45.05	-14.46	30.59	43.50	-12.91	QP
3 *	374.9967	46.73	-12.29	34.44	46.00	-11.56	QP
4	500.1267	40.65	-9.57	31.08	46.00	-14.92	QP
5	624.9333	35.05	-5.90	29.15	46.00	-16.85	QP
6	750.0633	35.21	-3.62	31.59	46.00	-14.41	QP

Remarks:

1. Factor (dB/m) = Antenna Factor (dB/m)+Cable Factor (dB)-Pre-amplifier Factor
2. Margin value = Level -Limit value



Transformer type:	Separate transformer
Ant. Pol.	Vertical
Test Mode:	Ant 1 + Ant 2 802.11b Mode 2412MHz
Remark:	Only worse case is reported

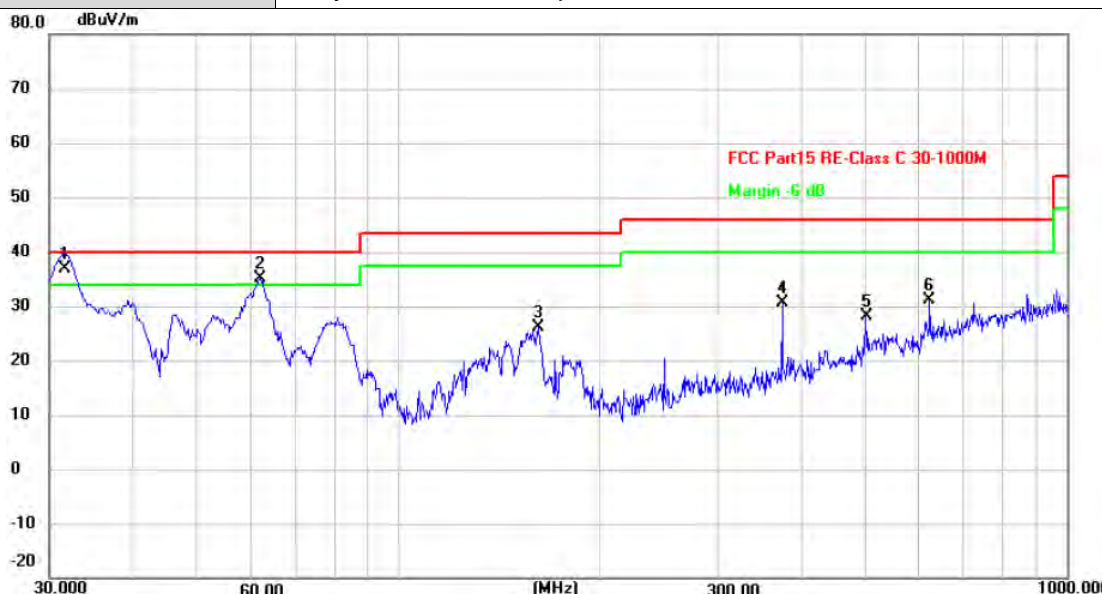

No.	Frequency (MHz)	Reading (dBuV)	Factor (dB/m)	Level (dBuV/m)	Limit (dBuV/m)	Margin (dB)	Detector
1 *	31.6167	51.64	-14.83	36.81	40.00	-3.19	QP
2 !	62.0100	51.17	-16.03	35.14	40.00	-4.86	QP
3	162.2433	40.46	-14.42	26.04	43.50	-17.46	QP
4	374.9967	42.89	-12.29	30.60	46.00	-15.40	QP
5	500.1267	37.71	-9.57	28.14	46.00	-17.86	QP
6	624.9333	37.02	-5.90	31.12	46.00	-14.88	QP

Remarks:

- Factor (dB/m) = Antenna Factor (dB/m)+Cable Factor (dB)-Pre-amplifier Factor
- Margin value = Level -Limit value



Adobe 1GHz

Ant No.:	Ant 1 + Ant 2
Ant. Pol.	Horizontal
Test Mode:	TX 802.11b Mode 2412MHz
Remark:	No report for the emission which more than 10 dB below the prescribed limit.

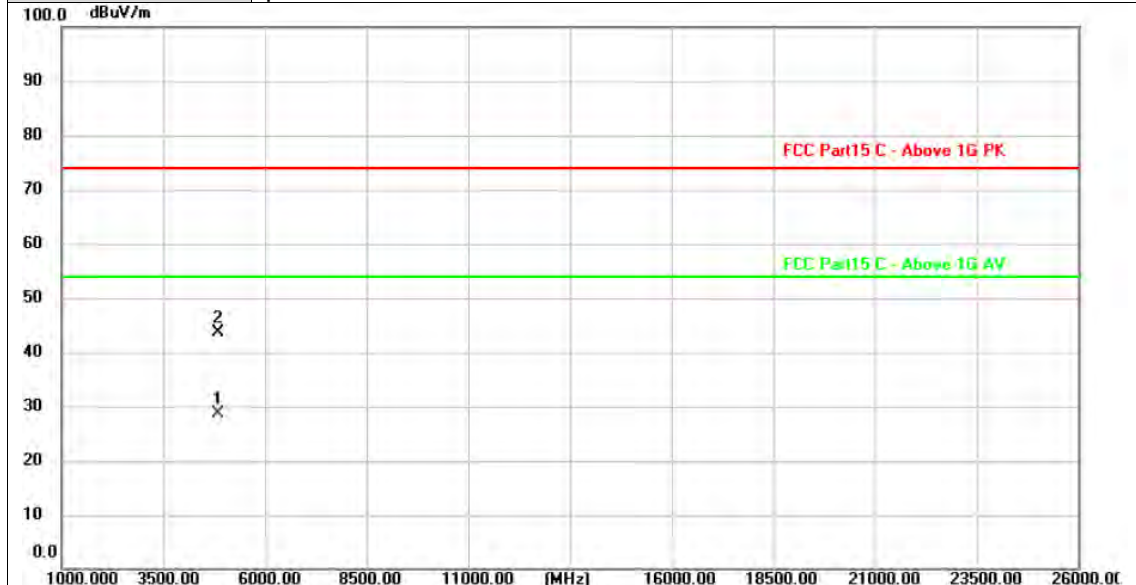

No.	Frequency (MHz)	Reading (dBuV)	Factor (dB/m)	Level (dBuV/m)	Limit (dBuV/m)	Margin (dB)	Detector
1 *	4823.147	26.01	2.62	28.63	54.00	-25.37	AVG
2	4823.938	40.90	2.62	43.52	74.00	-30.48	peak

Remarks:

1. Factor (dB/m) = Antenna Factor (dB/m)+Cable Factor (dB)-Pre-amplifier Factor
2. Margin value = Level -Limit value



Ant No.:	Ant 1 + Ant 2
Ant. Pol.	Vertical
Test Mode:	TX 802.11b Mode 2412MHz
Remark:	No report for the emission which more than 10 dB below the prescribed limit.

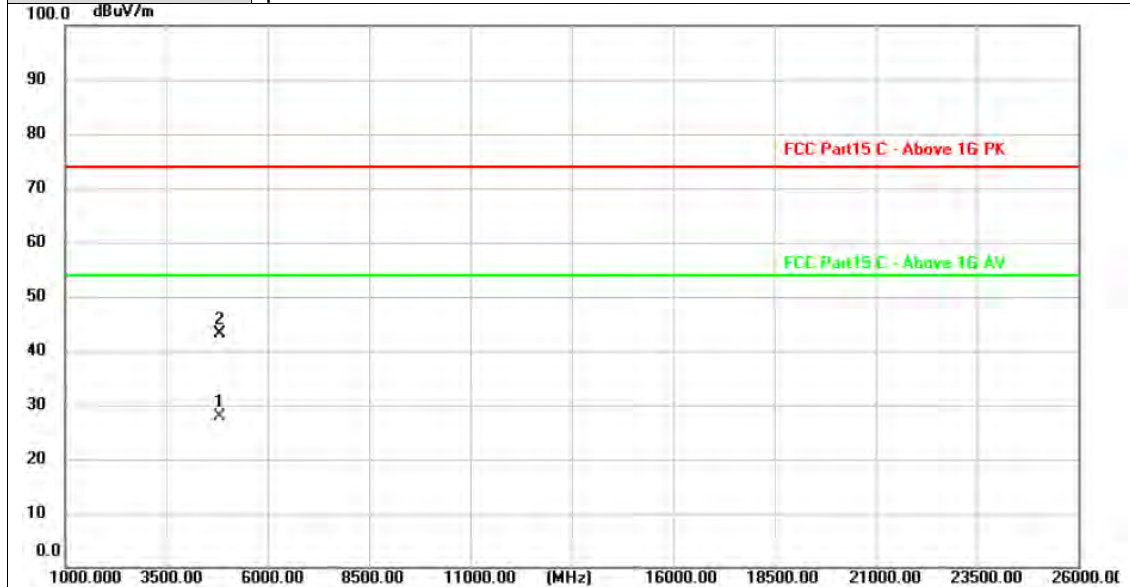

No.	Frequency (MHz)	Reading (dBuV)	Factor (dB/m)	Level (dBuV/m)	Limit (dBuV/m)	Margin (dB)	Detector
1 *	4823.802	25.31	2.62	27.93	54.00	-26.07	AVG
2	4823.961	40.58	2.62	43.20	74.00	-30.80	peak

Remarks:

- 1. Factor (dB/m) = Antenna Factor (dB/m)+Cable Factor (dB)-Pre-amplifier Factor
- 2. Margin value = Level -Limit value



Ant No.:	Ant 1 + Ant 2
Ant. Pol.	Horizontal
Test Mode:	TX 802.11b Mode 2437MHz
Remark:	No report for the emission which more than 10 dB below the prescribed limit.



No.	Frequency (MHz)	Reading (dBuV)	Factor (dB/m)	Level (dBuV/m)	Limit (dBuV/m)	Margin (dB)	Detector
1 *	4874.675	26.13	2.78	28.91	54.00	-25.09	AVG
2	4874.677	40.62	2.78	43.40	74.00	-30.60	peak

Remarks:
 1. Factor (dB/m) = Antenna Factor (dB/m)+Cable Factor (dB)-Pre-amplifier Factor
 2. Margin value = Level -Limit value



Ant No.:	Ant 1 + Ant 2
Ant. Pol.	Vertical
Test Mode:	TX 802.11b Mode 2437MHz
Remark:	No report for the emission which more than 10 dB below the prescribed limit.

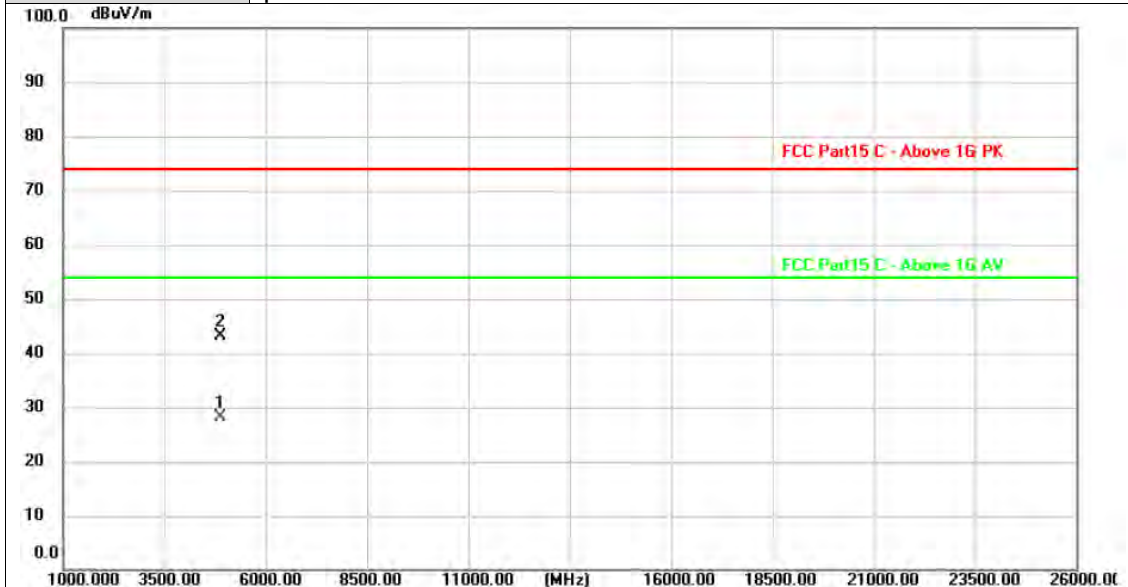

No.	Frequency (MHz)	Reading (dBuV)	Factor (dB/m)	Level (dBuV/m)	Limit (dBuV/m)	Margin (dB)	Detector
1 *	4873.682	25.47	2.78	28.25	54.00	-25.75	AVG
2	4874.941	40.33	2.78	43.11	74.00	-30.89	peak

Remarks:

- 1. Factor (dB/m) = Antenna Factor (dB/m)+Cable Factor (dB)-Pre-amplifier Factor
- 2. Margin value = Level -Limit value



Ant No.:	Ant 1 + Ant 2
Ant. Pol.	Horizontal
Test Mode:	TX 802.11b Mode 2462MHz
Remark:	No report for the emission which more than 10 dB below the prescribed limit.

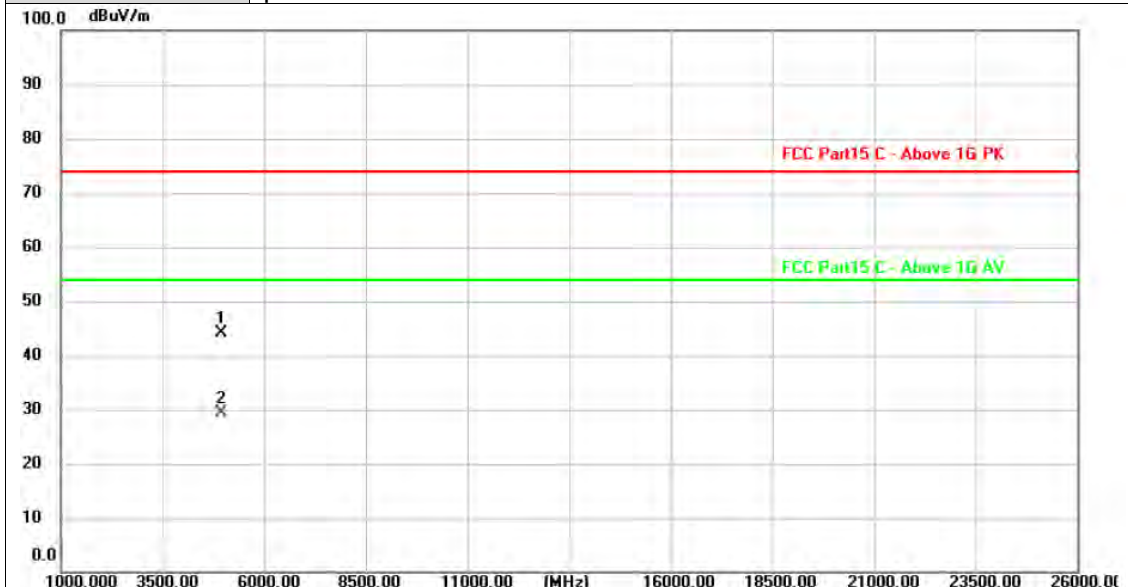

No.	Frequency (MHz)	Reading (dBuV)	Factor (dB/m)	Level (dBuV/m)	Limit (dBuV/m)	Margin (dB)	Detector
1	4923.920	41.25	2.93	44.18	74.00	-29.82	peak
2 *	4924.069	26.46	2.93	29.39	54.00	-24.61	AVG

Remarks:

- 1. Factor (dB/m) = Antenna Factor (dB/m)+Cable Factor (dB)-Pre-amplifier Factor
- 2. Margin value = Level -Limit value



Ant No.:	Ant 1 + Ant 2
Ant. Pol.	Vertical
Test Mode:	TX 802.11b Mode 2462MHz
Remark:	No report for the emission which more than 10 dB below the prescribed limit.



No.	Frequency (MHz)	Reading (dBuV)	Factor (dB/m)	Level (dBuV/m)	Limit (dBuV/m)	Margin (dB)	Detector
1 *	4924.181	24.58	2.93	27.51	54.00	-26.49	AVG
2	4924.587	41.12	2.93	44.05	74.00	-29.95	peak

Remarks:
 1. Factor (dB/m) = Antenna Factor (dB/m)+Cable Factor (dB)-Pre-amplifier Factor
 2. Margin value = Level -Limit value



Ant No.:	Ant 1 + Ant 2
Ant. Pol.	Horizontal
Test Mode:	TX 802.11g Mode 2412MHz
Remark:	No report for the emission which more than 10 dB below the prescribed limit.

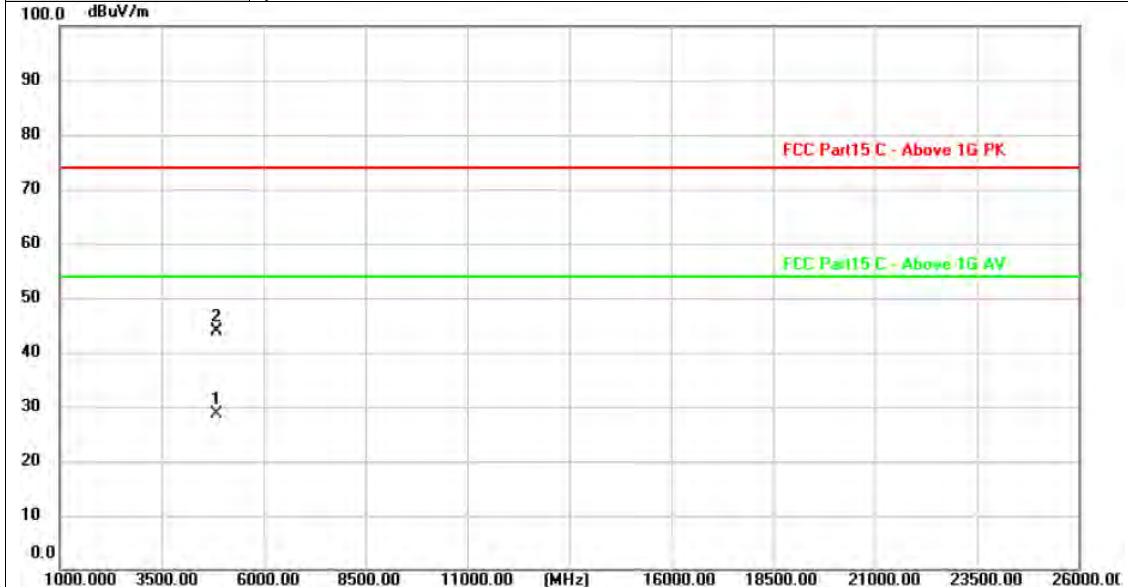

No.	Frequency (MHz)	Reading (dBuV)	Factor (dB/m)	Level (dBuV/m)	Limit (dBuV/m)	Margin (dB)	Detector
1 *	4823.857	26.05	2.62	28.67	54.00	-25.33	AVG
2	4824.854	41.25	2.62	43.87	74.00	-30.13	peak

Remarks:
 1. Factor (dB/m) = Antenna Factor (dB/m)+Cable Factor (dB)-Pre-amplifier Factor
 2. Margin value = Level -Limit value



Ant No.:	Ant 1 + Ant 2
Ant. Pol.	Vertical
Test Mode:	TX 802.11g Mode 2412MHz
Remark:	No report for the emission which more than 10 dB below the prescribed limit.

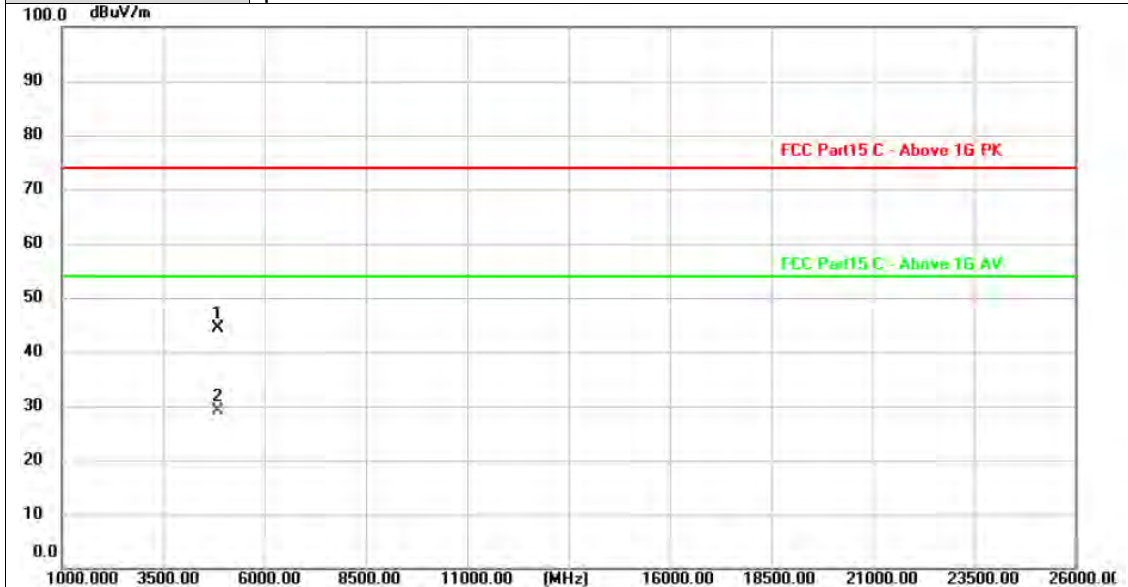

No.	Frequency (MHz)	Reading (dBuV)	Factor (dB/m)	Level (dBuV/m)	Limit (dBuV/m)	Margin (dB)	Detector
1	4823.197	41.67	2.62	44.29	74.00	-29.71	peak
2 *	4824.173	26.53	2.62	29.15	54.00	-24.85	AVG

Remarks:

- 1. Factor (dB/m) = Antenna Factor (dB/m)+Cable Factor (dB)-Pre-amplifier Factor
- 2. Margin value = Level -Limit value



Ant No.:	Ant 1 + Ant 2
Ant. Pol.	Horizontal
Test Mode:	TX 802.11g Mode 2437MHz
Remark:	No report for the emission which more than 10 dB below the prescribed limit.

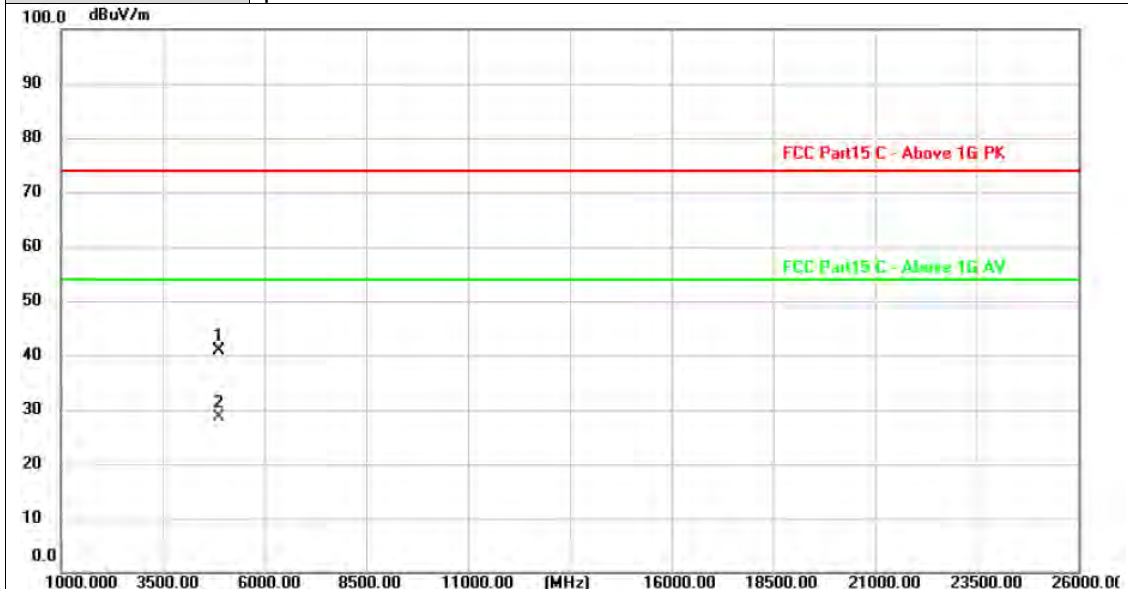

No.	Frequency (MHz)	Reading (dBuV)	Factor (dB/m)	Level (dBuV/m)	Limit (dBuV/m)	Margin (dB)	Detector
1	4873.056	38.03	2.78	40.81	74.00	-33.19	peak
2 *	4874.712	25.86	2.78	28.64	54.00	-25.36	AVG

Remarks:

- 1. Factor (dB/m) = Antenna Factor (dB/m)+Cable Factor (dB)-Pre-amplifier Factor
- 2. Margin value = Level -Limit value



Ant No.:	Ant 1 + Ant 2
Ant. Pol.	Vertical
Test Mode:	TX 802.11g Mode 2437MHz
Remark:	No report for the emission which more than 10 dB below the prescribed limit.

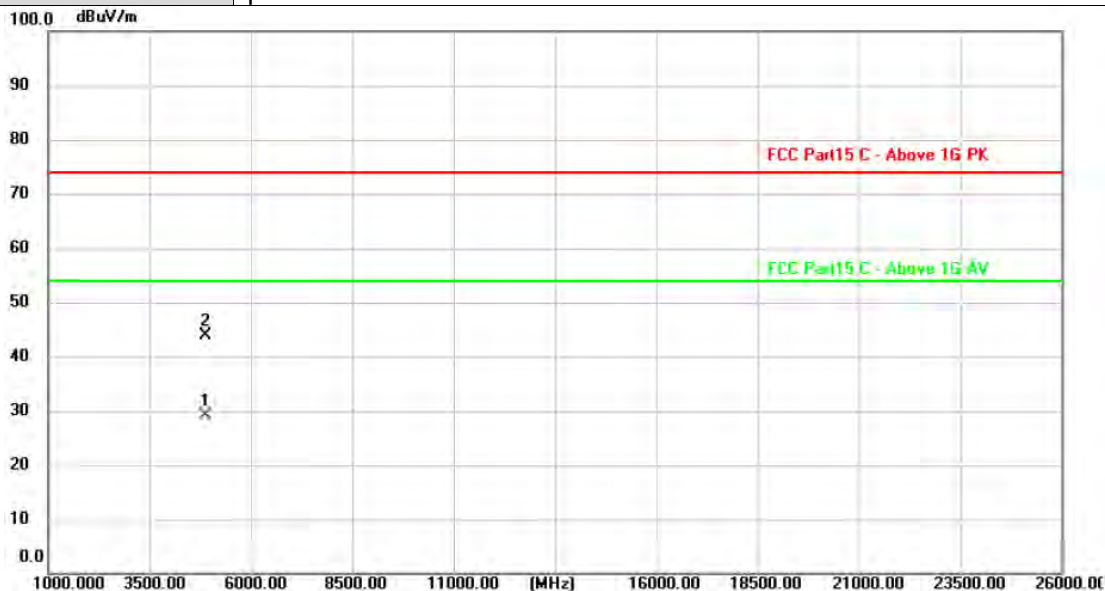

No.	Frequency (MHz)	Reading (dBuV)	Factor (dB/m)	Level (dBuV/m)	Limit (dBuV/m)	Margin (dB)	Detector
1 *	4874.061	26.31	2.78	29.09	54.00	-24.91	AVG
2	4874.575	41.08	2.78	43.86	74.00	-30.14	peak

Remarks:

- 1. Factor (dB/m) = Antenna Factor (dB/m)+Cable Factor (dB)-Pre-amplifier Factor
- 2. Margin value = Level -Limit value



Ant No.:	Ant 1 + Ant 2
Ant. Pol.	Horizontal
Test Mode:	TX 802.11g Mode 2462MHz
Remark:	No report for the emission which more than 10 dB below the prescribed limit.

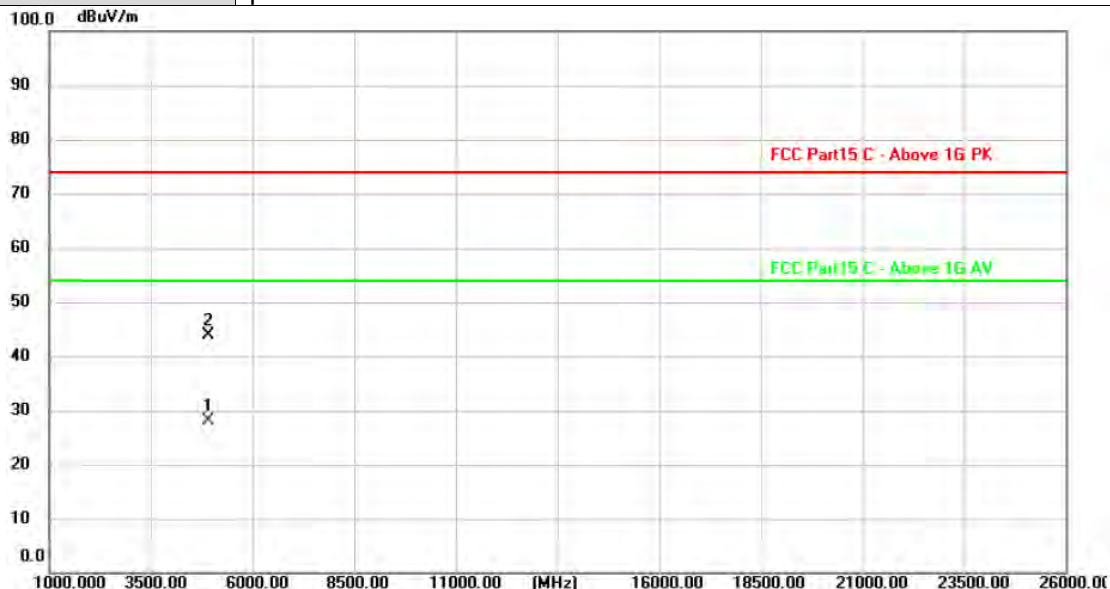

No.	Frequency (MHz)	Reading (dBuV)	Factor (dB/m)	Level (dBuV/m)	Limit (dBuV/m)	Margin (dB)	Detector
1 *	4923.071	25.29	2.93	28.22	54.00	-25.78	AVG
2	4923.799	40.93	2.93	43.86	74.00	-30.14	peak

Remarks:

- Factor (dB/m) = Antenna Factor (dB/m)+Cable Factor (dB)-Pre-amplifier Factor
- Margin value = Level -Limit value



Ant No.:	Ant 1 + Ant 2
Ant. Pol.	Vertical
Test Mode:	TX 802.11g Mode 2462MHz
Remark:	No report for the emission which more than 10 dB below the prescribed limit.

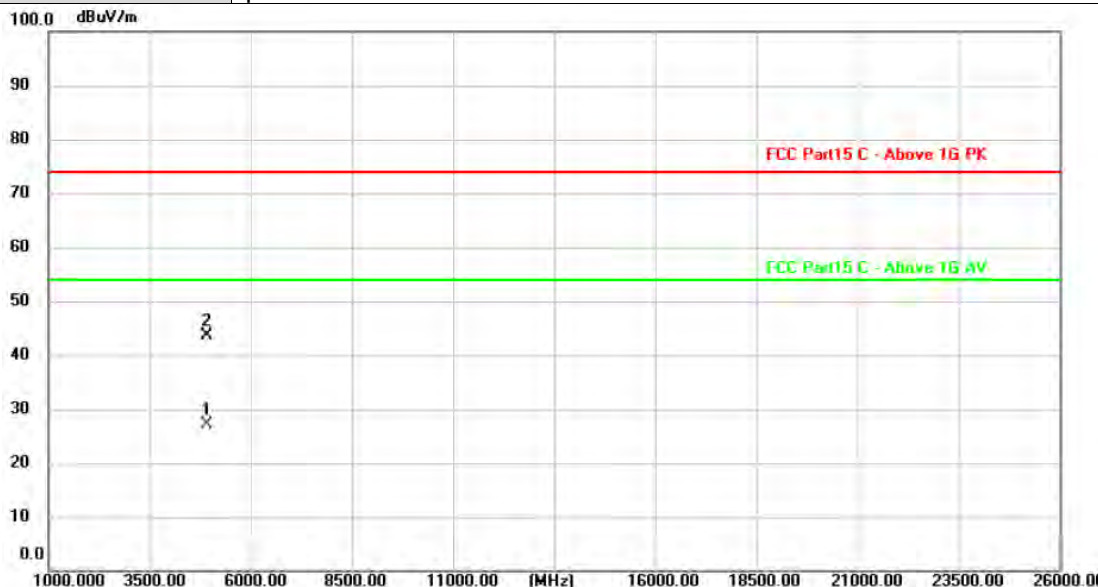

No.	Frequency (MHz)	Reading (dBuV)	Factor (dB/m)	Level (dBuV/m)	Limit (dBuV/m)	Margin (dB)	Detector
1 *	4924.145	24.21	2.93	27.14	54.00	-26.86	AVG
2	4924.967	40.77	2.93	43.70	74.00	-30.30	peak

Remarks:
 1. Factor (dB/m) = Antenna Factor (dB/m)+Cable Factor (dB)-Pre-amplifier Factor
 2. Margin value = Level -Limit value



Ant No.:	Ant 1 + Ant 2
Ant. Pol.	Horizontal
Test Mode:	TX 802.11n(HT20) Mode 2412MHz
Remark:	No report for the emission which more than 10 dB below the prescribed limit.



No.	Frequency (MHz)	Reading (dBuV)	Factor (dB/m)	Level (dBuV/m)	Limit (dBuV/m)	Margin (dB)	Detector
1 *	4823.117	26.35	2.62	28.97	54.00	-25.03	AVG
2	4823.862	41.59	2.62	44.21	74.00	-29.79	peak

Remarks:

- 1. Factor (dB/m) = Antenna Factor (dB/m)+Cable Factor (dB)-Pre-amplifier Factor
- 2. Margin value = Level -Limit value



Ant No.:	Ant 1 + Ant 2
Ant. Pol.	Vertical
Test Mode:	TX 802.11n(HT20) Mode 2412MHz
Remark:	No report for the emission which more than 10 dB below the prescribed limit.



No.	Frequency (MHz)	Reading (dBuV)	Factor (dB/m)	Level (dBuV/m)	Limit (dBuV/m)	Margin (dB)	Detector
1	4823.717	40.71	2.62	43.33	74.00	-30.67	peak
2 *	4823.763	26.29	2.62	28.91	54.00	-25.09	AVG

Remarks:
 1. Factor (dB/m) = Antenna Factor (dB/m)+Cable Factor (dB)-Pre-amplifier Factor
 2. Margin value = Level -Limit value



Ant No.:	Ant 1 + Ant 2
Ant. Pol.	Horizontal
Test Mode:	TX 802.11n(HT20) Mode 2437MHz
Remark:	No report for the emission which more than 10 dB below the prescribed limit.



No.	Frequency (MHz)	Reading (dBuV)	Factor (dB/m)	Level (dBuV/m)	Limit (dBuV/m)	Margin (dB)	Detector
1	4873.727	41.13	2.78	43.91	74.00	-30.09	peak
2 *	4873.815	25.91	2.78	28.69	54.00	-25.31	AVG

Remarks:

1. Factor (dB/m) = Antenna Factor (dB/m)+Cable Factor (dB)-Pre-amplifier Factor
2. Margin value = Level -Limit value



Ant No.:	Ant 1 + Ant 2
Ant. Pol.	Vertical
Test Mode:	TX 802.11n(HT20) Mode 2437MHz
Remark:	No report for the emission which more than 10 dB below the prescribed limit.

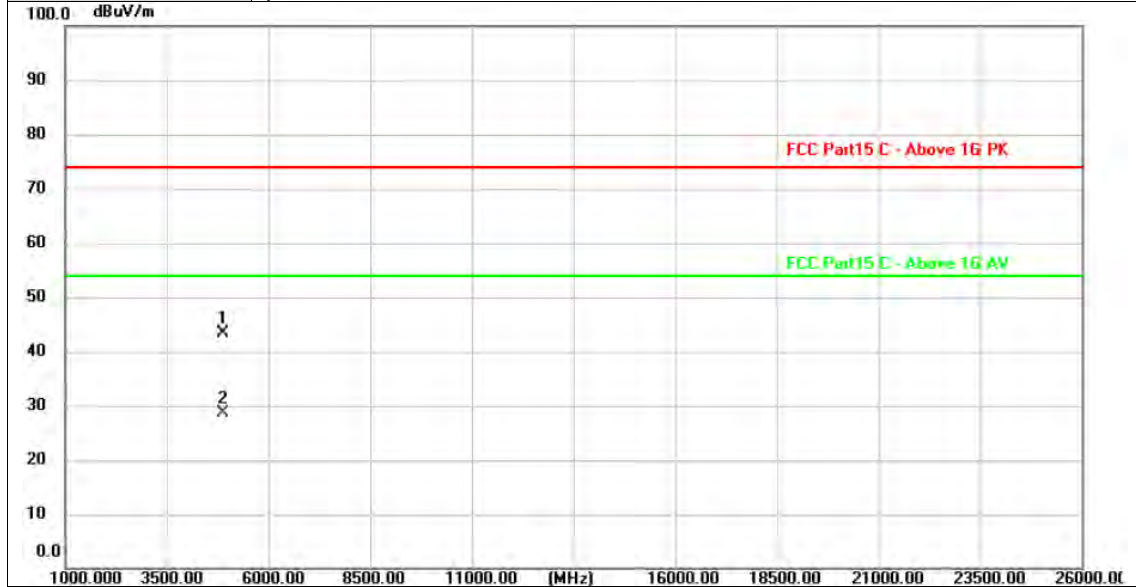

No.	Frequency (MHz)	Reading (dBuV)	Factor (dB/m)	Level (dBuV/m)	Limit (dBuV/m)	Margin (dB)	Detector
1	4873.005	40.65	2.78	43.43	74.00	-30.57	peak
2 *	4873.921	25.87	2.78	28.65	54.00	-25.35	AVG

Remarks:
 1. Factor (dB/m) = Antenna Factor (dB/m)+Cable Factor (dB)-Pre-amplifier Factor
 2. Margin value = Level -Limit value



Ant No.:	Ant 1 + Ant 2
Ant. Pol.	Horizontal
Test Mode:	TX 802.11n(HT20) Mode 2462MHz
Remark:	No report for the emission which more than 10 dB below the prescribed limit.

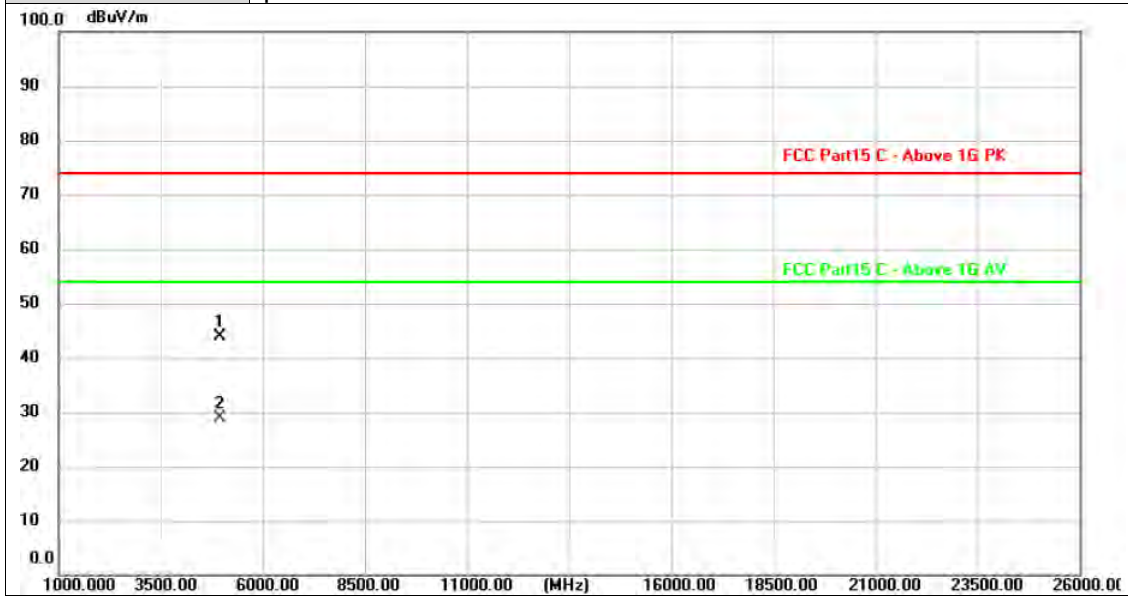

No.	Frequency (MHz)	Reading (dBuV)	Factor (dB/m)	Level (dBuV/m)	Limit (dBuV/m)	Margin (dB)	Detector
1	4923.329	40.92	2.93	43.85	74.00	-30.15	peak
2 *	4924.723	25.95	2.93	28.88	54.00	-25.12	AVG

Remarks:
 1. Factor (dB/m) = Antenna Factor (dB/m)+Cable Factor (dB)-Pre-amplifier Factor
 2. Margin value = Level -Limit value



Ant No.:	Ant 1 + Ant 2
Ant. Pol.	Vertical
Test Mode:	TX 802.11n(HT20) Mode 2462MHz
Remark:	No report for the emission which more than 10 dB below the prescribed limit.



No.	Frequency (MHz)	Reading (dBuV)	Factor (dB/m)	Level (dBuV/m)	Limit (dBuV/m)	Margin (dB)	Detector
1	4923.025	40.54	2.93	43.47	74.00	-30.53	peak
2 *	4924.082	25.69	2.93	28.62	54.00	-25.38	AVG

Remarks:
 1. Factor (dB/m) = Antenna Factor (dB/m)+Cable Factor (dB)-Pre-amplifier Factor
 2. Margin value = Level -Limit value



Ant No.:	Ant 1 + Ant 2
Ant. Pol.	Horizontal
Test Mode:	TX 802.11n(HT40) Mode 2422MHz
Remark:	No report for the emission which more than 10 dB below the prescribed limit.



No.	Frequency (MHz)	Reading (dBuV)	Factor (dB/m)	Level (dBuV/m)	Limit (dBuV/m)	Margin (dB)	Detector
1	4843.203	40.27	2.68	42.95	74.00	-31.05	peak
2 *	4844.063	26.59	2.68	29.27	54.00	-24.73	AVG

Remarks:

1. Factor (dB/m) = Antenna Factor (dB/m)+Cable Factor (dB)-Pre-amplifier Factor
2. Margin value = Level -Limit value



Ant No.:	Ant 1 + Ant 2
Ant. Pol.	Vertical
Test Mode:	TX 802.11n(HT40) Mode 2422MHz
Remark:	No report for the emission which more than 10 dB below the prescribed limit.

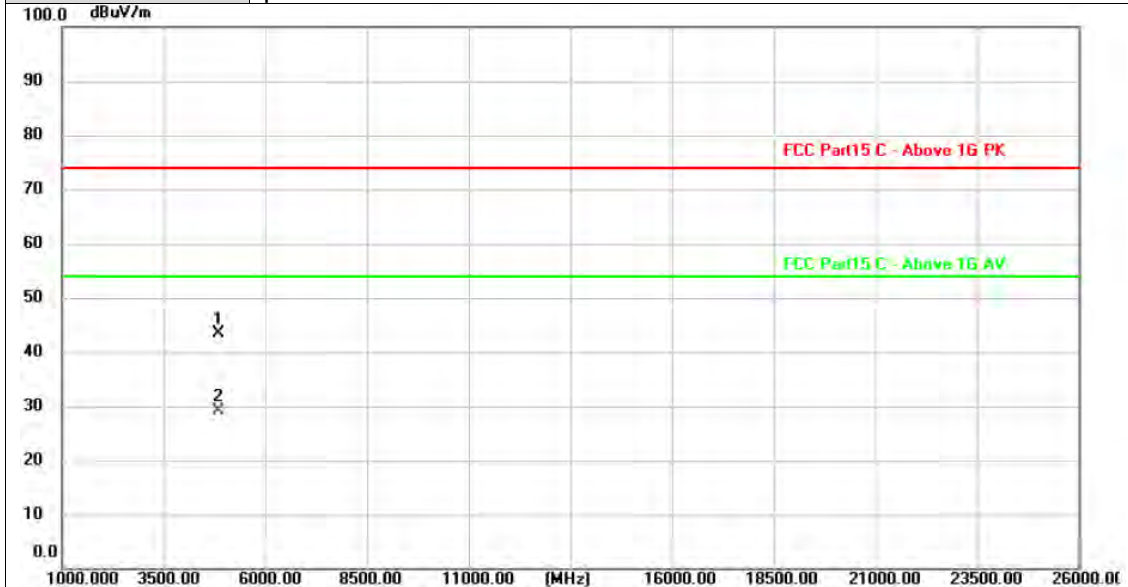

No.	Frequency (MHz)	Reading (dBuV)	Factor (dB/m)	Level (dBuV/m)	Limit (dBuV/m)	Margin (dB)	Detector
1	4843.127	40.63	2.68	43.31	74.00	-30.69	peak
2 *	4844.253	26.48	2.68	29.16	54.00	-24.84	AVG

Remarks:

1. Factor (dB/m) = Antenna Factor (dB/m)+Cable Factor (dB)-Pre-amplifier Factor
2. Margin value = Level -Limit value



Ant No.:	Ant 1 + Ant 2
Ant. Pol.	Horizontal
Test Mode:	TX 802.11n(HT40) Mode 2437MHz
Remark:	No report for the emission which more than 10 dB below the prescribed limit.



No.	Frequency (MHz)	Reading (dBuV)	Factor (dB/m)	Level (dBuV/m)	Limit (dBuV/m)	Margin (dB)	Detector
1 *	4874.151	25.93	2.78	28.71	54.00	-25.29	AVG
2	4874.525	40.81	2.78	43.59	74.00	-30.41	peak

Remarks:

- Factor (dB/m) = Antenna Factor (dB/m)+Cable Factor (dB)-Pre-amplifier Factor
- Margin value = Level -Limit value



Ant No.:	Ant 1 + Ant 2
Ant. Pol.	Vertical
Test Mode:	TX 802.11n(HT40) Mode 2437MHz
Remark:	No report for the emission which more than 10 dB below the prescribed limit.



No.	Frequency (MHz)	Reading (dBuV)	Factor (dB/m)	Level (dBuV/m)	Limit (dBuV/m)	Margin (dB)	Detector
1	4874.197	40.07	2.78	42.85	74.00	-31.15	peak
2 *	4874.277	25.83	2.78	28.61	54.00	-25.39	AVG

Remarks:

- 1. Factor (dB/m) = Antenna Factor (dB/m)+Cable Factor (dB)-Pre-amplifier Factor
- 2. Margin value = Level -Limit value



Ant No.:	Ant 1 + Ant 2
Ant. Pol.	Horizontal
Test Mode:	TX 802.11n(HT40) Mode 2452MHz
Remark:	No report for the emission which more than 10 dB below the prescribed limit.



No.	Frequency (MHz)	Reading (dBuV)	Factor (dB/m)	Level (dBuV/m)	Limit (dBuV/m)	Margin (dB)	Detector
1 *	4903.461	25.43	2.86	28.29	54.00	-25.71	AVG
2	4904.885	40.26	2.86	43.12	74.00	-30.88	peak

Remarks:
 1.Factor (dB/m) = Antenna Factor (dB/m)+Cable Factor (dB)-Pre-amplifier Factor
 2.Margin value = Level -Limit value



Ant No.:	Ant 1 + Ant 2
Ant. Pol.	Vertical
Test Mode:	TX 802.11n(HT40) Mode 2452MHz
Remark:	No report for the emission which more than 10 dB below the prescribed limit.

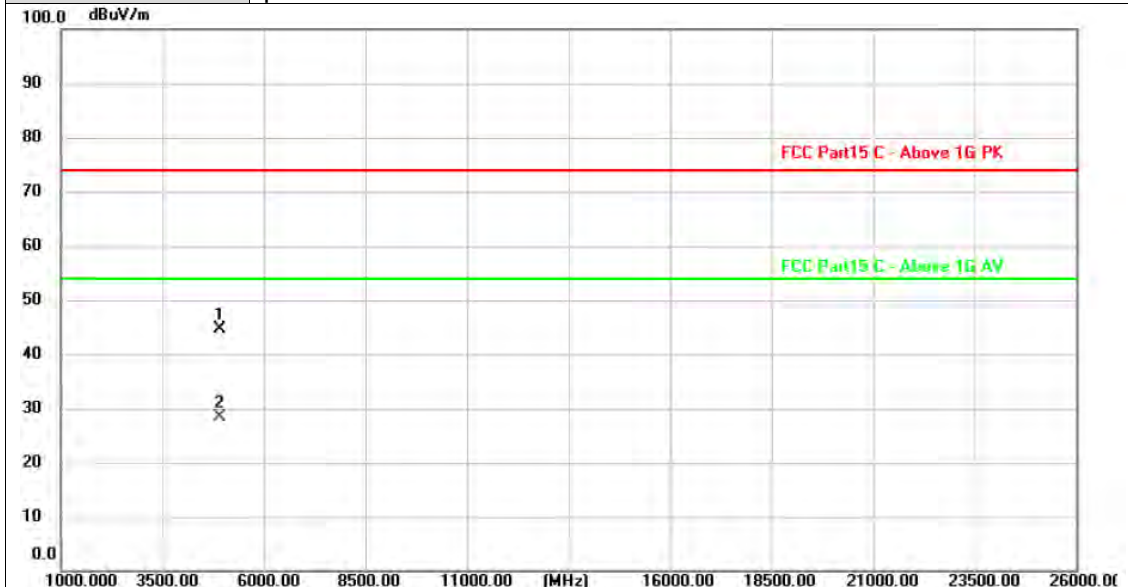

No.	Frequency (MHz)	Reading (dBuV)	Factor (dB/m)	Level (dBuV/m)	Limit (dBuV/m)	Margin (dB)	Detector
1	4903.361	41.70	2.86	44.56	74.00	-29.44	peak
2 *	4904.529	25.55	2.86	28.41	54.00	-25.59	AVG

Remarks:

- 1. Factor (dB/m) = Antenna Factor (dB/m)+Cable Factor (dB)-Pre-amplifier Factor
- 2. Margin value = Level -Limit value

3.3. Band Edge Emissions (Radiated)

Limit

FCC CFR Title 47 Part 15 Subpart C Section 15.247 (d)/ RSS 247 5.5:

Restricted Frequency Band (MHz)	(dBuV/m)(at 3m)	
	Peak	Average
2310 ~2390	74	54
2483.5 ~2500	74	54

Test Configuration

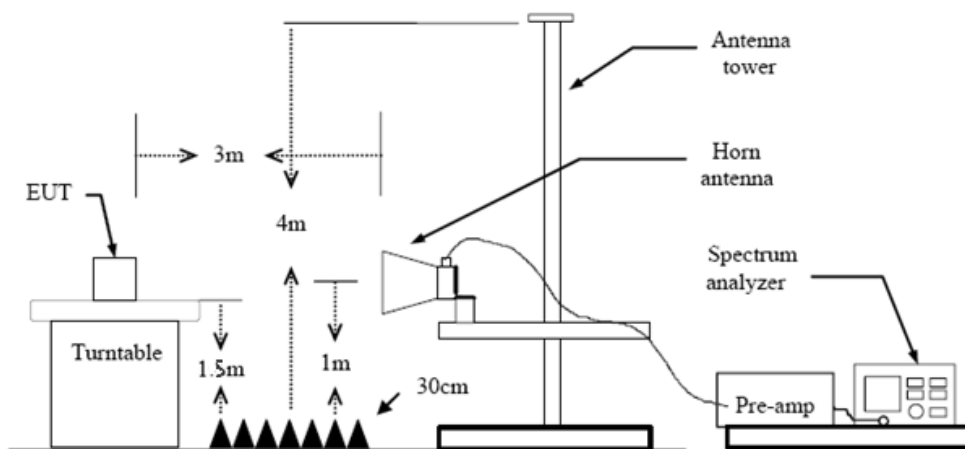

Test Procedure

1. The EUT was setup and tested according to ANSI C63.10:2013 requirements.
2. The EUT is placed on a turn table which is 1.5 meter above ground. The turn table is rotated 360 degrees to determine the position of the maximum emission level.
3. The EUT was positioned such that the distance from antenna to the EUT was 3 meters.
4. The antenna is scanned from 1 meter to 4 meters to find out the maximum emission level. This is repeated for both horizontal and vertical polarization of the antenna. In order to find the maximum emission, all of the interface cables were manipulated according to ANSI C63.10:2013 on radiated measurement.
5. The receiver set as follow:
 RBW=1MHz, VBW=3MHz Peak detector for Peak value.
 RBW=1MHz, VBW see note 1 with Peak Detector for Average Value.

Note 1: For measurements above 1 GHz the resolution bandwidth is set to 1 MHz, then the video bandwidth is set to 3 MHz for peak measurements and 1 MHz resolution bandwidth with 1/T video bandwidth with peak detector for average measurements. For the Duty Cycle please refer to clause 3.8 Duty Cycle.

Test Mode

Please refer to the clause 2.4.



Test Results

Pre-scan all antenna, only show the test data for worse case antenna on the test report.

Ant No.:	Ant 1 + Ant 2
Ant. Pol.	Horizontal
Test Mode:	802.11b Mode 2412MHz

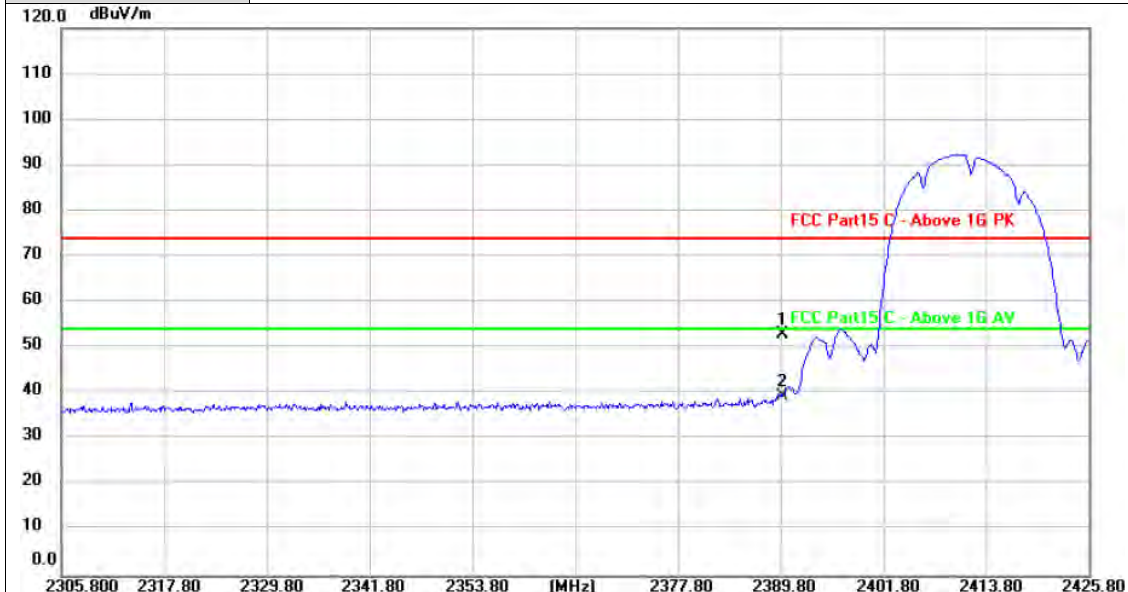

No.	Frequency (MHz)	Reading (dBuV)	Factor (dB/m)	Level (dBuV/m)	Limit (dBuV/m)	Margin (dB)	Detector
1	2390.000	22.11	30.84	52.95	74.00	-21.05	peak
2 *	2390.000	8.51	30.84	39.35	54.00	-14.65	AVG

Remarks:

- 1. Factor (dB/m) = Antenna Factor (dB/m)+Cable Factor (dB)-Pre-amplifier Factor
- 2. Margin value = Level -Limit value



Ant No.:	Ant 1 + Ant 2
Ant. Pol.	Vertical
Test Mode:	802.11b Mode 2412MHz

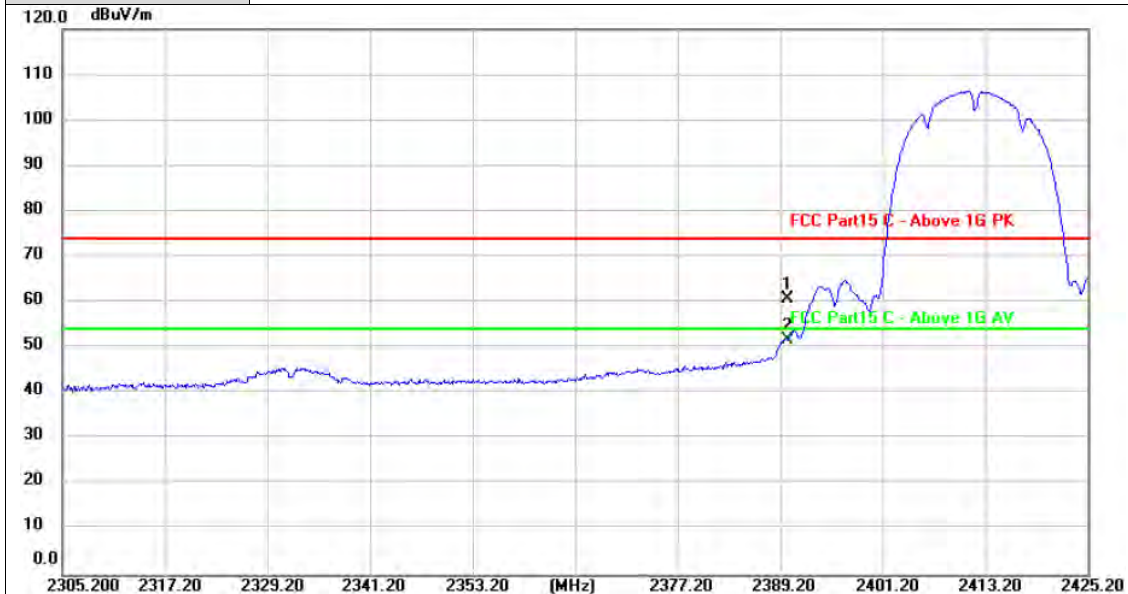

No.	Frequency (MHz)	Reading (dBuV)	Factor (dB/m)	Level (dBuV/m)	Limit (dBuV/m)	Margin (dB)	Detector
1	2390.000	29.92	30.84	60.76	74.00	-13.24	peak
2 *	2390.000	21.01	30.84	51.85	54.00	-2.15	AVG

Remarks:

1. Factor (dB/m) = Antenna Factor (dB/m)+Cable Factor (dB)-Pre-amplifier Factor
2. Margin value = Level -Limit value



Ant No.:	Ant 1 + Ant 2
Ant. Pol.	Horizontal
Test Mode:	802.11b Mode 2462 MHz

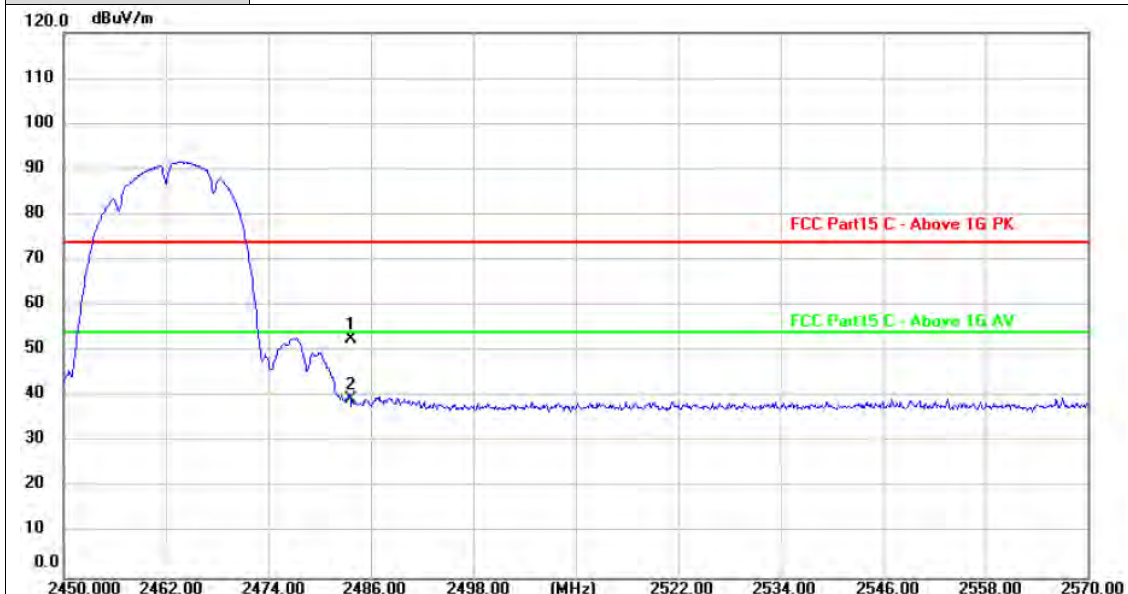

No.	Frequency (MHz)	Reading (dBuV)	Factor (dB/m)	Level (dBuV/m)	Limit (dBuV/m)	Margin (dB)	Detector
1	2483.500	21.31	31.24	52.55	74.00	-21.45	peak
2 *	2483.500	8.35	31.24	39.59	54.00	-14.41	AVG

Remarks:

1. Factor (dB/m) = Antenna Factor (dB/m)+Cable Factor (dB)-Pre-amplifier Factor
2. Margin value = Level -Limit value



Ant No.:	Ant 1 + Ant 2
Ant. Pol.	Vertical
Test Mode:	802.11b Mode 2462 MHz

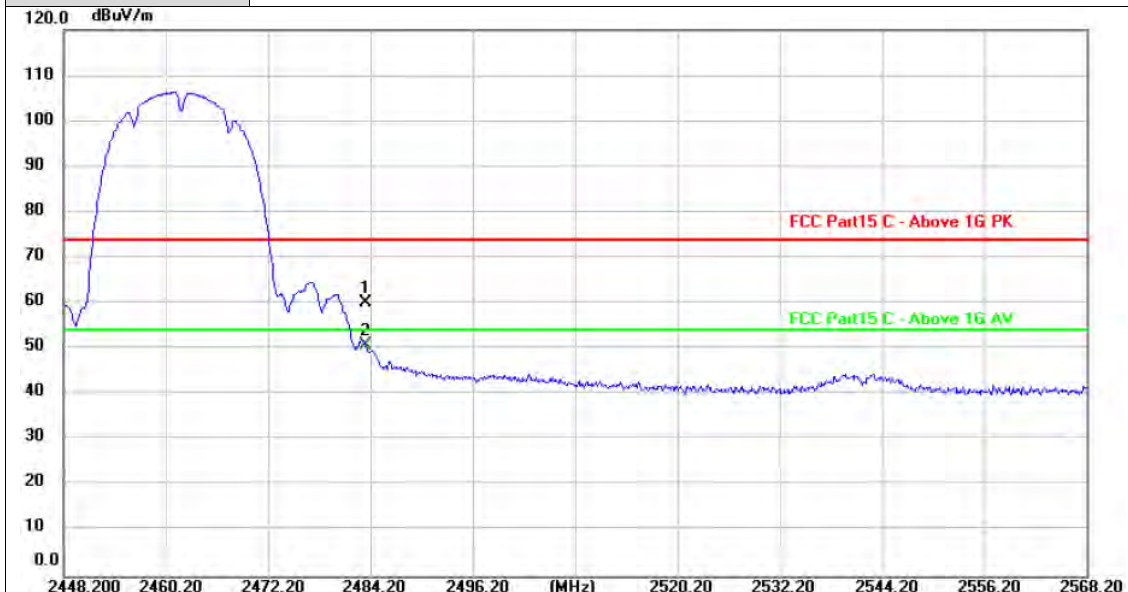

No.	Frequency (MHz)	Reading (dBuV)	Factor (dB/m)	Level (dBuV/m)	Limit (dBuV/m)	Margin (dB)	Detector
1	2483.500	28.82	31.24	60.06	74.00	-13.94	peak
2 *	2483.500	19.53	31.24	50.77	54.00	-3.23	AVG

Remarks:
 1. Factor (dB/m) = Antenna Factor (dB/m)+Cable Factor (dB)-Pre-amplifier Factor
 2. Margin value = Level -Limit value



Ant No.:	Ant 1 + Ant 2
Ant. Pol.	Horizontal
Test Mode:	802.11g Mode 2412MHz

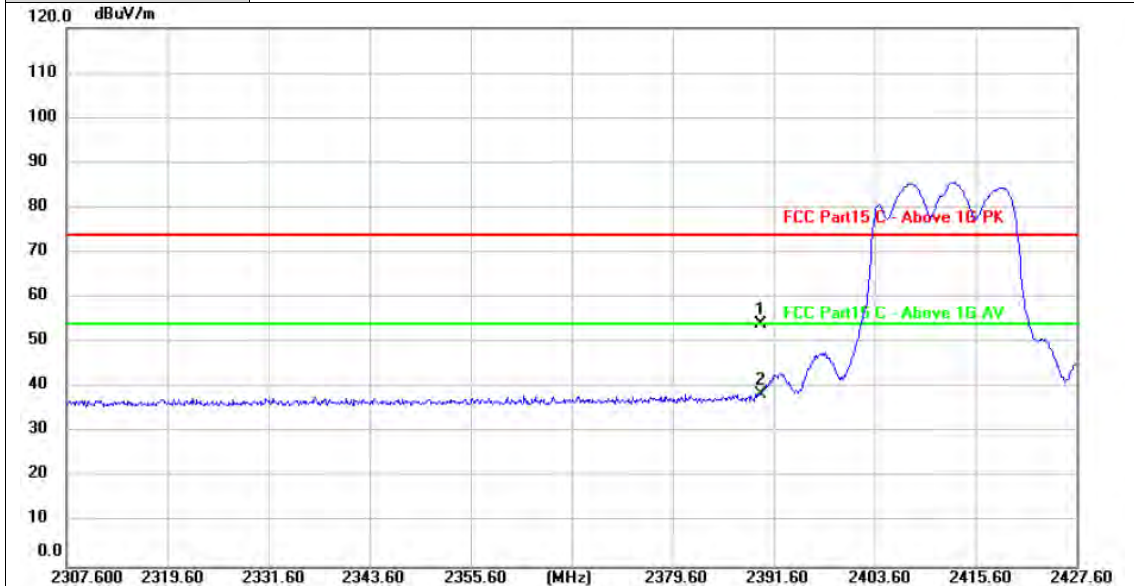

No.	Frequency (MHz)	Reading (dBuV)	Factor (dB/m)	Level (dBuV/m)	Limit (dBuV/m)	Margin (dB)	Detector
1	2390.000	23.38	30.84	54.22	74.00	-19.78	peak
2 *	2390.000	7.58	30.84	38.42	54.00	-15.58	AVG

Remarks:
 1. Factor (dB/m) = Antenna Factor (dB/m)+Cable Factor (dB)-Pre-amplifier Factor
 2. Margin value = Level -Limit value



Ant No.:	Ant 1 + Ant 2
Ant. Pol.	Vertical
Test Mode:	802.11g Mode 2412MHz

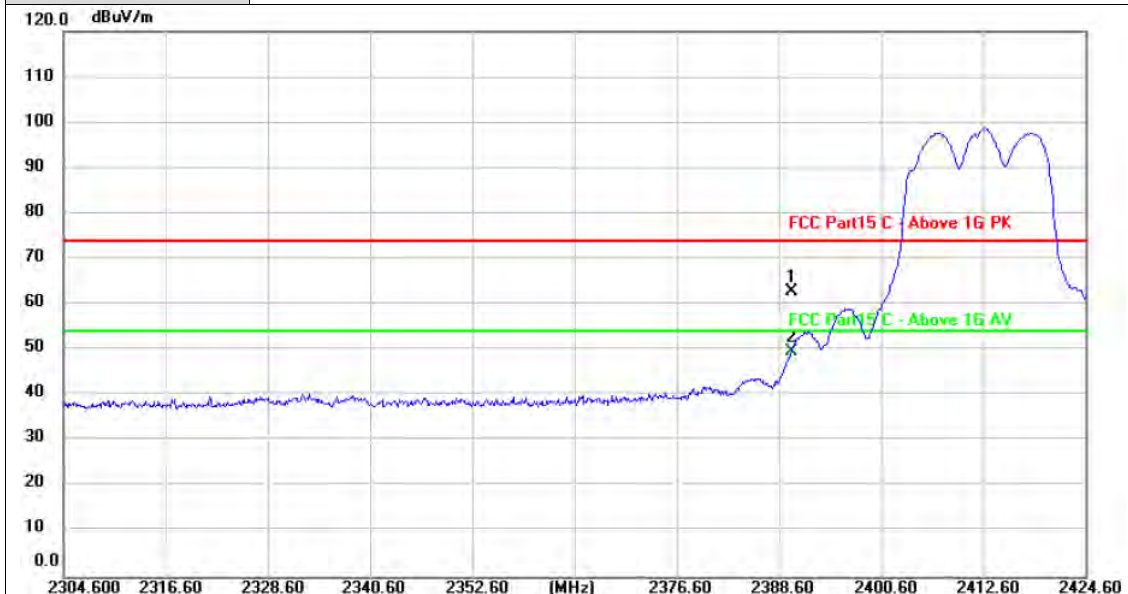

No.	Frequency (MHz)	Reading (dBuV)	Factor (dB/m)	Level (dBuV/m)	Limit (dBuV/m)	Margin (dB)	Detector
1	2390.000	32.03	30.84	62.87	74.00	-11.13	peak
2 *	2390.000	18.70	30.84	49.54	54.00	-4.46	AVG

Remarks:

1. Factor (dB/m) = Antenna Factor (dB/m)+Cable Factor (dB)-Pre-amplifier Factor
2. Margin value = Level -Limit value



Ant No.:	Ant 1 + Ant 2
Ant. Pol.	Horizontal
Test Mode:	802.11g Mode 2462MHz

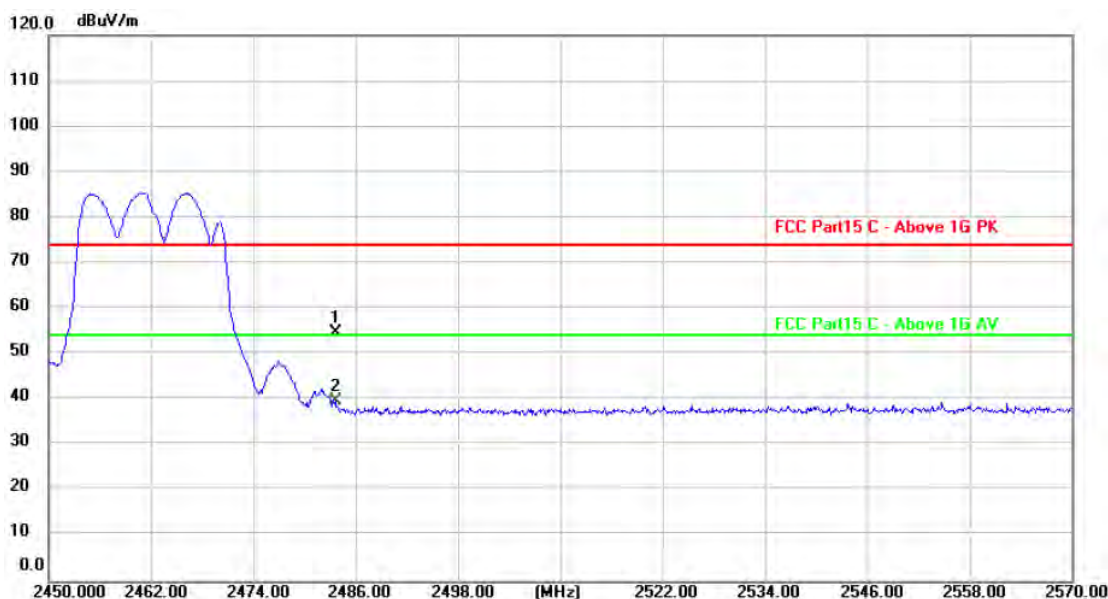

No.	Frequency (MHz)	Reading (dBuV)	Factor (dB/m)	Level (dBuV/m)	Limit (dBuV/m)	Margin (dB)	Detector
1	2483.500	23.43	31.24	54.67	74.00	-19.33	peak
2 *	2483.500	8.64	31.24	39.88	54.00	-14.12	AVG

Remarks:

- 1. Factor (dB/m) = Antenna Factor (dB/m)+Cable Factor (dB)-Pre-amplifier Factor
- 2. Margin value = Level -Limit value



Ant No.:	Ant 1 + Ant 2
Ant. Pol.	Vertical
Test Mode:	802.11g Mode 2462MHz

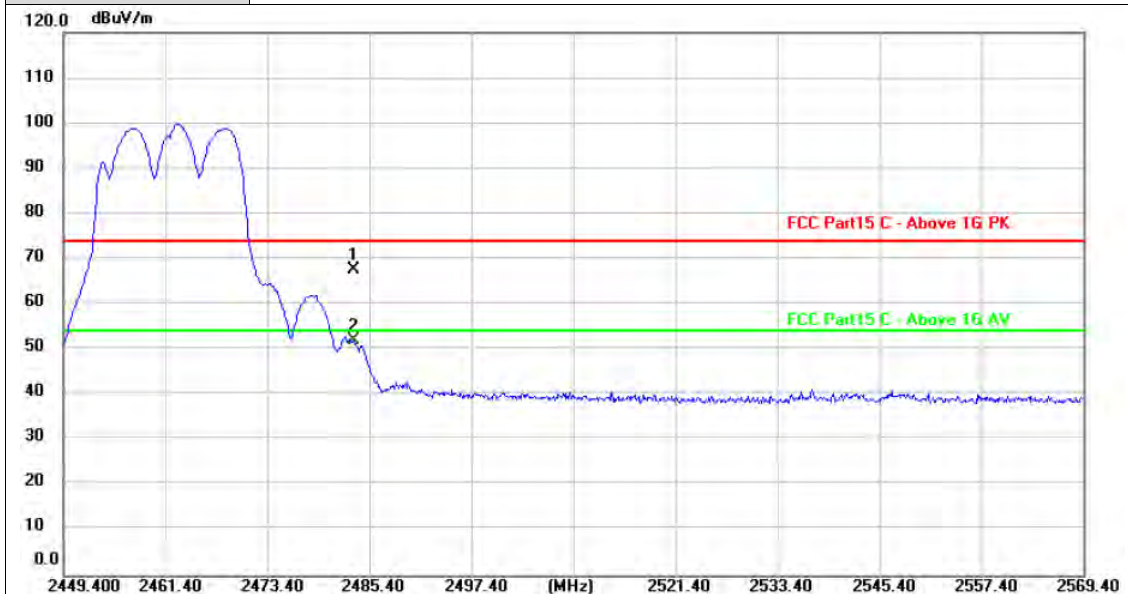

No.	Frequency (MHz)	Reading (dBuV)	Factor (dB/m)	Level (dBuV/m)	Limit (dBuV/m)	Margin (dB)	Detector
1	2483.500	36.32	31.24	67.56	74.00	-6.44	peak
2 *	2483.500	20.67	31.24	51.91	54.00	-2.09	AVG

Remarks:

- 1. Factor (dB/m) = Antenna Factor (dB/m) + Cable Factor (dB) - Pre-amplifier Factor
- 2. Margin value = Level - Limit value



Ant No.:	Ant 1 + Ant 2
Ant. Pol.	Horizontal
Test Mode:	802.11n(HT20) Mode 2412MHz

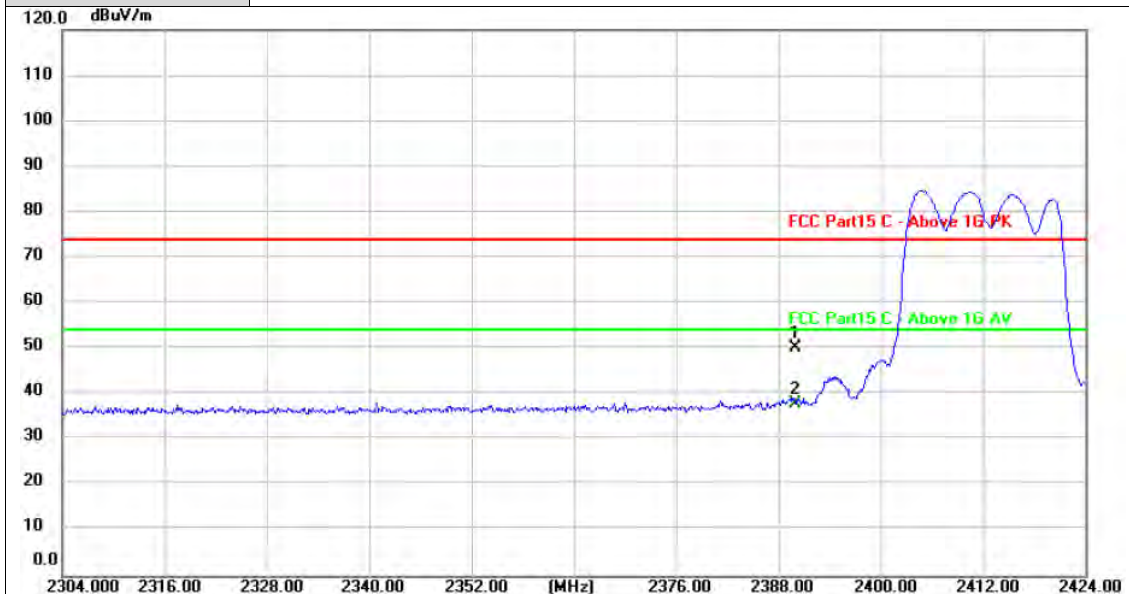

No.	Frequency (MHz)	Reading (dBuV)	Factor (dB/m)	Level (dBuV/m)	Limit (dBuV/m)	Margin (dB)	Detector
1	2390.000	19.43	30.84	50.27	74.00	-23.73	peak
2 *	2390.000	7.01	30.84	37.85	54.00	-16.15	AVG

Remarks:

1. Factor (dB/m) = Antenna Factor (dB/m)+Cable Factor (dB)-Pre-amplifier Factor
2. Margin value = Level -Limit value



Ant No.:	Ant 1 + Ant 2
Ant. Pol.	Vertical
Test Mode:	802.11n(HT20) Mode 2412MHz

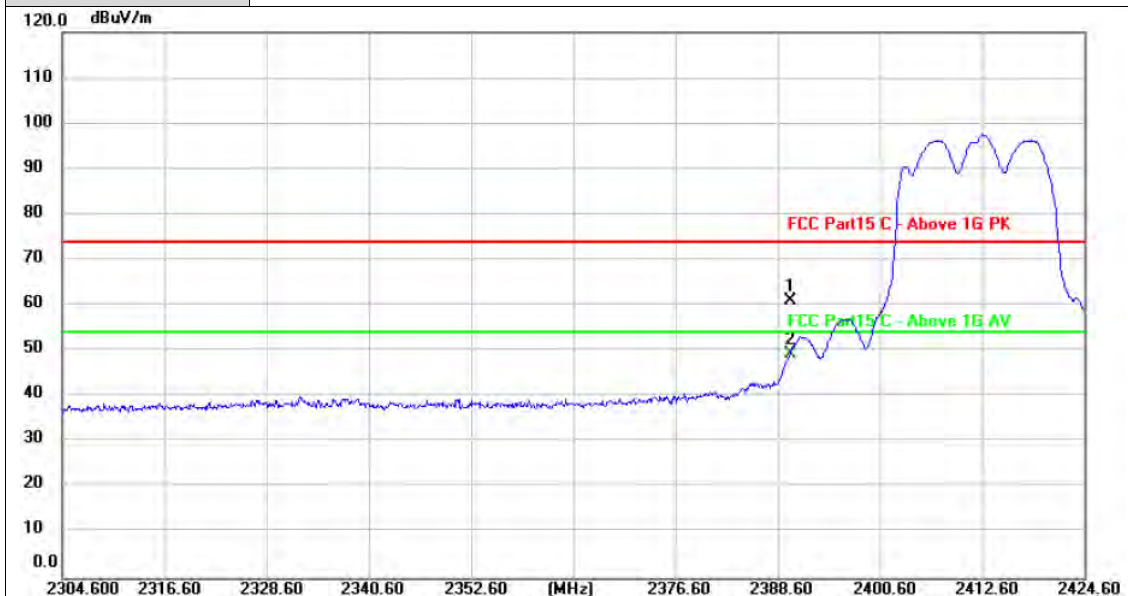

No.	Frequency (MHz)	Reading (dBuV)	Factor (dB/m)	Level (dBuV/m)	Limit (dBuV/m)	Margin (dB)	Detector
1	2390.000	30.07	30.84	60.91	74.00	-13.09	peak
2 *	2390.000	18.41	30.84	49.25	54.00	-4.75	AVG

Remarks:

- Factor (dB/m) = Antenna Factor (dB/m)+Cable Factor (dB)-Pre-amplifier Factor
- Margin value = Level -Limit value



Ant No.:	Ant 1 + Ant 2
Ant. Pol.	Horizontal
Test Mode:	802.11n(HT20) Mode 2462MHz

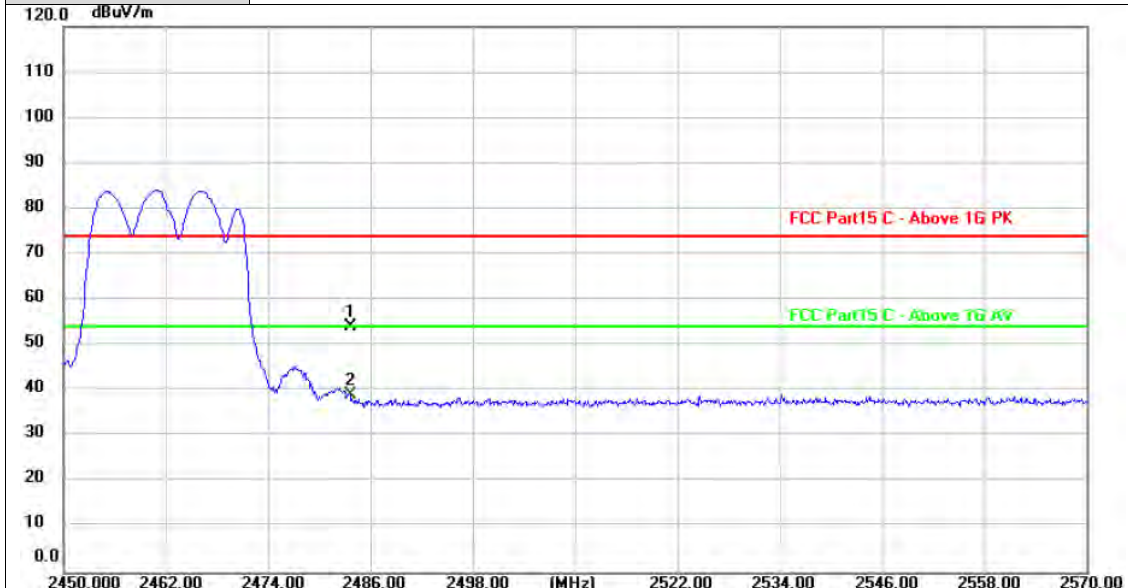

No.	Frequency (MHz)	Reading (dBuV)	Factor (dB/m)	Level (dBuV/m)	Limit (dBuV/m)	Margin (dB)	Detector
1	2483.500	23.02	31.24	54.26	74.00	-19.74	peak
2 *	2483.500	8.01	31.24	39.25	54.00	-14.75	AVG

Remarks:

- 1. Factor (dB/m) = Antenna Factor (dB/m)+Cable Factor (dB)-Pre-amplifier Factor
- 2. Margin value = Level -Limit value



Ant No.:	Ant 1 + Ant 2
Ant. Pol.	Vertical
Test Mode:	802.11n(HT20) Mode 2462MHz

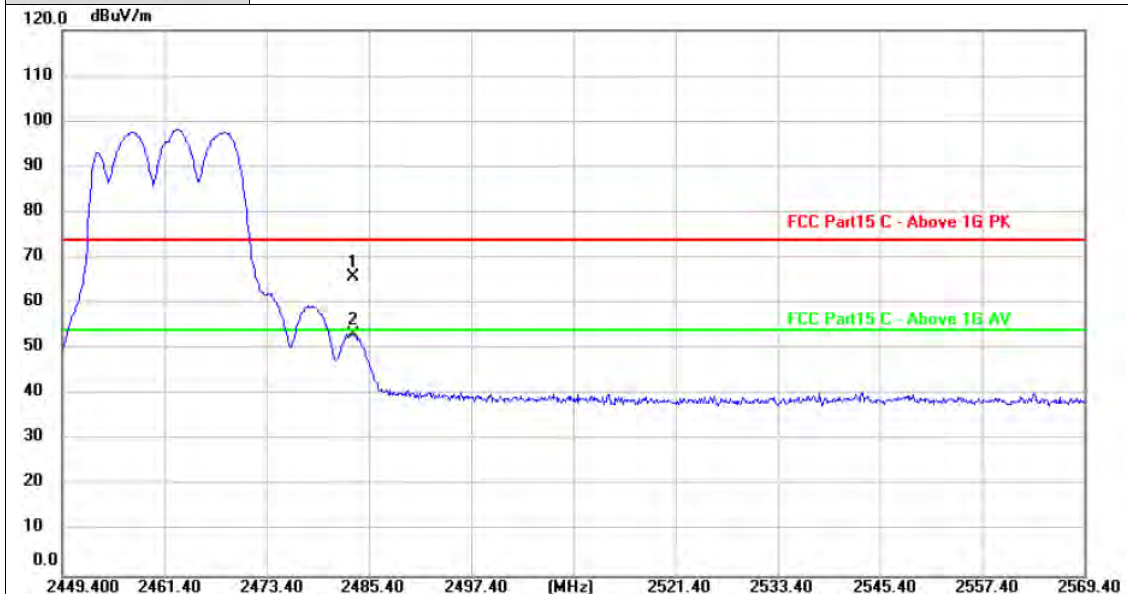

No.	Frequency (MHz)	Reading (dBuV)	Factor (dB/m)	Level (dBuV/m)	Limit (dBuV/m)	Margin (dB)	Detector
1	2483.500	34.65	31.24	65.89	74.00	-8.11	peak
2 *	2483.500	21.88	31.24	53.12	54.00	-0.88	AVG

Remarks:

- 1. Factor (dB/m) = Antenna Factor (dB/m)+Cable Factor (dB)-Pre-amplifier Factor
- 2. Margin value = Level -Limit value



Ant No.:	Ant 1 + Ant 2
Ant. Pol.	Horizontal
Test Mode:	802.11n(HT40) Mode 2422MHz



No.	Frequency (MHz)	Reading (dBuV)	Factor (dB/m)	Level (dBuV/m)	Limit (dBuV/m)	Margin (dB)	Detector
1	2390.000	23.37	30.84	54.21	74.00	-19.79	peak
2 *	2390.000	9.45	30.84	40.29	54.00	-13.71	AVG

Remarks:

- 1. Factor (dB/m) = Antenna Factor (dB/m)+Cable Factor (dB)-Pre-amplifier Factor
- 2. Margin value = Level -Limit value



Ant No.:	Ant 1 + Ant 2
Ant. Pol.	Vertical
Test Mode:	802.11n(HT40) Mode 2422MHz

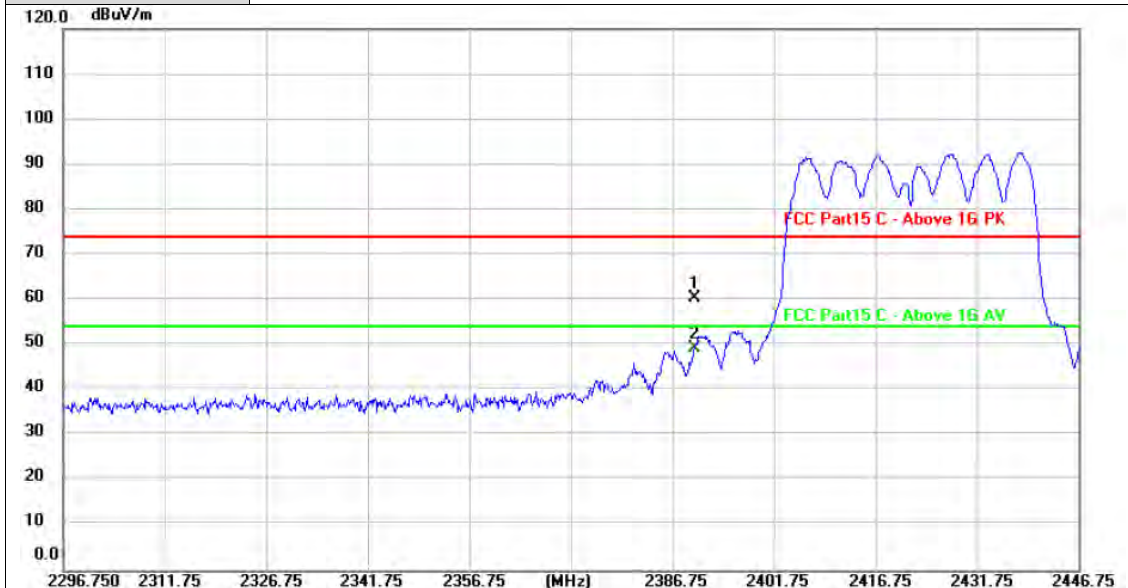

No.	Frequency (MHz)	Reading (dBuV)	Factor (dB/m)	Level (dBuV/m)	Limit (dBuV/m)	Margin (dB)	Detector
1	2390.000	29.59	30.84	60.43	74.00	-13.57	peak
2 *	2390.000	18.62	30.84	49.46	54.00	-4.54	AVG

Remarks:

- 1. Factor (dB/m) = Antenna Factor (dB/m)+Cable Factor (dB)-Pre-amplifier Factor
- 2. Margin value = Level -Limit value



Ant No.:	Ant 1 + Ant 2
Ant. Pol.	Horizontal
Test Mode:	802.11n(HT40) Mode 2452MHz

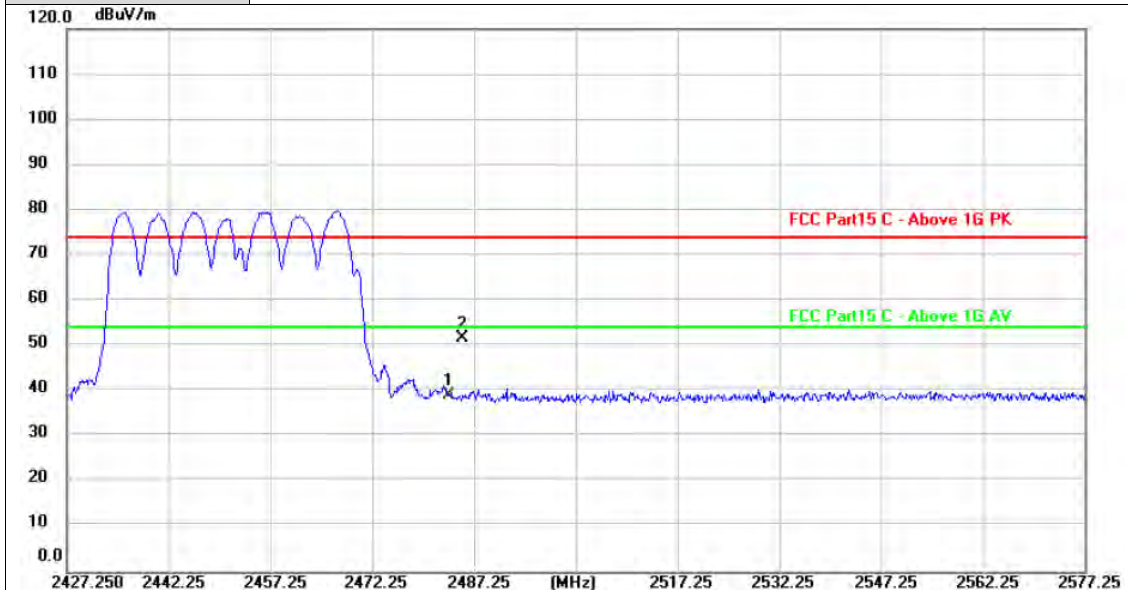

No.	Frequency (MHz)	Reading (dBuV)	Factor (dB/m)	Level (dBuV/m)	Limit (dBuV/m)	Margin (dB)	Detector
1 *	2483.500	7.85	31.24	39.09	54.00	-14.91	AVG
2	2485.600	20.52	31.25	51.77	74.00	-22.23	peak

Remarks:

- 1. Factor (dB/m) = Antenna Factor (dB/m) + Cable Factor (dB) - Pre-amplifier Factor
- 2. Margin value = Level - Limit value



Ant No.:	Ant 1 + Ant 2
Ant. Pol.	Vertical
Test Mode:	802.11n(HT40) Mode 2452MHz

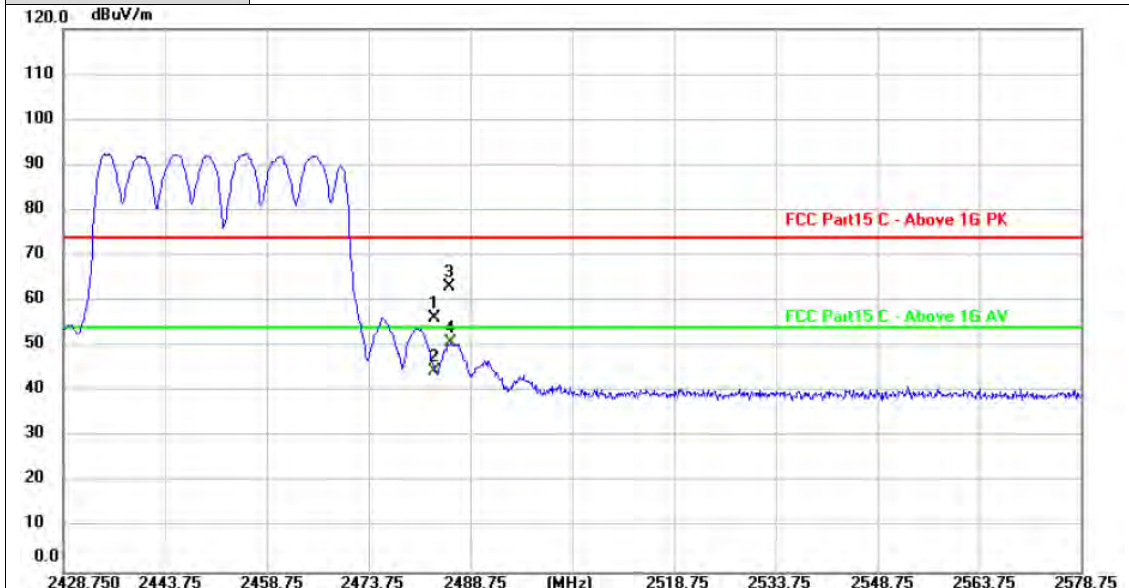

No.	Frequency (MHz)	Reading (dBuV)	Factor (dB/m)	Level (dBuV/m)	Limit (dBuV/m)	Margin (dB)	Detector
1	2483.500	24.91	31.24	56.15	74.00	-17.85	peak
2	2483.500	13.33	31.24	44.57	54.00	-9.43	AVG
3	2485.600	31.90	31.25	63.15	74.00	-10.85	peak
4 *	2485.900	19.60	31.25	50.85	54.00	-3.15	AVG

Remarks:

1. Factor (dB/m) = Antenna Factor (dB/m)+Cable Factor (dB)-Pre-amplifier Factor
2. Margin value = Level -Limit value



3.4. Band edge and Spurious Emissions (Conducted)

Limit

FCC CFR Title 47 Part 15 Subpart C Section 15.247 (d): In any 100 kHz bandwidth outside the frequency band in which the spread spectrum intentional radiator is operating, the radio frequency power that is produced by the intentional radiator shall be at least 20 dB below that in the 100 kHz bandwidth within the band that contains the highest level of the desired power, based on either an RF conducted or a radiated measurement.

Test Configuration

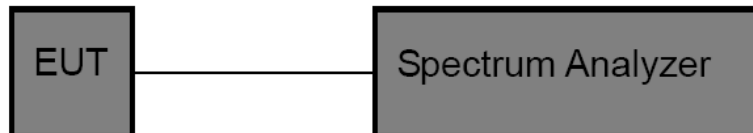

Test Procedure

1. The transmitter output was connected to the spectrum analyzer through an attenuator, the path loss was compensated to the results for each measurement.
2. Set to the maximum power setting and enable the EUT transmit continuously
3. Use the following spectrum analyzer settings:
RBW = 100 kHz, VBW \geq RBW, scan up through 10th harmonic.
Sweep = auto, Detector function = peak, Trace = max hold
4. Measure and record the results in the test report.

Test Mode

Please refer to the clause 2.4.

Test Results



(1) Band edge Conducted Test

Test Mode	Antenna	Frequency[MHz]	Ref Level[dBm]	Result[dBm]	Limit[dBm]	Verdict
802.11b	Ant1	2412	3.61	-29.73	<=-26.39	PASS
	Ant2	2412	4.83	-38.62	<=-25.17	PASS
	Ant1	2462	2.68	-46.98	<=-27.32	PASS
	Ant2	2462	4.07	-50.25	<=-25.93	PASS
802.11g	Ant1	2412	-2.28	-35.12	<=-32.28	PASS
	Ant2	2412	-0.07	-34.46	<=-30.07	PASS
	Ant1	2462	-2.28	-45.48	<=-32.28	PASS
	Ant2	2462	-1.30	-43.97	<=-31.30	PASS
802.11n(HT20)	Ant1	2412	-2.97	-36.52	<=-32.97	PASS
	Ant2	2412	-0.62	-37.03	<=-30.62	PASS
	Ant1	2462	-3.68	-48.58	<=-33.68	PASS
	Ant2	2462	-3.13	-45.00	<=-33.13	PASS
802.11n(HT40)	Ant1	2422	-8.26	-42.34	<=-38.26	PASS
	Ant2	2422	-6.24	-41.70	<=-36.24	PASS
	Ant1	2452	-8.68	-52.01	<=-38.68	PASS
	Ant2	2452	-6.62	-47.07	<=-36.62	PASS



802.11b_Ant1_Low_2412



802.11b_Ant2_Low_2412



802.11b_Ant1_High_2462



CTC Laboratories, Inc.

1-2/F., Building 2, Jiaquan Building, Guanlan High-Tech Park, Shenzhen, Guangdong, China

Tel.: (86)755-27521059

Fax: (86)755-27521011

Http://www.sz-ctc.org.cn



For anti-fake verification, please visit the official website of Certification and Accreditation Administration of the People's Republic of China : yz.cnca.cn



802.11b_Ant2_High_2462



802.11g_Ant1_Low_2412



802.11g_Ant2_Low_2412



802.11g_Ant1_High_2462

CTC Laboratories, Inc.

1-2/F., Building 2, Jiaquan Building, Guanlan High-Tech Park, Shenzhen, Guangdong, China

Tel.: (86)755-27521059

Fax: (86)755-27521011

Http://www.sz-ctc.org.cn



For anti-fake verification, please visit the official website of Certification and Accreditation Administration of the People's Republic of China : yz.cnca.cn



802.11g_Ant2_High_2462



802.11n(HT20)_Ant1_Low_2412



802.11n(HT20)_Ant2_Low_2412



802.11n(HT20)_Ant1_High_2462



802.11n(HT20)_Ant2_High_2462



802.11n(HT40)_Ant1_Low_2422



802.11n(HT40)_Ant2_Low_2422



802.11n(HT40)_Ant1_High_2452



802.11n(HT40)_Ant2_High_2452



CTC Laboratories, Inc.

1-2/F., Building 2, Jiaquan Building, Guanlan High-Tech Park, Shenzhen, Guangdong, China
Tel.: (86)755-27521059

Fax: (86)755-27521011 Http://www.sz-ctc.org.cn
For anti-fake verification, please visit the official website of Certification and Accreditation Administration of the People's Republic of China : yz.cnca.cn





(2) Conducted Spurious Emissions Test

Test Mode	Antenna	Channel	Freq Range [Mhz]	Ref Level [dBm]	Result [dBm]	Limit [dBm]	Verdict	
802.11b	Ant1	2412	Reference	3.88	3.88	---	PASS	
			30~1000	3.88	-58.70	<=-16.12	PASS	
			1000~26500	3.88	-25.46	<=-16.12	PASS	
	Ant2	2412	Reference	4.82	4.82	---	PASS	
			30~1000	4.82	-59.56	<=-15.18	PASS	
			1000~26500	4.82	-27.12	<=-15.18	PASS	
	Ant1	2437	Reference	2.72	2.72	---	PASS	
			30~1000	2.72	-59.82	<=-17.28	PASS	
			1000~26500	2.72	-26.45	<=-17.28	PASS	
	Ant2	2437	Reference	4.25	4.25	---	PASS	
			30~1000	4.25	-58.87	<=-15.76	PASS	
			1000~26500	4.25	-27.20	<=-15.76	PASS	
	Ant1	2462	Reference	3.35	3.35	---	PASS	
			30~1000	3.35	-58.67	<=-16.65	PASS	
			1000~26500	3.35	-26.41	<=-16.65	PASS	
	Ant2	2462	Reference	7.69	7.69	---	PASS	
			30~1000	7.69	-58.24	<=-12.31	PASS	
			1000~26500	7.69	-23.20	<=-12.31	PASS	
	802.11g	Ant1	2412	Reference	-2.08	-2.08	---	PASS
				30~1000	-2.08	-59.55	<=-22.08	PASS
				1000~26500	-2.08	-41.05	<=-22.08	PASS
		Ant2	2412	Reference	-0.71	-0.71	---	PASS
				30~1000	-0.71	-60.29	<=-20.71	PASS
				1000~26500	-0.71	-39.69	<=-20.71	PASS
Ant1		2437	Reference	-2.62	-2.62	---	PASS	
			30~1000	-2.62	-59.01	<=-22.62	PASS	
			1000~26500	-2.62	-42.48	<=-22.62	PASS	
Ant2		2437	Reference	-1.63	-1.63	---	PASS	
			30~1000	-1.63	-59.56	<=-21.63	PASS	
			1000~26500	-1.63	-42.07	<=-21.63	PASS	
Ant1		2462	Reference	-2.39	-2.39	---	PASS	
			30~1000	-2.39	-59.62	<=-22.39	PASS	
			1000~26500	-2.39	-41.70	<=-22.39	PASS	
Ant2		2462	Reference	-1.51	-1.51	---	PASS	
			30~1000	-1.51	-59.59	<=-21.51	PASS	
			1000~26500	-1.51	-42.61	<=-21.51	PASS	
802.11n(HT20)		Ant1	2412	Reference	-3.02	-3.02	---	PASS
				30~1000	-3.02	-59.62	<=-23.02	PASS
				1000~26500	-3.02	-43.95	<=-23.02	PASS
		Ant2	2412	Reference	-0.80	-0.80	---	PASS
				30~1000	-0.80	-59.16	<=-20.8	PASS

CTC Laboratories, Inc.

1-2/F., Building 2, Jiaquan Building, Guanlan High-Tech Park, Shenzhen, Guangdong, China

Tel.: (86)755-27521059

Fax: (86)755-27521011

Http://www.sz-ctc.org.cn

中国国家认证认可监督管理委员会
Certification and Accreditation Administration of the People's Republic of ChinaFor anti-fake verification, please visit the official website of Certification and Accreditation Administration of the People's Republic of China: yz.cnca.cn



	Ant1	2437	1000~26500	-0.80	-41.39	<=-20.8	PASS
			Reference	-4.46	-4.46	---	PASS
			30~1000	-4.46	-59.61	<=-24.46	PASS
	Ant2	2437	1000~26500	-4.46	-41.12	<=-24.46	PASS
			Reference	-2.22	-2.22	---	PASS
			30~1000	-2.22	-59.09	<=-22.22	PASS
	Ant1	2462	1000~26500	-2.22	-42.11	<=-22.22	PASS
			Reference	-3.58	-3.58	---	PASS
			30~1000	-3.58	-59.34	<=-23.58	PASS
	Ant2	2462	1000~26500	-3.58	-40.76	<=-23.58	PASS
			Reference	-4.11	-4.11	---	PASS
			30~1000	-4.11	-60.66	<=-24.11	PASS
802.11n(HT40)	Ant1	2422	1000~26500	-4.11	-46.24	<=-24.11	PASS
			Reference	-8.43	-8.43	---	PASS
			30~1000	-8.43	-60.25	<=-28.43	PASS
	Ant2	2422	1000~26500	-8.43	-46.5	<=-28.43	PASS
			Reference	-5.73	-5.73	---	PASS
			30~1000	-5.73	-59.84	<=-25.73	PASS
	Ant1	2437	1000~26500	-5.73	-44.18	<=-25.73	PASS
			Reference	-8.03	-8.03	---	PASS
			30~1000	-8.03	-59.39	<=-28.03	PASS
	Ant2	2437	1000~26500	-8.03	-46.39	<=-28.03	PASS
			Reference	-5.96	-5.96	---	PASS
			30~1000	-5.96	-58.59	<=-25.96	PASS
	Ant1	2452	1000~26500	-5.96	-44.65	<=-25.96	PASS
			Reference	-8.17	-8.17	---	PASS
			30~1000	-8.17	-59.15	<=-28.17	PASS
Ant2	2452	1000~26500	-8.17	-44.92	<=-28.17	PASS	
		Reference	-6.11	-6.11	---	PASS	
		30~1000	-6.11	-58.93	<=-26.11	PASS	
	Ant2	2452	1000~26500	-6.11	-45.55	<=-26.11	PASS



802.11b_Ant1_2412_0~Reference



802.11b_Ant1_2412_30~1000

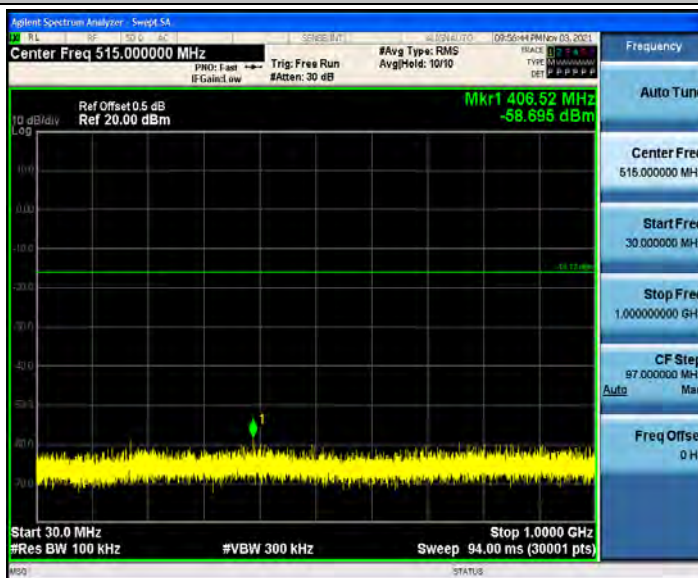

802.11b_Ant1_2412_1000~26500

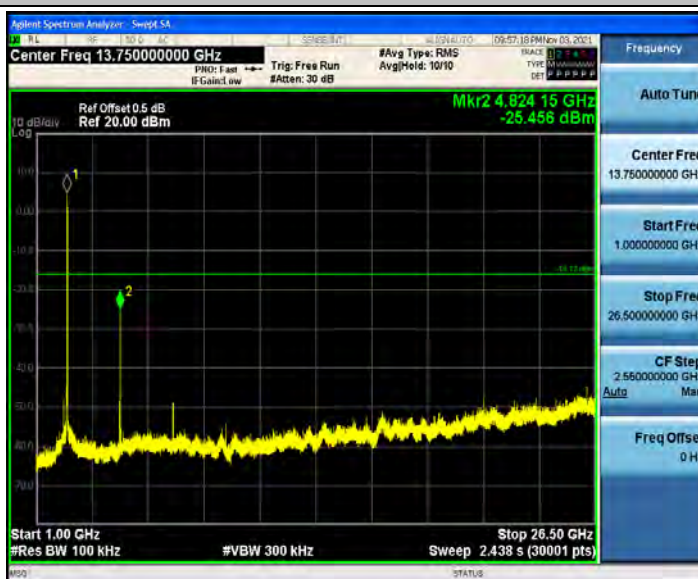

CTC Laboratories, Inc.

1-2/F., Building 2, Jiaquan Building, Guanlan High-Tech Park, Shenzhen, Guangdong, China
 Tel.: (86)755-27521059 Fax: (86)755-27521011 Http://www.sz-ctc.org.cn



For anti-fake verification, please visit the official website of Certification and Accreditation Administration of the People's Republic of China : yz.cnca.cn



802.11b_Ant2_2412_0-Reference



802.11b_Ant2_2412_30-1000

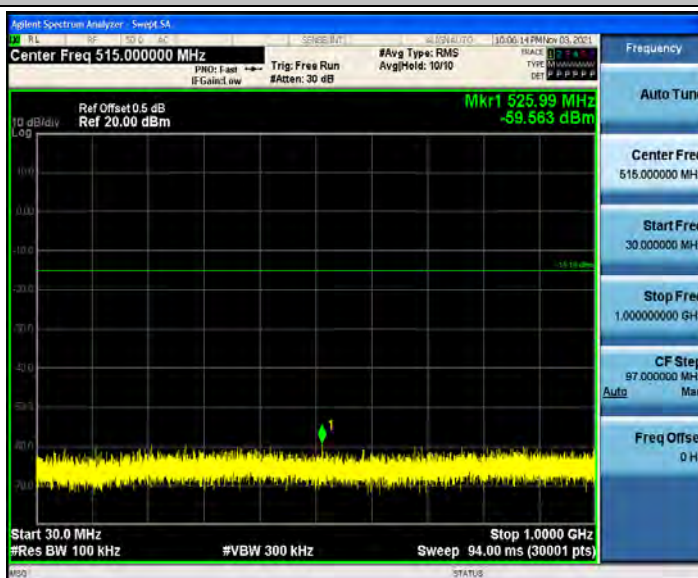

802.11b_Ant2_2412_1000-26500

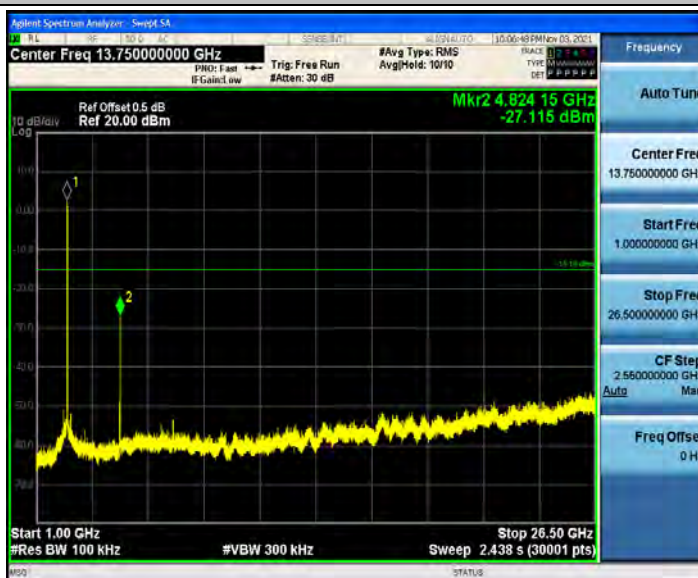

802.11b_Ant1_2437_0-Reference

CTC Laboratories, Inc.

1-2/F., Building 2, Jiaquan Building, Guanlan High-Tech Park, Shenzhen, Guangdong, China

Tel.: (86)755-27521059

Fax: (86)755-27521011

Http://www.sz-ctc.org.cn



For anti-fake verification, please visit the official website of Certification and Accreditation Administration of the People's Republic of China : yz.cnca.cn



802.11b_Ant1_2437_30~1000



802.11b_Ant1_2437_1000~26500

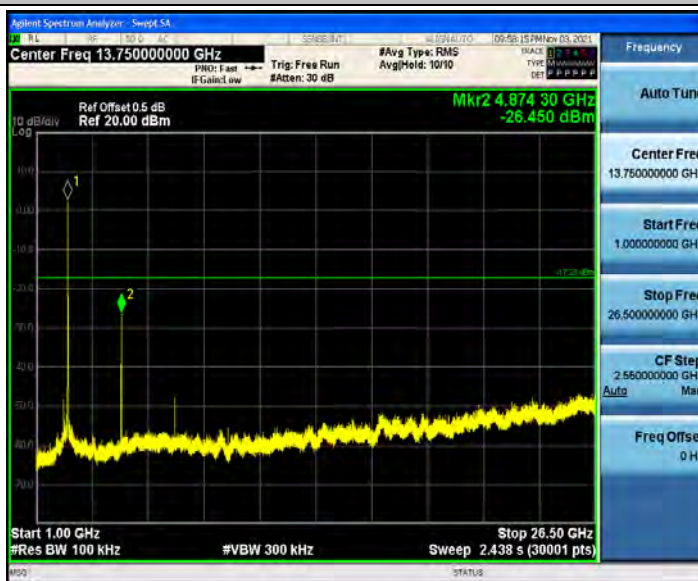

802.11b_Ant2_2437_0~Reference

CTC Laboratories, Inc.

1-2/F., Building 2, Jiaquan Building, Guanlan High-Tech Park, Shenzhen, Guangdong, China
 Tel.: (86)755-27521059 Fax: (86)755-27521011 Http://www.sz-ctc.org.cn



For anti-fake verification, please visit the official website of Certification and Accreditation Administration of the People's Republic of China : yz.cnca.cn



802.11b_Ant2_2437_30~1000



802.11b_Ant2_2437_1000~26500

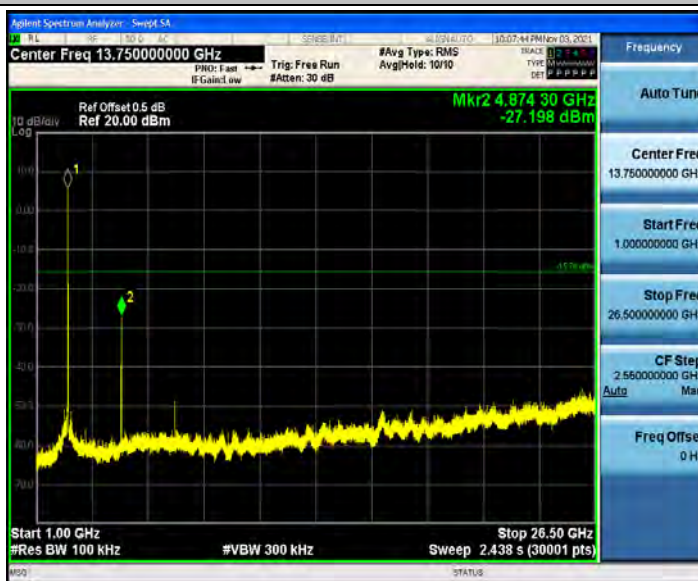

802.11b_Ant1_2462_0~Reference

CTC Laboratories, Inc.

1-2/F., Building 2, Jiaquan Building, Guanlan High-Tech Park, Shenzhen, Guangdong, China
Tel.: (86)755-27521059 Fax: (86)755-27521011 Http://www.sz-ctc.org.cn



For anti-fake verification, please visit the official website of Certification and Accreditation Administration of the People's Republic of China : yz.cnca.cn



802.11b_Ant1_2462_30~1000



802.11b_Ant1_2462_1000~26500

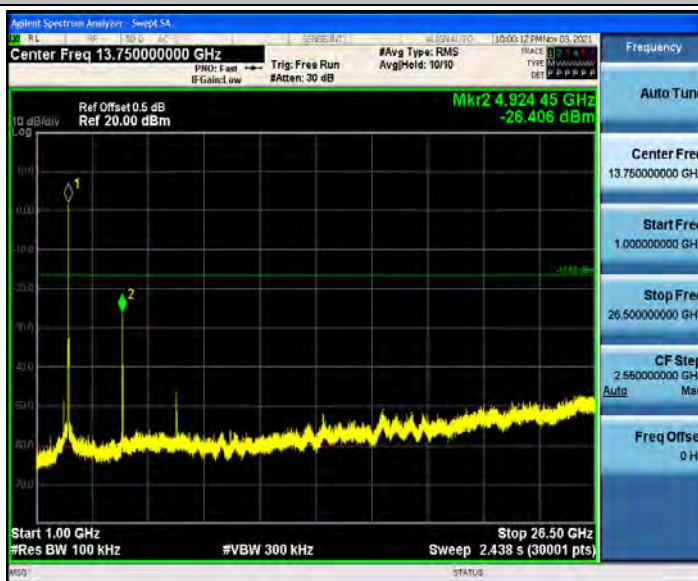

802.11b_Ant2_2462_0~Reference

CTC Laboratories, Inc.

1-2/F., Building 2, Jiaquan Building, Guanlan High-Tech Park, Shenzhen, Guangdong, China
Tel.: (86)755-27521059 Fax: (86)755-27521011 Http://www.sz-ctc.org.cn



For anti-fake verification, please visit the official website of Certification and Accreditation Administration of the People's Republic of China : yz.cnca.cn



802.11b_Ant2_2462_30~1000

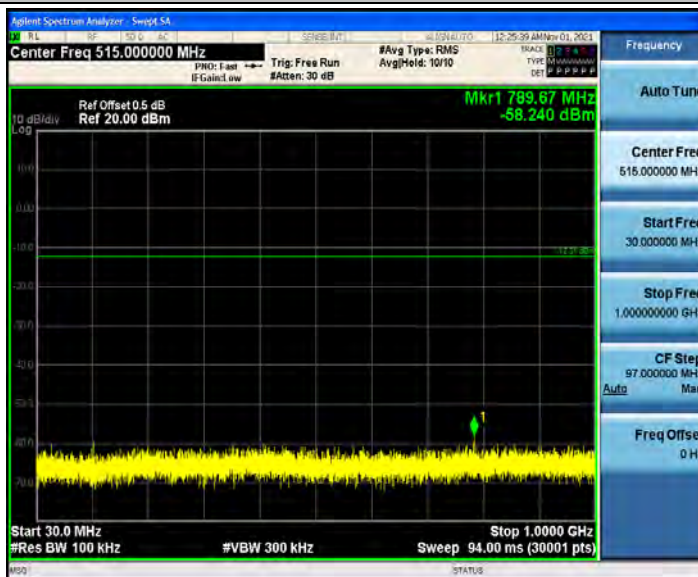

802.11b_Ant2_2462_1000~26500

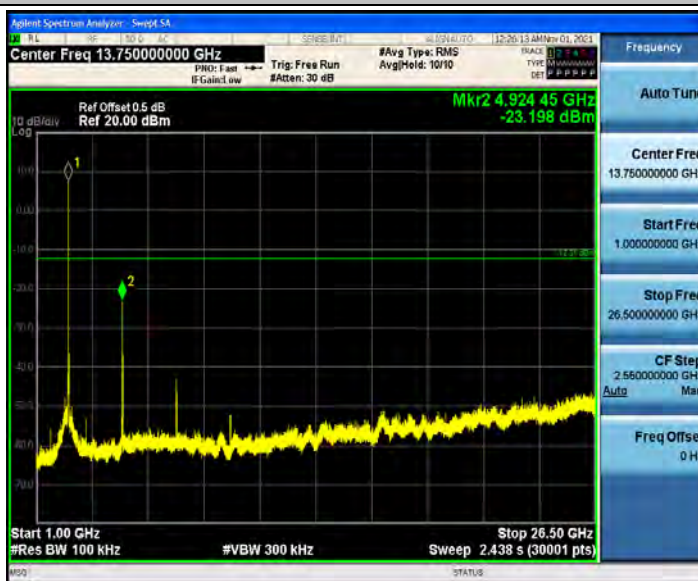

802.11g_Ant1_2412_0~Reference

CTC Laboratories, Inc.

1-2/F., Building 2, Jiaquan Building, Guanlan High-Tech Park, Shenzhen, Guangdong, China
Tel.: (86)755-27521059 Fax: (86)755-27521011 Http://www.sz-ctc.org.cn



For anti-fake verification, please visit the official website of Certification and Accreditation Administration of the People's Republic of China : yz.cnca.cn



802.11g_Ant1_2412_30~1000

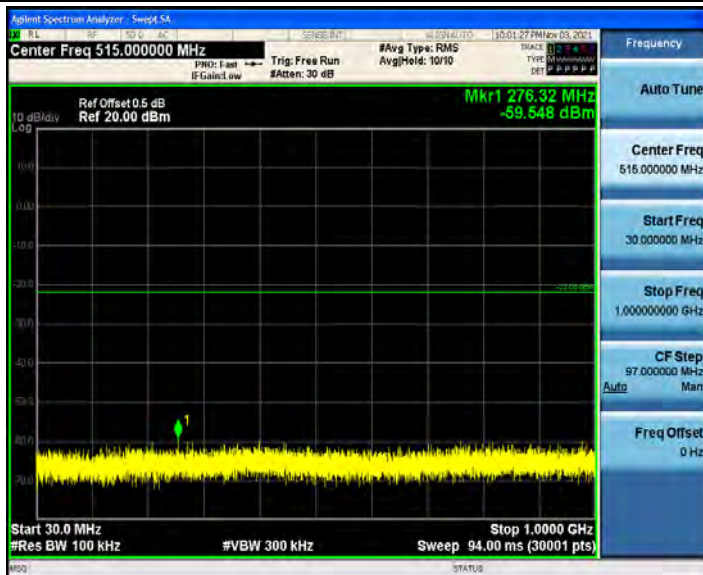

802.11g_Ant1_2412_1000~26500

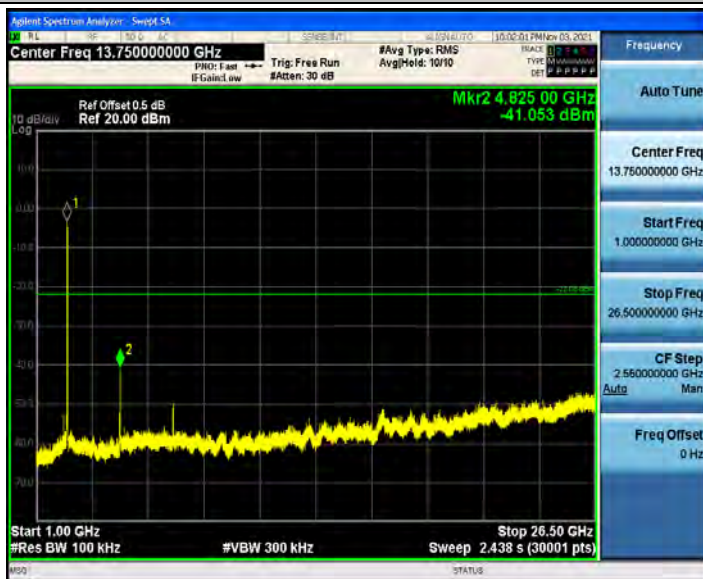

802.11g_Ant2_2412_0~Reference

CTC Laboratories, Inc.

1-2/F., Building 2, Jiaquan Building, Guanlan High-Tech Park, Shenzhen, Guangdong, China
Tel.: (86)755-27521059 Fax: (86)755-27521011 Http://www.sz-ctc.org.cn



For anti-fake verification, please visit the official website of Certification and Accreditation Administration of the People's Republic of China : yz.cnca.cn



802.11g_Ant2_2412_30~1000



802.11g_Ant2_2412_1000~26500

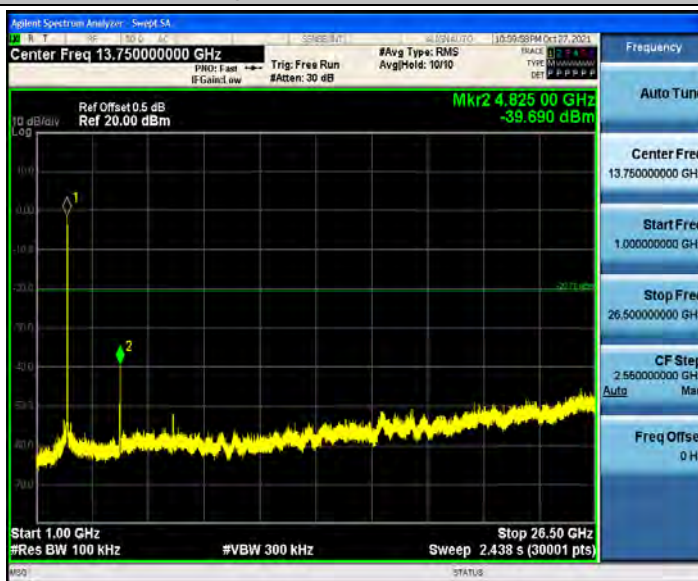

802.11g_Ant1_2437_0~Reference

CTC Laboratories, Inc.

1-2/F., Building 2, Jiaquan Building, Guanlan High-Tech Park, Shenzhen, Guangdong, China

Tel.: (86)755-27521059

Fax: (86)755-27521011

Http://www.sz-ctc.org.cn



For anti-fake verification, please visit the official website of Certification and Accreditation Administration of the People's Republic of China : yz.cnca.cn



802.11g_Ant1_2437_30~1000

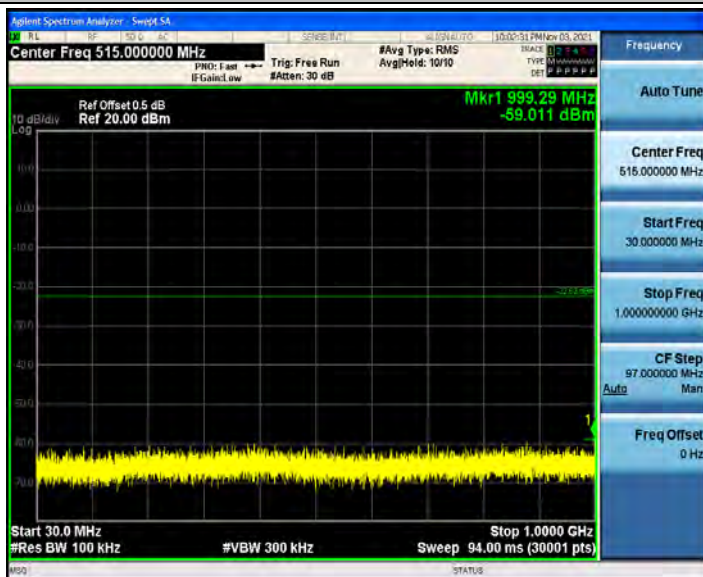

802.11g_Ant1_2437_1000~26500

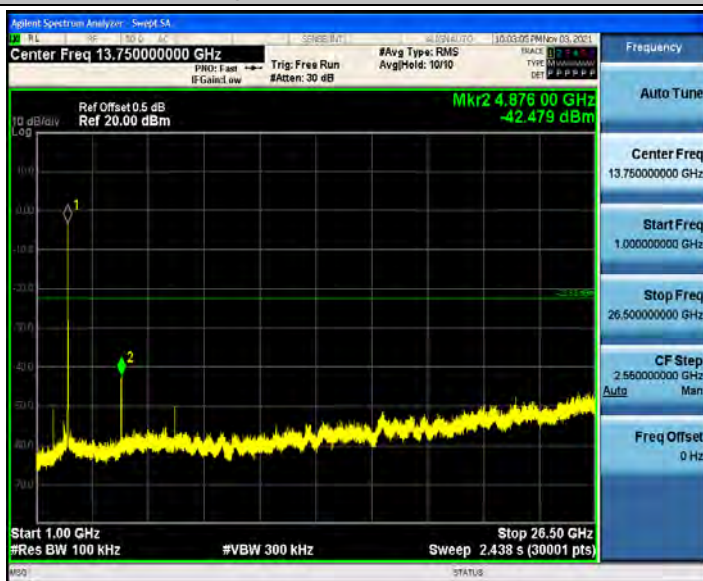

802.11g_Ant2_2437_0~Reference

CTC Laboratories, Inc.

1-2/F., Building 2, Jiaquan Building, Guanlan High-Tech Park, Shenzhen, Guangdong, China
 Tel.: (86)755-27521059 Fax: (86)755-27521011 Http://www.sz-ctc.org.cn



For anti-fake verification, please visit the official website of Certification and Accreditation Administration of the People's Republic of China : yz.cnca.cn



802.11g_Ant2_2437_30~1000

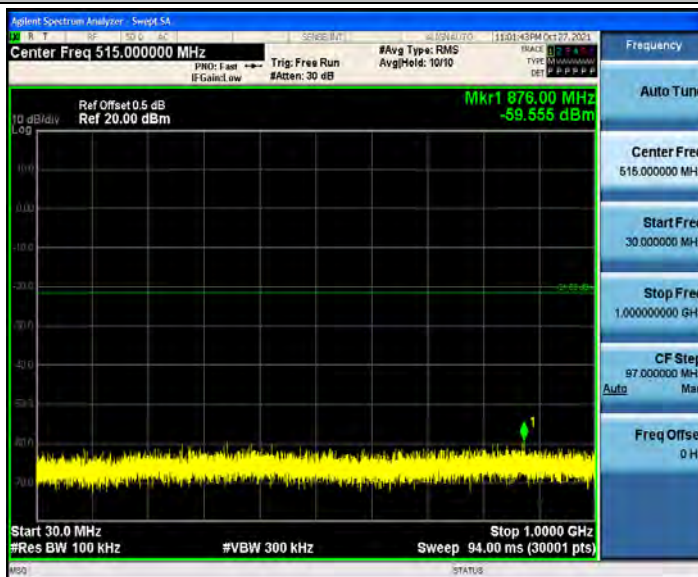

802.11g_Ant2_2437_1000~26500

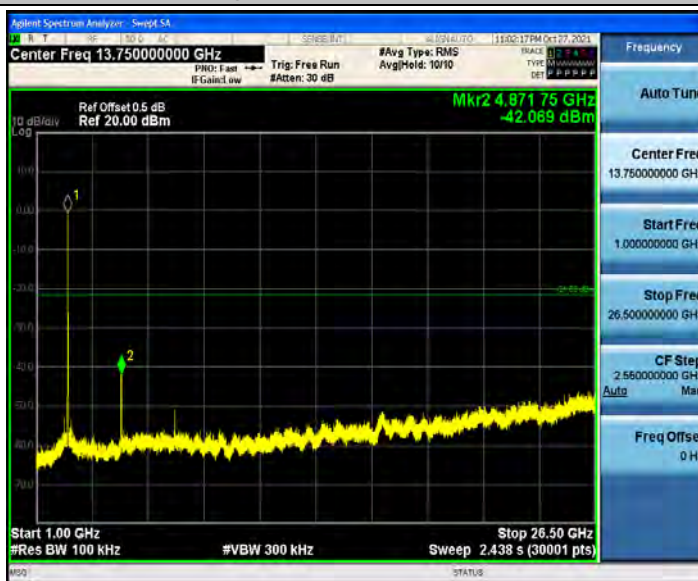

802.11g_Ant1_2462_0~Reference

CTC Laboratories, Inc.

1-2/F., Building 2, Jiaquan Building, Guanlan High-Tech Park, Shenzhen, Guangdong, China
 Tel.: (86)755-27521059 Fax: (86)755-27521011 Http://www.sz-ctc.org.cn



For anti-fake verification, please visit the official website of Certification and Accreditation Administration of the People's Republic of China : yz.cnca.cn



802.11g_Ant1_2462_30~1000



802.11g_Ant1_2462_1000~26500

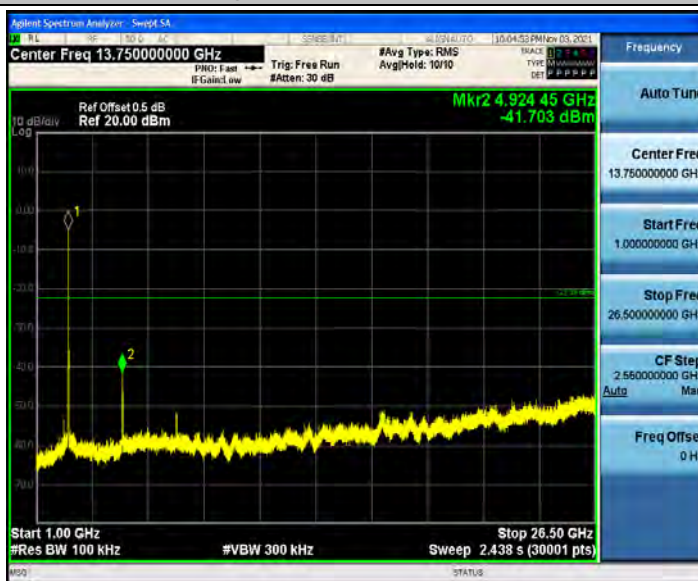

802.11g_Ant2_2462_0~Reference

CTC Laboratories, Inc.

1-2/F., Building 2, Jiaquan Building, Guanlan High-Tech Park, Shenzhen, Guangdong, China
Tel.: (86)755-27521059 Fax: (86)755-27521011 Http://www.sz-ctc.org.cn



For anti-fake verification, please visit the official website of Certification and Accreditation Administration of the People's Republic of China : yz.cnca.cn



802.11g_Ant2_2462_30~1000

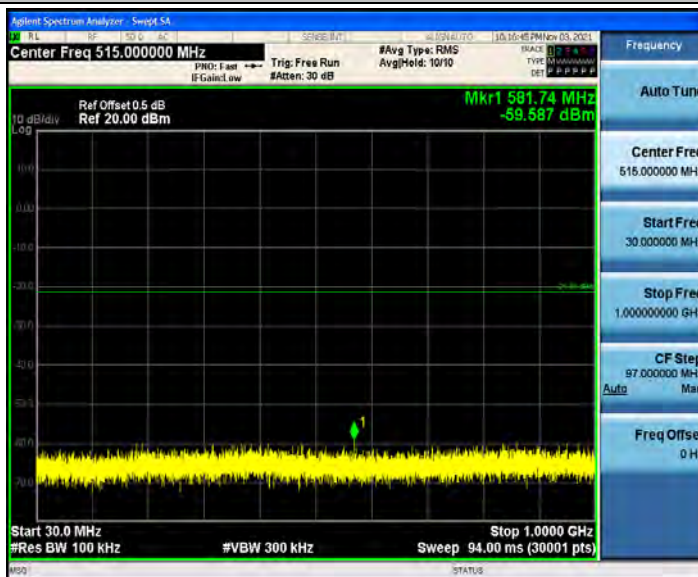

802.11g_Ant2_2462_1000~26500

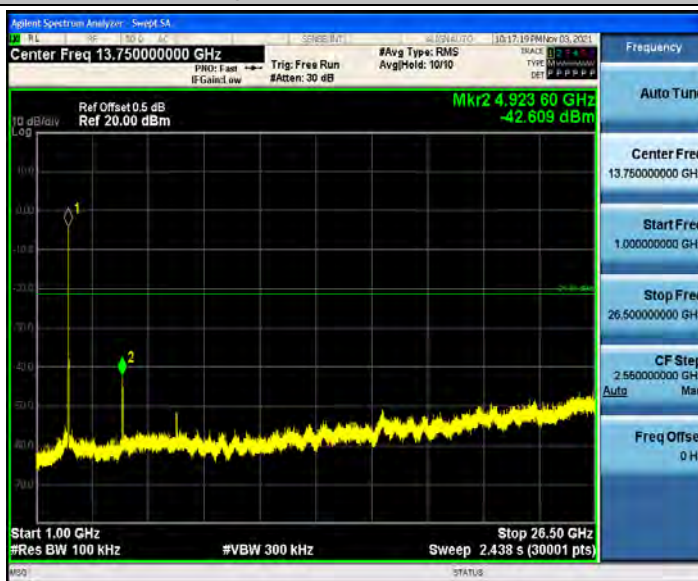

802.11n(HT20)_Ant1_2412_0~Reference

CTC Laboratories, Inc.

1-2/F., Building 2, Jiaquan Building, Guanlan High-Tech Park, Shenzhen, Guangdong, China
Tel.: (86)755-27521059

Fax: (86)755-27521011 Http://www.sz-ctc.org.cn
For anti-fake verification, please visit the official website of Certification and Accreditation Administration of the People's Republic of China : yz.cnca.cn





802.11n(HT20)_Ant1_2412_30~1000



802.11n(HT20)_Ant1_2412_1000~26500



802.11n(HT20)_Ant2_2412_0~Reference

CTC Laboratories, Inc.

1-2/F., Building 2, Jiaquan Building, Guanlan High-Tech Park, Shenzhen, Guangdong, China
 Tel.: (86)755-27521059

Fax: (86)755-27521011 Http://www.sz-ctc.org.cn
 For anti-fake verification, please visit the official website of Certification and Accreditation Administration of the People's Republic of China : yz.cnca.cn





802.11n(HT20)_Ant2_2412_30~1000

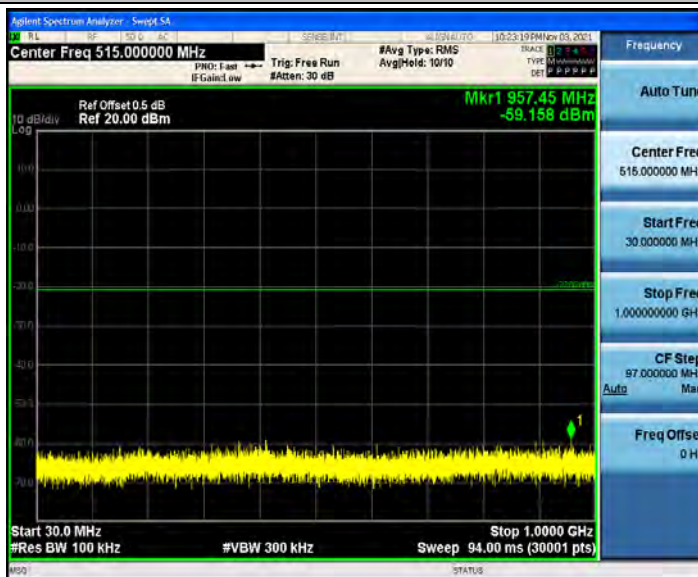

802.11n(HT20)_Ant2_2412_1000~26500

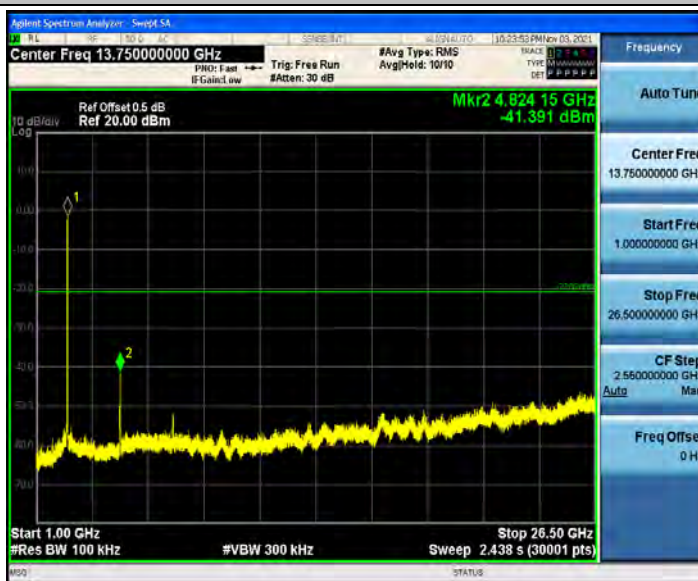

802.11n(HT20)_Ant1_2437_0~Reference

CTC Laboratories, Inc.

1-2/F., Building 2, Jiaquan Building, Guanlan High-Tech Park, Shenzhen, Guangdong, China
Tel.: (86)755-27521059 Fax: (86)755-27521011 Http://www.sz-ctc.org.cn



For anti-fake verification, please visit the official website of Certification and Accreditation Administration of the People's Republic of China : yz.cnca.cn



802.11n(HT20)_Ant1_2437_30~1000

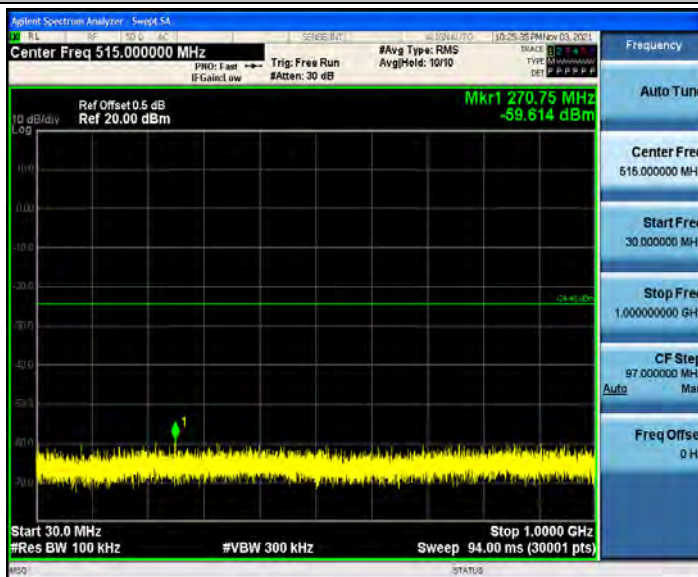

802.11n(HT20)_Ant1_2437_1000~26500

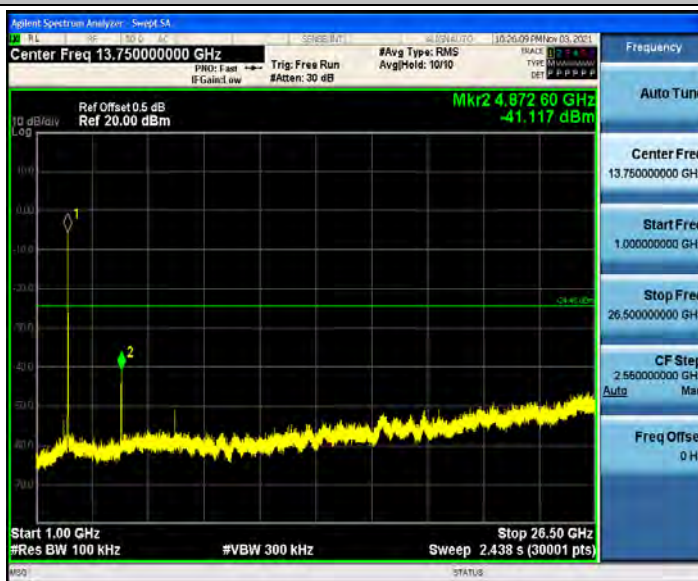

802.11n(HT20)_Ant2_2437_0~Reference

CTC Laboratories, Inc.

1-2/F., Building 2, Jiaquan Building, Guanlan High-Tech Park, Shenzhen, Guangdong, China
Tel.: (86)755-27521059 Fax: (86)755-27521011 Http://www.sz-ctc.org.cn



For anti-fake verification, please visit the official website of Certification and Accreditation Administration of the People's Republic of China : yz.cnca.cn



802.11n(HT20)_Ant2_2437_30~1000

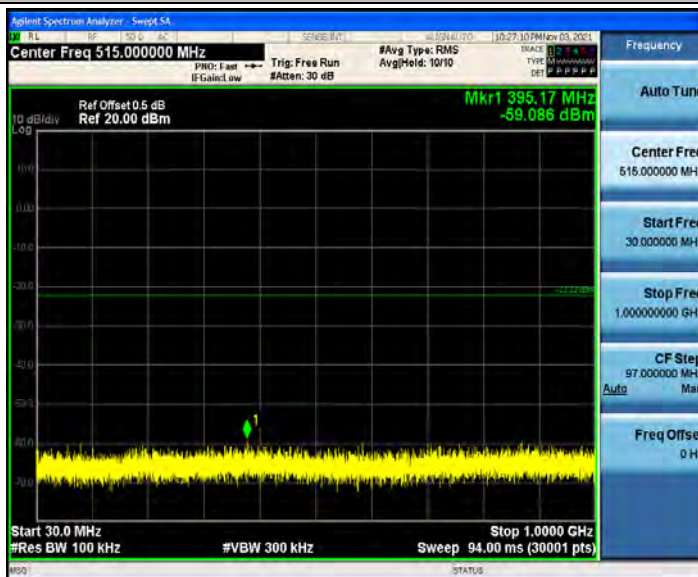

802.11n(HT20)_Ant2_2437_1000~26500



802.11n(HT20)_Ant1_2462_0~Reference

CTC Laboratories, Inc.

1-2/F., Building 2, Jiaquan Building, Guanlan High-Tech Park, Shenzhen, Guangdong, China
 Tel.: (86)755-27521059 Fax: (86)755-27521011 Http://www.sz-ctc.org.cn



For anti-fake verification, please visit the official website of Certification and Accreditation Administration of the People's Republic of China : yz.cnca.cn



802.11n(HT20)_Ant1_2462_30~1000



802.11n(HT20)_Ant1_2462_1000~26500

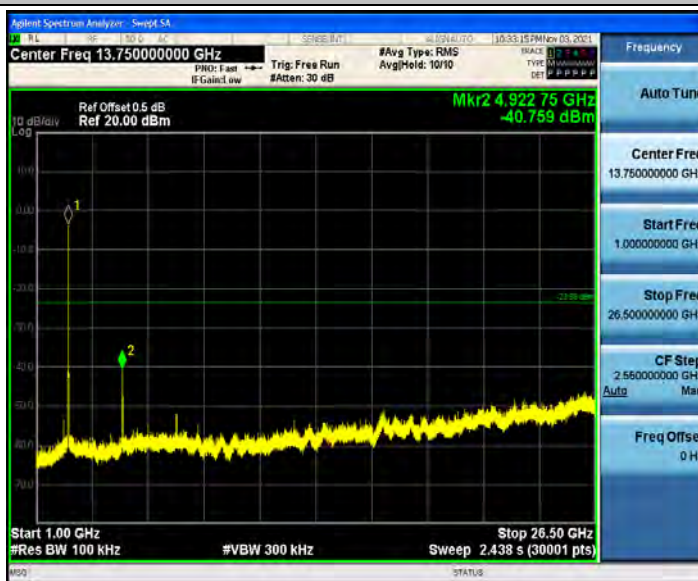

802.11n(HT20)_Ant2_2462_0~Reference

CTC Laboratories, Inc.

1-2/F., Building 2, Jiaquan Building, Guanlan High-Tech Park, Shenzhen, Guangdong, China
Tel.: (86)755-27521059

Fax: (86)755-27521011 Http://www.sz-ctc.org.cn
For anti-fake verification, please visit the official website of Certification and Accreditation Administration of the People's Republic of China : yz.cnca.cn





802.11n(HT20)_Ant2_2462_30~1000



802.11n(HT20)_Ant2_2462_1000~26500



802.11n(HT40)_Ant1_2422_0~Reference

CTC Laboratories, Inc.

1-2/F., Building 2, Jiaquan Building, Guanlan High-Tech Park, Shenzhen, Guangdong, China
Tel.: (86)755-27521059 Fax: (86)755-27521011 Http://www.sz-ctc.org.cn



For anti-fake verification, please visit the official website of Certification and Accreditation Administration of the People's Republic of China : yz.cnca.cn



802.11n(HT40)_Ant1_2422_30~1000



802.11n(HT40)_Ant1_2422_1000~26500

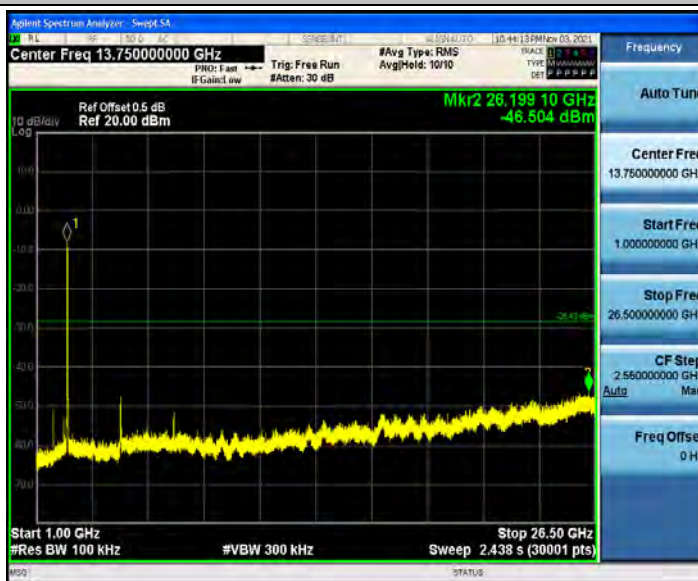

802.11n(HT40)_Ant2_2422_0~Reference

CTC Laboratories, Inc.

1-2/F., Building 2, Jiaquan Building, Guanlan High-Tech Park, Shenzhen, Guangdong, China
 Tel.: (86)755-27521059 Fax: (86)755-27521011 Http://www.sz-ctc.org.cn



For anti-fake verification, please visit the official website of Certification and Accreditation Administration of the People's Republic of China : yz.cnca.cn



802.11n(HT40)_Ant2_2422_30~1000

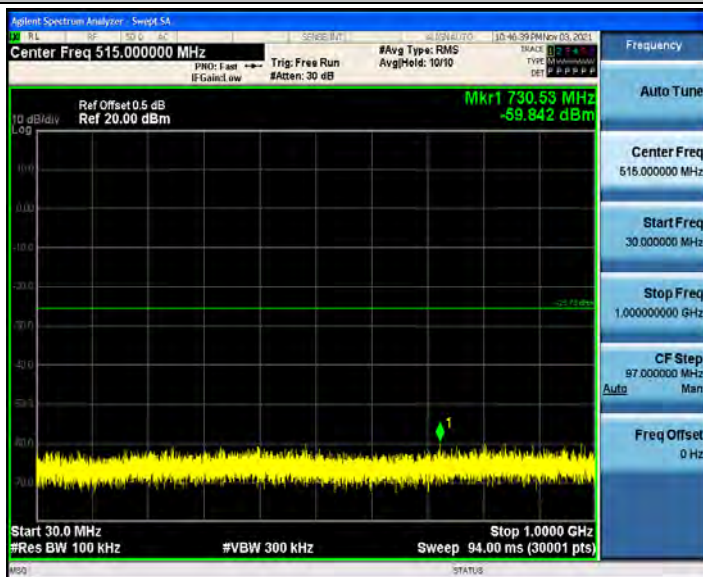

802.11n(HT40)_Ant2_2422_1000~26500



802.11n(HT40)_Ant1_2437_0~Reference

CTC Laboratories, Inc.

1-2/F., Building 2, Jiaquan Building, Guanlan High-Tech Park, Shenzhen, Guangdong, China
 Tel.: (86)755-27521059 Fax: (86)755-27521011 Http://www.sz-ctc.org.cn



For anti-fake verification, please visit the official website of Certification and Accreditation Administration of the People's Republic of China : yz.cnca.cn

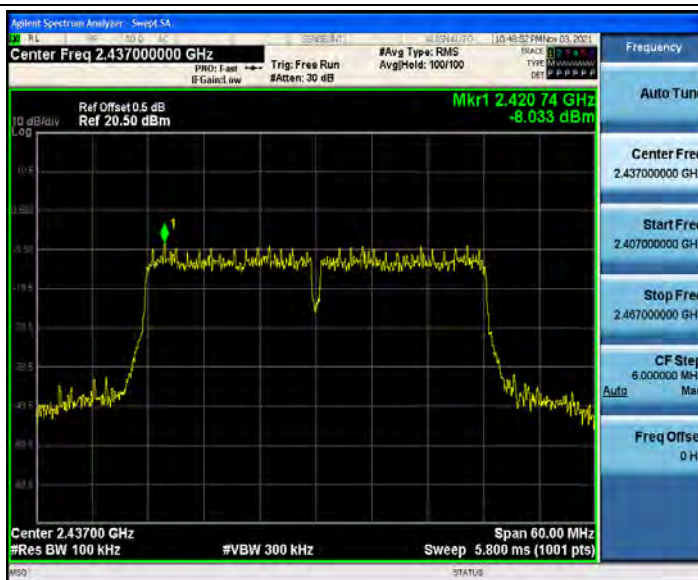

802.11n(HT40)_Ant1_2437_30~1000

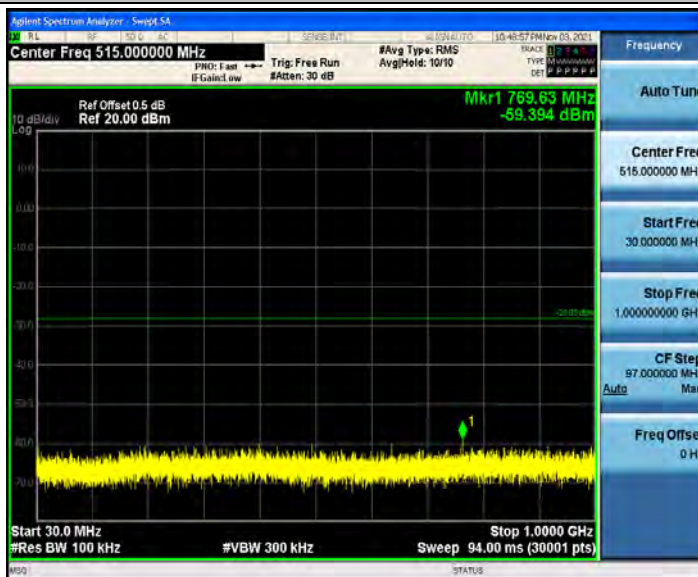

802.11n(HT40)_Ant1_2437_1000~26500



802.11n(HT40)_Ant2_2437_0~Reference

CTC Laboratories, Inc.

1-2/F., Building 2, Jiaquan Building, Guanlan High-Tech Park, Shenzhen, Guangdong, China
 Tel.: (86)755-27521059 Fax: (86)755-27521011 Http://www.sz-ctc.org.cn



For anti-fake verification, please visit the official website of Certification and Accreditation Administration of the People's Republic of China : yz.cnca.cn

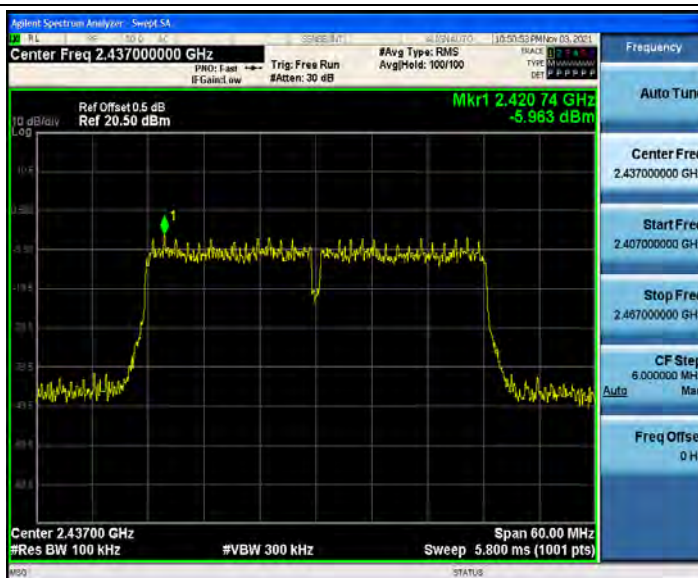

802.11n(HT40)_Ant2_2437_30~1000

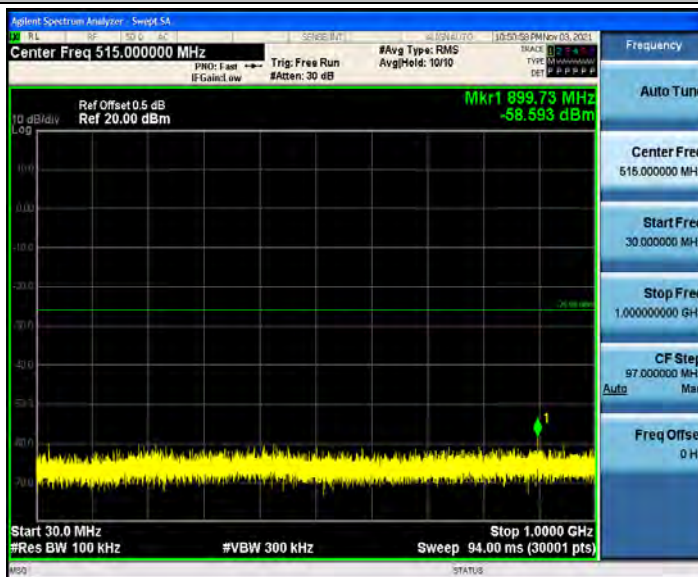

802.11n(HT40)_Ant2_2437_1000~26500



802.11n(HT40)_Ant1_2452_0~Reference

CTC Laboratories, Inc.

1-2/F., Building 2, Jiaquan Building, Guanlan High-Tech Park, Shenzhen, Guangdong, China
 Tel.: (86)755-27521059

Fax: (86)755-27521011 Http://www.sz-ctc.org.cn
 For anti-fake verification, please visit the official website of Certification and Accreditation Administration of the People's Republic of China : yz.cnca.cn





802.11n(HT40)_Ant1_2452_30~1000



802.11n(HT40)_Ant1_2452_1000~26500

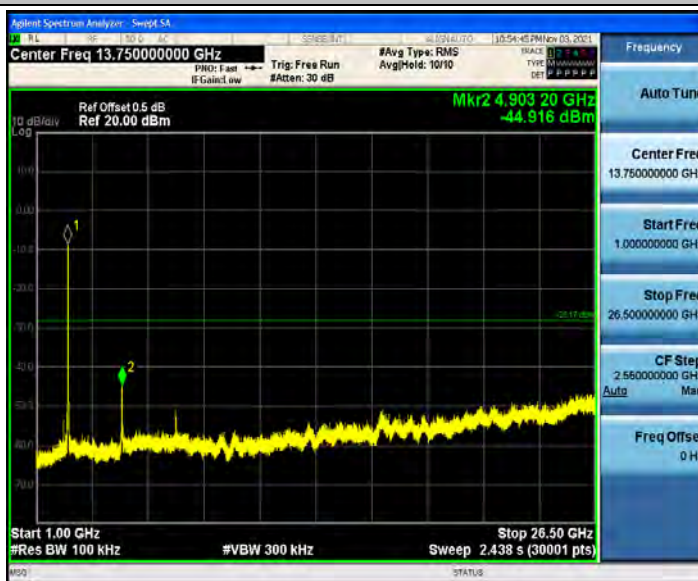

802.11n(HT40)_Ant2_2452_0~Reference

CTC Laboratories, Inc.

1-2/F., Building 2, Jiaquan Building, Guanlan High-Tech Park, Shenzhen, Guangdong, China
 Tel.: (86)755-27521059 Fax: (86)755-27521011 Http://www.sz-ctc.org.cn



For anti-fake verification, please visit the official website of Certification and Accreditation Administration of the People's Republic of China : yz.cnca.cn



802.11n(HT40)_Ant2_2452_30~1000



802.11n(HT40)_Ant2_2452_1000~26500

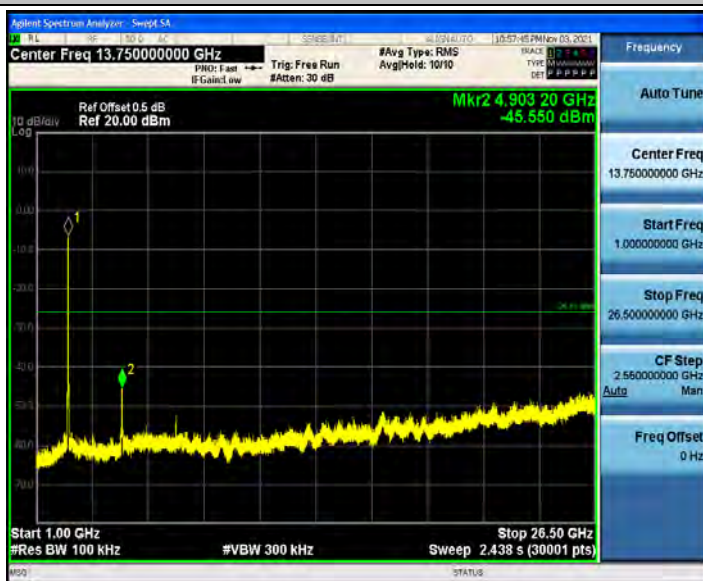

CTC Laboratories, Inc.

1-2/F., Building 2, Jiaquan Building, Guanlan High-Tech Park, Shenzhen, Guangdong, China
Tel.: (86)755-27521059 Fax: (86)755-27521011 Http://www.sz-ctc.org.cn



For anti-fake verification, please visit the official website of Certification and Accreditation Administration of the People's Republic of China : yz.cnca.cn



3.5. DTS Bandwidth

Limit

FCC CFR Title 47 Part 15 Subpart C Section 15.247 (a)(2)/ RSS-247 5.2 a:

Test Item	Limit	Frequency Range(MHz)
DTS Bandwidth	≥ 500 KHz (6dB bandwidth)	2400~2483.5

Test Configuration

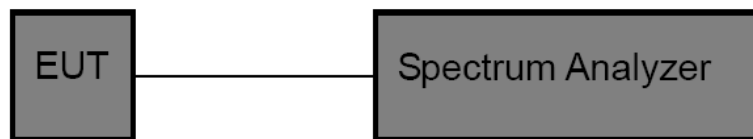

Test Procedure

5. The EUT was directly connected to the spectrum analyzer and antenna output port as show in the block diagram above.
6. DTS Spectrum Setting:
 - (1) Set RBW = 100 kHz.
 - (2) Set the video bandwidth (VBW) ≥ 3 RBW.
 - (3) Detector = Peak.
 - (4) Trace mode = Max hold.
 - (5) Sweep = Auto couple.
- OCB Spectrum Setting:
 - (1) Set RBW = 1% ~ 5% occupied bandwidth.
 - (2) Set the video bandwidth (VBW) ≥ 3 RBW.
 - (3) Detector = Peak.
 - (4) Trace mode = Max hold.
 - (5) Sweep = Auto couple.

NOTE: The EUT was set to continuously transmitting in each mode and low, Middle and high channel for the test.

Test Mode

Please refer to the clause 2.4.

**Test Results**

Test Mode	Antenna	Channel	DTS BW [MHz]	Limit[MHz]	Verdict
802.11b	Ant1	2412	11.640	>=0.5	PASS
	Ant2	2412	11.680	>=0.5	PASS
	Ant1	2437	13.120	>=0.5	PASS
	Ant2	2437	13.080	>=0.5	PASS
	Ant1	2462	11.600	>=0.5	PASS
	Ant2	2462	12.640	>=0.5	PASS
802.11g	Ant1	2412	16.440	>=0.5	PASS
	Ant2	2412	16.440	>=0.5	PASS
	Ant1	2437	16.520	>=0.5	PASS
	Ant2	2437	16.440	>=0.5	PASS
	Ant1	2462	16.480	>=0.5	PASS
	Ant2	2462	16.440	>=0.5	PASS
802.11n(HT20)	Ant1	2412	17.600	>=0.5	PASS
	Ant2	2412	17.640	>=0.5	PASS
	Ant1	2437	17.360	>=0.5	PASS
	Ant2	2437	17.640	>=0.5	PASS
	Ant1	2462	17.640	>=0.5	PASS
	Ant2	2462	17.440	>=0.5	PASS
802.11n(HT40)	Ant1	2422	36.000	>=0.5	PASS
	Ant2	2422	36.160	>=0.5	PASS
	Ant1	2437	35.760	>=0.5	PASS
	Ant2	2437	36.000	>=0.5	PASS
	Ant1	2452	35.840	>=0.5	PASS
	Ant2	2452	35.920	>=0.5	PASS



802.11b_Ant1_2412



802.11b_Ant2_2412



802.11b_Ant1_2437



CTC Laboratories, Inc.

1-2/F., Building 2, Jiaquan Building, Guanlan High-Tech Park, Shenzhen, Guangdong, China
Tel.: (86)755-27521059 Fax: (86)755-27521011 Http://www.sz-ctc.org.cn



For anti-fake verification, please visit the official website of Certification and Accreditation Administration of the People's Republic of China : yz.cnca.cn



802.11b_Ant2_2437



802.11b_Ant1_2462



802.11b_Ant2_2462



802.11g_Ant1_2412

CTC Laboratories, Inc.

1-2/F., Building 2, Jiaquan Building, Guanlan High-Tech Park, Shenzhen, Guangdong, China

Tel.: (86)755-27521059

Fax: (86)755-27521011

Http://www.sz-ctc.org.cn



For anti-fake verification, please visit the official website of Certification and Accreditation Administration of the People's Republic of China : yz.cnca.cn

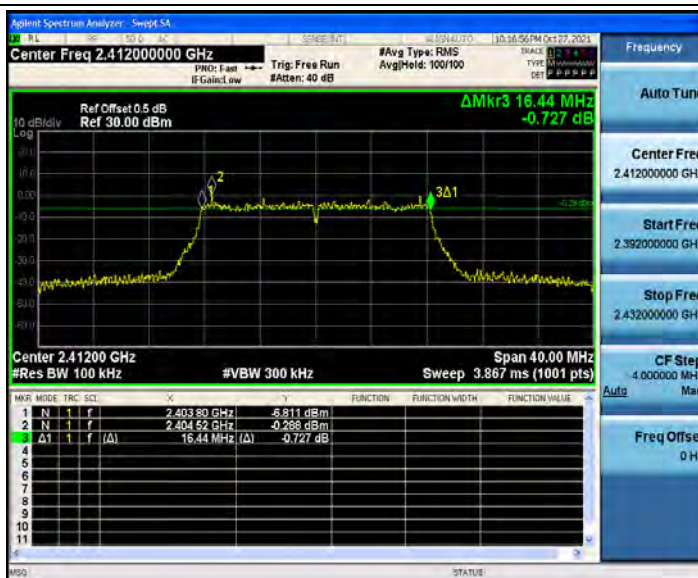

802.11g_Ant2_2412

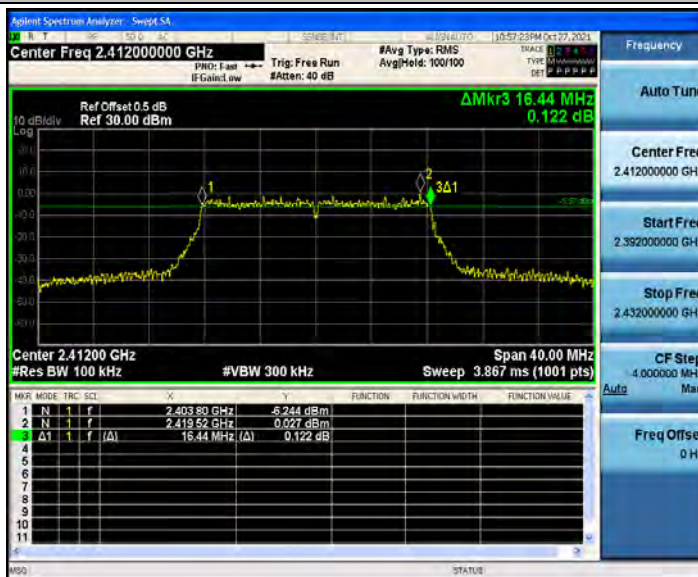

802.11g_Ant1_2437



802.11g_Ant2_2437

CTC Laboratories, Inc.

1-2/F., Building 2, Jiaquan Building, Guanlan High-Tech Park, Shenzhen, Guangdong, China
Tel.: (86)755-27521059

Fax: (86)755-27521011 Http://www.sz-ctc.org.cn
For anti-fake verification, please visit the official website of Certification and Accreditation Administration of the People's Republic of China : yz.cnca.cn





802.11g_Ant1_2462



802.11g_Ant2_2462



802.11n(HT20)_Ant1_2412

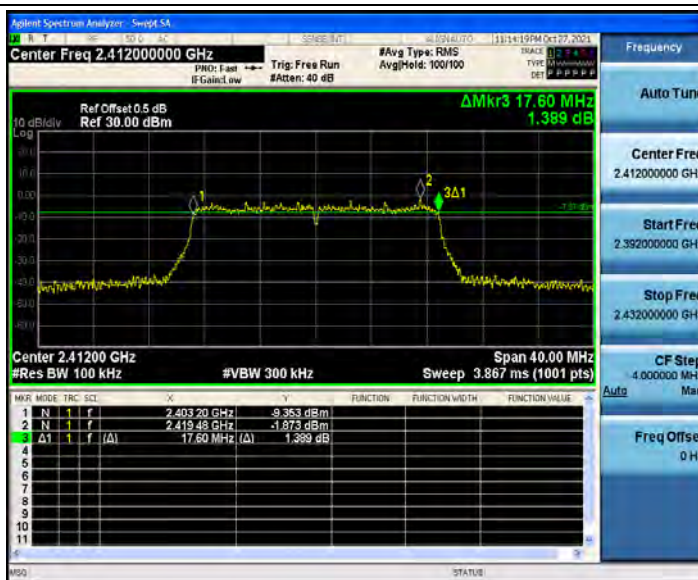

802.11n(HT20)_Ant2_2412



802.11n(HT20)_Ant1_2437



802.11n(HT20)_Ant2_2437

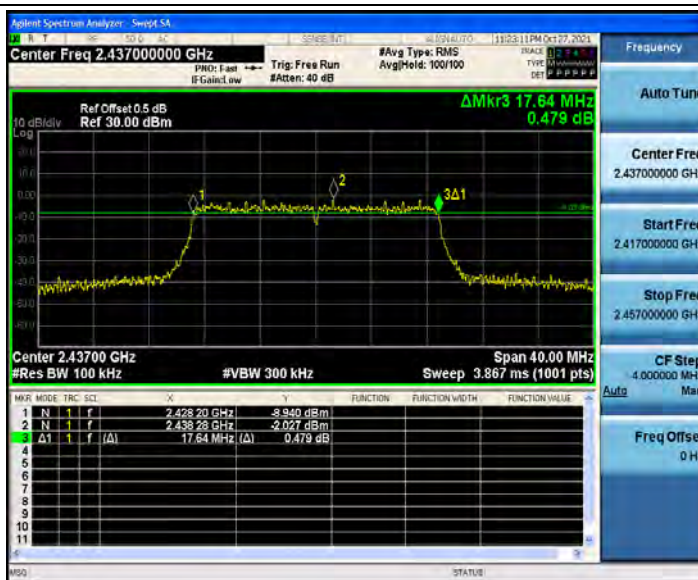

802.11n(HT20)_Ant1_2462



802.11n(HT20)_Ant2_2462



802.11n(HT40)_Ant1_2422

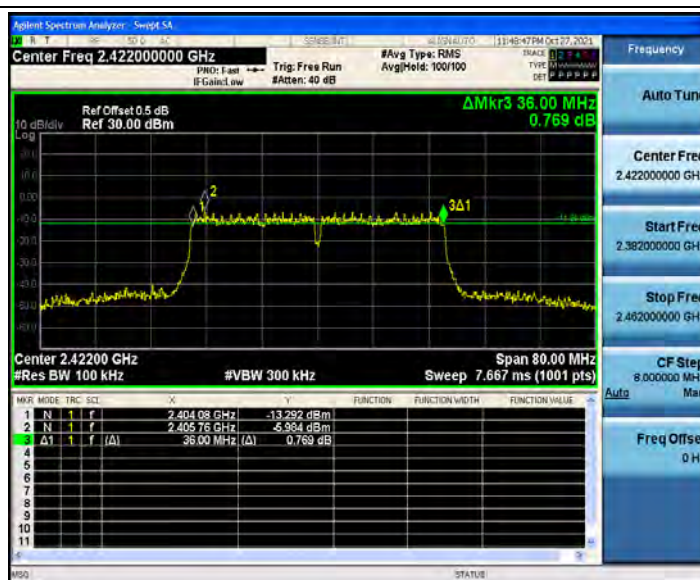

802.11n(HT40)_Ant2_2422



802.11n(HT40)_Ant1_2437

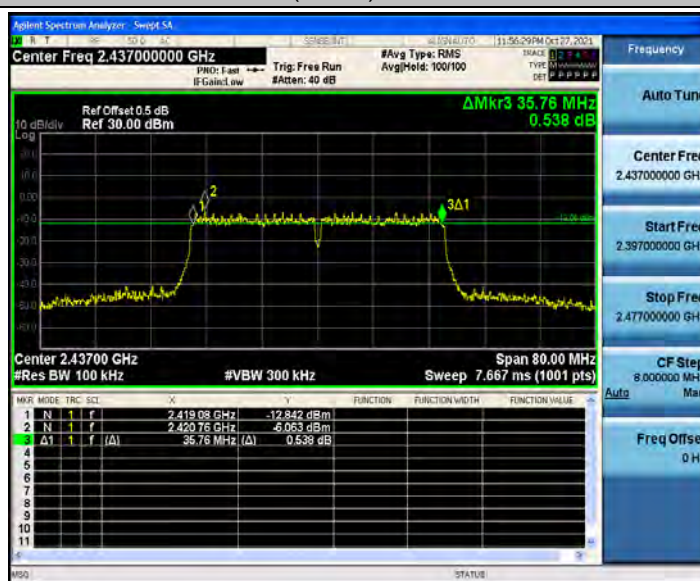

802.11n(HT40)_Ant2_2437

CTC Laboratories, Inc.

1-2/F., Building 2, Jiaquan Building, Guanlan High-Tech Park, Shenzhen, Guangdong, China
Tel.: (86)755-27521059

Fax: (86)755-27521011 Http://www.sz-ctc.org.cn
For anti-fake verification, please visit the official website of Certification and Accreditation Administration of the People's Republic of China : yz.cnca.cn



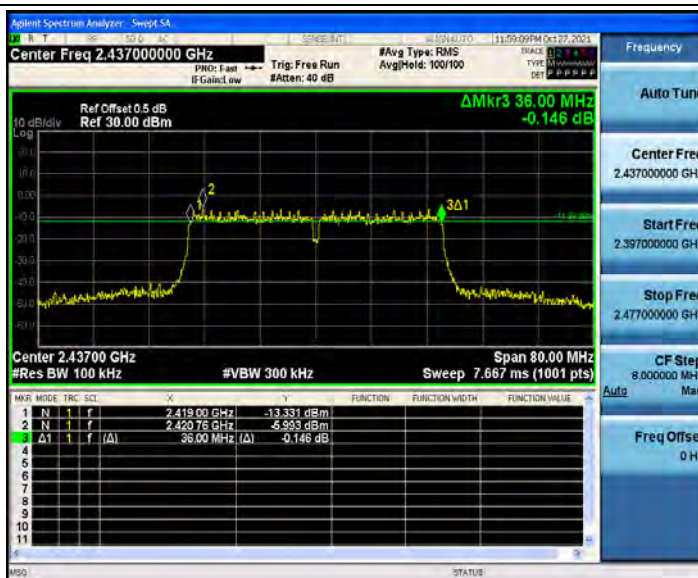

802.11n(HT40)_Ant1_2452

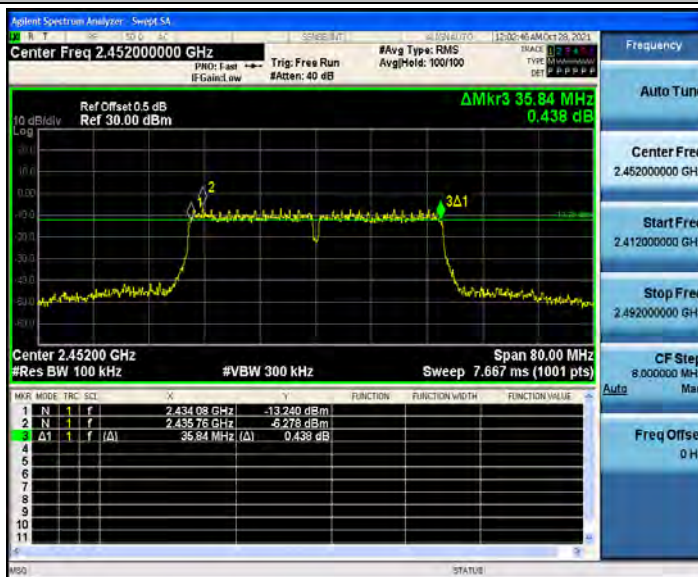

802.11n(HT40)_Ant2_2452

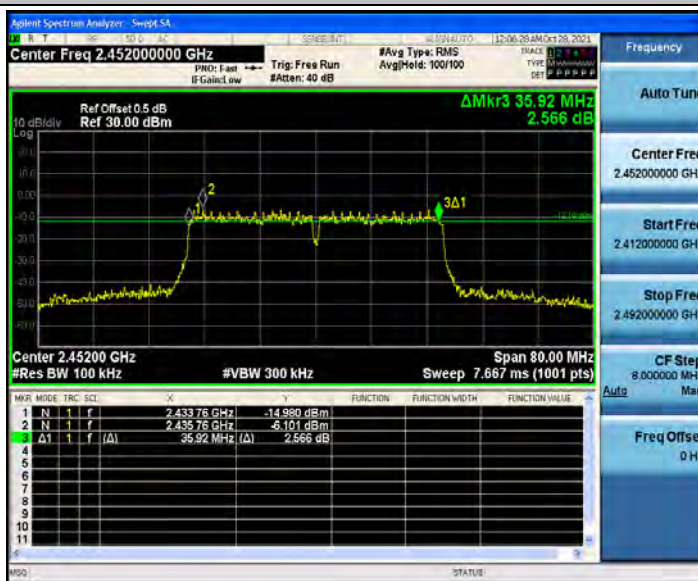



3.6. Peak Output Power

Limit

FCC CFR Title 47 Part 15 Subpart C Section 15.247 (b)(3)/ RSS-247 5.4:

Section	Test Item	Limit	Frequency Range(MHz)
CFR 47 FCC 15.247(b)(3)	Maximum conducted output power	1 Watt or 30dBm	2400~2483.5
ISED RSS-247 5.4 d	EIRP	4 Watt or 36dBm	2400~2483.5

Test Configuration

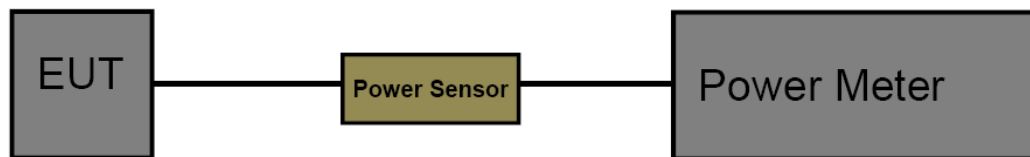

Test Procedure

1. The maximum conducted output power may be measured using a broadband Peak RF power meter.
2. Peak power measurements were performed only when the EUT was transmitting at its maximum power control level using a broadband power meter with a pulse sensor.
3. The power meter implemented triggering and gating capabilities which were set up such that power measurements were recorded only during the ON time of the transmitter.
4. Record the measurement data.

Test Mode

Please refer to the clause 2.4.

Test Result



Test Mode	Antenna	Channel	Result[dBm]	Limit[dBm]	Verdict
802.11b	Ant1	2412	14.50	<=30	PASS
	Ant2	2412	16.40	<=30	PASS
	Ant1	2437	13.90	<=30	PASS
	Ant2	2437	15.40	<=30	PASS
	Ant1	2462	14.20	<=30	PASS
	Ant2	2462	15.60	<=30	PASS
802.11g	Ant1	2412	13.44	<=30	PASS
	Ant2	2412	13.70	<=30	PASS
	Ant1	2437	13.45	<=30	PASS
	Ant2	2437	16.14	<=30	PASS
	Ant1	2462	13.24	<=30	PASS
	Ant2	2462	15.80	<=30	PASS
802.11n(HT20)	Ant1	2412	12.20	<=30	PASS
	Ant2	2412	15.16	<=30	PASS
	Total	2412	16.94	<=27.19	PASS
	Ant1	2437	12.13	<=30	PASS
	Ant2	2437	15.10	<=30	PASS
	Total	2437	16.87	<=27.19	PASS
	Ant1	2462	12.20	<=30	PASS
	Ant2	2462	14.73	<=30	PASS
	Total	2462	16.66	<=27.19	PASS
802.11n(HT40)	Ant1	2422	10.45	<=30	PASS
	Ant2	2422	12.53	<=30	PASS
	Total	2422	14.62	<=27.19	PASS
	Ant1	2437	10.48	<=30	PASS
	Ant2	2437	12.35	<=30	PASS
	Total	2437	14.53	<=27.19	PASS
	Ant1	2452	10.16	<=30	PASS
	Ant2	2452	12.44	<=30	PASS
	Total	2452	14.46	<=27.19	PASS

Note: 1. Test results increased RF cable loss by 0.5dB.

2. The Directional Gain=8.81dBi > 6dBi. So $P_{out} = P_{limit} - (G_{TX} - 6) = 30 - 2.81 = 27.19\text{dBm}$



3.7. Power Spectral Density

Limit

FCC CFR Title 47 Part 15 Subpart C Section 15.247 (e)/ RSS-247 5.2 b:

Test Item	Limit	Frequency Range(MHz)
Power Spectral Density	8dBm(in any 3 kHz)	2400~2483.5

Test Configuration

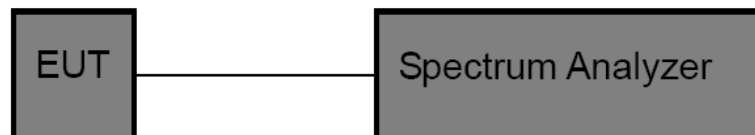

Test Procedure

1. The EUT was directly connected to the spectrum analyzer and antenna output port as show in the block diagram above.
2. The EUT was directly connected to the Spectrum Analyzer and antenna output port as show in the block diagram above. The measurement according to section 10.2 of KDB 558074 D01 DTS Meas Guidance v05r02.
3. Spectrum Setting:
Set analyzer center frequency to DTS channel center frequency.
Set the span to 1.5 times the DTS bandwidth.
Set the RBW to: 3 kHz
Set the VBW to: 10 kHz
Detector: PK
Sweep time: Auto
Allow trace to fully stabilize. Then use the peak marker function to determine the maximum amplitude level.

Test Mode

Please refer to the clause 2.4.

**Test Result**

Test Mode	Antenna	Channel	Result[dBm/3kHz]	Limit[dBm/3kHz]	Verdict
802.11b	Ant1	2412	-10.99	<=8	PASS
	Ant2	2412	-9.76	<=8	PASS
	Ant1	2437	-10.62	<=8	PASS
	Ant2	2437	-9.79	<=8	PASS
	Ant1	2462	-12.27	<=8	PASS
	Ant2	2462	-9.85	<=8	PASS
802.11g	Ant1	2412	-15.98	<=8	PASS
	Ant2	2412	-14.51	<=8	PASS
	Ant1	2437	-16.12	<=8	PASS
	Ant2	2437	-14.30	<=8	PASS
	Ant1	2462	-16.38	<=8	PASS
	Ant2	2462	-15.79	<=8	PASS
802.11n(HT20)	Ant1	2412	-16.68	<=8	PASS
	Ant2	2412	-14.49	<=8	PASS
	Total	2412	-12.44	<=5.19	PASS
	Ant1	2437	-15.79	<=8	PASS
	Ant2	2437	-15.53	<=8	PASS
	Total	2437	-12.65	<=5.19	PASS
	Ant1	2462	-17.72	<=8	PASS
	Ant2	2462	-18.13	<=8	PASS
	Total	2462	-14.91	<=5.19	PASS
802.11n(HT40)	Ant1	2422	-20.81	<=8	PASS
	Ant2	2422	-18.92	<=8	PASS
	Total	2422	-16.75	<=5.19	PASS
	Ant1	2437	-20.38	<=8	PASS
	Ant2	2437	-18.30	<=8	PASS
	Total	2437	-16.21	<=5.19	PASS
	Ant1	2452	-21.10	<=8	PASS
	Ant2	2452	-18.23	<=8	PASS
	Total	2452	-16.42	<=5.19	PASS

Note: The Directional Gain=8.81dBi > 6dBi. So $P_{out} = P_{limit} - (G_{TX} - 6) = 8 - 2.81 = 5.19 \text{ dBm}$



802.11b_Ant1_2412

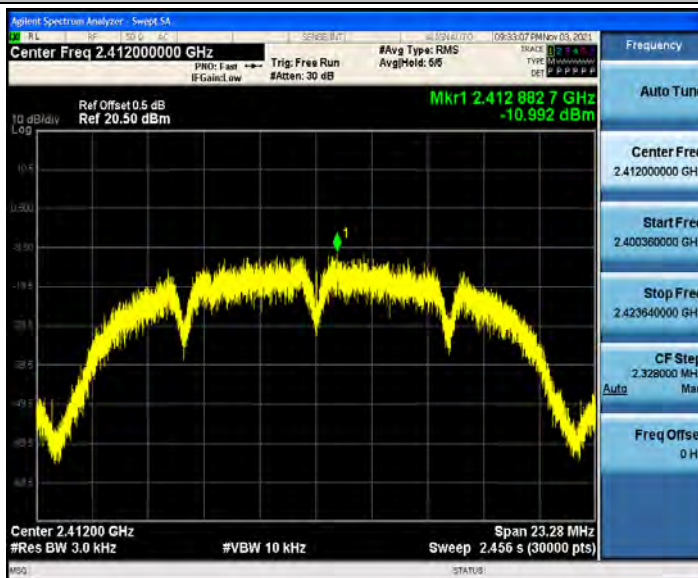

802.11b_Ant2_2412



802.11b_Ant1_2437



CTC Laboratories, Inc.

1-2/F., Building 2, Jiaquan Building, Guanlan High-Tech Park, Shenzhen, Guangdong, China

Tel.: (86)755-27521059

Fax: (86)755-27521011

Http://www.sz-ctc.org.cn



For anti-fake verification, please visit the official website of Certification and Accreditation Administration of the People's Republic of China : yz.cnca.cn



802.11b_Ant2_2437



802.11b_Ant1_2462



802.11b_Ant2_2462



802.11g_Ant1_2412

CTC Laboratories, Inc.

1-2/F., Building 2, Jiaquan Building, Guanlan High-Tech Park, Shenzhen, Guangdong, China

Tel.: (86)755-27521059

Fax: (86)755-27521011

Http://www.sz-ctc.org.cn



For anti-fake verification, please visit the official website of Certification and Accreditation Administration of the People's Republic of China : yz.cnca.cn



802.11g_Ant2_2412



802.11g_Ant1_2437

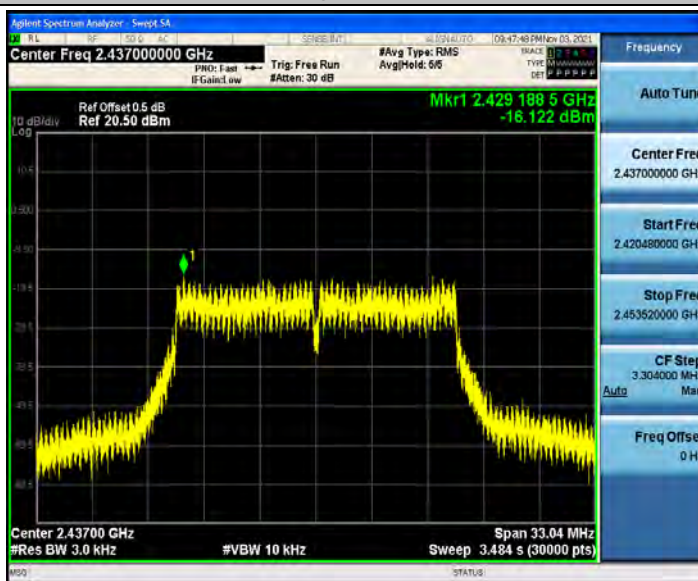

802.11g_Ant2_2437

CTC Laboratories, Inc.

1-2/F., Building 2, Jiaquan Building, Guanlan High-Tech Park, Shenzhen, Guangdong, China
 Tel.: (86)755-27521059 Fax: (86)755-27521011 Http://www.sz-ctc.org.cn



For anti-fake verification, please visit the official website of Certification and Accreditation Administration of the People's Republic of China : yz.cnca.cn

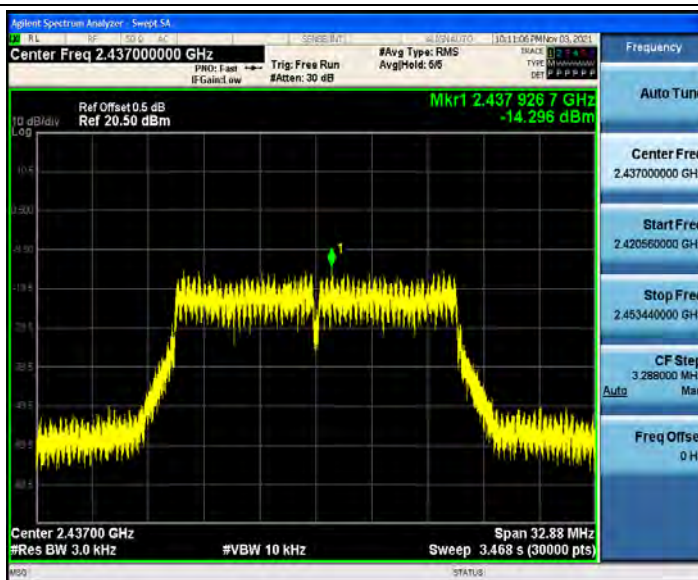

802.11g_Ant1_2462



802.11g_Ant2_2462

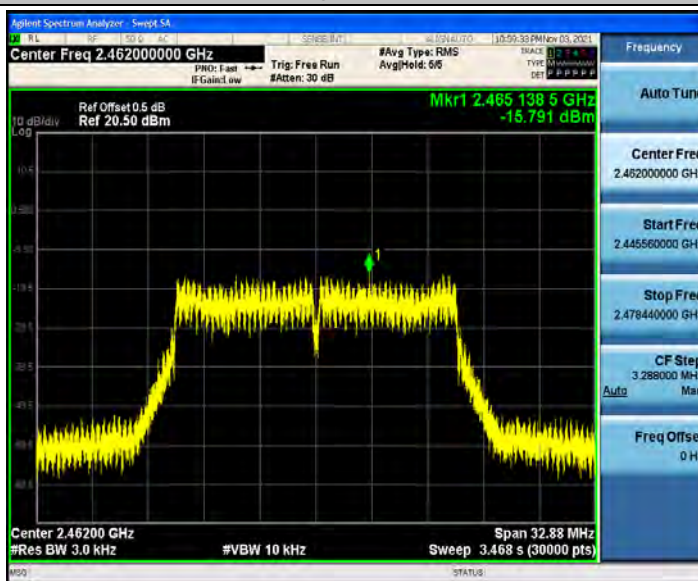

802.11n(HT20)_Ant1_2412

CTC Laboratories, Inc.

1-2/F., Building 2, Jiaquan Building, Guanlan High-Tech Park, Shenzhen, Guangdong, China
Tel.: (86)755-27521059 Fax: (86)755-27521011 Http://www.sz-ctc.org.cn



For anti-fake verification, please visit the official website of Certification and Accreditation Administration of the People's Republic of China : yz.cnca.cn



802.11n(HT20)_Ant2_2412

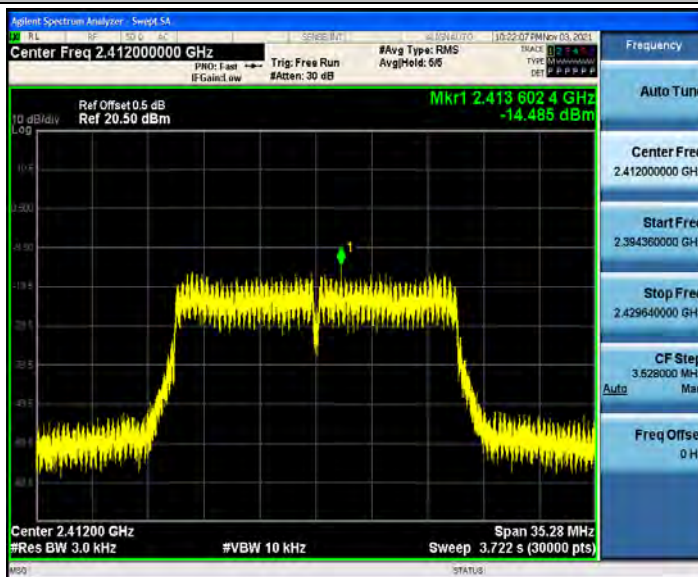

802.11n(HT20)_Ant1_2437



802.11n(HT20)_Ant2_2437

CTC Laboratories, Inc.

1-2/F., Building 2, Jiaquan Building, Guanlan High-Tech Park, Shenzhen, Guangdong, China
 Tel.: (86)755-27521059 Fax: (86)755-27521011 Http://www.sz-ctc.org.cn



For anti-fake verification, please visit the official website of Certification and Accreditation Administration of the People's Republic of China : yz.cnca.cn

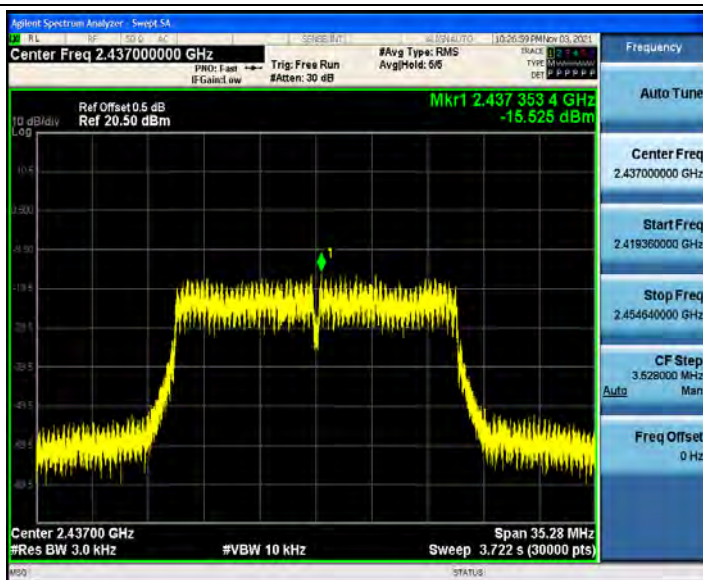

802.11n(HT20)_Ant1_2462

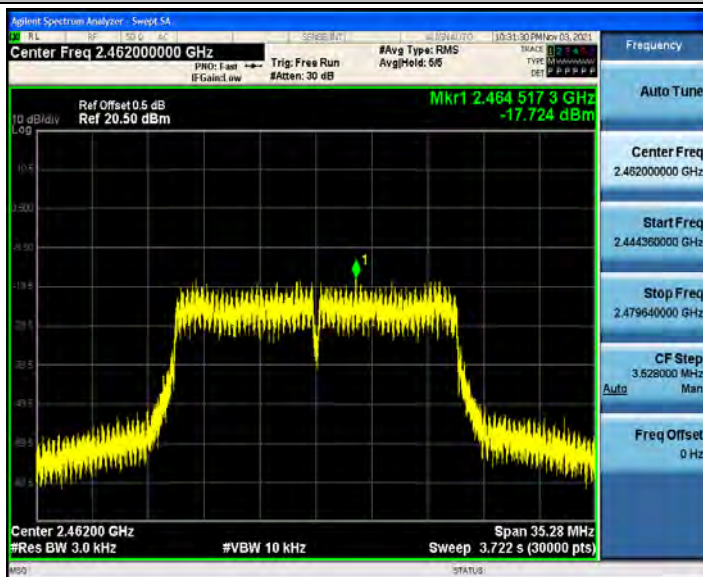

802.11n(HT20)_Ant2_2462

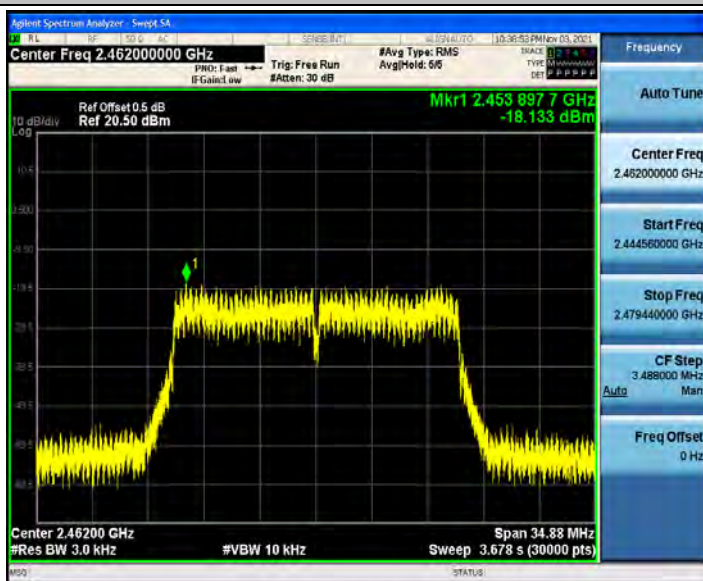

802.11n(HT40)_Ant1_2422

CTC Laboratories, Inc.

1-2/F., Building 2, Jiaquan Building, Guanlan High-Tech Park, Shenzhen, Guangdong, China
 Tel.: (86)755-27521059 Fax: (86)755-27521011 Http://www.sz-ctc.org.cn



For anti-fake verification, please visit the official website of Certification and Accreditation Administration of the People's Republic of China : yz.cnca.cn

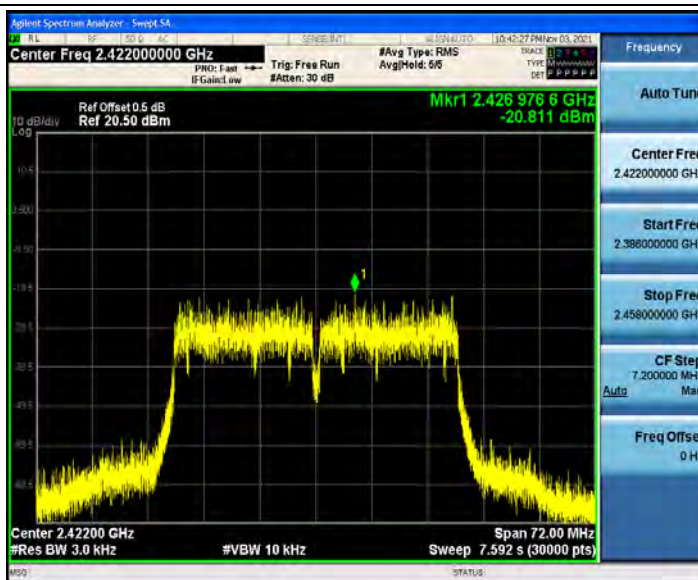

802.11n(HT40)_Ant2_2422



802.11n(HT40)_Ant1_2437

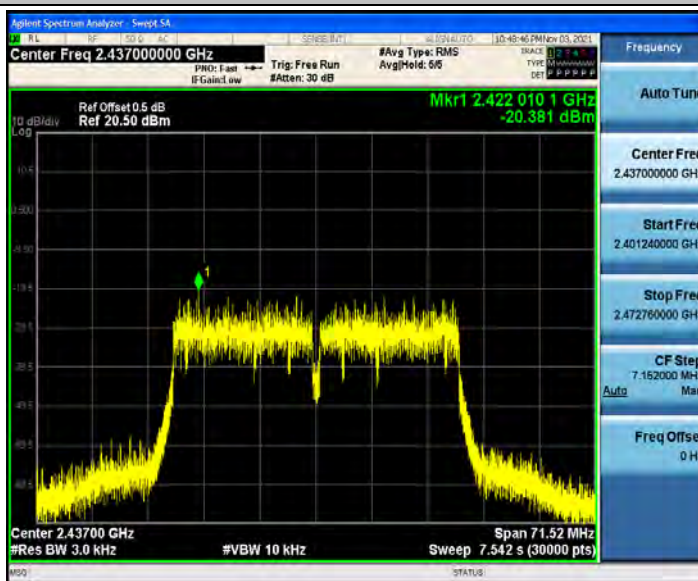

802.11n(HT40)_Ant2_2437

CTC Laboratories, Inc.

1-2/F., Building 2, Jiaquan Building, Guanlan High-Tech Park, Shenzhen, Guangdong, China
 Tel.: (86)755-27521059 Fax: (86)755-27521011 Http://www.sz-ctc.org.cn



For anti-fake verification, please visit the official website of Certification and Accreditation Administration of the People's Republic of China : yz.cnca.cn

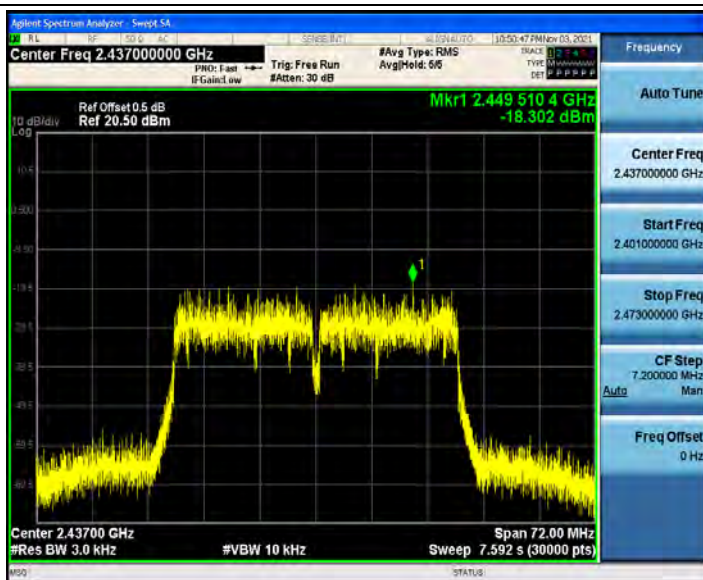

802.11n(HT40)_Ant1_2452

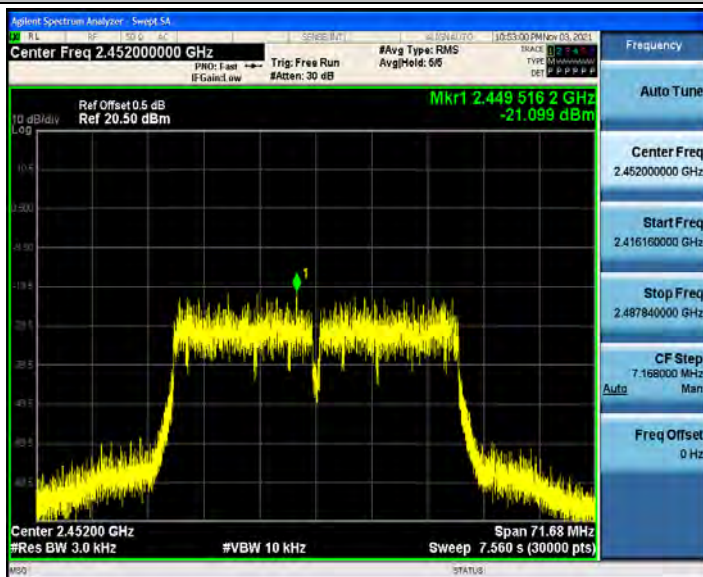

802.11n(HT40)_Ant2_2452

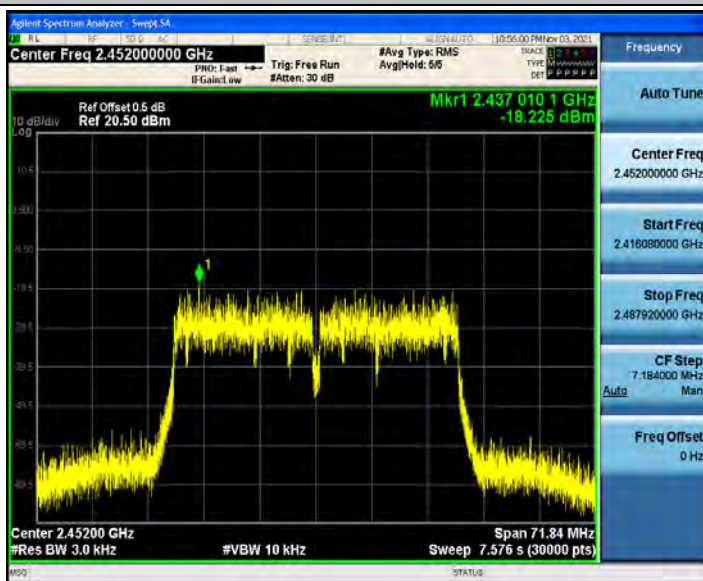

CTC Laboratories, Inc.

1-2/F., Building 2, Jiaquan Building, Guanlan High-Tech Park, Shenzhen, Guangdong, China
 Tel.: (86)755-27521059 Fax: (86)755-27521011 Http://www.sz-ctc.org.cn



For anti-fake verification, please visit the official website of Certification and Accreditation Administration of the People's Republic of China : yz.cnca.cn



3.8. Duty Cycle

Limit

None, for report purposes only.

Test Configuration

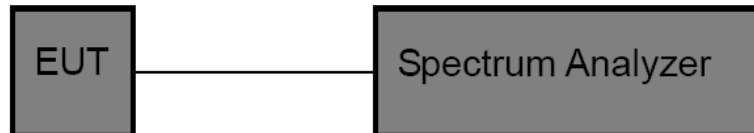

Test Procedure

1. The EUT was directly connected to the spectrum analyzer and antenna output port as show in the block diagram above.
2. The EUT was directly connected to the Spectrum Analyzer and antenna output port as show in the block diagram above. The measurement according to section 10.2 of KDB 558074 D01 DTS Meas Guidance v05r02.
3. Spectrum Setting:
Set analyzer center frequency to DTS channel center frequency.
Set the span to 0Hz
Set the RBW to 10MHz
Set the VBW to 10MHz
Detector: peak
Sweep time: auto
Allow trace to fully stabilize. Then use the peak marker function to determine the maximum amplitude level.

Test Mode

Please refer to the clause 2.4.

Test Result



Test Mode	Antenna	Channel	Transmission Duration [ms]	Transmission Period [ms]	Duty Cycle [%]	1/T Minimum VBW (kHz)	Final setting For VBW (kHz)
802.11b	Ant1	2412	8.28	8.30	99.76	0.12	1
	Ant2	2412	8.28	8.30	99.76	0.12	1
	Ant1	2437	8.28	8.30	99.76	0.12	1
	Ant2	2437	8.28	8.30	99.76	0.12	1
	Ant1	2462	8.28	8.30	99.76	0.12	1
	Ant2	2462	8.28	8.30	99.76	0.12	1
802.11g	Ant1	2412	1.39	1.40	99.29	0.72	1
	Ant2	2412	1.39	1.40	99.29	0.72	1
	Ant1	2437	1.39	1.40	99.29	0.72	1
	Ant2	2437	1.39	1.40	99.29	0.72	1
	Ant1	2462	1.39	1.40	99.29	0.72	1
	Ant2	2462	1.39	1.40	99.29	0.72	1
802.11n(HT20)	Ant1	2412	1.30	1.31	99.24	0.77	1
	Ant2	2412	1.30	1.31	99.24	0.77	1
	Ant1	2437	1.30	1.31	99.24	0.77	1
	Ant2	2437	1.30	1.31	99.24	0.77	1
	Ant1	2462	1.30	1.31	99.24	0.77	1
	Ant2	2462	1.30	1.31	99.24	0.77	1
802.11n(HT40)	Ant1	2422	1.30	1.31	99.24	0.77	1
	Ant2	2422	0.10	0.11	90.91	10.00	10
	Ant1	2437	0.10	0.11	90.91	10.00	10
	Ant2	2437	0.10	0.11	90.91	10.00	10
	Ant1	2452	0.10	0.11	90.91	10.00	10
	Ant2	2452	0.10	0.11	90.91	10.00	10



802.11b_Ant1_2412



802.11b_Ant2_2412

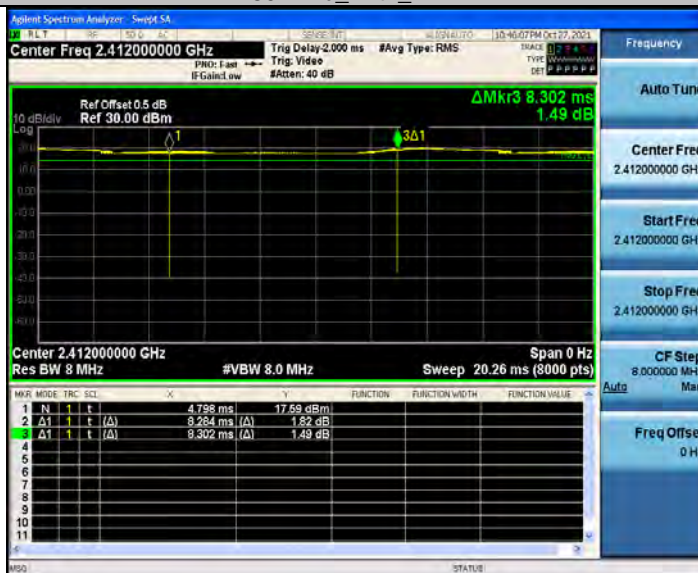

802.11b_Ant1_2437

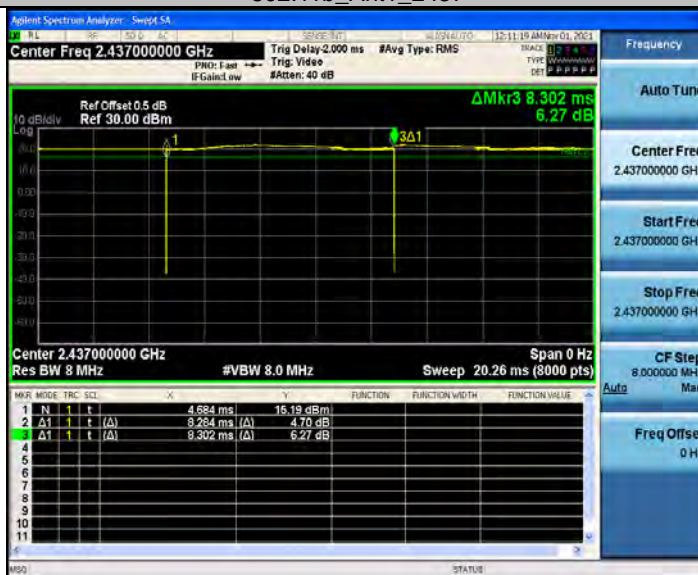

802.11b_Ant2_2437



802.11b_Ant1_2462

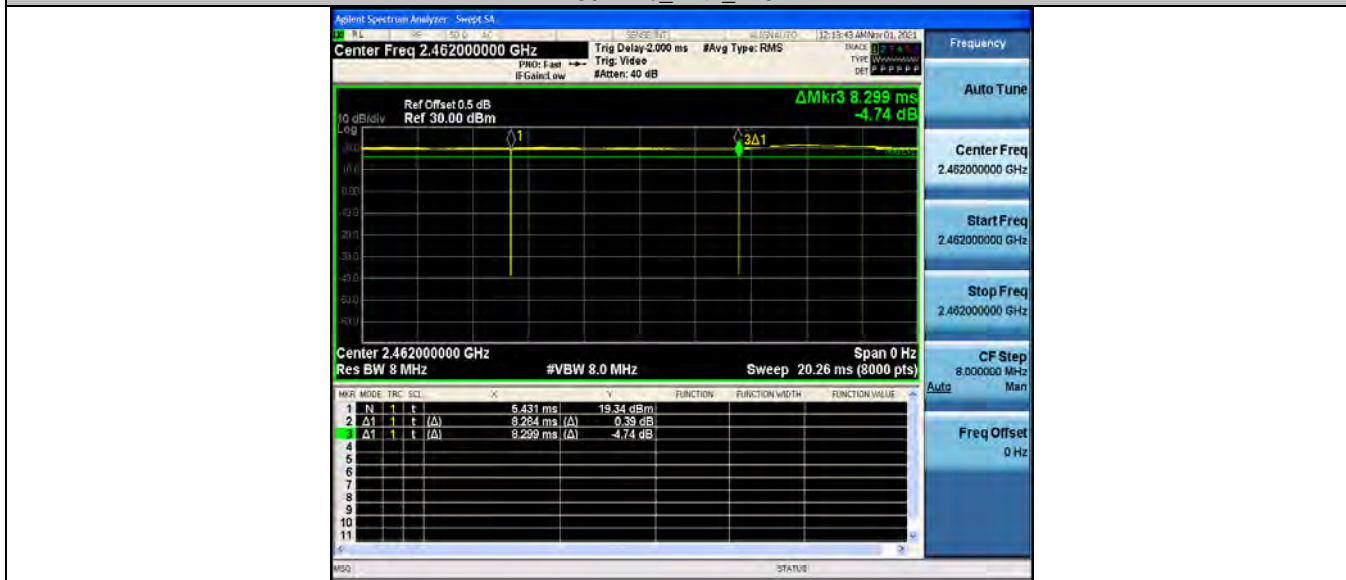

802.11b_Ant2_2462

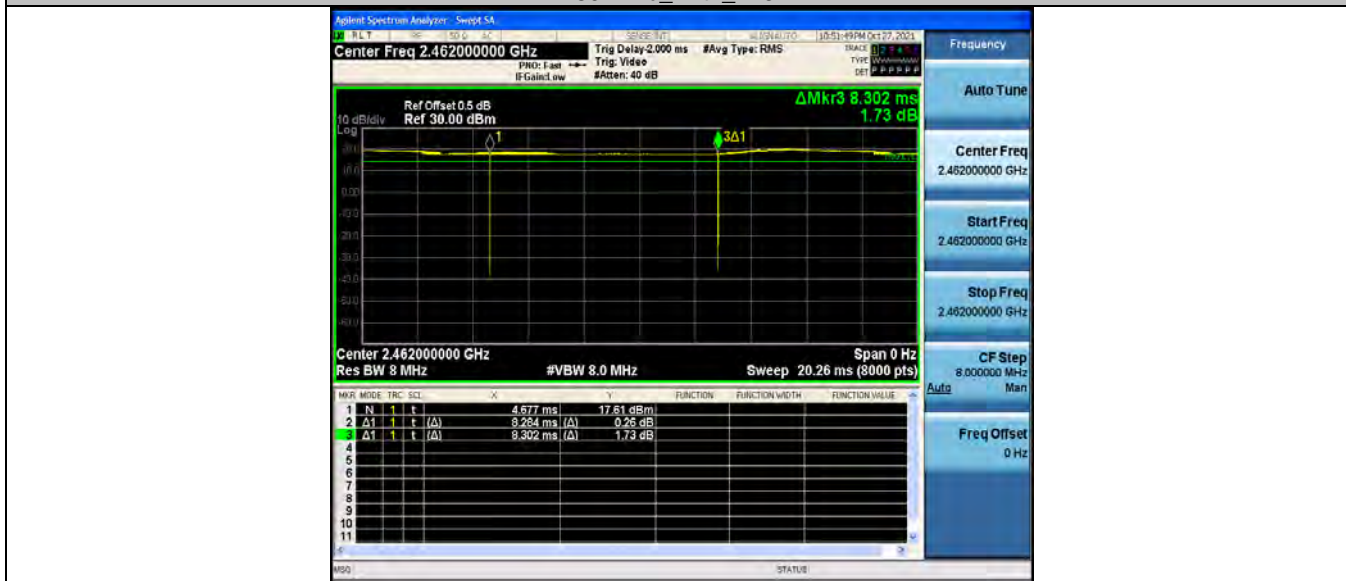

802.11g_Ant1_2412



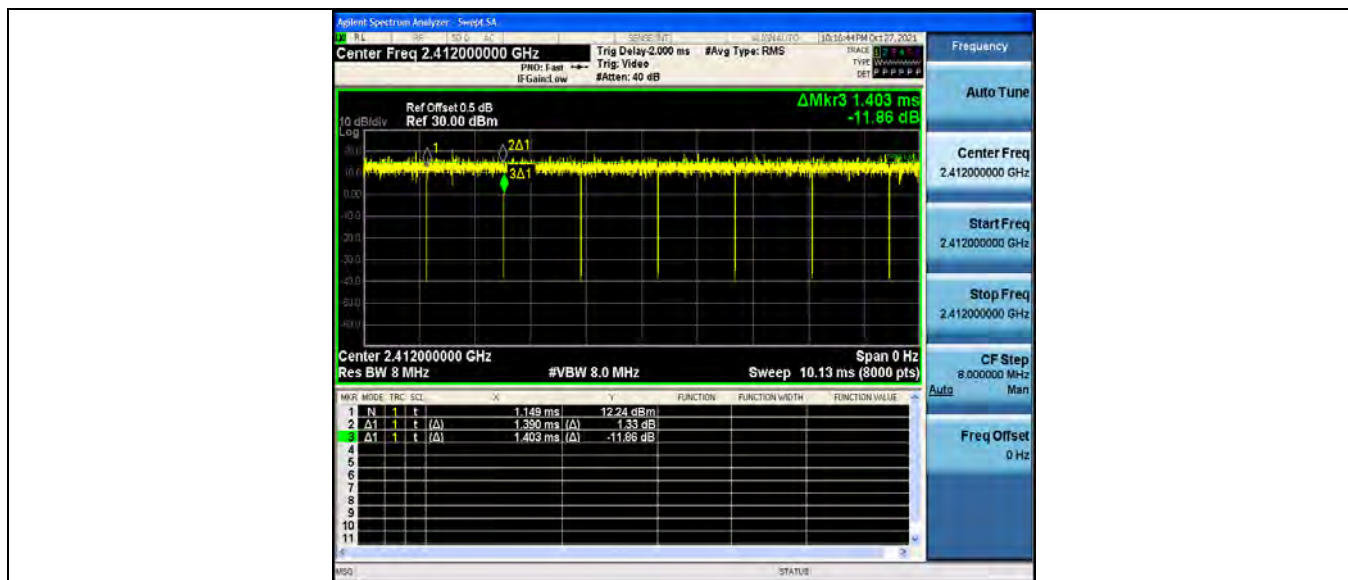

802.11g_Ant2_2412

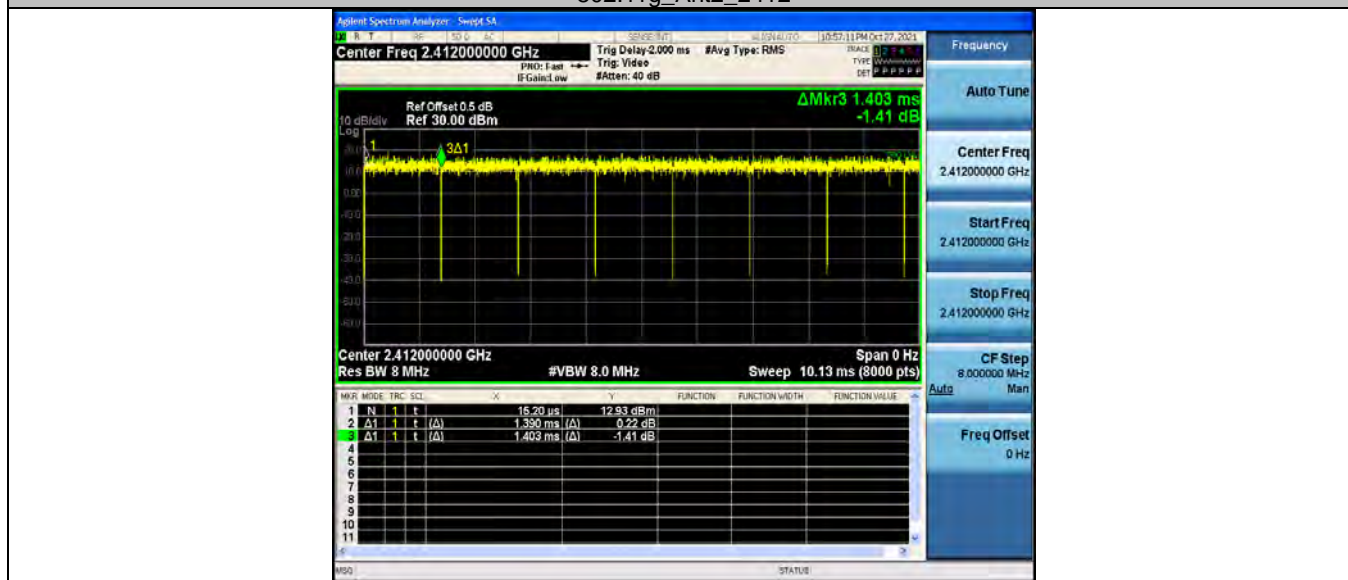

802.11g_Ant1_2437

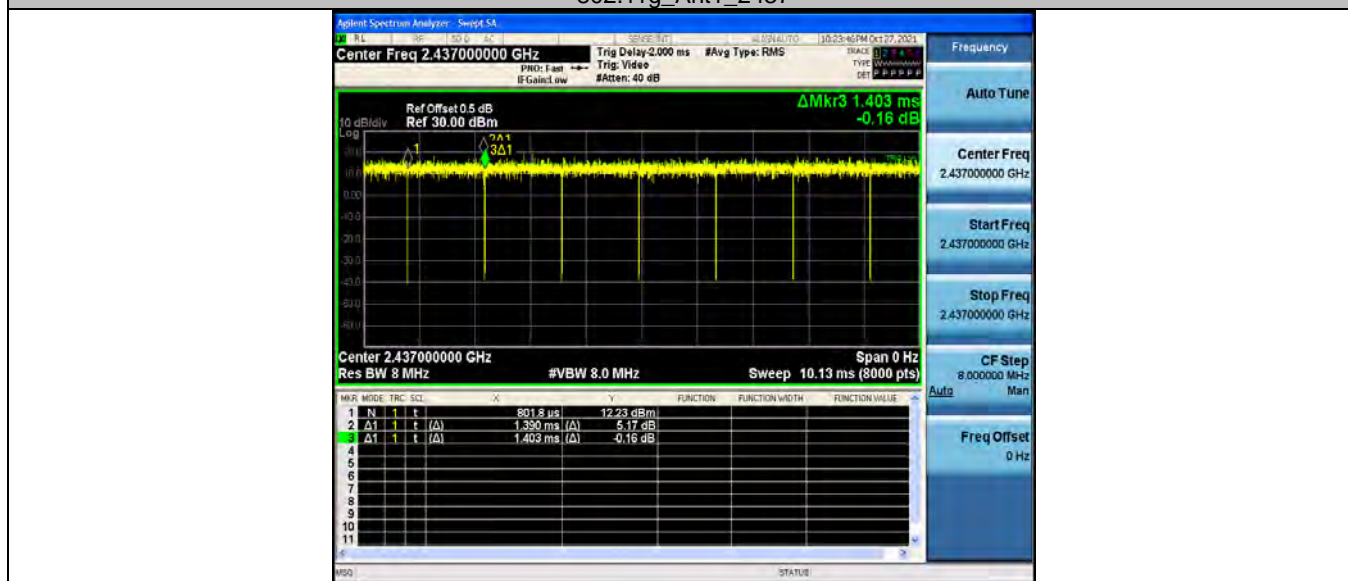

802.11g_Ant2_2437

CTC Laboratories, Inc.

1-2/F., Building 2, Jiaquan Building, Guanlan High-Tech Park, Shenzhen, Guangdong, China
Tel.: (86)755-27521059

Fax: (86)755-27521011 Http://www.sz-ctc.org.cn
For anti-fake verification, please visit the official website of Certification and Accreditation Administration of the People's Republic of China : yz.cnca.cn



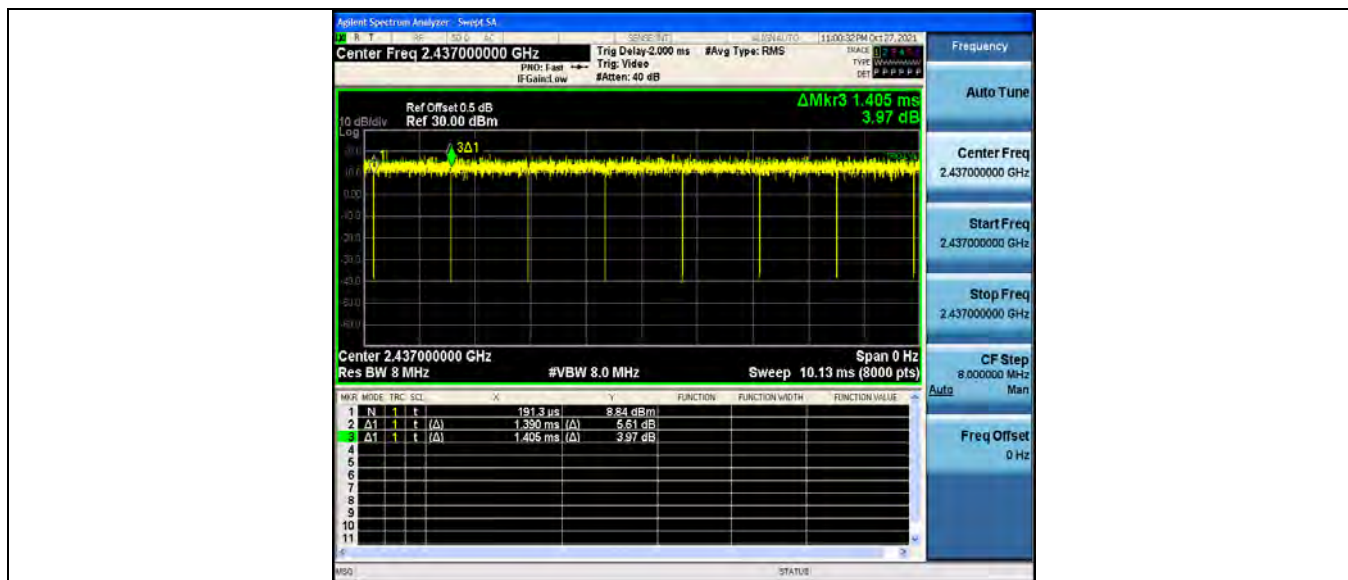

802.11g_Ant1_2462

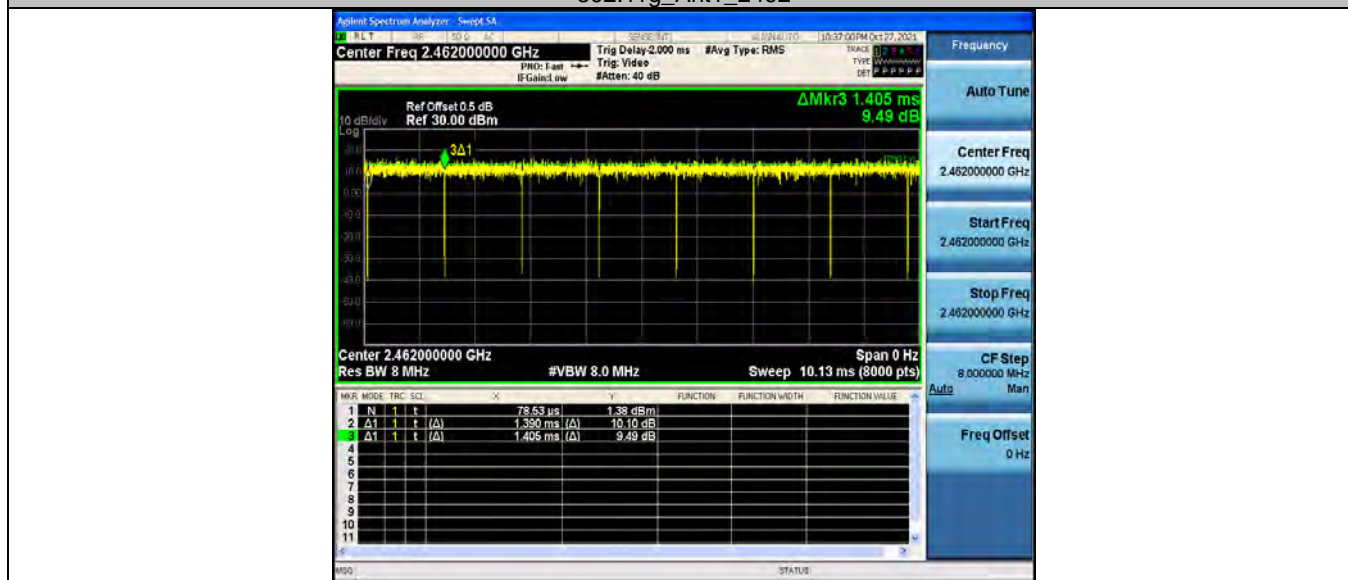

802.11g_Ant2_2462

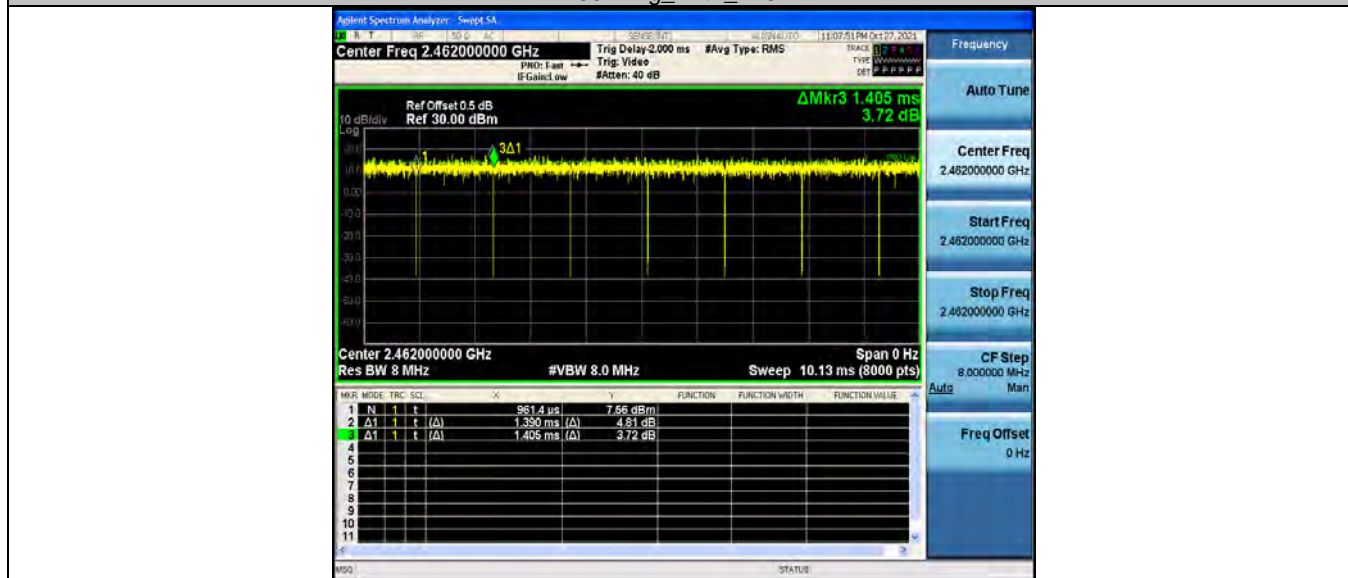

802.11n(HT20)_Ant1_2412



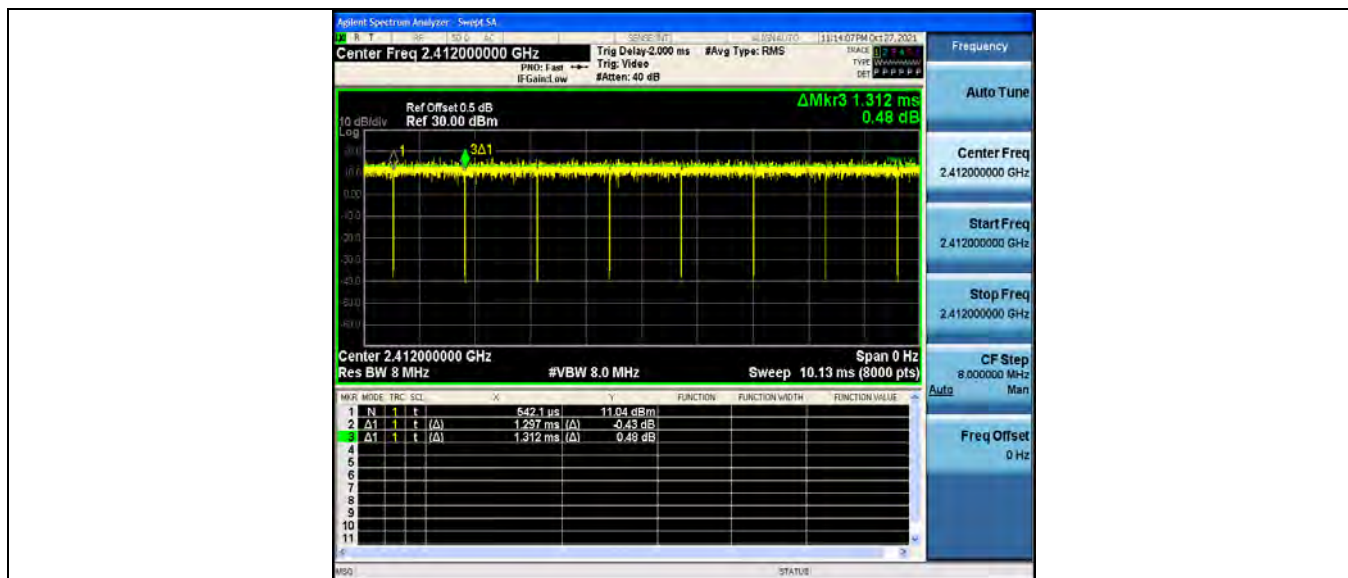

802.11n(HT20)_Ant2_2412

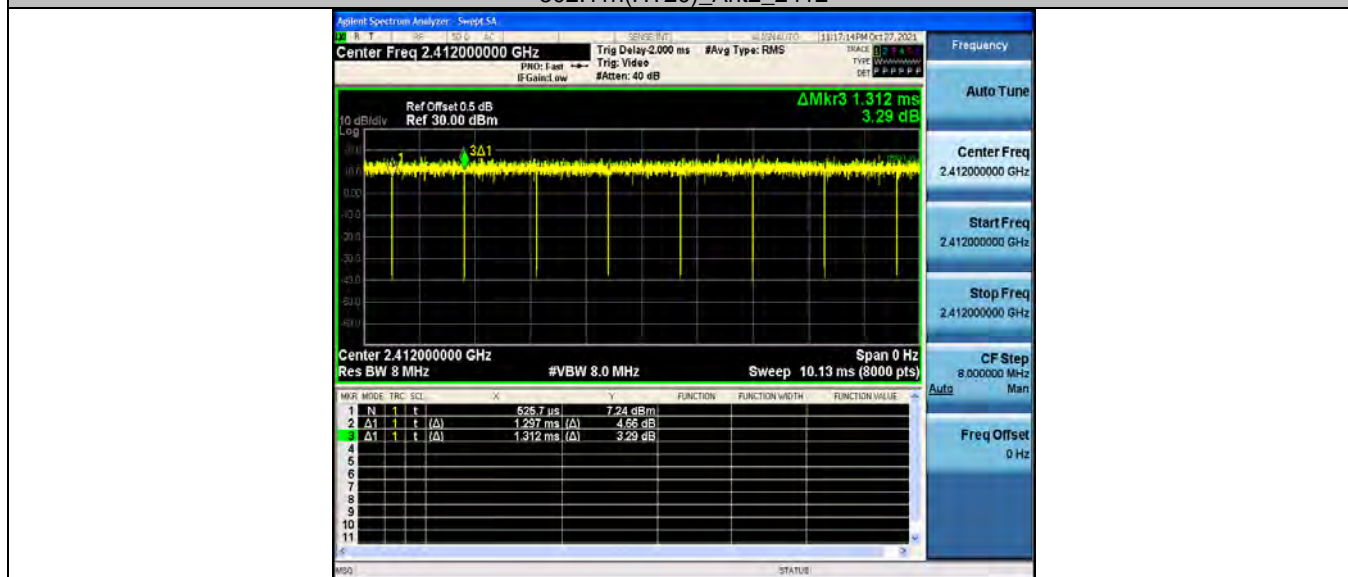

802.11n(HT20)_Ant2_2437

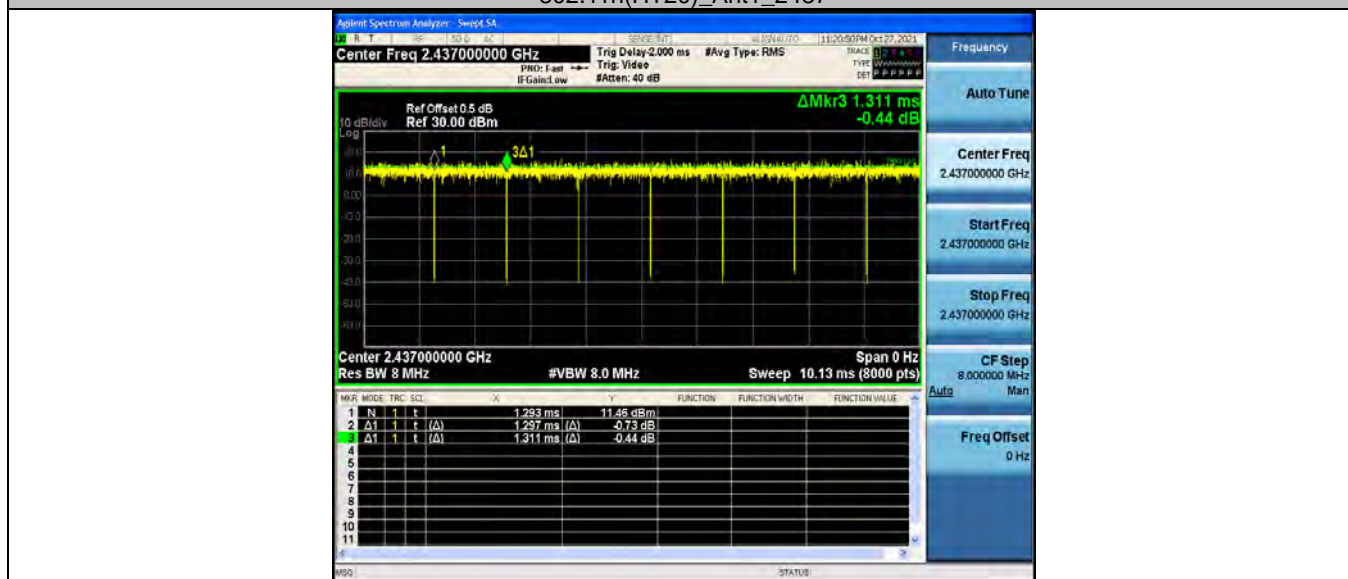

802.11n(HT20)_Ant1_2437



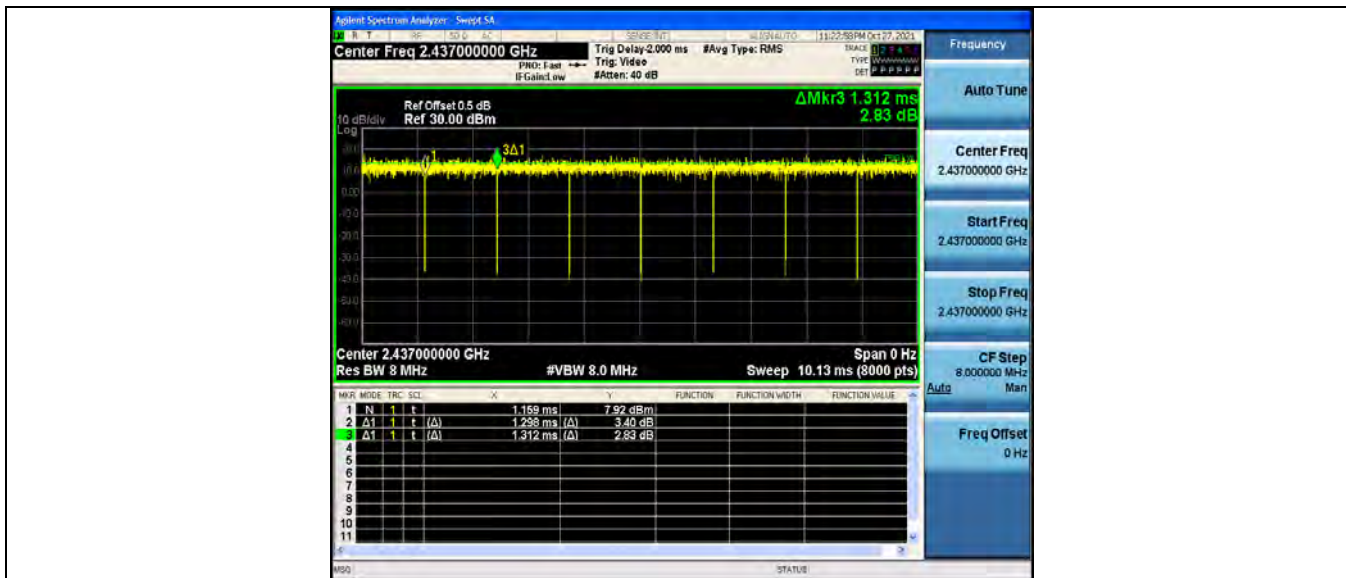

802.11n(HT20)_Ant1_2462

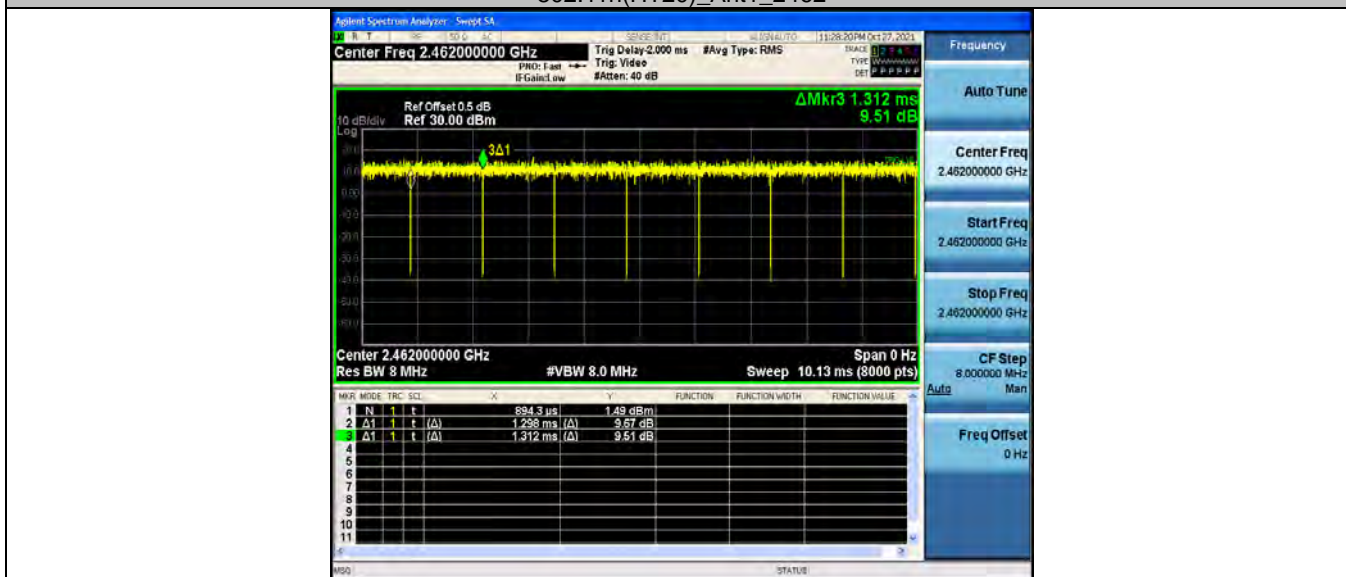

802.11n(HT20)_Ant2_2462

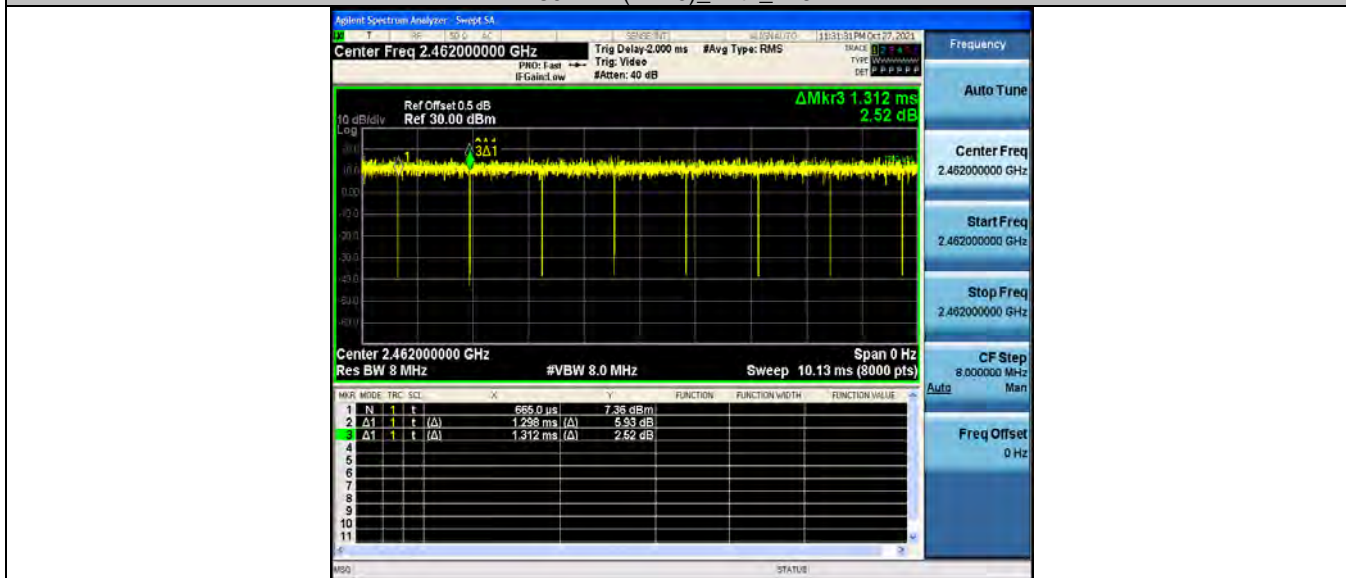

802.11n(HT40)_Ant1_2422



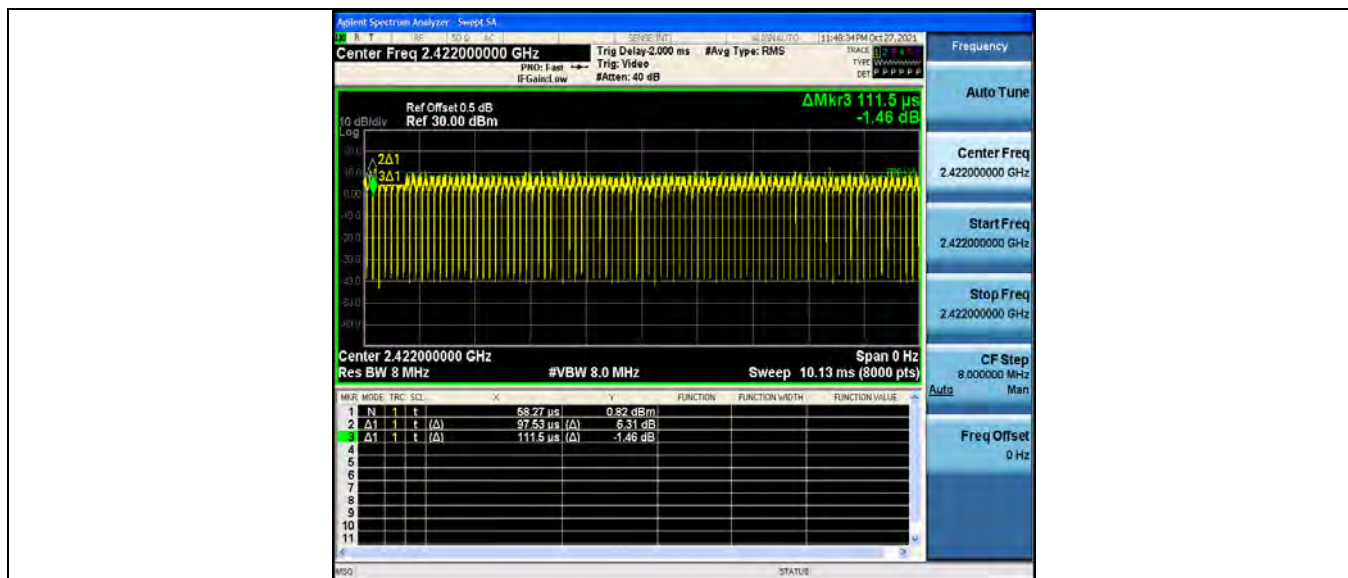

802.11n(HT40)_Ant2_2422

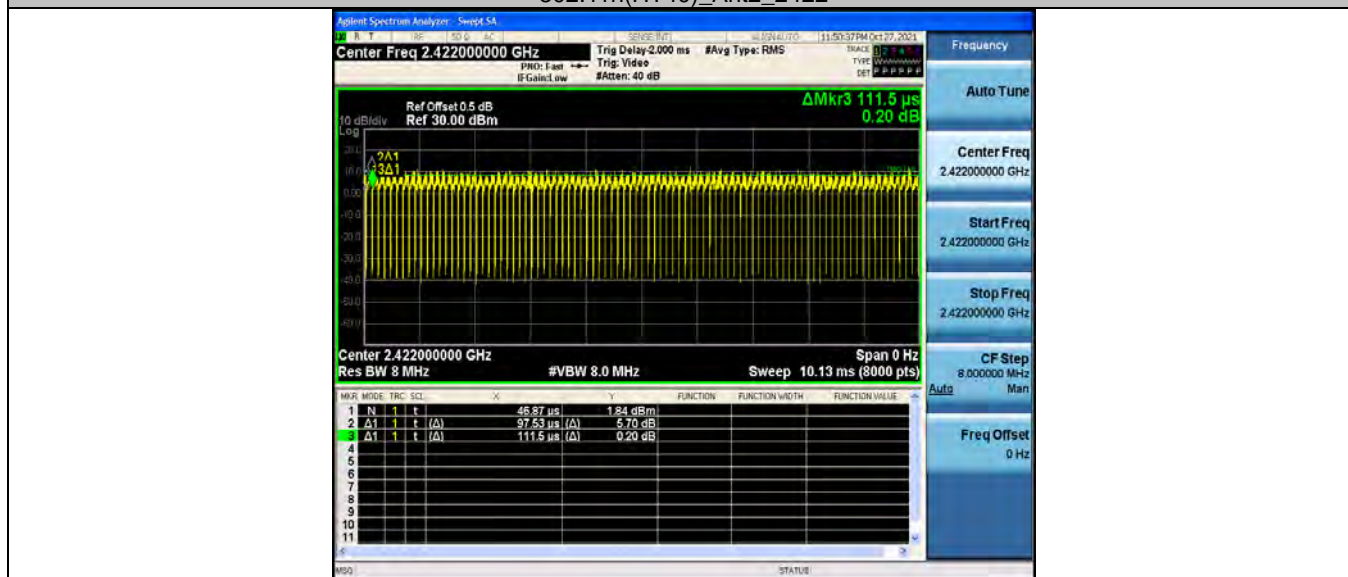

802.11n(HT40)_Ant1_2437

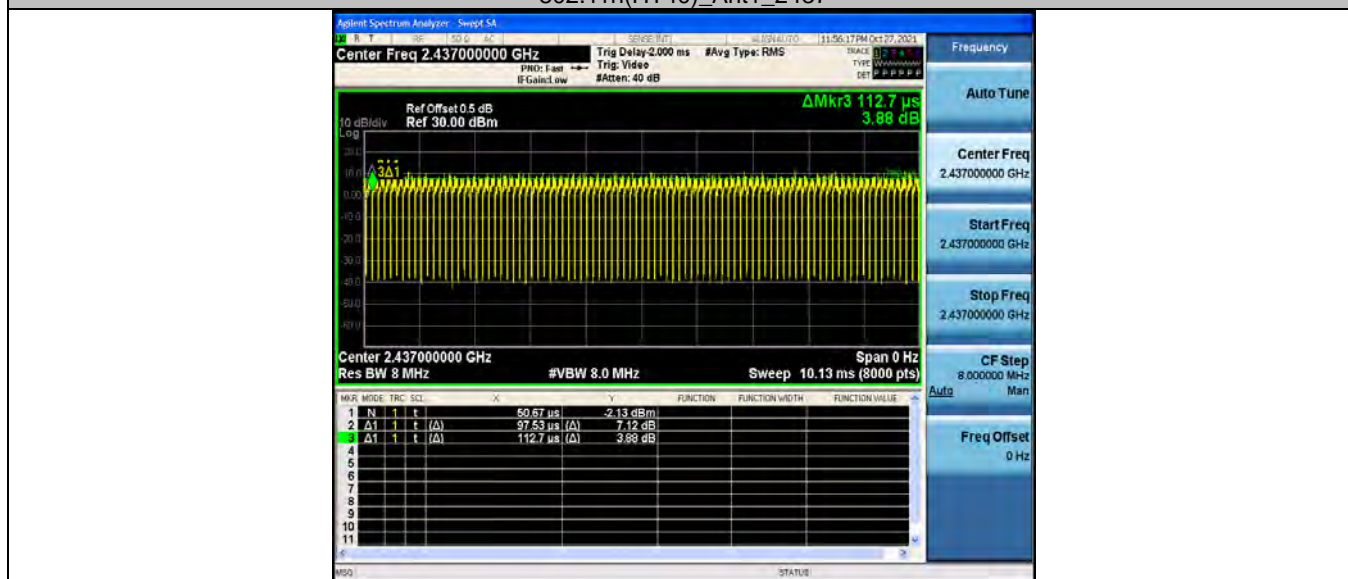

802.11n(HT40)_Ant2_2437



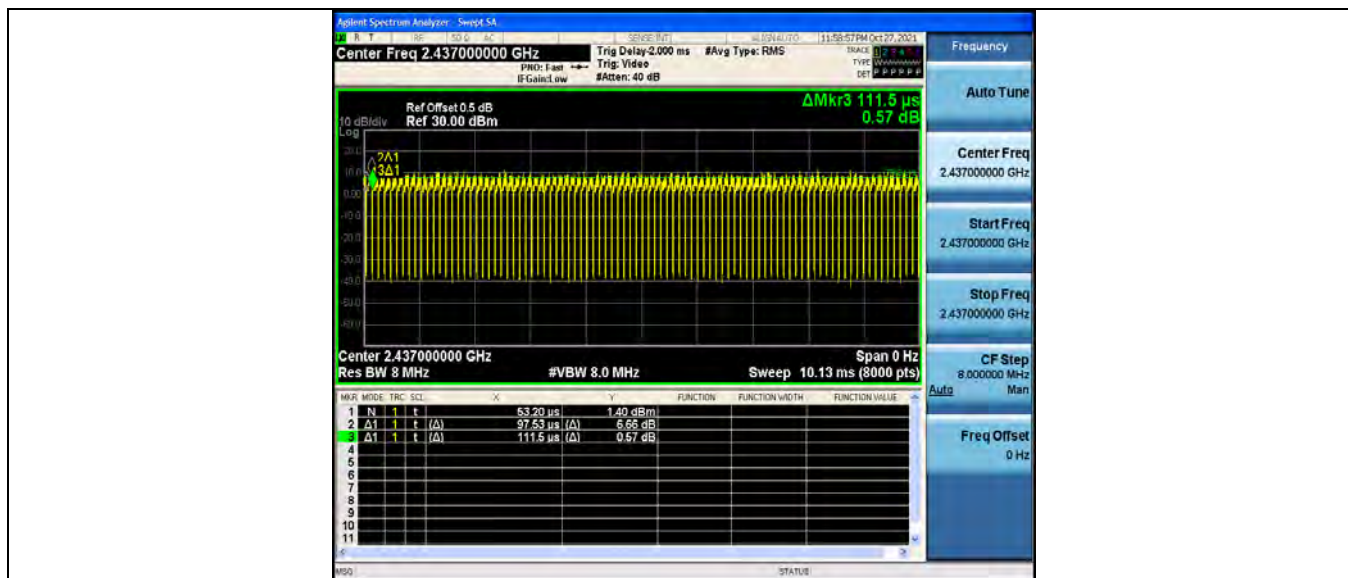

802.11n(HT40)_Ant1_2452

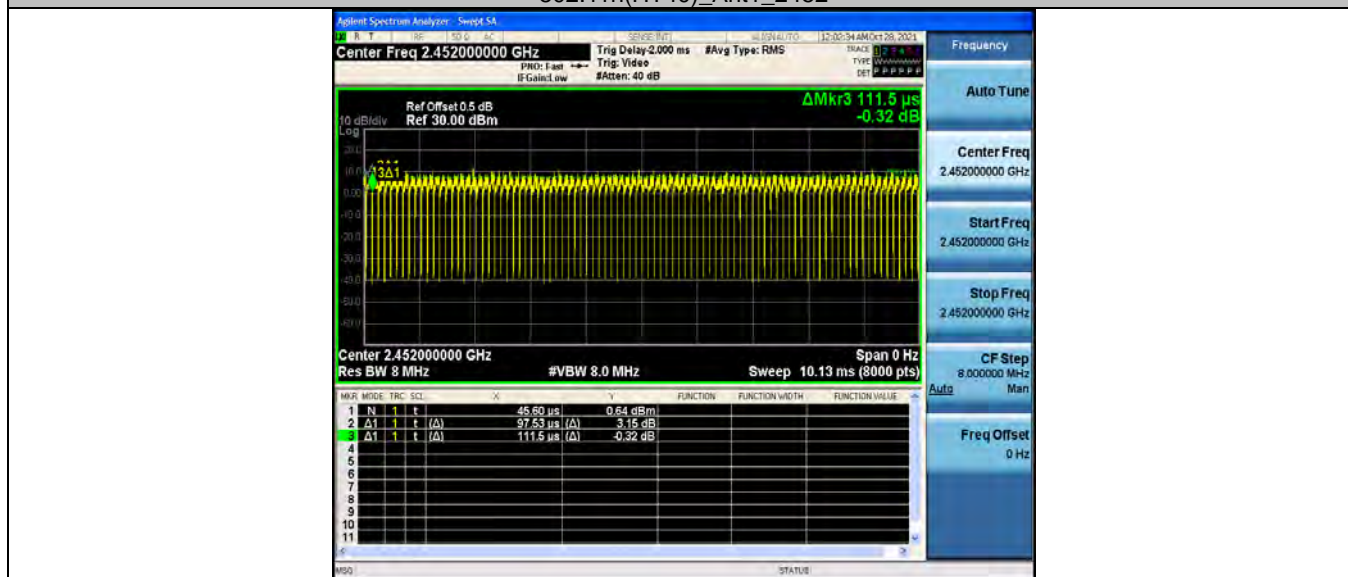

802.11n(HT40)_Ant2_2452

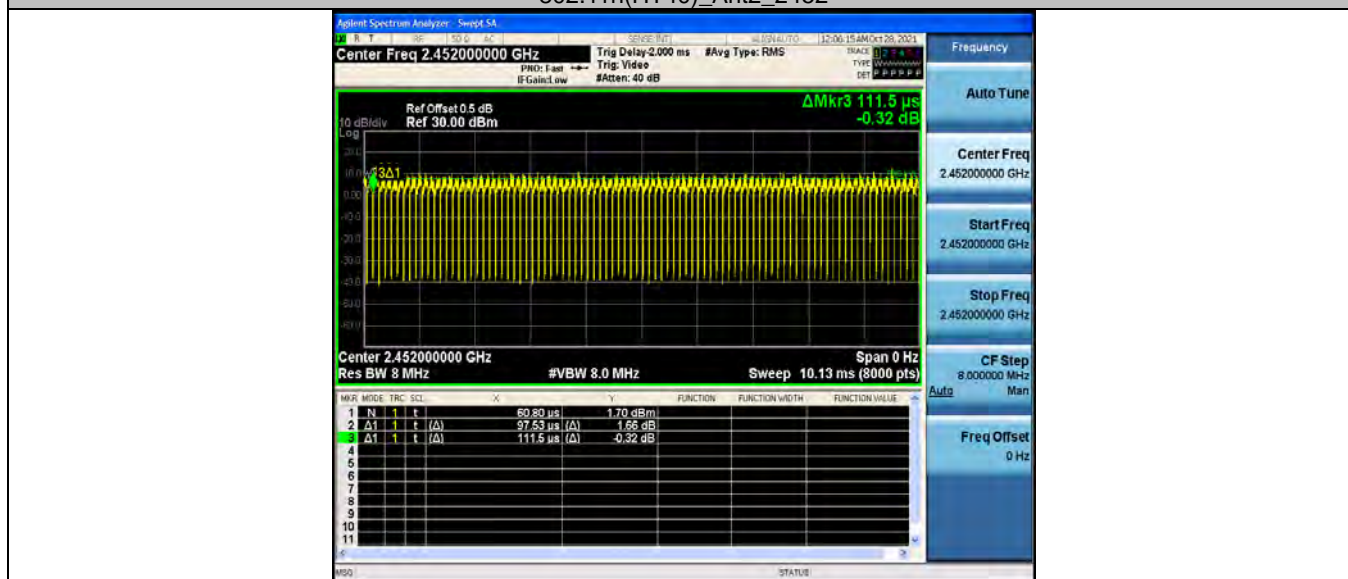



3.9. Antenna requirement

Requirement

FCC CFR Title 47 Part 15 Subpart C Section 15.203:

An intentional radiator shall be designed to ensure that no antenna other than that furnished by the responsible party shall be used with the device. The use of a permanently attached antenna or of antenna that uses a unique coupling to the intentional radiator, the manufacturer may design the unit so that a broken antenna can be replaced by the user, but the use of a standard antenna jack or electrical connector is prohibited.

FCC CFR Title 47 Part 15 Subpart C Section 15.247(c) (1)(i):

(i) Systems operating in the 2400~2483.5 MHz band that is used exclusively for fixed. Point-to-point operations may employ transmitting antennas with directional gain greater than 6dBi provided the maximum conducted output power of the intentional radiator is reduced by 1 dB for every 3 dB that the directional gain of the antenna exceeds 6dBi.

Test Result

The directional gain of the antenna 8.81dBi, please refer to the EUT internal photographs antenna photo.

*****THE END*****