

规格书

SPECIFICATION FOR APPROVAL

客户名称

CUSTOMER NAME: 广联

产品名称

PRODUCT NAME: 2.4/5.85G 外置天线 L=110/268mm

客户料号

CUSTOMER P/N:

仁丰料号

Ren Feng P/N: U00T01S168N04246 REV: A

	MANUFACTURER SIGNATURE	CUSTOMER SIGNATURE
CHECKED BY:	周荣创	
AUDITOR BY:	宋俊	
APPROVED BY:	姚定军	
DATE:	2023-09-21	



东莞市仁丰电子科技有限公司

Dongguan RF Electronic Technology Co., Ltd

公司地址：东莞市塘厦镇清湖头三坑工业区1号 电话：0769-38940168 传真：0769-39010966 网址：<http://rflink.net.cn>

Contents

1、封面 Cover	-----	1
2、履历表 Resume	-----	2
3、目录 Contents	-----	3
4、规格表 Specifications sheets	-----	4
5、成品图 End product chart	-----	5-6
6、测试报告 Testing report	-----	7 -9

二、规格表：

产品主要技术参数

主要技术指标		Main technical specifications	
频率范围 (MHZ)	2400~2500MHZ 5150~5850MHZ	Frequency Range (MHZ)	2400~2500MHZ 5150~5850MHZ
特性阻抗(Ω)	50 \pm 10	Impedance(Ω)	50 \pm 10
增益(dBi)	3.36dbi	Peak Gain(dBi)	3.36dbi
输出电压 驻波比	\leq 1.92	VSWR	\leq 1.92
极化方式	交叉极化	Polarization	Cross
方向性	全向性	Radiation	Omni-directional
连接方式	端子	Connector Type	terminal
物理性能		Physical Properties	
天线外套材料	ABS	Antenna cover	ABS
工作温度		Operating Temp	
保存温度		Storage Temp	

REV	DATE	DESCRIPTION	Change the code
A	2023-09-21	NEW ISSUE	

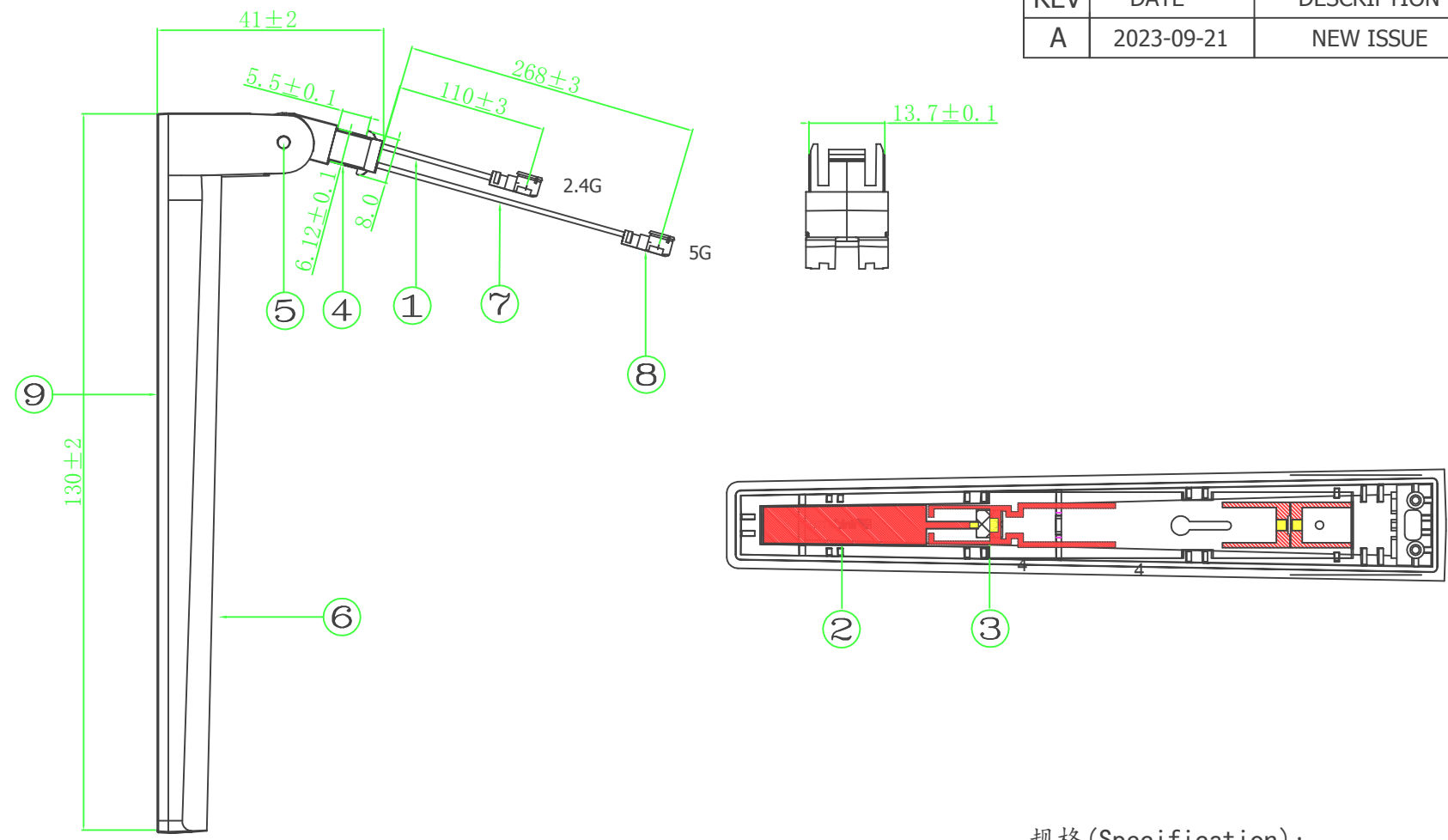

规格 (Specification):
 频率 (Frequency Range): 2.4~2.5GHz/5.15~5.825GHz
 回波损耗 (Return loss): -10dB or less
 驻波比 (VSWR): 1.92max
 增益 (Gain (peak)): 3.36dBi

9	下盖	1	ABS Gray
8	端子	2	Copper
7	线材	1	φ1.37 Black
6	上盖	1	ABS Gray
5	铆钉	2	POM Gray
4	下固	1	PC+ABS Gray
3	泡棉	1	EVA Black
2	PCB	1	FR-4
6	1 线材	1	φ1.37 Gray
NO.	DESCRIPTION	Q'TY	REMARK

尺寸范围 (mm)	公差 (mm)	APPROVED	COSTOMER:					
0<L≤6	±0.10		PART NO :					
6<L≤30	±0.10		CHECKED	PARTNAME : RF Antenna Assembly				
30<L≤90	±0.15			R.F P/NO : U00T01S168N04246				
80<L≤180	±0.20			REV				
180<L≤315	±0.25	DRAWING	UNIT	SCALE	SIZE	SHEET		
315<L≤800	±0.35		A	mm	1:1	A4	10F1	
角度	±0.5°							

RF link
 东莞市仁丰电子科技有限公司
 RenFeng Electronic technology Co., LTD.

带公差尺寸为检验尺寸
 产品符合环保RoHS2.0之要求

1
2
3
4
5
6

A B C D E F G

产品包装

REV	DATE	DESCRIPTION
A	2023-09-21	NEW ISSUE

单个产品

排包装说明:

1. 每大袋装50PPCS产品, 每排袋装入10pcs产品.
2. 每袋需贴相应标签
3. 用珍珠棉袋/橡皮筋固定线材

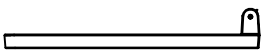

排袋包装

——橡皮筋固定

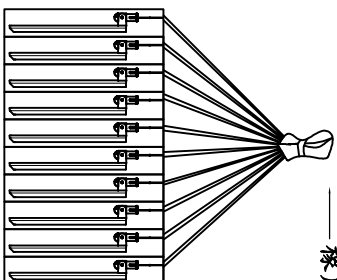

PE袋

橡皮筋固定

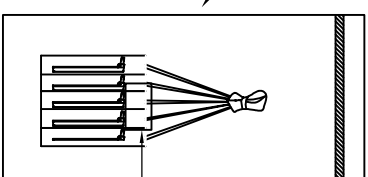

内袋标签

外箱包装



外箱包装说明:

1. 外箱需RoHS标识及1pc外箱标签.
2. 每箱装10袋, 共装500pcs产品.

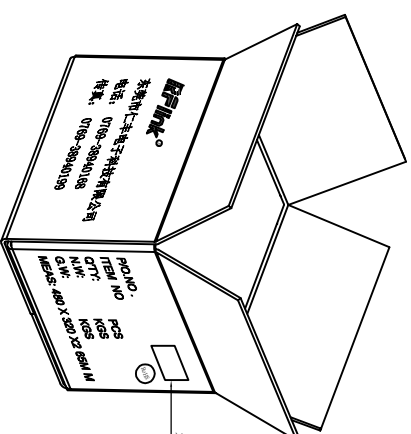

外箱标签

尺寸范围 (mm) 公差 (mm)

APPROVED

CUSTOMER:

0.1 ≤ L ≤ 6 ±0.10

CHECKED

PART NO :

0.1 ≤ L ≤ 30 ±0.10

DRAWING

PARTNAME : 外置天线出线式包装

30.1 ≤ L ≤ 100 ±0.15

REV

R.F P/NO : U00T01S168N04246

100.1 ≤ L ≤ 150 ±0.20

UNIT

SCALE

150.1 ≤ L ≤ 315 ±0.35

SCALE

SIZE

角度 ±0.5°

角度

SHEET

Rlink
 东莞市仁丰电子科技有限公司
 RenFeng Electronic technology
 Co., LTD.

产品符合环保ROHS2.0之要求

6. 测试报告 Testing report

6.6.1 网络分析仪测试报告

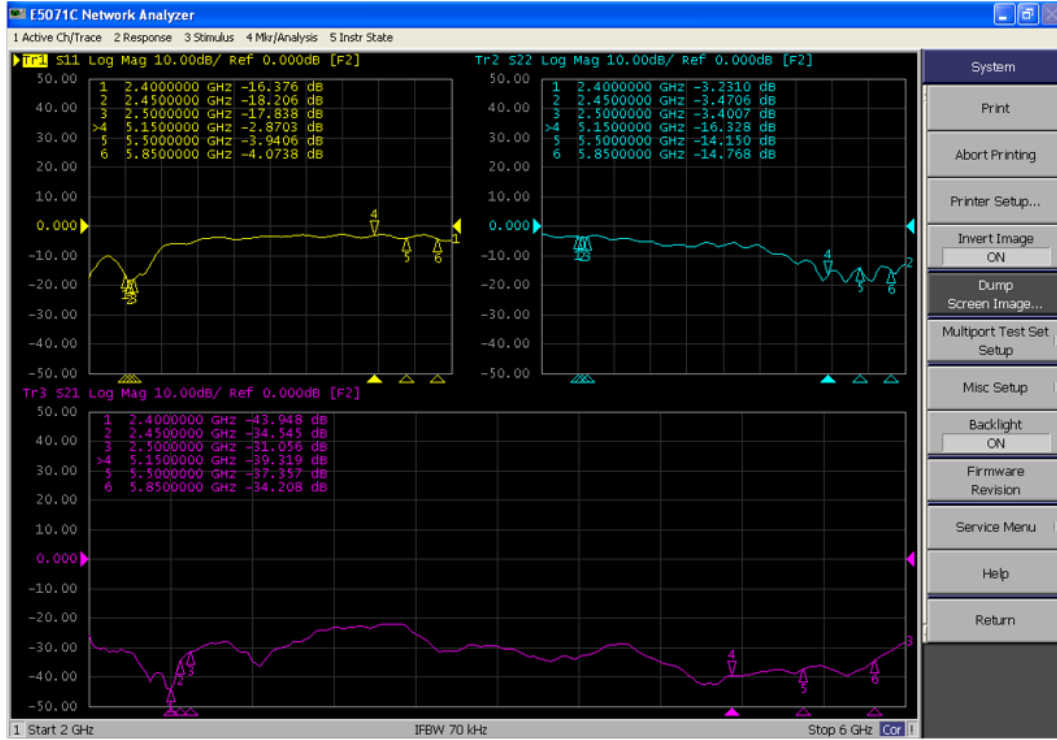

6.2: 暗室 2D、3D Radiation Pattern

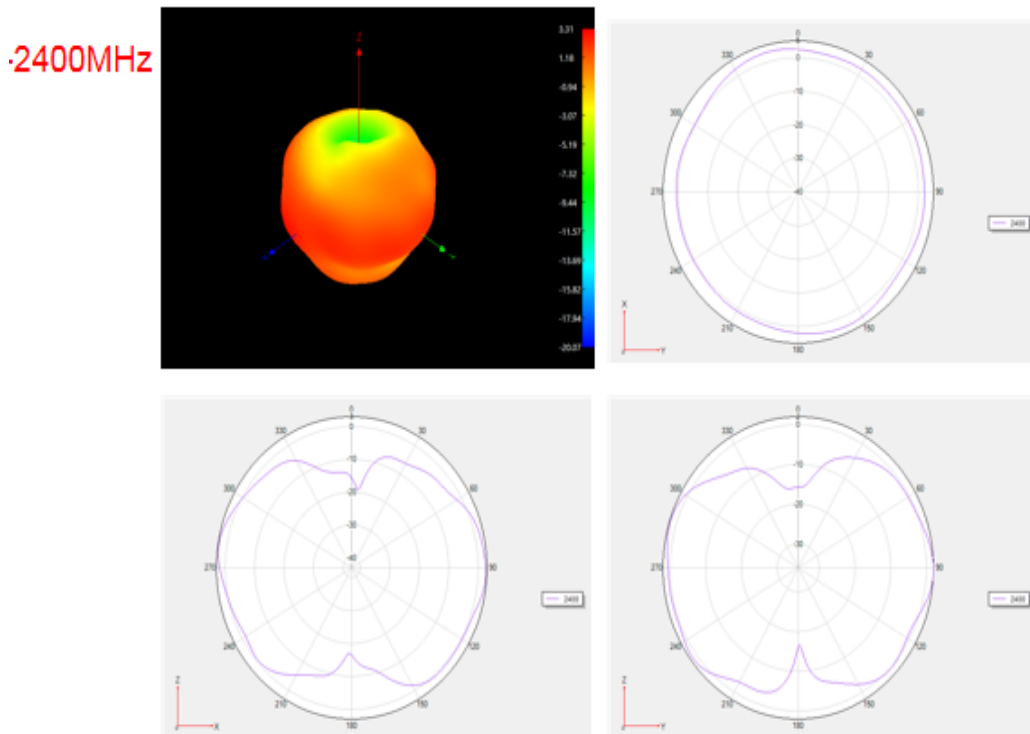

-2450MHz

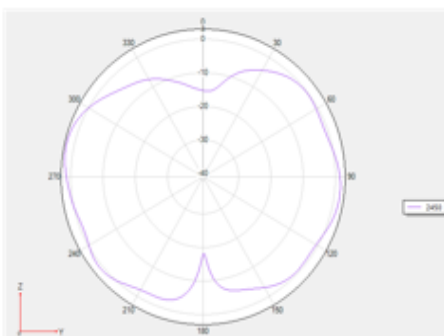
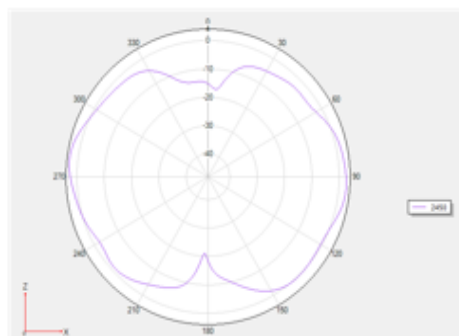
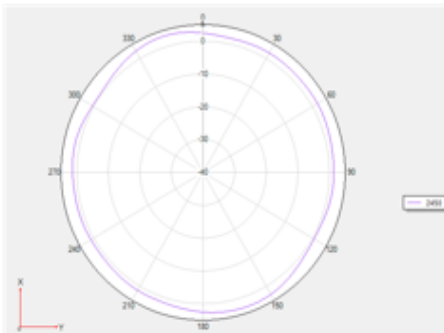
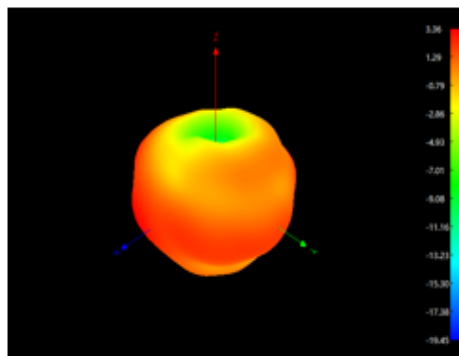

-2500MHz

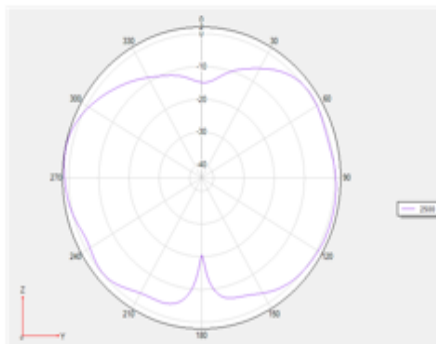
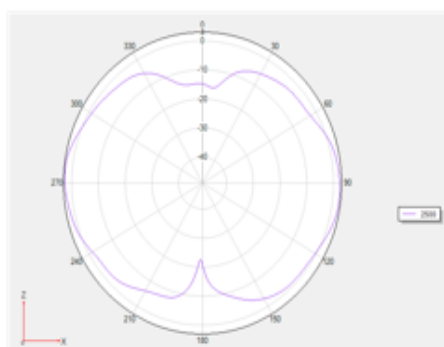
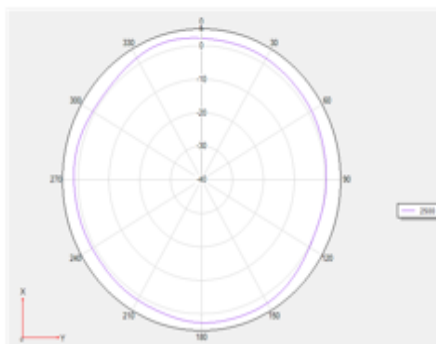
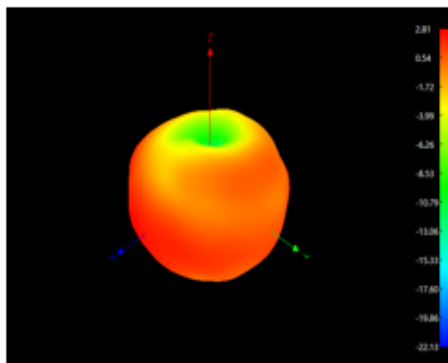

5850MHz

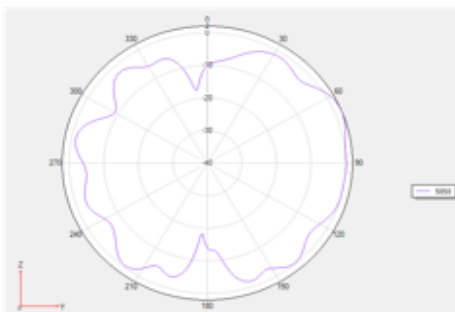
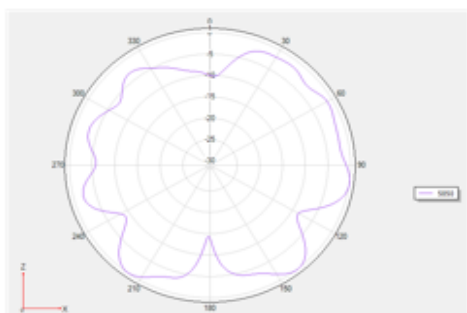
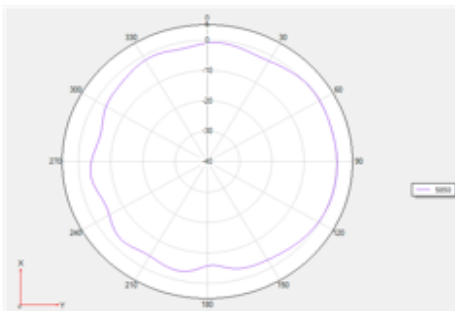
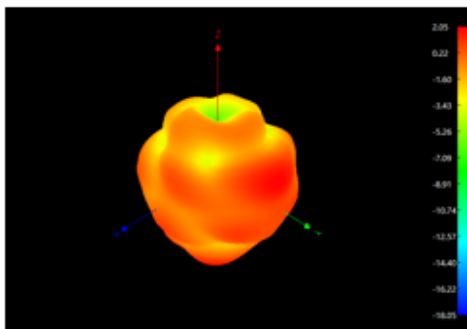

5150MHz

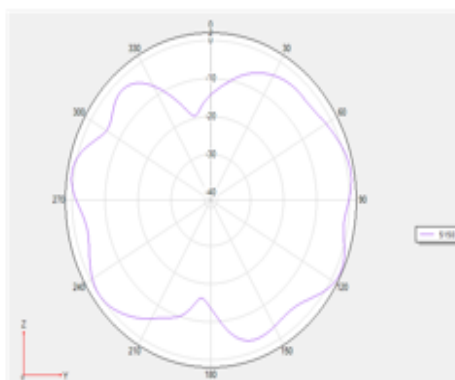
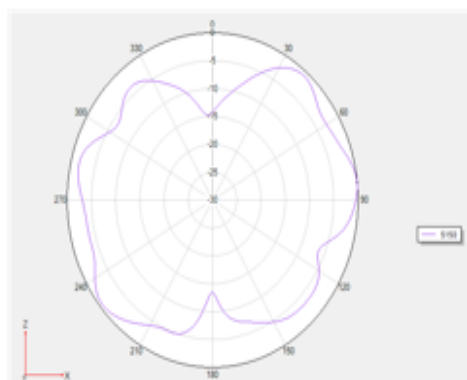
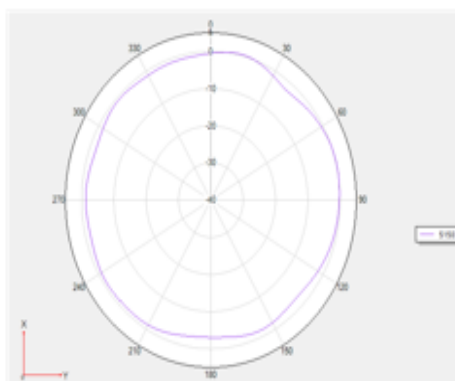
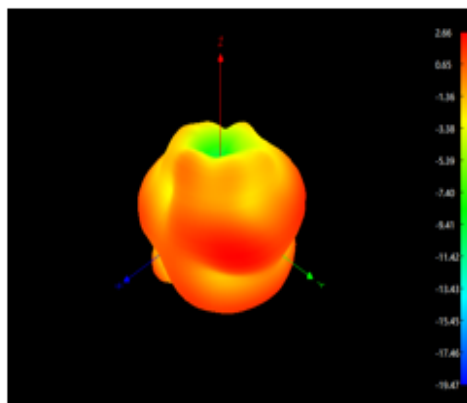

I-5500MHz

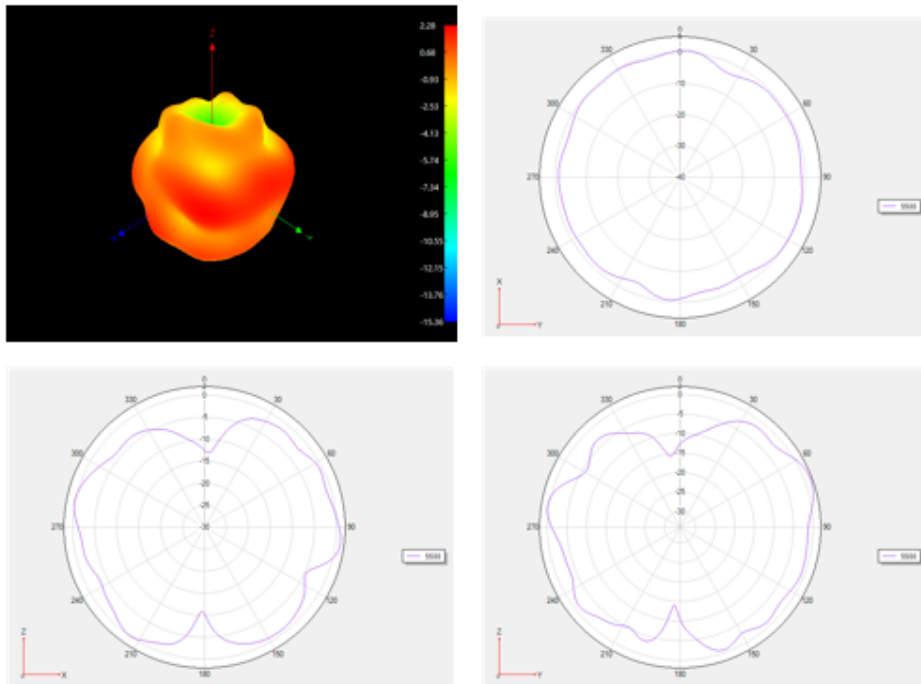

Frequency / MHz	Gain/ dBi	Efficiency / %	Frequency / MHz	Gain/ dBi	Efficiency / %
2400	3.31	69.34	5150	2.66	64.58
2410	3.42	69.5	5200	2.39	64.95
2420	3.27	67.76	5250	2.46	65.05
2430	3.11	65.61	5300	2.73	64.83
2440	3.21	67.92	5350	2.34	64.7
2450	3.36	68.39	5400	2	62.12
2460	3.14	65.97	5450	2.19	63.83
2470	2.93	63.12	5500	2.28	63.46
2480	2.98	64.66	5550	2.33	64.7
2490	2.94	64.09	5600	2.27	63.46
2500	2.81	63.24	5650	2.34	62.24
			5700	2.35	65.21
			5750	2.19	61.17
			5800	2.12	60.7
			5850	2.05	60.47