

# Test Report of FCC CFR 47 Part 15 Subpart E

On Behalf of

**GL Technologies (Hong Kong) Limited**

210D Enterprise Place, Hong Kong Science Park, Sha Tin, NT, Hong Kong

Product Name:	<b>GL-AR300M mini router</b>
Model/Type No.:	<b>GL-AR300MD, GL-AR300M</b>
FCC ID:	<b>2AFIW-AR300M</b>
Prepared By:	<b>Shenzhen Hongcai Testing Technology Co., Ltd.</b> 1st-3rd Floor, Building C, Shuanghuan Xin Yi Dai Hi-Tech Industrial Park, No.8 Baoqing Road, Baolong Industrial Zone, Longgang District, Shenzhen, Guangdong, China Tel: +86-755-86337020 Fax: +86-755-86337028
Report Number:	HCT16FR135E-4
Tested Date:	July 17 ~22, 2016
Issued Date:	July 22, 2016
Tested By:	Haiqing.Zhao/ <i>Haiqing Zhao</i>

Reviewed By:

*Owen Yang*

Approved By:

*Tony Wu*

Owen.Yang

EMC Technical Supervisor

Tony Wu

EMC Technical Manager

## TABLE OF CONTENTS

<b>1. GENERAL INFORMATION.....</b>	<b>3</b>
1.2 TEST STANDARDS .....	5
1.3 TEST FACILITY .....	5
<b>2. SYSTEM TEST CONFIGURATION.....</b>	<b>6</b>
2.1 EUT CONFIGURATION.....	6
2.2 EUT EXERCISE.....	6
2.3 GENERAL TEST PROCEDURES.....	6
2.4 MEASUREMENT UNCERTAINTY .....	6
2.5 LIST OF MEASURING EQUIPMENTS USED.....	7
<b>3. SUMMARY OF TEST RESULTS .....</b>	<b>9</b>
<b>4. DUTY CYCLE.....</b>	<b>10</b>
<b>5. 26 DB EMISSION BANDWIDTH.....</b>	<b>13</b>
<b>6. THE MAXIMUM E.I.R.P &amp; MAXIMUM CONDUCTED OUTPUT POWER.....</b>	<b>22</b>
<b>7. BAND EDGES MEASUREMENT .....</b>	<b>25</b>
<b>8. PEAK POWER SPECTRAL DENSITY.....</b>	<b>47</b>
<b>8.1LIMIT .....</b>	<b>47</b>
<b>9. 6DB BANDWIDTH MEASUREMENT.....</b>	<b>57</b>
<b>10. RADIATED UNDESIRABLE EMISSION .....</b>	<b>66</b>
<b>11. CONDUCTED UNDESIRABLE EMISSION .....</b>	<b>84</b>
<b>12. POWERLINE CONDUCTED EMISSIONS.....</b>	<b>92</b>
<b>13. FREQUENCY STABILITY.....</b>	<b>96</b>

# 1. GENERAL INFORMATION

## 1.1 Product Description for Equipment Under Test (EUT)

### Client Information

Applicant:	GL Technologies (Hong Kong) Limited.
Address of Applicant:	210D Enterprise Place, Hong Kong Science Park, Sha Tin, NT, Hong Kong.
Manufacturer:	GL Technologies (Hong Kong) Limited.
Address of Manufacturer:	210D Enterprise Place, Hong Kong Science Park, Sha Tin, NT, Hong Kong.

### General Description of E.U.T

Items	Description
EUT Description:	GL-AR300M mini router
Model No.:	GL-AR300MD
Supplementary Model:	GL-AR300M
Operation Frequency:	For 802.11a/nHT20/acHT20: 5745~5825MHz For 802.11nHT40/acHT40: 5755~5795MHz
Channel numbers:	5 for 802.11a, 802.11n (HT20), 802.11ac (VHT20) 2 for 802.11n (HT40), 802.11ac (VHT40)
Channel separation:	802.11a/802.11n20/802.11ac20:20MHz, 802.11n40/802.11ac40 :40MHz
Modulation Type	64QAM, 16QAM, QPSK, BPSK for OFDM 256QAM for OFDM in 11ac mode
Data speed:	maximum of 750Mbps
Antenna Type:	Internal antenna
Antenna Gain:	3 dBi
Power Supply:	DC: 5V/1A micro USB

Remark: \* The test data gathered are from the production sample provided by the manufacturer.  
\* Supplementary models have the same base board circuit, the appearance is different.

**Operation Frequency:**

UNLICENSED NATIONAL INFORMATION INFRASTRUCTURE (U-NII)	
CHANNEL	MHz
149	5745
151	5755
157	5785
159	5795
165	5825

*Remark: The sample selected for test was engineering sample that approximated to production product and was provided by manufacturer.*

**802.11a/802.11n20/802.11ac20**

Channel	Frequency
The lowest channel	5745MHz
The middle channel	5785MHz
The Highest channel	5825MHz

**802.11n40/802.11ac40**

Channel	Frequency
The lowest channel	5755MHz
The Highest channel	5795MHz

## 1.2 Test Standards

The tests were performed based on the Electromagnetic Interference (EMI) tests performed on the EUT. Both conducted and radiated testing were performed according to the procedures in ANSI C63.4 - 2009 and Industry Canada RSS-210 Issue 8. Radiated testing was performed at an antenna to EUT distance 3 meters.

The tests were performed in order to determine compliance with FCC Part 15, Subpart E, and section 15.203, 15.207, 15.209 and 15.407 rules and the FCC publication KDB789033, KDB662911, KDB558074 of Guidance on Measurements for Digital Transmission Systems (47 CFR 15.407) .

## 1.3 Test Facility

The test facility is recognized, certified, or accredited by the following organizations:

### **FCC – Registration No.: 970318**

Shenzhen CTL Testing Technology Co., Ltd. EMC Laboratory has been registered and fully described in a report filed with the (FCC) Federal Communications Commission. The acceptance letter from the FCC is maintained in our files. Registration 970318, December, 2013.

### **IC Registration No.: 9618B**

The 3m alternate test site of Shenzhen CTL Testing Technology Co., Ltd. EMC Laboratory has been registered by Certification and Engineer Bureau of Industry Canada for the performance of with Registration No.: 9618B on November 13, 2013.

## 2. SYSTEM TEST CONFIGURATION

### 2.1 EUT Configuration

The EUT configuration for testing is installed on RF field strength measurement to meet the Commissions requirement and operating in a manner that intends to maximize its emission characteristics in a continuous normal application.

### 2.2 EUT Exercise

The calibrated antennas used to sample the radiated field strength are mounted on a non-conductive, motorized antenna mast 3 or 10 meters from the leading edge of the turntable.

Support equipments or special accessories in test configuration :

AUX Description:	Manufacturer	Model No.	Certificate	CABLE
Host Computer	Dell	78MD82X	CE, FCC	1.5m Unshielded Power Cord
Monitor	Dell	E178Pc	CE, FCC	1.5m Unshielded Power Cord 1.8m shielded data Cable with core
Keyboard	Dell	L100	CE, FCC	1.8m shielded data Cable with core
Mouse	Dell	OCJ339	CE, FCC	1.8m shielded data Cable with core

### 2.3 General Test Procedures

**Conducted Emissions:** The EUT is placed on the turntable, which is 0.8 m above ground plane. According to the requirements in Section 7.1 of ANSI C63.4-2009 and Clause 4 of RSS-GEN Issue 2. Conducted emissions from the EUT measured in the frequency range between 0.15 MHz and 30MHz using CISPR Quasi-Peak detector mode.

**Radiated Emissions:** The EUT is placed on as turntable, which is 0.8 m above ground plane. The turntable shall rotate 360 degrees to determine the position of maximum emission level. EUT is set 3m away from the receiving antenna, which varied from 1m to 4m to find out the highest emission. And also, each emission was to be maximized by changing the polarization of receiving antenna both horizontal and vertical. In order to find out the maximum emissions, exploratory radiated emission measurements were made according to the requirements in Section 13.1.4.1 of ANSI C63.4-2009 and Clause 4 of RSS-GEN Issue 2.

### 2.4 Measurement Uncertainty

Where relevant, the following measurement uncertainty levels have been estimated for tests performed on the apparatus:

Parameter	Uncertainty
Power Line Conducted Emission	+/- 2.3 dB
Radiated Emission	+/- 3.4 dB

Uncertainty figures are valid to a confidence level of 95%.

## 2.5 List of Measuring Equipments Used

Test equipments list of Shenzhen Bontek Compliance Testing Laboratory Co., Ltd.

No.	Instrument no.	Equipment	Manufacturer	Model No.	S/N	Last Calculator	Due Calculator
1	BCT-EMC001	EMI Test Receiver	R&S	ESCI	100687	2016-6-25	2017-7-24
2	BCT-EMC002	EMI Test Receiver	R&S	ESPI	100097	2015-11-1	2016-10-31
3	BCT-EMC003	Amplifier	HP	8447D	1937A02492	2016-6-25	2017-7-24
4	BCT-EMC004	Single Power Conductor Module	R&S	NNBM 8124	242	2016-6-25	2017-7-24
5	BCT-EMC005	Single Power Conductor Module	R&S	NNBM 8124	243	2015-11-1	2016-10-31
6	BCT-EMC006	Power Clamp	SCHWARZBECK	MDS-21	3812	2016-6-25	2017-7-24
7	BCT-EMC007	Positioning Controller	C&C	CC-C-1F	MF7802113	2016-6-25	2017-7-24
8	BCT-EMC008	Electrostatic Discharge Simulator	TESEQ	NSG437	125	2016-6-25	2017-7-24
9	BCT-EMC009	Fast Transient Burst Generator	SCHAFFNER	MODULA6150	34572	2015-11-1	2016-10-31
10	BCT-EMC010	Fast Transient Noise Simulator	Noiseken	FNS-105AX	10501	2016-6-25	2017-7-24
11	BCT-EMC011	Color TV Pattern Generator	PHILIPS	PM5418	TM209947	2016-6-25	2017-7-24
12	BCT-EMC012	Power Frequency Magnetic Field Generator	EVERFINE	EMS61000-8K	608002	2016-6-25	2017-7-24
14	BCT-EMC014	Capacitive Coupling Clamp	TESEQ	CDN8014	25096	2015-11-1	2016-10-31
15	BCT-EMC015	High Field Biconical Antenna	ELECTRO-METRICS	EM-6913	166	2015-11-1	2016-10-31
16	BCT-EMC016	Log Periodic Antenna	ELECTRO-METRICS	EM-6950	811	2015-10-10	2016-10-9
17	BCT-EMC017	Remote Active Vertical Antenna	ELECTRO-METRICS	EM-6892	304	2016-6-25	2017-7-24
18	BCT-EMC018	TRILOG Broadband Test-Antenna	SCHWARZBECK	VULB9163	9163-324	2015-11-1	2016-10-31
19	BCT-EMC019	Horn Antenna	SCHWARZBECK	BBHA9120A	0499	2016-6-25	2017-7-24
20	BCT-EMC020	Teo Line Single Phase Module	SCHWARZBECK	NSLK8128	8128247	2016-6-25	2017-7-24
21	BCT-EMC021	Triple-Loop Antenna	EVERFINE	LLA-2	711002	2015-11-1	2016-10-31
22	BCT-EMC022	Electric bridge	Jhai	JK2812C	803024	2016-6-25	2017-7-24
23	BCT-EMC026	RF POWER AMPLIFIER	FRANKONIA	FLL-75	1020A1109	2016-6-25	2017-7-24
24	BCT-EMC027	CDN	FRANKONIA	CDN M2+M3	A3027019	2016-6-25	2017-7-24
25	BCT-EMC029	6DB Attenuator	FRANKONIA	N/A	1001698	2015-11-1	2016-10-31
26	BCT-EMC030	EM Injection clamp	FCC	F-2031-23mm	091536	2016-6-25	2017-7-24
27	BCT-EMC031	9kHz-2.4GHz signal	MARCONI	10S/6625-99	112260/042	2016-6-25	2017-7-24

		generator 2024		457-8730			
28	BCT-EMC032	10dB attenuator	ELECTRO-METRICS	EM-7600	836	2016-6-25	2017-7-24
29	BCT-EMC033	ISN	TESEQ	ISN-T800	30301	2015-11-1	2016-10-31
30	BCT-EMC034	10KV surge generator	SANKI	SKS-0510M	048110003E 321	2015-11-1	2016-10-31
31	BCT-EMC035	HRMONICS&FLICKRE ANALYSER	VOLTECH	PM6000	200006700433	2015-10-10	2016-10-9
32	BCT-EMC036	Spectrum Analyzer	R&S	FSP	100397	2016-6-25	2017-7-24
33	BCT-EMC037	Broadband preamplifier	SCH WARZBECK	BBV9718	9718-182	2015-11-1	2016-10-31
34	BCT-EMC038	Power Sensor	Anymetre	TH101B	TR3-01	2016-6-25	2017-7-24





### 3. SUMMARY OF TEST RESULTS

FCC Rules	Description of Test	Test Limit	Result
N/A	Duty Cycle	>99%	Pass
FCC §15.407(a)	26dB Bandwidth	N/A	Pass
FCC §15.407(e)	6dB Bandwidth	≥ 500kHz	Pass
FCC §15.407(a)	Maximum Conducted Output Power	< 30 dBm	Pass
FCC §15.407(a)	Power Spectral Density	< 17 dBm/MHz < 30 dBm/MHz	Pass
FCC §15.407(b)	Band Edges Measurement	< -27dBm/MHz EIRP < -17dBm/MHz EIRP	Pass
FCC §15.407(g)	Frequency Stability	N/A	Pass
FCC §15.209(a)	Radiated Undesirable Emission	Emissions in restricted bands must meet the radiated limits detailed in 15.209	Pass
FCC §15.407(b)	Conducted Undesirable Emission	< -27dBm/MHz	Pass
FCC §15.207(a)	AC Conducted Emissions 150kHz – 30MHz	< FCC 15.207 limits	Pass

HONGCAI TESTING

## 4. DUTY CYCLE

A mode duty cycle

Duty cycle > 99%

5745MHz

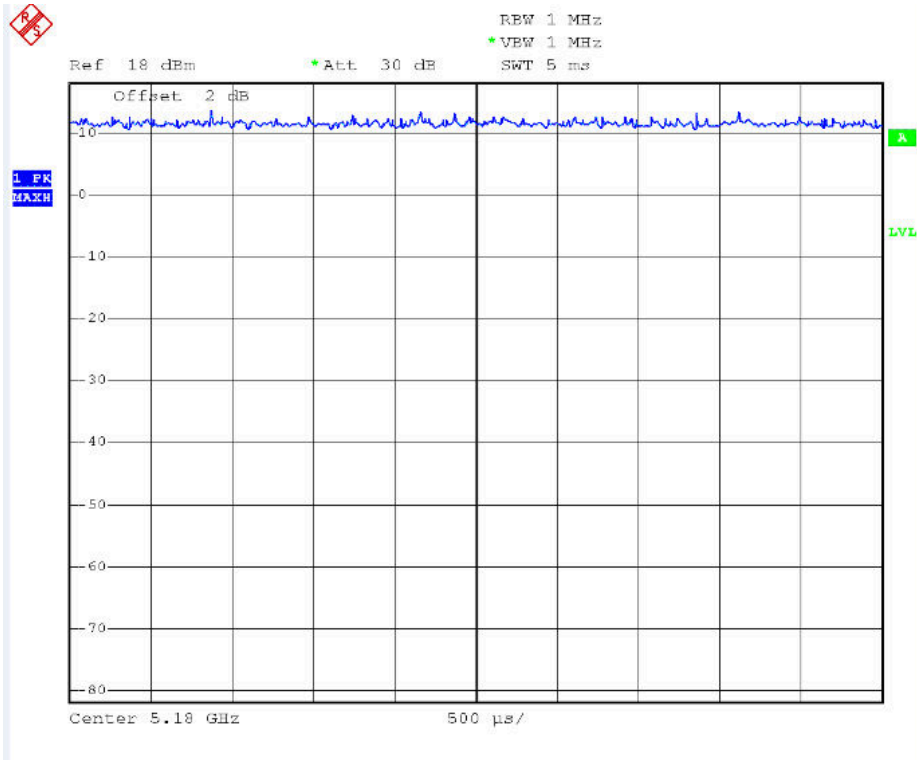

N HT20 mode duty cycle

Duty cycle > 99%

5745MHz

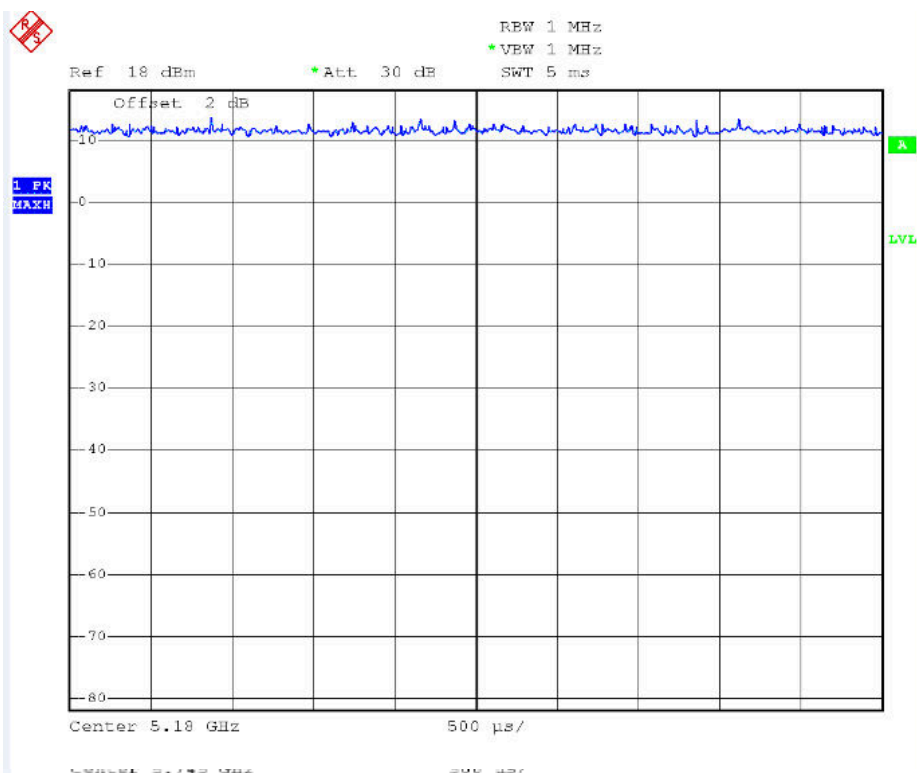

N HT40 mode duty cycle

Duty cycle > 99%

5755MHz

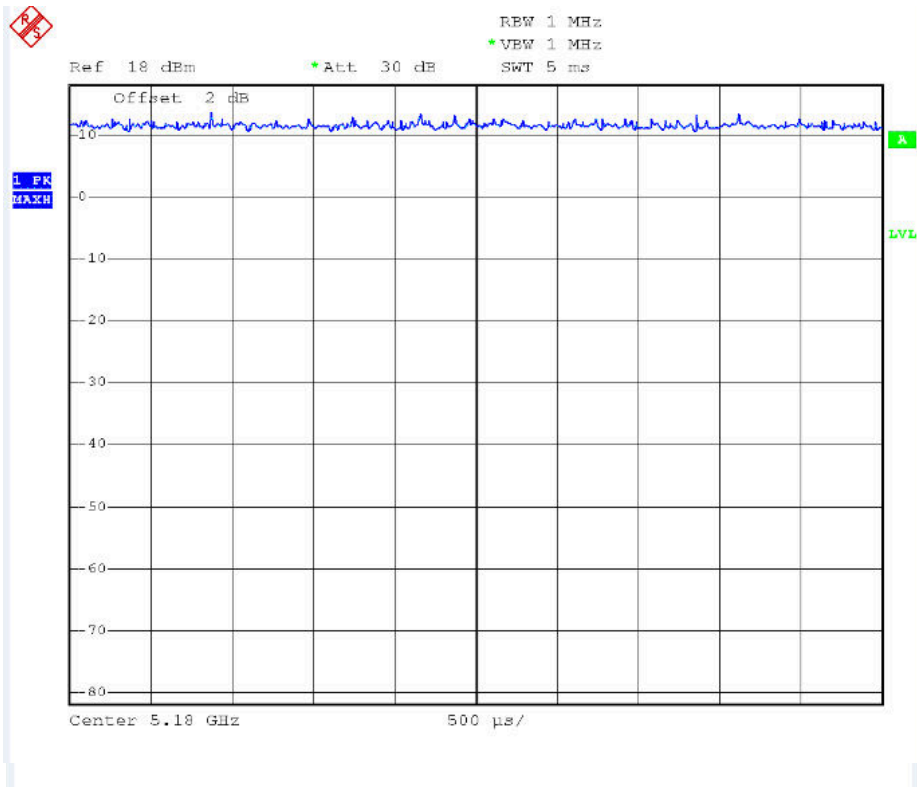

Ac HT20 mode duty cycle

Duty cycle > 99%

5755MHz

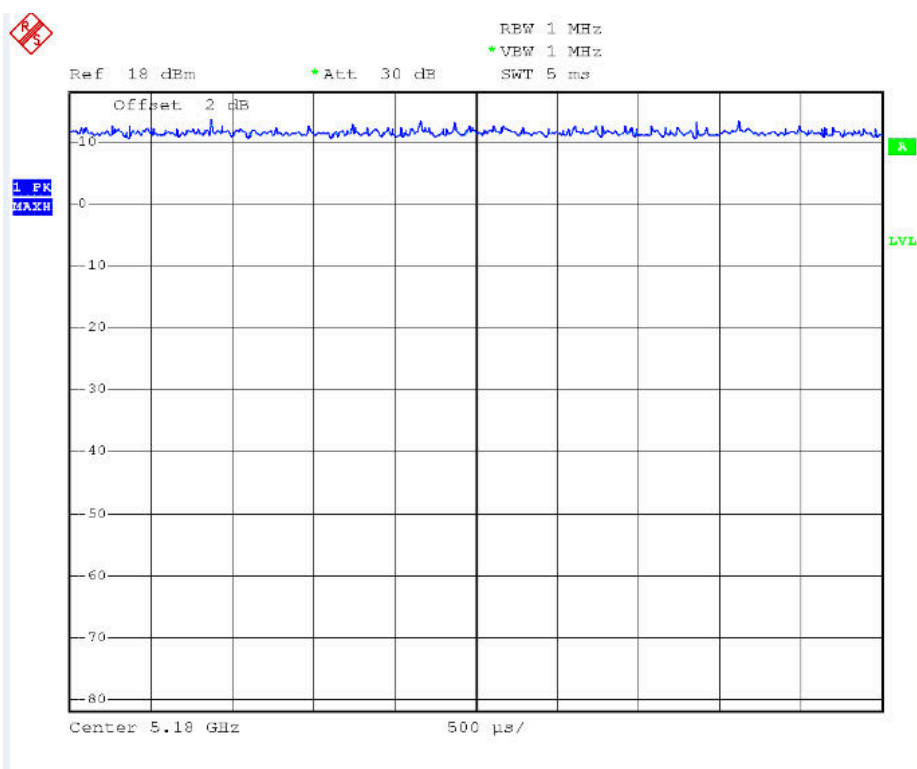

Ac HT40 mode duty cycle

Duty cycle > 99%

5755MHz

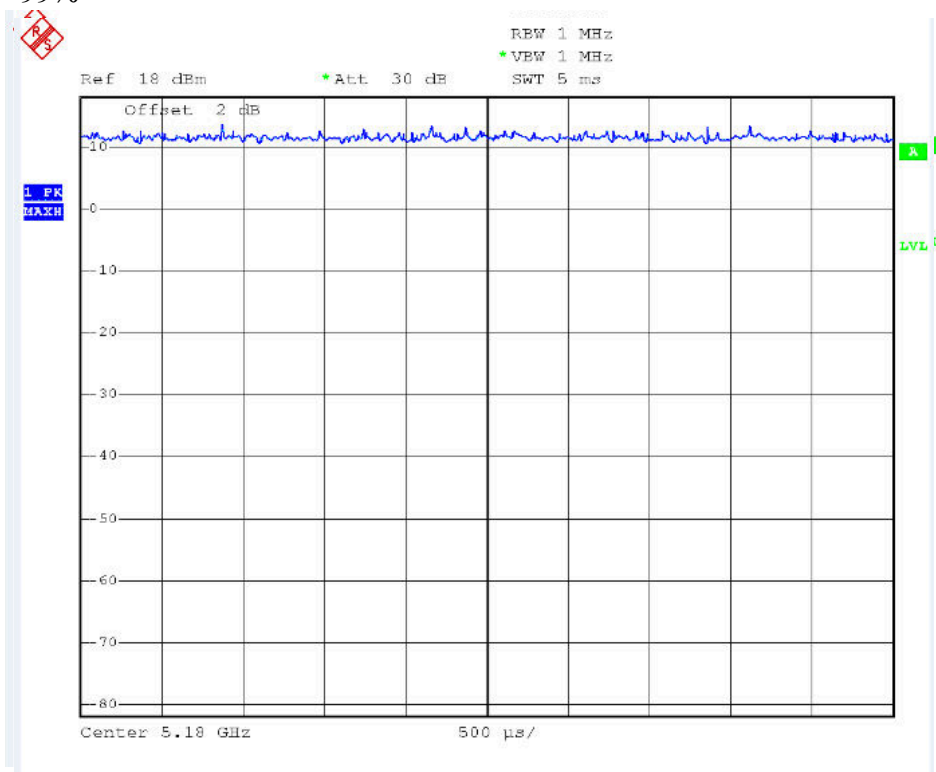

## 5. 26 dB EMISSION BANDWIDTH

### LIMIT

According to §15.303(c), for purposes of this subpart the emission bandwidth shall be determined by measuring the width of the signal between two points, one below the carrier center frequency and one above the carrier center frequency, that are 26 dB down relative to the maximum level of the modulated carrier. Compliance with the emissions limits is based on the use of measurement instrumentation employing a peak detector function with an instrument resolutions bandwidth approximately equal to 1.0 percent of the emission bandwidth of the device under measurement.

### Test Procedure used

KDB 789033 D02v01 – Section C.1

### Test Configuration

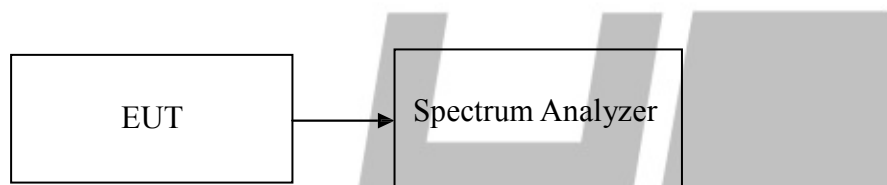

### TEST PROCEDURE

1. The analyzers' automatic bandwidth measurement capability was used to perform the 26dB bandwidth measurement. The "X" dB bandwidth parameter was set to  $X = 26$ . The automatic bandwidth measurement function also has the capability of simultaneously measuring the 99% occupied bandwidth. The bandwidth measurement was not influenced by any intermediated power nulls in the fundamental emission.
2. RBW = approximately 1% of the emission bandwidth.
3. VBW  $\geq 3 \times$  RBW.
4. Detector = Peak.
5. Trace mode = max hold.

### TEST RESULTS

*No non-compliance noted*

**Test Data**

**Test mode: IEEE 802.11a mode / 5745 ~ 5825MHz**

Channel	Frequency (MHz)	Bandwidth (MHz)	99%Bandwidth (MHz)
Low	5745	23.36	17.20
Mid	5785	24.88	17.36
High	5825	26.56	17.44

**Test mode: IEEE 802.11n HT 20 MHz Channel mode / 5745 ~ 5825MHz**

Channel	Frequency (MHz)	Bandwidth (B) (MHz)	99%Bandwidth (MHz)
Low	5745	26.08	18.32
Mid	5785	24.72	18.24
High	5825	26.64	18.40

**Test mode: IEEE 802.11n HT 40 MHz Channel mode / 5755 ~ 5825MHz**

Channel	Frequency (MHz)	Bandwidth (B) (MHz)	99%Bandwidth (MHz)
Low	5755	59.76	36.64
High	5795	49.68	36.64

**Test mode: IEEE 802.11ac HT 20 MHz Channel mode / 5745 ~ 5825MHz**

Channel	Frequency (MHz)	Bandwidth (B) (MHz)	99%Bandwidth (MHz)
Low	5745	26.48	18.32
Mid	5785	24.56	18.16
High	5825	24.96	18.32

Test mode: IEEE 802.11ac HT 40 MHz Channel mode / 5755 ~ 5825MHz

Channel	Frequency (MHz)	Bandwidth (B) (MHz)	99%Bandwidth (MHz)
Low	5755	57.84	3644
High	5795	50.00	36.64

Test Plot

IEEE 802.11a  
CH Low

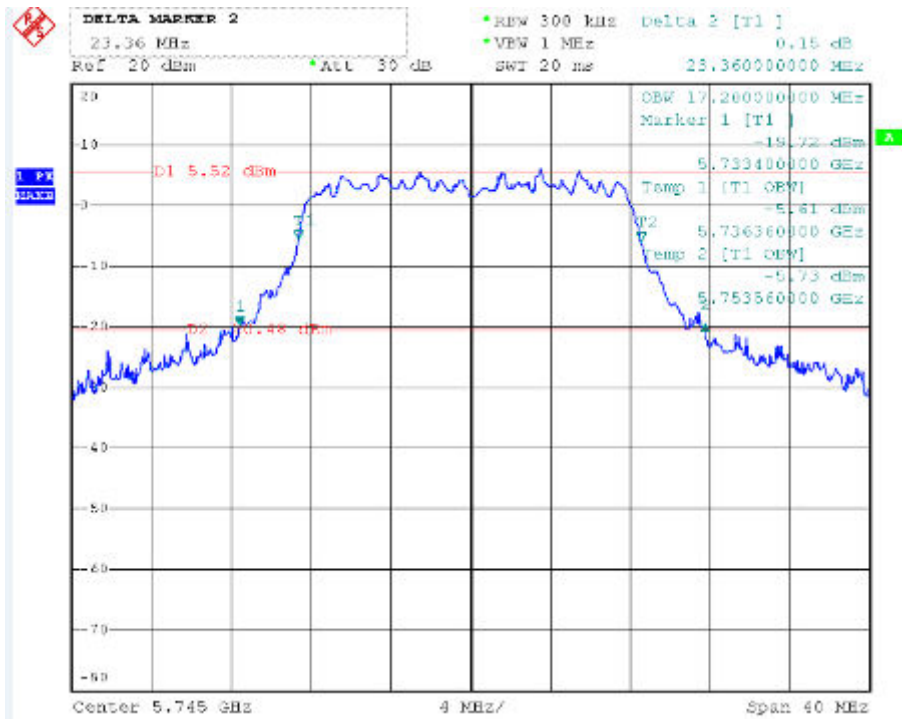

### CH Mid

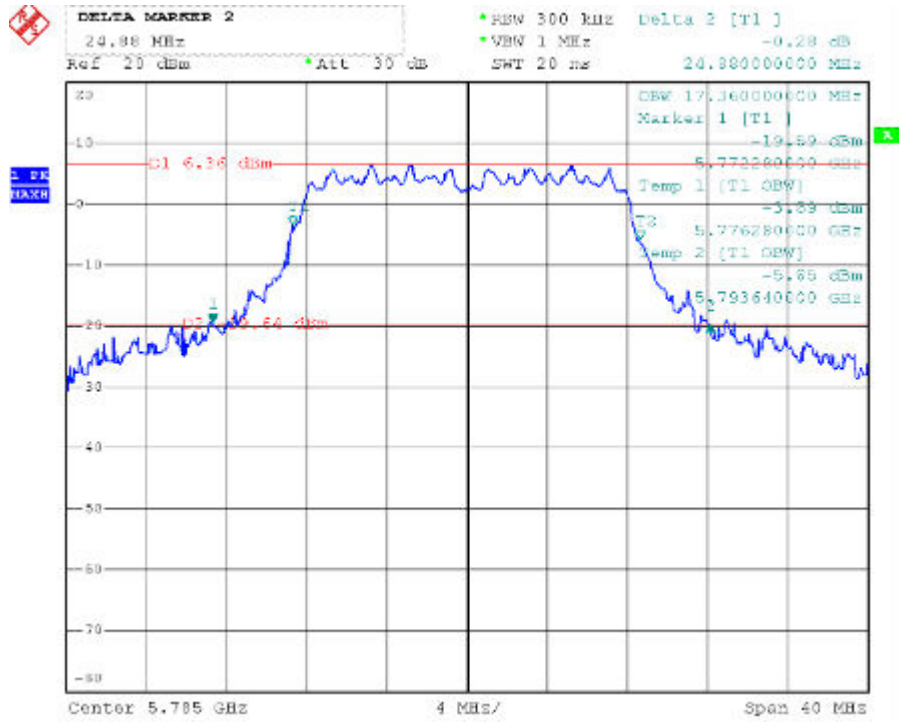

### CH High

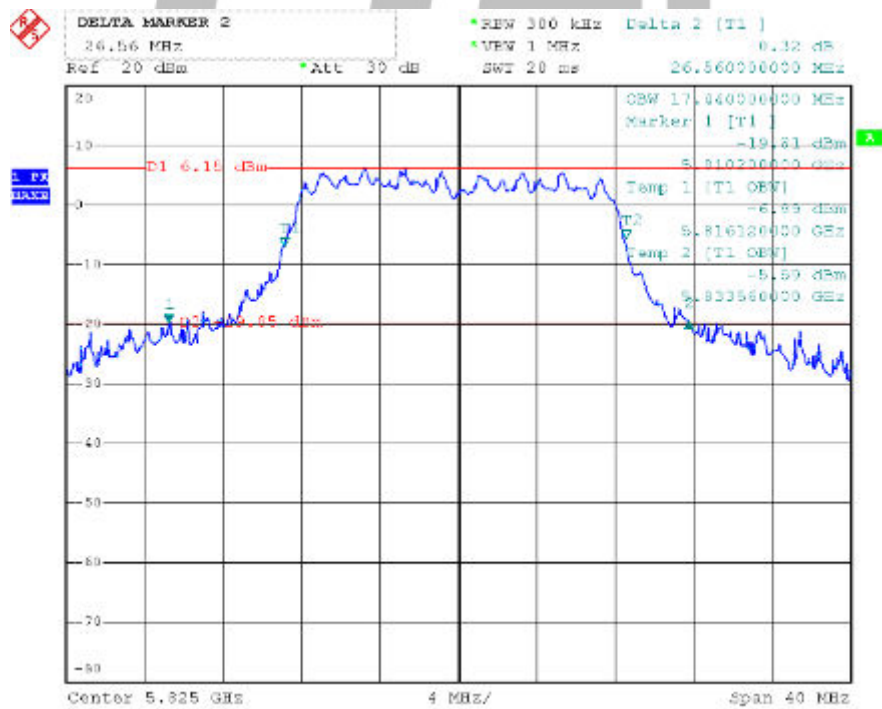



# IEEE 802.11n HT 20

## CH Low

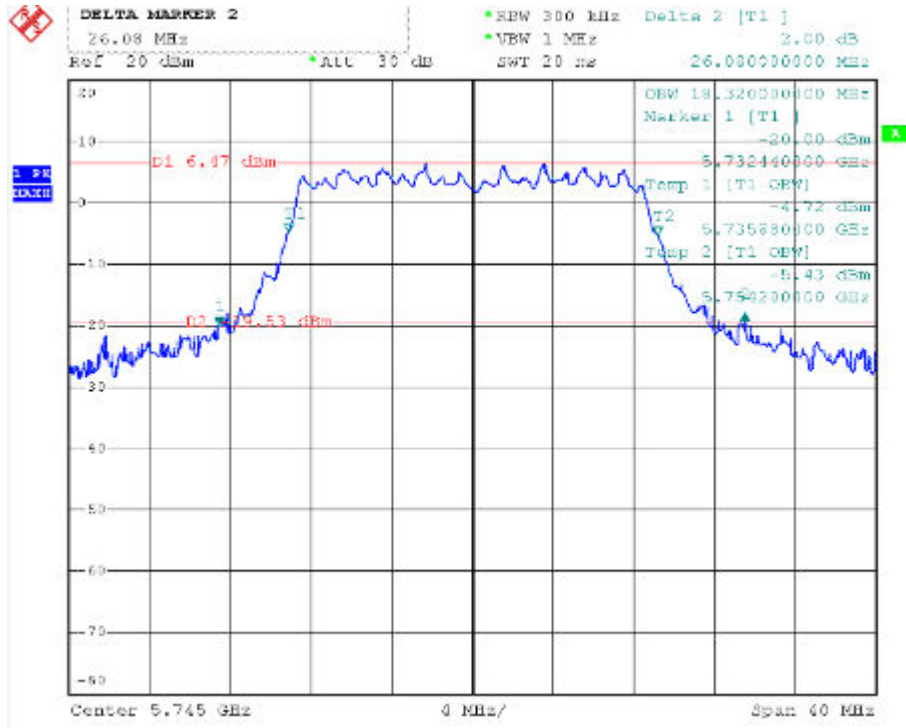

## CH Mid

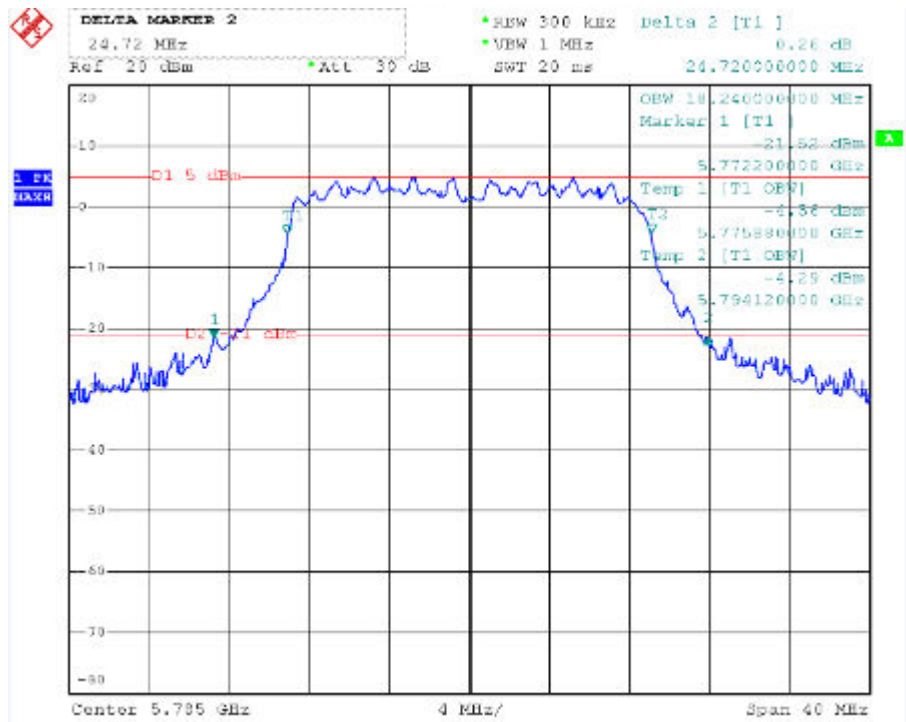

### CH High

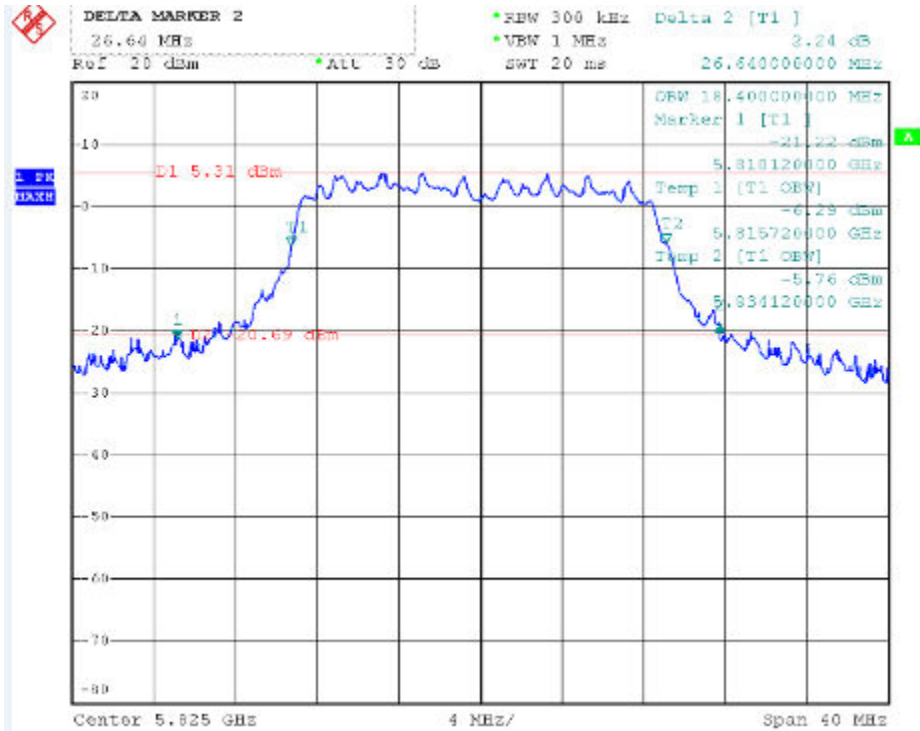

### IEEE 802.11n HT 40

### CH Low

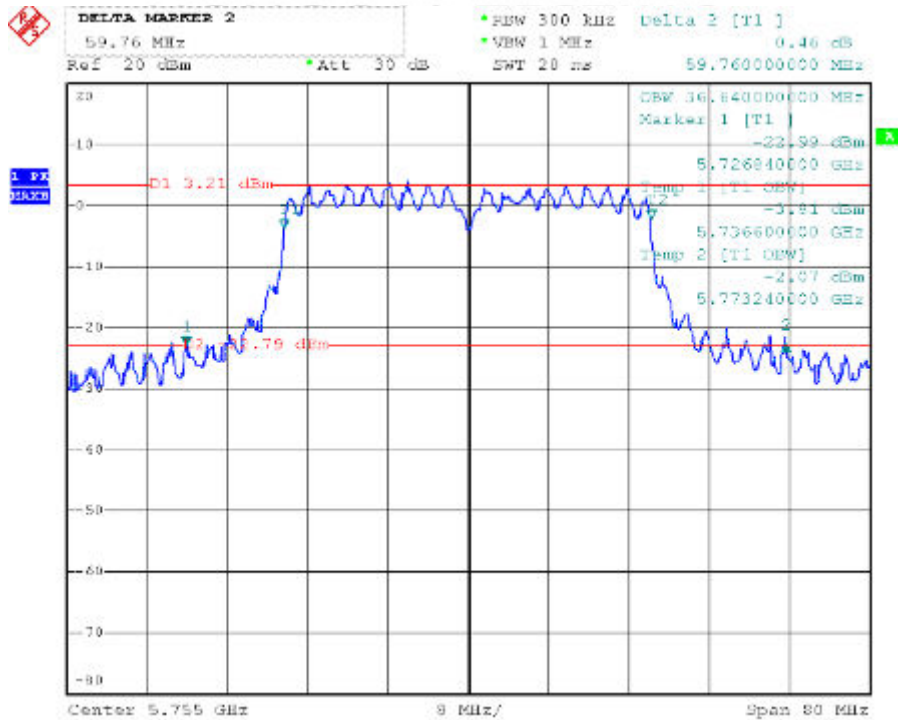

### CH High

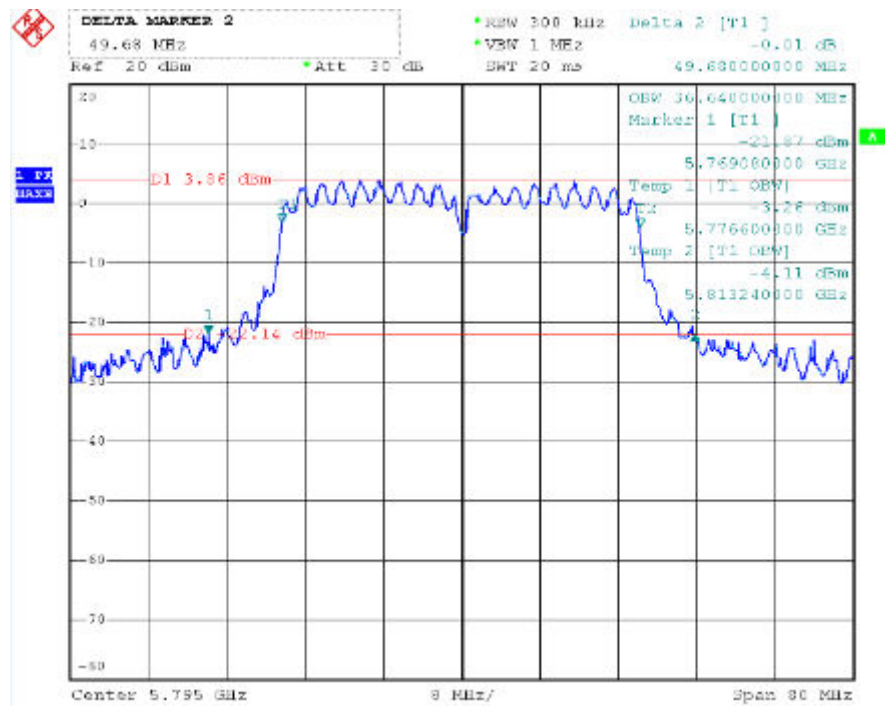

### IEEE 802.11ac HT 20

### CH Low

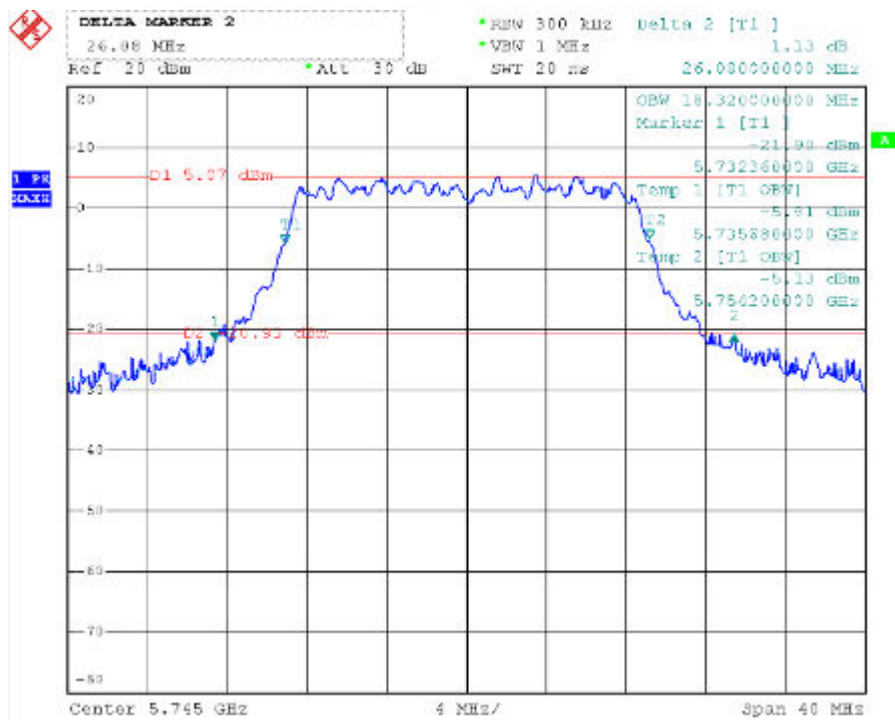

### CH Mid

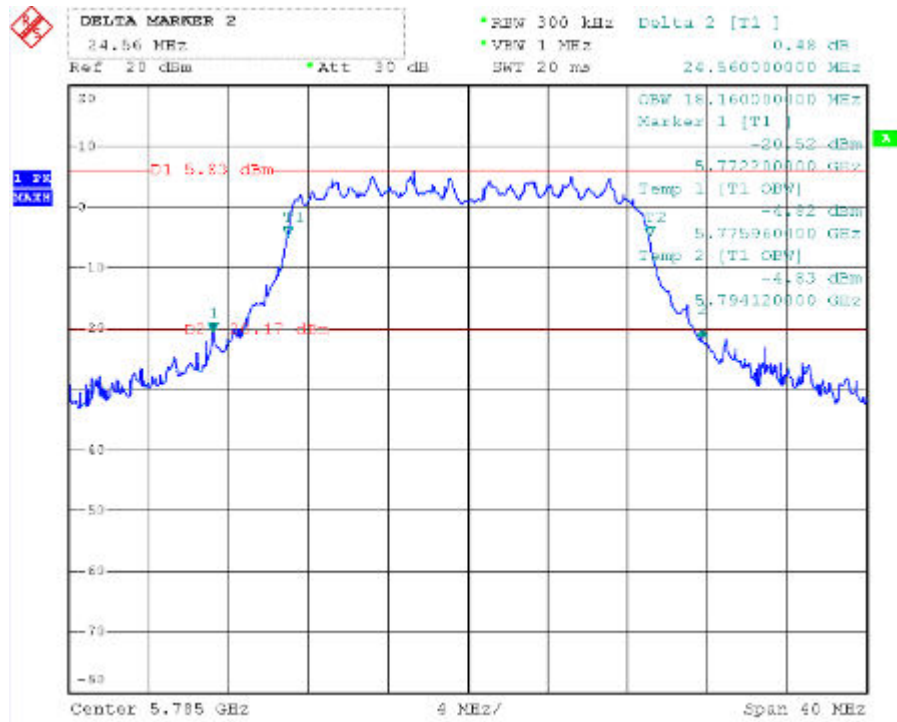

### CH High

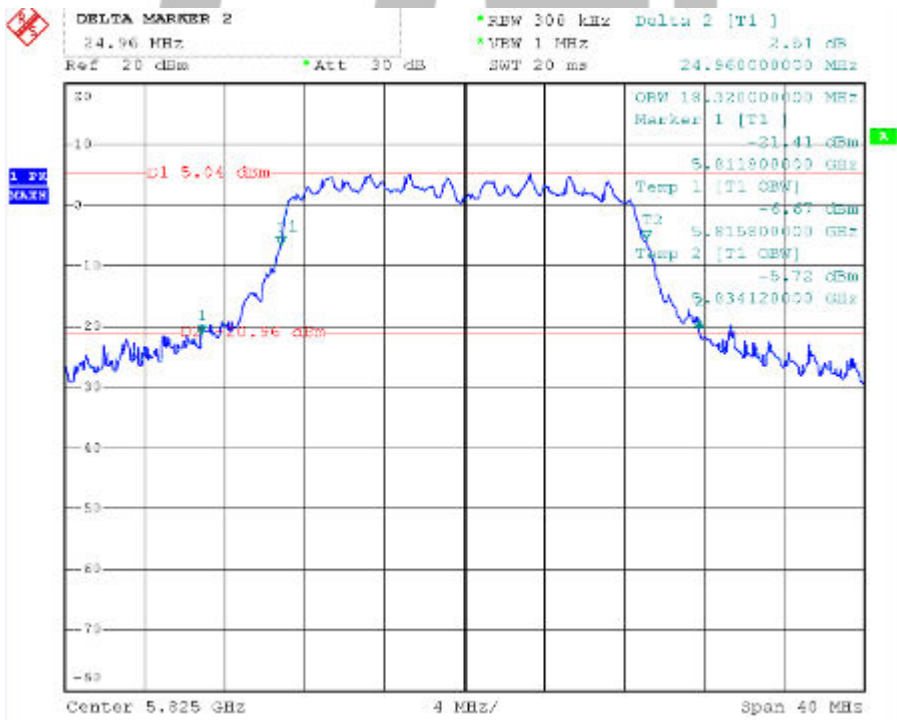

# IEEE 802.11ac HT 40

## CH Low

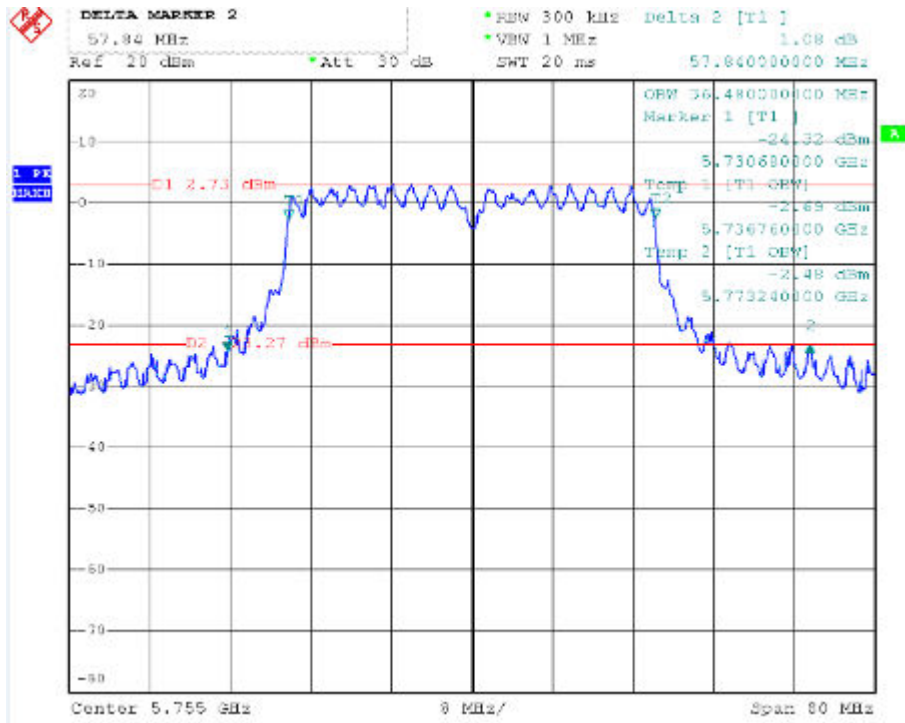

## CH High

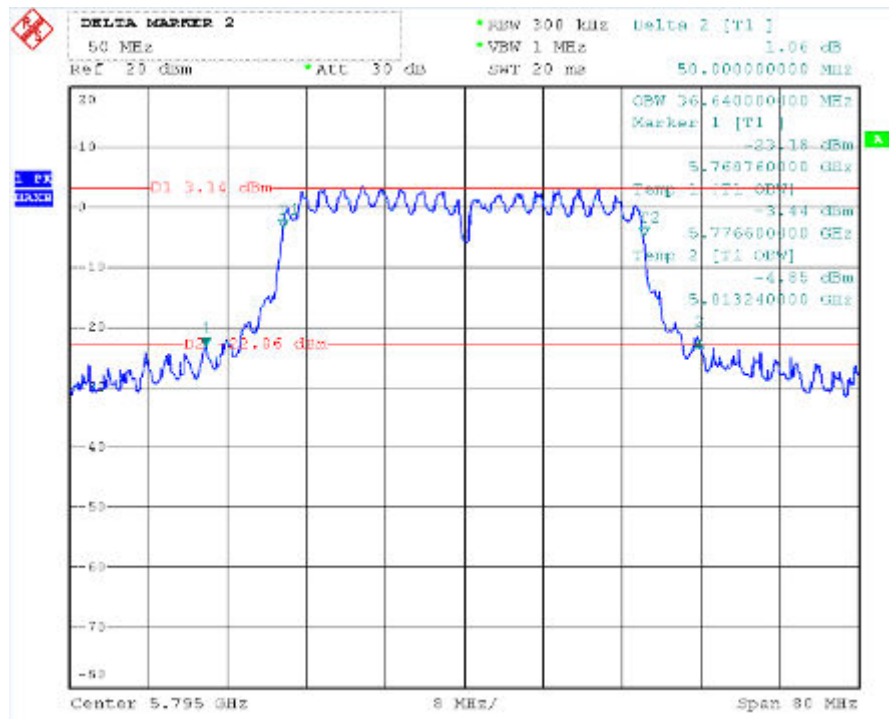

## 6. THE MAXIMUM E.I.R.P & MAXIMUM CONDUCTED OUTPUT POWER

### 6.1 LIMIT

According to §15.407(a),

- (1) For the band 5.15-5.25 GHz, the maximum conducted output power over the frequency band of operation shall not exceed the lesser of 1W . The maximum e.i.r.p. at any elevation angle above 30 degrees as measured from the horizon must not exceed 125 mW (21 dBm).
- (2) For the band 5.725-5.85 GHz, the maximum conducted output power over the frequency band of operation shall not exceed 1 W

*If transmitting antennas of directional gain greater than 6dBi are used, both the peak transmit power and the peak power spectral density shall be reduced by the amount in dB that the directional gain of the antenna exceeds 6dBi.*

*5.15-5.25GHz: Limit (dBm) = 30dBm.*

*5.725-5.85GHz: Limit (dBm) = 30dBm.*

### 6.2 Test Procedure Used

KDB 789033 D02v01 - Section E) 3) b) Method PM-G

### 6.3 Radiation measurement Test Configuration

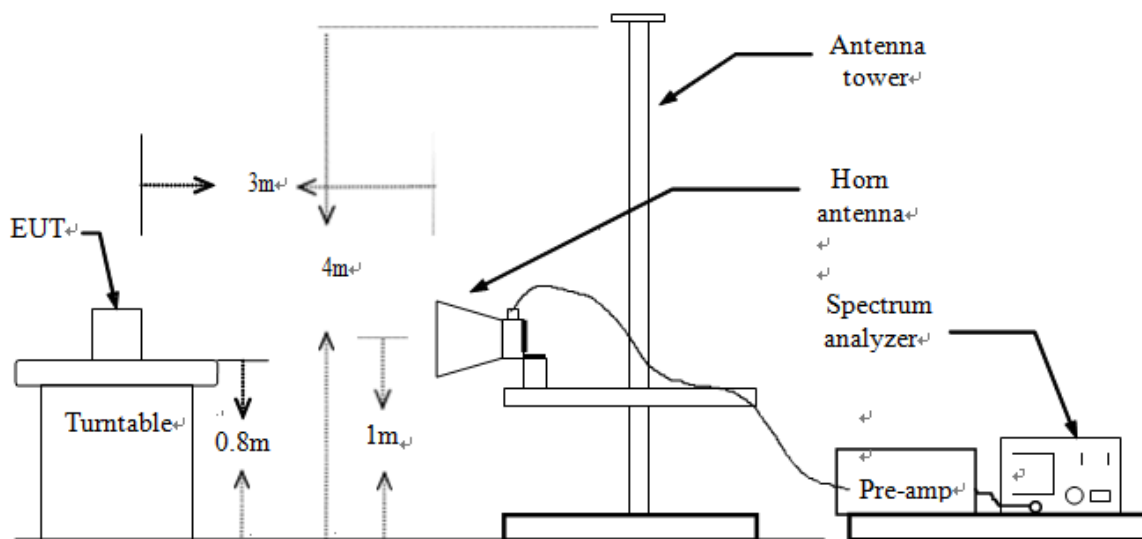

### TEST PROCEDURE

1. The EUT is placed on a turntable, which is 0.8m above ground plane.
2. The turntable shall be rotated for 360 degrees to determine the position of maximum emission level.
3. EUT is set 3m away from the receiving antenna, which is varied from 1m to 4m to find out the highest emissions.
4. Maximum procedure was performed on the six highest emissions to ensure EUT compliance.
5. And also, each emission was to be maximized by changing the polarization of receiving antenna both horizontal and vertical.

6. Set the spectrum analyzer in the following setting as:

Below 1GHz:

RBW=100kHz / VBW=300kHz / Sweep=AUTO

Above 1GHz:

(a) PEAK: RBW=1MHz, VBW=3MHz / Sweep=AUTO

(b) AVERAGE: RBW=1MHz

duty cycle  $\geq$  98 percent, set VBW  $\leq$  RBW/100 but not less than 10 Hz.

duty cycle  $<$  98 percent, set VBW  $\geq$  1/T

/ Sweep=AUTO

7. Repeat the procedures until all the PEAK and AVERAGE versus POLARIZATION are measured.
8. Repeat above procedures until the measurements for all frequencies are complete.

### 6.3 Conduction measurement Test Configuration

Average power measurements were performed only when the EUT was transmitting at its maximum power control level using a broadband power meter with a pulse sensor. The power meter implemented triggering and gating capabilities which were set up such that power measurements were recorded only during the ON time of the transmitter. The trace was averaged over 100 traces to obtain the final measured average power.

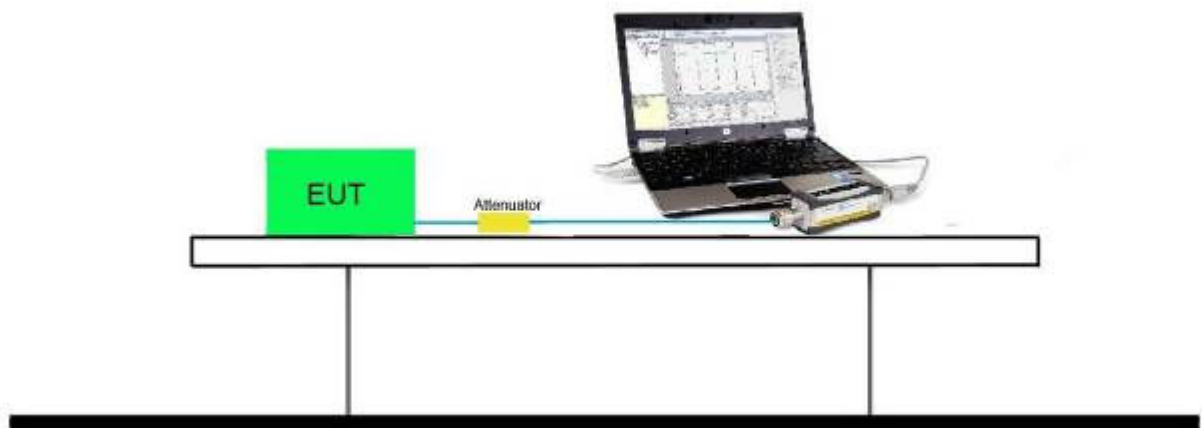

## TEST RESULTS

*No non-compliance noted*

Mode	Test CH	Average power (dBm)	Total Average power (dBm)	Limit (dBm)	Result
802.11a	Low	15.21	18.15	30.00	Pass
	Mid	15.52	18.39	30.00	Pass
	High	15.02	17.88	30.00	Pass
802.11n20	Low	15.12	17.90	30.00	Pass
	Mid	14.95	17.54	30.00	Pass
	High	14.47	17.27	30.00	Pass
802.11n40	Low	15.12	18.06	30.00	Pass
	High	15.20	17.97	30.00	Pass
802.11ac20	Low	12.58	14.50	21.00	Pass
	Mid	12.38	14.29	21.00	Pass
	High	12.30	14.24	21.00	Pass
802.11ac40	Low	12.34	14.21	21.00	Pass
	High	12.31	14.27	21.00	Pass



## 7. BAND EDGES MEASUREMENT

### 7.1 Test Limit

#### For 15.205 requirement:

Radiated emissions which fall in the restricted bands, as defined in Section 15.205(a) of FCC part 15, must also comply with the radiated emission limits specified in Section 15.209(a).

MHz	MHz	MHz	GHz
0.090 - 0.110	16.42 - 16.423	399.9 - 410	4.5 - 5.15
<sup>1</sup> 0.495 - 0.505	16.69475 - 16.69525	608 - 614	5.35 - 5.46
2.1735 - 2.1905	16.80425 - 16.80475	960 - 1240	7.25 - 7.75
4.125 - 4.128	25.5 - 25.67	1300 - 1427	8.025 - 8.5
4.17725 - 4.17775	37.5 - 38.25	1435 - 1626.5	9.0 - 9.2
4.20725 - 4.20775	73 - 74.6	1645.5 - 1646.5	9.3 - 9.5
6.215 - 6.218	74.8 - 75.2	1660 - 1710	10.6 - 12.7
6.26775 - 6.26825	108 - 121.94	1718.8 - 1722.2	13.25 - 13.4
6.31175 - 6.31225	123 - 138	2200 - 2300	14.47 - 14.5
8.291 - 8.294	149.9 - 150.05	2310 - 2390	15.35 - 16.2
8.362 - 8.366	156.52475 - 156.52525	2483.5 - 2500	17.7 - 21.4
8.37625 - 8.38675	156.7 - 156.9	2690 - 2900	22.01 - 23.12
8.41425 - 8.41475	162.0125 - 167.17	3260 - 3267	23.6 - 24.0
12.29 - 12.293	167.72 - 173.2	3332 - 3339	31.2 - 31.8
12.51975 - 12.52025	240 - 285	3345.8 - 3358	36.43 - 36.5
12.57675 - 12.57725	322 - 335.4	3600 - 4400	( <sup>2</sup> )

#### For 15.407(b) requirement:

For transmitters operating in the 5.15-5.25 GHz band: All emissions outside of the 5.15-5.35 GHz band shall not exceed an e.i.r.p. of -27 dBm/MHz.

For transmitters operating in the 5.25-5.35 GHz band: All emissions outside of the 5.15-5.35 GHz band shall not exceed an e.i.r.p. of -27 dBm/MHz.

For transmitters operating in the 5.47-5.725 GHz band: All emissions outside of the 5.47-5.725 GHz band shall not exceed an e.i.r.p. of -27 dBm/MHz.

All emissions shall be limited to a level of -27 dBm/MHz at 75 MHz or more above or below the band edge increasing linearly to 10 dBm/MHz at 25 MHz above or below the band edge, and from 25 MHz above or below the band edge increasing linearly to a level of 15.6 dBm/MHz at 5 MHz above or below the band edge, and from 5 MHz above or below the band edge increasing linearly to a level of 27 dBm/MHz at the band edge.

Refer to KDB 789033 D02v01 G)2)c), as specified in § 15.407(b), emissions above 1000 MHz that are outside of the restricted bands are subject to a maximum emission limit of -27 dBm/MHz (or -17 dBm/MHz as specified in § 15.407(b)(4)). However, an out-of-band emission that complies with both the peak and average limits of § 15.209 is not required to satisfy the -27 dBm/MHz or -17 dBm/MHz maximum emission limit.

All out of band emissions appearing in a restricted band as specified in Section 15.205 of the Title 47 CFR must not exceed the limits shown in Table per Section 15.209.

FCC Part 15 Subpart C Paragraph 15.209		
Frequency [MHz]	Field Strength [V/m]	Measured Distance [Meters]
0.009 – 0.490	2400/F (kHz)	300
0.490 – 1.705	24000/F (kHz)	30
1.705 - 30	30	30
30 - 88	100	3
88 - 216	150	3
216 - 960	200	3
Above 960	500	3

## 7.2 Test Result of Radiated Restricted Band Edge

Band Edges (IEEE 802.11a mode / 5745 MHz)

Detector mode: Pk/AV

Polarity: Horizontal

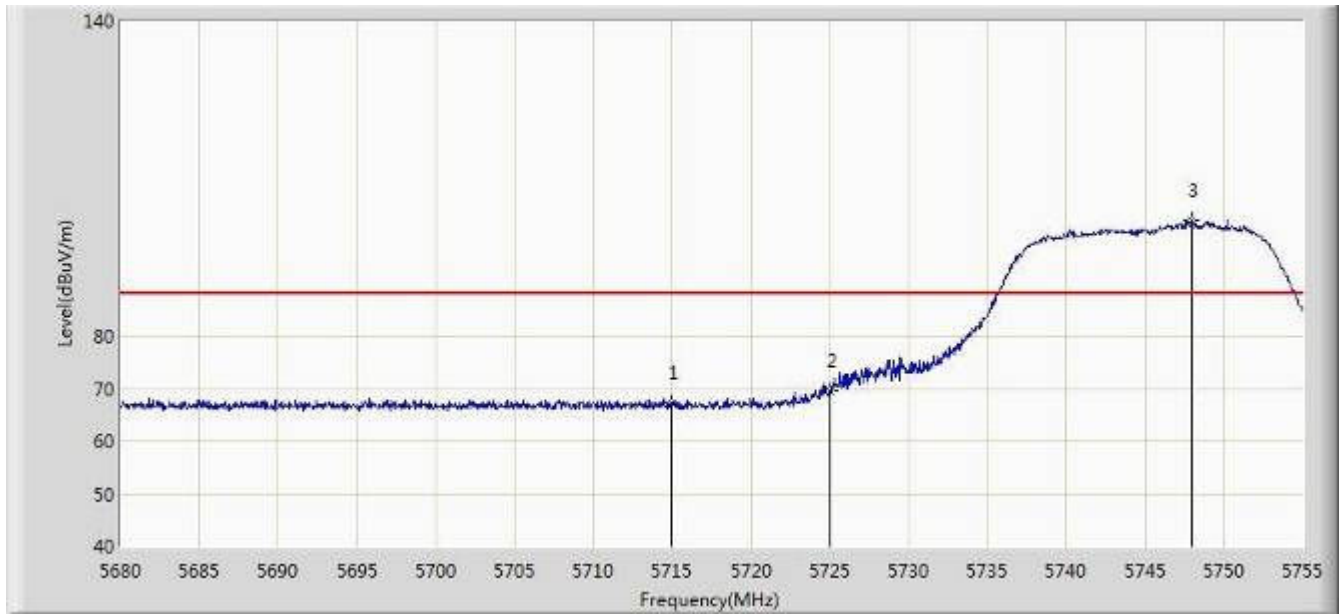

No	Flag	Mark	Frequency (MHz)	Measure Level (dBuV/m)	Reading Level (dBuV)	Over Limit (dB)	Limit (dBuV/m)	Factor (dB)	Type
1			5715.000	67.238	59.466	-20.962	88.200	7.772	PK
2			5725.000	69.491	61.700	-28.709	98.200	7.791	AV
3		*	5747.958	102.081	94.242	N/A	N/A	7.839	PK

Note: Measure Level (dB $\mu$ V/m) = Reading Level (dB $\mu$ V) + Factor (dB)

Factor (dB) = Cable Loss (dB) + Antenna Factor (dB/m) – Pre\_Amplifier Gain (dB).

**Band Edges (IEEE 802.11a mode / 5745 MHz)**

**Detector mode: Peak/AV**

**Polarity: Vertical**

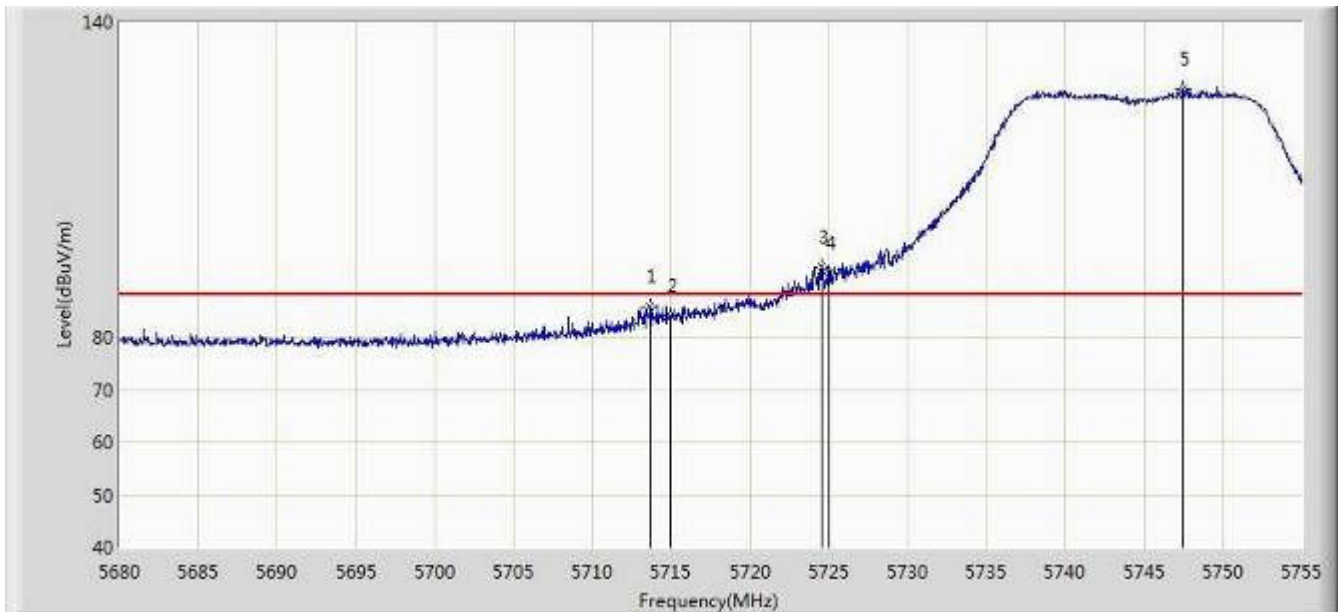

No	Flag	Mark	Frequency (MHz)	Measure Level (dBuV/m)	Reading Level (dBuV)	Over Limit (dB)	Limit (dBuV/m)	Factor (dB)	Type
1			5713.660	85.882	78.113	-2.318	88.200	7.769	PK
2			5715.000	84.127	76.355	-4.073	88.200	7.772	AV
3			5724.583	93.445	85.655	-4.755	98.200	7.790	PK
4			5725.000	92.241	84.450	-5.959	98.200	7.791	AV
5		*	5747.490	127.296	119.458	N/A	N/A	7.838	PK

Note: Measure Level (dBuV/m) = Reading Level (dBuV) + Factor (dB)

Factor (dB) = Cable Loss (dB) + Antenna Factor (dB/m) – Pre\_Amplifier Gain (dB).

**Band Edges (IEEE 802.11a Channel mode / 5825 MHz)**

**Detector mode: Peak/AV**

**Polarity: Horizontal**

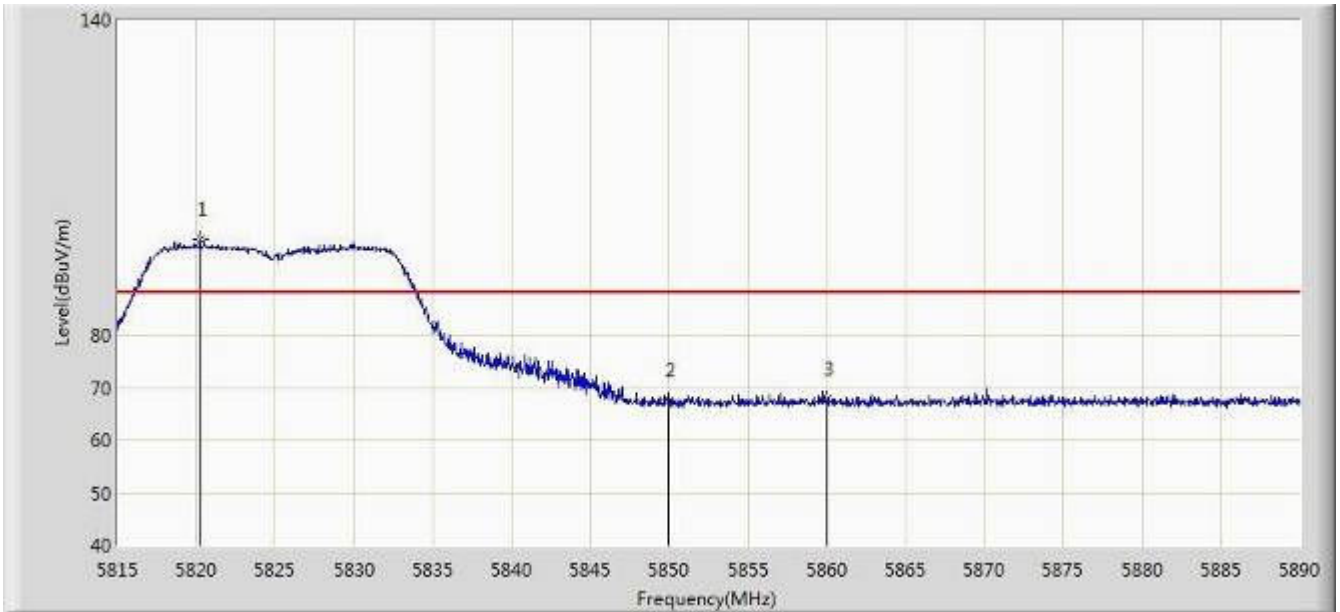

No	Flag	Mark	Frequency (MHz)	Measure Level (dBuV/m)	Reading Level (dBuV)	Over Limit (dB)	Limit (dBuV/m)	Factor (dB)	Type
1		*	5820.250	98.264	90.221	N/A	N/A	8.043	PK
2			5850.000	67.629	59.495	-30.571	98.200	8.134	AV
3			5860.000	67.848	59.659	-20.352	88.200	8.189	PK

Note: Measure Level (dBμV/m) = Reading Level (dBμV) + Factor (dB)

Factor (dB) = Cable Loss (dB) + Antenna Factor (dB/m) – Pre\_Amplifier Gain (dB).

**Band Edges (IEEE 802.11a Channel mode / 5825 MHz)**

**Detector mode: Peak/AV**

**Polarity: Vertical**

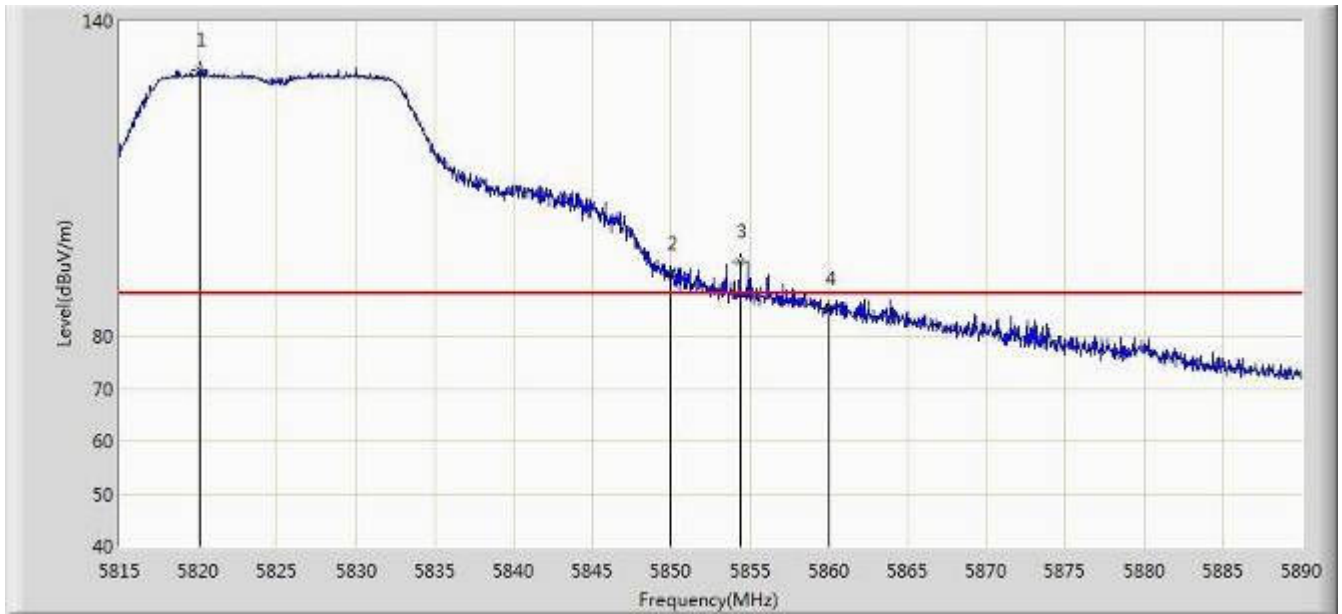

No	Flag	Mark	Frequency (MHz)	Measure Level (dBuV/m)	Reading Level (dBuV)	Over Limit (dB)	Limit (dBuV/m)	Factor (dB)	Type
1		*	5820.062	130.729	122.686	N/A	N/A	8.043	PK
2			5850.000	91.943	83.809	-6.257	98.200	8.134	AV
3			5854.337	94.255	86.097	-3.945	98.200	8.157	PK
4			5860.000	85.322	77.133	-2.878	88.200	8.189	AV

Note: Measure Level (dB $\mu$ V/m) = Reading Level (dB $\mu$ V) + Factor (dB)

Factor (dB) = Cable Loss (dB) + Antenna Factor (dB/m) – Pre\_Amplifier Gain (dB).

**Band Edges (IEEE 802.11n HT20 MHz Channel mode / 5745 MHz)**

**Detector mode: Peak/AV**

**Polarity: Horizontal**

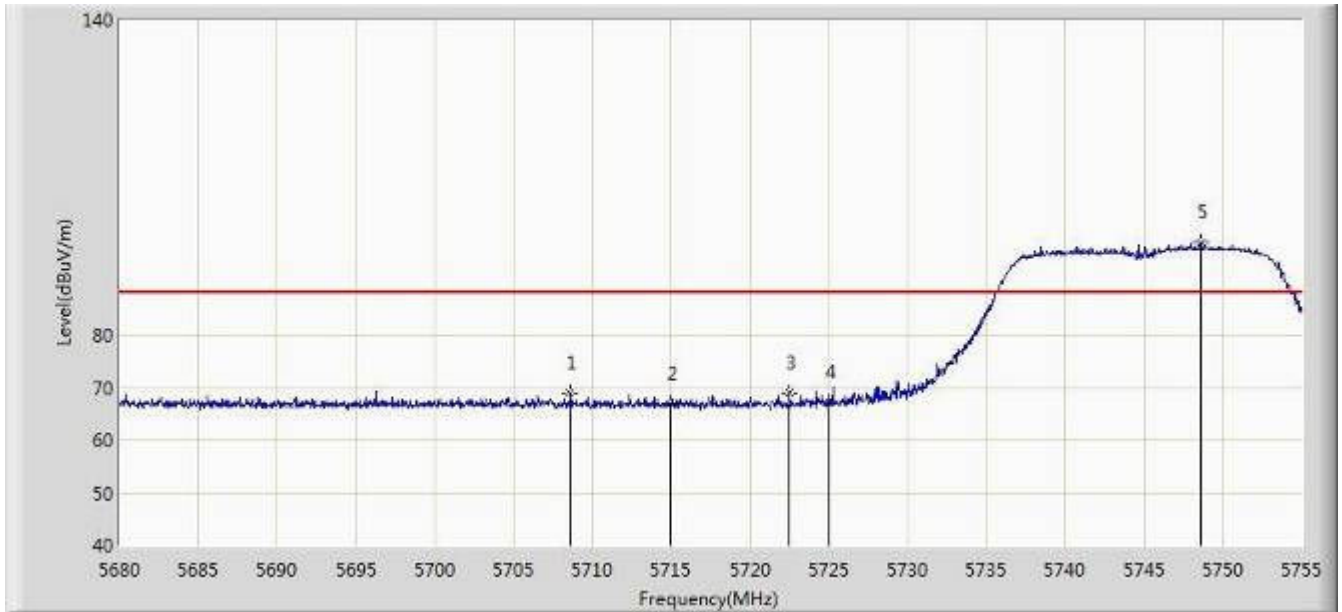

No	Flag	Mark	Frequency (MHz)	Measure Level (dBuV/m)	Reading Level (dBuV)	Over Limit (dB)	Limit (dBuV/m)	Factor (dB)	Type
1			5708.612	68.933	61.174	-19.267	88.200	7.759	PK
2			5715.000	66.895	59.123	-21.305	88.200	7.772	AV
3			5722.525	68.984	61.198	-29.216	98.200	7.786	PK
4			5725.000	67.150	59.359	-31.050	98.200	7.791	AV
5		*	5748.587	97.545	89.705	N/A	N/A	7.840	PK

Note: Measure Level (dBuV/m) = Reading Level (dBuV) + Factor (dB)

Factor (dB) = Cable Loss (dB) + Antenna Factor (dB/m) – Pre\_Amplifier Gain (dB).

**Band Edges (IEEE 802.11n HT20 MHz Channel mode / 5745 MHz)**

**Detector mode: Peak/AV**

**Polarity: Vertical**

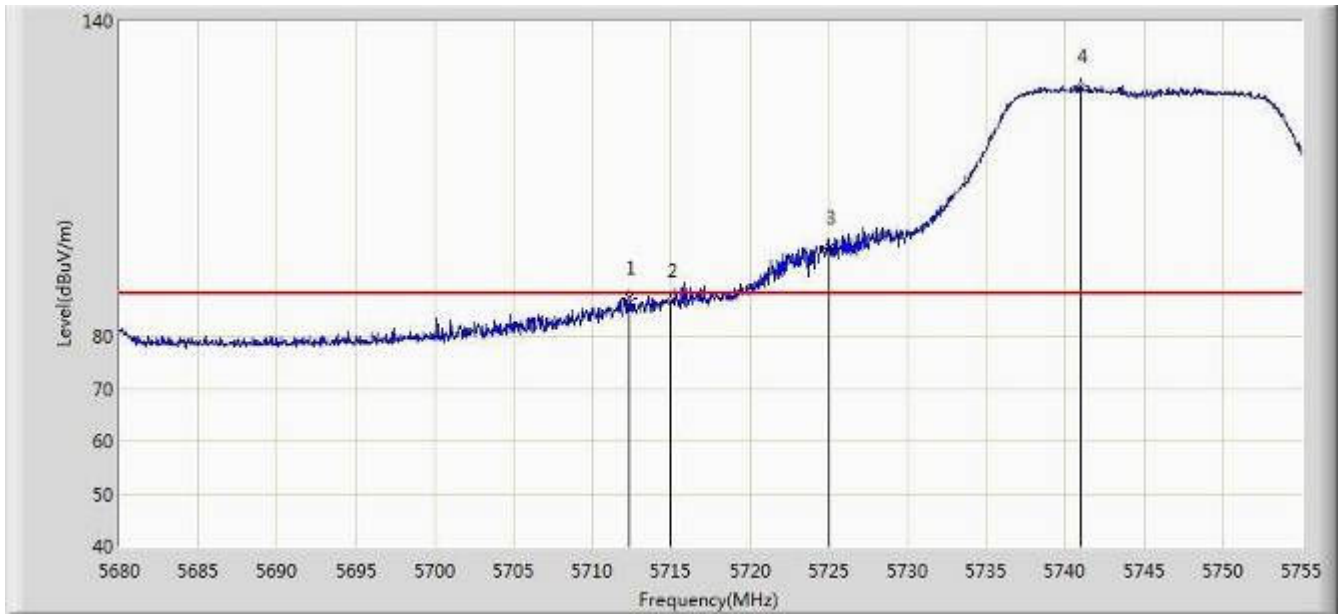

No	Flag	Mark	Frequency (MHz)	Measure Level (dBuV/m)	Reading Level (dBuV)	Over Limit (dB)	Limit (dBuV/m)	Factor (dB)	Type
1			5712.325	87.131	79.365	-1.069	88.200	7.767	PK
2			5715.000	86.635	78.863	-1.565	88.200	7.772	AV
3			5725.000	96.785	88.994	-1.415	98.200	7.791	PK
4		*	5740.975	127.510	119.685	N/A	N/A	7.825	AV

Note: Measure Level (dB $\mu$ V/m) = Reading Level (dB $\mu$ V) + Factor (dB)

Factor (dB) = Cable Loss (dB) + Antenna Factor (dB/m) – Pre\_Amplifier Gain (dB).



**Band Edges (IEEE 802.11n HT20 MHz Channel mode / 5785 MHz)**

**Detector mode: Peak/AV**

**Polarity: Horizontal**

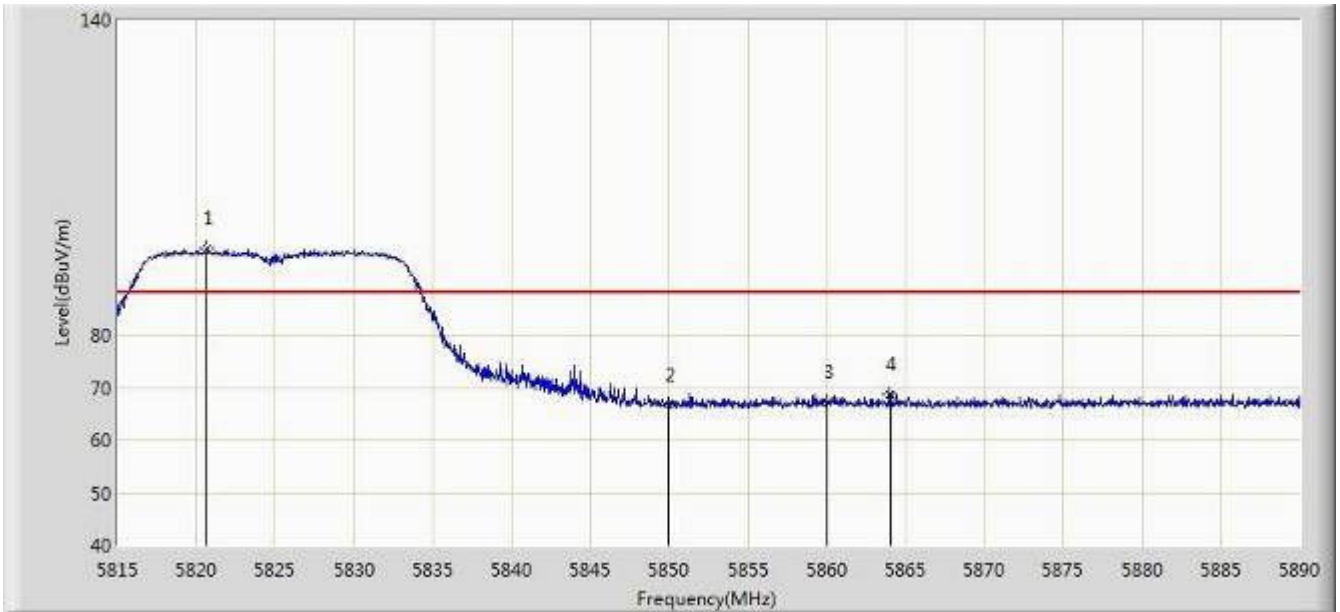

No	Flag	Mark	Frequency (MHz)	Measure Level (dBuV/m)	Reading Level (dBuV)	Over Limit (dB)	Limit (dBuV/m)	Factor (dB)	Type
1		*	5820.663	96.566	88.522	N/A	N/A	8.044	PK
2			5850.000	66.704	58.570	-31.496	98.200	8.134	AV
3			5860.000	67.318	59.129	-20.882	88.200	8.189	PK
4			5864.013	68.728	60.521	-19.472	88.200	8.207	AV

Note: Measure Level (dB $\mu$ V/m) = Reading Level (dB $\mu$ V) + Factor (dB)

Factor (dB) = Cable Loss (dB) + Antenna Factor (dB/m) – Pre\_Amplifier Gain (dB).

**Band Edges (IEEE 802.11n HT20 MHz Channel mode / 5785 MHz)**

**Detector mode: Peak/AV**

**Polarity: Vertical**

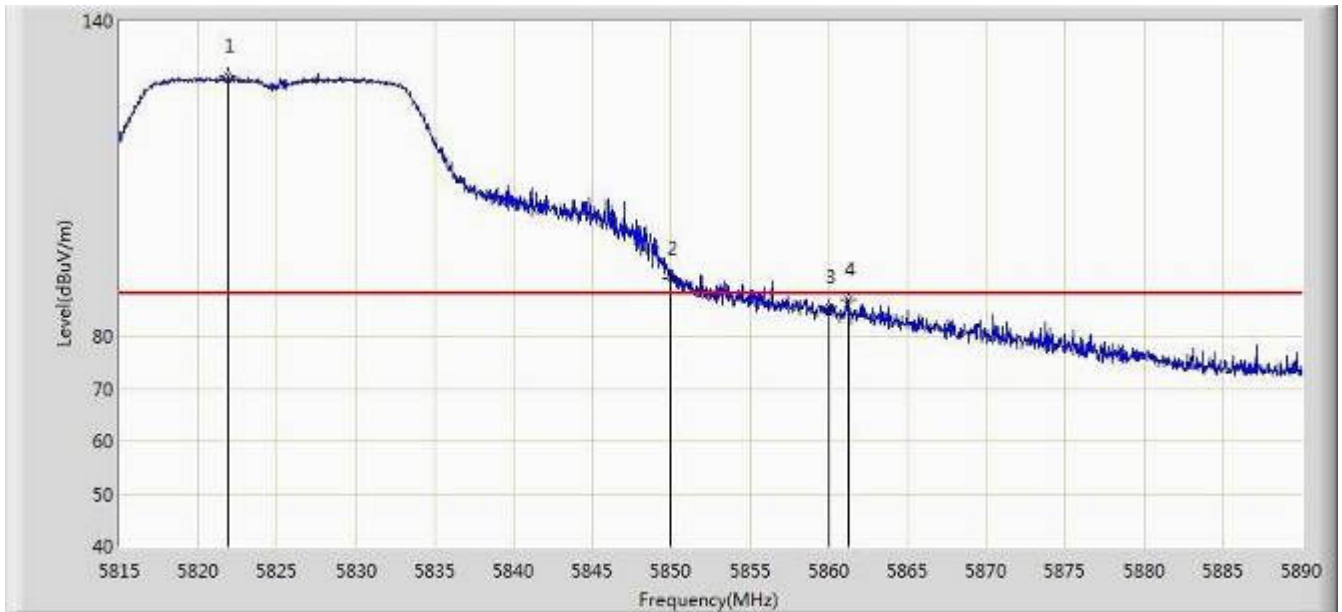

No	Flag	Mark	Frequency (MHz)	Measure Level (dBuV/m)	Reading Level (dBuV)	Over Limit (dB)	Limit (dBuV/m)	Factor (dB)	Type
1		*	5821.862	129.665	121.620	N/A	N/A	8.045	PK
2			5850.000	91.002	82.868	-7.198	98.200	8.134	AV
3			5860.000	85.463	77.274	-2.737	88.200	8.189	PK
4			5861.200	87.009	78.814	-1.191	88.200	8.195	AV

Note: Measure Level (dB $\mu$ V/m) = Reading Level (dB $\mu$ V) + Factor (dB)

Factor (dB) = Cable Loss (dB) + Antenna Factor (dB/m) – Pre\_Amplifier Gain (dB).

**Band Edges (IEEE 802.11n HT40 MHz Channel mode / 5755 MHz)**

**Detector mode: Peak/AV**

**Polarity: Horizontal**

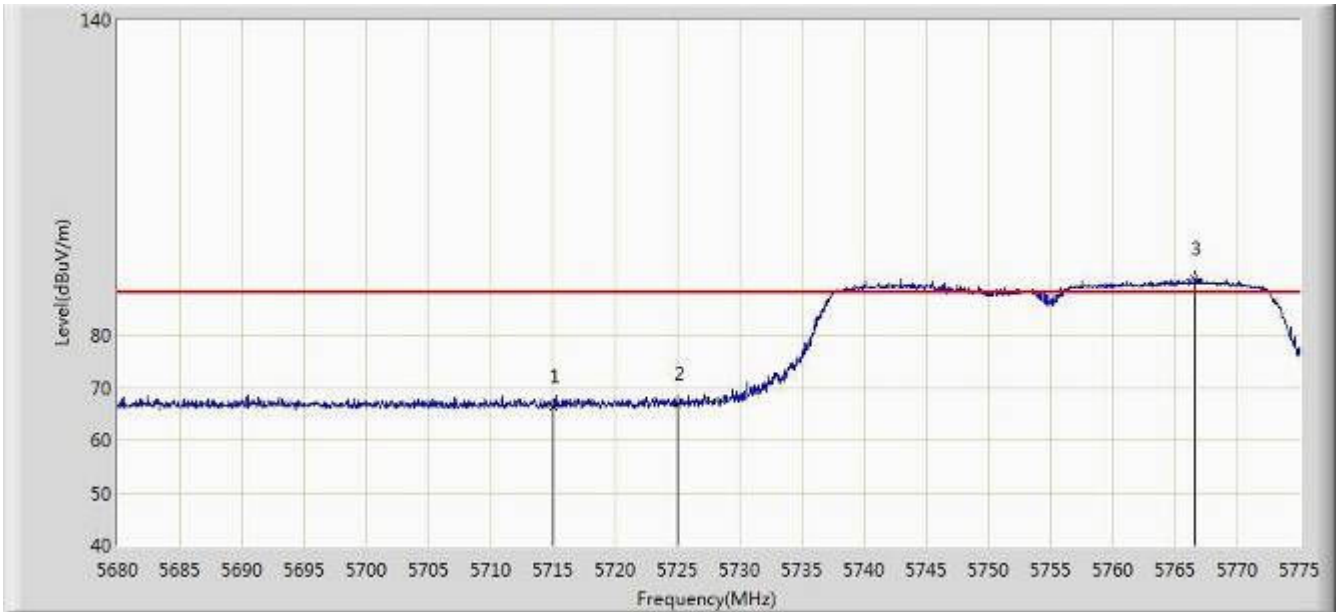

No	Flag	Mark	Frequency (MHz)	Measure Level (dBuV/m)	Reading Level (dBuV)	Over Limit (dB)	Limit (dBuV/m)	Factor (dB)	Type
1			5715.000	66.435	58.663	-21.765	88.200	7.772	PK
2			5725.000	66.853	59.062	-31.347	98.200	7.791	AV
3		*	5766.592	90.678	82.794	N/A	N/A	7.884	PK

Note: Measure Level (dBμV/m) = Reading Level (dBμV) + Factor (dB)

Factor (dB) = Cable Loss (dB) + Antenna Factor (dB/m) – Pre\_Amplifier Gain (dB).

**Band Edges (IEEE 802.11n HT40 MHz Channel mode / 5755 MHz)**

**Detector mode: Peak/AV**

**Polarity: Vertical**

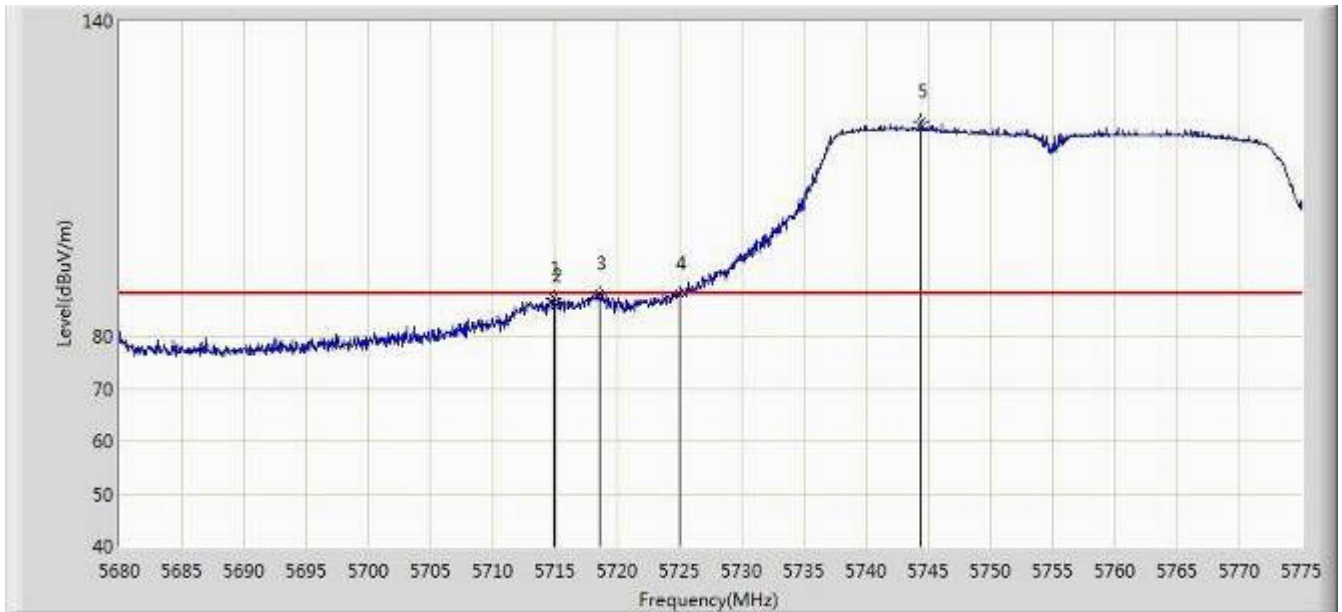

No	Flag	Mark	Frequency (MHz)	Measure Level (dBuV/m)	Reading Level (dBuV)	Over Limit (dB)	Limit (dBuV/m)	Factor (dB)	Type
1			5714.913	87.140	79.369	-1.060	88.200	7.771	PK
2			5715.000	85.752	77.980	-2.448	88.200	7.772	AV
3			5718.618	88.042	80.264	-10.158	98.200	7.778	PK
4			5725.000	87.980	80.189	-10.220	98.200	7.791	AV
5		*	5744.410	120.848	113.017	N/A	N/A	7.831	PK

Note: Measure Level (dBuV/m) = Reading Level (dBuV) + Factor (dB)

Factor (dB) = Cable Loss (dB) + Antenna Factor (dB/m) – Pre\_Amplifier Gain (dB).

**Band Edges (IEEE 802.11n HT40 MHz Channel mode / 5795 MHz)**

**Detector mode: Peak/AV**

**Polarity: Horizontal**

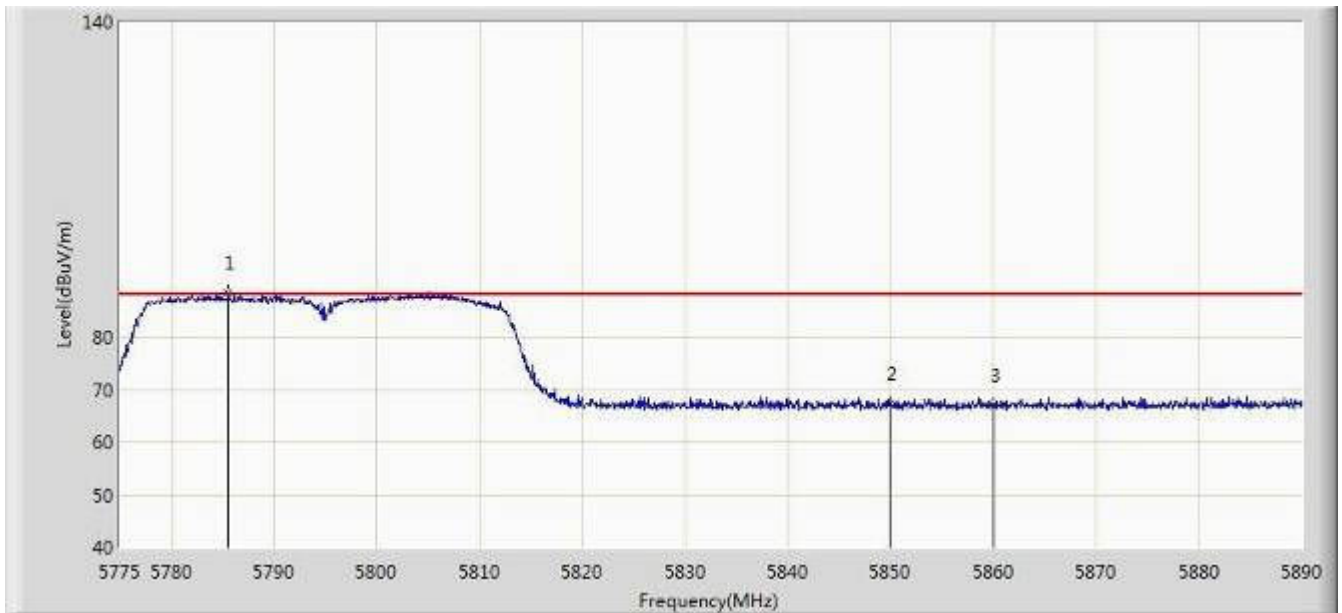

No	Flag	Mark	Frequency (MHz)	Measure Level (dBuV/m)	Reading Level (dBuV)	Over Limit (dB)	Limit (dBuV/m)	Factor (dB)	Type
1		*	5785.522	88.528	80.579	N/A	N/A	7.949	PK
2			5850.000	67.191	59.057	-31.009	98.200	8.134	AV
3			5860.000	66.976	58.787	-21.224	88.200	8.189	PK

Note: Measure Level (dBμV/m) = Reading Level (dBμV) + Factor (dB)

Factor (dB) = Cable Loss (dB) + Antenna Factor (dB/m) – Pre\_Amplifier Gain (dB).

**Band Edges (IEEE 802.11n HT40 MHz Channel mode / 5795 MHz)**

**Detector mode: Peak/AV**

**Polarity: Vertical**

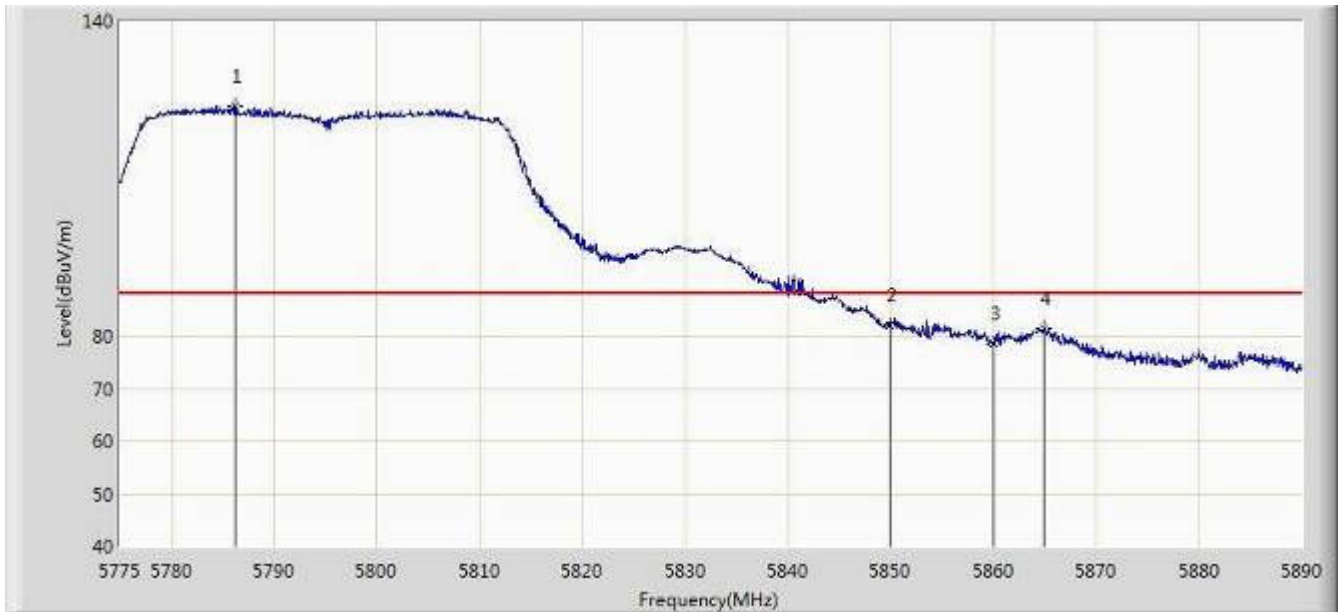

No	Flag	Mark	Frequency (MHz)	Measure Level (dBuV/m)	Reading Level (dBuV)	Over Limit (dB)	Limit (dBuV/m)	Factor (dB)	Type
1		*	5786.270	123.769	115.817	N/A	N/A	7.953	PK
2			5850.000	82.062	73.928	-16.138	98.200	8.134	AV
3			5860.000	78.587	70.398	-9.613	88.200	8.189	PK
4			5864.873	81.496	73.292	-6.704	88.200	8.210	AV

Note: Measure Level (dB $\mu$ V/m) = Reading Level (dB $\mu$ V) + Factor (dB)

Factor (dB) = Cable Loss (dB) + Antenna Factor (dB/m) – Pre\_Amplifier Gain (dB).

**Band Edges (IEEE 802.11ac HT20 MHz Channel mode / 5745 MHz)**

**Detector mode: Pk/AV**

**Polarity: Horizontal**

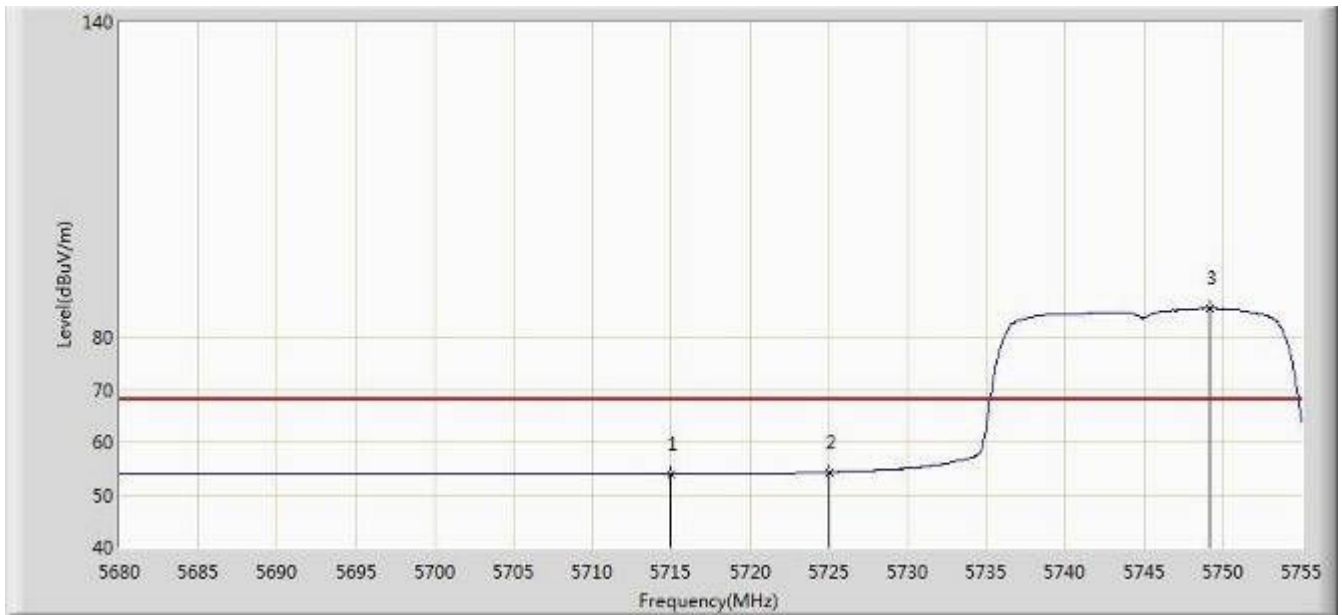

No	Flag	Mark	Frequency (MHz)	Measure Level (dBuV/m)	Reading Level (dBuV)	Over Limit (dB)	Limit (dBuV/m)	Factor (dB)	Type
1			5715.000	53.858	46.086	-14.342	68.200	7.772	PK
2			5725.000	54.301	46.510	-23.899	78.200	7.791	AV
3		*	5749.150	85.395	77.554	N/A	N/A	7.841	PK

Note: Measure Level (dBμV/m) = Reading Level (dBμV) + Factor (dB)

Factor (dB) = Cable Loss (dB) + Antenna Factor (dB/m) – Pre\_Amplifier Gain (dB).

**Band Edges (IEEE 802.11ac HT20 MHz Channel mode / 5745 MHz)**

**Detector mode: Pk/AV**

**Polarity: Vertical**

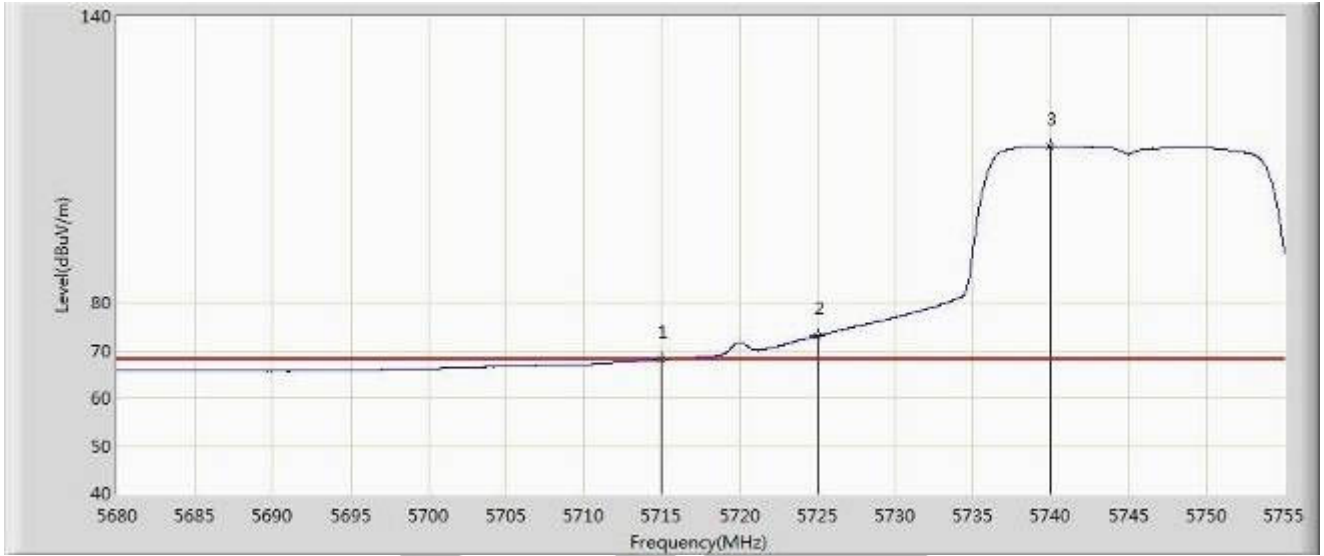

No	Flag	Mark	Frequency (MHz)	Measure Level (dBuV/m)	Reading Level (dBuV)	Over Limit (dB)	Limit (dBuV/m)	Factor (dB)	Type
1			5715.000	68.025	60.253	-0.175	68.200	7.772	PK
2			5725.000	73.014	65.223	-5.186	78.200	7.791	AV
3		*	5739.925	112.832	105.009	N/A	N/A	7.823	PK

Note: Measure Level (dBμV/m) = Reading Level (dBμV) + Factor (dB)

Factor (dB) = Cable Loss (dB) + Antenna Factor (dB/m) – Pre\_Amplifier Gain (dB).



**Band Edges (IEEE 802.11ac HT20 MHz Channel mode / 5785 MHz)**

**Detector mode: PK/AV**

**Polarity: Horizontal**

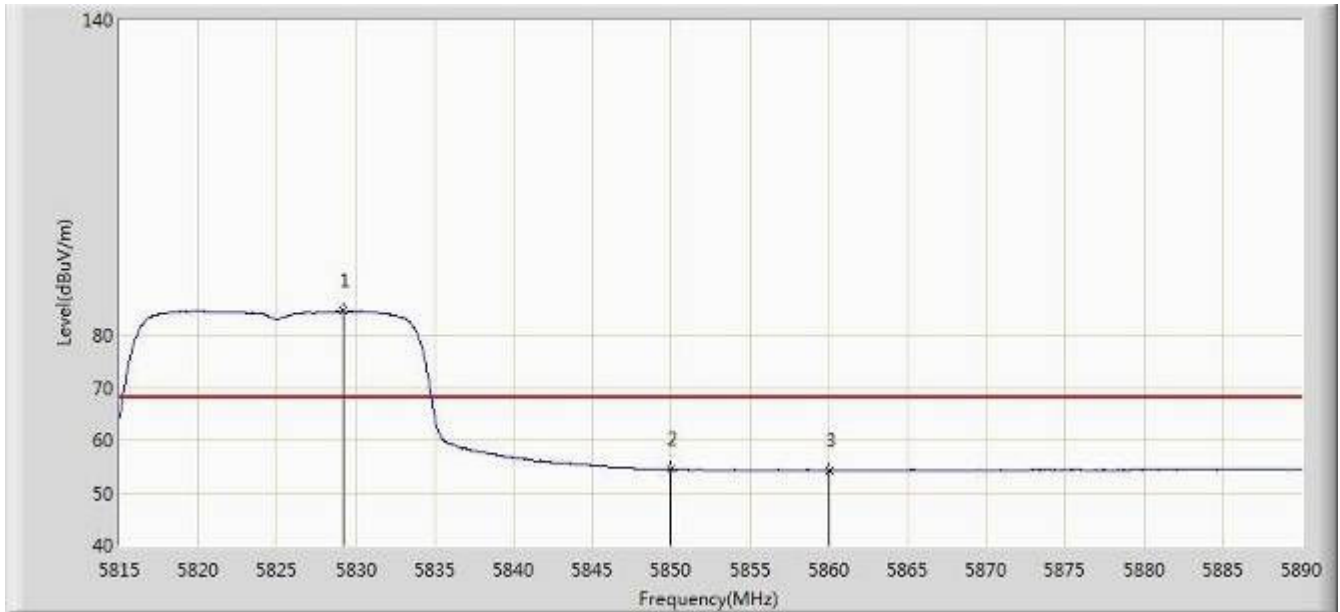

No	Flag	Mark	Frequency (MHz)	Measure Level (dBuV/m)	Reading Level (dBuV)	Over Limit (dB)	Limit (dBuV/m)	Factor (dB)	Type
1		*	5829.175	84.572	76.513	N/A	N/A	8.059	PK
2			5850.000	54.393	46.259	-23.807	78.200	8.134	AV
3			5860.000	54.317	46.128	-13.883	68.200	8.189	PK

Note: Measure Level (dB $\mu$ V/m) = Reading Level (dB $\mu$ V) + Factor (dB)

Factor (dB) = Cable Loss (dB) + Antenna Factor (dB/m) – Pre\_Amplifier Gain (dB).

**Band Edges (IEEE 802.11ac HT20 MHz Channel mode / 5785 MHz)**

**Detector mode: PK/AV**

**Polarity: Vertical**

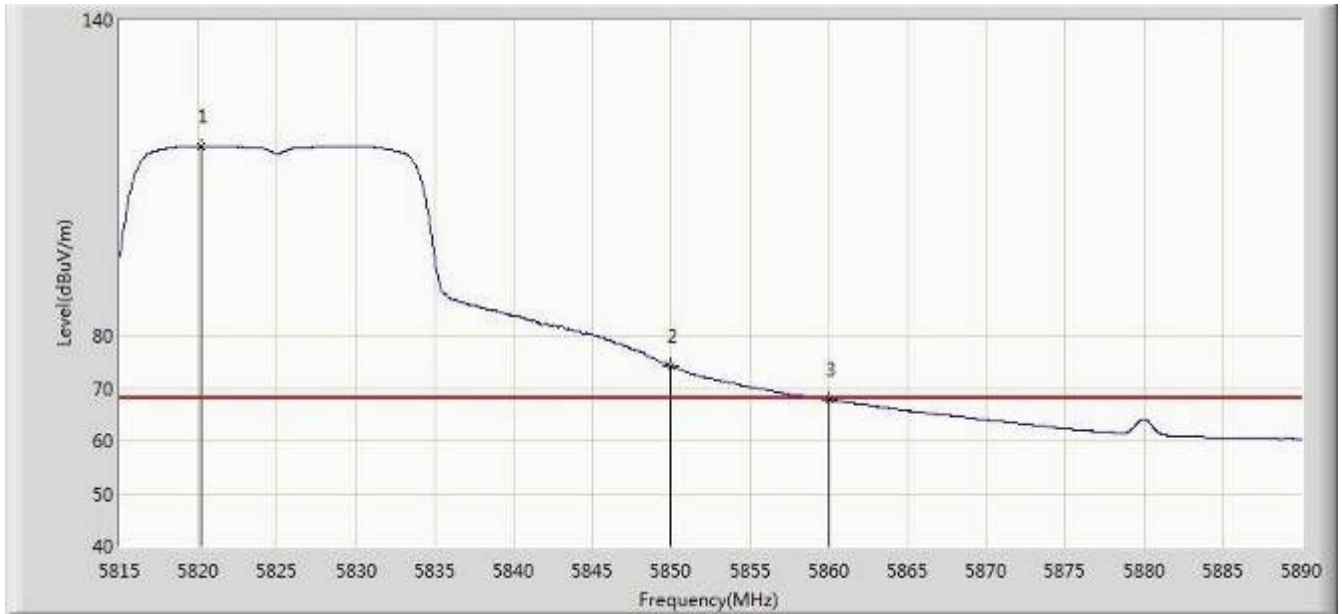

No	Flag	Mark	Frequency (MHz)	Measure Level (dBuV/m)	Reading Level (dBuV)	Over Limit (dB)	Limit (dBuV/m)	Factor (dB)	Type
1		*	5820.212	115.942	107.899	N/A	N/A	8.043	PK
2			5850.000	74.178	66.044	-4.022	78.200	8.134	AV
3			5860.000	67.813	59.624	-0.387	68.200	8.189	PK

Note: Measure Level (dBμV/m) = Reading Level (dBμV) + Factor (dB)

Factor (dB) = Cable Loss (dB) + Antenna Factor (dB/m) – Pre\_Amplifier Gain (dB).

**Band Edges (IEEE 802.11ac HT40 MHz Channel mode / 5755 MHz)**

**Detector mode: PK/AV**

**Polarity: Horizontal**

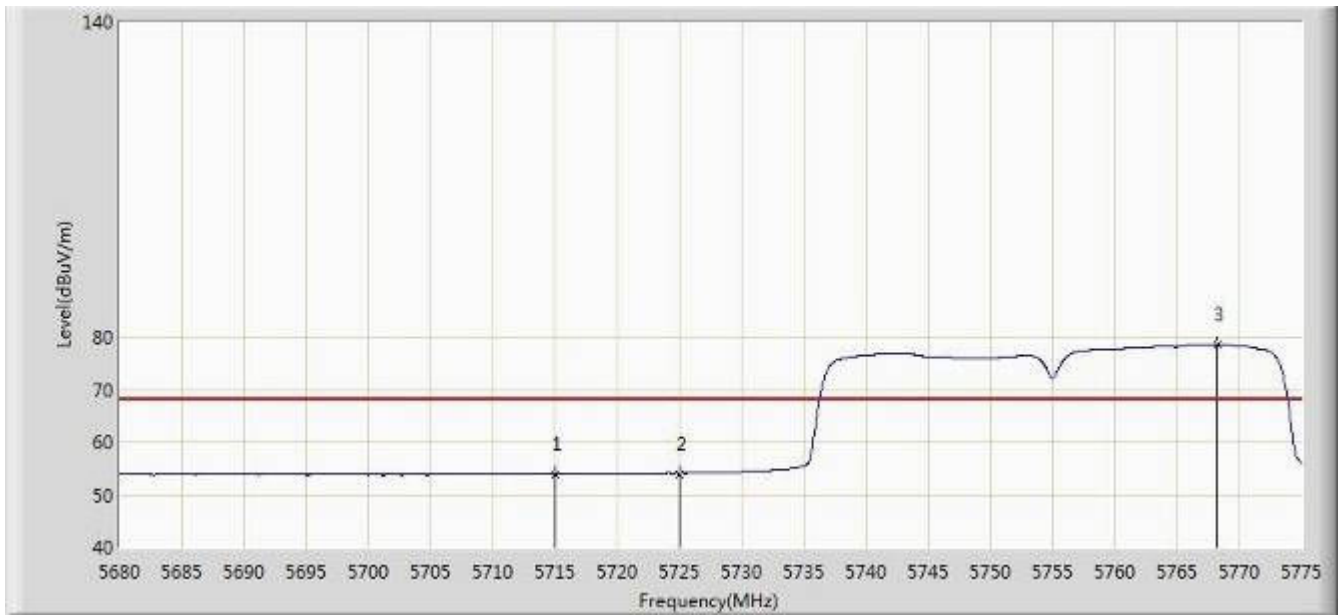

No	Flag	Mark	Frequency (MHz)	Measure Level (dBuV/m)	Reading Level (dBuV)	Over Limit (dB)	Limit (dBuV/m)	Factor (dB)	Type
1			5715.000	53.913	46.141	-14.287	68.200	7.772	PK
2			5725.000	54.042	46.251	-24.158	78.200	7.791	AV
3		*	5768.160	78.565	70.676	N/A	N/A	7.889	PK

Note: Measure Level (dB $\mu$ V/m) = Reading Level (dB $\mu$ V) + Factor (dB)

Factor (dB) = Cable Loss (dB) + Antenna Factor (dB/m) – Pre\_Amplifier Gain (dB).

**Band Edges (IEEE 802.11ac HT40 MHz Channel mode / 5755 MHz)**

**Detector mode: PK/AV**

**Polarity: Vertical**

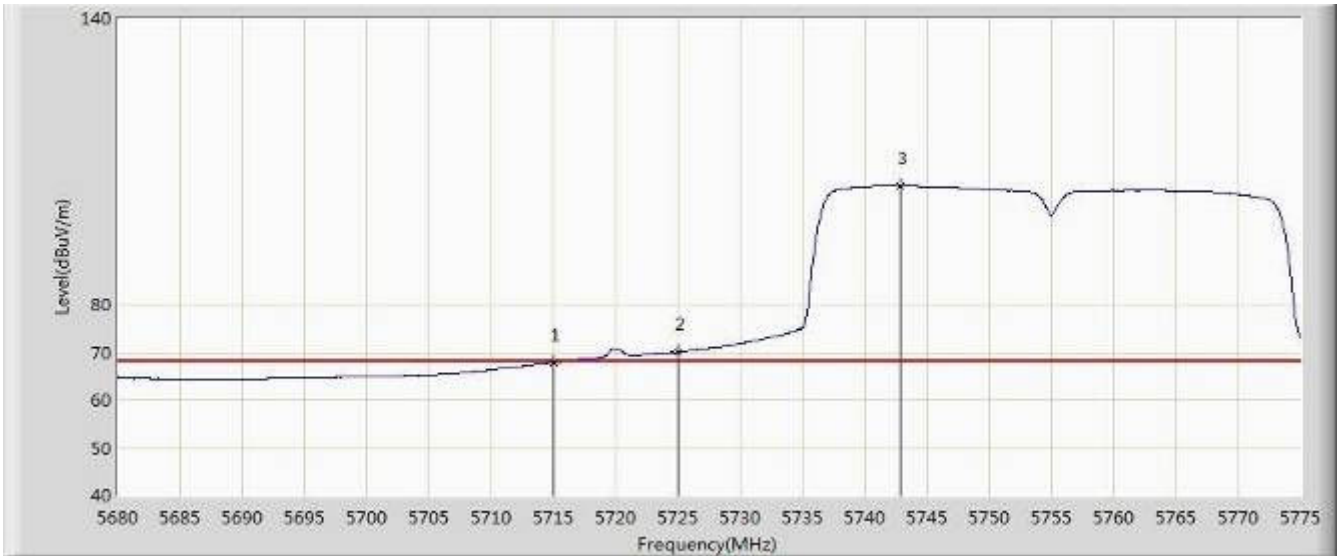

No	Flag	Mark	Frequency (MHz)	Measure Level (dBuV/m)	Reading Level (dBuV)	Over Limit (dB)	Limit (dBuV/m)	Factor (dB)	Type
1			5715.000	67.787	60.015	-0.413	68.200	7.772	PK
2			5725.000	70.036	62.245	-8.164	78.200	7.791	AV
3		*	5742.890	104.931	97.103	N/A	N/A	7.828	PK

Note: Measure Level (dBuV/m) = Reading Level (dBuV) + Factor (dB)

Factor (dB) = Cable Loss (dB) + Antenna Factor (dB/m) – Pre\_Amplifier Gain (dB).

**Band Edges (IEEE 802.11ac HT40 MHz Channel mode / 5795 MHz)**

**Detector mode: PK/AV**

**Polarity: Horizontal**

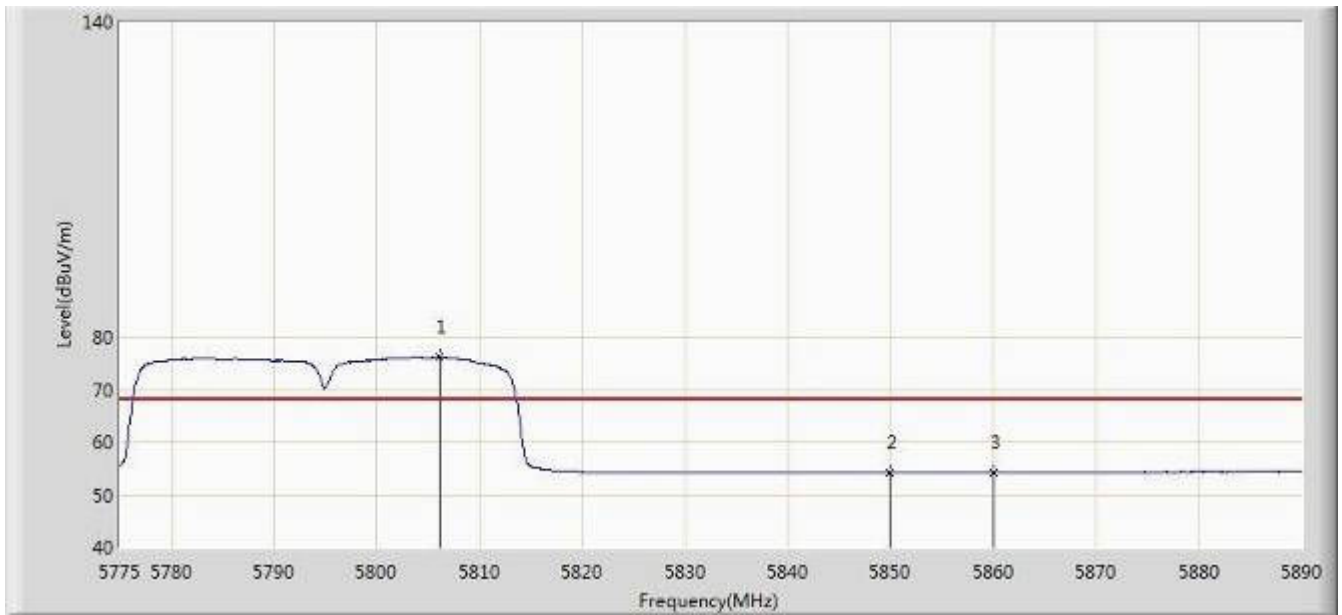

No	Flag	Mark	Frequency (MHz)	Measure Level (dBuV/m)	Reading Level (dBuV)	Over Limit (dB)	Limit (dBuV/m)	Factor (dB)	Type
1		*	5806.107	76.183	68.169	N/A	N/A	8.015	PK
2			5850.000	54.211	46.077	-23.989	78.200	8.134	AV
3			5860.000	54.283	46.094	-13.917	68.200	8.189	PK

Note: Measure Level (dB $\mu$ V/m) = Reading Level (dB $\mu$ V) + Factor (dB)

Factor (dB) = Cable Loss (dB) + Antenna Factor (dB/m) – Pre\_Amplifier Gain (dB).

**Band Edges (IEEE 802.11ac HT40 MHz Channel mode / 5795 MHz)**

**Detector mode: Pk/AV**

**Polarity: Vertical**

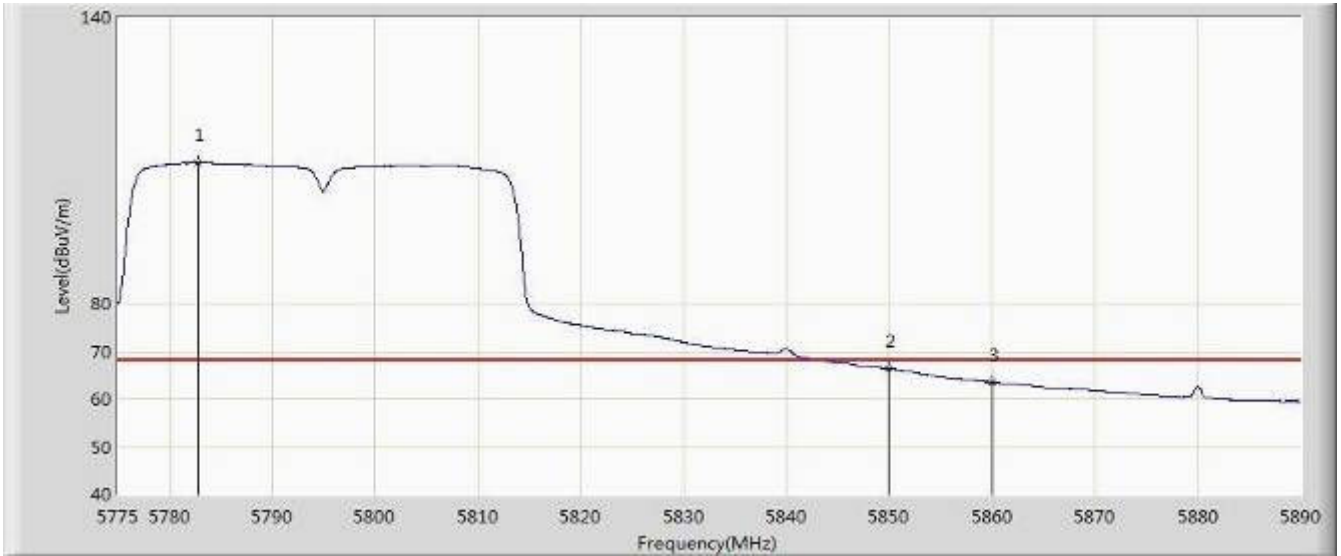

No	Flag	Mark	Frequency (MHz)	Measure Level (dBuV/m)	Reading Level (dBuV)	Over Limit (dB)	Limit (dBuV/m)	Factor (dB)	Type
1		*	5782.820	109.519	101.579	N/A	N/A	7.940	PK
2			5850.000	66.403	58.269	-11.797	78.200	8.134	AV
3			5860.000	63.530	55.341	-4.670	68.200	8.189	PK

Note: Measure Level (dBμV/m) = Reading Level (dBμV) + Factor (dB)

Factor (dB) = Cable Loss (dB) + Antenna Factor (dB/m) – Pre\_Amplifier Gain (dB).

## 8. PEAK POWER SPECTRAL DENSITY

### 8.1 LIMIT

According to §15.407(a)

For an outdoor access point operating in the band 5.15-5.25 GHz, the maximum conducted output power over the frequency band of operation shall not exceed 1 W provided the maximum antenna gain does not exceed 6 dBi. In addition, the maximum power spectral density shall not exceed 17 dBm in any 1 megahertz band.

For the band 5.725-5.85 GHz, the maximum power spectral density shall not exceed 30 dBm in any 500-kHz band. If transmitting antennas of directional gain greater than 6 dBi are used, the maximum power spectral density shall be reduced by the amount in dB that the directional gain of the antenna exceeds 6 dBi.

5.15-5.25 GHz: Limit (dBm/MHz) = 17dBm/MHz.

5.725-5.85 GHz Limit (dBm/500kHz) = 30dBm/500kHz.

### 8.2. Test Procedure Used

KDB 789033 D02v01 - Section F

### 8.3. Test Setting

1. Analyzer was set to the center frequency of the UNII channel under investigation
2. Span was set to encompass the entire 26dB EBW of the signal.
3. RBW = 1MHz, if measurement bandwidth of Maximum PSD is specified in 500 kHz,  
RBW = 100 kHz
4. VBW = 3MHz
5. Number of sweep points  $\geq 2 \times (\text{span} / \text{RBW})$
6. Detector = power averaging (RMS)
7. Sweep time = auto
8. Trigger = free run
9. Use the peak search function on the instrument to find the peak of the spectrum and record its value

10. Add  $10 \cdot \log(1/x)$ , where  $x$  is the duty cycle, to the measured power in order to compute the average power during the actual transmission times (because the measurement represents an average over both the on and off times of the transmission). For example, add  $10 \cdot \log(1/0.25) = 6$  dB if the duty cycle is 25 percent.
11. When the measurement bandwidth of Maximum PSD is specified in 500 kHz, add a constant factor  $10 \cdot \log(500\text{kHz}/100\text{kHz}) = 6.99$  dB to the measured result

#### 8.4. Test Setup

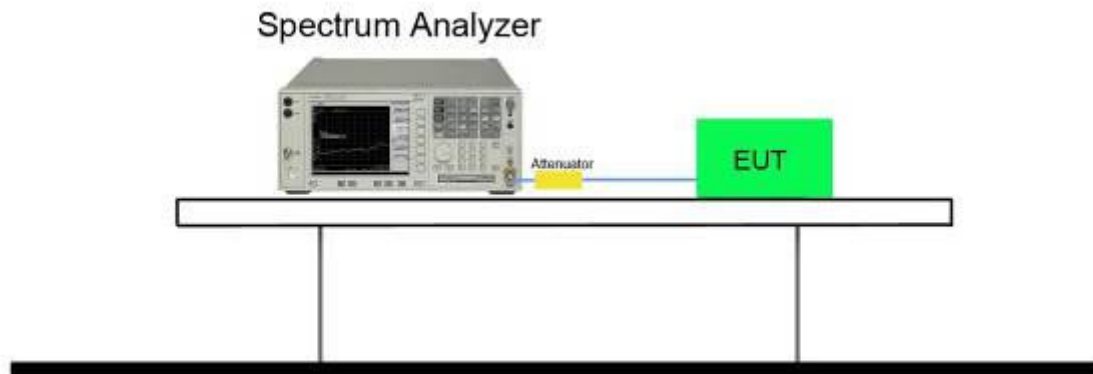

#### 8.5 TEST RESULTS

*No non-compliance noted*



Mode	Test CH	PSD (dBm)	Total PSD (dBm)	Limit (dBm)	Result
802.11a	Lowest	4.56	11.55	30	Pass
	Middle	4.59	11.58	30	Pass
	Highest	4.81	11.8	30	Pass
802.11n 20	Lowest	4.32	11.31	30	Pass
	Middle	4.22	11.21	30	Pass
	Highest	3.56	10.55	30	Pass
802.11n 40	Lowest	0.60	7.59	30	Pass
	Highest	0.23	7.22	30	Pass
802.11ac 20	Lowest	3.07	10.06	30	Pass
	Middle	2.99	9.98	30	Pass
	Highest	2.44	9.43	30	Pass
802.11ac 40	Lowest	-0.63	6.36	30	Pass
	Highest	-1.55	5.44	30	Pass

Note: The Total PSD Level =  $10 \cdot \log(10^{\text{PSD}/10})$

# IEEE 802.11a mode / 5745 ~ 5825MHz

## CH Low

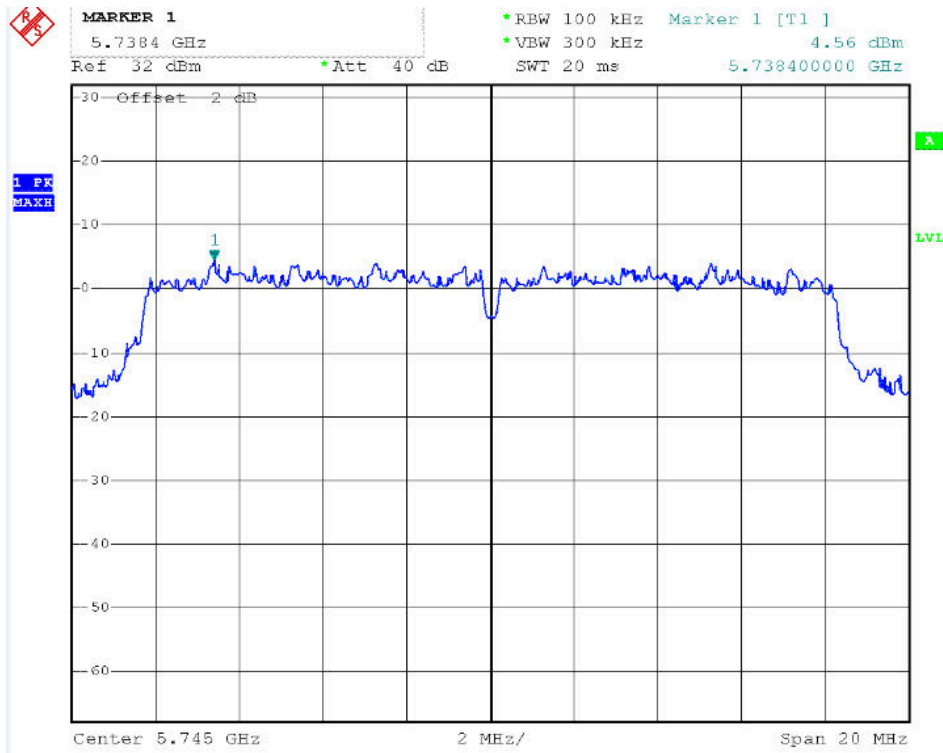

## CH Mid

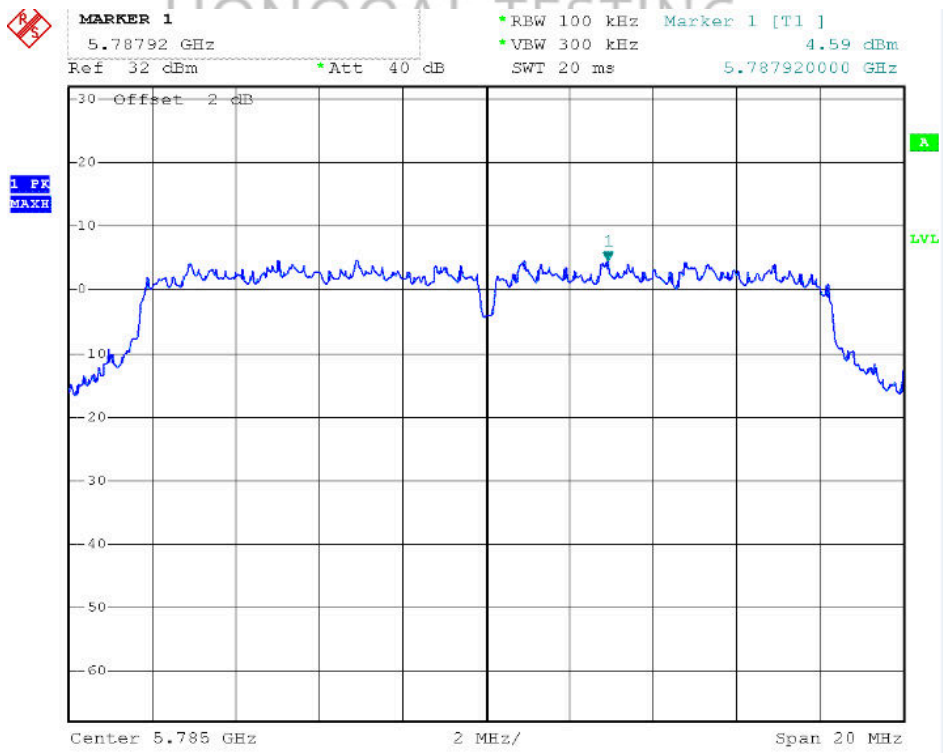

### CH High

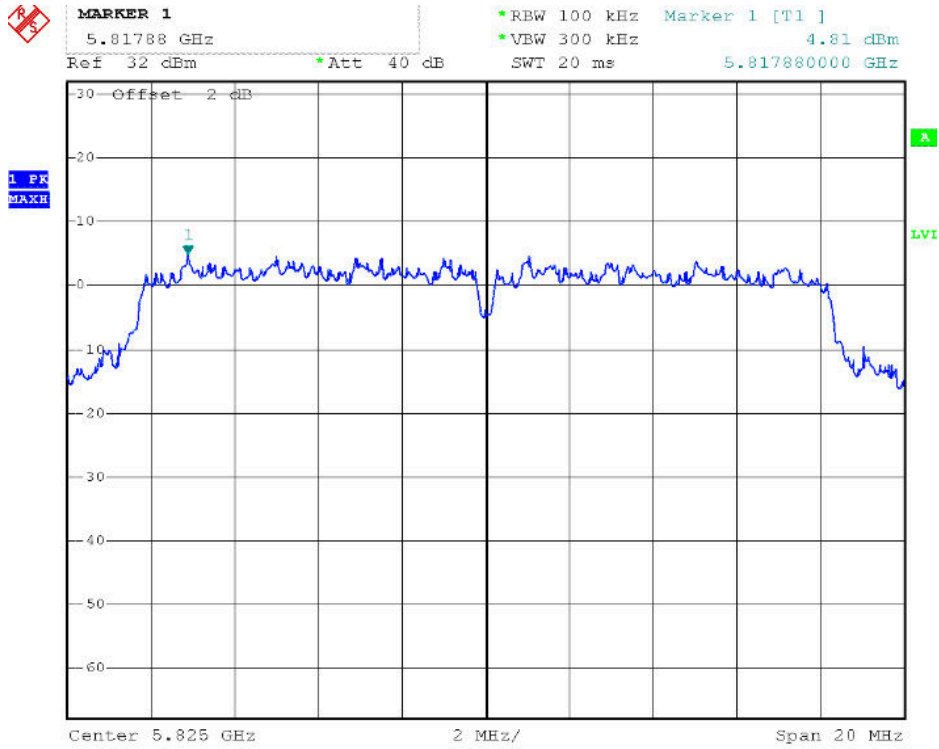

### IEEE 802.11n HT 20 MHz Channel mode / 5745 ~ 5825MHz

### CH Low

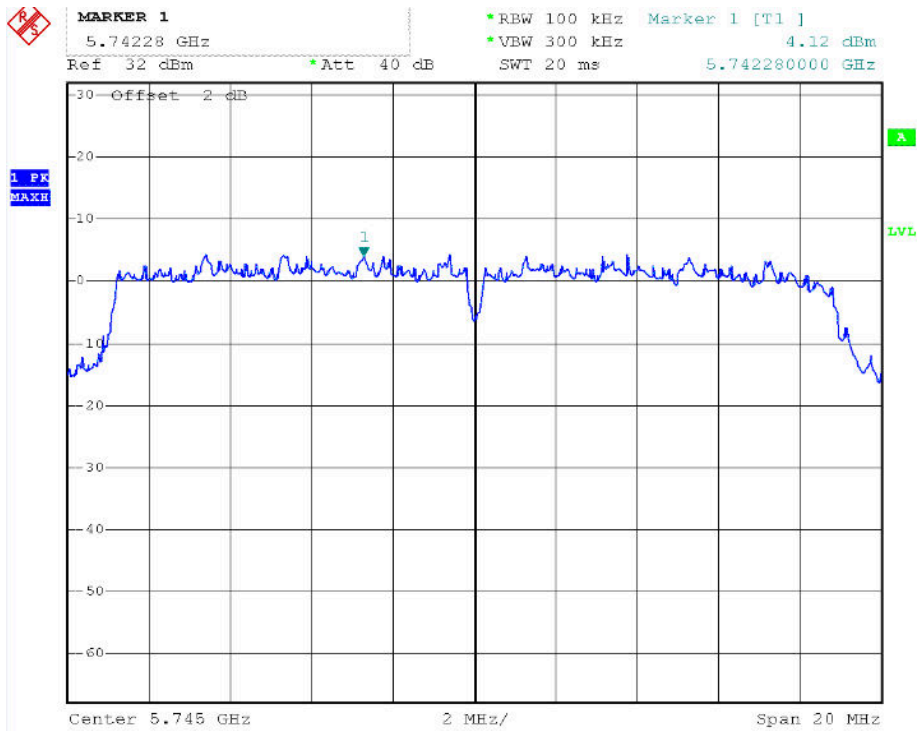

### CH Mid

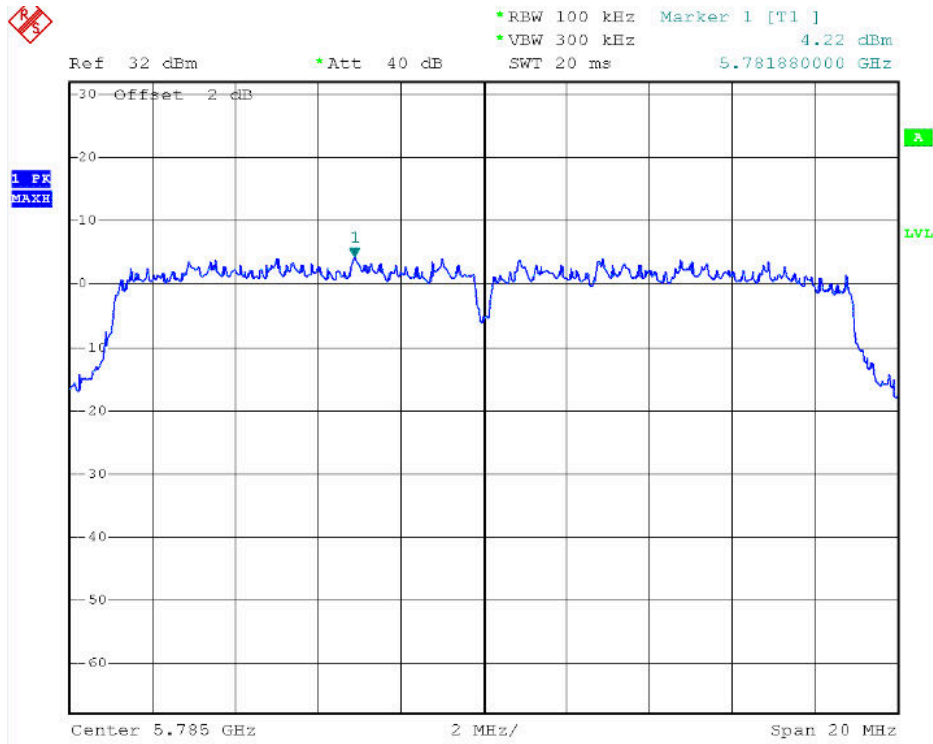

### CH High

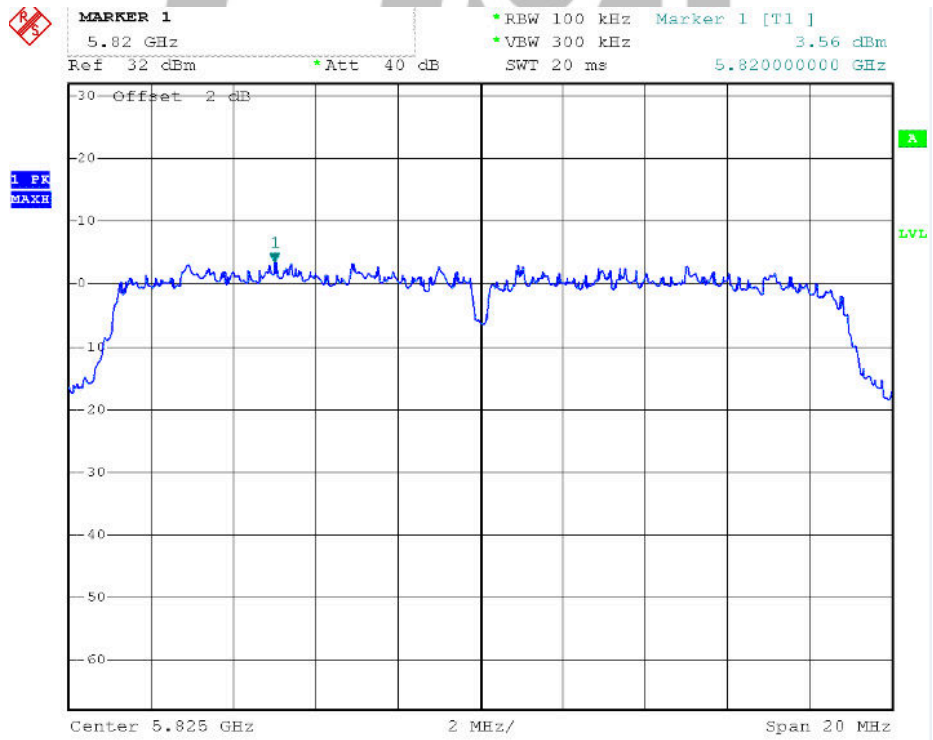

# IEEE 802.11n HT 40 MHz Channel mode / 5755 ~ 5795MHz

## CH Low

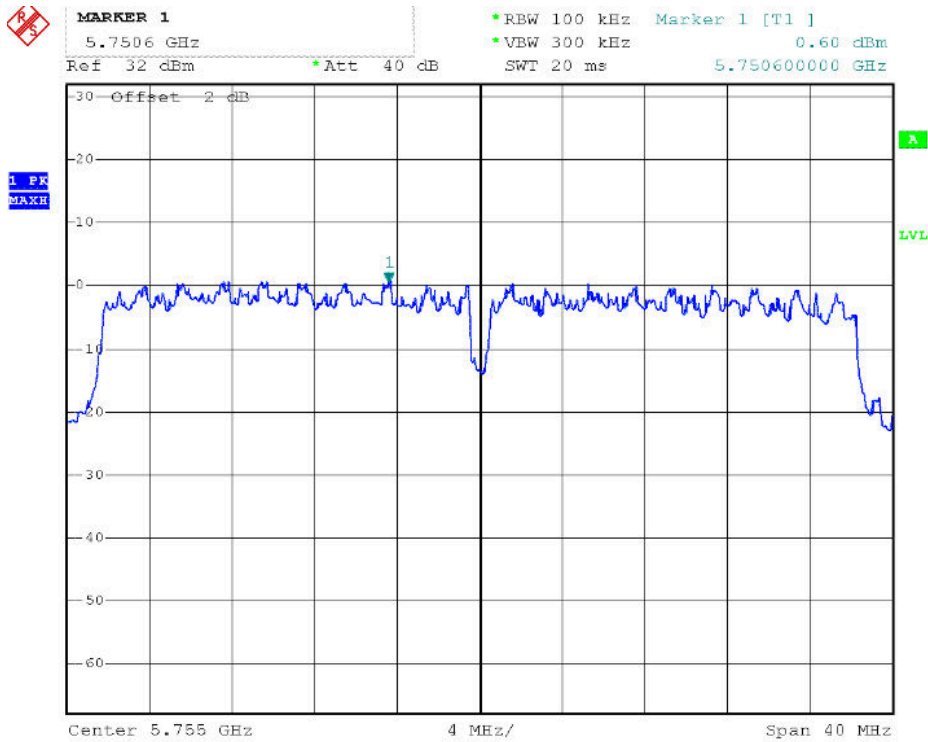

## CH High

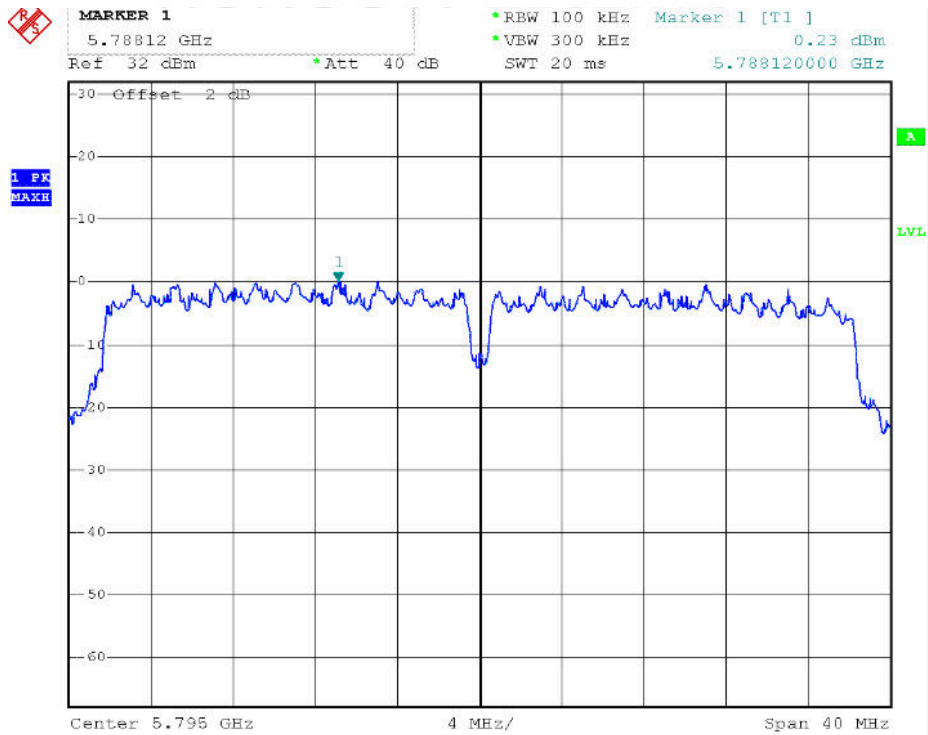

### IEEE 802.11ac HT 20 MHz Channel mode / 5745 ~ 5825MHz

#### CH Low

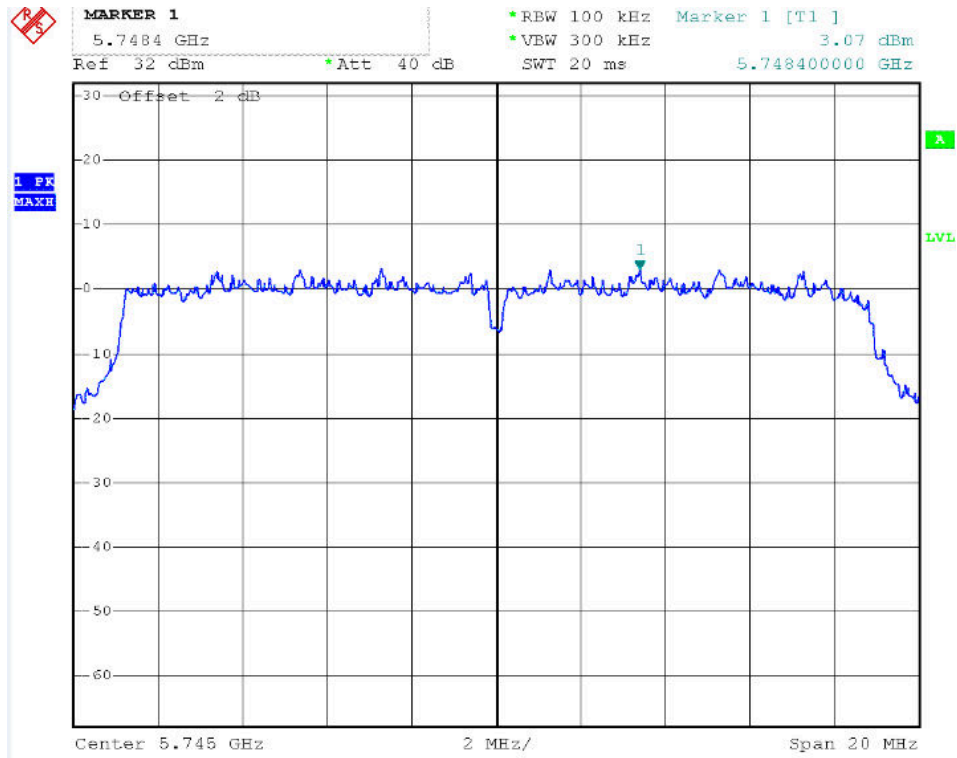

#### CH Mid

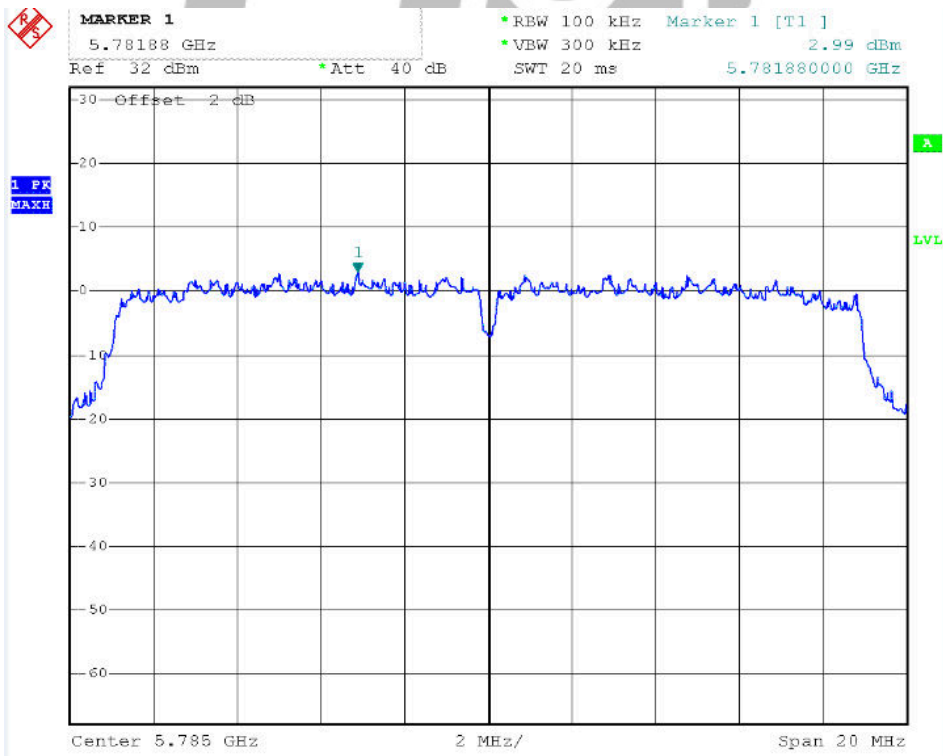

### CH High

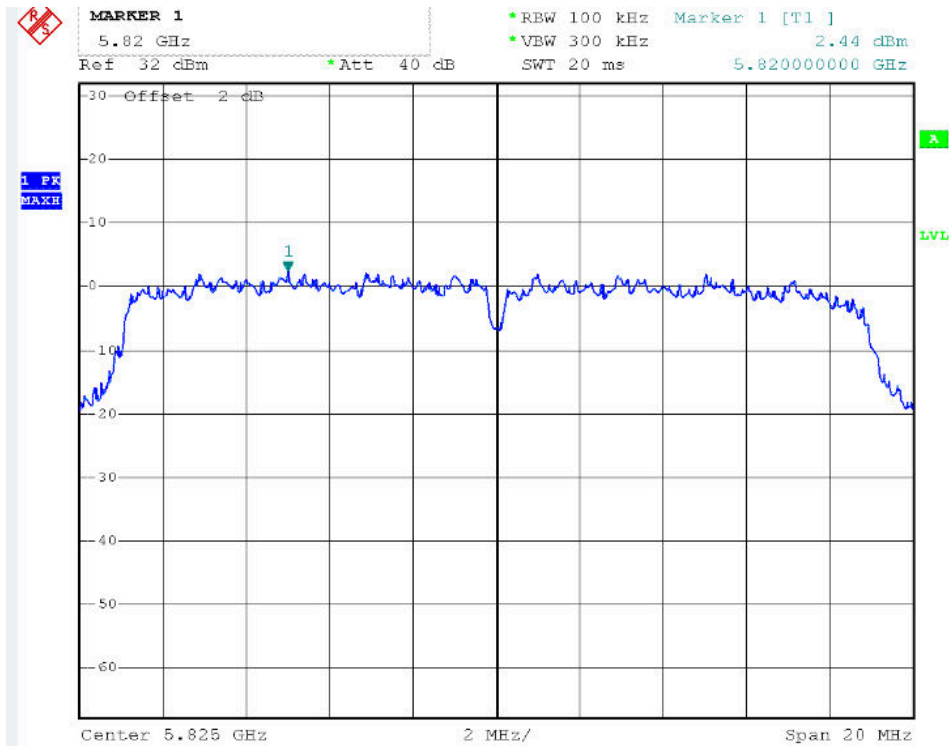

### IEEE 802.11ac HT 40 MHz Channel mode / 5745 ~ 5825MHz

### CH Low

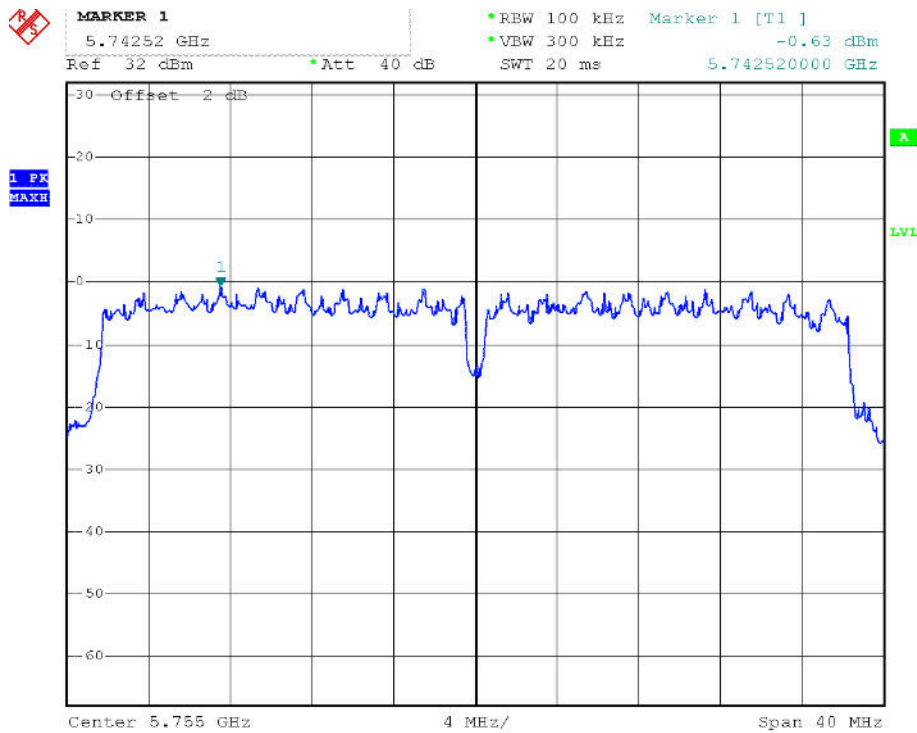

**CH High**

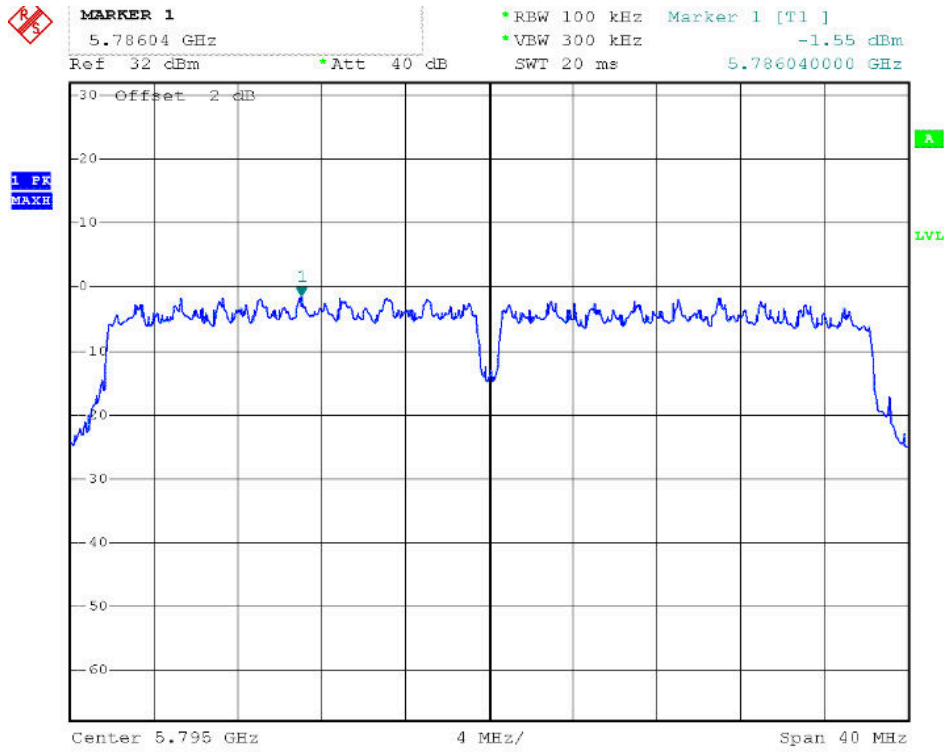



## 9. 6dB Bandwidth Measurement

### 9.1. Test Limit

The minimum 6dB bandwidth shall be at least 500 kHz.

### 9.2. Test Procedure used

KDB 789033 D02v01 – Section C.2

### 9.3. Test Setting

1. Set center frequency to the nominal EUT channel center frequency.
2. RBW = 100 kHz.
3. VBW  $\geq 3 \times$  RBW.
4. Detector = Peak.
5. Trace mode = max hold.
6. Sweep = auto couple.
7. Allow the trace to stabilize.
8. Measure the maximum width of the emission that is constrained by the frequencies associated with the two outermost amplitude points (upper and lower frequencies) that are attenuated by 6 dB relative to the maximum level measured in the fundamental emission.

#### 7.3.4. Test Setup

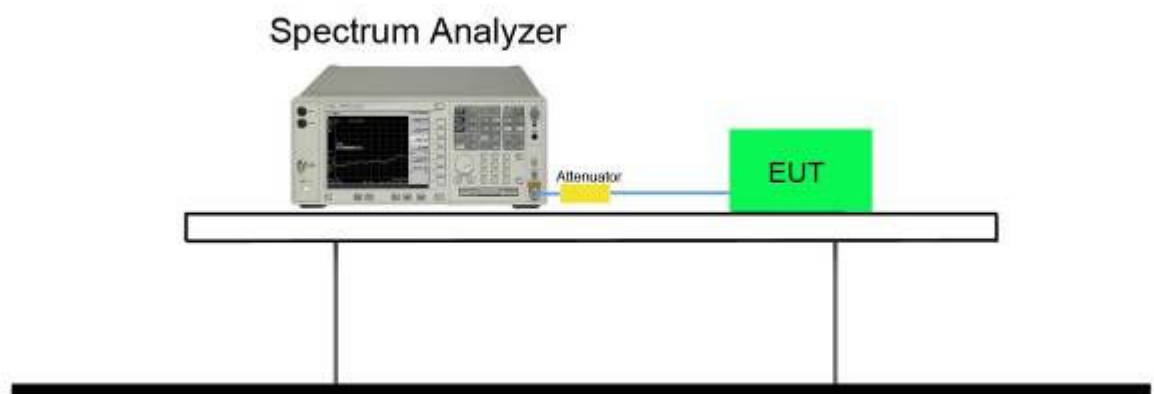

## TEST RESULTS

*No non-compliance noted*

**Chain 1**

Test CH	6dB Bandwidth (MHz)					Limit(kHz)	Result
	802.11a	802.11n20	802.11n40	802.11ac20	802.11ac40		
Lowest	16.44	17.60	36.80	17.6	36.48	>500	Pass
Middle	16.40	17.76	---	17.76	---		
Highest	16.40	17.68	36.48	17.44	36.64		

Test plot as follows:



### 6dB BANDWIDTH ( 802.11a MODE CH Low 5745MHz)

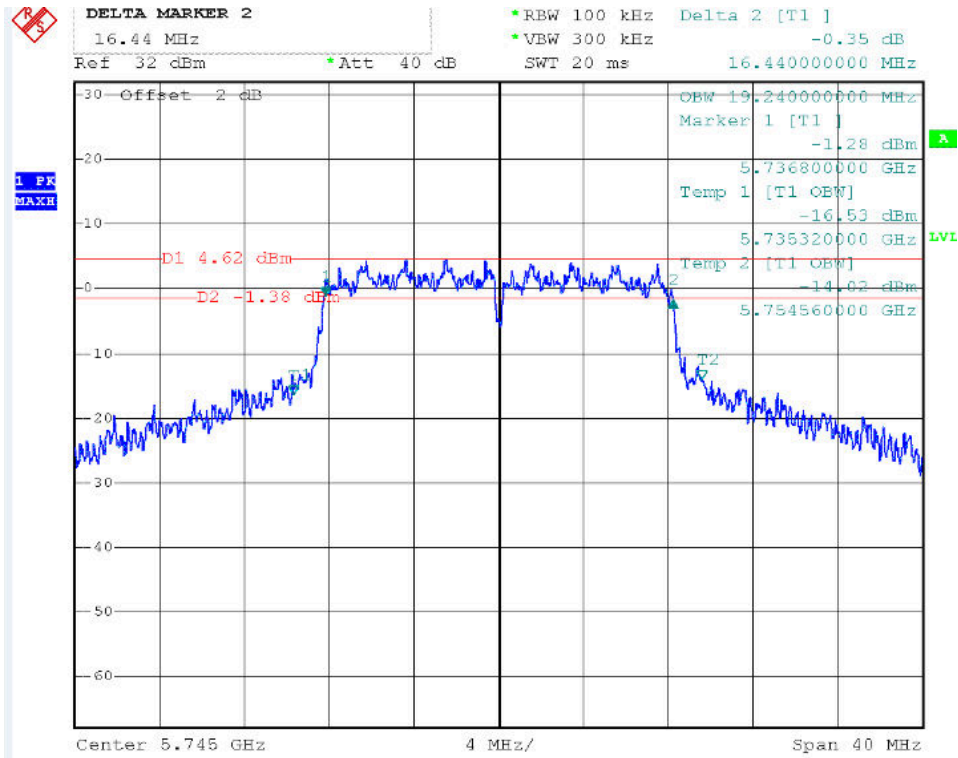

### 6dB BANDWIDTH ( 802.11a MODE CH Mid 5785MHz)

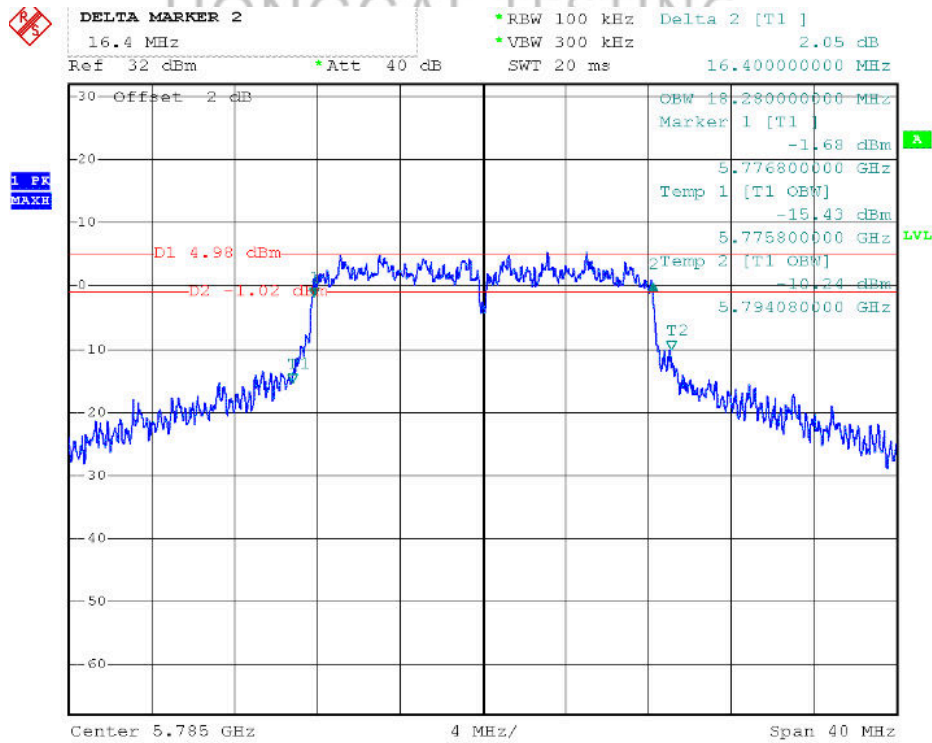

### 6dB BANDWIDTH ( 802.11a MODE CH High 5825MHz)

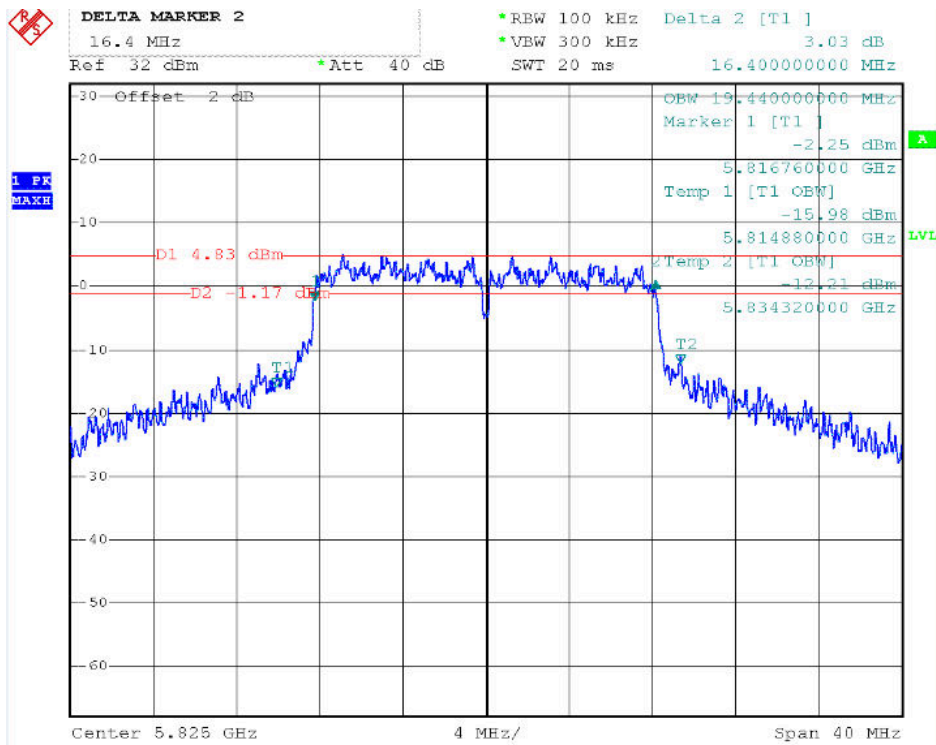

### 6dB BANDWIDTH ( 802.11n HT20 MODE CH Low 5745MHz)

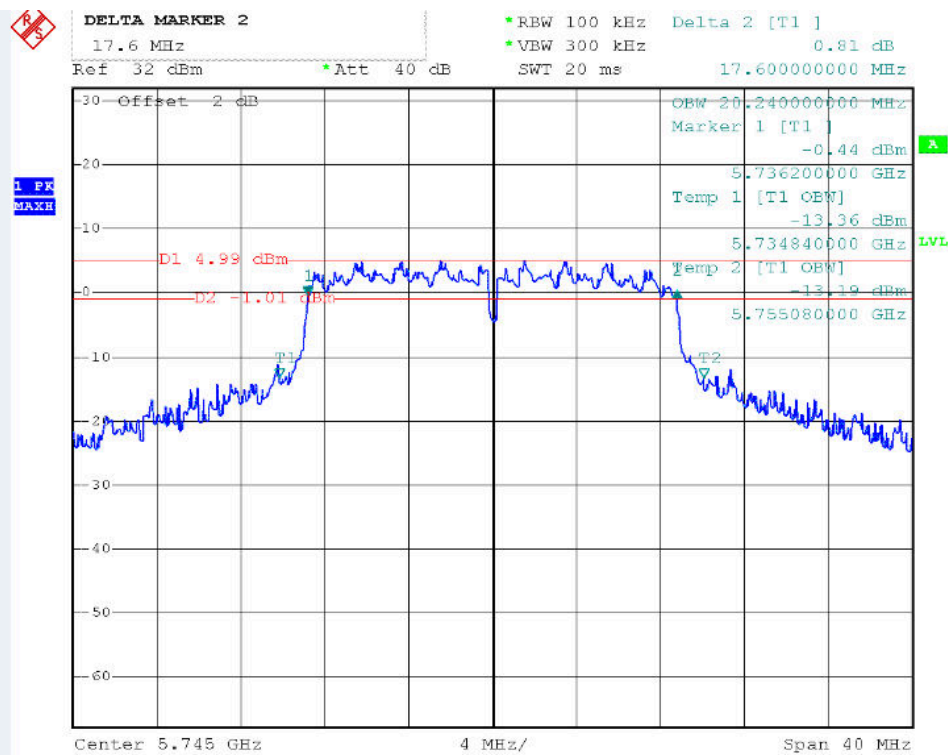

### 6dB BANDWIDTH ( 802.11n HT20 MODE CH High 5785MHz)

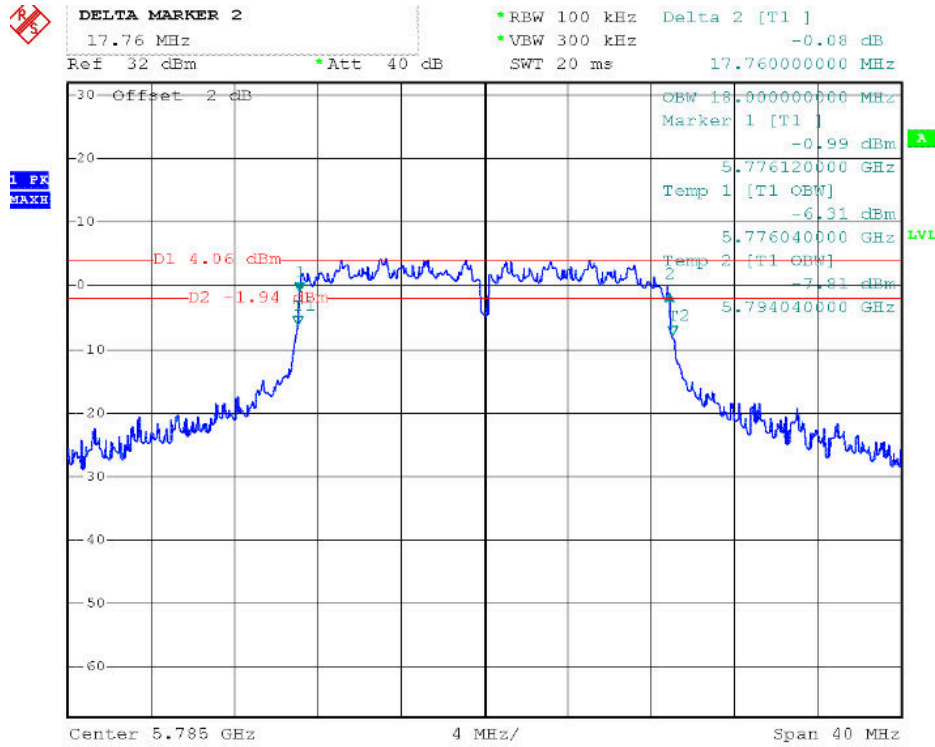

### 6dB BANDWIDTH ( 802.11n HT20 MODE CH High 5825MHz)

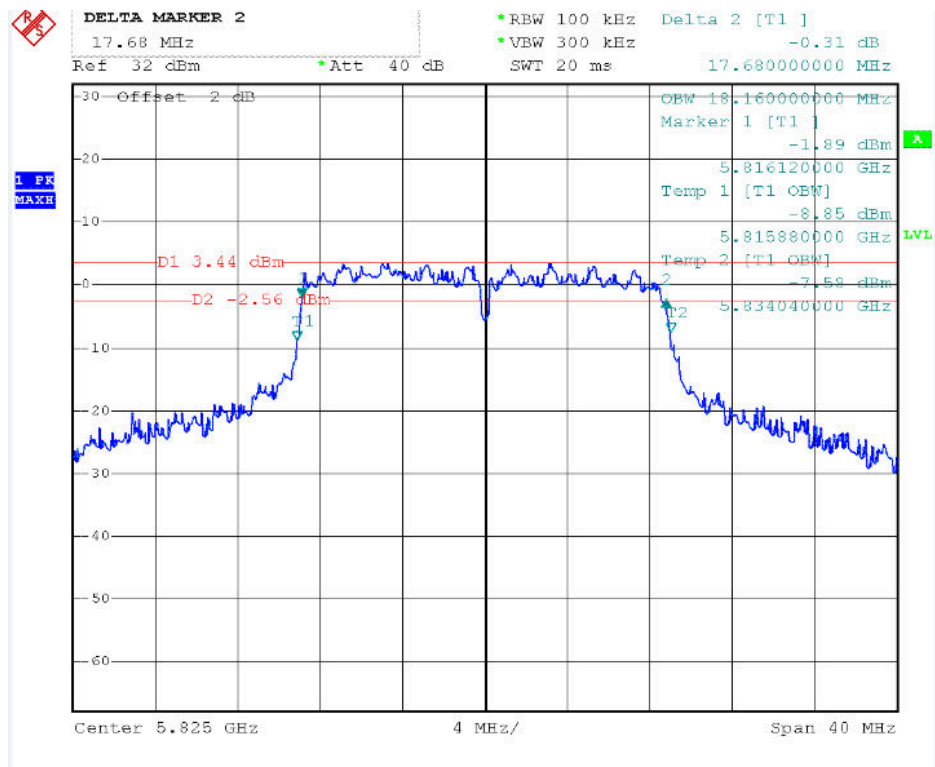

### 6dB BANDWIDTH ( 802.11n HT40 MODE CH Low 5755MHz)

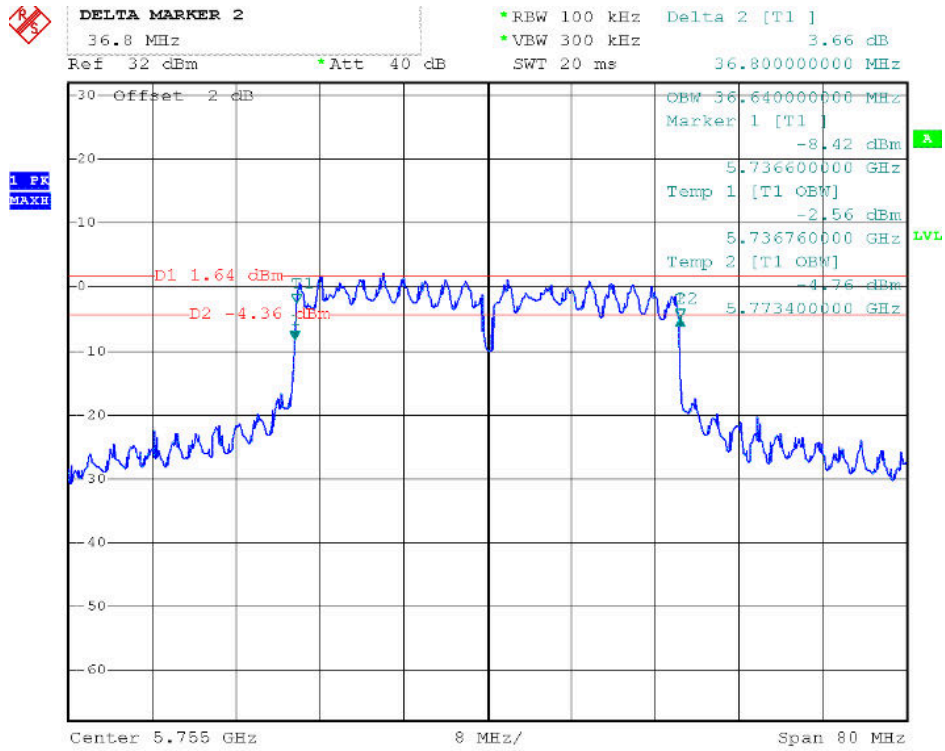

### 6dB BANDWIDTH ( 802.11n HT40 MODE CH High 5795MHz)

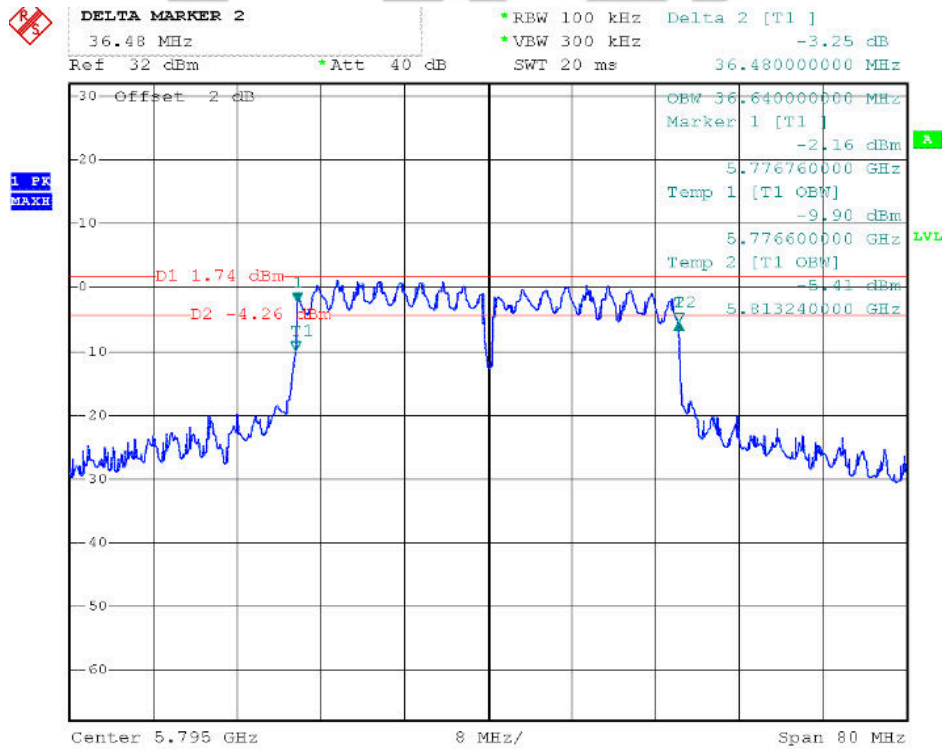

### 6dB BANDWIDTH ( 802.11ac HT20 MODE CH Low 5745MHz)

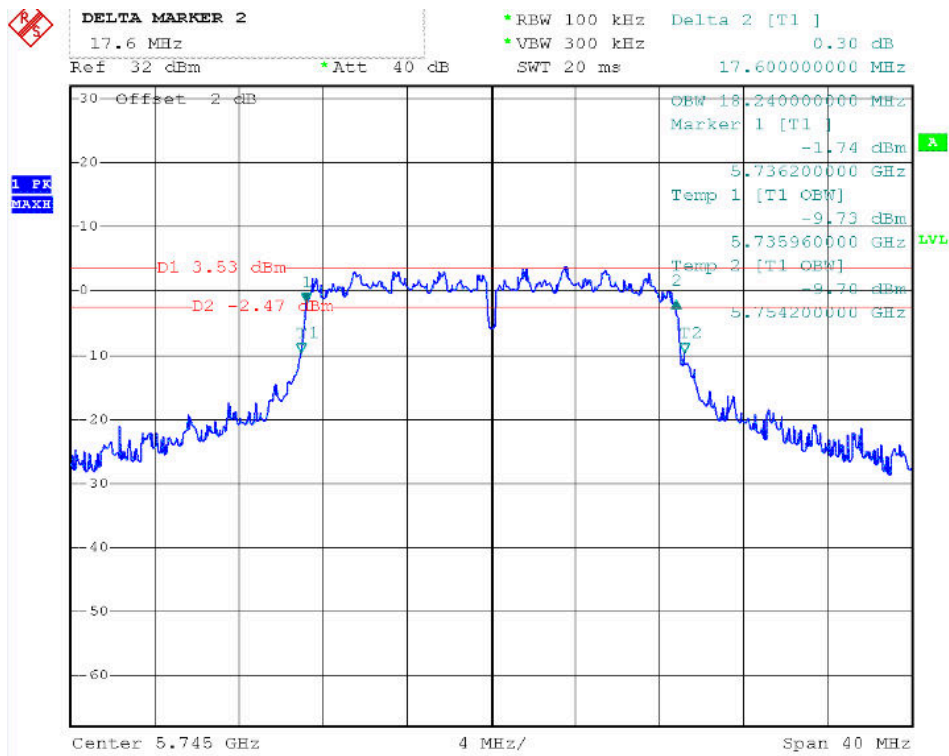

### 6dB BANDWIDTH ( 802.11ac HT20 MODE CH Mid 5785MHz)

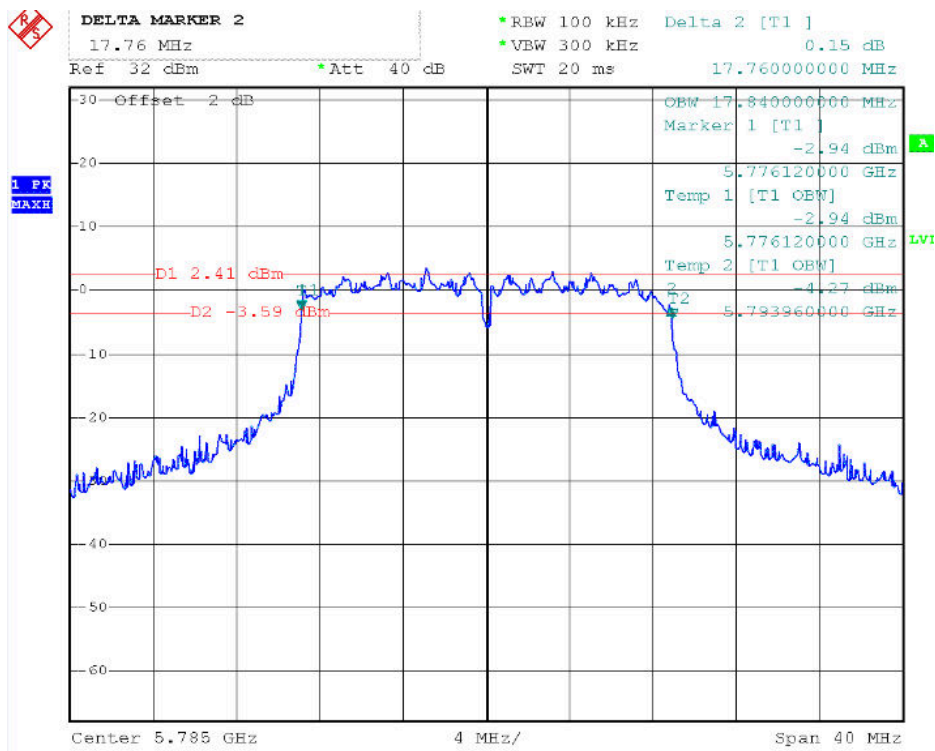

### 6dB BANDWIDTH ( 802.11ac HT20 MODE CH High 5825MHz)

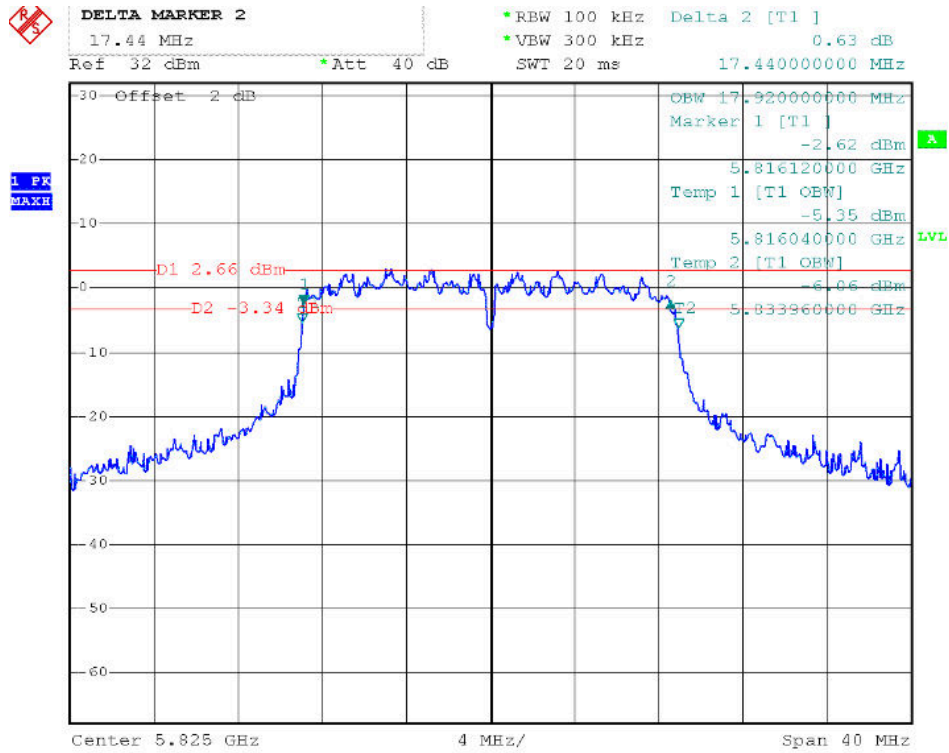

### 6dB BANDWIDTH ( 802.11ac HT40 MODE CH Low 5755MHz)

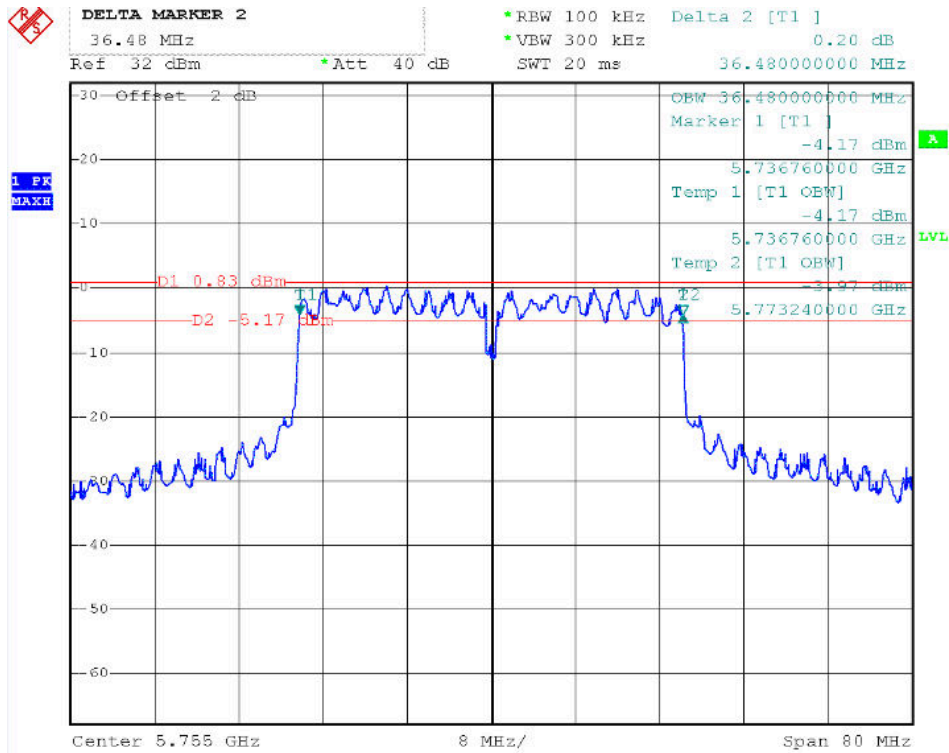



### 6dB BANDWIDTH ( 802.11ac HT40 MODE CH High 5795MHz)

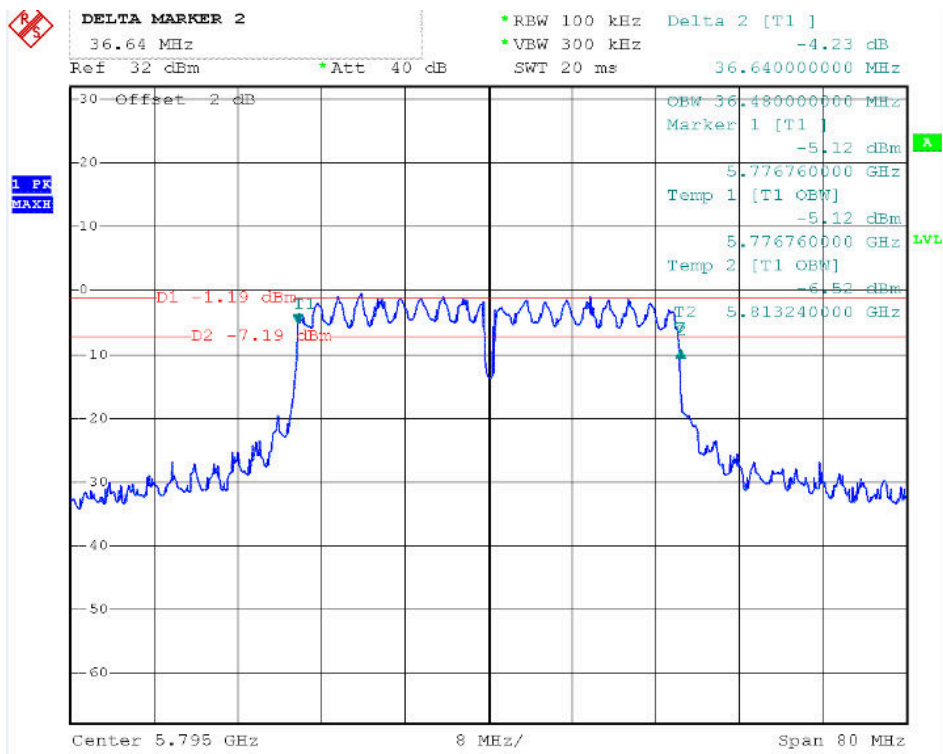

## 10. RADIATED UNDESIRABLE EMISSION

### 10.1. Test Limit

All out of band emissions appearing in a restricted band as specified in Section 15.205 of the Title 47 CFR must not exceed the limits shown in Table per Section 15.209.

FCC Part 15 Subpart C Paragraph 15.209		
Frequency [MHz]	Field Strength [V/m]	Measured Distance [Meters]
0.009 – 0.490	2400/F (kHz)	300
0.490 – 1.705	24000/F (kHz)	30
1.705 - 30	30	30
30 - 88	100	3
88 - 216	150	3
216 - 960	200	3
Above 960	500	3

HONGCAI TESTING

### 10.2. Test Procedure Used

KDB 789033 D02v01 – Section G

### 10.3. Test Setting

#### Peak Measurements above 1GHz

1. Analyzer center frequency was set to the frequency of the radiated spurious emission of interest
2. RBW = 1MHz
3. VBW = 3MHz
4. Detector = peak
5. Sweep time = auto couple
6. Trace mode = max hold
7. Trace was allowed to stabilize

### **Quasi-Peak Measurements below 1GHz**

1. Analyzer center frequency was set to the frequency of the radiated spurious emission of interest
2. Span was set greater than 1MHz
3. RBW = 120 kHz
4. Detector = CISPR quasi-peak
5. Sweep time = auto couple
6. Trace was allowed to stabilize

### **Average Measurements above 1GHz (Method AD)**

1. Analyzer center frequency was set to the frequency of the radiated spurious emission of interest
2. RBW = 1MHz
3. VBW = 3MHz
4. Detector = power average (RMS)
5. Number of measurement points = 1001 (Number of points must be  $> 2 \times \text{span}/\text{RBW}$ )
6. Sweep time = auto
7. Trace was averaged over at 100 sweeps

#### **7.7.4. Test Setup**

##### 9kHz ~ 30MHz Test Setup:

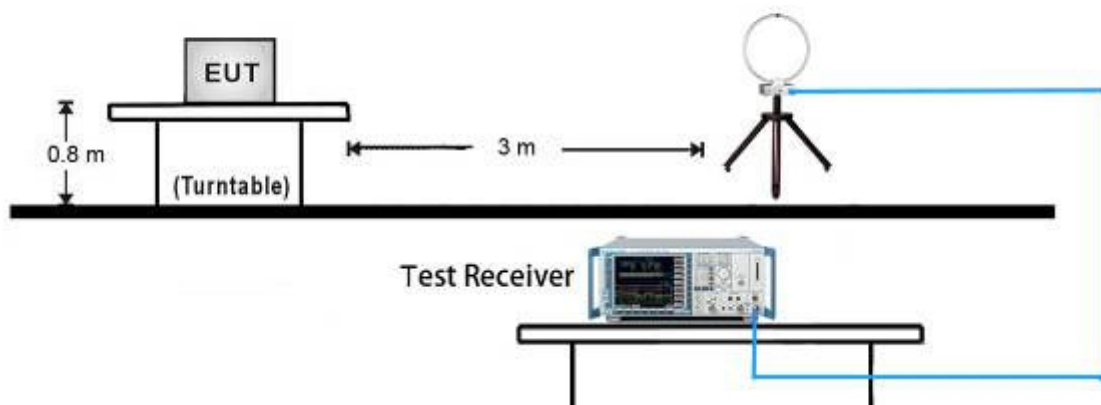

30MHz ~ 1GHz Test Setup:

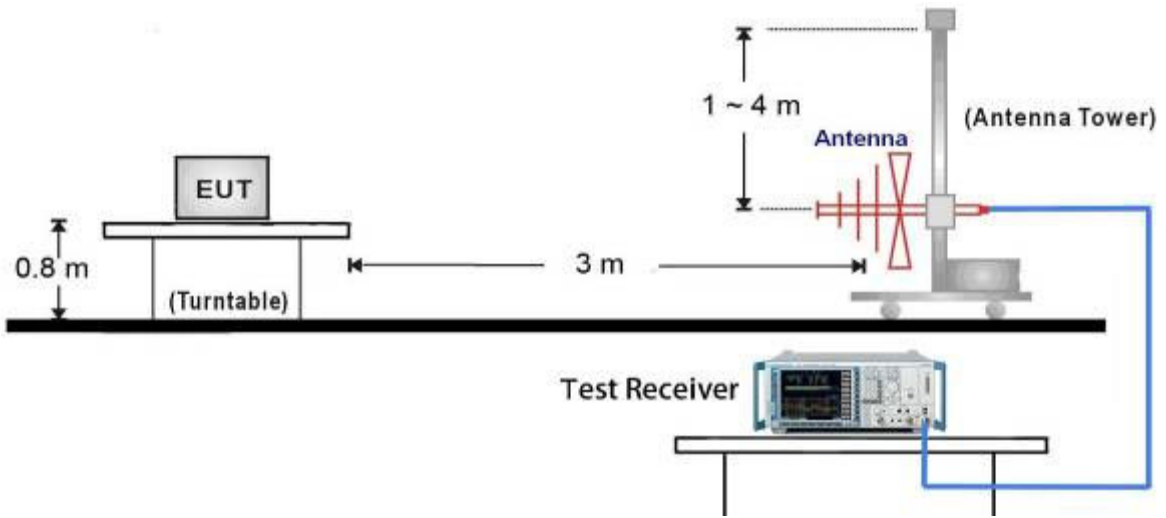

1GHz ~ 18GHz Test Setup:

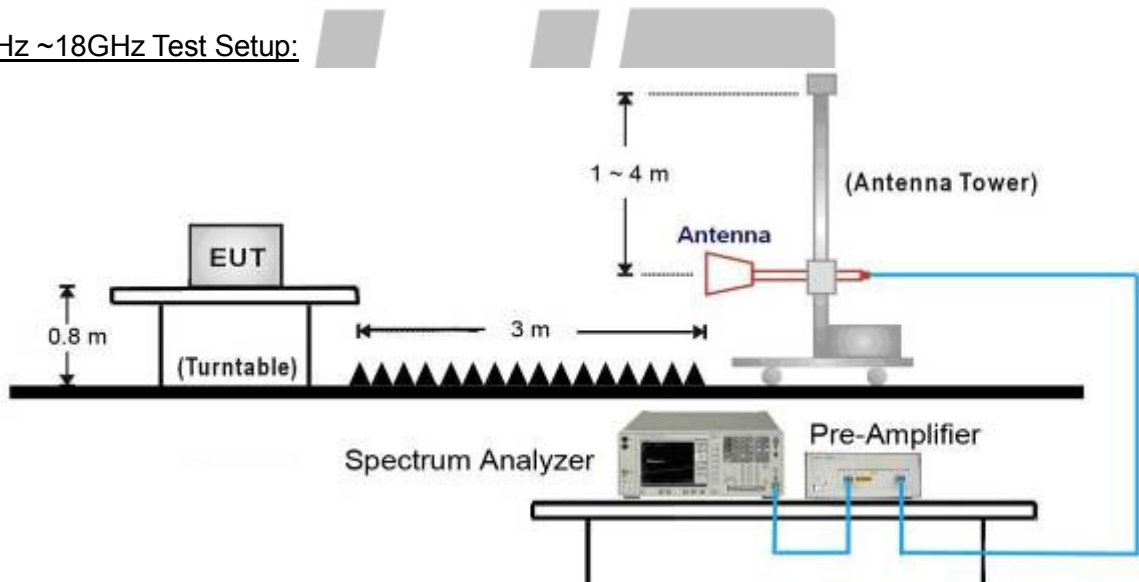

18GHz ~ 40GHz Test Setup:

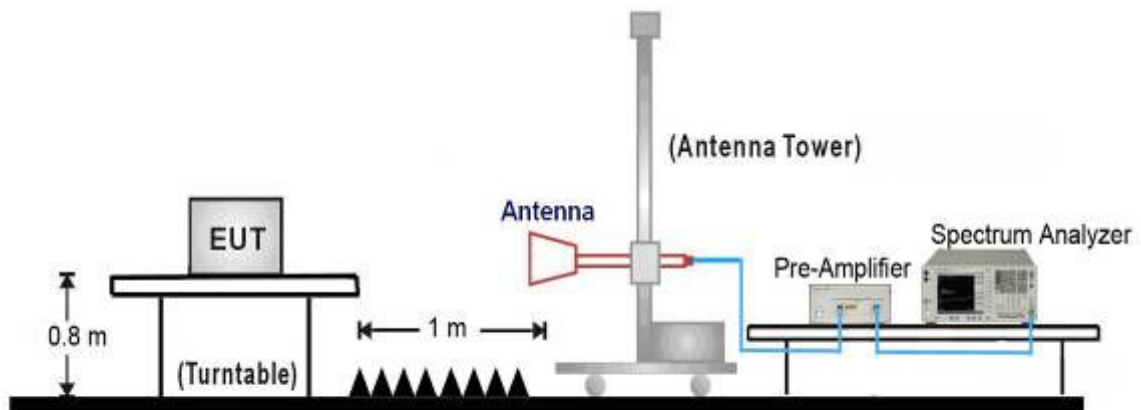

**Below 30 MHz**

**Operation Mode:** Normal Link  
**Temperature:** 25°C  
**Humidity:** 50% RH

**Test Date:** 2016-7-19  
**Tested by:** Haiqing.Zhao  
**Polarity:** Ver. / Hor.

Frequency (MHz)	Reading (dBuV)	Correction Factor (dB/m)	Result (dBuV/m)	Limit (dBuV/m)	Margin (dB)	Remark
0.17	46.78	32.87	79.65	116.82	-37.17	Peak
0.21	45.66	31.54	77.19	113.99	-36.80	Peak
0.27	43.08	29.75	72.83	109.36	-36.53	Peak
0.36	40.34	28.22	68.56	103.29	-34.73	Peak
0.41	38.86	27.23	66.09	99.35	-33.27	Peak
0.46	37.28	26.32	63.61	95.77	-32.16	Peak
6.00	14.30	7.12	21.42	69.50	-48.08	Peak
9.44	10.60	6.32	16.92	69.50	-52.58	Peak
13.28	10.41	5.77	16.18	69.50	-53.32	Peak
17.46	7.51	5.47	12.98	69.50	-56.52	Peak
21.79	8.40	5.42	13.82	69.50	-55.68	Peak
27.93	9.32	6.10	15.41	69.50	-54.09	Peak

**Remark:**

- Radiated emissions measured in frequency range from 9kHz ~ 30MHz were made with an instrument using peak/quasi-peak detector mode.*
- Quasi-peak test would be performed if the peak result were greater than the quasi-peak limit or as required by the applicant.*
- Data of measurement within this frequency range shown “ --- ” in the table above means the reading of emissions are attenuated more than 20dB below the permissible limits or the field strength is too small to be measured.*
- Measurements above show only up to 6 maximum emissions noted, or would be lesser, with “ N/A ” remark, if no specific emissions from the EUT are recorded (ie: margin>20dB from the applicable limit) and considered that's already beyond the background noise floor.*
- Margin (dB) = Remark result (dBuV/m) – Quasi-peak limit (dBuV/m).*

**Below 1 GHz**

**Operation Mode:** Normal Link

**Temperature:** 25°C

**Humidity:** 50% RH

**Test Date:** 2016-7-19

**Tested by:** Haiqing.Zhao

**Polarity:** Ver. / Hor.

Frequency (MHz)	Reading (dBuV)	Correction Factor (dB/m)	Result (dBuV/m)	Limit (dBuV/m)	Margin (dB)	Remark	Ant.Pol. (H/V)
41.32	47.26	-12.67	34.59	40.00	-5.41	Peak	V
78.50	43.24	-16.75	26.48	40.00	-13.52	Peak	V
384.05	31.94	-9.58	22.35	46.00	-23.65	Peak	V
479.43	35.01	-8.27	26.74	46.00	-19.26	Peak	V
527.93	32.48	-7.69	24.80	46.00	-21.20	Peak	V
799.53	31.70	-3.88	27.82	46.00	-18.18	Peak	V
191.67	43.20	-12.69	30.50	43.50	-13.00	Peak	H
240.17	46.91	-13.10	33.81	46.00	-12.19	Peak	H
299.98	41.68	-10.82	30.86	46.00	-15.14	Peak	H
359.80	44.75	-9.99	34.76	46.00	-11.24	Peak	H
419.62	50.41	-9.03	41.38	46.00	-4.62	Peak	H
799.53	40.07	-3.88	36.19	46.00	-9.81	Peak	H

**Remark:**

- 1 Measuring frequencies from 30 MHz to the 1GHz.
- 2 Radiated emissions measured in frequency range from 30 MHz to 1000MHz were made with an instrument using peak/quasi-peak detector mode.
- 3 Quasi-peak test would be performed if the peak result were greater than the quasi-peak limit or as required by the applicant.
- 4 Measurements above show only up to 6 maximum emissions noted, or would be lesser, with " N/A " remark, if no specific emissions from the EUT are recorded (ie: margin>20dB from the applicable limit) and considered that's already beyond the background noise floor.
- 5 Margin (dB) = Remark result (dBuV/m) – Quasi-peak limit (dBuV/m).

**Above 1 GHz**

**Operation Mode:** Tx / IEEE 802.11a mode / 5745 ~ 5825MHz  
 CH Low

**Temperature:** 25°C

**Humidity:** 50% RH

**Test Date:** 2016-7-19

**Tested by:** Haiqing.Zha

**Polarity:** Ver. / Hor.

Frequency (MHz)	Reading (Peak)	Reading (Average) (dBuV)	Correction Factor (dB/m)	Result (Peak) (dBuV/m)	Result (Average)	Limit (Peak) (dBuV/m)	Limit (Average)	Margin (dB)	Remark	Ant.Pol. (H/V)
1658.33	53.78	---	-8.99	44.79	---	68.3	54	-23.51	Peak	V
11490.00	38.96	31.36	18.68	57.64	50.04	68.3	54	-3.96	AVG	V
N/A										
1400.67	49.91	41.12	-10.66	39.25	30.46	68.3	54	-23.54	AVG	H
11490.67	39.18	29.74	18.68	57.86	48.42	68.3	54	-5.58	AVG	H
N/A										

**Remark:**

1. Measuring frequencies from 1 GHz to the 10th harmonic of highest fundamental frequency.
2. Radiated emissions measured in frequency above 1000MHz were made with an instrument using peak/average detector mode.
3. Average test would be performed if the peak result were greater than the average limit.
4. Data of measurement within this frequency range shown “ --- ” in the table above means the reading of emissions are attenuated more than 20dB below the permissible limits or the field strength is too small to be measured.
5. Measurements above show only up to 6 maximum emissions noted, or would be lesser, with “ N/A ” remark, if no specific emissions from the EUT are recorded (ie: margin>20dB from the applicable limit) and considered that's already beyond the background noise floor.
6. Margin (dB) = Remark result (dBuV/m) – Average limit (dBuV/m).

Tx / IEEE 802.11a mode / 5745 ~ 5825MHz

**Operation Mode:** CH Mid

**Test Date:** 2016-7-19

**Temperature:** 25°C

**Tested by:** Haiqing.Zha

**Humidity:** 50% RH

**Polarity:** Ver. / Hor.

Frequency (MHz)	Reading (Peak) (dBuV)	Reading (Average)	Correction Factor (dB/m)	Result (Peak) (dBuV/m)	Result (Average)	Limit (Peak) (dBuV/m)	Limit (Average)	Margin (dB)	Remark	Ant.Pol. (H/V)
1863.33	53.26	---	-6.86	46.4	---	68.3	54	-21.9	Peak	V
11570.33	38.78	31.22	18.77	57.55	49.99	68.3	54	-4.01	AVG	V
1396.67	52.89	42.12	-10.66	42.23	31.46	68.3	54	-22.54	AVG	H
11570.33	39.8	30.36	18.77	58.57	49.13	68.3	54	-4.87	AVG	H
N/A										

**Remark:**

1. Measuring frequencies from 1 GHz to the 10th harmonic of highest fundamental frequency.
2. Radiated emissions measured in frequency above 1000MHz were made with an instrument using peak/average detector mode.
3. Average test would be performed if the peak result were greater than the average limit.
4. Data of measurement within this frequency range shown “ --- ” in the table above means the reading of emissions are attenuated more than 20dB below the permissible limits or the field strength is too small to be measured.
5. Measurements above show only up to 6 maximum emissions noted, or would be lesser, with “ N/A ” remark, if no specific emissions from the EUT are recorded (ie: margin>20dB from the applicable limit) and considered that's already beyond the background noise floor.
6. Margin (dB) = Remark result (dBuV/m) – Average limit (dBuV/m).



**Operation Mode:** Tx / IEEE 802.11a mode / 5745 ~ 5825MHz  
**Temperature:** 25°C  
**Humidity:** 50% RH

**Test Date:** 2016-7-19  
**Tested by:** Haiqing.Zhao  
**Polarity:** Ver. / Hor.

Frequency (MHz)	Reading (Peak) (dBuV)	Reading (Average)	Correction Factor (dB/m)	Result (Peak) (dBuV/m)	Result (Average)	Limit (Peak) (dBuV/m)	Limit (Average)	Margin (dB)	Remark	Ant.Pol. (H/V)
1921.67	50.87	---	-6.27	44.6	---	68.3	54	-23.7	Peak	V
11650.33	41.88	31.23	18.86	60.74	50.09	68.3	54	-3.91	AVG	V
N/A										
1396.67	60.48	42.31	-10.66	49.82	31.65	68.3	54	-22.35	AVG	H
11650.33	44.22	30.21	18.86	63.08	49.07	68.3	54	-4.93	AVG	H
N/A										

**Remark:**

1. Measuring frequencies from 1 GHz to the 10th harmonic of highest fundamental frequency.
2. Radiated emissions measured in frequency above 1000MHz were made with an instrument using peak/average detector mode.
3. Average test would be performed if the peak result were greater than the average limit.
4. Data of measurement within this frequency range shown “ --- ” in the table above means the reading of emissions are attenuated more than 20dB below the permissible limits or the field strength is too small to be measured.
5. Measurements above show only up to 6 maximum emissions noted, or would be lesser, with “ N/A ” remark, if no specific emissions from the EUT are recorded (ie: margin>20dB from the applicable limit) and considered that's already beyond the background noise floor.
6. Margin (dB) = Remark result (dBuV/m) – Average limit (dBuV/m).

**Operation Mode:** Tx / IEEE 802.11n HT 20 MHz  
 5745 ~ 5825MHz /CH Low  
**Temperature:** 25°C  
**Humidity:** 50% RH

**Test Date:** 2016-7-19  
**Tested by:** Haiqing.Zh  
**Polarity:** Ver. / Hor.

Frequency (MHz)	Reading (Peak) (dBuV)	Reading (Average) (dBuV)	Correction Factor (dB/m)	Result (Peak) (dBuV/m)	Result (Average) (dBuV/m)	Limit (Peak) (dBuV/m)	Limit (Average) (dBuV/m)	Margin (dB)	Remark	Ant.Pol. (H/V)
1793.33	52.19	---	-7.57	44.62	---	68.3	54	-23.68	Peak	V
11490.00	40.11	31.23	18.68	58.79	49.91	68.3	54	-4.09	AVG	V
N/A										
1396.67	54.32	42.16	-10.66	43.66	31.5	68.3	54	-22.5	AVG	H
11490.00	40.21	31.2	18.68	58.89	49.88	68.3	54	-4.12	AVG	H
N/A										

**Remark:**

1. Measuring frequencies from 1 GHz to the 10th harmonic of highest fundamental frequency.
2. Radiated emissions measured in frequency above 1000MHz were made with an instrument using peak/average detector mode.
3. Average test would be performed if the peak result were greater than the average limit.
4. Data of measurement within this frequency range shown “ --- ” in the table above means the reading of emissions are attenuated more than 20dB below the permissible limits or the field strength is too small to be measured.
5. Measurements above show only up to 6 maximum emissions noted, or would be lesser, with “ N/A ” remark, if no specific emissions from the EUT are recorded (ie: margin>20dB from the applicable limit) and considered that's already beyond the background noise floor.
6. Margin (dB) = Remark result (dBuV/m) – Average limit (dBuV/m).

**Operation Mode:** Tx / IEEE 802.11n HT 20 MHz  
/5745 ~ 5825MHz / CH Mid

**Temperature:** 25°C

**Humidity:** 50% RH

**Test Date:** 2016-7-19

**Tested by:** Haiqing.Zh

**Polarity:** Ver. / Hor.

Frequency (MHz)	Reading (Peak) (dBuV)	Reading (Average) (dBuV)	Correction Factor (dB/m)	Result (Peak) (dBuV/m)	Result (Average) (dBuV/m)	Limit (Peak) (dBuV/m)	Limit (Average) (dBuV/m)	Margin (dB)	Remark	Ant.Pol. (H/V)
2061.67	52.12	---	-5.31	46.81	---	68.3	54	-21.49	Peak	V
11570.33	34.35	29.33	18.77	53.12	48.1	68.3	54	-5.9	AVG	V
N/A										
1396.67	50.95	---	-10.66	40.29	---	68.3	54	-28.01	Peak	H
11570.33	40.32	31.02	18.77	59.09	49.79	68.3	54	-4.21	AVG	H
N/A										

**Remark:**

1. Measuring frequencies from 1 GHz to the 10th harmonic of highest fundamental frequency.
2. Radiated emissions measured in frequency above 1000MHz were made with an instrument using peak/average detector mode.
3. Average test would be performed if the peak result were greater than the average limit.
4. Data of measurement within this frequency range shown “ --- ” in the table above means the reading of emissions are attenuated more than 20dB below the permissible limits or the field strength is too small to be measured.
5. Measurements above show only up to 6 maximum emissions noted, or would be lesser, with “ N/A ” remark, if no specific emissions from the EUT are recorded (ie: margin>20dB from the applicable limit) and considered that's already beyond the background noise floor.
6. Margin (dB) = Remark result (dBuV/m) – Average limit (dBuV/m).

**Operation Mode:** Tx / IEEE 802.11n HT 20 MHz  
5745 ~ 5825MHz / CH High

**Test Date:** 2016-7-19

**Temperature:** 25°C

**Tested by:**

Haiqing.Zhao

**Humidity:** 50% RH

**Polarity:** Ver. / Hor.

Frequency (MHz)	Reading (Peak) (dBuV)	Reading (Average) (dBuV)	Correction Factor (dB/m)	Result (Peak) (dBuV/m)	Result (Average) (dBuV/m)	Limit (Peak) (dBuV/m)	Limit (Average) (dBuV/m)	Margin (dB)	Remark	Ant.Pol. (H/V)
1356.67	55.38	---	-5.91	49.47	---	68.30	54.00	-4.53	Peak	V
11650.33	39.25	31.21	18.86	56.87	48.83	68.30	54.00	-5.17	AVG	V
N/A										
1396.67	52.33	---	-5.91	46.42	---	68.3	54	-21.88	AVG	H
11650.33	39.86	31.32	18.86	58.72	50.18	68.3	54	-3.82	AVG	H
N/A										

**Remark:**

1. Measuring frequencies from 1 GHz to the 10th harmonic of highest fundamental frequency.
2. Radiated emissions measured in frequency above 1000MHz were made with an instrument using peak/average detector mode.
3. Average test would be performed if the peak result were greater than the average limit.
4. Data of measurement within this frequency range shown “ --- ” in the table above means the reading of emissions are attenuated more than 20dB below the permissible limits or the field strength is too small to be measured.
5. Measurements above show only up to 6 maximum emissions noted, or would be lesser, with “ N/A ” remark, if no specific emissions from the EUT are recorded (ie: margin>20dB from the applicable limit) and considered that's already beyond the background noise floor.
6. Margin (dB) = Remark result (dBuV/m) – Average limit (dBuV/m).

**Operation Mode:** Tx / IEEE 802.11n HT 40 MHz  
**Temperature:** 25°C  
**Humidity:** 50% RH

**Test Date:** 2016-7-19  
**Tested by:** Haiqing.Zh  
**Polarity:** Ver. / Hor.

Frequency (MHz)	Reading (Peak) (dBuV)	Reading (Average) (dBuV)	Correction Factor (dB/m)	Result (Peak) (dBuV/m)	Result (Average) (dBuV/m)	Limit (Peak) (dBuV/m)	Limit (Average) (dBuV/m)	Margin (dB)	Remark	Ant.Pol. (H/V)
1793.33	54.36	---	-7.57	46.79	---	68.3	54	-21.51	Peak	V
11510.00	40.33	32.11	18.71	59.04	50.82	68.3	54	-3.18	AVG	V
N/A										
1396.67	56.33	44.44	-10.66	45.67	33.78	68.3	54	-20.22	AVG	H
11510.00	41.24	31.23	18.71	59.95	49.94	68.3	54	-4.06	AVG	H
N/A										

**Remark:**

1. Measuring frequencies from 1 GHz to the 10th harmonic of highest fundamental frequency.
2. Radiated emissions measured in frequency above 1000MHz were made with an instrument using peak/average detector mode.
3. Average test would be performed if the peak result were greater than the average limit.
4. Data of measurement within this frequency range shown “ --- ” in the table above means the reading of emissions are attenuated more than 20dB below the permissible limits or the field strength is too small to be measured.
5. Measurements above show only up to 6 maximum emissions noted, or would be lesser, with “ N/A ” remark, if no specific emissions from the EUT are recorded (ie: margin>20dB from the applicable limit) and considered that's already beyond the background noise floor.
6. Margin (dB) = Remark result (dBuV/m) – Average limit (dBuV/m).

**Operation Mode:** Tx / IEEE 802.11n HT 40 MHz  
 5755 ~ 5795MHz / CH High  
**Temperature:** 25°C  
**Humidity:** 50% RH

**Test Date:** 2016-7-19  
**Tested by:** Haiqing.Zhao  
**Polarity:** Ver. / Hor.

Frequency (MHz)	Reading (Peak) (dBuV)	Reading (Average) (dBuV)	Correction Factor (dB/m)	Result (Peak) (dBuV/m)	Result (Average) (dBuV/m)	Limit (Peak) (dBuV/m)	Limit (Average) (dBuV/m)	Margin (dB)	Remark	Ant.Pol. (H/V)
1956.67	53.21	---	-5.91	47.3	---	68.3	54	-21	Peak	V
11590.33	40.12	30.59	18.8	58.92	49.39	68.3	54	-4.61	AVG	V
N/A										
1396.67	54.81	40.21	-10.66	29.55	29.55	68.3	54	-24.45	AVG	H
11590.33	40.55	31.66	18.8	50.46	50.46	68.3	54	-3.54	AVG	H
N/A										

**Remark:**

1. Measuring frequencies from 1 GHz to the 10th harmonic of highest fundamental frequency.
2. Radiated emissions measured in frequency above 1000MHz were made with an instrument using peak/average detector mode.
3. Average test would be performed if the peak result were greater than the average limit.
4. Data of measurement within this frequency range shown “ --- ” in the table above means the reading of emissions are attenuated more than 20dB below the permissible limits or the field strength is too small to be measured.
5. Measurements above show only up to 6 maximum emissions noted, or would be lesser, with “ N/A ” remark, if no specific emissions from the EUT are recorded (ie: margin>20dB from the applicable limit) and considered that's already beyond the background noise floor.
6. Margin (dB) = Remark result (dBuV/m) – Average limit (dBuV/m).

**Operation Mode:** Tx / IEEE 802.11ac HT 20 MHz  
 5745 ~ 5825MHz /CH Low  
**Temperature:** 25°C  
**Humidity:** 50% RH

**Test Date:** 2016-7-19  
**Tested by:** Haiqing.Zh  
**Polarity:** Ver. / Hor.

Frequency (MHz)	Reading (Peak) (dBuV)	Reading (Average) (dBuV)	Correction Factor (dB/m)	Result (Peak) (dBuV/m)	Result (Average) (dBuV/m)	Limit (Peak) (dBuV/m)	Limit (Average) (dBuV/m)	Margin (dB)	Remark	Ant.Pol. (H/V)
1793.33	50.19	---	-7.57	42.62	---	68.3	54	-11.38	Peak	V
11490.00	40.16	30.88	18.68	58.84	49.56	68.3	54	-4.44	AVG	V
N/A										
1396.67	54.39	43.32	-10.66	43.73	32.66	68.3	54	-21.34	AVG	H
11490.00	40	31.22	18.68	58.68	49.9	68.3	54	-4.1	AVG	H
N/A										

**Remark:**

1. Measuring frequencies from 1 GHz to the 10th harmonic of highest fundamental frequency.
2. Radiated emissions measured in frequency above 1000MHz were made with an instrument using peak/average detector mode.
3. Average test would be performed if the peak result were greater than the average limit.
4. Data of measurement within this frequency range shown “ --- ” in the table above means the reading of emissions are attenuated more than 20dB below the permissible limits or the field strength is too small to be measured.
5. Measurements above show only up to 6 maximum emissions noted, or would be lesser, with “ N/A ” remark, if no specific emissions from the EUT are recorded (ie: margin>20dB from the applicable limit) and considered that's already beyond the background noise floor.
6. Margin (dB) = Remark result (dBuV/m) – Average limit (dBuV/m).

**Operation Mode:** Tx / IEEE 802.11ac HT 20 MHz  
/5745 ~ 5825MHz / CH Mid

**Temperature:** 25°C

**Humidity:** 50% RH

**Test Date:** 2016-7-19

**Tested by:** Haiqing.Zh

**Polarity:** Ver. / Hor.

Frequency (MHz)	Reading (Peak) (dBuV)	Reading (Average) (dBuV)	Correction Factor (dB/m)	Result (Peak) (dBuV/m)	Result (Average) (dBuV/m)	Limit (Peak) (dBuV/m)	Limit (Average) (dBuV/m)	Margin (dB)	Remark	Ant.Pol. (H/V)
2061.67	53.02	---	-5.31	47.71	---	68.3	54	-20.59	Peak	V
11570.33	35.66	29.38	18.77	54.43	48.15	68.3	54	-5.85	AVG	V
N/A										
1396.67	50.55	---	-10.66	39.89	---	68.3	54	-28.41	Peak	H
11570.33	40.38	31.55	18.77	59.15	50.32	68.3	54	-3.68	AVG	H
N/A										

**Remark:**

1. Measuring frequencies from 1 GHz to the 10th harmonic of highest fundamental frequency.
2. Radiated emissions measured in frequency above 1000MHz were made with an instrument using peak/average detector mode.
3. Average test would be performed if the peak result were greater than the average limit.
4. Data of measurement within this frequency range shown “ --- ” in the table above means the reading of emissions are attenuated more than 20dB below the permissible limits or the field strength is too small to be measured.
5. Measurements above show only up to 6 maximum emissions noted, or would be lesser, with “ N/A ” remark, if no specific emissions from the EUT are recorded (ie: margin>20dB from the applicable limit) and considered that's already beyond the background noise floor.
6. Margin (dB) = Remark result (dBuV/m) – Average limit (dBuV/m).



**Operation Mode:** Tx / IEEE 802.11ac HT 20 MHz  
5745 ~ 5825MHz / CH High

**Test Date:** 2016-7-19

**Temperature:** 25°C

**Tested by:**

Haiqing.Zhao

**Humidity:** 50% RH

**Polarity:** Ver. / Hor.

Frequency (MHz)	Reading (Peak) (dBuV)	Reading (Average) (dBuV)	Correction Factor (dB/m)	Result (Peak) (dBuV/m)	Result (Average) (dBuV/m)	Limit (Peak) (dBuV/m)	Limit (Average) (dBuV/m)	Margin (dB)	Remark	Ant.Pol. (H/V)
1356.67	52.33	---	-5.91	46.42	---	68.3	54	-21.88	Peak	V
11650.33	39.89	30.23	18.86	58.75	49.09	68.3	54	-4.91	AVG	V
N/A										
1396.67	50.33	---	-5.91	44.42	---	68.3	54	-23.88	AVG	H
11650.33	40.32	30.22	18.86	59.18	49.08	68.3	54	-4.92	AVG	H
N/A										

**Remark:**

1. Measuring frequencies from 1 GHz to the 10th harmonic of highest fundamental frequency.
2. Radiated emissions measured in frequency above 1000MHz were made with an instrument using peak/average detector mode.
3. Average test would be performed if the peak result were greater than the average limit.
4. Data of measurement within this frequency range shown " --- " in the table above means the reading of emissions are attenuated more than 20dB below the permissible limits or the field strength is too small to be measured.
5. Measurements above show only up to 6 maximum emissions noted, or would be lesser, with " N/A " remark, if no specific emissions from the EUT are recorded (ie: margin>20dB from the applicable limit) and considered that's already beyond the background noise floor.
6. Margin (dB) = Remark result (dBuV/m) – Average limit (dBuV/m).

**Operation Mode:** Tx / IEEE 802.11ac HT 40 MHz  
**Temperature:** 25°C  
**Humidity:** 50% RH

**Test Date:** 2016-7-19  
**Tested by:** Haiqing.Zh  
**Polarity:** Ver. / Hor.

Frequency (MHz)	Reading (Peak) (dBuV)	Reading (Average) (dBuV)	Correction Factor (dB/m)	Result (Peak) (dBuV/m)	Result (Average) (dBuV/m)	Limit (Peak) (dBuV/m)	Limit (Average) (dBuV/m)	Margin (dB)	Remark	Ant.Pol. (H/V)
1793.33	52.33	---	-7.57	44.76	---	68.3	54	-23.54	Peak	V
11510.00	40.68	30.89	18.71	59.39	49.6	68.3	54	-4.4	AVG	V
N/A										
1396.67	54.32	45.68	-10.66	43.66	35.02	68.3	54	-18.98	AVG	H
11510.00	42.33	31	18.71	61.04	49.71	68.3	54	-4.29	AVG	H
N/A										

**Remark:**

1. Measuring frequencies from 1 GHz to the 10th harmonic of highest fundamental frequency.
2. Radiated emissions measured in frequency above 1000MHz were made with an instrument using peak/average detector mode.
3. Average test would be performed if the peak result were greater than the average limit.
4. Data of measurement within this frequency range shown “ --- ” in the table above means the reading of emissions are attenuated more than 20dB below the permissible limits or the field strength is too small to be measured.
5. Measurements above show only up to 6 maximum emissions noted, or would be lesser, with “ N/A ” remark, if no specific emissions from the EUT are recorded (ie: margin>20dB from the applicable limit) and considered that's already beyond the background noise floor.
6. Margin (dB) = Remark result (dBuV/m) – Average limit (dBuV/m).

**Operation Mode:** Tx / IEEE 802.11ac HT 40 MHz  
5755 ~ 5795MHz / CH High

**Test Date:** 2016-7-19

**Temperature:** 25°C

**Tested by:**

Haiqing.Zhao

**Humidity:** 50% RH

**Polarity:** Ver. / Hor.

Frequency (MHz)	Reading (Peak) (dBuV)	Reading (Average) (dBuV)	Correction Factor (dB/m)	Result (Peak) (dBuV/m)	Result (Average) (dBuV/m)	Limit (Peak) (dBuV/m)	Limit (Average) (dBuV/m)	Margin (dB)	Remark	Ant.Pol. (H/V)
1956.67	54.66	---	-5.91	48.75	---	68.3	54	-19.55	Peak	V
11590.33	40.68	29.56	18.8	59.48	48.36	68.3	54	-5.64	AVG	V
N/A										
1396.67	53.56	40.44	-10.66	42.9	29.78	68.3	54	-24.22	AVG	H
11590.33	41.23	29.56	18.8	60.03	48.36	68.3	54	-5.64	AVG	H
N/A										

**Remark:**

1. Measuring frequencies from 1 GHz to the 10th harmonic of highest fundamental frequency.
2. Radiated emissions measured in frequency above 1000MHz were made with an instrument using peak/average detector mode.
3. Average test would be performed if the peak result were greater than the average limit.
4. Data of measurement within this frequency range shown “ --- ” in the table above means the reading of emissions are attenuated more than 20dB below the permissible limits or the field strength is too small to be measured.
5. Measurements above show only up to 6 maximum emissions noted, or would be lesser, with “ N/A ” remark, if no specific emissions from the EUT are recorded (ie: margin>20dB from the applicable limit) and considered that's already beyond the background noise floor.
6. Margin (dB) = Remark result (dBuV/m) – Average limit (dBuV/m).

## 11. CONDUCTED UNDESIRABLE EMISSION

### LIMIT

According to 15.407(b),

- (1) For transmitters operating in the 5.15-5.25 GHz band: all emissions outside of the 5.15-5.35 GHz band shall not exceed an EIRP of -27 dBm/MHz.

For transmitters operating in the 5.725-5.85 GHz band: for frequencies 10 MHz or greater above or below the band edge, emissions shall not exceed an e.i.r.p. of -27 dBm/MHz.

The provisions of §15.205 apply to intentional radiators operating under this section.

### Test Configuration

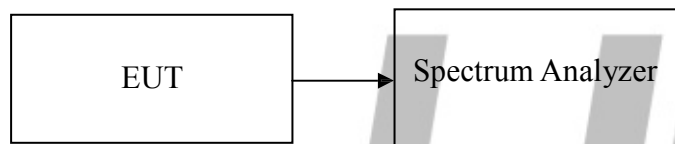

### TEST PROCEDURE

Conducted RF measurements of the transmitter output were made to confirm that the EUT antenna port conducted emissions meet the specified limit and to identify any spurious signals that require further investigation or measurements on the radiated emissions site.

The transmitter output is connected to the spectrum analyzer. The resolution bandwidth is set to 1 MHz. The video bandwidth is set to 1 MHz. Peak detection measurements are compared to the average EIRP limit, adjusted for the maximum antenna gain. If necessary, additional average detection measurements are made.

Measurements are made over the 30 MHz to 40 GHz range with the transmitter set to the lowest, middle, and highest channels.

### TEST RESULTS

*No non-compliance noted*

### IEEE 802.11a (5745 ~ 5825MHz) CH

Low

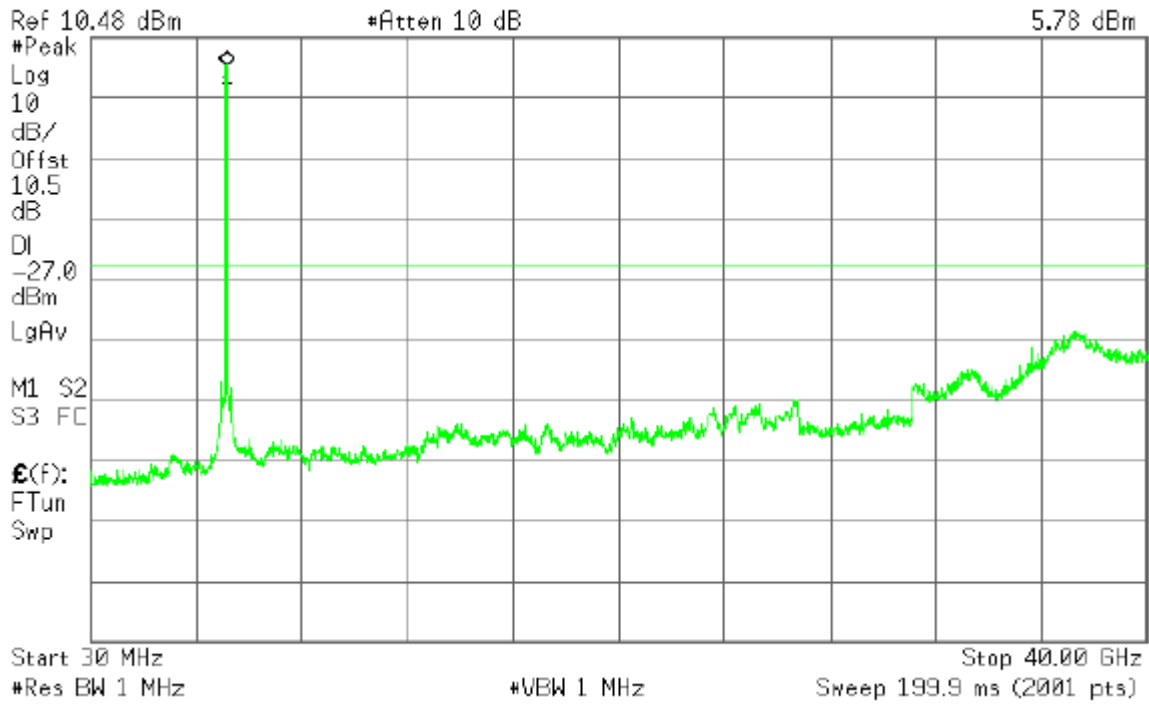

CH Mid

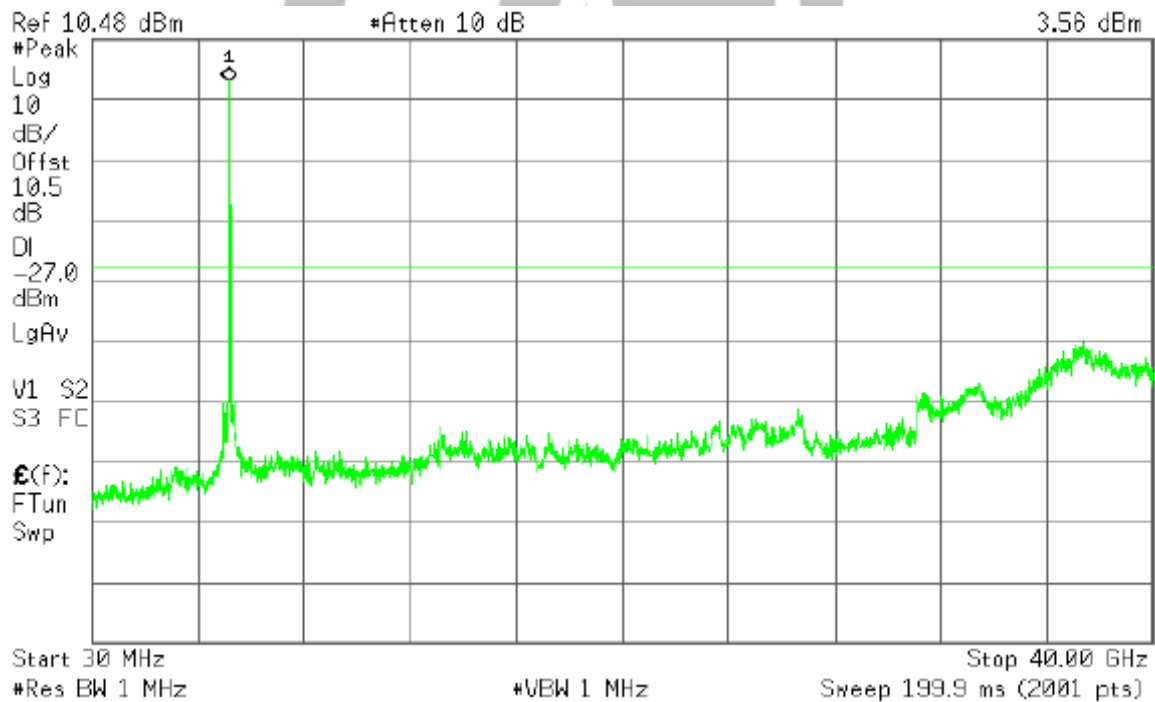

**CH High**

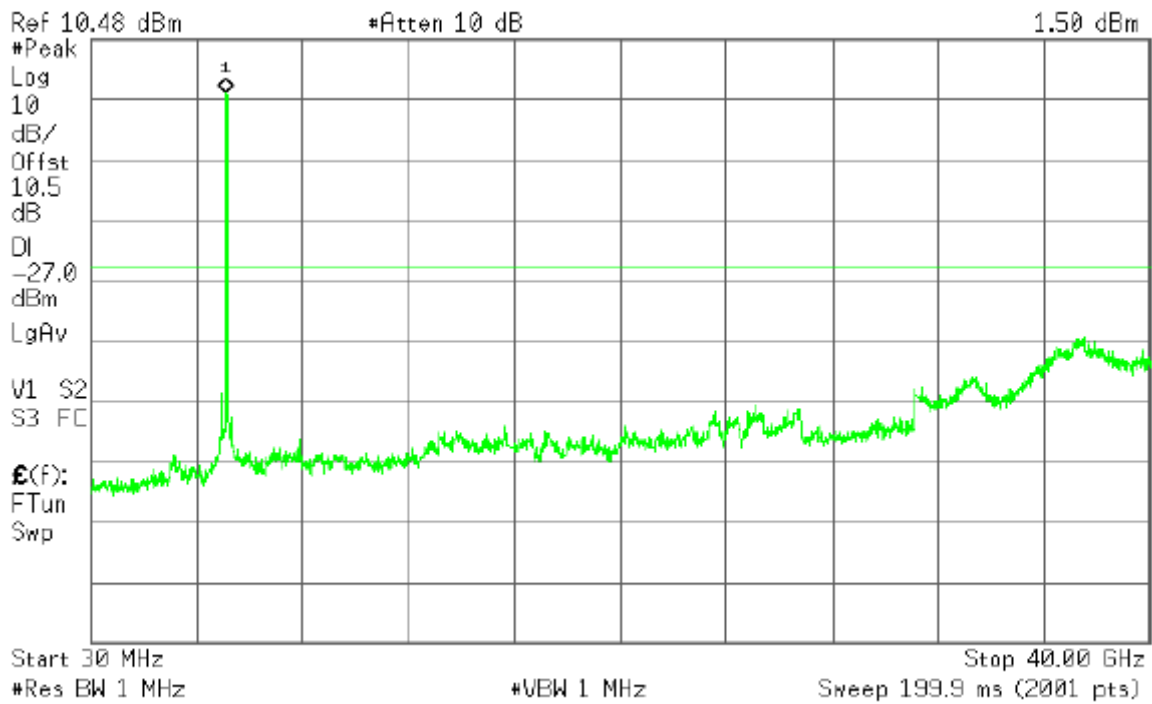

**IEEE 802.11n HT 20 MHz (5745 ~ 5825MHz) CH**

**Low**

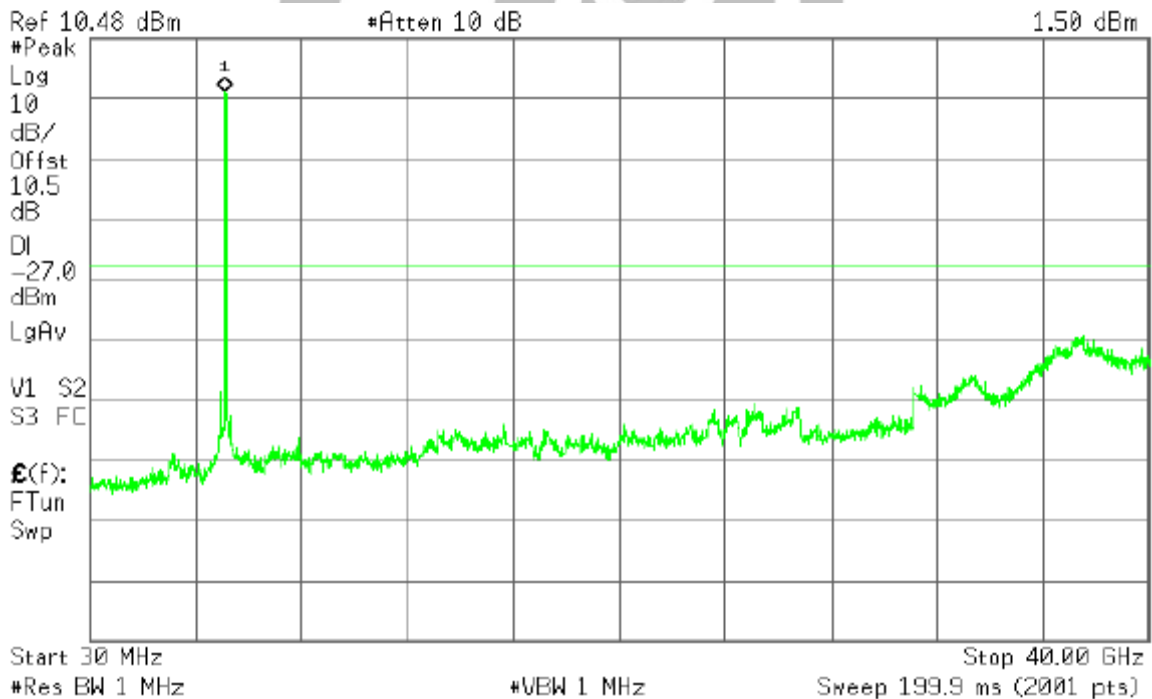

### CH Mid

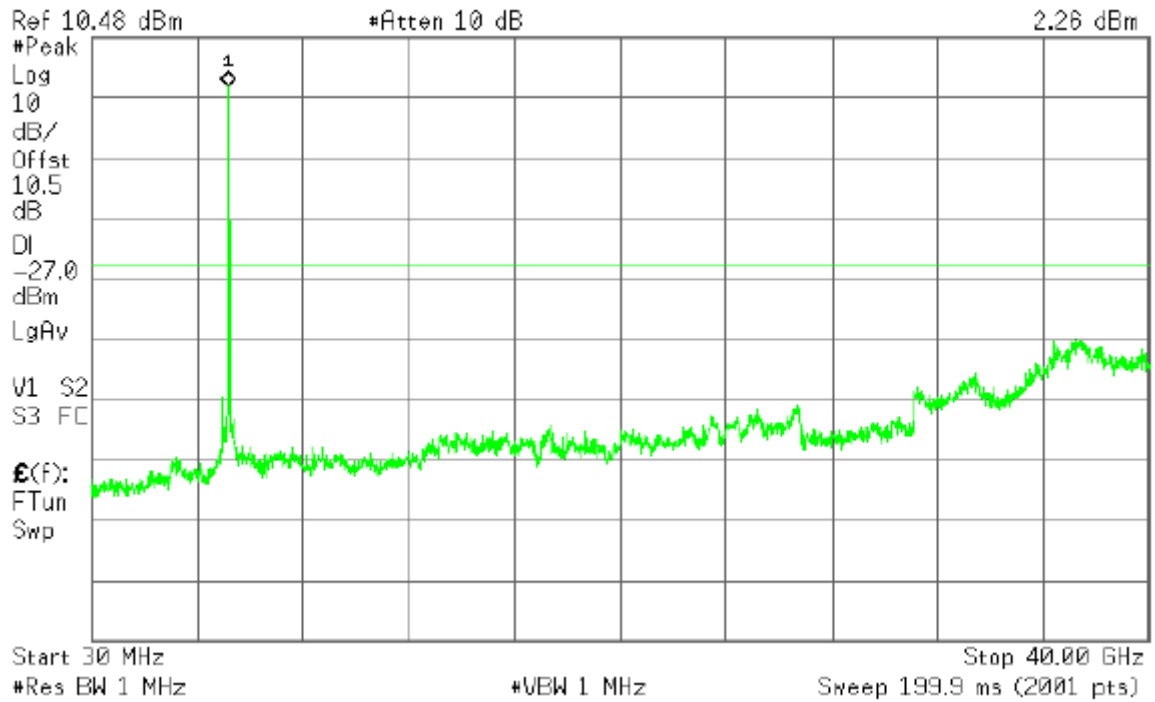

### CH High

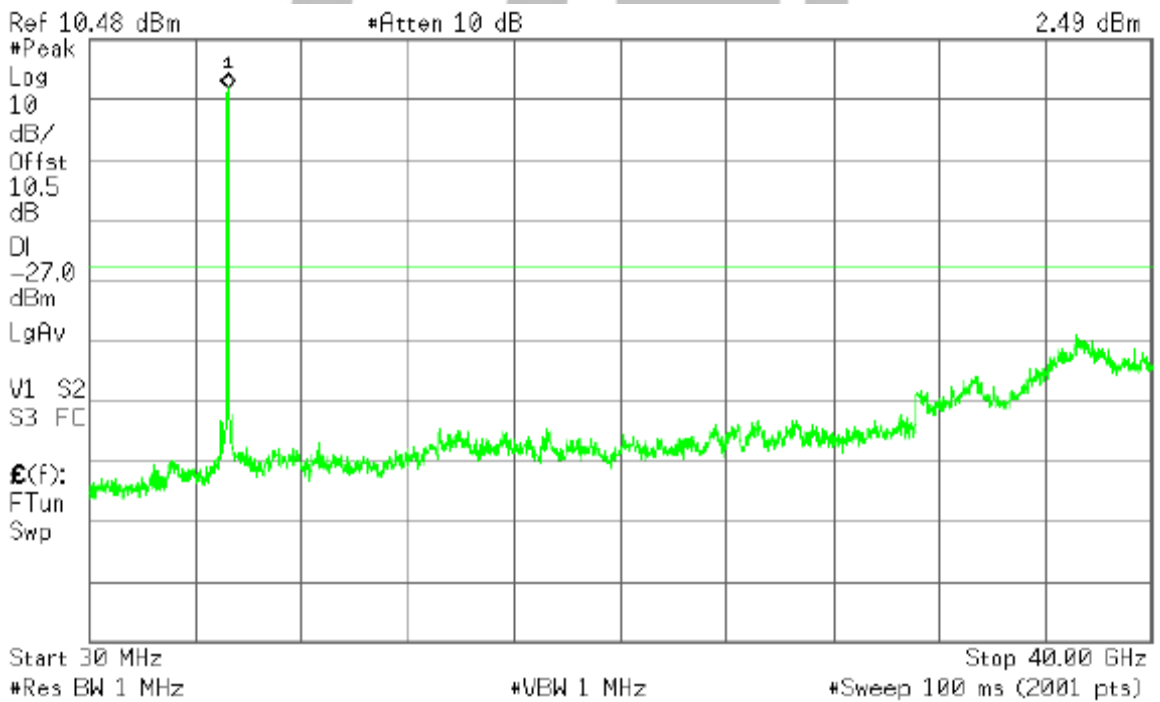

### IEEE 802.11n HT 40 MHz (5755 ~ 5795MHz) CH

Low

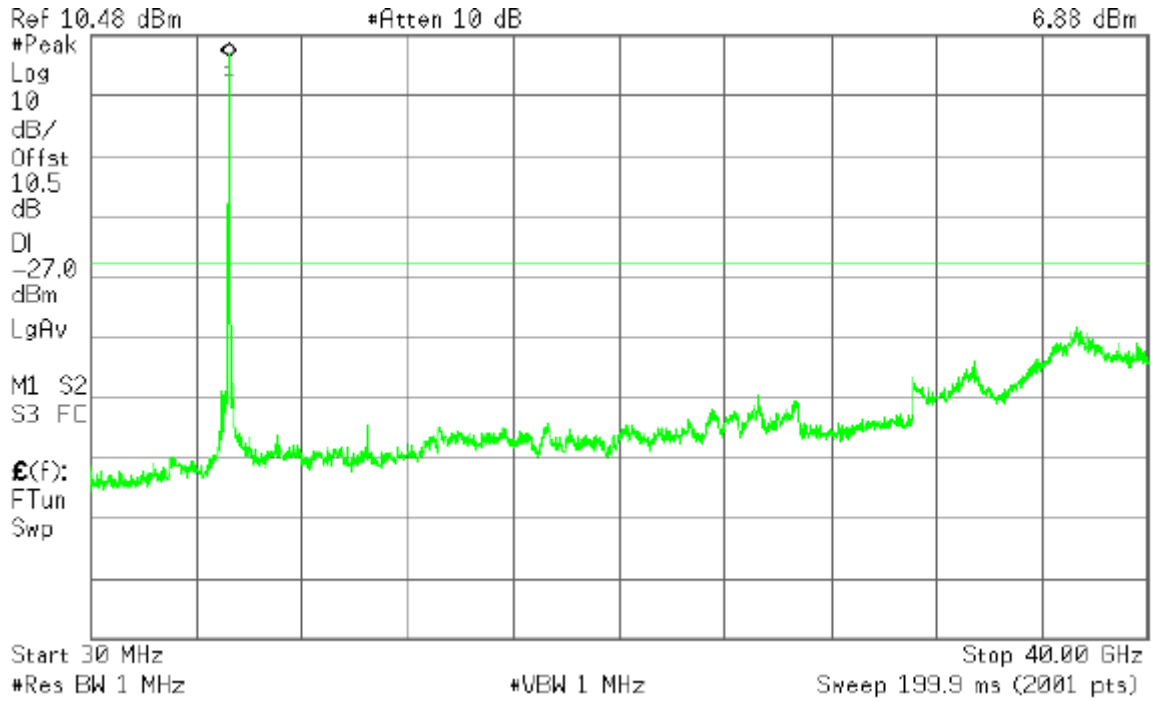

CH High

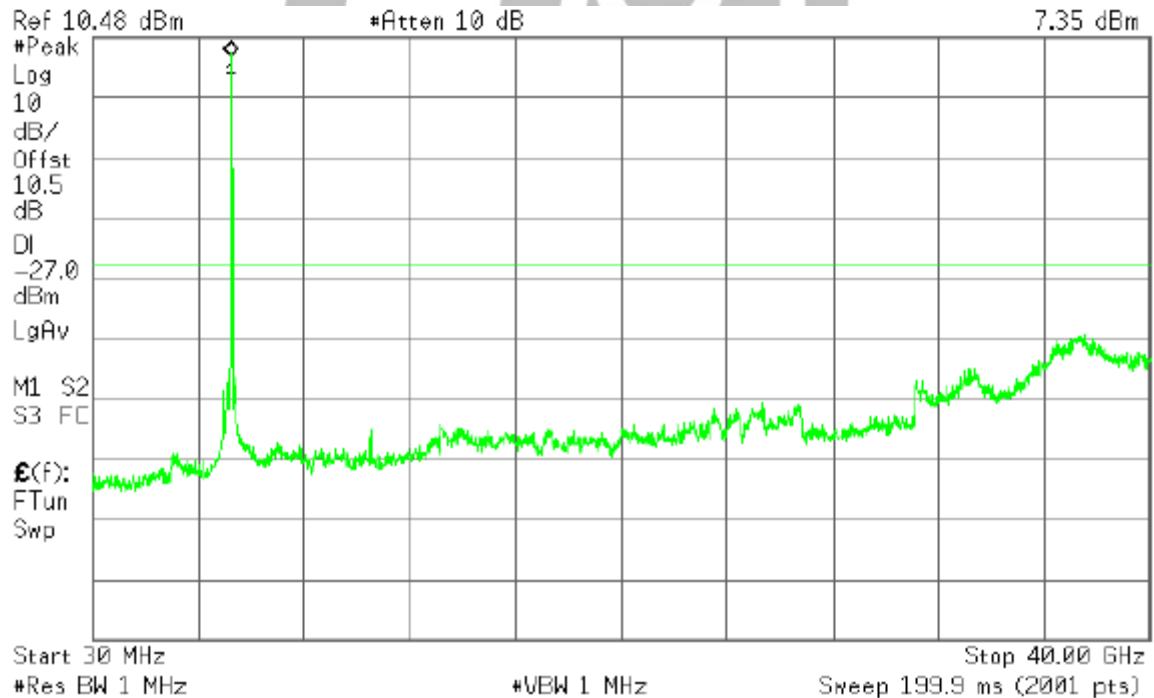



# IEEE 802.11ac HT 20 MHz (5745 ~ 5825MHz) CH

## Low

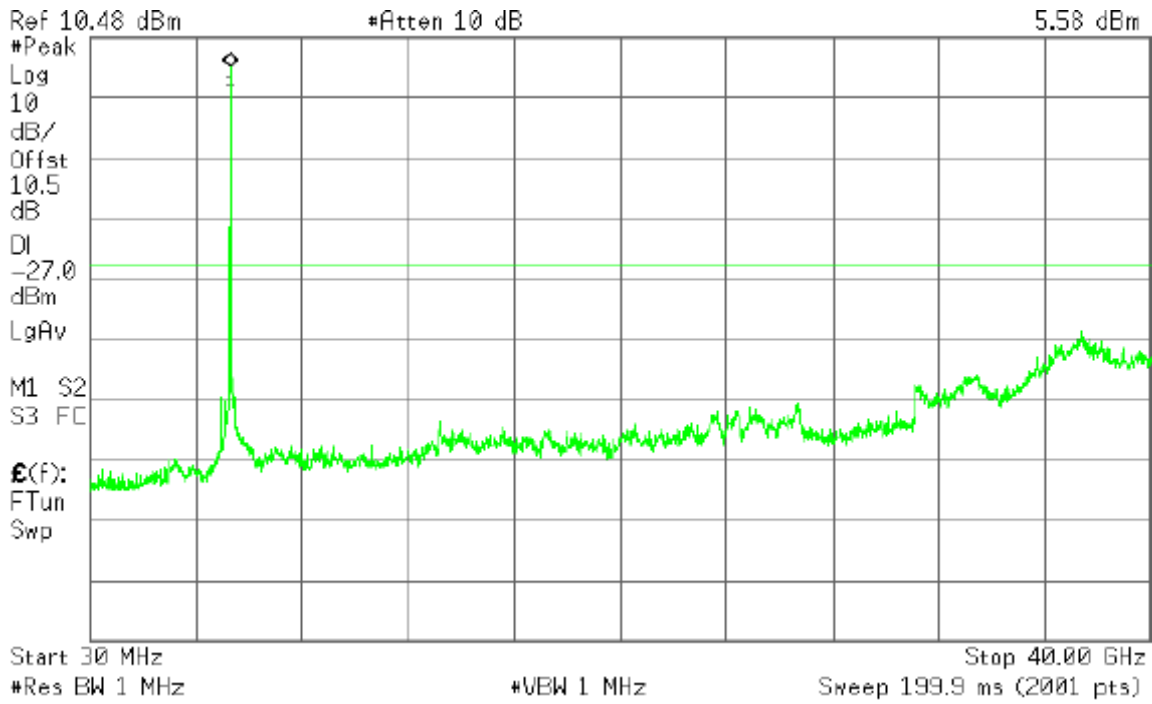

## CH Mid

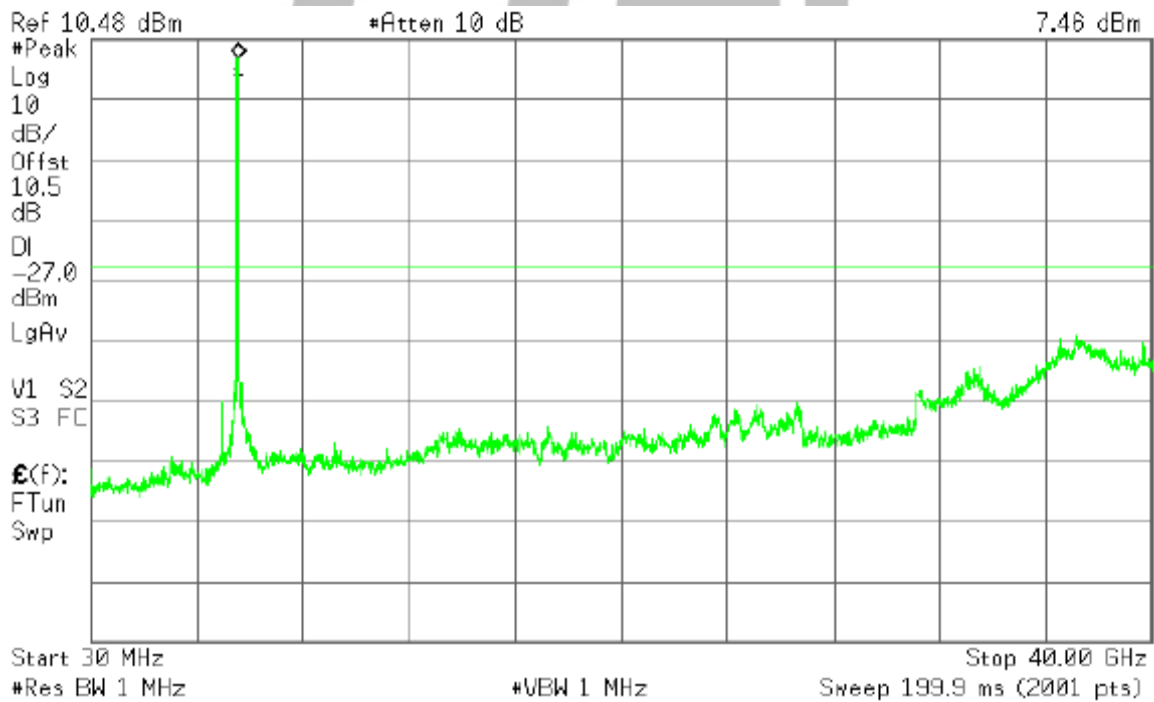

**CH High**

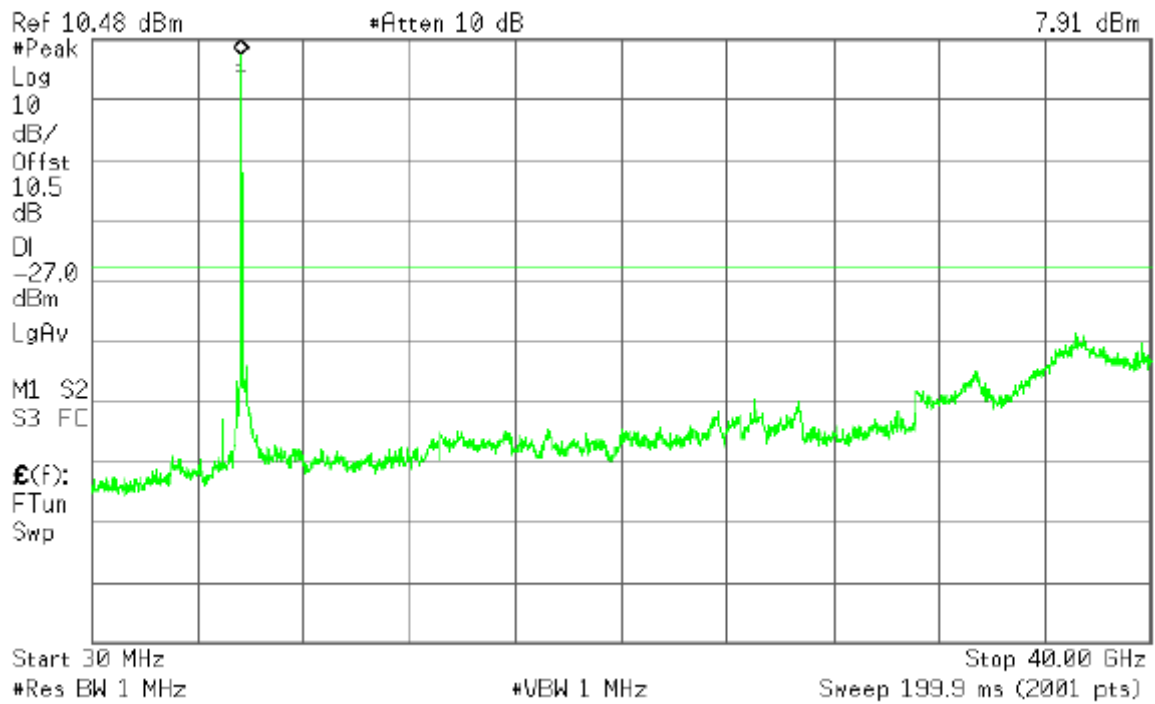

**IEEE 802.11ac HT 40 MHz (5755 ~ 5795MHz) CH**

**Low**

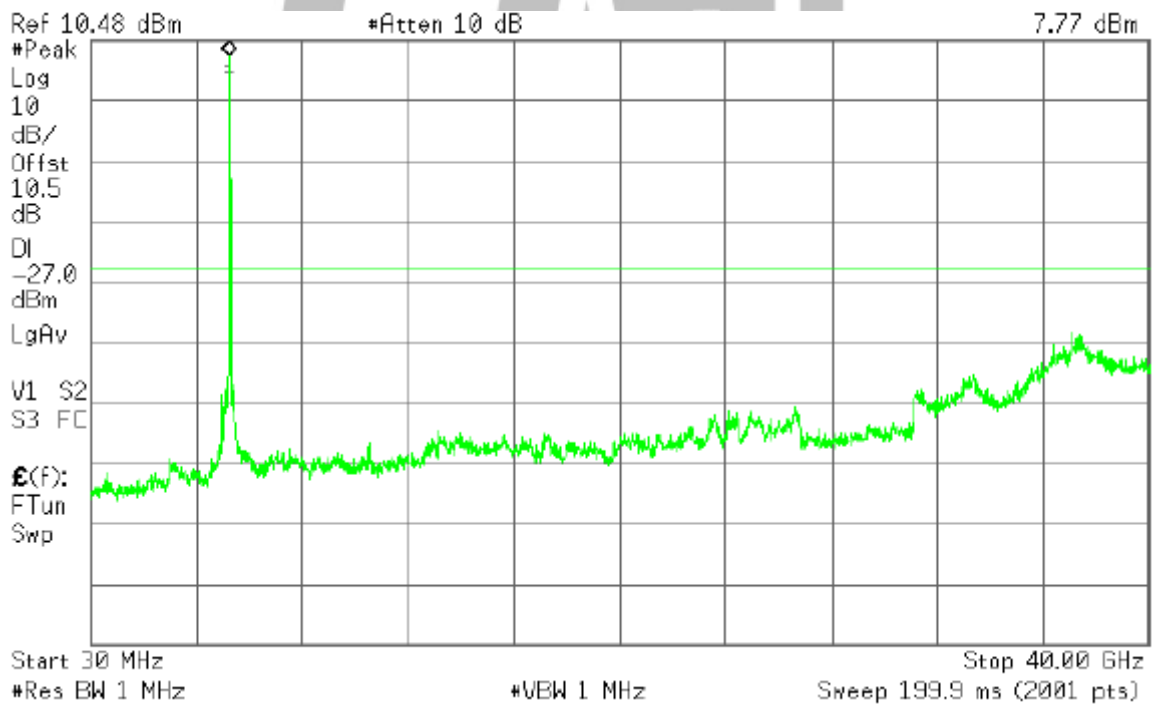

### CH High

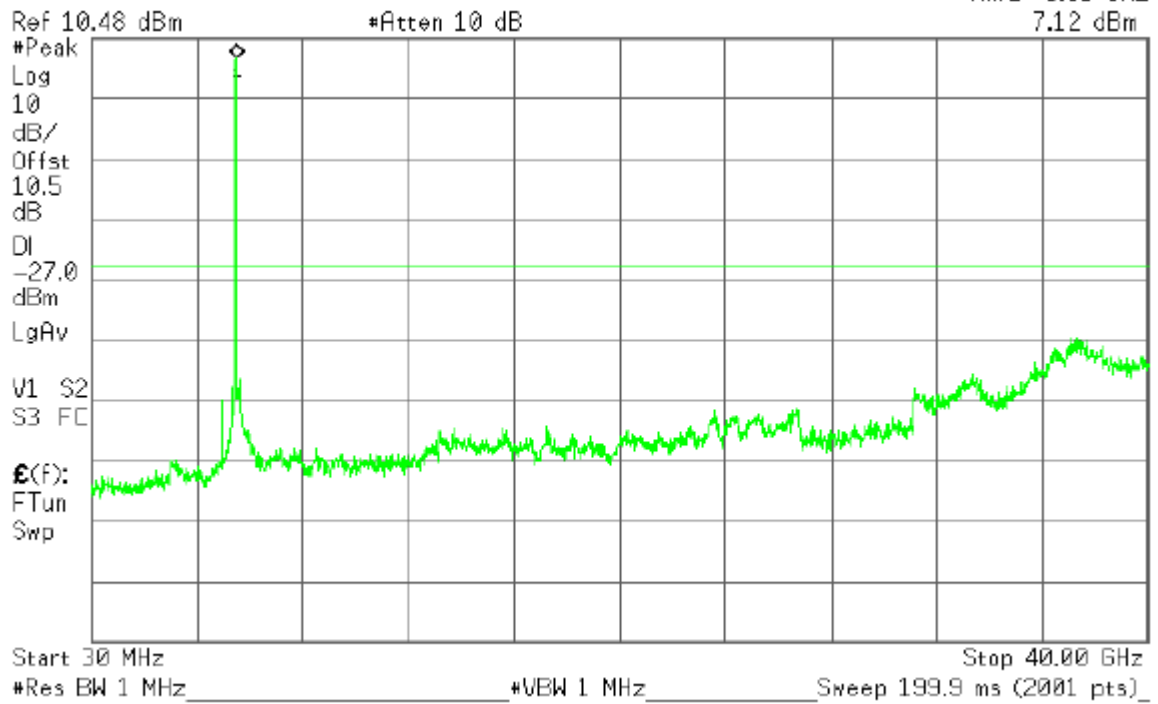

## 12. POWERLINE CONDUCTED EMISSIONS

### 12.1. Test Limit

FCC Part 15 Subpart C Paragraph 15.207		
Frequency (MHz)	QP (dB $\mu$ V)	AV (dB $\mu$ V)
0.15 - 0.50	66 - 56	56 - 46
0.50 - 5.0	56	46
5.0 - 30	60	50

Note 1: The lower limit shall apply at the transition frequencies.

Note 2: The limit decreases linearly with the logarithm of the frequency in the range 0.15MHz to 0.5MHz.

### 7.9.2. Test Procedure

The EUT was setup according to ANSI C63.4, 2009 and tested according to KDB 789033 for compliance to FCC 47CFR 15.247 requirements. The EUT was placed on a platform of nominal size, 1 m by 1.5 m, raised 80 cm above the conducting ground plane. The vertical conducting plane was located 40 cm to the rear of the EUT. All other surfaces of EUT were at least 80 cm from any other grounded conducting surface. The EUT and simulators are connected to the main power through a line impedance stabilization network (LISN). The LISN provides a 50 ohm /50uH coupling impedance for the measuring equipment. The peripheral devices are also connected to the main power through a LISN. (Please refer to the block diagram of the test setup and photographs) Each current-carrying conductor of the EUT power cord, except the ground (safety) conductor, was individually connected through a LISN to the input power source.

The excess length of the power cord between the EUT and the LISN receptacle were folded back and forth at the center of the lead to form a bundle not exceeding 40 cm in length.

Conducted emissions were investigated over the frequency range from 0.15MHz to 30MHz using a receiver bandwidth of 9 kHz.

### 7.9.3. Test Setup

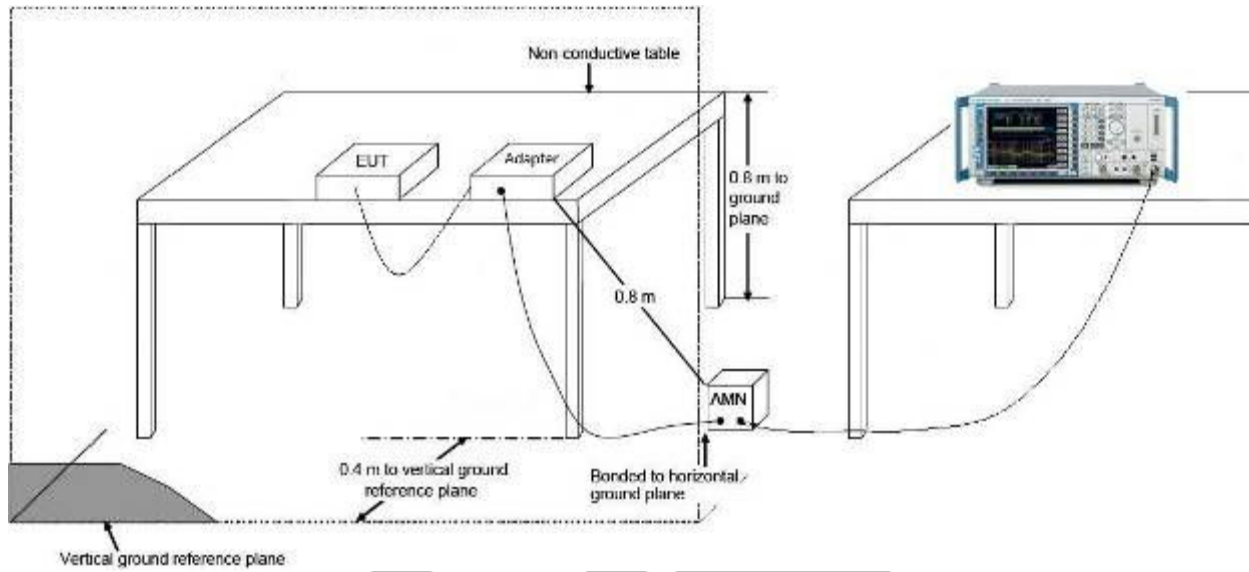

**Conducted Emission:**

EUT: GL-AR300M mini router  
M/N: GL-AR300MD  
Operating Condition: Tx Mode  
Test Site: Shielded Room  
Operator: Yang  
Test Specification: DC: 5V/1A micro USB  
Comment: L Line

**SCAN TABLE: "Voltage(150K-30M)PR"**  
Short Description: 150K-30M Voltage

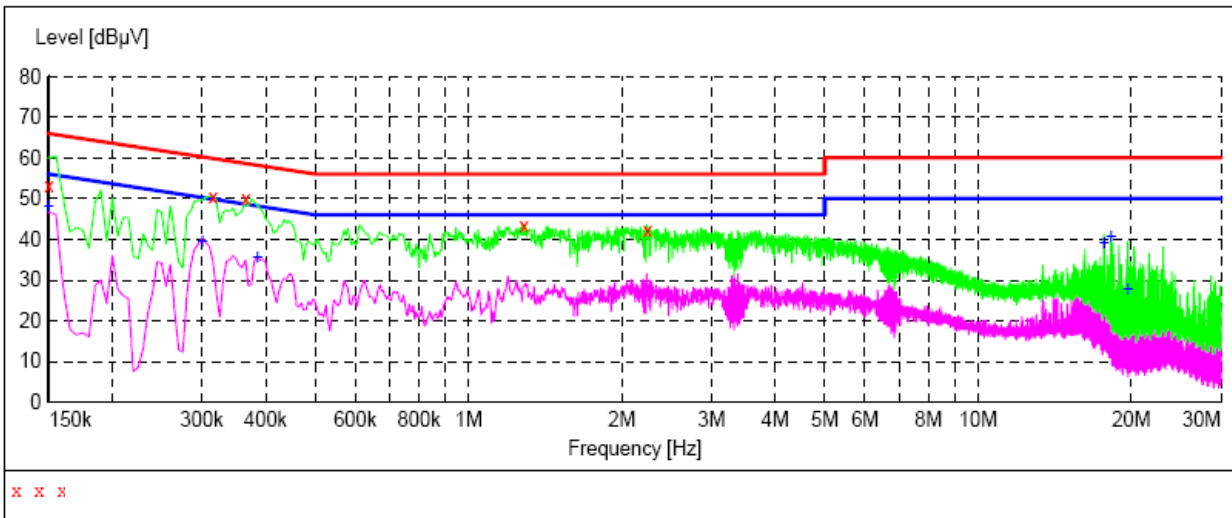

**MEASUREMENT RESULT:**

Frequency MHz	Level dBµV	Transd dB	Limit dBµV	Margin dB	Detector	Line	PE
0.150000	53.10	13.4	66	12.9	PK	L1	GND
0.315000	50.50	10.9	60	9.3	PK	L1	GND
0.365000	50.30	10.8	59	8.3	PK	L1	GND
1.285000	43.40	10.4	56	12.6	PK	L1	GND
2.245000	42.20	10.4	56	13.8	PK	L1	GND

**MEASUREMENT RESULT:**

Frequency MHz	Level dBµV	Transd dB	Limit dBµV	Margin dB	Detector	Line	PE
0.150000	48.00	13.4	56	8.0	AV	L1	GND
0.300000	39.70	11.0	50	10.5	AV	L1	GND
0.385000	35.60	10.7	48	12.6	AV	L1	GND
17.695000	39.20	10.7	50	10.8	AV	L1	GND
18.245000	40.90	10.7	50	9.1	AV	L1	GND
19.705000	27.90	10.7	50	22.1	AV	L1	GND

**Conducted Emission:**

EUT: GL-AR300M mini router  
 M/N: GL-AR300MD  
 Operating Condition: Tx Mode  
 Test Site: Shielded Room  
 Operator: Yang  
 Test Specification: DC: 5V/1A micro USB  
 Comment: N Line

**SCAN TABLE: "Voltage (150K-30M) PR"**  
 Short Description: 150K-30M Voltage

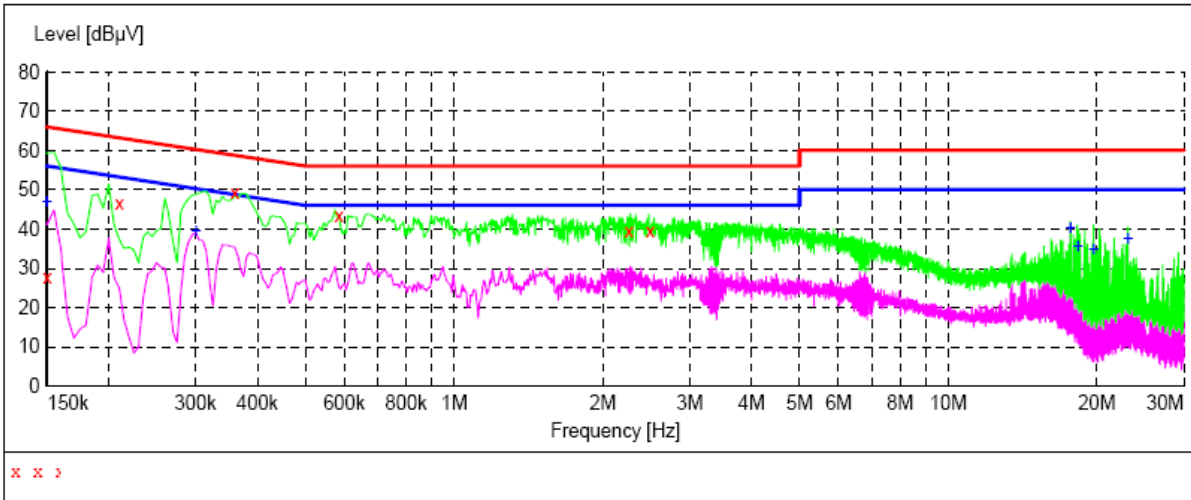

**MEASUREMENT RESULT:**

Frequency MHz	Level dBµV	Transd dB	Limit dBµV	Margin dB	Detector	Line	PE
0.150000	27.90	13.4	66	38.1	PK	N	GND
0.210000	46.60	11.3	63	16.6	PK	N	GND
0.360000	49.40	10.8	59	9.3	PK	N	GND
0.585000	43.30	10.4	56	12.7	PK	N	GND
2.260000	39.50	10.4	56	16.5	PK	N	GND
2.495000	39.60	10.4	56	16.4	PK	N	GND

**MEASUREMENT RESULT:**

Frequency MHz	Level dBµV	Transd dB	Limit dBµV	Margin dB	Detector	Line	PE
0.150000	46.90	13.4	56	9.1	AV	N	GND
0.300000	39.60	11.0	50	10.6	AV	N	GND
17.695000	40.30	10.7	50	9.7	AV	N	GND
18.305000	35.50	10.7	50	14.5	AV	N	GND
19.710000	34.80	10.7	50	15.2	AV	N	GND
23.130000	37.40	10.8	50	12.6	AV	N	GND

## 13. FREQUENCY STABILITY

### 13.1. Test Limit

Manufactures of U-NII devices are responsible for ensuring frequency stability such that an emission is maintained within the band of operation under all conditions of normal operation as specified in the user's manual.

### 13.2. Test Procedure Used

#### **Frequency Stability Under Temperature Variations:**

The equipment under test was connected to an external AC or DC power supply and input rated voltage. RF output was connected to a frequency counter or spectrum analyzer via feed through attenuators. The EUT was placed inside the temperature chamber. Set the spectrum analyzer RBW low enough to obtain the desired frequency resolution and measure EUT 20°C operating frequency as reference frequency. Turn EUT off and set the chamber temperature to highest. After the temperature stabilized for approximately 30 minutes recorded the frequency. Repeat step measure with 10°C decreased per stage until the lowest temperature reached.

#### **Frequency Stability Under Voltage Variations:**

Set chamber temperature to 20°C. Use a variable AC power supply / DC power source to power the EUT and set the voltage to rated voltage. Set the spectrum analyzer RBW low enough to obtain the desired frequency resolution and recorded the frequency.

Reduce the input voltage to specify extreme voltage variation ( $\pm 15\%$ ) and endpoint, record the maximum frequency change.

### 13.3. Test Setup

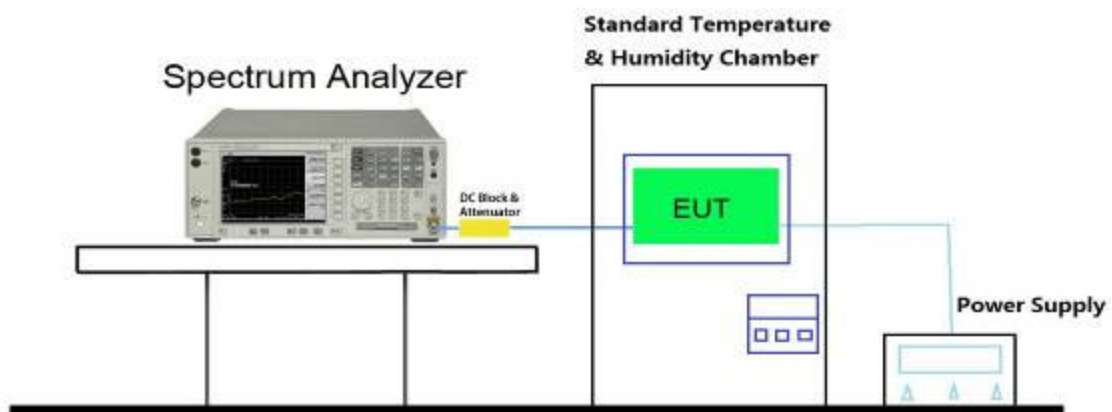



### 13.4. Test Result

Voltage (%)	Power (VAC)	Temp (°C)	Frequency (Hz)	Freq. Dev. (Hz)	Deviation (%)
100%	120	+ 20 (Ref)	5745018651.694	18651.694	0.000357
			5784998125.684	-1874.316	-0.000032
		- 30	5745031581.522	31581.522	0.000605
			5785029633.344	29633.344	0.000512
		- 20	5745028764.749	28764.749	0.000551
			5785014243.547	14243.547	0.000246
		- 10	5745036157.243	36157.243	0.000693
			5785031634.751	31634.751	0.000547
		0	5745010357.212	10357.212	0.000198
			5785041821.370	41821.370	0.000723
		+ 10	5745015658.651	15658.651	0.000300
			5784995187.658	-4812.342	-0.000083
		+ 20	5745025680.830	25680.830	0.000492
			5784996714.185	-3285.815	-0.000057
		+ 30	5745989752.347	-10247.653	-0.000196
			5785015204.625	15204.625	0.000263
+ 40	5745001738.711	1738.711	0.000033		
	5784990164.571	-9835.429	-0.000170		
+ 50	5745996525.712	-3474.288	-0.000067		
	5784989303.618	-10696.382	-0.000185		
115%	138	+ 20	5745002774.668	2774.668	0.000053
			5784988601.402	-11398.598	-0.000197
85%	102	+ 20	5745998124.121	-1875.879	-0.000036
			5784988413.321	-11586.679	-0.000200