

FCC

RF

TEST REPORT

ISSUED BY  
Shenzhen BALUN Technology Co., Ltd.



FOR  
**BLUETOOTH SHOWER SPEAKER**

ISSUED TO  
Grand Star Industrial Limited

10F., NO.322, SEC.1, NEIHU RD., NEIHU DISTRICT, TAIPEI, TAIWAN  
(R.O.C.)



Tested by:

*Cao Shadong*  
Cao Shadong  
(Engineer)

Date *Aug 14, 2015*

Approved by:



*Wei Yanquan*  
Wei Yanquan  
(Chief Engineer)

Date *Aug 14, 2015*

Report No.: BL-SZ1570025-601

EUT Type: BLUETOOTH SHOWER SPEAKER

Model Name: SM-35270

Brand Name: N/A

Test Standard: 47 CFR Part 15 Subpart C

FCC ID: 2AFIGSM-35270

Test conclusion: Pass

Test Date: Jul. 20, 2015 ~ Jul. 28, 2015

Date of Issue: Aug. 14, 2015

NOTE: This test report can be duplicated completely for the legal use with the approval of the applicant; it shall not be reproduced except in full, without the written approval of Shenzhen BALUN Technology Co., Ltd. BALUN Laboratory. Any objections should be raised within thirty days from the date of issue. To validate the report, please visit BALUN website.

**Revision History**

<u>Version</u>	<u>Issue Date</u>	<u>Revisions</u>
<u>Rev. 01</u>	<u>Jul. 30, 2015</u>	<u>Initial Issue</u>
<u>Rev. 02</u>	<u>Aug. 14, 2015</u>	<u>The Second Issue</u>

**TABLE OF CONTENTS**

TABLE OF CONTENTS.....	2
1 ADMINISTRATIVE DATA (GENERAL INFORMATION).....	6
1.1 Identification of the Testing Laboratory.....	6
1.2 Identification of the Responsible Testing Location.....	6
1.3 Announce.....	6
2 PRODUCT INFORMATION.....	7
2.1 Applicant.....	7
2.2 Manufacturer.....	7
2.3 General Description for Equipment under Test (EUT).....	7
2.4 Technical Information.....	7
2.5 Ancillary Equipment.....	8
3 SUMMARY OF TEST RESULTS.....	8
3.1 Test Standards.....	8
3.2 Verdict.....	9
4 GENERAL TEST CONFIGURATIONS.....	9
4.1 Test Environments.....	9
4.2 Test Equipment List.....	9
4.3 Test Configurations.....	10
4.4 Description of Test Setup.....	10
4.4.1 For Antenna Port Test.....	10
4.4.2 For AC Power Supply Port Test.....	11
4.4.3 For Radiated Test (Below 30 MHz).....	12
4.4.4 For Radiated Test (30 MHz-1 GHz).....	12
4.4.5 For Radiated Test (Above 1 GHz).....	13
4.5 Test Conditions.....	13

4.6 Measurement Results Explanation Example.....	14
4.6.1 For conducted test items:.....	14
4.6.2 For radiated band edges and spurious emission test:.....	14
5 TEST ITEMS.....	15
5.1 Antenna Requirements.....	15
5.1.1 Standard Applicable.....	15
5.1.2 Antenna Anti-Replacement Construction.....	15
5.1.3 Antenna Gain.....	15
5.2 Number of Hopping Frequency.....	16
5.2.1 Limit.....	16
5.2.2 Test Setup.....	16
5.2.3 Test Procedure.....	16
5.2.4 Test Result.....	16
5.3 Peak Output Power.....	17
5.3.1 Test Limit.....	17
5.3.2 Test Setup.....	17
5.3.3 Test Procedure.....	17
5.3.4 Test Result.....	17
5.4 Occupied Bandwidth.....	18
5.4.1 Limit.....	18
5.4.2 Test Setup.....	18
5.4.3 Test Procedure.....	18
5.4.4 Test Result.....	18
5.5 Carrier Frequency Separation.....	19
5.5.1 Limit.....	19
5.5.2 Test Setup.....	19
5.5.3 Test Procedure.....	19
5.5.4 Test Result.....	19
5.6 Time of Occupancy (Dwell time).....	20
5.6.1 Limit.....	20
5.6.2 Test Setup.....	20
5.6.3 Test Procedure.....	20

5.6.4 Test Result.....	20
5.7 Conducted Spurious Emission.....	21
5.7.1 Limit.....	21
5.7.2 Test Setup.....	21
5.7.3 Test Procedure.....	21
5.7.4 Test Result.....	21
5.8 Conducted Emission.....	22
5.8.1 Limit.....	22
5.8.2 Test Setup.....	22
5.8.3 Test Procedure.....	22
5.8.4 Test Result.....	22
5.9 Radiated Spurious Emission.....	23
5.9.1 Limit.....	23
5.9.2 Test Setup.....	23
5.9.3 Test Procedure.....	23
5.9.4 Test Result.....	24
5.10 Band Edge.....	25
5.10.1 Limit.....	25
5.10.2 Test Setup.....	25
5.10.3 Test Procedure.....	25
5.10.4 Test Result.....	25
ANNEX A TEST RESULT.....	26
A.1 Number of Hopping Frequency.....	26
A.2 Peak Output Power.....	30
A.3 20 dB and 99% bandwidth.....	36
A.4 Hopping Frequency Separation.....	42
A.5 Average Time of Occupancy.....	44
A.6 Conducted Spurious Emissions.....	50
A.7 Conducted Emissions.....	63
A.8 Radiated Emission.....	65
A.9 Band Edge.....	92
ANNEX B TEST SETUP PHOTOS.....	99



ANNEX C EUT EXTERNAL PHOTOS.....	99
ANNEX D EUT INTERNAL PHOTOS.....	99

# 1 ADMINISTRATIVE DATA (GENERAL INFORMATION)

## 1.1 Identification of the Testing Laboratory

Company Name	Shenzhen BALUN Technology Co., Ltd.
Address	Block B, 1st FL, Baisha Science and Technology Park, Shahe Xi Road, Nanshan District, Shenzhen, Guangdong Province, P. R. China
Phone Number	+86 755 6683 3402
Fax Number	+86 755 6182 4271

## 1.2 Identification of the Responsible Testing Location

Test Location	Shenzhen BALUN Technology Co., Ltd.
Address	Block B, 1st FL, Baisha Science and Technology Park, Shahe Xi Road, Nanshan District, Shenzhen, Guangdong Province, P. R. China
Accreditation Certificate	<p>The laboratory has been listed by Industry Canada to perform electromagnetic emission measurements. The recognition numbers of test site are 11524A-1.</p> <p>The laboratory has been listed by US Federal Communications Commission to perform electromagnetic emission measurements. The recognition numbers of test site are 832625.</p> <p>The laboratory has met the requirements of the IAS Accreditation Criteria for Testing Laboratories (AC89), has demonstrated compliance with ISO/IEC Standard 17025:2005. The accreditation certificate number is TL-588.</p> <p>The laboratory is a testing organization accredited by China National Accreditation Service for Conformity Assessment (CNAS) according to ISO/IEC 17025. The accreditation certificate number is L6791.</p>
Description	All measurement facilities used to collect the measurement data are located at Block B, FL 1, Baisha Science and Technology Park, Shahe Xi Road, Nanshan District, Shenzhen, Guangdong Province, P. R. China 518055

## 1.3 Announce

- (1) The test report reference to the report template version v1.0.
- (2) The test report is invalid if not marked with the signatures of the persons responsible for preparing and approving the test report.
- (3) The test report is invalid if there is any evidence and/or falsification.
- (4) The results documented in this report apply only to the tested sample, under the conditions and modes of operation as described herein.
- (5) This document may not be altered or revised in any way unless done so by BALUN and all revisions are duly noted in the revisions section.
- (6) Content of the test report, in part or in full, cannot be used for publicity and/or promotional purposes without prior written approval from the laboratory.

## 2 PRODUCT INFORMATION

### 2.1 Applicant

Applicant	Grand Star Industrial Limited
Address	10F., NO.322, SEC.1, NEIHURD.,NEIHU DISTRICT, TAIPEI, TAIWAN (R.O.C.)

### 2.2 Manufacturer

Manufacturer	Shenzhen of Pindu Electronic Co.,LTD
Address	6/F, Bao yun da Logistics Center, Complex Building Three, Baoan District, Xixiang, shenzhen

### 2.3 General Description for Equipment under Test (EUT)

EUT Type	BLUETOOTH SHOWER SPEAKER
Model Name	SM-35270
Hardware Version	N/A
Software Version	N/A
Network and Wireless connectivity	Bluetooth 3.0
About the Product	The equipment is BLUETOOTH SHOWER SPEAKER, it contains Bluetooth 3.0 operating at 2.4 GHz ISM band. The Bluetooth 3.0 was tested in this report.

### 2.4 Technical Information

Modulation Technology	FHSS
Modulation Type	GFSK, $\pi/4$ -DQPSK, 8-DPSK
Transfer Rate	1 Mbps, 2 Mbps, 3 Mbps
Frequency Range	The frequency range used is 2402 MHz – 2480 MHz; The frequency block is 2400 MHz to 2483.5 MHz.
Number of channel	79 (at intervals of 1 MHz)
Tested Channel	0 (2402 MHz), 39 (2441 MHz), 78 (2480 MHz).
Antenna Type	PCB Antenna
Antenna Gain	0 dBi (All involve the antenna gain test item, has been included in the final results)

Note: The above EUT information in section 2.3 and 2.4 was declared by manufacturer and for more detailed features description, please refer to the manufacturer's specifications or user's manual.

## 2.5 Ancillary Equipment

Ancillary Equipment 1	Battery	
	Brand Name	N/A
	Model No	053040
	Serial No	(N/A. marked #1 by test site)
	Capacitance	300 mAh
	Rated Voltage	3.7 V
	Extreme Voltage	Low: 3.0 V / High: 4.2 V
Ancillary Equipment 2	USB Cable	
	Length	50 cm



### 3 SUMMARY OF TEST RESULTS

#### 3.1 Test Standards

No.	Identity	Document Title
1	47 CFR Part 15, Subpart C (10-1-14 Edition)	Miscellaneous Wireless Communications Services
2	FCC PUBLIC NOTICE DA 00-705 (Mar. 30, 2000)	Filling and Measurement Guidelines for Frequency Hopping Spread Spectrum Systems
3	ANSI C63.4-2009	American National Standard for Standard for Methods of Measurement of Radio-Noise Emissions from Low-Voltage Electrical and Electronic Equipment in the Range of 9 kHz to 40 GHz
4	ANSI C63.10-2009	American National Standard for Testing Unlicensed Wireless Devices

### 3.2 Verdict

No.	Description	FCC Part No.	Test Result	Verdict
1	Antenna Requirement	15.203	--	Pass <sup>Note 1</sup>
2	Number of Hopping Frequency	15.247(a)	ANNEX A.1	Pass
3	Peak Output Power	15.247(b)	ANNEX A.2	Pass
4	Occupied Bandwidth	15.247(a)	ANNEX A.3	Pass
5	Carrier Frequency Separation	15.247(a)	ANNEX A.4	Pass
6	Time of Occupancy (Dwell time)	15.247(a)	ANNEX A.5	Pass
7	Conducted Spurious Emission	15.247(d)	ANNEX A.6	Pass
8	Conducted Emission	15.207	ANNEX A.7	Pass
9	Radiated Spurious Emission	15.209 15.247(d)	ANNEX A.8	Pass
10	Band Edge	15.209 15.247(d)	ANNEX A.9	Pass

Note 1: The EUT has a permanently and irreplaceable attached antenna, which complies with the requirement FCC 15.203.

## 4 GENERAL TEST CONFIGURATIONS

### 4.1 Test Environments

During the measurement, the normal environmental conditions were within the listed ranges:

Relative Humidity	45% - 55%	
Atmospheric Pressure	100 kPa - 102 kPa	
Temperature	NT (Normal Temperature)	-22°C to +25°C
Working Voltage of the EUT	NV (Normal Voltage)	3.7 V

### 4.2 Test Equipment List

Description	Manufacturer	Model	Serial No.	Cal. Date	Cal. Due
Spectrum Analyzer	ROHDE&SCHWARZ	FSV-30	103118	2015.07.16	2016.07.15
Vector Signal Generator	ROHDE&SCHWARZ	SMBV100A	177746	2015.07.16	2016.07.15
Signal Generator	ROHDE&SCHWARZ	SMB100A	260592	2015.07.01	2016.06.30
Switch Unit with OSP-B157	ROHDE&SCHWARZ	OSP120	101270	2015.07.16	2016.07.15
Spectrum Analyzer	AGILENT	E4440A	MY45304434	2014.10.18	2015.10.17
EMI Receiver	ROHDE&SCHWARZ	ESRP	101036	2015.07.14	2016.07.13
LISN	SCHWARZBECK	NSLK 8127	8127-687	2015.07.14	2016.07.13
Bluetooth Tester	ROHDE&SCHWARZ	CBT	101005	2015.07.16	2016.07.15
Power Splitter	KMW	DCPD-LDC	1305003215	2015.07.01	2016.06.30
Power Sensor	ROHDE&SCHWARZ	NRP-Z21	103971	2015.07.21	2016.07.20
Attenuator (20 dB)	KMW	ZA-S1-201	110617091	--	--
Attenuator (6 dB)	KMW	ZA-S1-61	1305003189	--	--
DC Power Supply	ROHDE&SCHWARZ	HMP2020	018141664	2015.07.17	2016.07.16
Temperature Chamber	ANGELANTIONI SCIENCE	NTH64-40A	1310	2014.11.20	2015.11.19
Test Antenna-Loop(9 kHz-30 MHz)	SCHWARZBECK	FMZB 1519	1519-037	2015.07.22	2017.07.21
Test Antenna-Bi-Log(30 MHz-3 GHz)	SCHWARZBECK	VULB 9163	9163-624	2015.07.22	2017.07.21
Test Antenna-Horn(1-18 GHz)	SCHWARZBECK	BBHA 9120D	9120D-1148	2015.07.22	2017.07.21
Test Antenna-Horn(15-26.5 GHz)	SCHWARZBECK	BBHA 9170	9170-305	2015.07.22	2017.07.21
Anechoic Chamber	RAINFORD	9m*6m*6m	N/A	2015.02.28	2016.02.27
Shielded Enclosure	ChangNing	CN-130701	130703	--	--

### 4.3 Test Configurations

Test Configurations (TC) NO.	Description	
	Signal Description	Operating Frequency
<b>Transmitter</b>		
TC01	GFSK modulation, package type DH5, hopping on	--
TC02	GFSK modulation, package type DH5, hopping off	Ch No. 0/ 2402 MHz
TC03	GFSK modulation, package type DH5, hopping off	Ch No. 39/ 2441 MHz
TC04	GFSK modulation, package type DH5, hopping off	Ch No. 78/ 2480 MHz
TC05	$\pi/4$ -DQPSK modulation, package type DH5, hopping on	--
TC06	$\pi/4$ -DQPSK modulation, package type DH5, hopping off	Ch No. 0/ 2402 MHz
TC07	$\pi/4$ -DQPSK modulation, package type DH5, hopping off	Ch No. 39/ 2441 MHz
TC08	$\pi/4$ -DQPSK modulation, package type DH5, hopping off	Ch No. 78/ 2480 MHz
TC09	8DPSK modulation, package type DH5, hopping on	--
TC10	8DPSK modulation, package type DH5, hopping off	Ch No. 0/ 2402 MHz
TC11	8DPSK modulation, package type DH5, hopping off	Ch No. 39/ 2441 MHz
TC12	8DPSK modulation, package type DH5, hopping off	Ch No. 78/ 2480 MHz

### 4.4 Description of Test Setup

#### 4.4.1 For Antenna Port Test

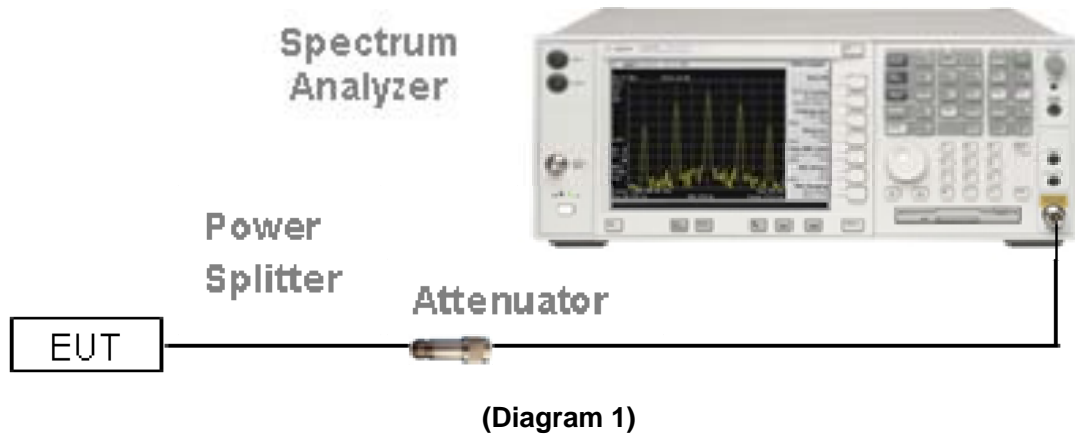

4.4.2 For AC Power Supply Port Test

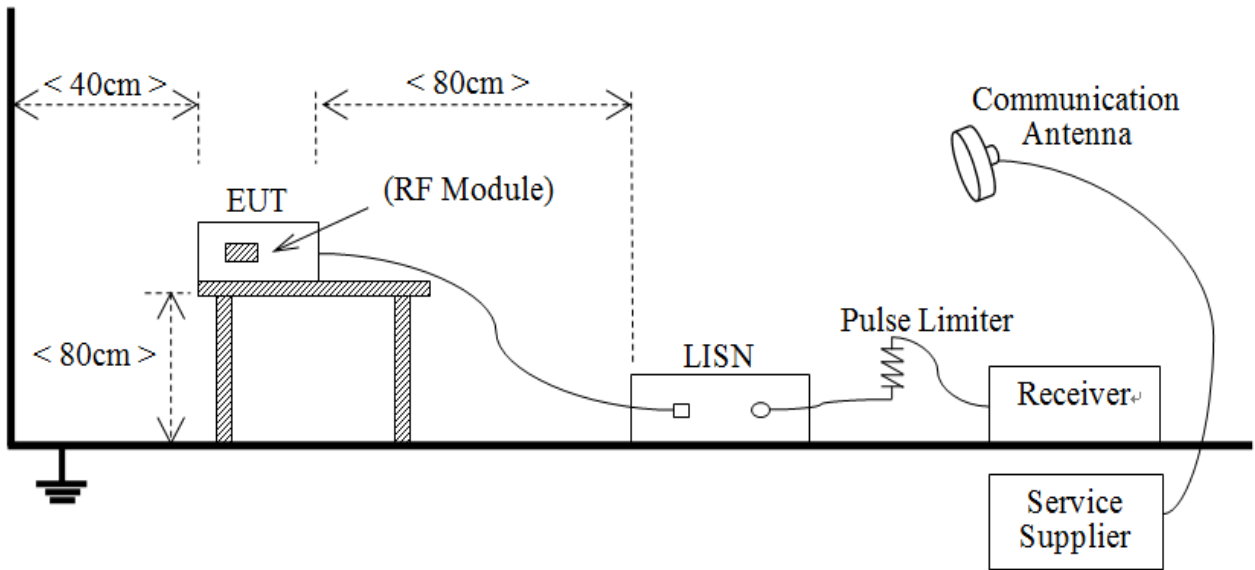

(Diagram 2)

4.4.3 For Radiated Test (Below 30 MHz)

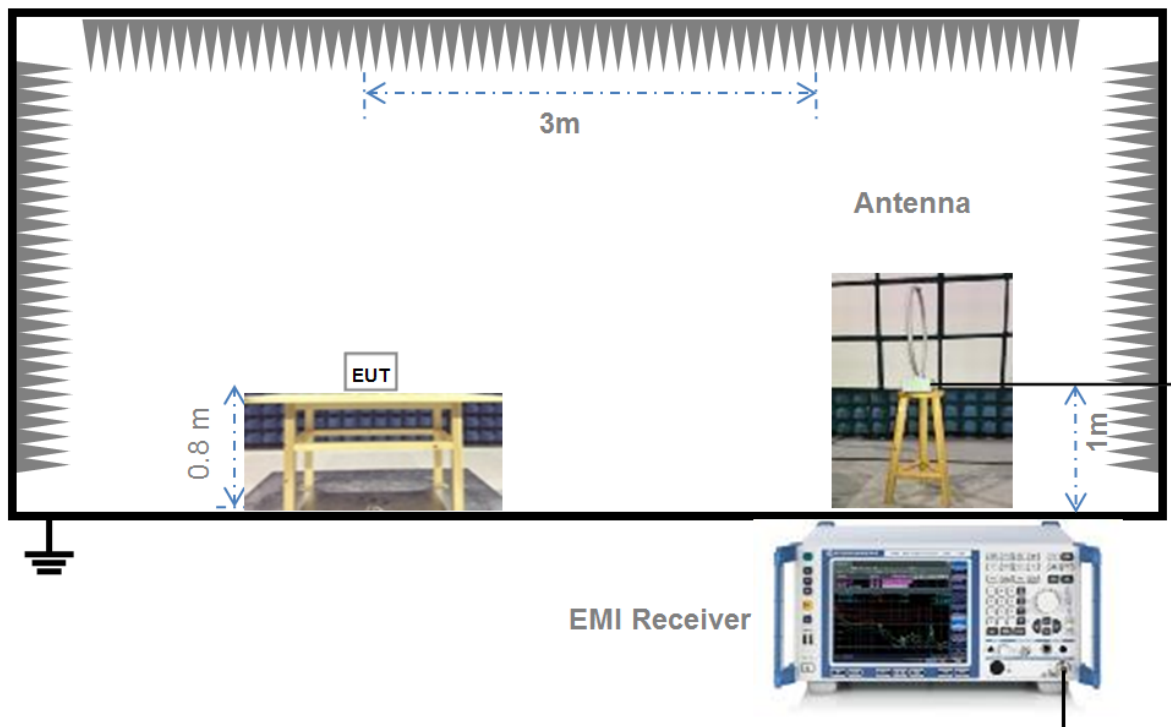

(Diagram 3)

4.4.4 For Radiated Test (30 MHz-1 GHz)

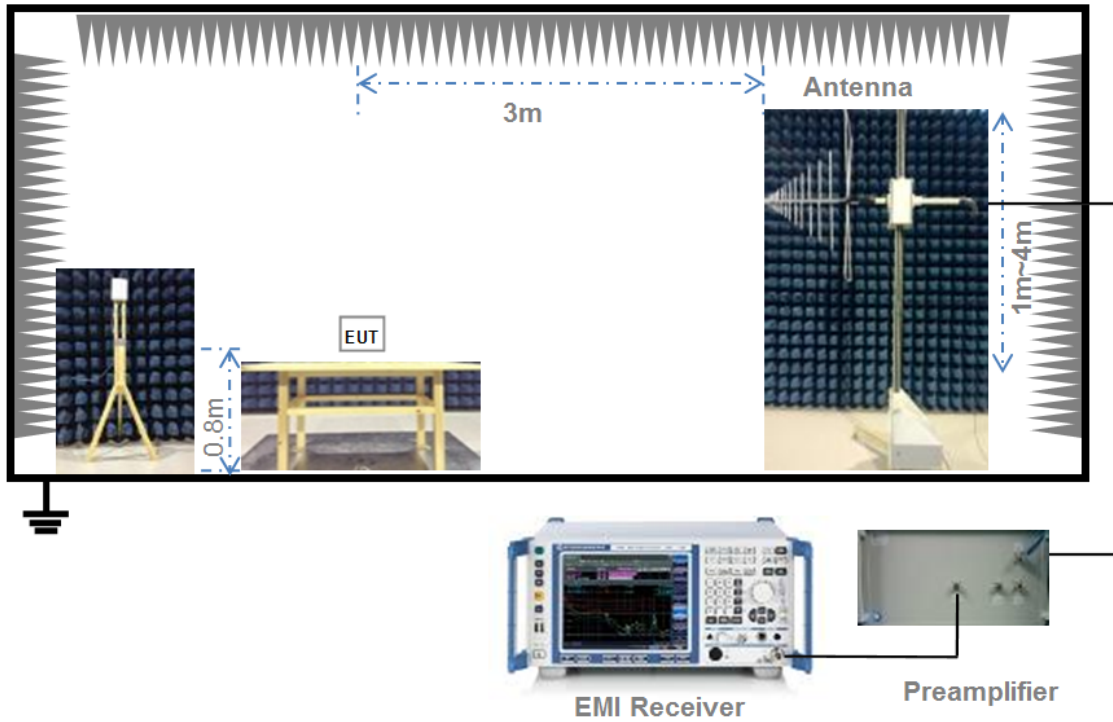

(Diagram 4)

4.4.5 For Radiated Test (Above 1 GHz)

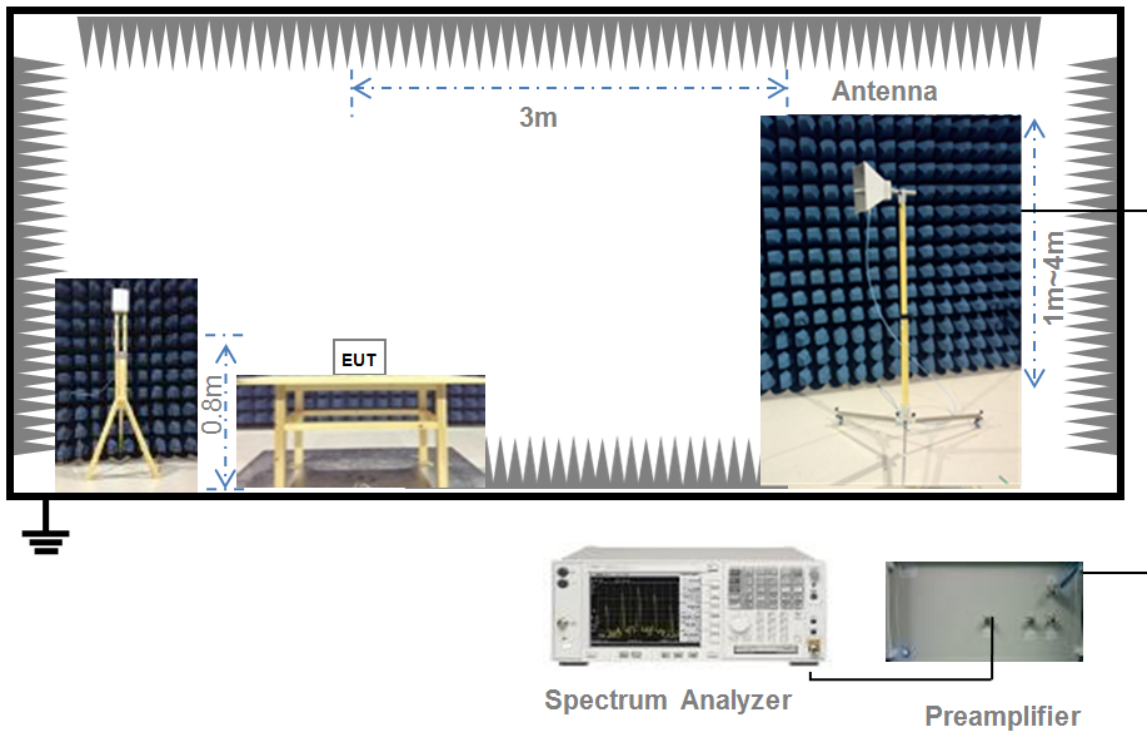

(Diagram 5)

## 4.5 Test Conditions

Test Case	Test Conditions		
	Test Env.	Test Setup <sup>Note 1</sup>	Test Configuration <sup>Note 2</sup>
Number of Hopping Frequency	NTNV	Test Setup 1	TC01, TC05, TC09
Peak Output Power	NTNV	Test Setup 1	TC02, TC03, TC04, TC06, TC07, TC08, TC10, TC11, TC12
Occupied Bandwidth	NTNV	Test Setup 1	TC02, TC03, TC04, TC06, TC07, TC08, TC10, TC11, TC12
Carrier Frequency Separation	NTNV	Test Setup 1	TC01, TC05, TC09
Time of Occupancy (Dwell time)	NTNV	Test Setup 1	TC01, TC05, TC09
Conducted Spurious Emission	NTNV	Test Setup 1	TC02, TC03, TC04, TC06, TC07, TC08, TC10, TC11, TC12
Conducted Emission	NTNV	Test Setup 2	TC01, TC02, TC03, TC04, TC05, TC06, TC07, TC08, TC09, TC10, TC11, TC12
Radiated Emission	NTNV	Test Setup 3 Test Setup 4 Test Setup 5	TC01, TC02, TC03, TC04, TC05, TC06, TC07, TC08, TC09, TC10, TC11, TC12
Band Edge	NTNV	Test Setup 5	TC01, TC02, TC04, TC05, TC06, TC08, TC09, TC10, TC12
Note: 1. Please refer to section 4.4 for test setup details. 2. Please refer to section 4.3 for test configuration details.			

## 4.6 Measurement Results Explanation Example

### 4.6.1 For conducted test items:

The offset level is set in the spectrum analyzer to compensate the RF cable loss and attenuator between EUT conducted output port and spectrum analyzer. With the offset compensation, the spectrum analyzer reading level is exactly the EUT RF output level.

The spectrum analyzer offset is derived from RF cable loss and attenuator factor.

Offset = RF cable loss + attenuator factor.

### 4.6.2 For radiated band edges and spurious emission test:

Per part 15.35(c), the EUT Bluetooth average emission level could be determined by the peak emission level applying duty cycle correction factor, to represent averaging over the whole pulse train.

The average level is derived from the peak level corrected with "Duty cycle correction factor".

Average Emission Level (dBuV/m) = Peak Emission Level (dBuV/m) + Duty cycle correction factor (dB)

Duty cycle correction factor (dB) =  $20 * \log(\text{Duty cycle})$ .

Duty cycle = on time / 100 milliseconds

On time = dwell time \* hopping number in 100 ms

For example: bluetooth with dwell time 2.9 ms and 3 hops in 100 ms, then

Duty cycle correction factor (dB) =  $20 * \log((2.9 * 3) / 100) = -21.21 \text{ dB}$

Following shows an average computation example with duty cycle correction factor = -21.21 dB, and the peak emission level is 45.61 dBuV/m.

Example:

Average Emission Level (dBuV/m) = Peak Emission Level (dBuV/m) + duty cycle correction factor (dB)

=  $45.61 + (-21.21) = 24.4 \text{ (dBuV/m)}$



## 5 TEST ITEMS

### 5.1 Antenna Requirements

#### 5.1.1 Standard Applicable

FCC §15.203 & 15.247(b)

An intentional radiator shall be designed to ensure that no antenna other than that furnished by the responsible party shall be used with the device. The use of a permanently attached antenna or of an antenna that uses a unique coupling to the intentional radiator shall be considered sufficient to comply with the provisions of this section. The manufacturer may design the unit so that a broken antenna can be replaced by the user, but the use of a standard antenna jack or electrical connector is prohibited. This requirement does not apply to carrier current devices or to devices operated under the provisions of § 15.211, § 15.213, § 15.217, § 15.219, or § 15.221. Further, this requirement does not apply to intentional radiators that must be professionally installed, such as perimeter protection systems and some field disturbance sensors, or to other intentional radiators which, in accordance with § 15.31(d), must be measured at the installation site. However, the installer shall be responsible for ensuring that the proper antenna is employed so that the limits in this part are not exceeded.

If directional gain of transmitting antennas is greater than 6 dBi, the power shall be reduced by the same level in dB comparing to gain minus 6 dBi. For the fixed point-to-point operation, the power shall be reduced by one dB for every 3 dB that the directional gain of the antenna exceeds 6 dBi. The use of a permanently attached antenna or of an antenna that uses a unique coupling to the intentional radiator shall be considered sufficient to comply with the FCC rule.

#### 5.1.2 Antenna Anti-Replacement Construction

The Antenna Anti-Replacement as following method:

Protected Method	Description
The antenna is An embedded-in	The antenna is welded on the mainboard, can't be replaced by the consumer

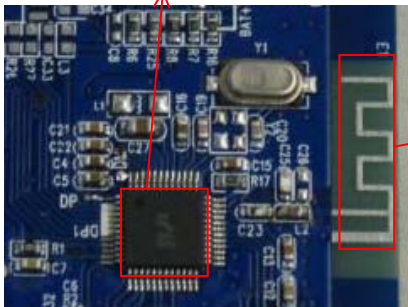
Reference Documents	Item
Photo	<div style="display: flex; align-items: center;"> <div style="border: 1px solid red; padding: 2px; margin-right: 10px;">RF Chip</div>  </div>

#### 5.1.3 Antenna Gain

The antenna peak gain of EUT is less than 6 dBi. Therefore, it is not necessary to reduce maximum peak output power limit.

## 5.2 Number of Hopping Frequency

### 5.2.1 Limit

FCC §15.247(a) (1) (iii)

Frequency hopping systems operating in the 2400 MHz to 2483.5 MHz bands shall use at least 15 hopping frequencies.

### 5.2.2 Test Setup

See section 4.1.1 for test setup description for the antenna port. The photo of test setup please refer to ANNEX B.

### 5.2.3 Test Procedure

The EUT must have its hopping function enabled. Use the following spectrum analyzer settings:

Span = the frequency band of operation

RBW  $\geq$  1% of the span

VBW  $\geq$  RBW

Sweep = auto

Detector function = peak

Trace = max hold

Allow the trace to stabilize

### 5.2.4 Test Result

Please refer to ANNEX A.1.

## 5.3 Peak Output Power

### 5.3.1 Test Limit

FCC § 15.247(b)

For frequency hopping systems that operates in the 2400 MHz to 2483.5 MHz band employing at least 75 hopping channels, the maximum peak output power of the intentional radiator shall not exceed 1 Watt.

### 5.3.2 Test Setup

See section 4.1.1 for test setup description for the antenna port. The photo of test setup please refer to ANNEX B.

### 5.3.3 Test Procedure

The Bluetooth Module operates at hopping-off test mode. The lowest, middle and highest channels are selected to perform testing to verify the conducted RF output peak power of the Module.

Use the following spectrum analyzer settings:

Span = approximately 5 times the 20 dB bandwidth, centered on a hopping channel

RBW > the 20 dB bandwidth of the emission being measured

VBW  $\geq$  RBW

Sweep = auto

Detector function = peak

Trace = max hold

Allow the trace to stabilize.

### 5.3.4 Test Result

Please refer to ANNEX A.2.

## 5.4 Occupied Bandwidth

### 5.4.1 Limit

FCC §15.247(a)

The 20 dB bandwidth is known as the 99% emission bandwidth, or 20 dB bandwidth ( $10 \cdot \log 1\% = 20$  dB) taking the total RF output power.

### 5.4.2 Test Setup

See section 4.1.1 for test setup description for the antenna port. The photo of test setup please refer to ANNEX B.

### 5.4.3 Test Procedure

Use the following spectrum analyzer settings:

Span = approximately 2 to 3 times the 20 dB bandwidth, centered on a hopping channel

RBW  $\geq$  1% of the 20 dB bandwidth

VBW  $\geq$  RBW

Sweep = auto

Detector function = peak

Trace = max hold

The EUT should be transmitting at its maximum data rate, Allow the trace to stabilize.

### 5.4.4 Test Result

Please refer to ANNEX A.3.

## 5.5 Carrier Frequency Separation

### 5.5.1 Limit

FCC §15.247(a)

Frequency hopping systems shall have hopping channel carrier frequencies separated by a minimum of 25 kHz or two-thirds of the 20 dB bandwidth of the hopping channel, whichever is greater.

### 5.5.2 Test Setup

See section 4.1.1 for test setup description for the antenna port. The photo of test setup please refer to ANNEX B.

### 5.5.3 Test Procedure

The EUT must have its hopping function enabled. Use the following spectrum analyzer settings:

Span = wide enough to capture the peaks of two adjacent channels

Resolution (or IF) Bandwidth (RBW)  $\geq$  1% of the span

Video (or Average) Bandwidth (VBW)  $\geq$  RBW

Sweep = auto

Detector function = peak

Trace = max hold

Allow the trace to stabilize. Use the marker-delta function to determine the separation between the peaks of the adjacent channels.

### 5.5.4 Test Result

Please refer to ANNEX A.4.

## 5.6 Time of Occupancy (Dwell time)

### 5.6.1 Limit

FCC §15.247(a)

Frequency hopping systems in the 2400 MHz - 2483.5 MHz band shall use at least 15 non-overlapping channels. The average time of occupancy on any channel shall not be greater than 0.4 seconds within a period of 0.4 seconds multiplied by the number of hopping channels employed. Frequency hopping systems may avoid or suppress transmissions on a particular hopping frequency provided that a minimum of 15 channels are used.

### 5.6.2 Test Setup

See section 4.1.1 for test setup description for the antenna port. The photo of test setup please refer to ANNEX B.

### 5.6.3 Test Procedure

The average time of occupancy on any channel within the Period can be calculated with formulas:

For DH1 package type

$$\{\text{Total of Dwell}\} = \{\text{Pulse Time}\} * (1600 / 2) / \{\text{Number of Hopping Frequency}\} * \{\text{Period}\}$$

$$\{\text{Period}\} = 0.4 \text{ s} * \{\text{Number of Hopping Frequency}\}$$

For DH3 package type

$$\{\text{Total of Dwell}\} = \{\text{Pulse Time}\} * (1600 / 4) / \{\text{Number of Hopping Frequency}\} * \{\text{Period}\}$$

$$\{\text{Period}\} = 0.4 \text{ s} * \{\text{Number of Hopping Frequency}\}$$

For DH5 package type

$$\{\text{Total of Dwell}\} = \{\text{Pulse Time}\} * (1600 / 6) / \{\text{Number of Hopping Frequency}\} * \{\text{Period}\}$$

$$\{\text{Period}\} = 0.4 \text{ s} * \{\text{Number of Hopping Frequency}\}$$

The lowest, middle and highest channels are selected to perform testing to record the dwell time of each occupation measured in this channel, which is called Pulse Time here.

### 5.6.4 Test Result

Please refer to ANNEX A.5

## 5.7 Conducted Spurious Emission

### 5.7.1 Limit

FCC §15.247(d)

In any 100 kHz bandwidth outside the frequency band in which the spread spectrum or digitally modulated intentional radiator is operating, the radio frequency power that is produced by the intentional radiator shall be at least 20 dB below that in the 100 kHz bandwidth within the band that contains the highest level of the desired power, based on either an RF conducted or a radiated measurement.

### 5.7.2 Test Setup

See section 4.1.1 for test setup description for the antenna port. The photo of test setup please refer to ANNEX B.

### 5.7.3 Test Procedure

Use the following spectrum analyzer settings:

Span = wide enough to capture the peak level of the in-band emission and all spurious emissions (e.g., harmonics) from the lowest frequency generated in the EUT up through the 10th harmonic. Typically, several plots are required to cover this entire span.

RBW = 100 kHz

VBW  $\geq$  RBW

Sweep = auto

Detector function = peak

Trace = max hold

Allow the trace to stabilize

### 5.7.4 Test Result

Please refer to ANNEX A.6.

## 5.8 Conducted Emission

### 5.8.1 Limit

FCC §15.207

For an intentional radiator that is designed to be connected to the public utility (AC) power line, the radio frequency voltage that is conducted back onto the AC power line on any frequency within the band 150 kHz to 30 MHz shall not exceed the limits in the following table, as measured using a 50 $\mu$ H/50 $\Omega$  line impedance stabilization network (LISN).

Frequency range (MHz)	Conducted Limit (dB $\mu$ V)	
	Quai-peak	Average
0.15 - 0.50	66 to 56	56 to 46
0.50 - 5	56	46
0.50 - 30	60	50

### 5.8.2 Test Setup

See section 4.1.1 for test setup description for the antenna port. The photo of test setup please refer to ANNEX B.

### 5.8.3 Test Procedure

The maximum conducted interference is searched using Peak (PK), if the emission levels more than the AV and QP limits, and that have narrow margins from the AV and QP limits will be re-measured with AV and QP detectors. Tests for both L phase and N phase lines of the power mains connected to the EUT are performed. Refer to recorded points and plots below.

### 5.8.4 Test Result

Please refer to ANNEX A.7.



## 5.9 Radiated Spurious Emission

### 5.9.1 Limit

FCC §15.209&15.247(d)

Radiated emission outside the frequency band attenuation below the general limits specified in FCC section 15.209(a) is not required. In addition, radiated emissions which fall in the restricted bands, as defined in FCC section 15.205(a), must also comply with the radiated emission limits specified in FCC section 15.209(a).

According to FCC section 15.209 (a), except as provided elsewhere in this subpart, the emissions from an intentional radiator shall not exceed the field strength levels specified in the following table:

Frequency (MHz)	Field Strength ( $\mu\text{V}/\text{m}$ )	Measurement Distance (m)
0.009 - 0.490	2400/F(kHz)	300
0.490 - 1.705	24000/F(kHz)	30
1.705 - 30.0	30	30
30 - 88	100	3
88 - 216	150	3
216 - 960	200	3
Above 960	500	3

Note:

1. Field Strength (dB $\mu\text{V}/\text{m}$ ) =  $20 \cdot \log[\text{Field Strength } (\mu\text{V}/\text{m})]$ .
2. In the emission tables above, the tighter limit applies at the band edges.
3. For Above 1000 MHz, the emission limit in this paragraph is based on measurement instrumentation employing an average detector, measurement using instrumentation with a peak detector function, corresponding to 20dB above the maximum permitted average limit.
4. For above 1000 MHz, limit field strength of harmonics: 54dB $\mu\text{V}/\text{m}@3\text{m}$  (AV) and 74dB $\mu\text{V}/\text{m}@3\text{m}$  (PK).

### 5.9.2 Test Setup

See section 4.4.2 to 4.4.5 for test setup description for the antenna port. The photo of test setup please refer to ANNEX B.

### 5.9.3 Test Procedure

The measurement frequency range is from 9 kHz to the 10th harmonic of the fundamental frequency. The Turn Table is actuated to turn from  $0^\circ$  to  $360^\circ$ , and both horizontal and vertical polarizations of the Test Antenna are used to find the maximum radiated power. Mid channels on all channel bandwidth verified. Only the worst RB size/offset presented.

The power of the EUT transmitting frequency should be ignored.

All Spurious Emission tests were performed in X, Y, Z axis direction. And only the worst axis test condition was recorded in this test report.

Use the following spectrum analyzer settings:

Span = wide enough to fully capture the emission being measured

RBW = 1 MHz for  $f \geq 1$  GHz, 100 kHz for  $f < 1$  GHz

VBW  $\geq$  RBW

Sweep = auto

Detector function = peak

Trace = max hold

For measurement below 1GHz, If the emission level of the EUT measured by the peak detector is 3 dB lower than the applicable limit, the peak emission level will be reported, Otherwise, the emission measurement will be repeated using the quasi-peak detector and reported.

#### 5.9.4 Test Result

Please refer to ANNEX A.8.

## 5.10 Band Edge

### 5.10.1 Limit

FCC §15.209&15.247(d)

In any 100 kHz bandwidth outside the frequency band in which the spread spectrum or digitally modulated intentional radiator is operating, the radio frequency power that is produced by the intentional radiator shall be at least 20 dB below that in the 100 kHz bandwidth within the band that contains the highest level of the desired power, based on either an RF conducted or a radiated measurement.

### 5.10.2 Test Setup

See section 4.1.1 for test setup description for the antenna port. The photo of test setup please refer to ANNEX B.

### 5.10.3 Test Procedure

Span = wide enough to capture the peak level of the emission operating on the channel closest to the band edge, as well as any modulation products which fall outside of the authorized band of operation

RBW  $\geq$  1% of the span

VBW  $\geq$  RBW

Sweep = auto

Detector function = peak /AV

Trace = max hold

Allow the trace to stabilize.

$E \text{ [dB}\mu\text{V/m]} = \text{UR} + \text{AT} + \text{AFactor [dB]}; \text{AT} = \text{LCable loss [dB]} - \text{Gpreamp [dB]}$

AT: Total correction Factor except Antenna

UR: Receiver Reading

Gpreamp: Preamplifier Gain

AFactor: Antenna Factor at 3m

### 5.10.4 Test Result

Please refer to ANNEX A.9.

## ANNEX A TEST RESULT

### A.1 Number of Hopping Frequency

#### Test Data

Test Mode	Frequency Block (MHz)	Measured Channel Numbers	Min. Limit	Verdict
GFSK	2400 - 2483.5	79	15	Pass
π/4-DQPSK	2400 - 2483.5	79	15	Pass
8-DPSK	2400 - 2483.5	79	15	Pass

#### Test plots

GFSK 2.4 GHz ~ 2.4415 GHz

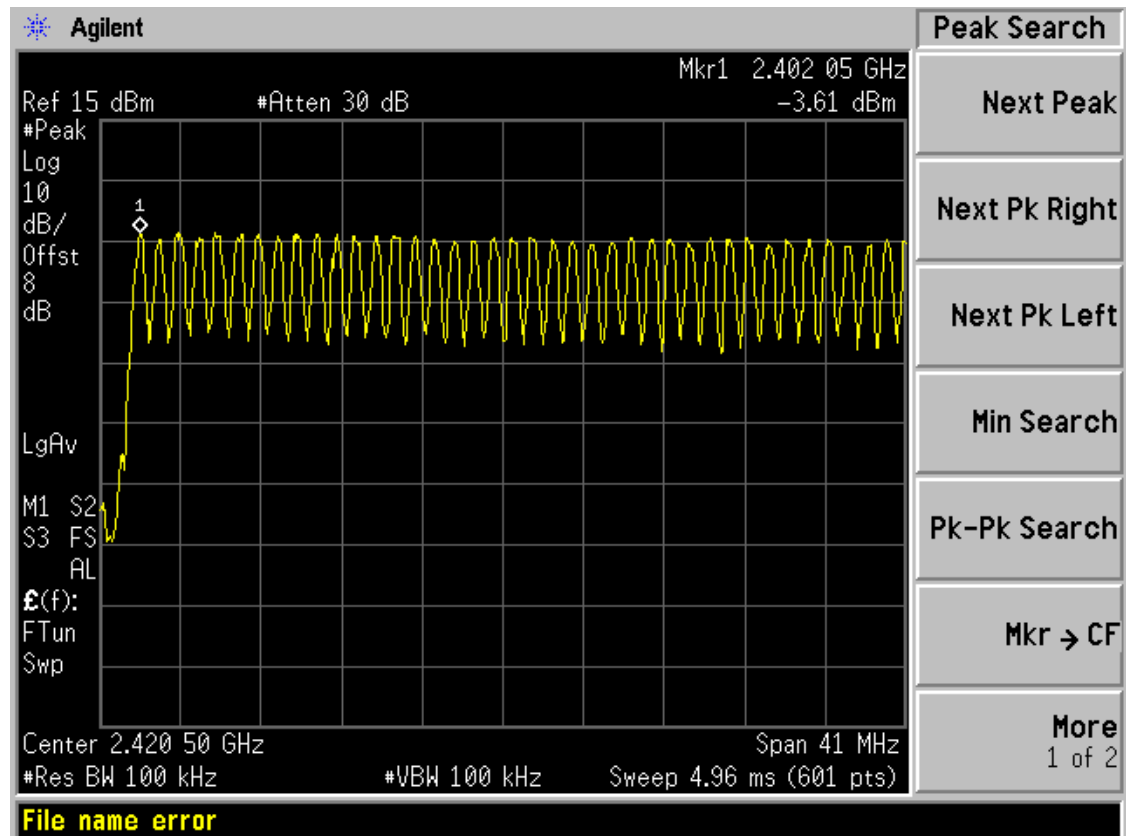

## GFSK 2.4415 GHz ~ 2.4835 GHz

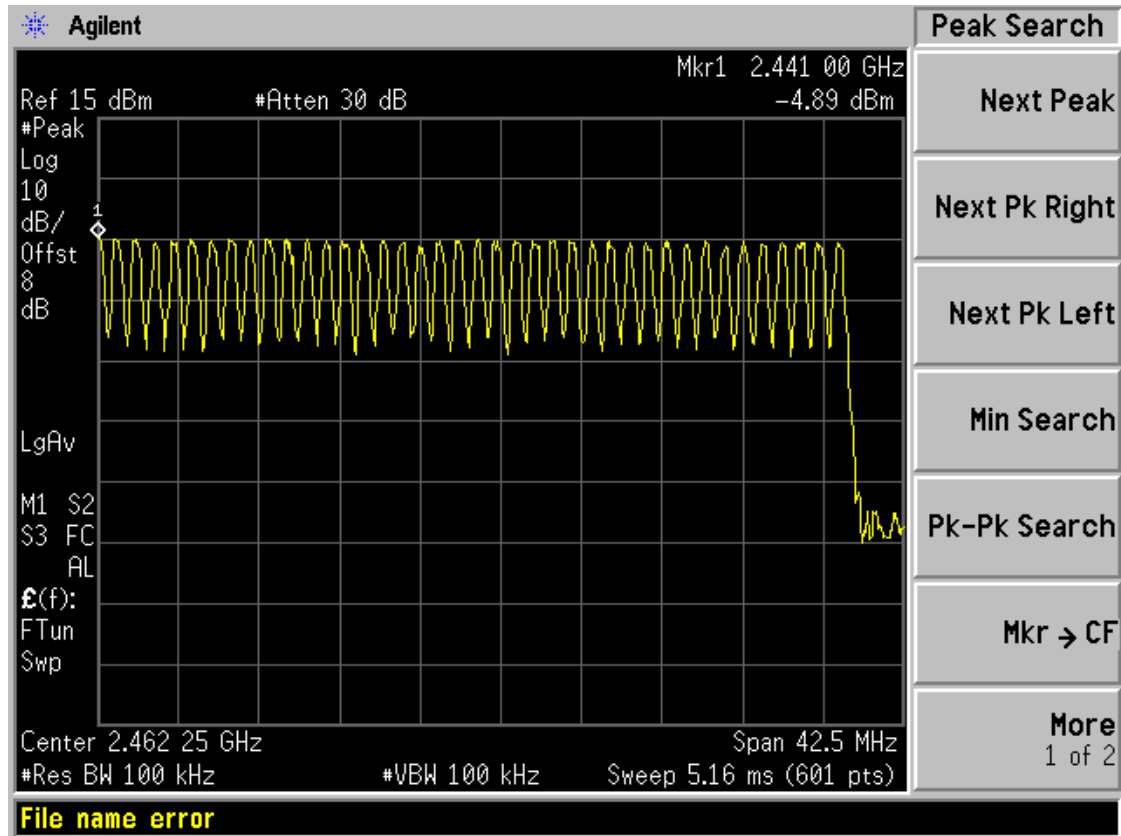

## 1/4-DQPSK 2.4 GHz ~ 2.4415 GHz

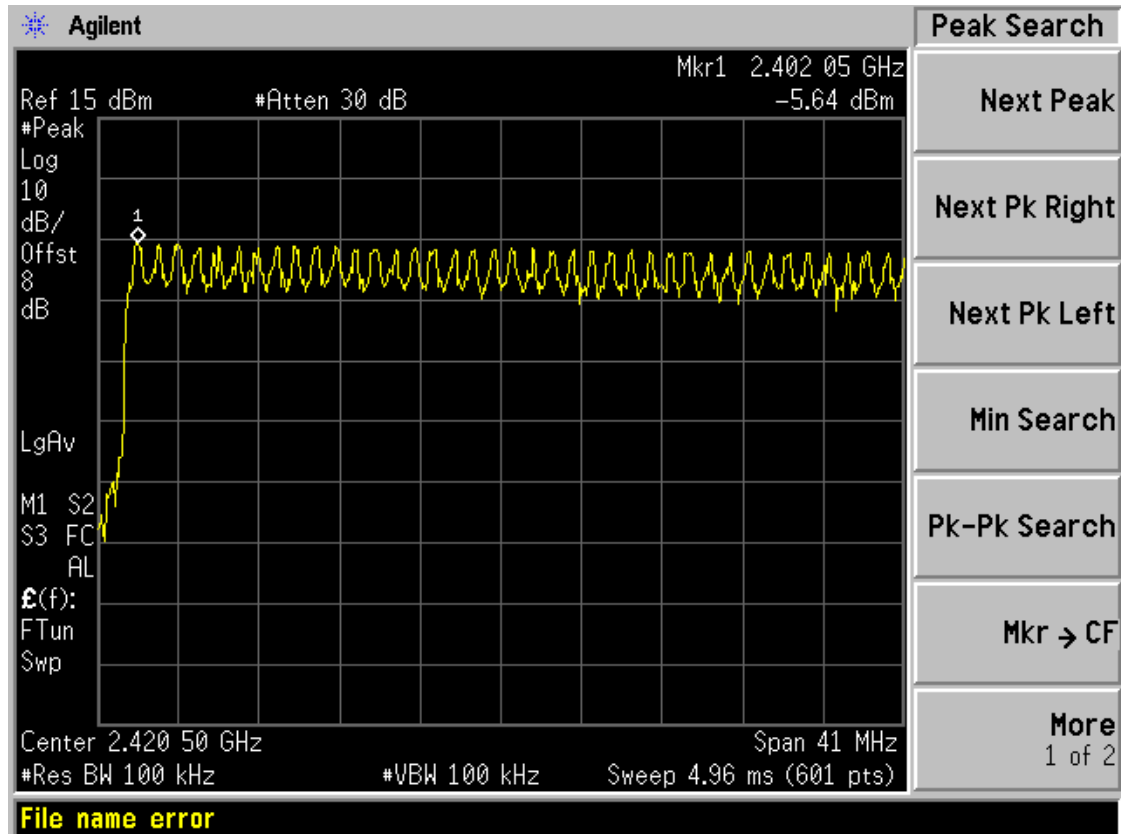

## □/4-DQPSK 2.4415 GHz ~ 2.4835 GHz

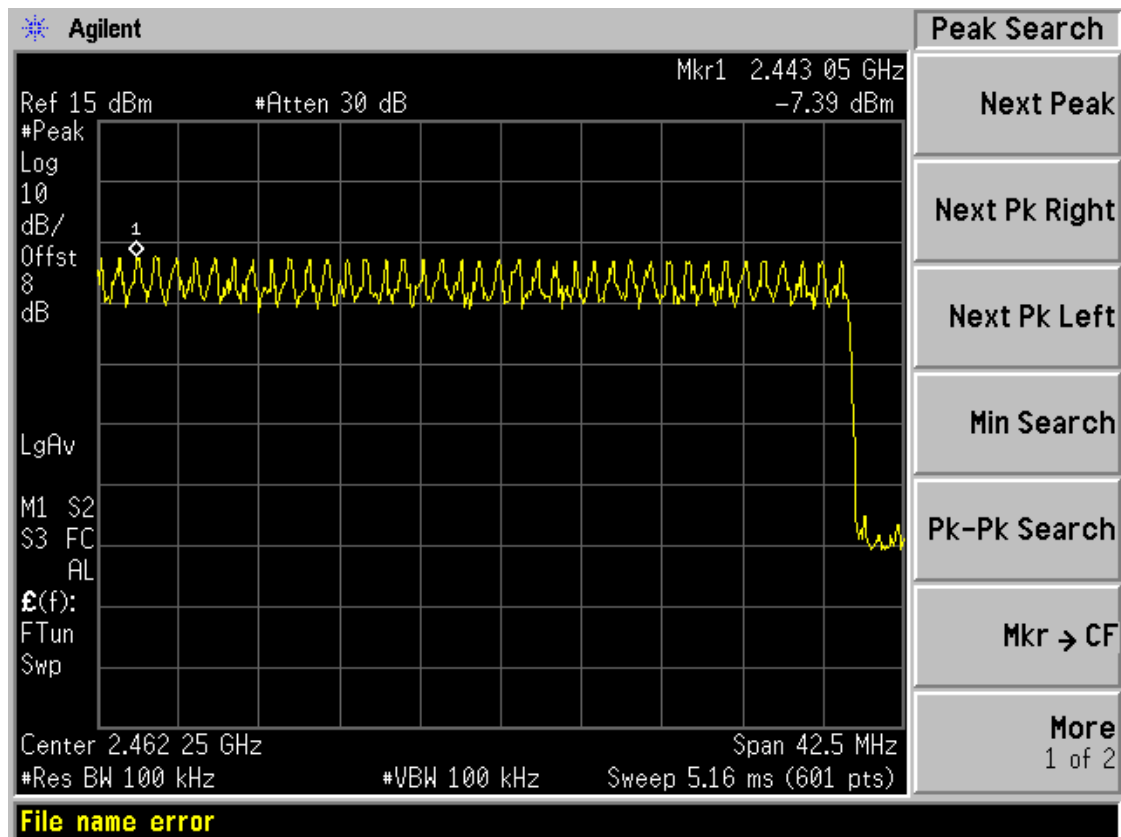

## 8-DPSK 2.4 GHz ~ 2.4415 GHz

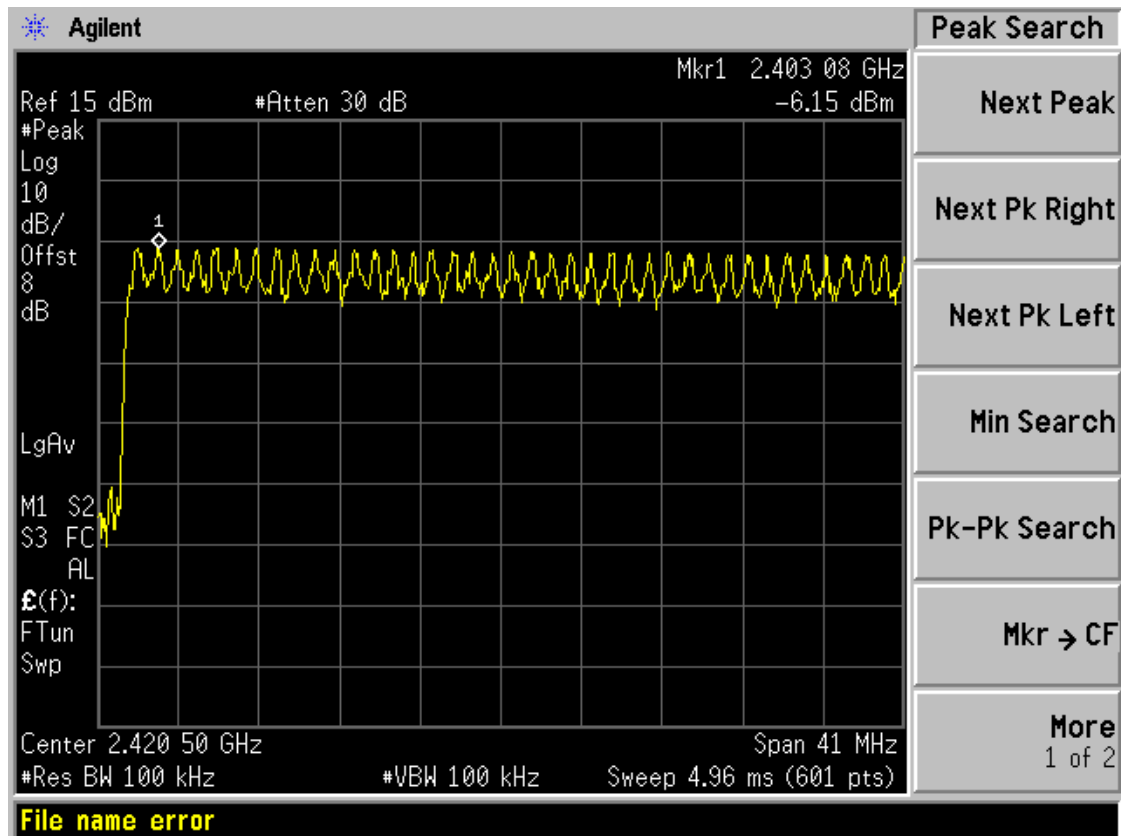

## 8-DPSK 2.4415 GHz ~ 2.4835 GHz

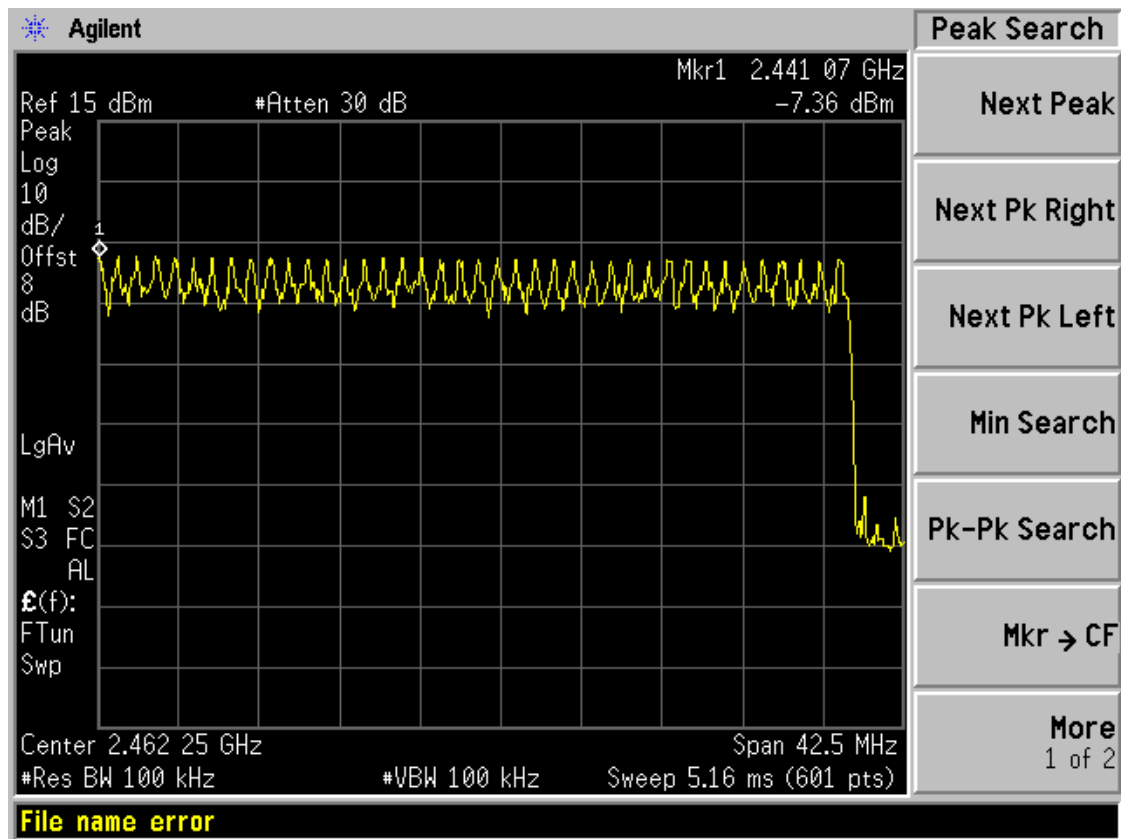

## A.2 Peak Output Power

### Test Data

GFSK Mode:

Channel	Measured Output Peak Power		Limit		Verdict
	dBm	mW	dBm	mW	
Low	-2.91	0.51	30	1000	Pass
Middle	-4.31	0.37			Pass
High	-4.98	0.32			Pass

π/4-DQPSK Mode:

Channel	Measured Output Peak Power		Limit		Verdict
	dBm	mW	dBm	mW	
Low	-4.29	0.37	30	1000	Pass
Middle	-5.56	0.28			Pass
High	-6.19	0.24			Pass

8-DPSK Mode:

Channel	Measured Output Peak Power		Limit		Verdict
	dBm	mW	dBm	mW	
Low	-3.90	0.41	30	1000	Pass
Middle	-4.79	0.33			Pass
High	-5.39	0.29			Pass



## Test plots

## GFSK LOW CHANNEL

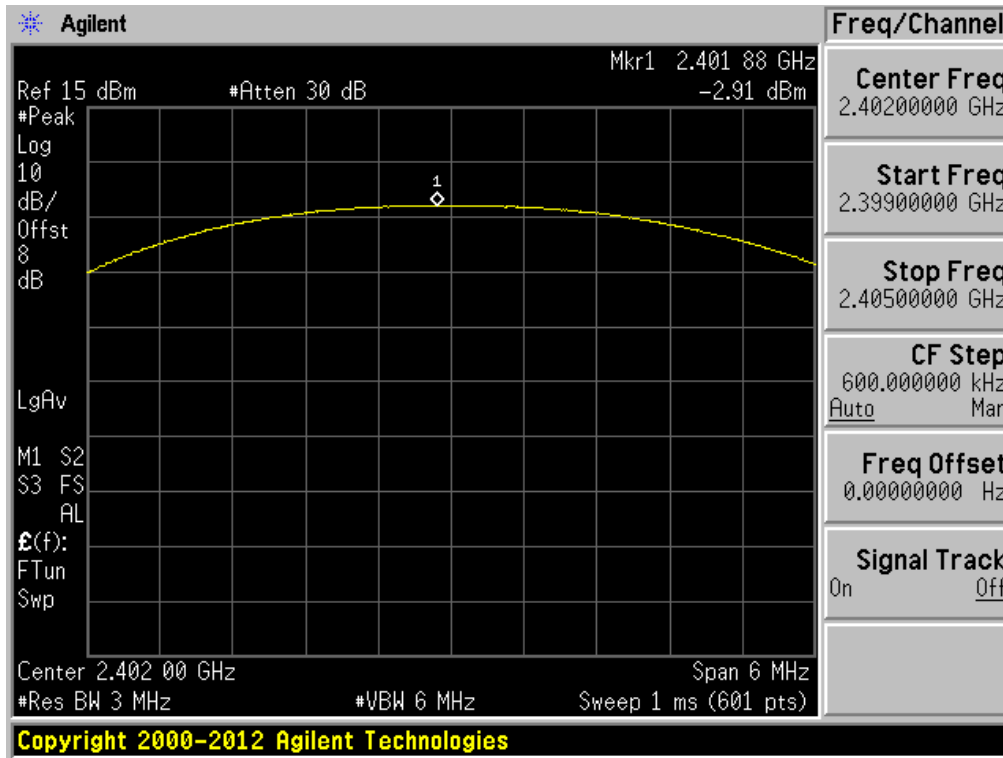

## GFSK MIDDLE CHANNEL

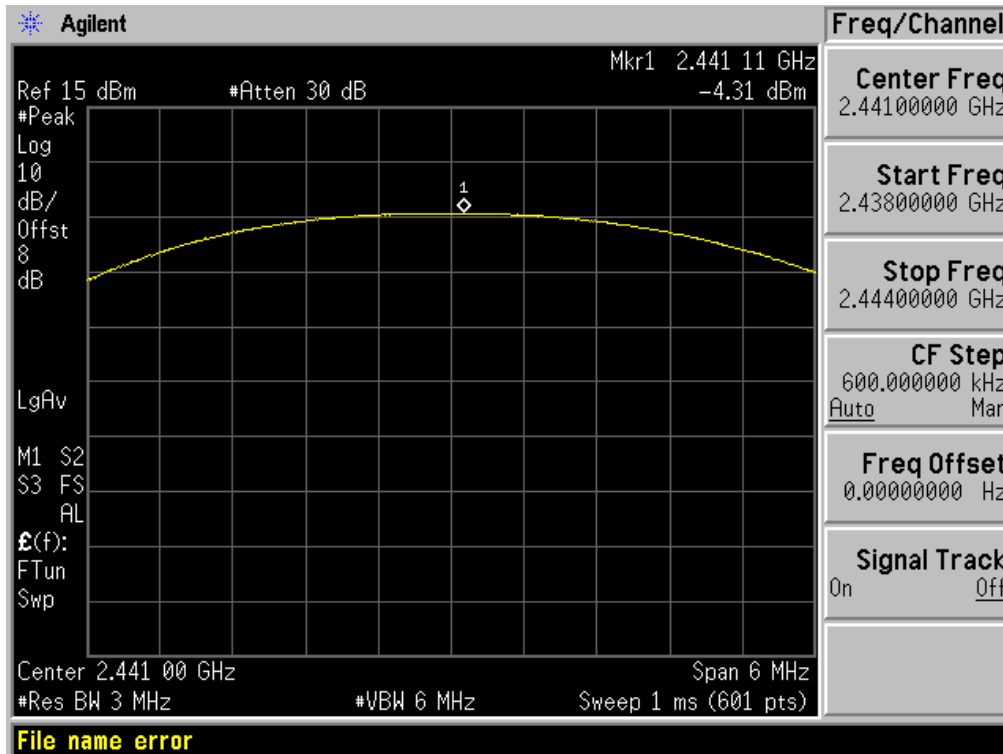

## GFSK HIGH CHANNEL

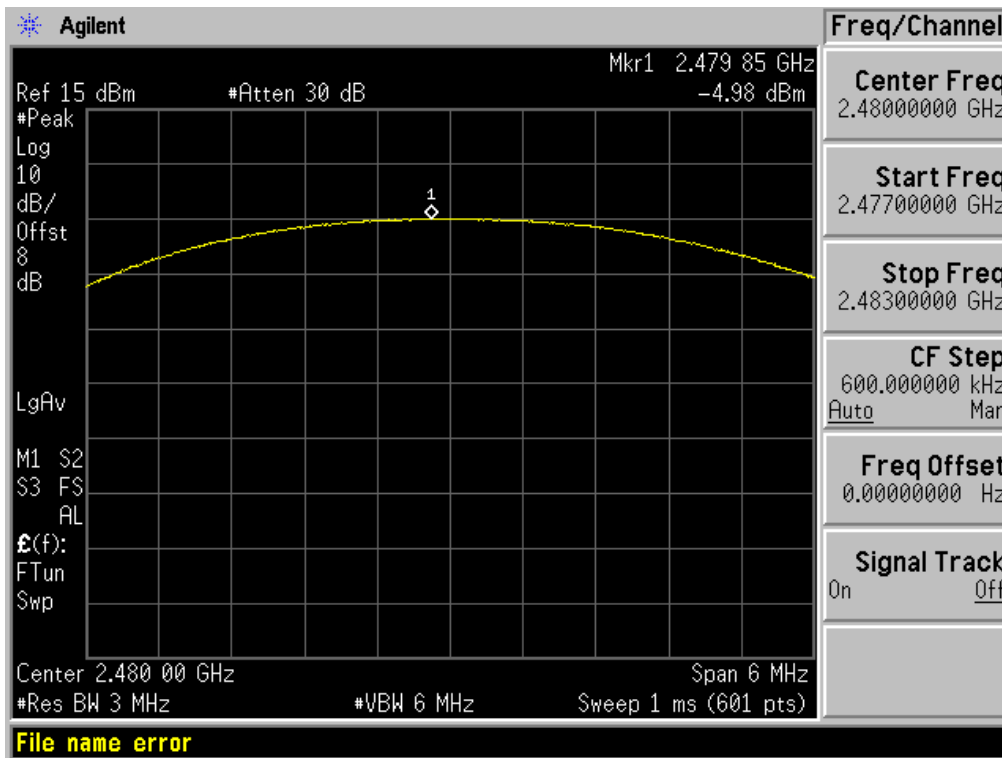

## QPSK LOW CHANNEL

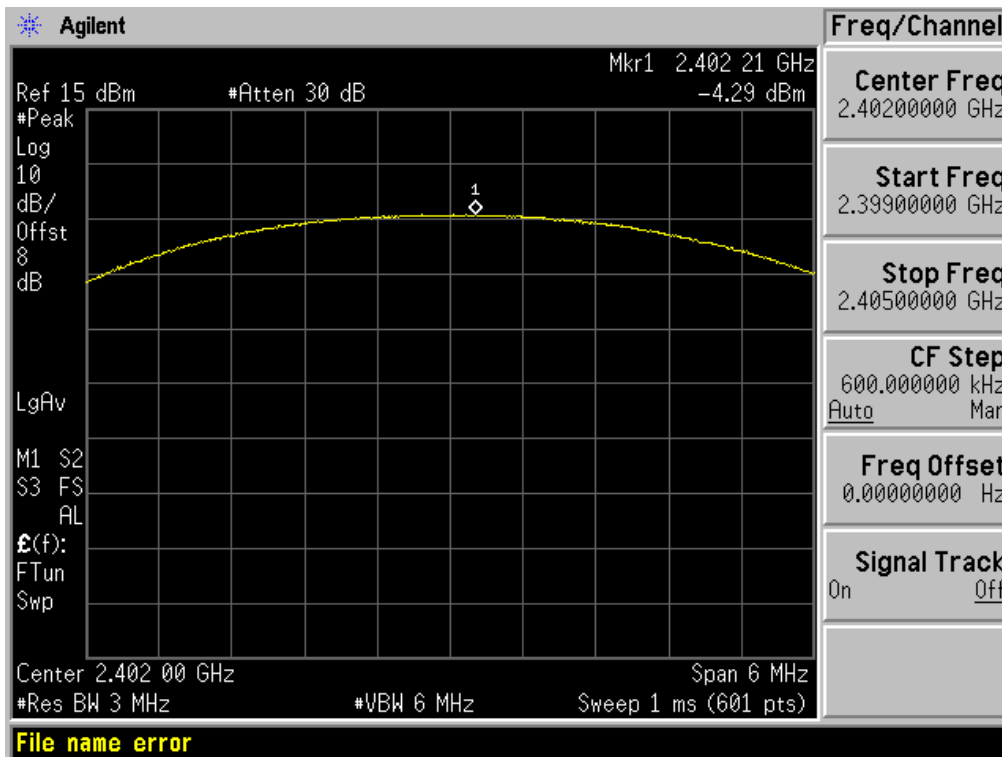

## □/4-DQPSK MIDDLE CHANNEL

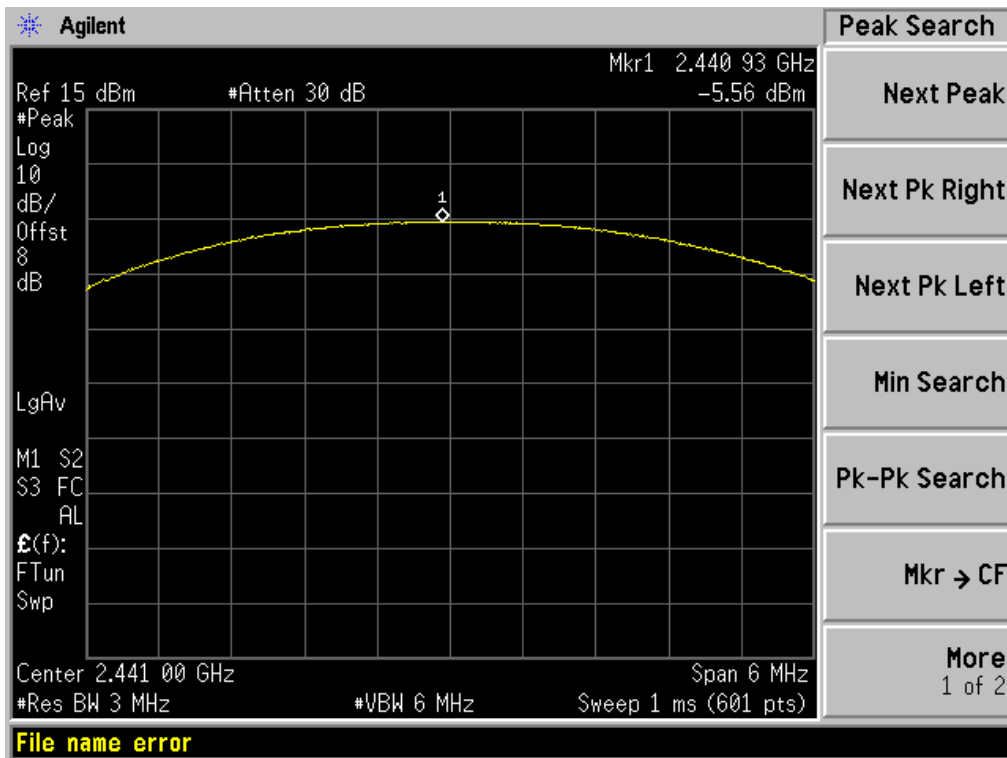

## □/4-DQPSK HIGH CHANNEL

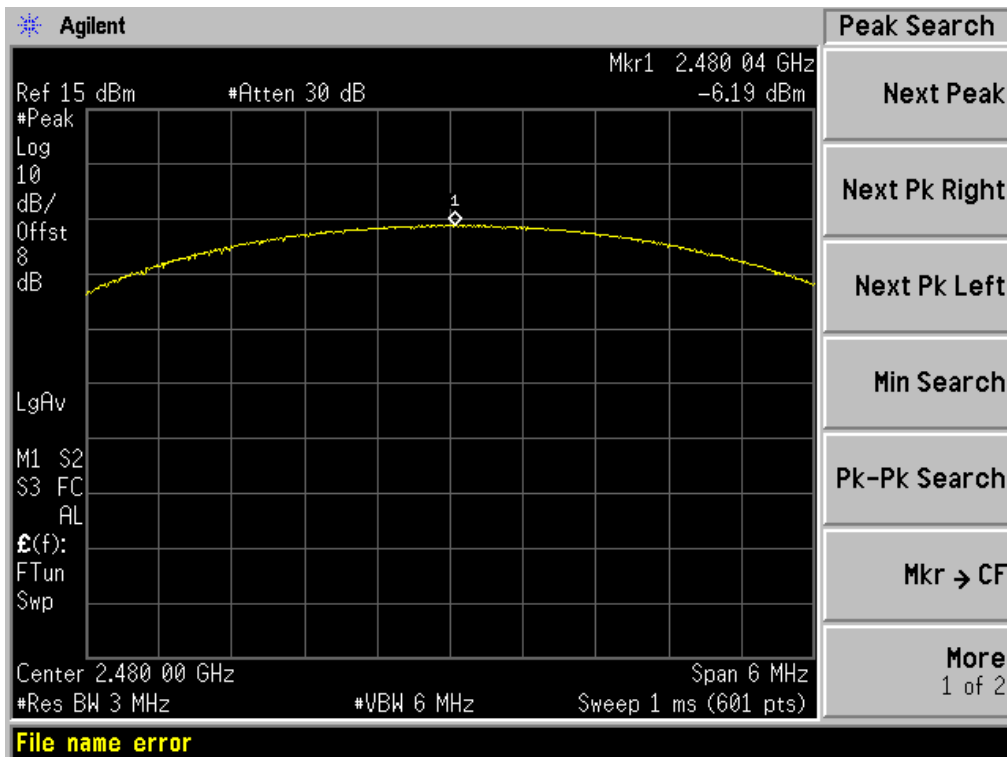

## 8-DPSK LOW CHANNEL

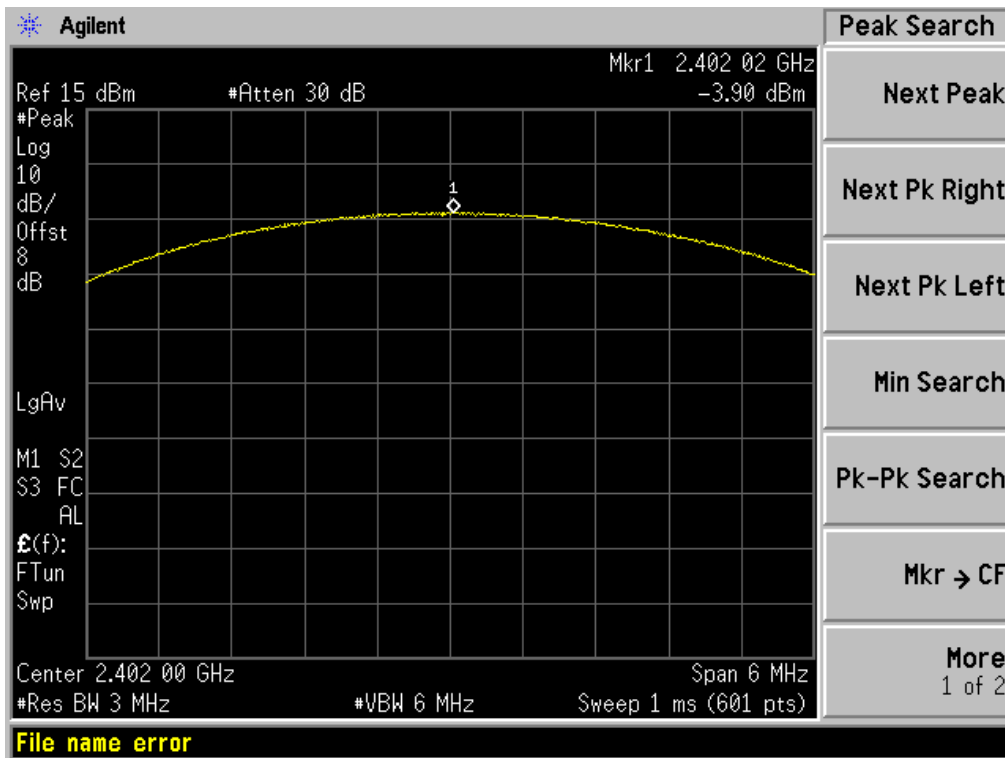

## 8-DPSK MIDDLE CHANNEL

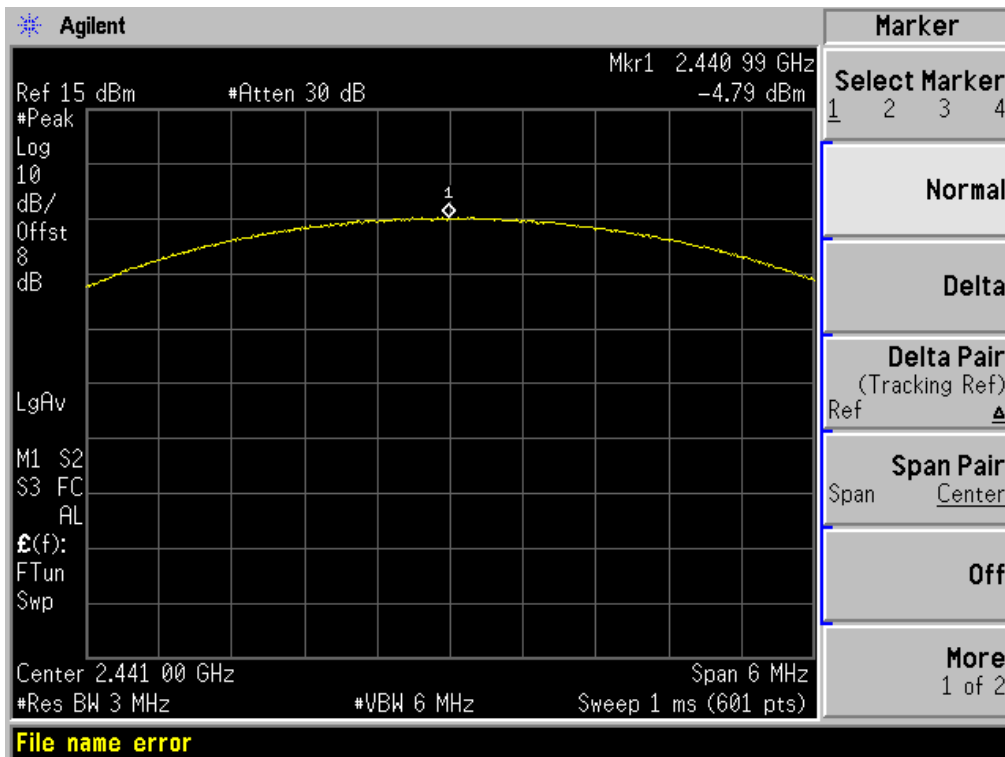

8-DPSK HIGH CHANNEL

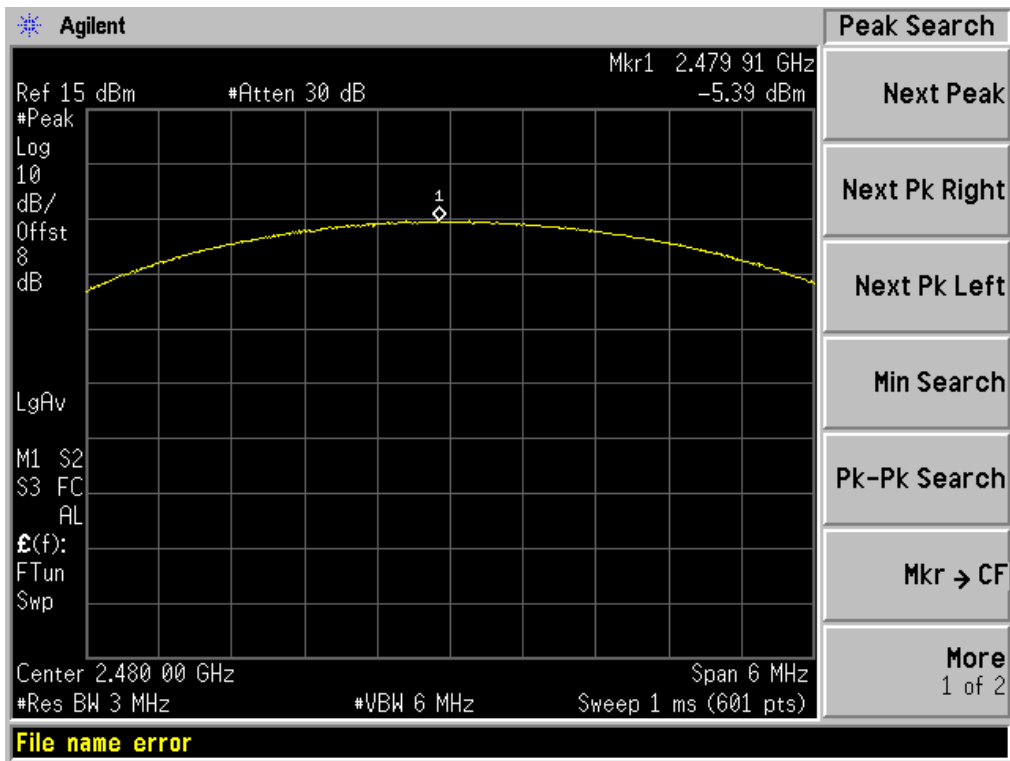

### A.3 20 dB and 99% bandwidth

#### Test Data

GFSK Mode:

Channel	20 dB Bandwidth (MHz)	99% Bandwidth (kHz)
Low	1.140	982.0471
Middle	1.137	984.4278
High	1.136	989.6781

π/4-DQPSK Mode:

Channel	20 dB Bandwidth (MHz)	99% Bandwidth (MHz)
Low	1.383	1.2222
Middle	1.387	1.2201
High	1.334	1.2120

8-DPSK Mode:

Channel	20 dB Bandwidth (MHz)	99% Bandwidth (MHz)
Low	1.385	1.2307
Middle	1.388	1.2303
High	1.385	1.2299

## Test plots

## GFSK LOW CHANNEL

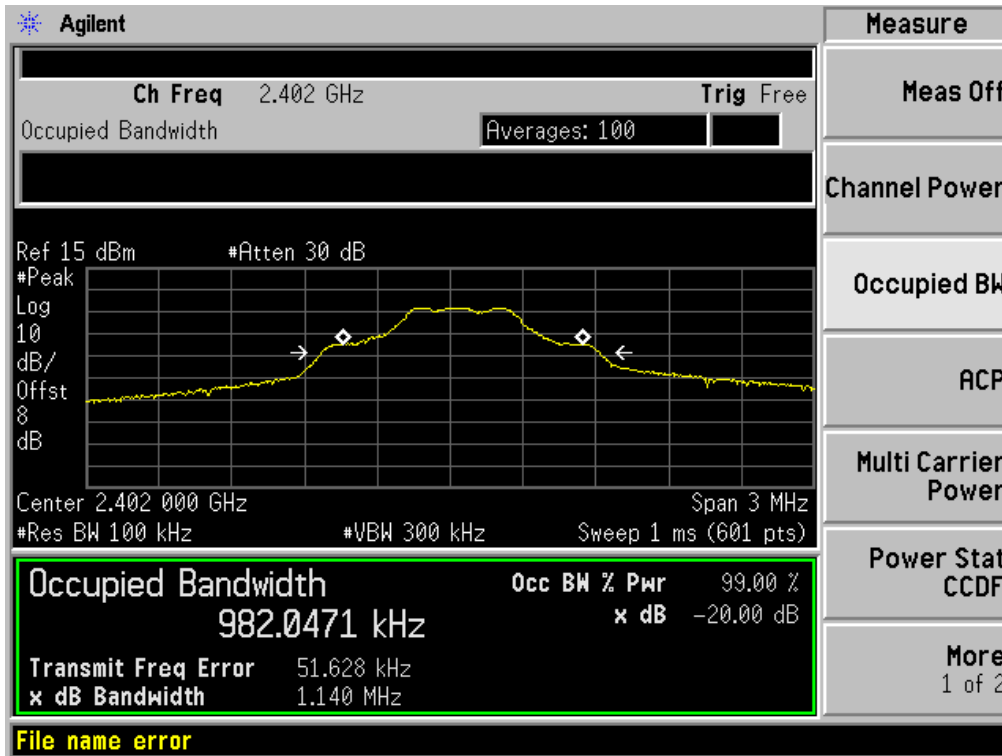

## GFSK MIDDLE CHANNEL

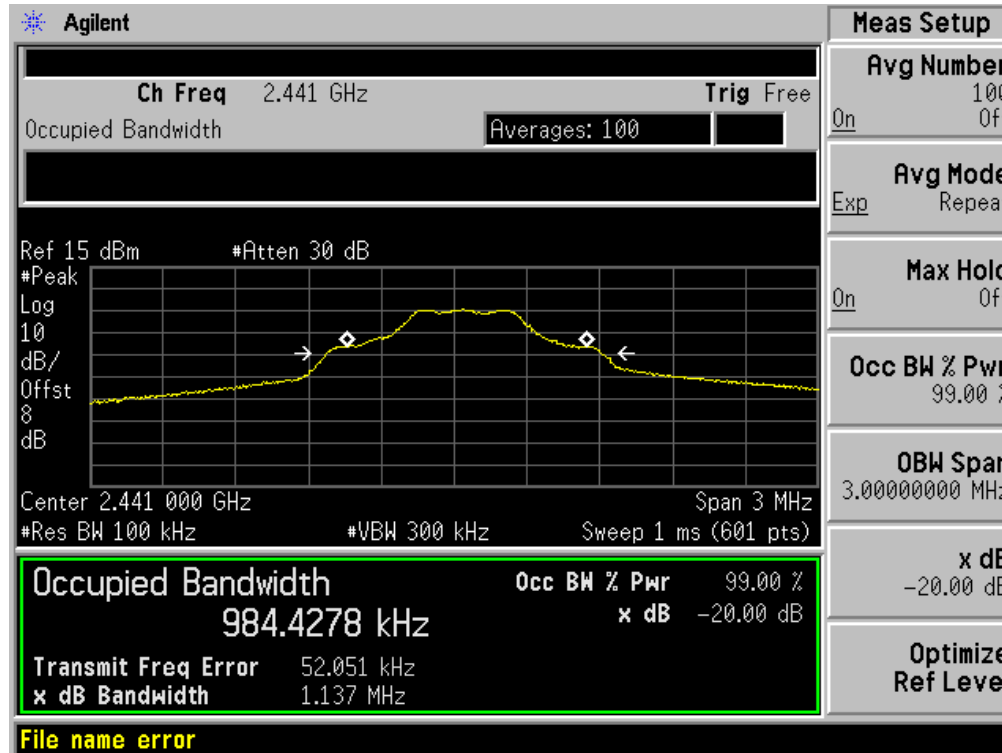

## GFSK HIGH CHANNEL

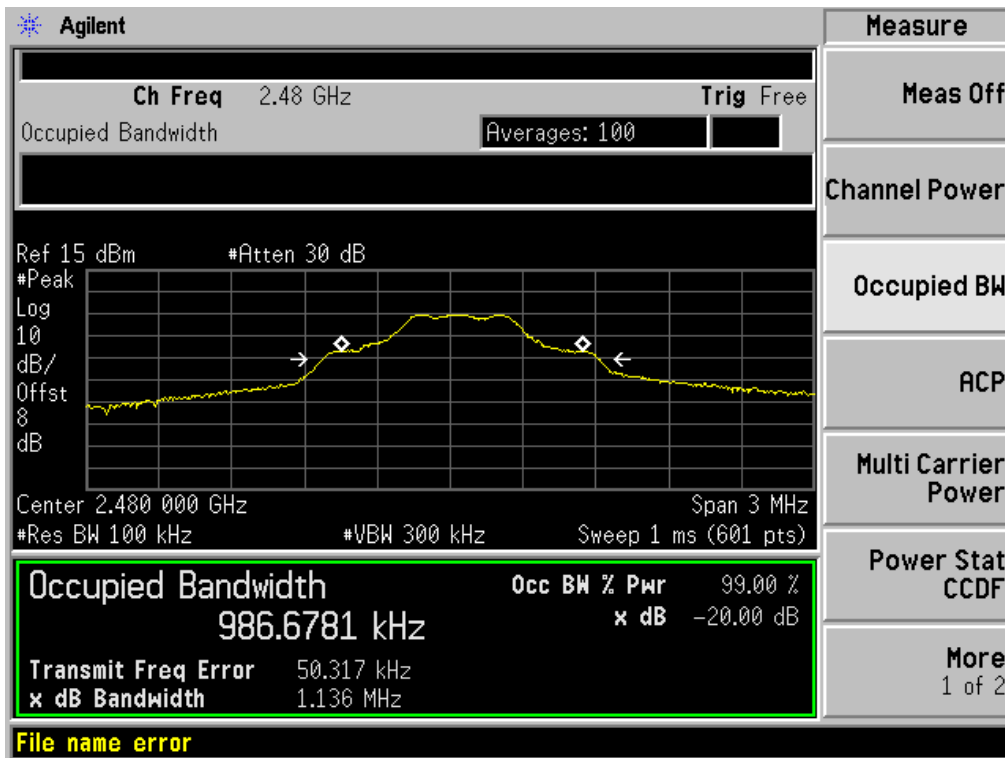

## QPSK LOW CHANNEL

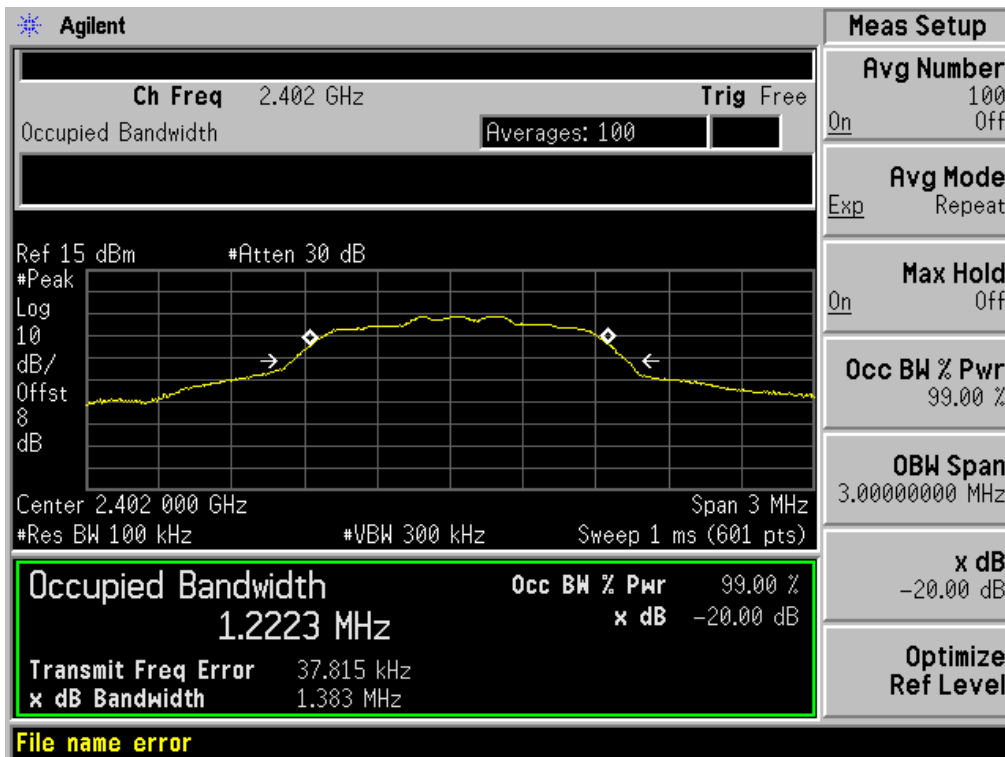



## □/4-DQPSK MIDDLE CHANNEL

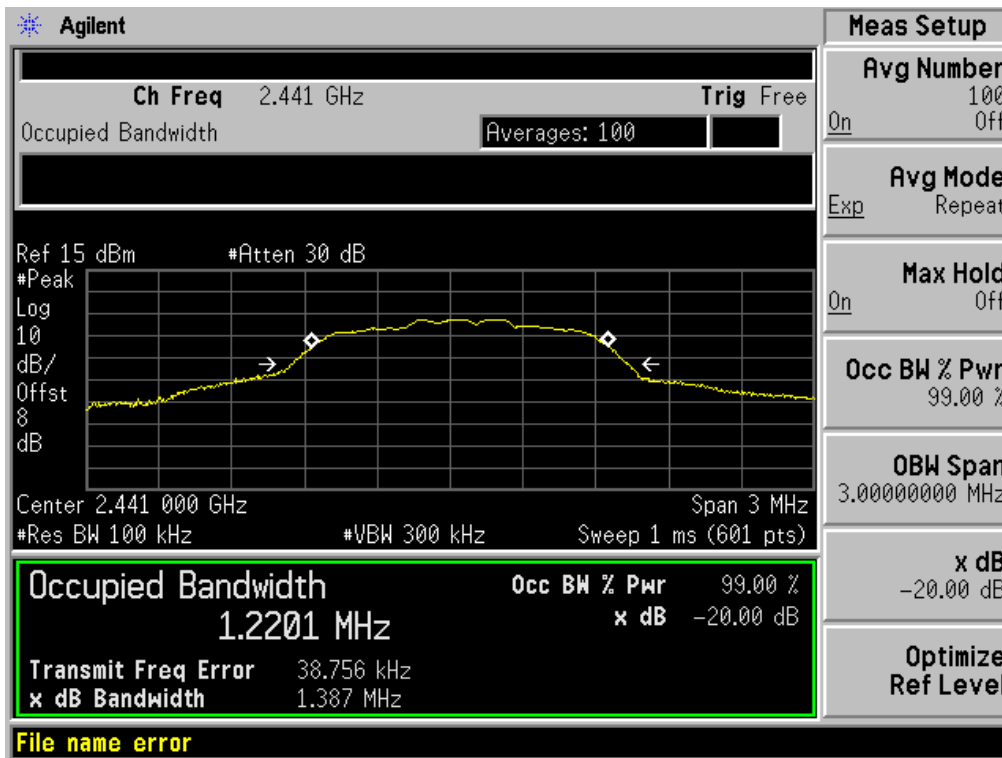

## □/4-DQPSK HIGH CHANNEL

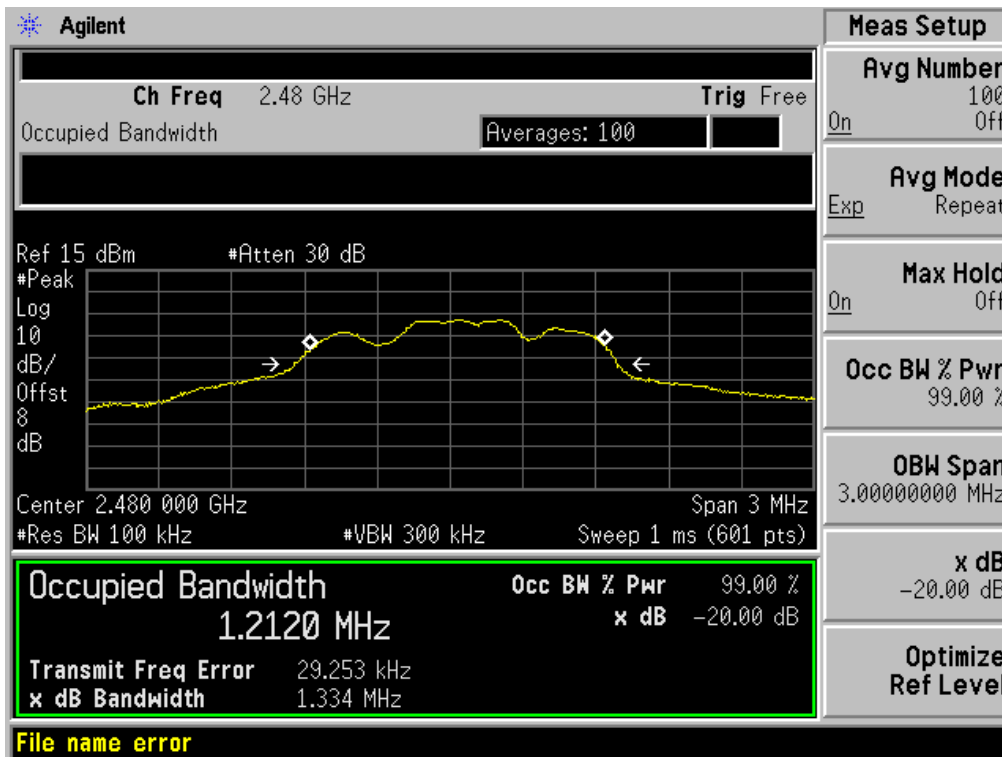

## 8-DPSK LOW CHANNEL

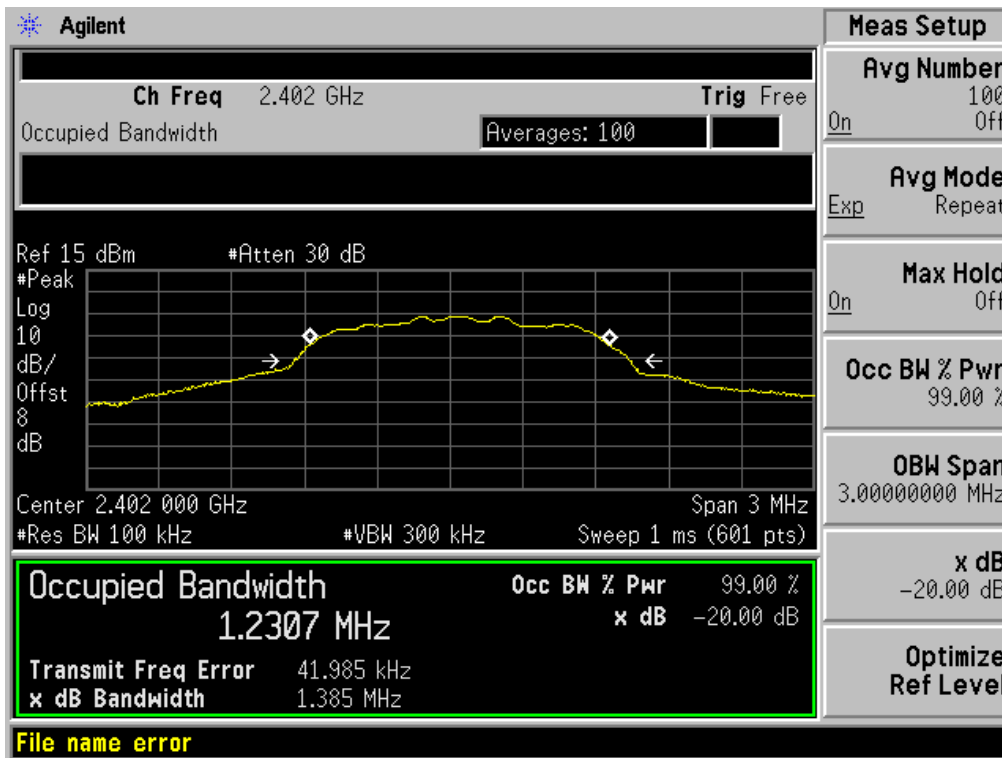

## 8-DPSK MIDDLE CHANNEL

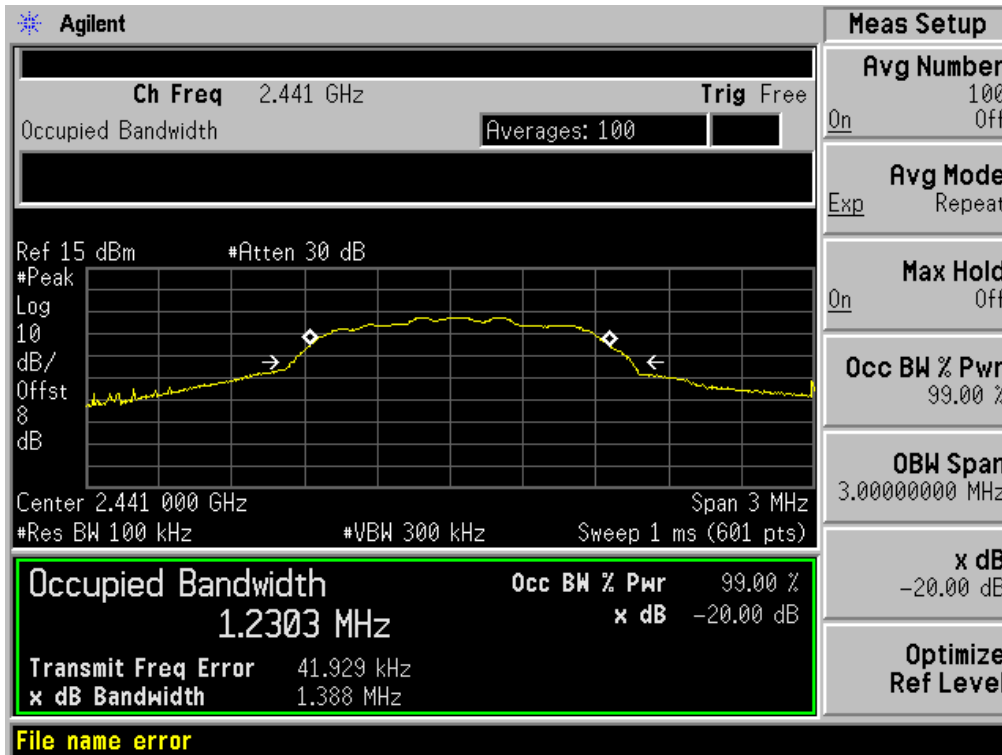

## 8-DPSK HIGH CHANNEL

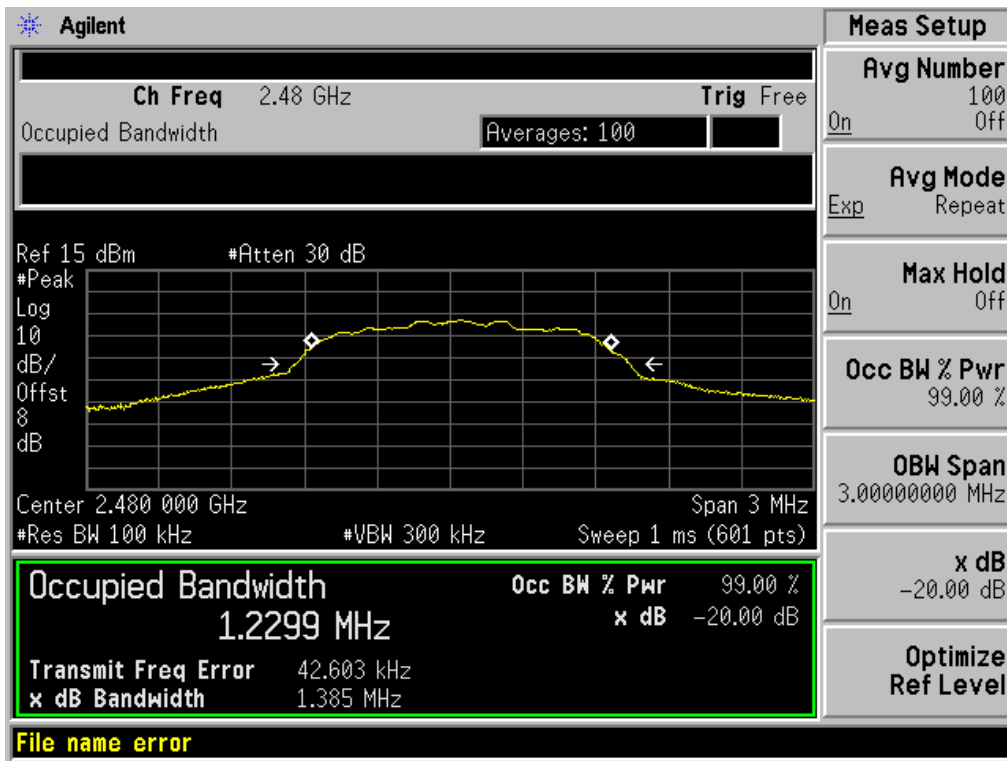

## A.4 Hopping Frequency Separation

### Test Data

Mode	Frequency separation (MHz)	Max 20 dB Bandwidth (MHz)	Two-thirds of the 20 dB bandwidth (MHz)	Verdict
GFSK	1.000	1.140	0.760	Pass
π/4-DQPSK	1.005	1.387	0.925	Pass
8-DPSK	1.000	1.388	0.925	Pass

### Test Plots

GFSK

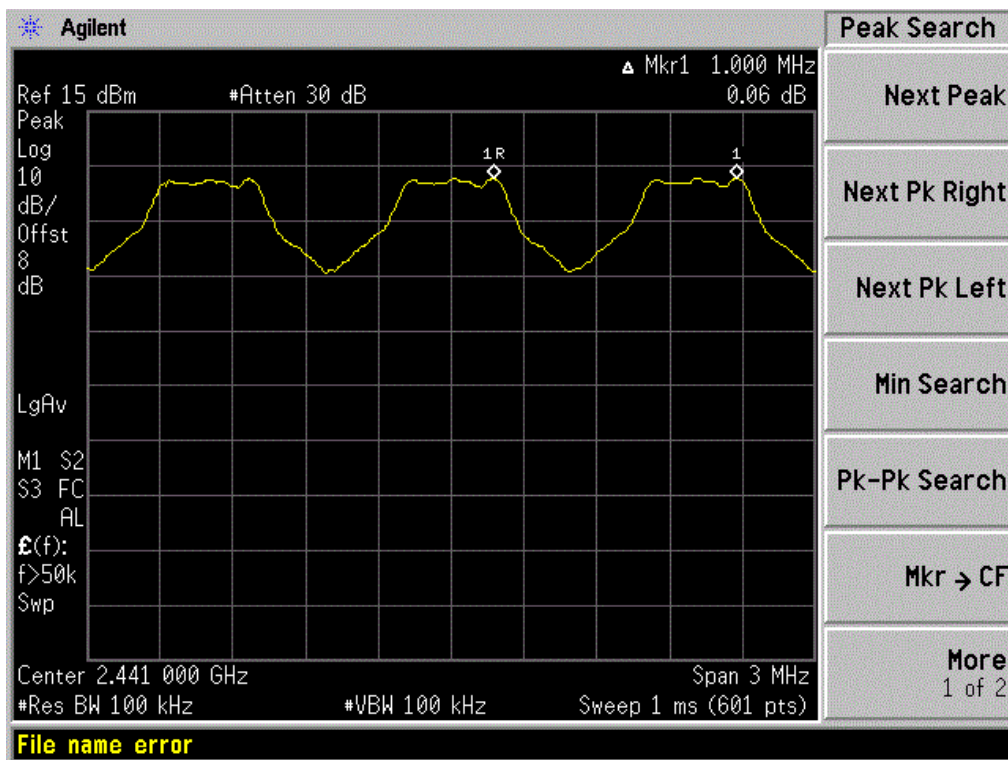

## □/4-DQPSK

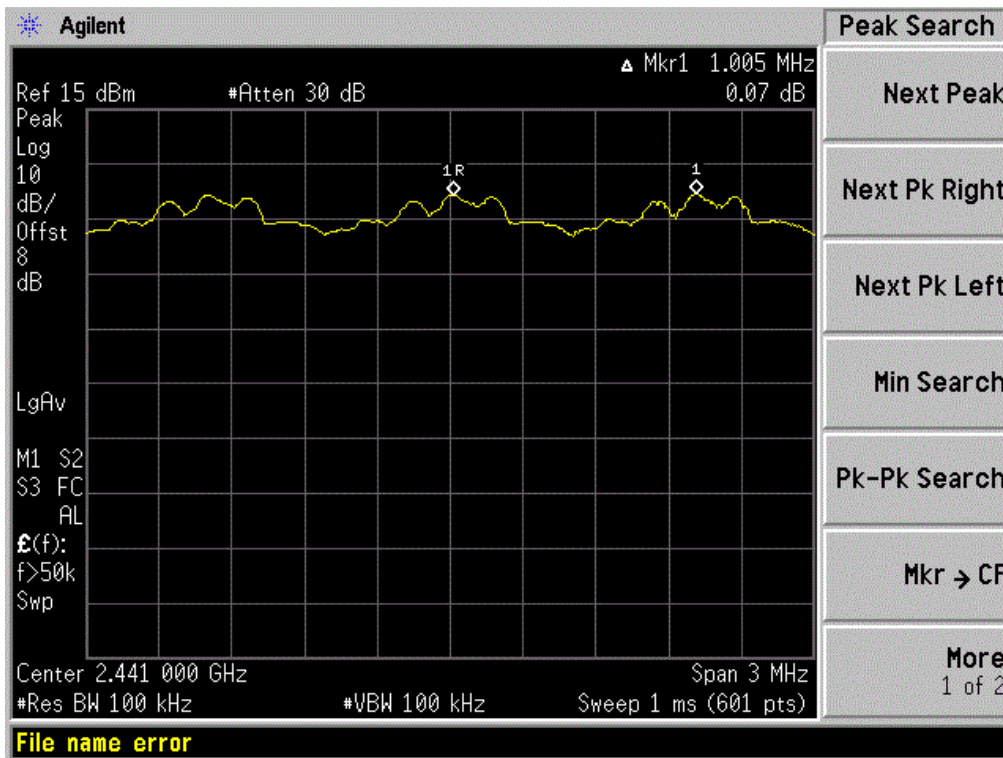

## 8-DPSK

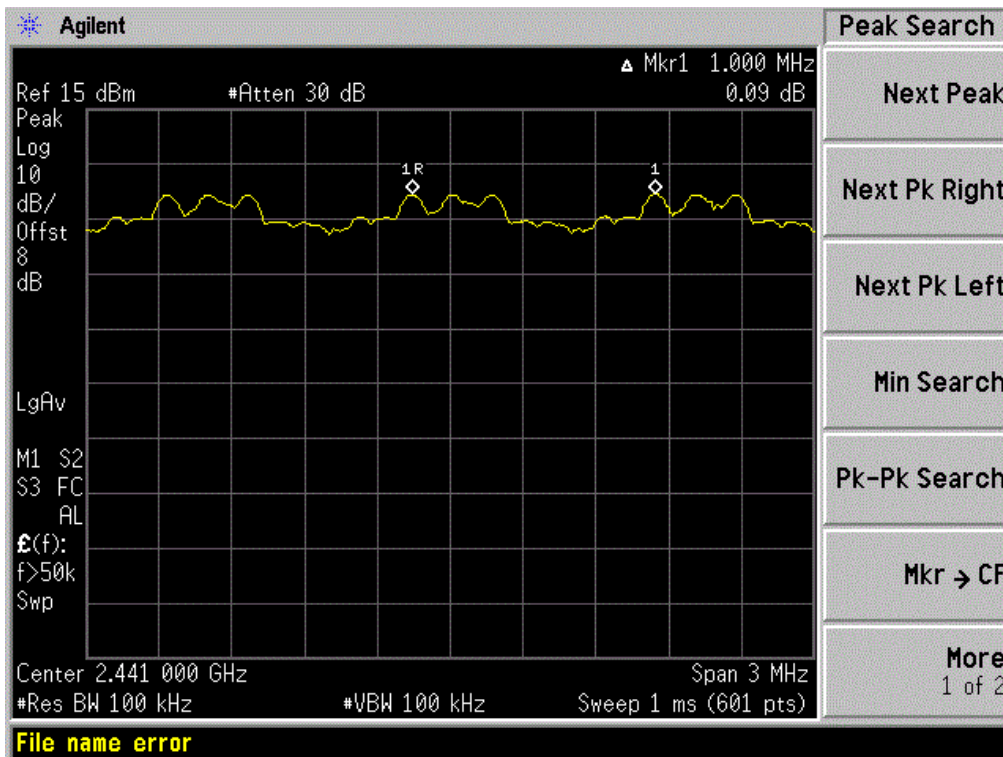

## A.5 Average Time of Occupancy

### Test Data

GFSK Mode:

DH Packet	Pulse Width (ms)	Total of Dwell (ms)	Limit (sec)	Verdict
DH 1	0.487	155.845	0.4	Pass
DH 3	1.747	279.529	0.4	Pass
DH 5	2.980	317.877	0.4	Pass

π/4-DQPSK Mode:

DH Packet	Pulse Width (ms)	Total of Dwell (ms)	Limit (sec)	Verdict
DH 1	0.500	160.005	0.4	Pass
DH 3	1.747	279.529	0.4	Pass
DH 5	2.980	317.877	0.4	Pass

8-DPSK Mode:

DH Packet	Pulse Width (ms)	Total of Dwell (ms)	Limit (sec)	Verdict
DH 1	0.500	160.005	0.4	Pass
DH 3	1.747	279.529	0.4	Pass
DH 5	2.980	317.877	0.4	Pass

## Test Plots

## GFSK DH1

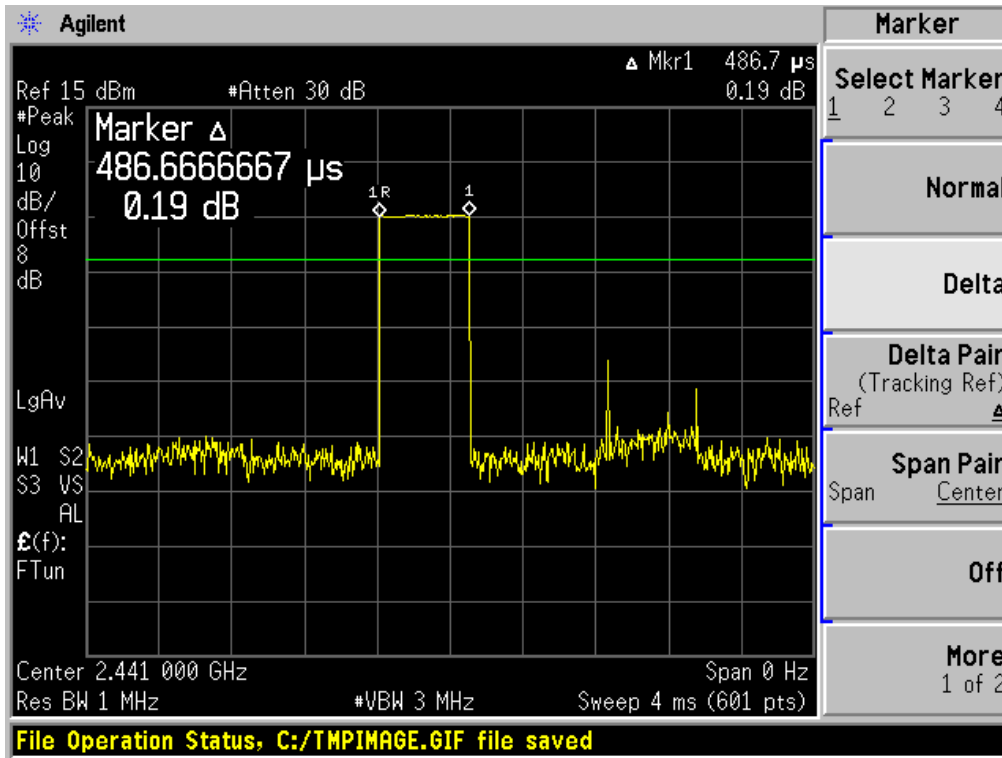

## GFSK DH3

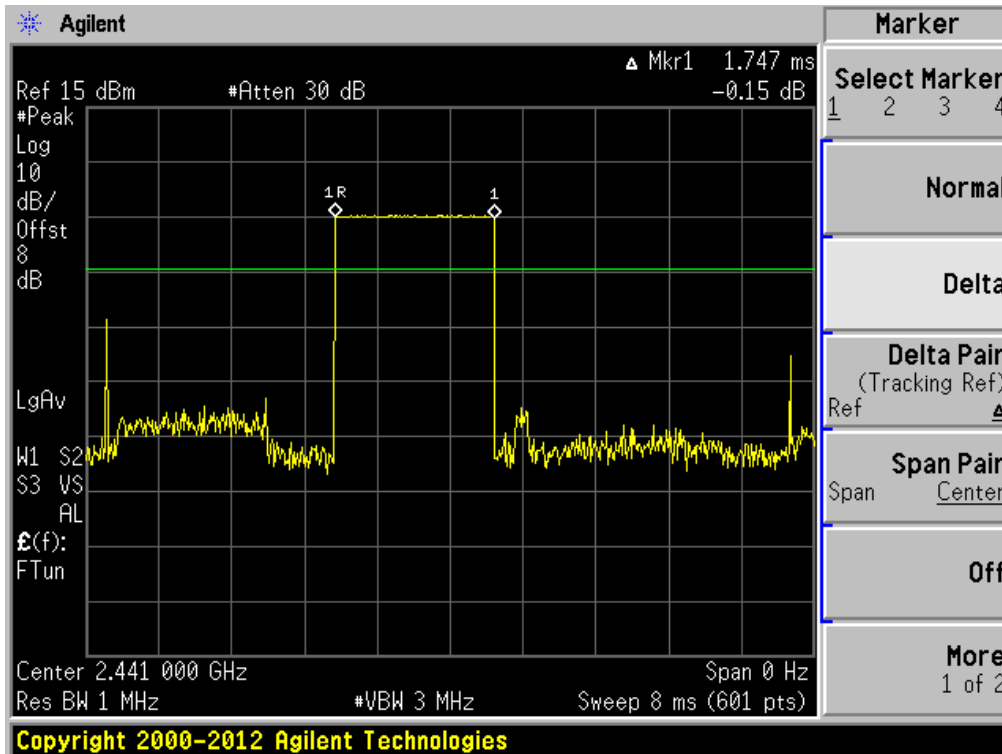

## GFSK DH5

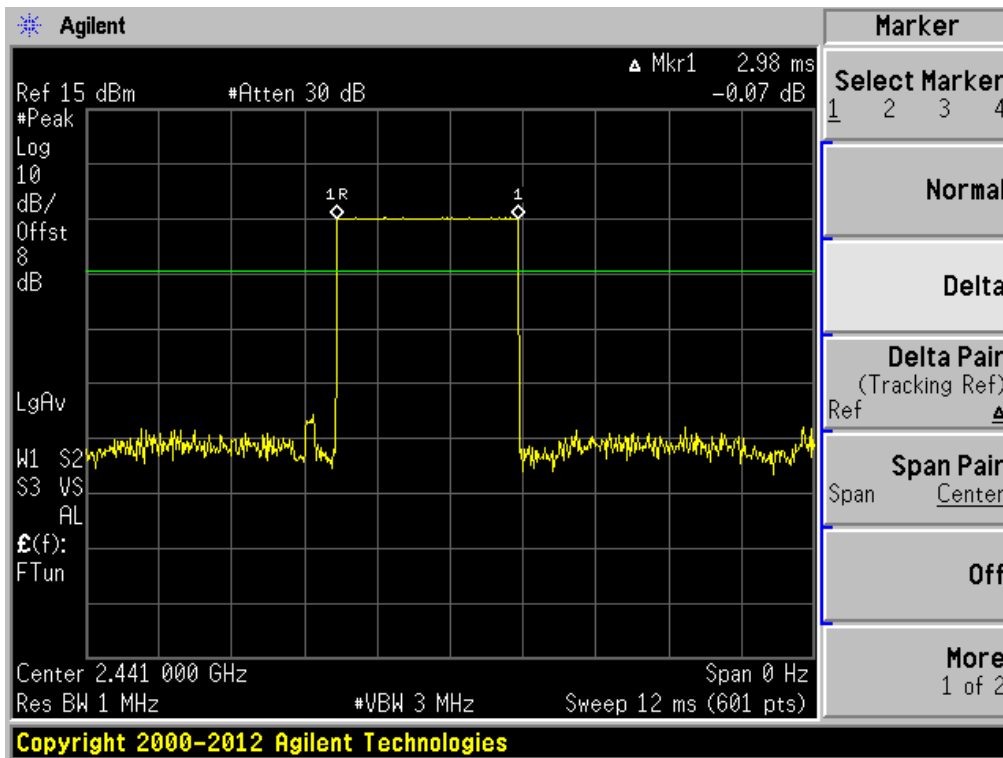

## 1/4-DQPSK DH1

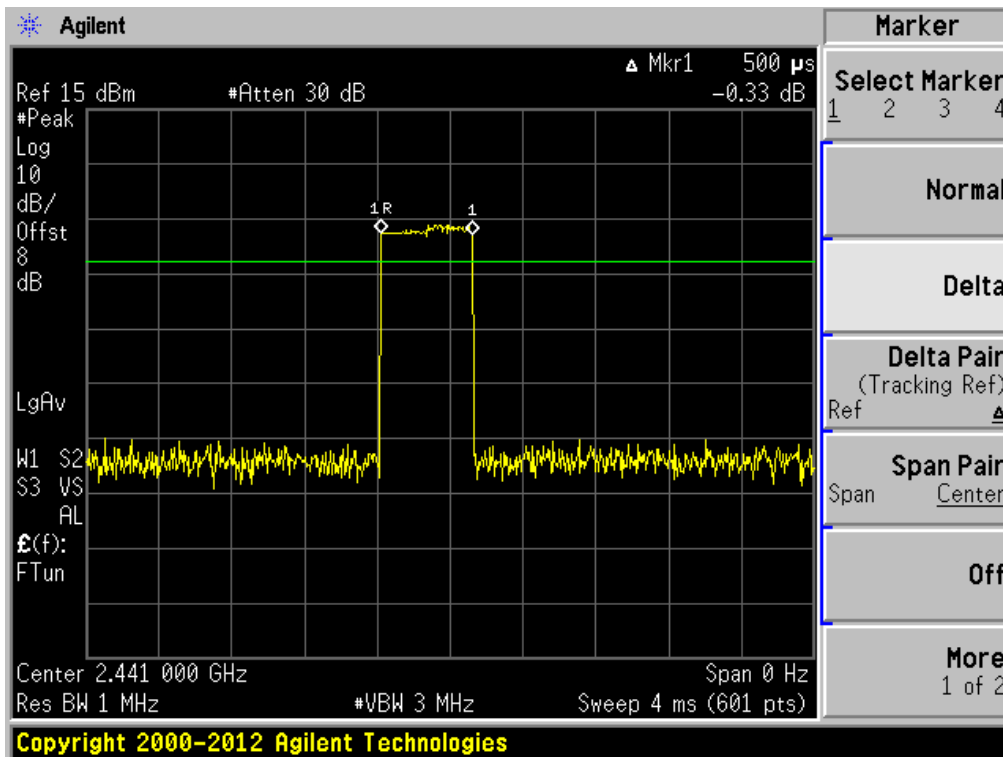



## □/4-DQPSK DH3

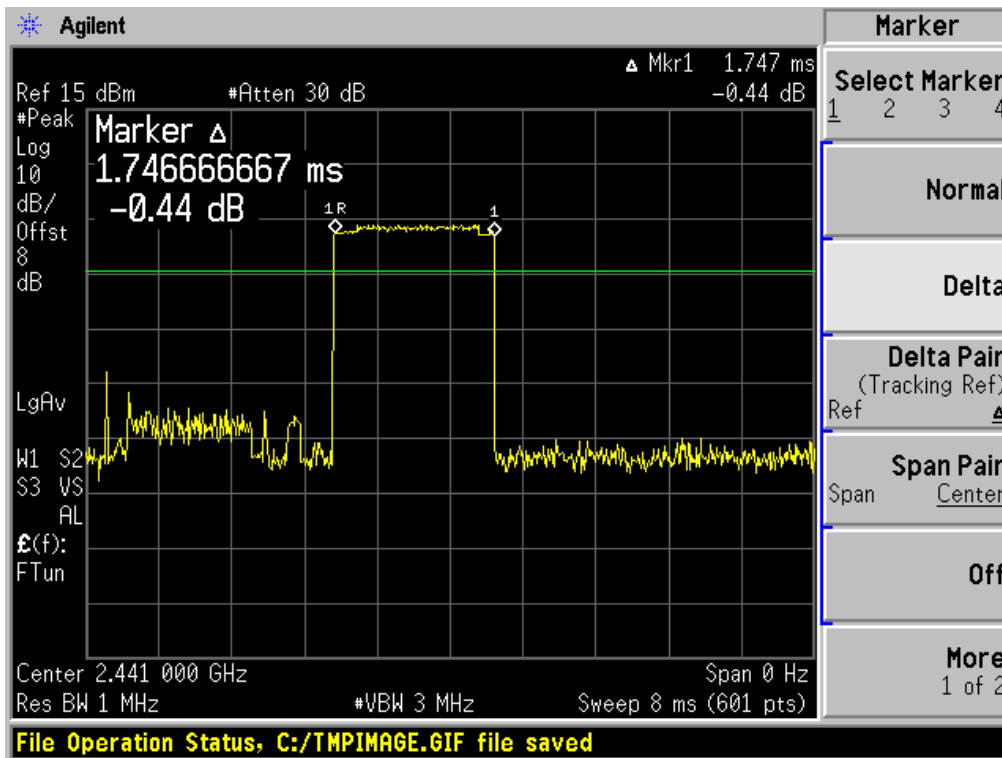

## □/4-DQPSK DH5

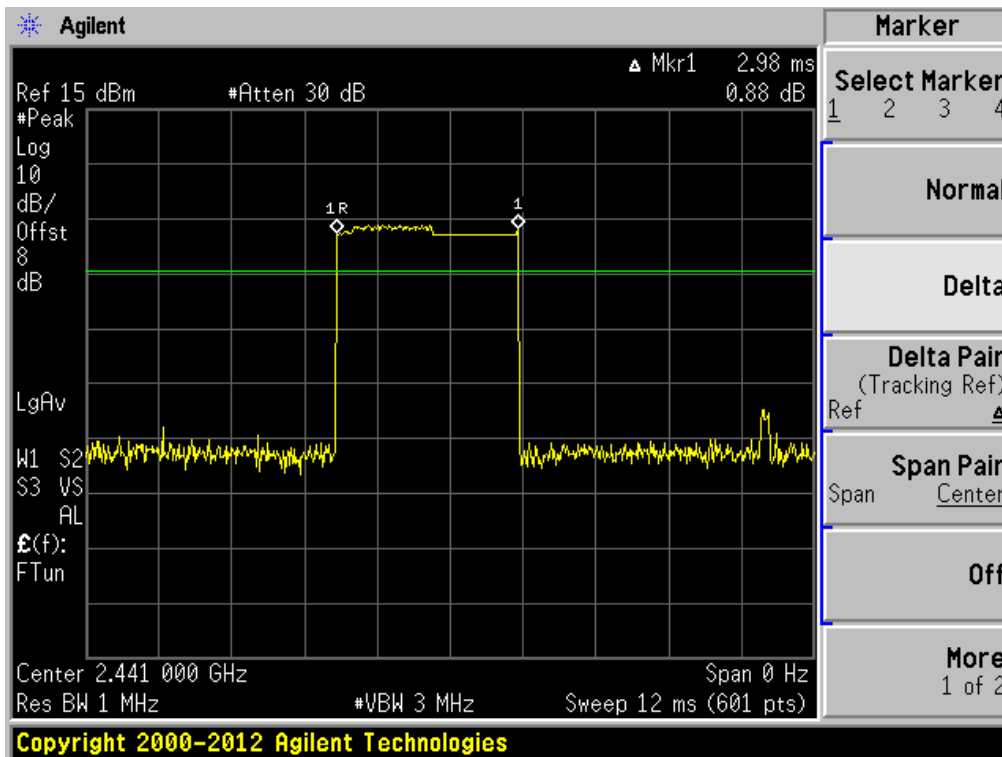

## 8-DPSK DH1

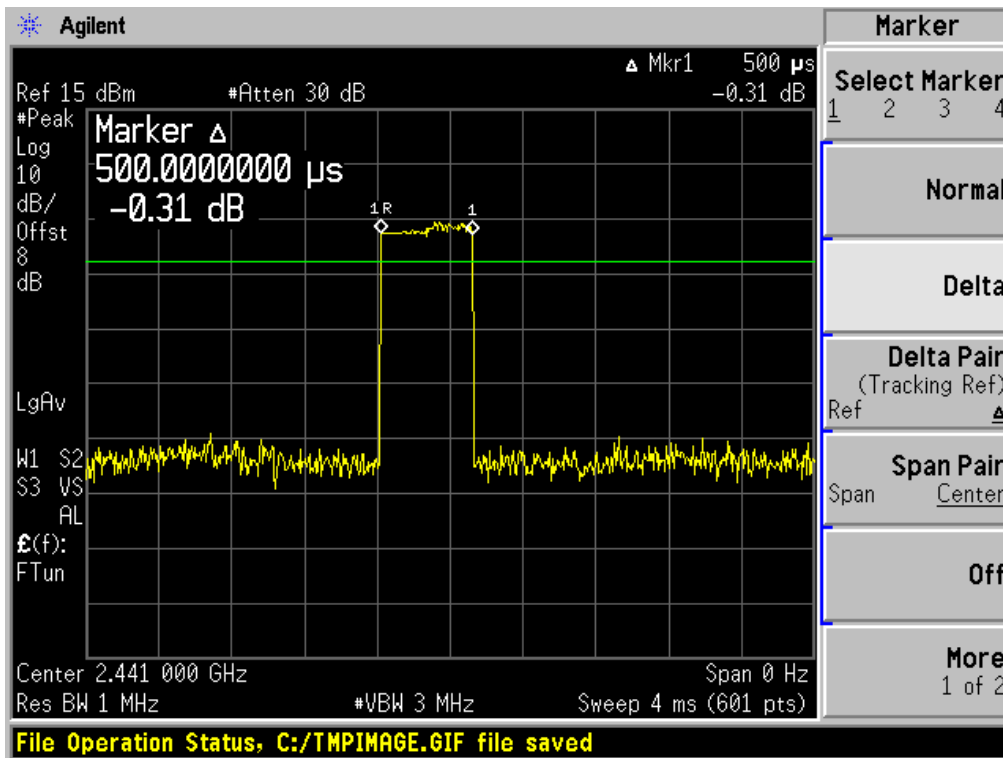

## 8-DPSK DH3

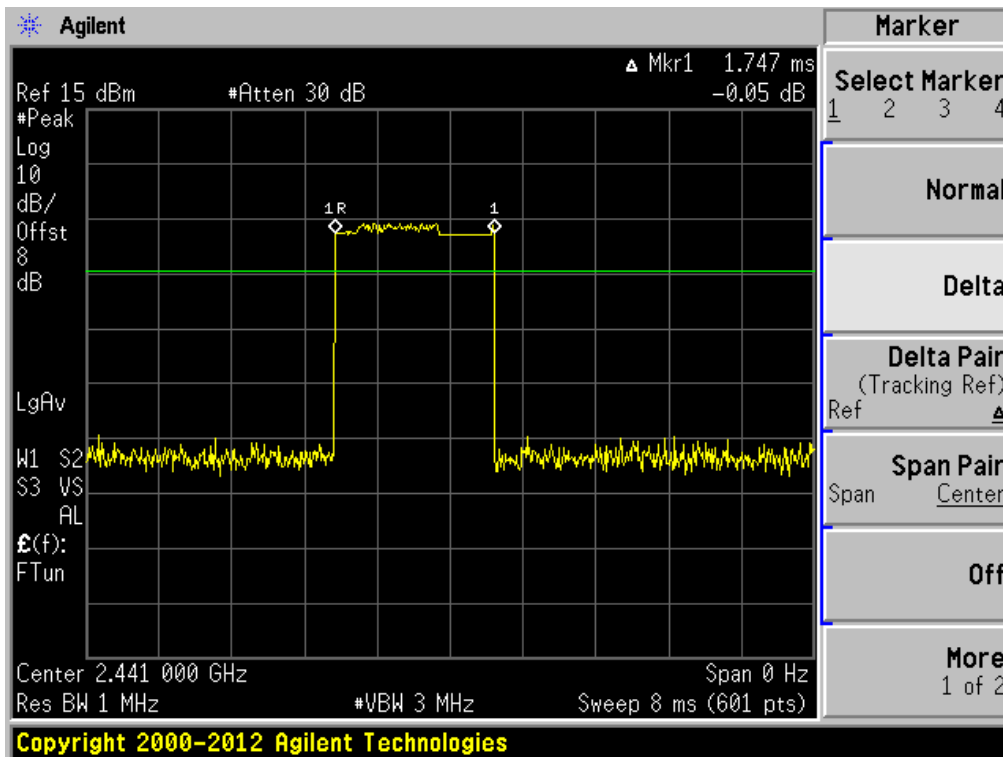

## 8-DPSK DH5

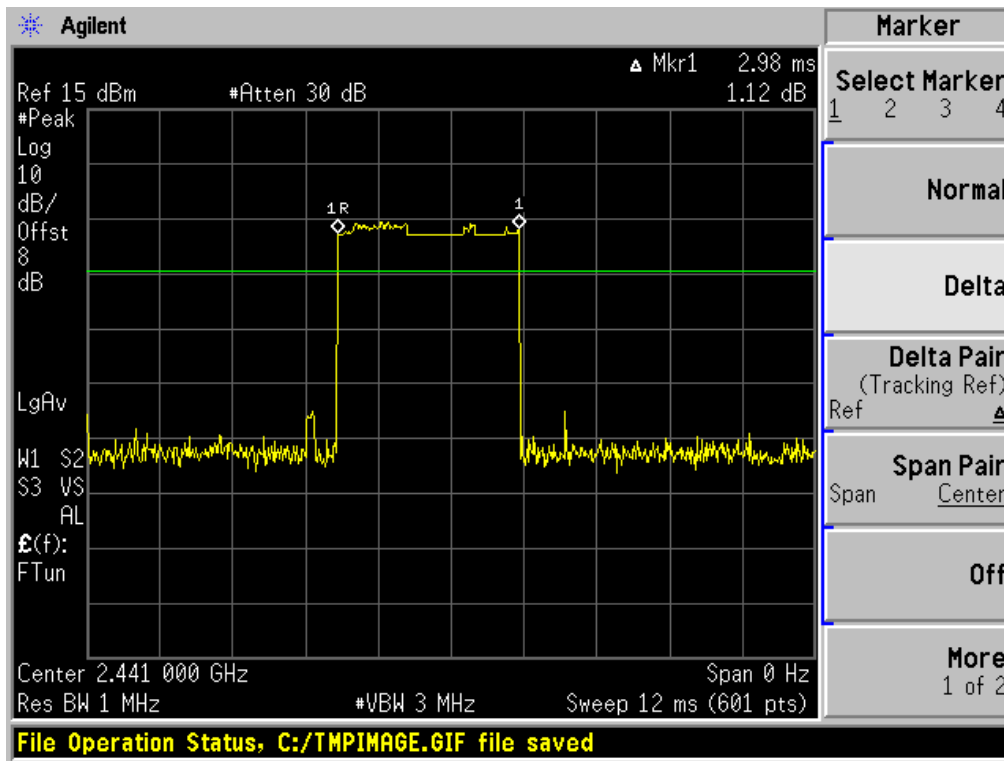

## A.6 Conducted Spurious Emissions

### Test Data

GFSK Mode:

Channel	Measured Max. Out of Band Emission (dBm)	Limit (dBm)		Verdict
		Carrier Level	Calculated 20 dBc Limit	
Low	-40.02	-3.35	-23.4	Pass
Middle	-44.22	-4.76	-24.8	Pass
High	-46.43	-5.29	-25.3	Pass

□/4-DQPSK Mode:

Channel	Measured Max. Out of Band Emission (dBm)	Limit (dBm)		Verdict
		Carrier Level	Calculated 20 dBc Limit	
Low	-44.54	-6.62	-26.6	Pass
Middle	-47.08	-7.72	-27.7	Pass
High	-45.35	-8.17	-28.2	Pass

8-DPSK Mode:

Channel	Measured Max. Out of Band Emission (dBm)	Limit (dBm)		Verdict
		Carrier Level	Calculated 20 dBc Limit	
Low	-42.86	-6.49	-26.5	Pass
Middle	-46.11	-7.88	-27.9	Pass
High	-47.24	-8.39	-28.4	Pass

## Test Plots

## GFSK LOW CHANNEL , BAND EDGE

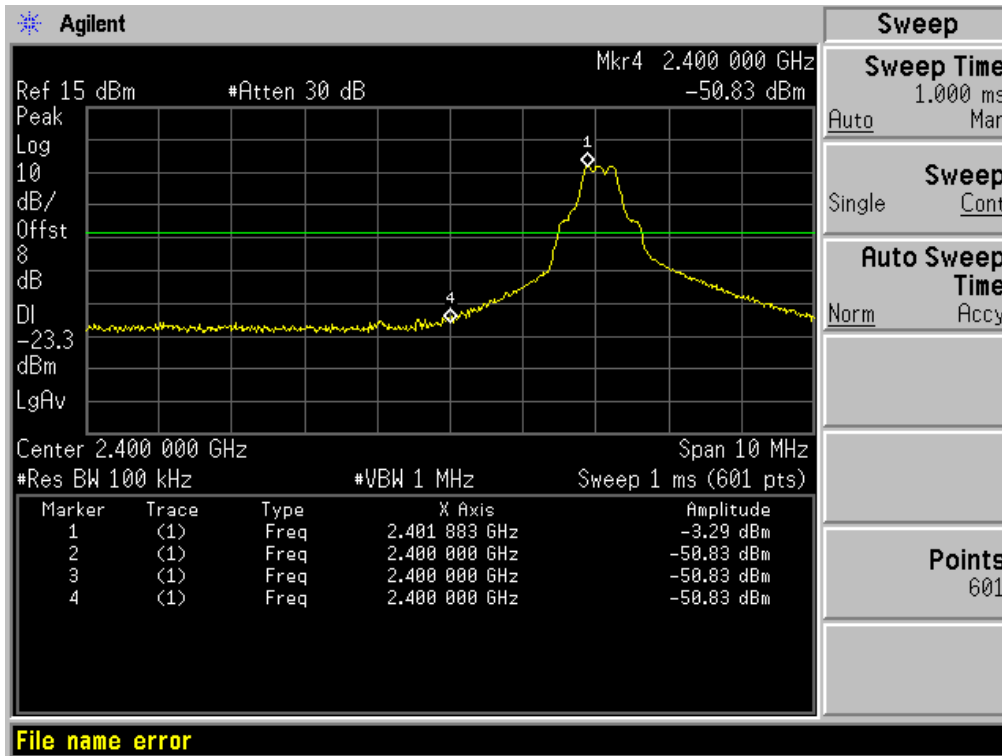

## GFSK LOW CHANNEL , SPURIOUS 30 MHz ~ 3 GHz

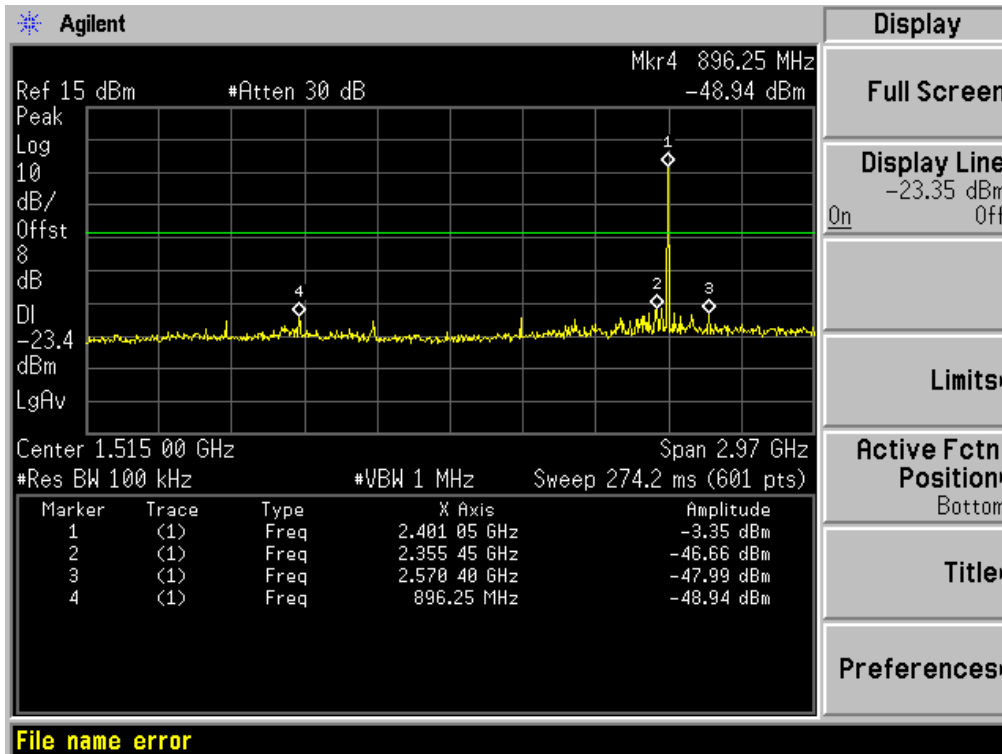

## GFSK LOW CHANNEL , SPURIOUS 3 GHz ~ 25 GHz

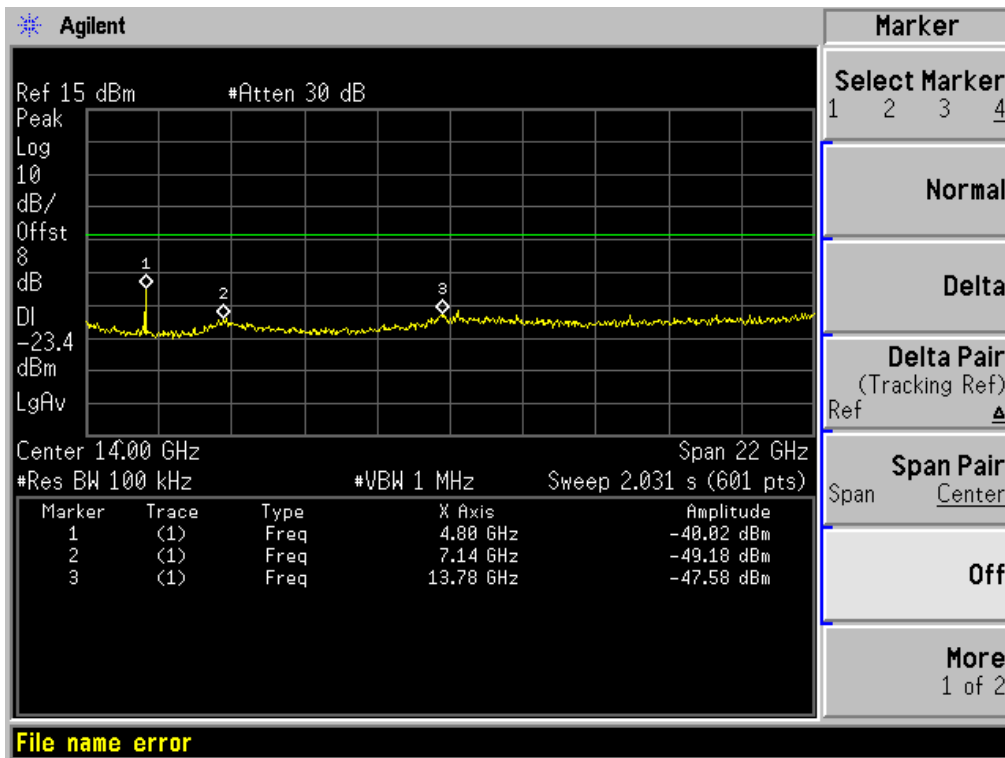

## GFSK MIDDLE CHANNEL , SPURIOUS 30 MHz ~ 3 GHz

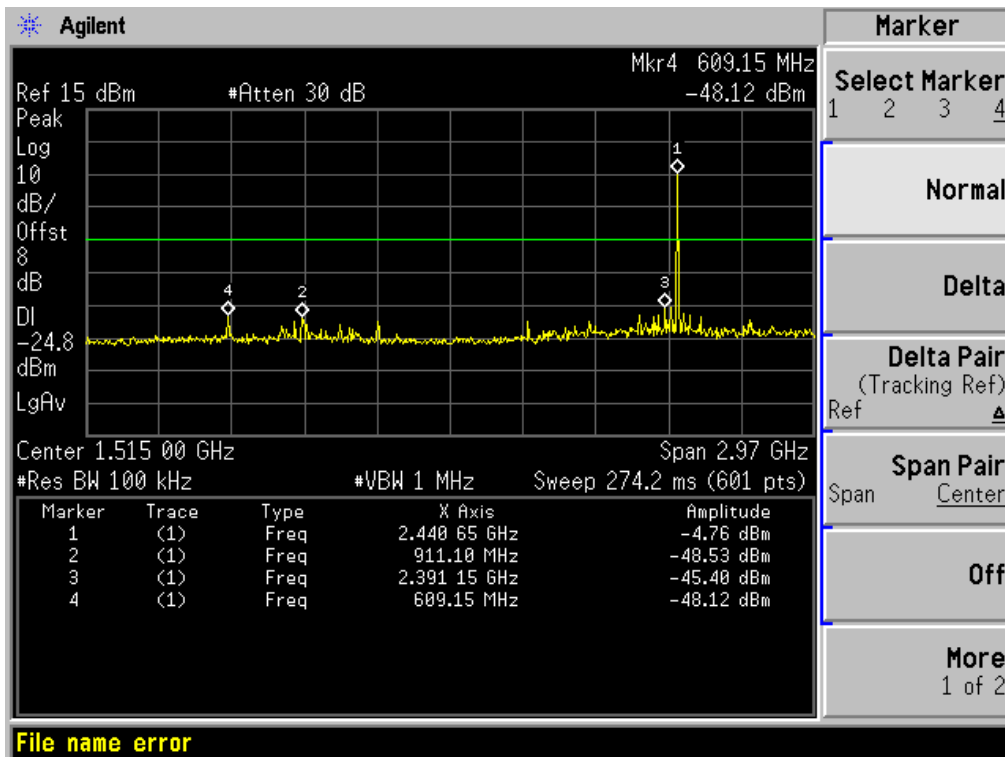

## GFSK MIDDLE CHANNEL , SPURIOUS 3 GHz ~ 25 GHz

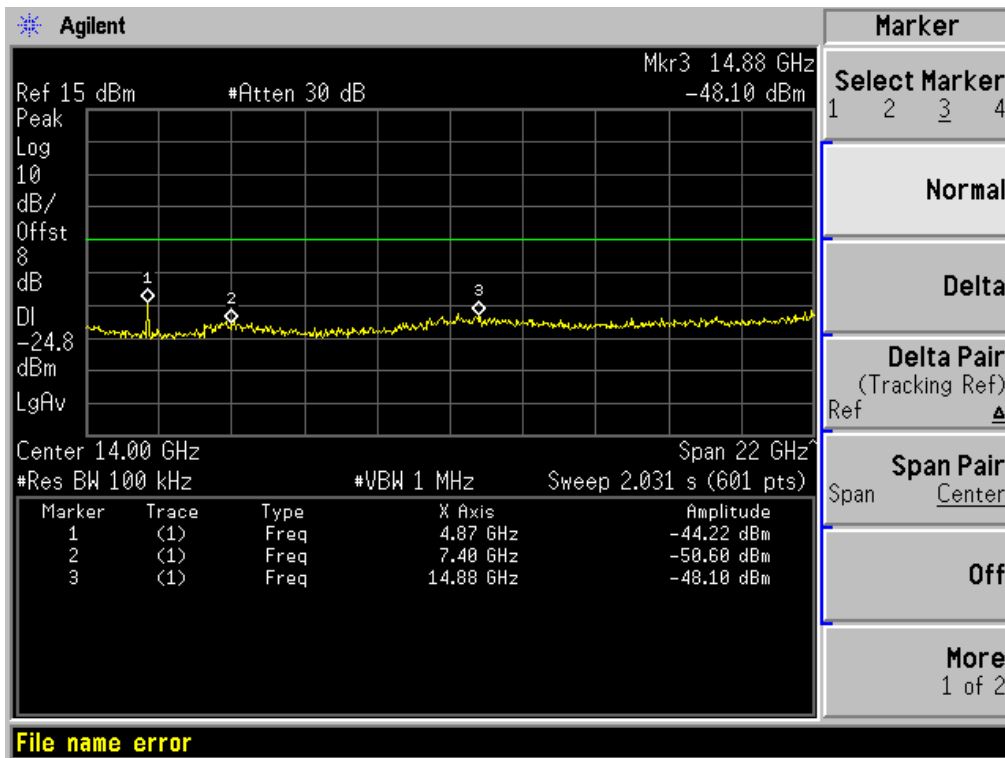

## GFSK HIGH CHANNEL , BAND EDGE

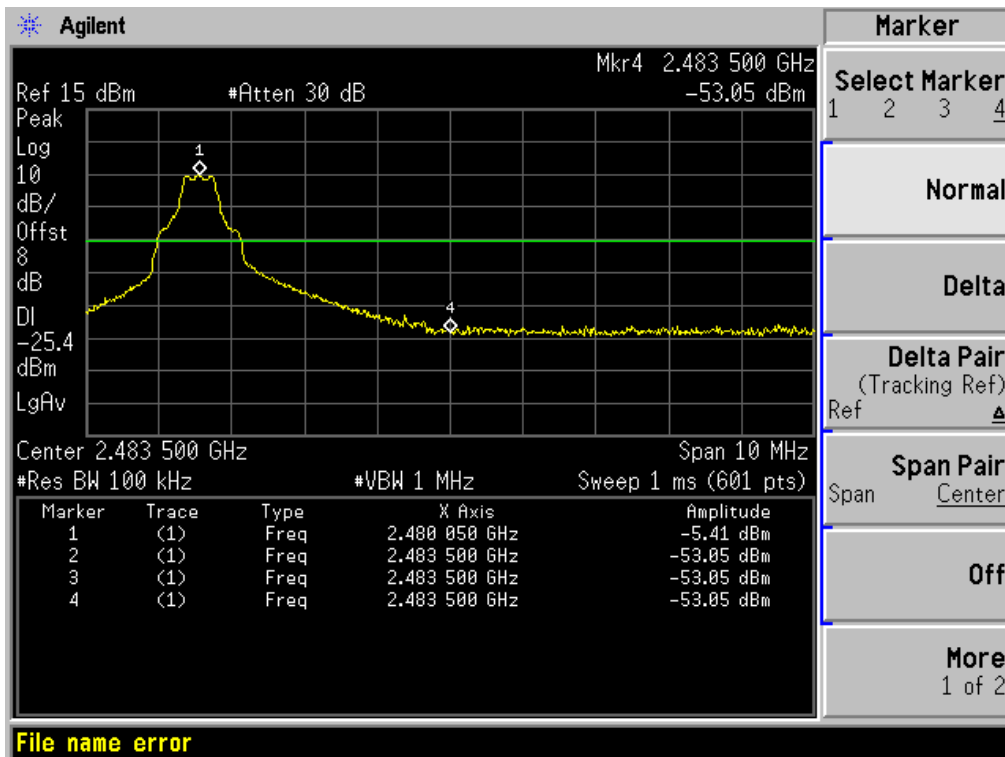

## GFSK HIGH CHANNEL , SPURIOUS 30 MHz ~ 3 GHz

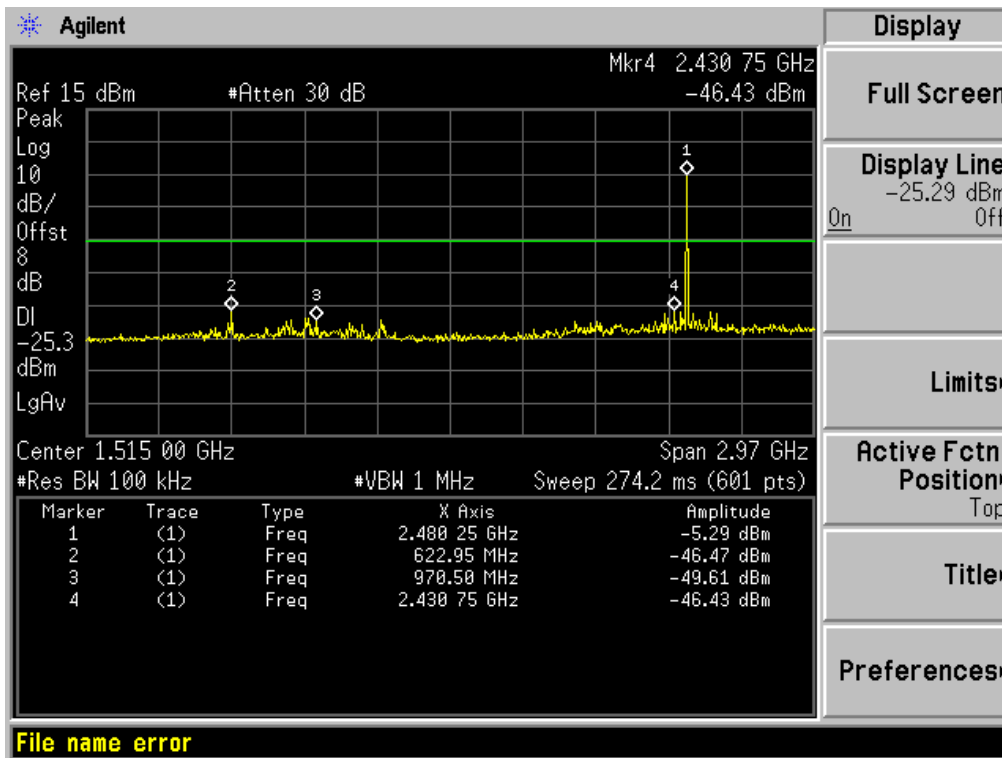

## GFSK HIGH CHANNEL , SPURIOUS 3 GHz ~ 25 GHz

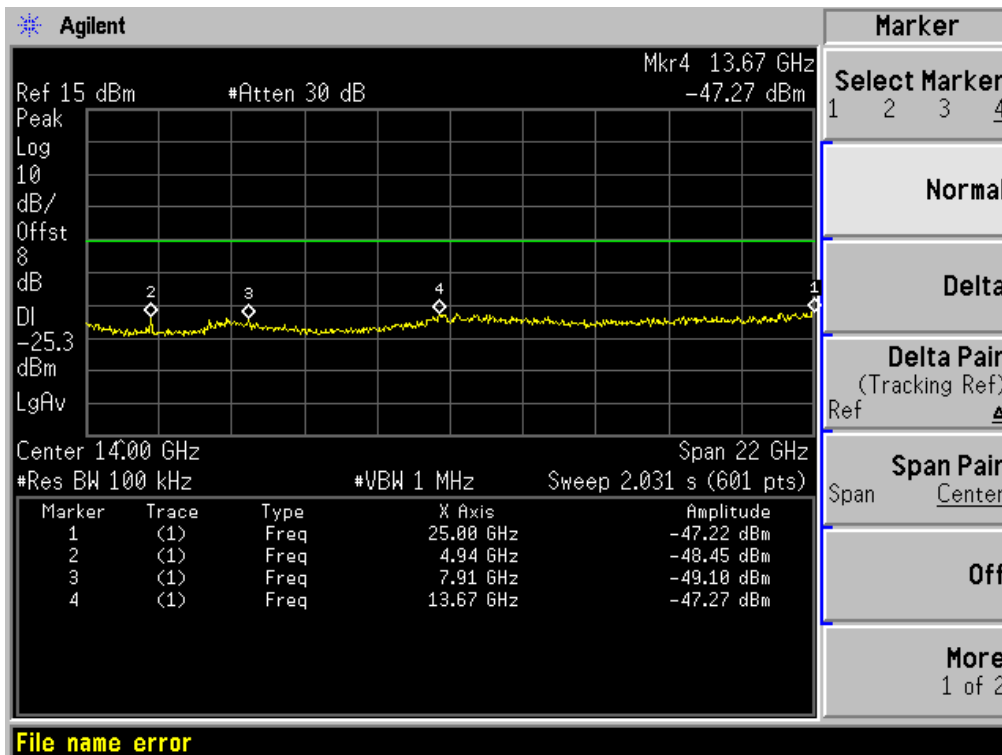



## □/4-DQPSK LOW CHANNEL , BAND EDGE

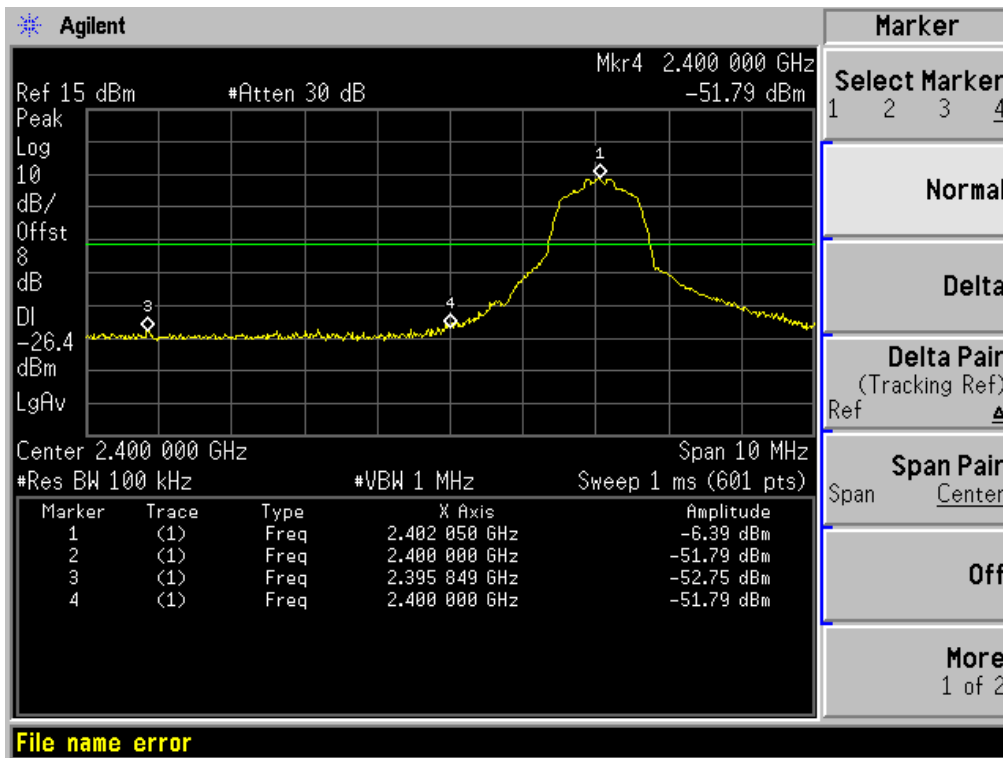

## □/4-DQPSK LOW CHANNEL , SPURIOUS 30 MHz ~ 3 GHz

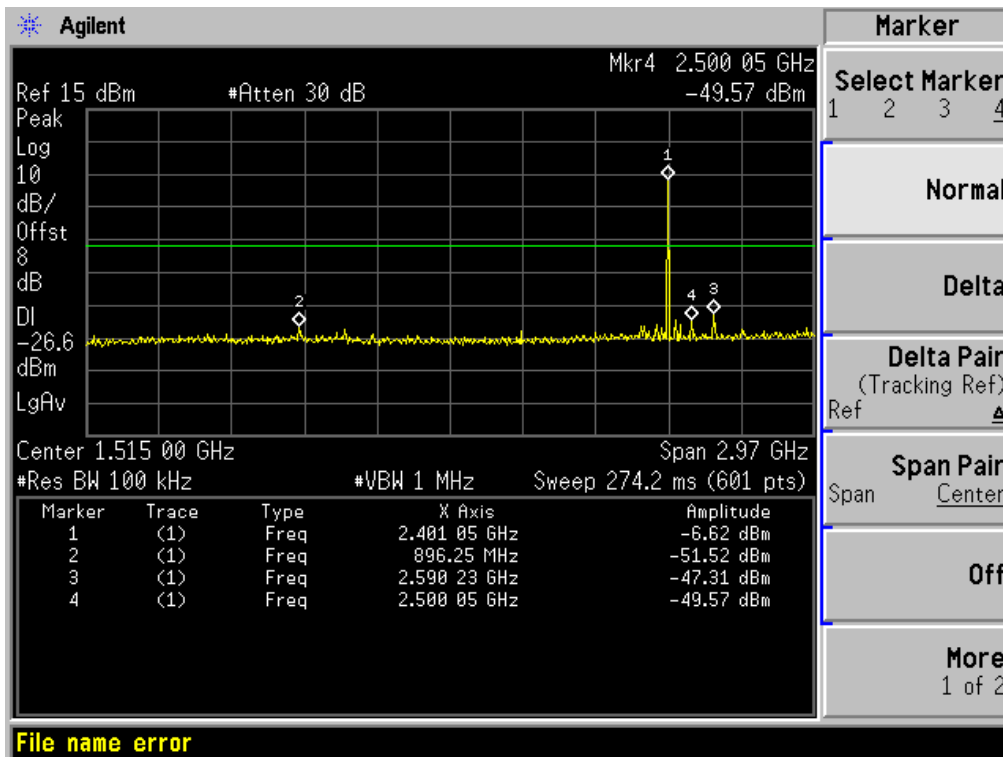

## □/4-DQPSK LOW CHANNEL , SPURIOUS 3 GHz ~ 25 GHz

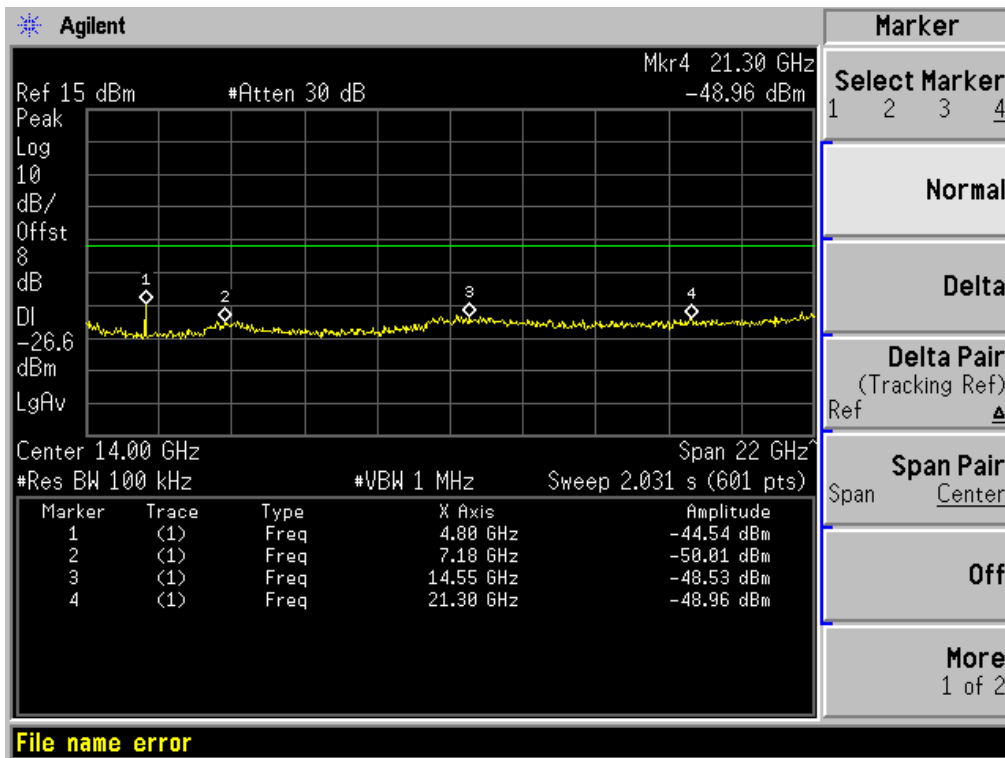

## □/4-DQPSK MIDDLE CHANNEL , SPURIOUS 30 MHz ~ 3 GHz

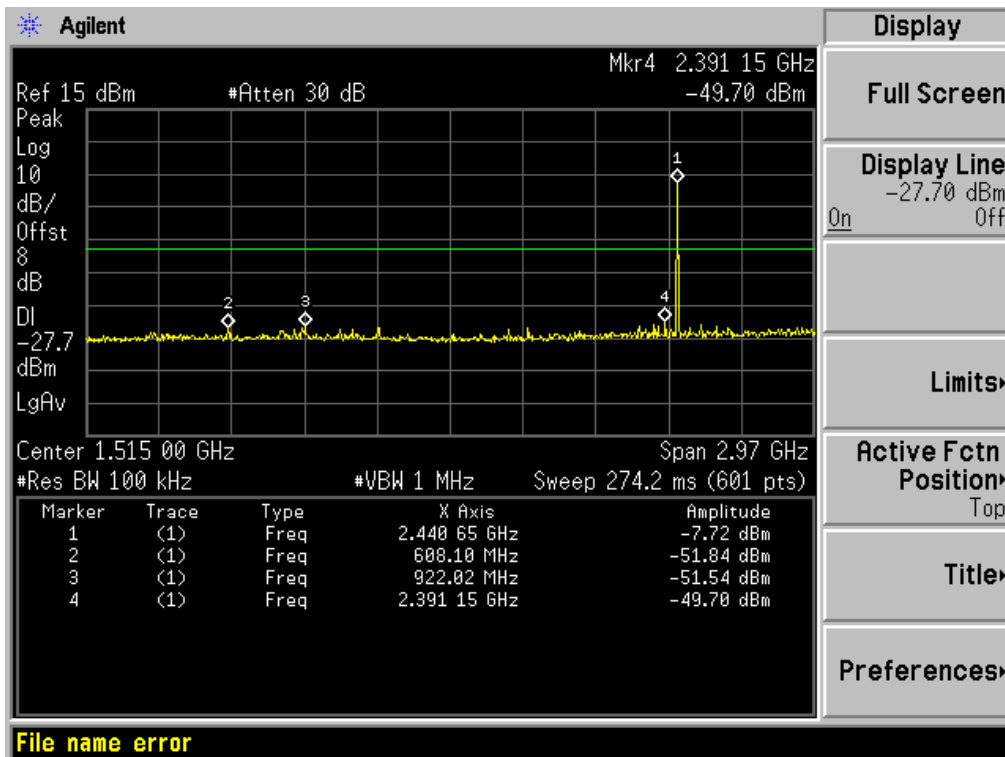

## □/4-DQPSK MIDDLE CHANNEL , SPURIOUS 3 GHz ~ 25 GHz

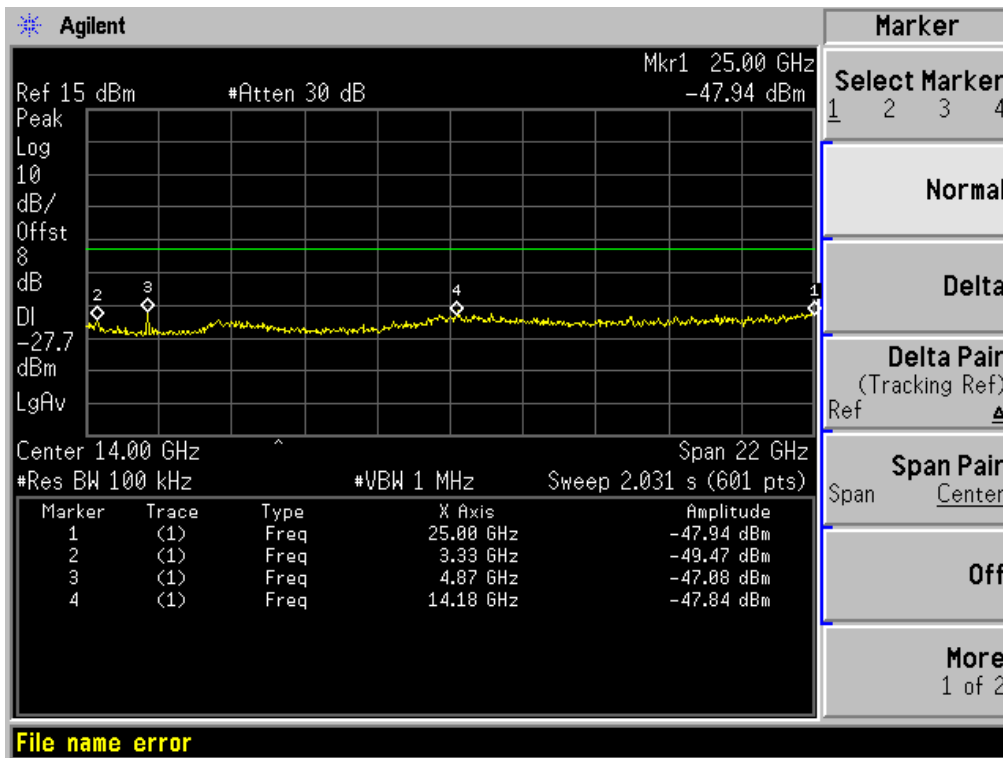

## □/4-DQPSK HIGH CHANNEL , BAND EDGE

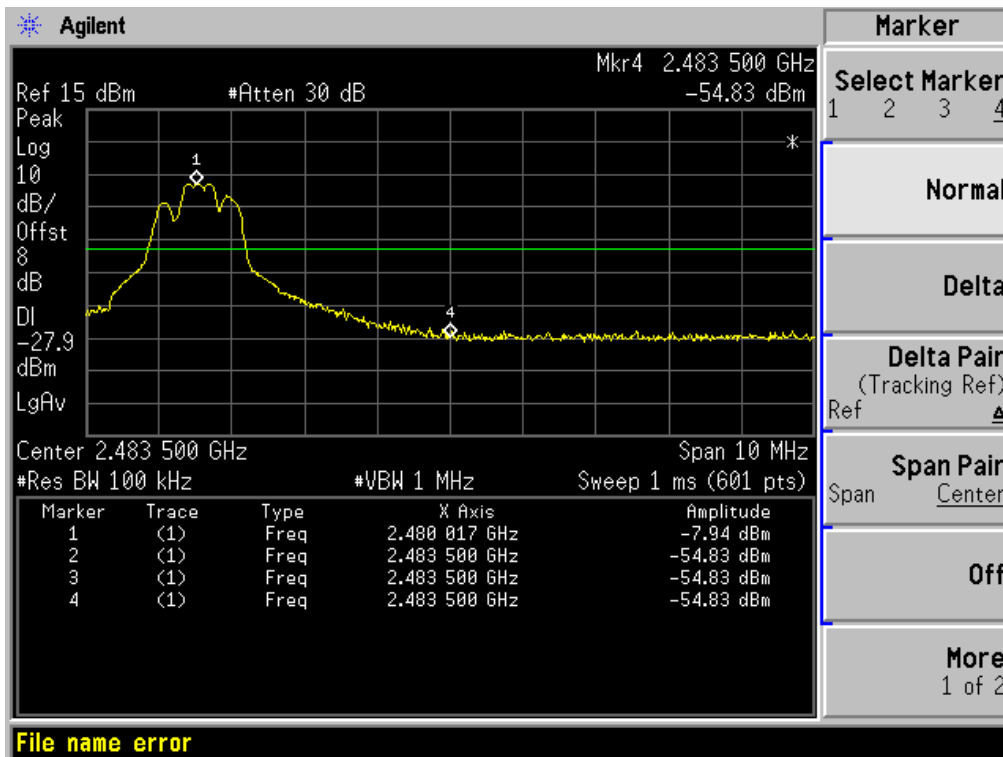

## □/4-DQPSK HIGH CHANNEL , SPURIOUS 30 MHz ~ 3 GHz

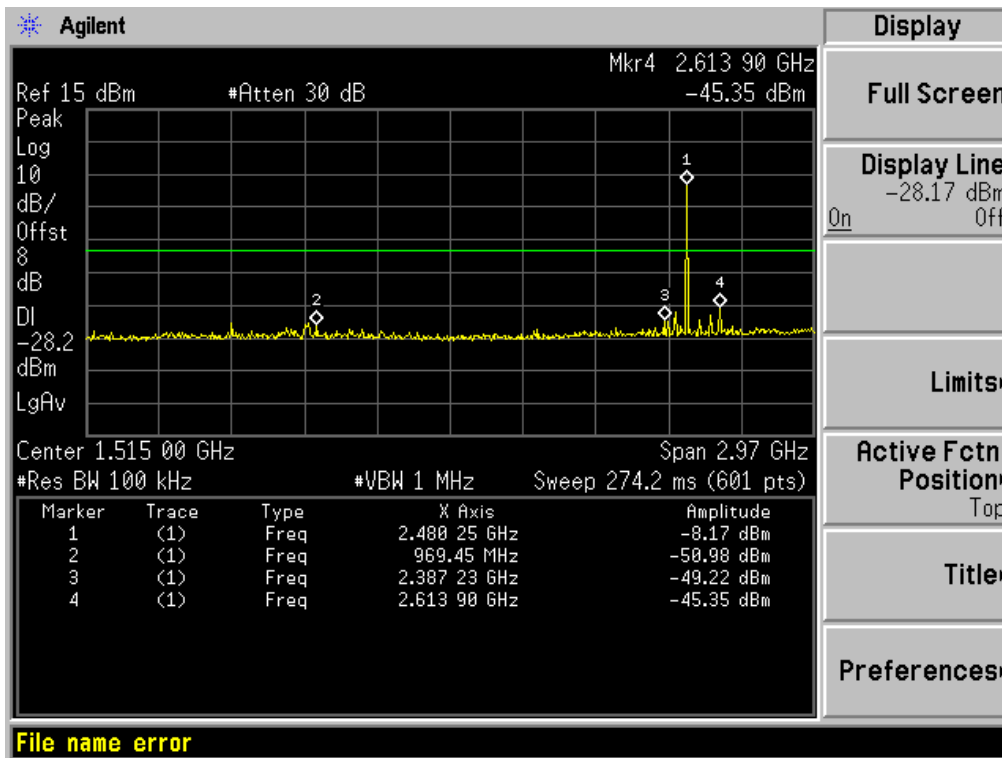

## □/4-DQPSK HIGH CHANNEL , SPURIOUS 3 GHz ~ 25 GHz

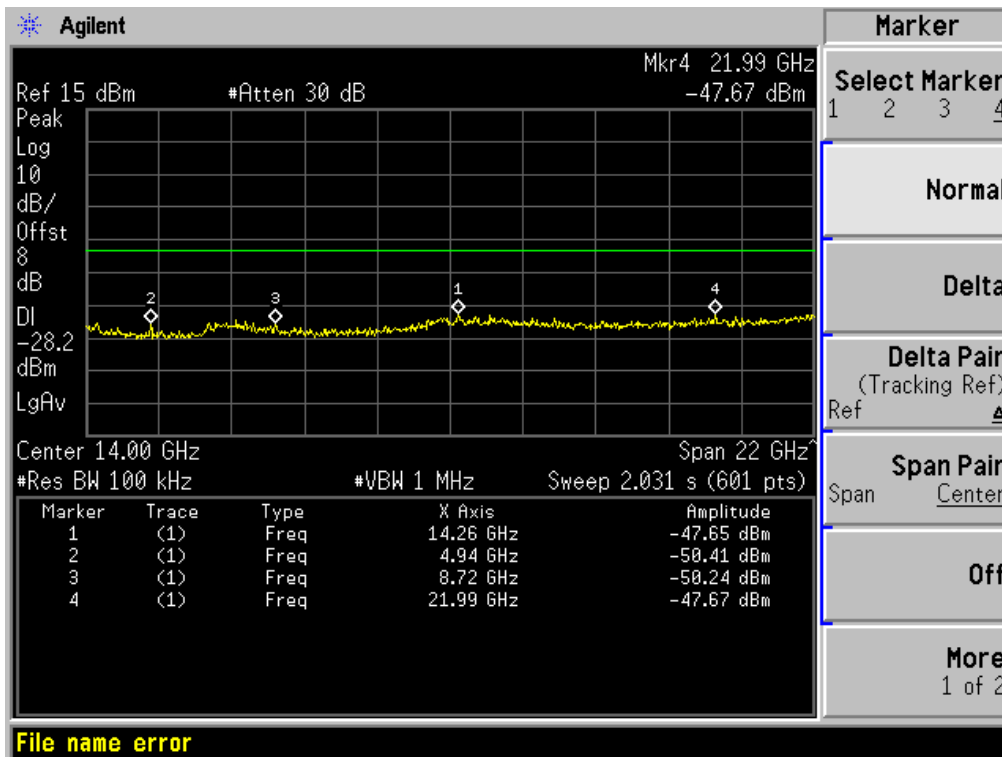

## 8-DPSK LOW CHANNEL , BAND EDGE

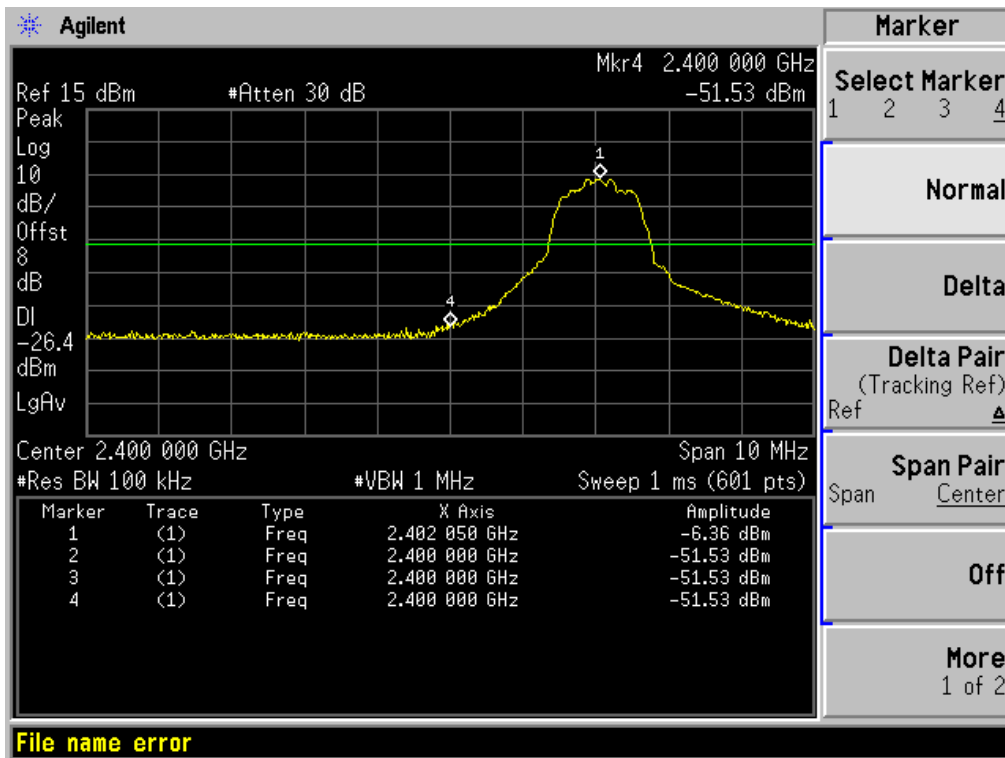

## 8-DPSK LOW CHANNEL , SPURIOUS 30 MHz ~ 3 GHz

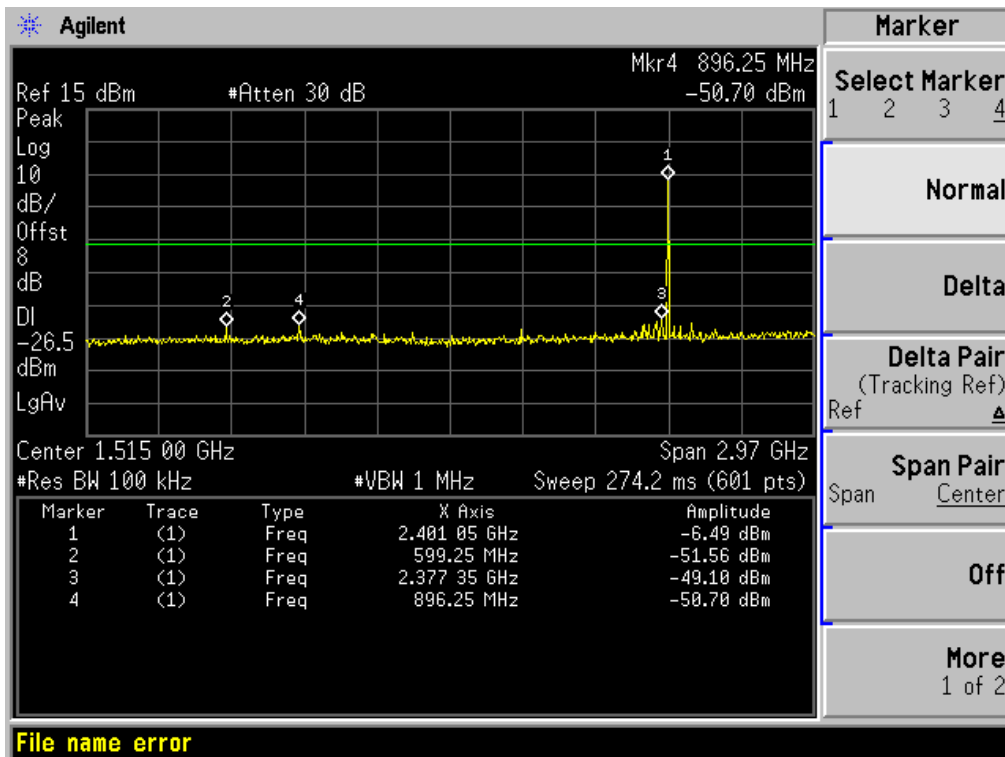

8-DPSK LOW CHANNEL , SPURIOUS 3 GHz ~ 25 GHz

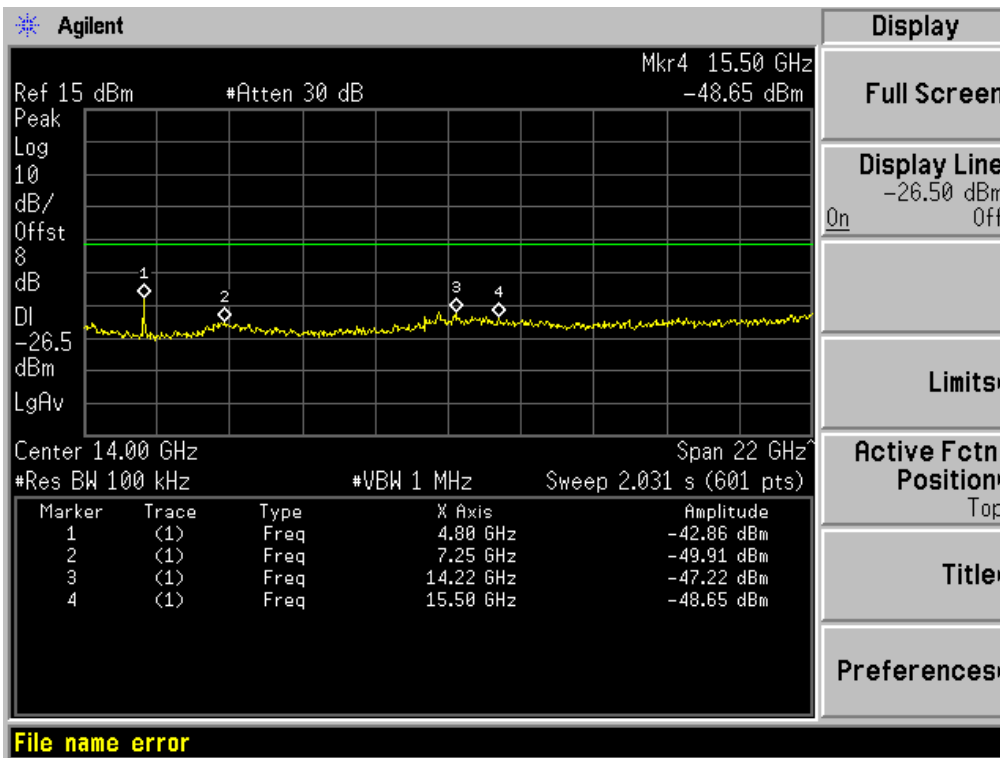

8-DPSK MIDDLE CHANNEL , SPURIOUS 30 MHz ~ 3 GHz

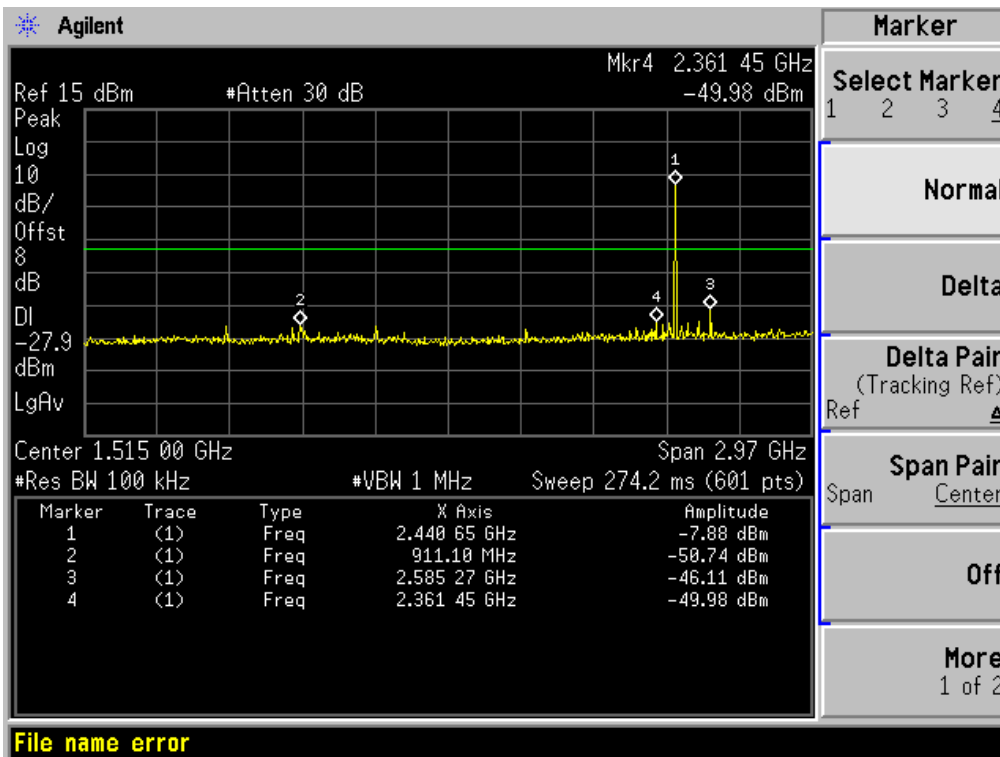

## 8-DPSK MIDDLE CHANNEL , SPURIOUS 3 GHz ~ 25 GHz

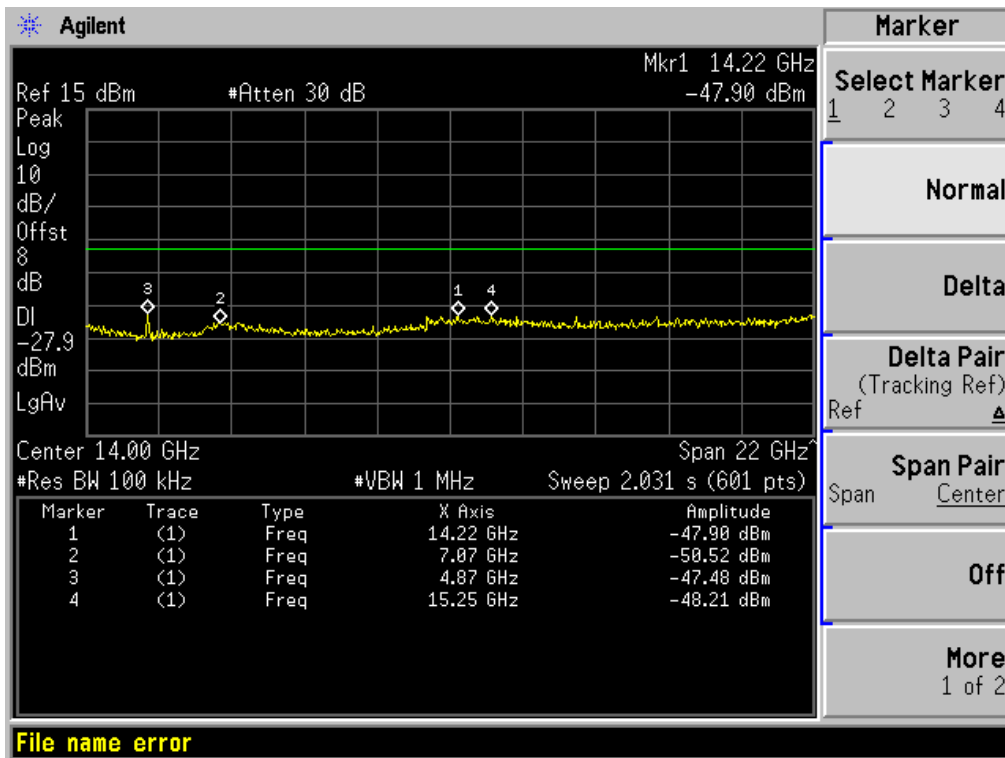

## 8-DPSK HIGH CHANNEL , BAND EDGE

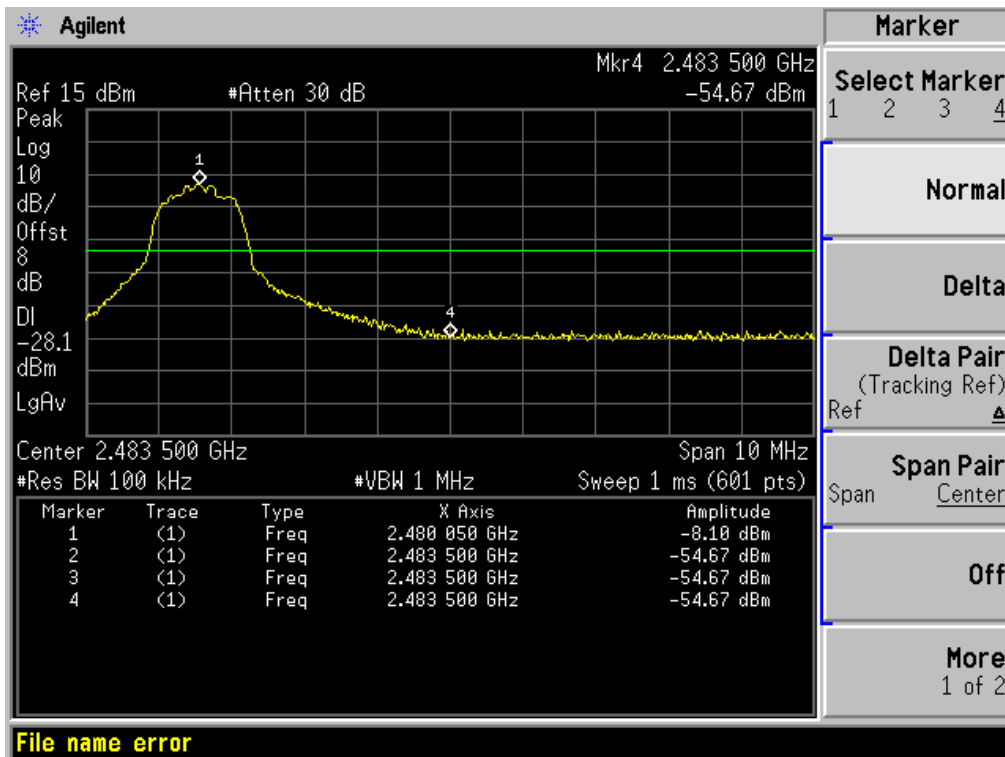

## 8-DPSK HIGH CHANNEL , SPURIOUS 30 MHz ~3 GHz

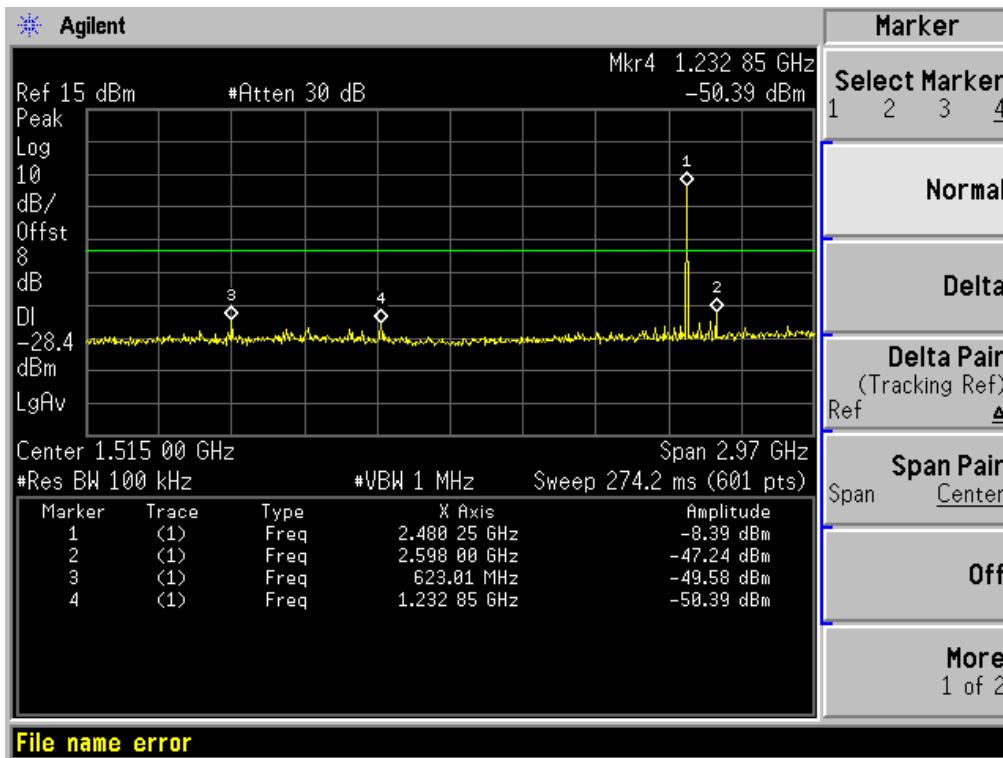

## 8-DPSK HIGH CHANNEL , SPURIOUS 3 GHz ~ 25 GHz

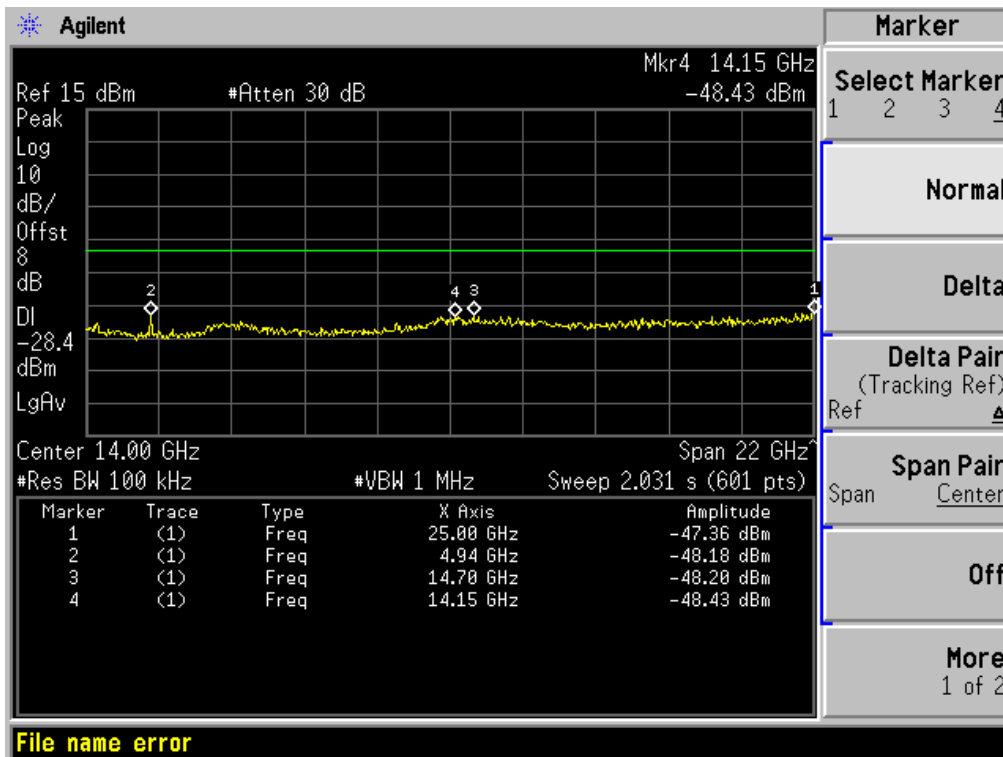



## A.7 Conducted Emissions

Note: All configurations have been tested, only the worst configuration (GFSK High Channel) shown here.

### Test Data and Plots

#### PHASE L

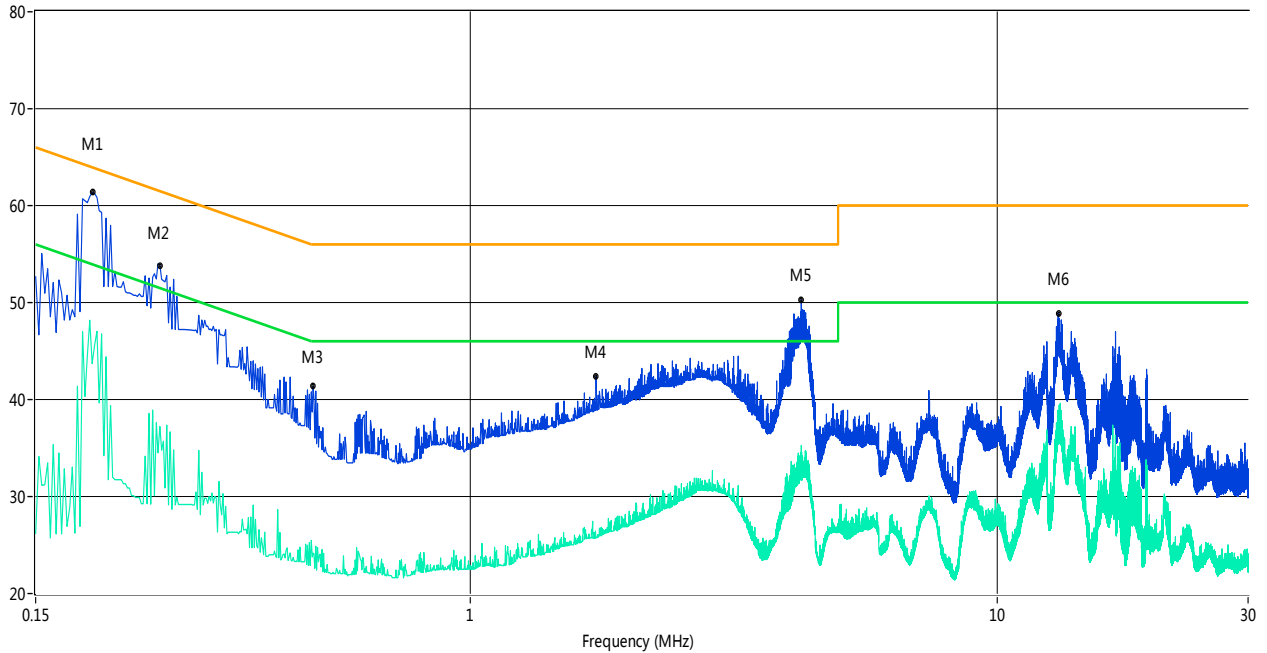

No.	Frequency (MHz)	Results (dBuV)	Factor (dB)	Limit (dBuV)	Margin (dB)	Detector	Line	Verdict
1	0.19	61.4	13.00	64.8	3.40	Peak	L Line	Pass
1**	0.19	43.7	13.00	54.8	11.10	AV	L Line	Pass
2	0.26	53.9	13.00	62.9	9.00	Peak	L Line	Pass
2**	0.26	37.2	13.00	52.9	15.70	AV	L Line	Pass
3	0.50	41.4	13.00	56.0	14.60	Peak	L Line	Pass
3**	0.50	24.2	13.00	46.0	21.80	AV	L Line	Pass
4	1.74	42.4	13.00	56.0	13.60	Peak	L Line	Pass
4**	1.74	25.8	13.00	46.0	20.20	AV	L Line	Pass
5	4.26	50.3	13.00	56.0	5.70	Peak	L Line	Pass
5**	4.26	35.3	13.00	46.0	10.70	AV	L Line	Pass
6	13.10	48.9	13.00	60.0	11.10	Peak	L Line	Pass
6**	13.10	38.5	13.00	50.0	11.50	AV	L Line	Pass

PHASE N

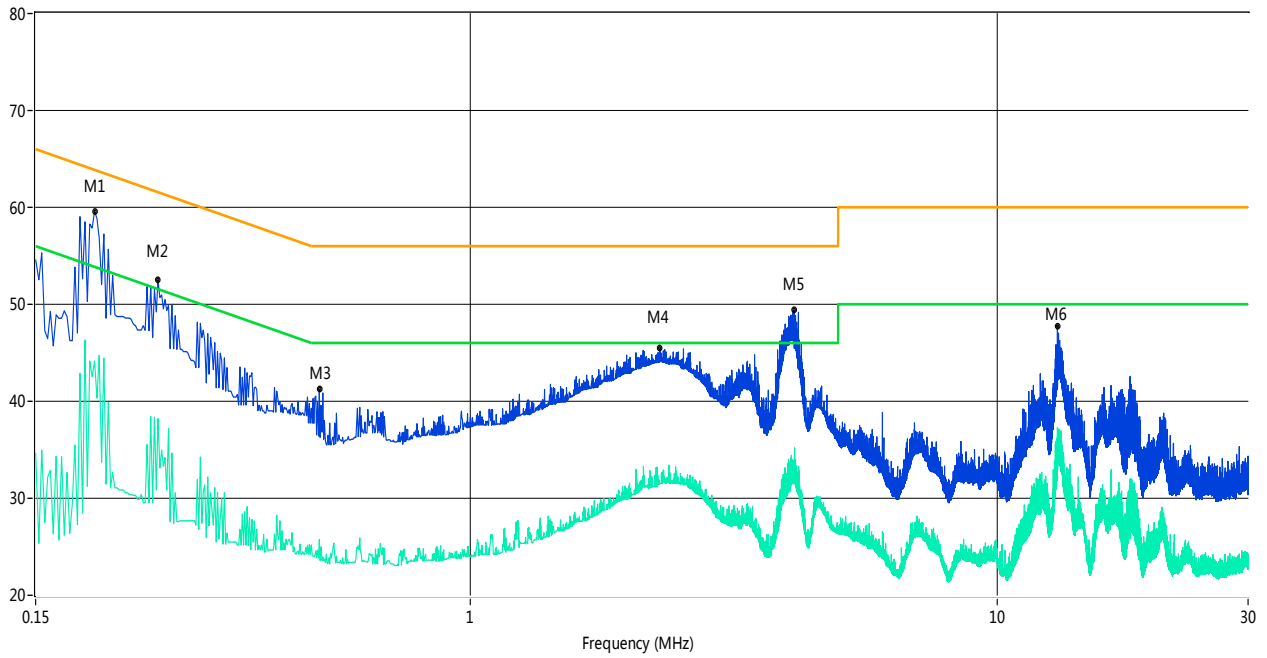

No.	Frequency (MHz)	Results (dBuV)	Factor (dB)	Limit (dBuV)	Margin (dB)	Detector	Line	Verdict
1	0.19	59.6	13.00	64.7	5.10	Peak	N Line	Pass
1**	0.19	44.1	13.00	54.7	10.60	AV	N Line	Pass
2	0.26	52.5	13.00	63.0	10.50	Peak	N Line	Pass
2**	0.26	38.2	13.00	53.0	14.80	AV	N Line	Pass
3	0.52	41.2	13.00	56.0	14.80	Peak	N Line	Pass
3**	0.52	25.7	13.00	46.0	20.30	AV	N Line	Pass
4	2.29	45.5	13.00	56.0	10.50	Peak	N Line	Pass
4**	2.29	30.4	13.00	46.0	15.60	AV	N Line	Pass
5	4.13	49.4	13.00	56.0	6.60	Peak	N Line	Pass
5**	4.13	33.9	13.00	46.0	12.10	AV	N Line	Pass
6	13.04	47.8	13.00	60.0	12.20	Peak	N Line	Pass
6**	13.04	37.3	13.00	50.0	12.70	AV	N Line	Pass

## A.8 Radiated Emission

Duty cycle correction factor for average measurement.

DH5 on time/100 ms(Count Pulses) Plot on Channel 39

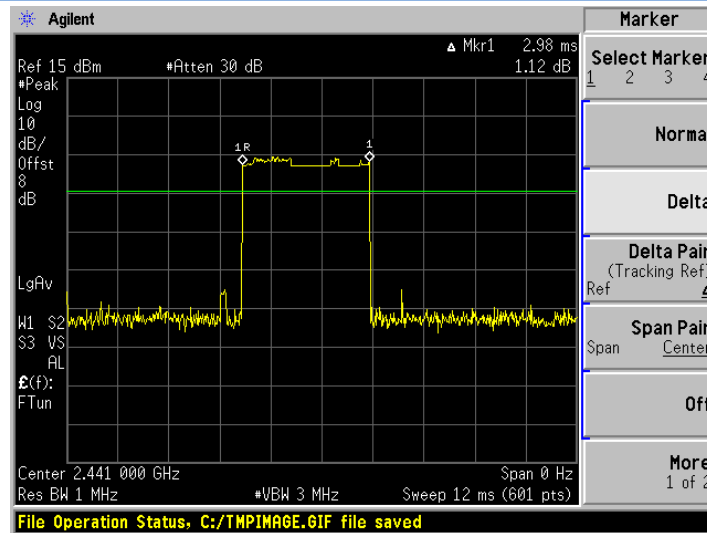

DH5 on time/100 ms(One Pulse) Plot on Channel 39

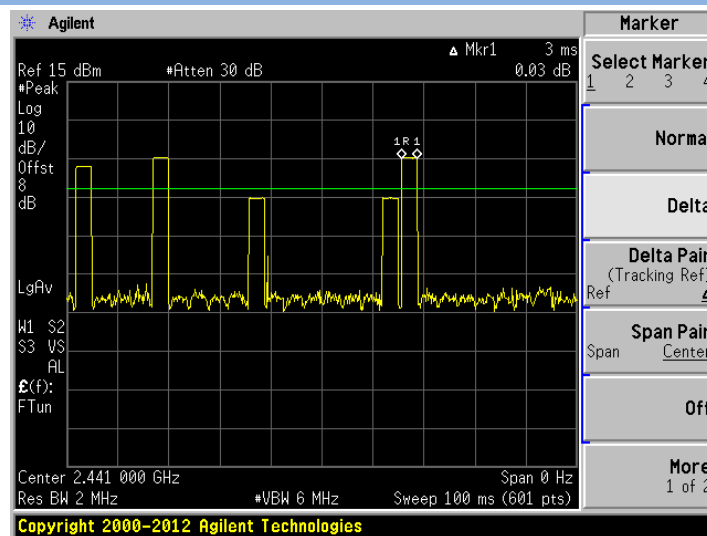

**Note:**

1. Duty cycle = on time/100 milliseconds =  $5 * 2.98 / 100 = 14.9 \%$
2. Duty cycle correction factor =  $20 * \log(\text{Duty cycle}) = -16.54 \text{ dB}$
3. DH5 has the highest duty cycle and is reported.

Note 1: The symbol of “--” in the table which means not application.

Note 2: For the test data above 1 GHz, According the ANSI C63.4-2009, where limits are specified for both average and peak (or quasi-peak) detector functions, if the peak (or quasi-peak) measured value complies with the average limit, it is unnecessary to perform an average measurement.

Note 3: All configurations have been tested, only the worst configuration (GFSK High Channel) shown here.

Test Data and Plots

The low frequency, which started from 9 kHz to 30 MHz, was pre-scanned and the result which was 20 dB lower than the limit line per 15.31(o) was not reported.

30 MHz to 1 GHz, ANT V

RE Test case\_FCC 15B 30MHz-1GHz

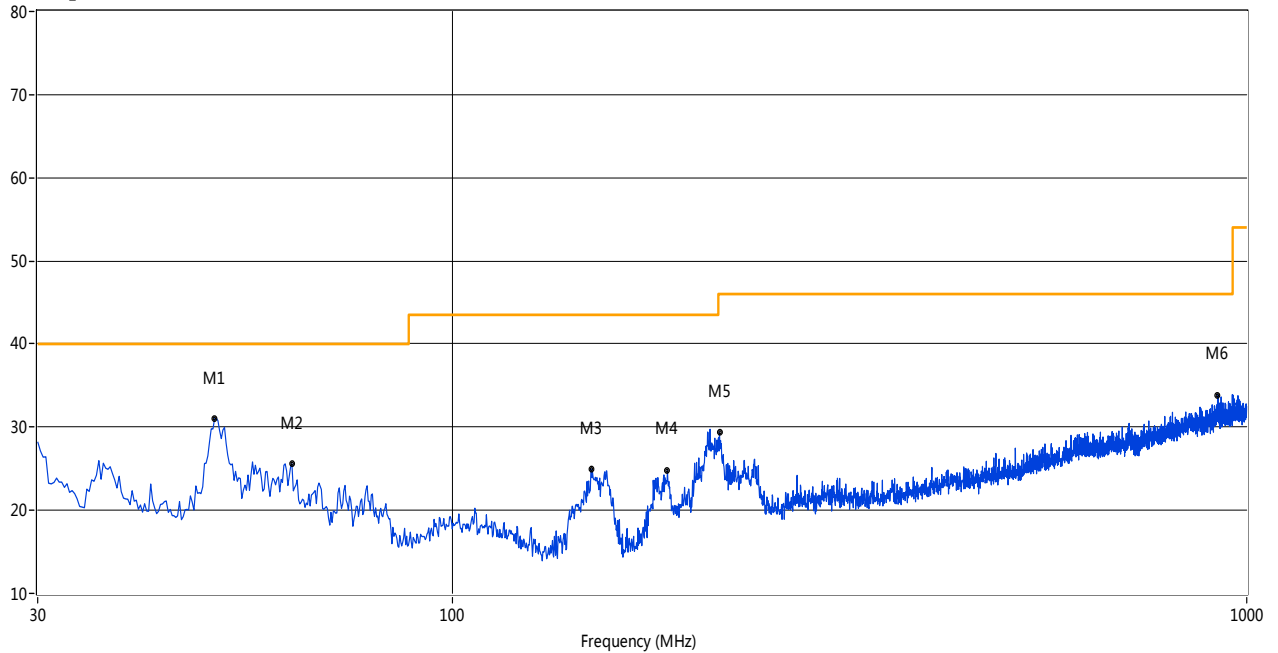

No.	Frequency (MHz)	Results (dBuV/m)	Factor (dB)	Limit (dBuV/m)	Margin (dB)	Detector	Table (o)	Height (cm)	ANT	Verdict
1	50.12	31.04	-18.66	40.0	8.96	Peak	359.60	100	Vertical	Pass
2	62.73	25.59	-20.41	40.0	14.41	Peak	339.20	100	Vertical	Pass
3	149.52	24.95	-23.48	43.5	18.55	Peak	195.00	100	Vertical	Pass
4	186.37	24.83	-21.55	43.5	18.67	Peak	236.80	100	Vertical	Pass
5	216.68	29.36	-20.02	46.0	16.64	Peak	167.10	100	Vertical	Pass
6	919.02	33.91	-5.30	46.0	12.09	Peak	269.10	100	Vertical	Pass

30 MHz to 1 GHz, ANT H

RE Test case\_FCC 15B 30MHz-1GHz

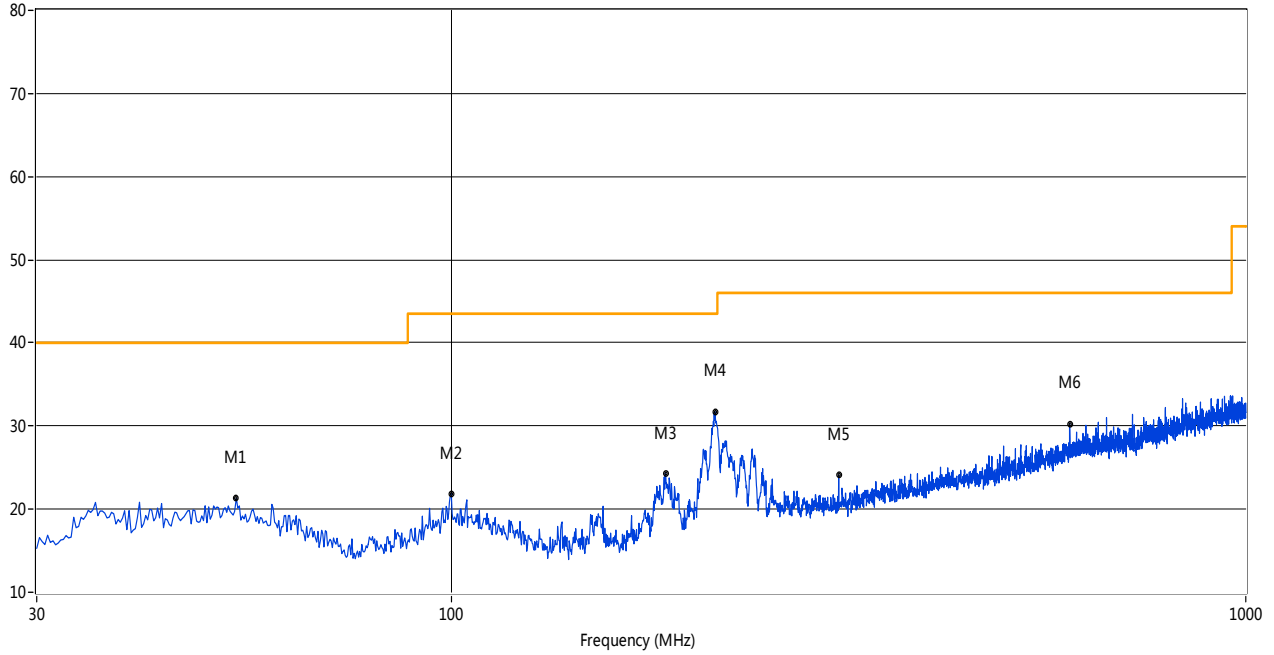

No.	Frequency (MHz)	Results (dBuV/m)	Factor (dB)	Limit (dBuV/m)	Margin (dB)	Detector	Table (o)	Height (cm)	ANT	Verdict
1	53.52	21.32	-18.77	40.0	18.68	Peak	-0.00	100	Horizontal	Pass
2	99.82	21.79	-20.20	43.5	21.71	Peak	1.60	100	Horizontal	Pass
3	185.89	24.30	-21.50	43.5	19.20	Peak	352.90	100	Horizontal	Pass
4	214.50	31.72	-19.95	43.5	11.78	Peak	339.50	100	Horizontal	Pass
5	307.11	24.09	-17.45	46.0	21.91	Peak	88.50	100	Horizontal	Pass
6	599.98	30.27	-10.76	46.0	15.73	Peak	186.20	100	Horizontal	Pass

Note: The marked spikes near 2400 MHz with circle should be ignored because they are Fundamental signal.

Test Data and Plots (1 GHz ~ 10th Harmonic)

GFSK LOW CHANNEL 1 GHz to 25 GHz, ANT V

RE Test case\_FCC 15C 1GHz-25GHz

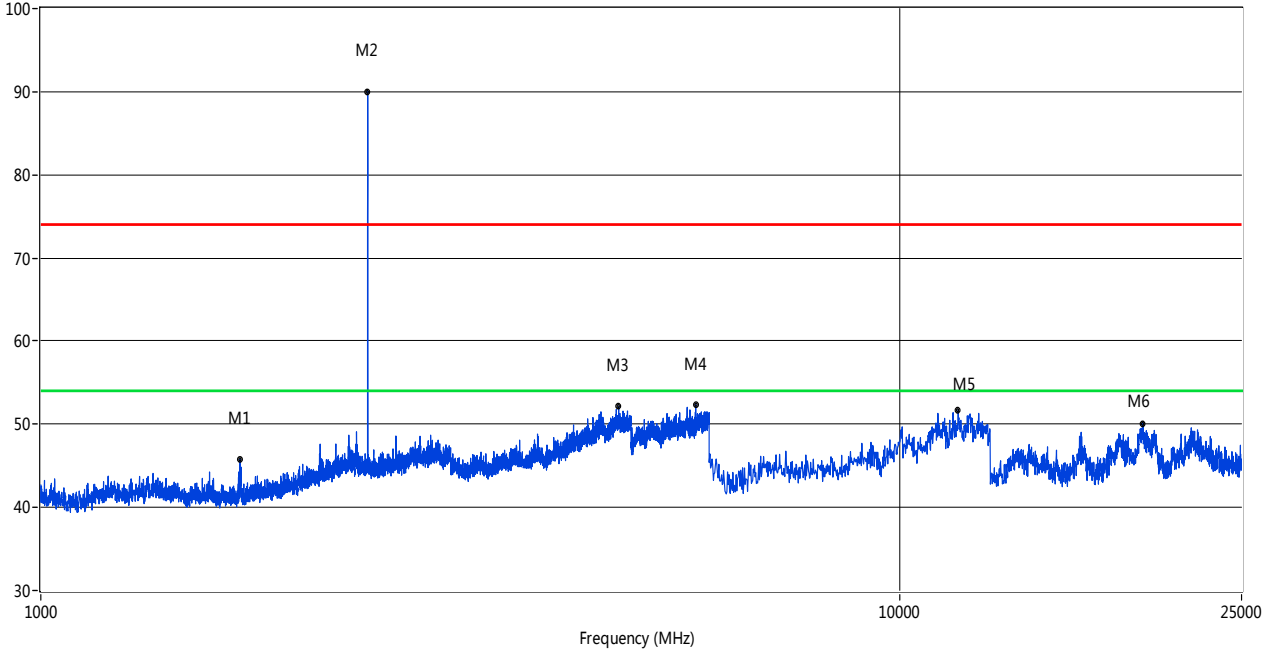

No.	Frequency (MHz)	Results (dBuV/m)	Factor (dB)	Limit (dBuV/m)	Margin (dB)	Detector	Table (o)	Height (cm)	ANT	Verdict
1	1705.32	45.80	-4.10	74.0	28.20	Peak	277.00	100	Vertical	Pass
2	2402.15	90.05	-0.34	74.0	-16.05	Peak	181.00	100	Vertical	N/A
3	4706.57	52.14	13.34	74.0	21.86	Peak	296.00	100	Vertical	Pass
4	5786.30	52.35	15.56	74.0	21.65	Peak	328.00	100	Vertical	Pass
5	11694.26	51.76	20.51	74.0	22.24	Peak	13.00	100	Vertical	Pass
6	19189.68	50.09	14.08	74.0	23.91	Peak	41.00	100	Vertical	Pass

GFSK LOW CHANNEL 1 GHz to 25 GHz, ANT H

RE Test case\_FCC 15C 1GHz-25GHz

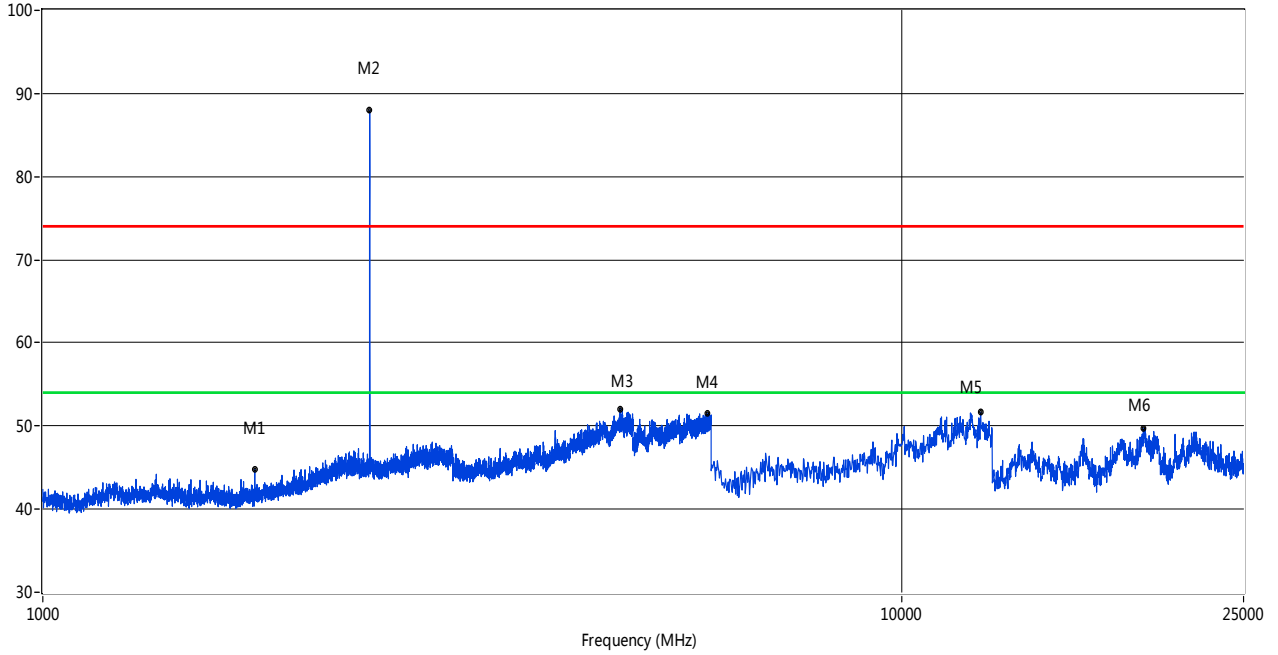

No.	Frequency (MHz)	Results (dBuV/m)	Factor (dB)	Limit (dBuV/m)	Margin (dB)	Detecto r	Table (o)	Height (cm)	ANT	Verdict
1	1764.81	44.81	-3.76	74.0	29.19	Peak	255.00	100	Horizontal	Pass
2	2402.15	87.93	-0.34	74.0	-13.93	Peak	47.00	100	Horizontal	N/A
3	4700.57	52.09	13.32	74.0	21.91	Peak	242.00	100	Horizontal	Pass
4	5937.77	51.45	15.63	74.0	22.55	Peak	314.00	100	Horizontal	Pass
5	12356.91	51.65	20.64	74.0	22.35	Peak	313.00	100	Horizontal	Pass
6	19109.82	49.67	13.79	74.0	24.33	Peak	165.00	100	Horizontal	Pass

GFSK MIDDLE CHANNEL 1 GHz to 25 GHz, ANT V

RE Test case\_FCC 15C 1GHz-25GHz

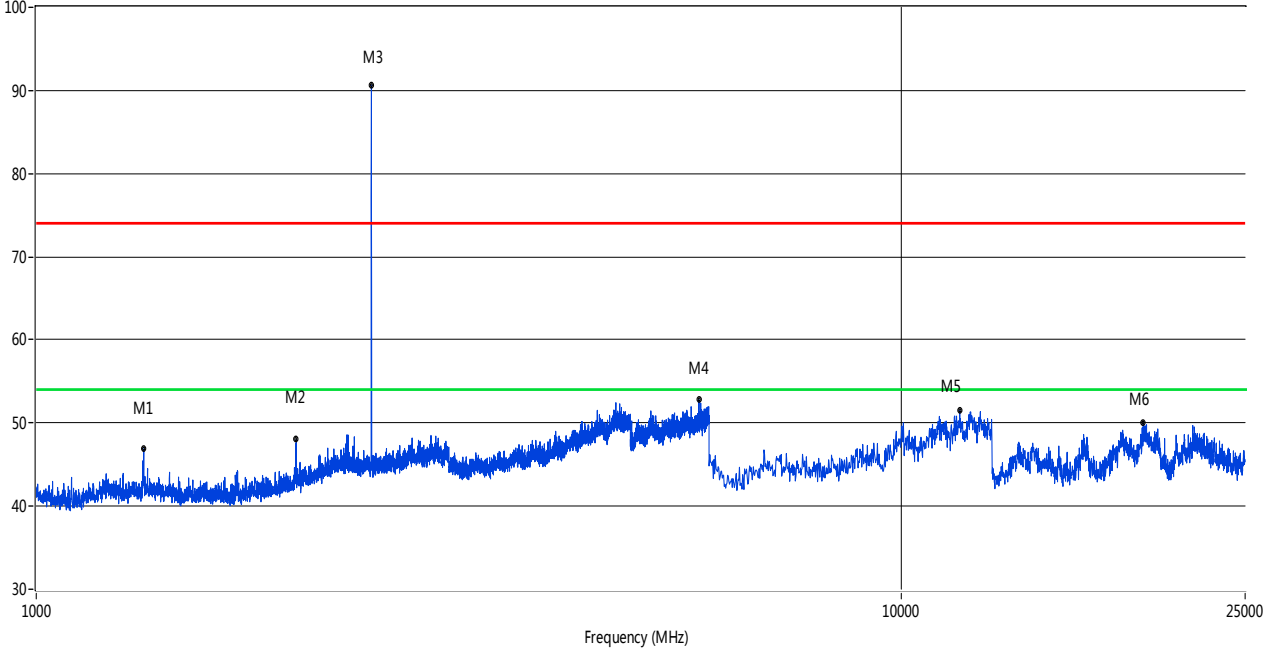

No.	Frequency (MHz)	Results (dBuV/m)	Factor (dB)	Limit (dBuV/m)	Margin (dB)	Detector	Table (o)	Height (cm)	ANT	Verdict
1	1331.92	46.90	-4.79	74.0	27.10	Peak	97.00	100	Vertical	Pass
2	1999.25	48.02	-2.39	74.0	25.98	Peak	258.00	100	Vertical	Pass
3	2441.14	90.64	-0.38	74.0	-16.64	Peak	32.00	100	Vertical	N/A
4	5839.54	52.78	15.56	74.0	21.22	Peak	121.00	100	Vertical	Pass
5	11694.26	51.51	20.51	74.0	22.49	Peak	15.00	100	Vertical	Pass
6	19059.90	49.98	13.60	74.0	24.02	Peak	299.00	100	Vertical	Pass



GFSK MIDDLE CHANNEL 1 GHz to 25 GHz, ANT H

RE Test case\_FCC 15C 1GHz-25GHz

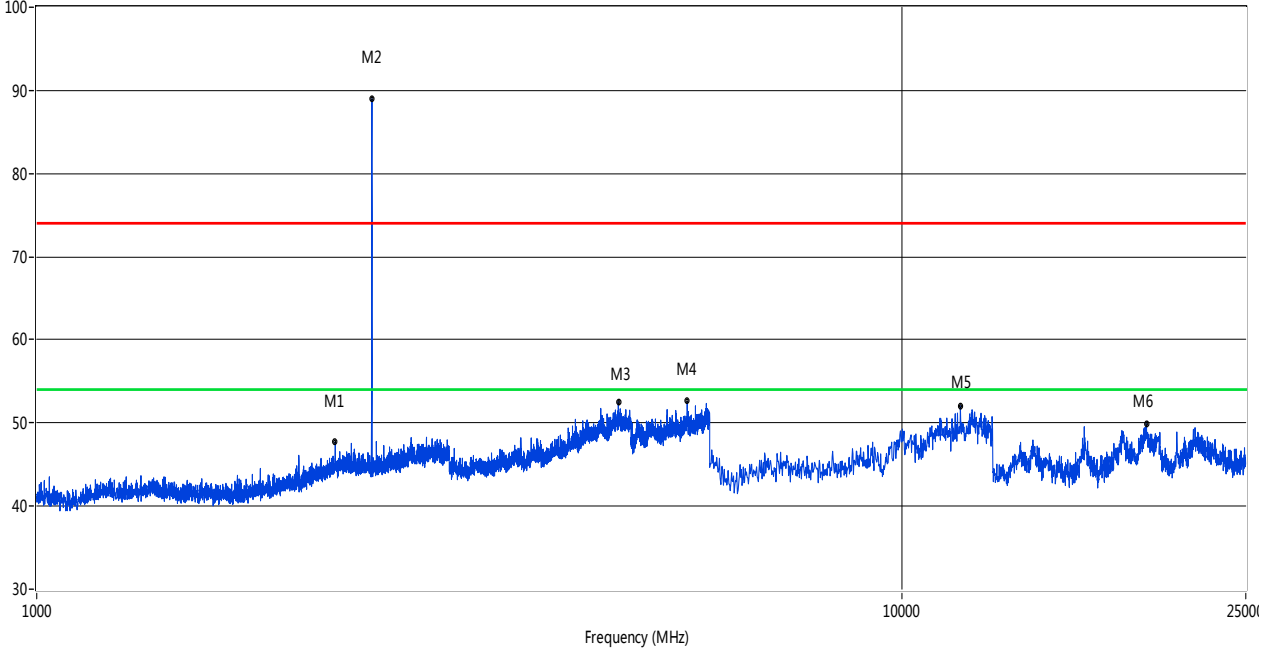

No.	Frequency (MHz)	Results (dBuV/m)	Factor (dB)	Limit (dBuV/m)	Margin (dB)	Detecto r	Table (o)	Height (cm)	ANT	Verdict
1	2213.70	47.75	-0.22	74.0	26.25	Peak	102.00	100	Horizontal	Pass
2	2441.14	89.00	-0.38	74.0	-15.00	Peak	215.00	100	Horizontal	N/A
3	4705.07	52.55	13.33	74.0	21.45	Peak	193.00	100	Horizontal	Pass
4	5652.09	52.60	15.66	74.0	21.40	Peak	175.00	100	Horizontal	Pass
5	11694.26	52.02	20.51	74.0	21.98	Peak	80.00	100	Horizontal	Pass
6	19189.68	49.90	14.08	74.0	24.10	Peak	259.00	100	Horizontal	Pass

GFSK HIGH CHANNEL 1 GHz to 25 GHz, ANT V

RE Test case\_FCC 15C 1GHz-25GHz

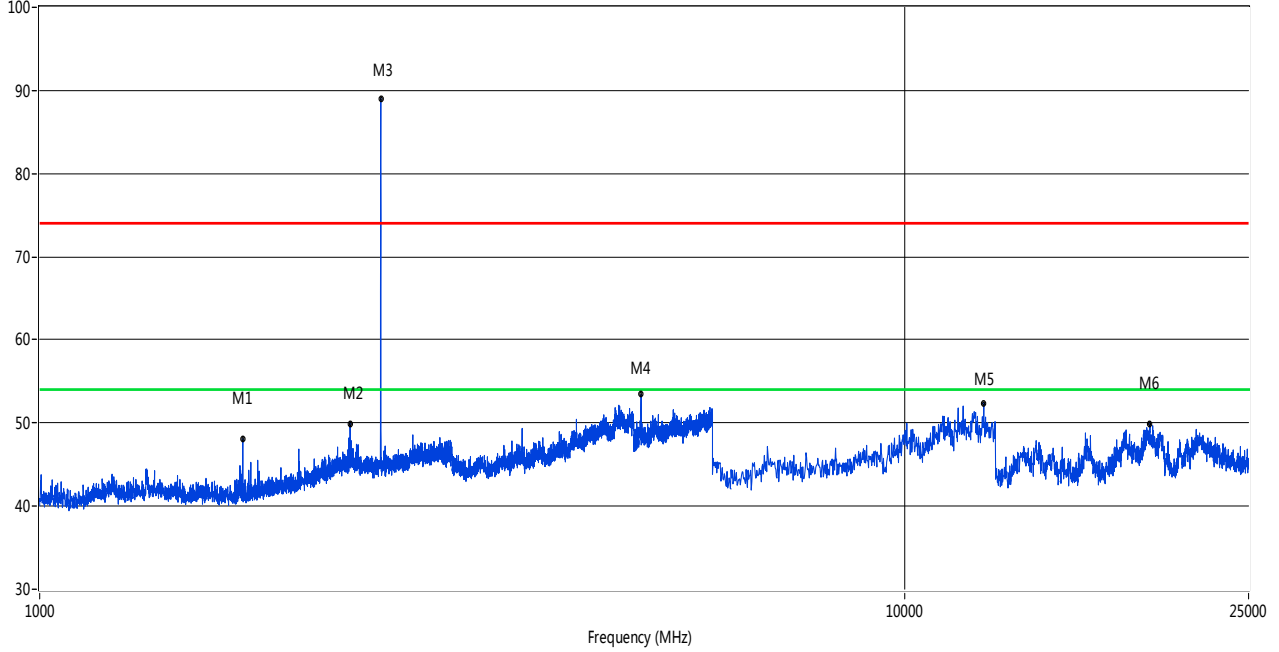

No.	Frequency (MHz)	Results (dBuV/m)	Factor (dB)	Limit (dBuV/m)	Margin (dB)	Detector	Table (o)	Height (cm)	ANT	Verdict
1	1717.82	48.10	-4.02	74.0	25.90	Peak	352.00	100	Vertical	Pass
2	2286.18	49.96	-0.48	74.0	24.04	Peak	206.00	100	Vertical	Pass
3	2480.13	89.04	-0.60	74.0	-15.04	Peak	192.00	100	Vertical	N/A
4	4960.76	53.42	14.26	74.0	20.58	Peak	300.00	100	Vertical	Pass
5	12356.91	52.38	20.64	74.0	21.62	Peak	324.00	100	Vertical	Pass
6	19229.62	49.96	13.94	74.0	24.04	Peak	186.00	100	Vertical	Pass

GFSK HIGH CHANNEL 1 GHz to 25 GHz, ANT H

RE Test case\_FCC 15C 1GHz-25GHz

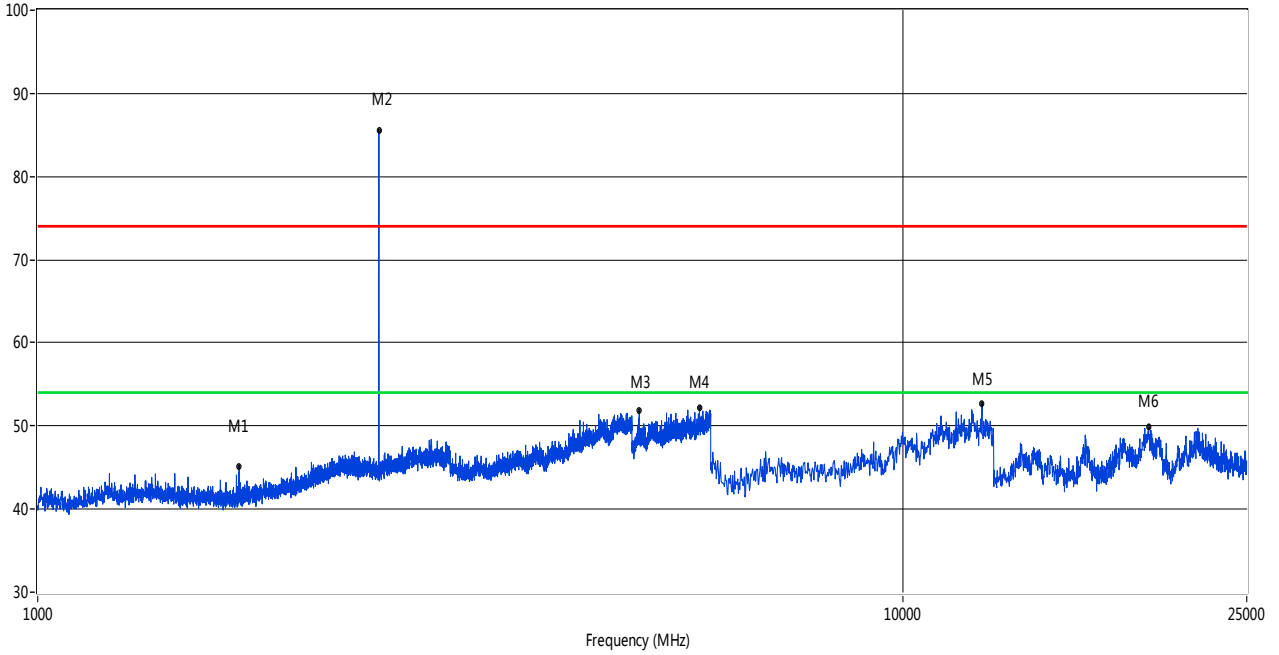

No.	Frequency (MHz)	Results (dBuV/m)	Factor (dB)	Limit (dBuV/m)	Margin (dB)	Detecto r	Table (o)	Height (cm)	ANT	Verdict
1	1709.82	45.19	-4.07	74.0	28.81	Peak	27.00	100	Horizontal	Pass
2	2480.13	85.56	-0.60	74.0	-11.56	Peak	164.00	100	Horizontal	N/A
3	4960.01	51.87	14.22	74.0	22.13	Peak	205.00	100	Horizontal	Pass
4	5823.79	52.22	15.51	74.0	21.78	Peak	53.00	100	Horizontal	Pass
5	12356.91	52.70	20.64	74.0	21.30	Peak	280.00	100	Horizontal	Pass
6	19249.58	49.83	13.82	74.0	24.17	Peak	219.00	100	Horizontal	Pass

Π/4-DQPSK LOW CHANNEL 1 GHz to 25 GHz, ANT V

RE Test case\_FCC 15C 1GHz-25GHz

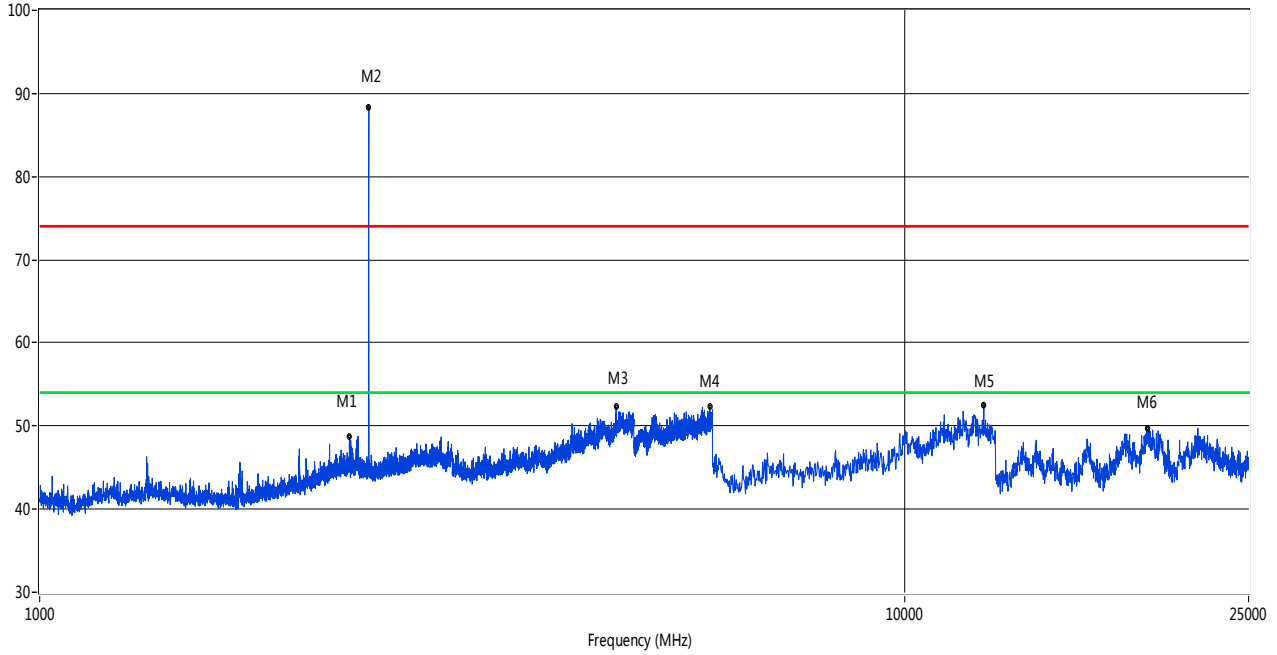

No.	Frequency (MHz)	Results (dBuV/m)	Factor (dB)	Limit (dBuV/m)	Margin (dB)	Detector	Table (o)	Height (cm)	ANT	Verdict
1	2281.68	48.66	-0.47	74.0	25.34	Peak	174.00	100	Vertical	Pass
2	2402.15	88.37	-0.34	74.0	-14.37	Peak	1.00	100	Vertical	N/A
3	4642.84	52.27	13.07	74.0	21.73	Peak	156.00	100	Vertical	Pass
4	5952.76	52.32	15.90	74.0	21.68	Peak	194.00	100	Vertical	Pass
5	12356.91	52.50	20.64	74.0	21.50	Peak	198.00	100	Vertical	Pass
6	19079.87	49.64	13.68	74.0	24.36	Peak	133.00	100	Vertical	Pass

□/4-DQPSK LOW CHANNEL 1 GHz to 25 GHz, ANT H

RE Test case\_FCC 15C 1GHz-25GHz

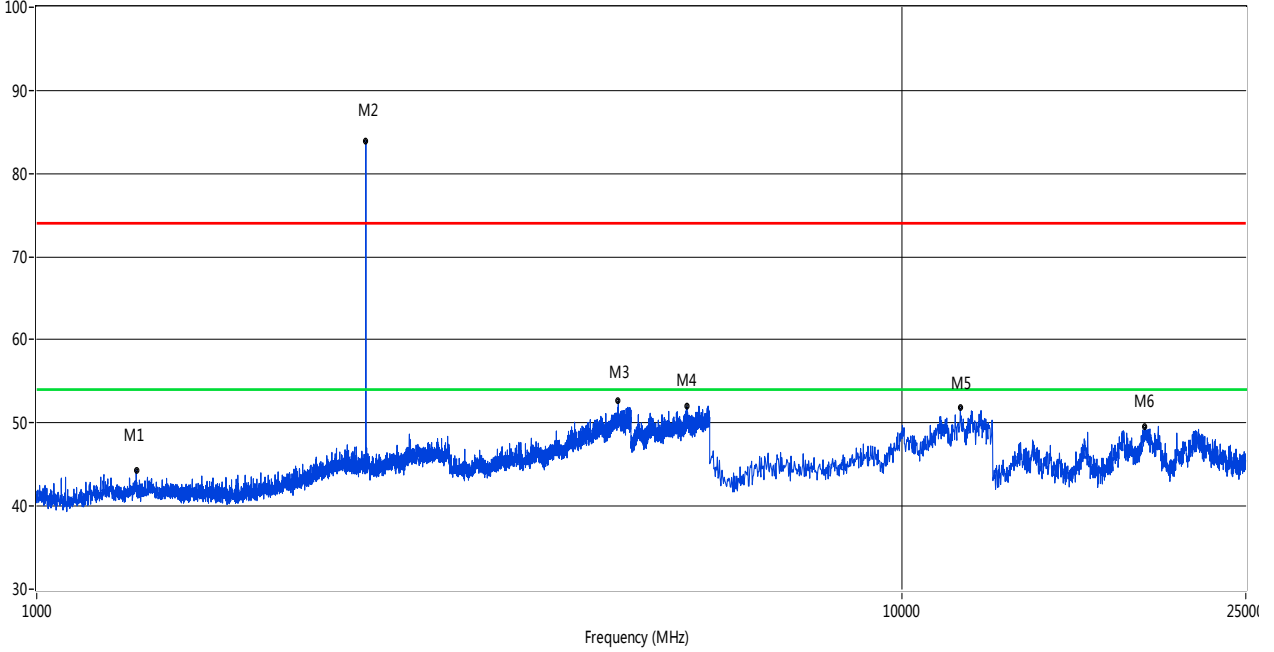

No.	Frequency (MHz)	Results (dBuV/m)	Factor (dB)	Limit (dBuV/m)	Margin (dB)	Detecto r	Table (o)	Height (cm)	ANT	Verdic t
1	1303.42	44.36	-4.73	74.0	29.64	Peak	70.00	100	Horizontal	Pass
2	2402.15	83.95	-0.34	74.0	-9.95	Peak	259.00	100	Horizontal	N/A
3	4704.32	52.64	13.32	74.0	21.36	Peak	228.00	100	Horizontal	Pass
4	5646.84	51.96	15.60	74.0	22.04	Peak	86.00	100	Horizontal	Pass
5	11694.26	51.80	20.51	74.0	22.20	Peak	298.00	100	Horizontal	Pass
6	19119.80	49.51	13.82	74.0	24.49	Peak	46.00	100	Horizontal	Pass

Π/4-DQPSK MIDDLE CHANNEL 1 GHz to 25 GHz, ANT V

RE Test case\_FCC 15C 1GHz-25GHz

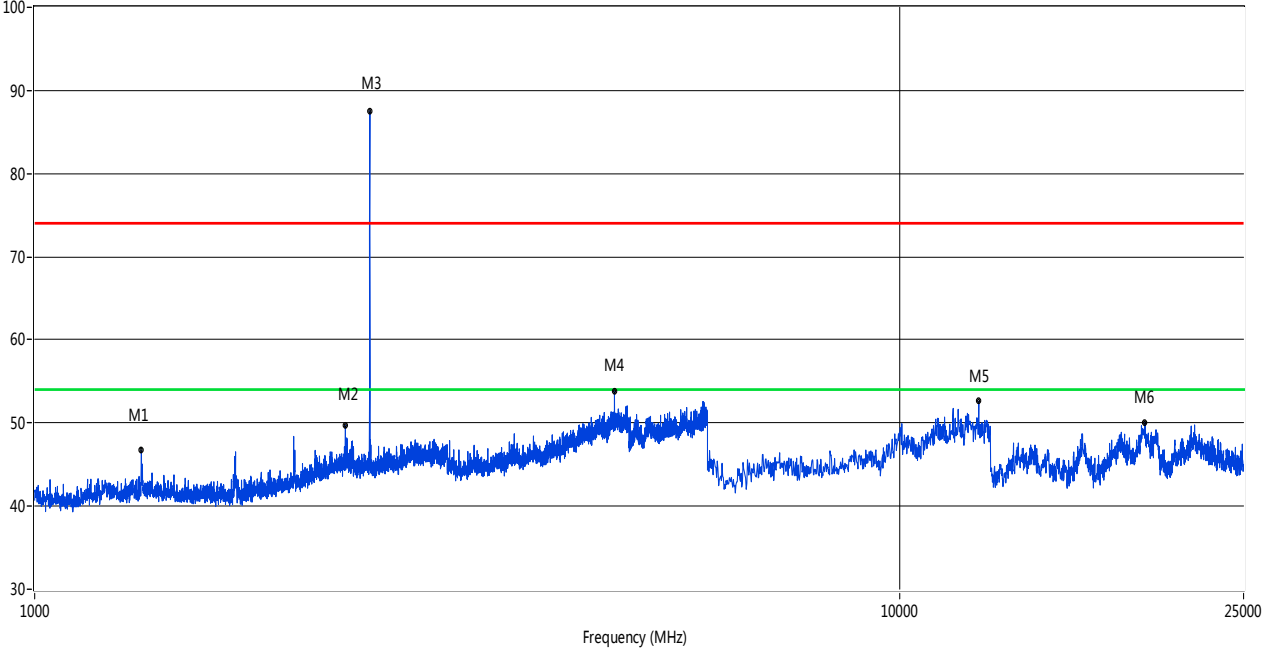

No.	Frequency (MHz)	Results (dBuV/m)	Factor (dB)	Limit (dBuV/m)	Margin (dB)	Detector	Table (o)	Height (cm)	ANT	Verdict
1	1328.42	46.72	-4.75	74.0	27.28	Peak	95.00	100	Vertical	Pass
2	2287.18	49.70	-0.46	74.0	24.30	Peak	267.00	100	Vertical	Pass
3	2441.14	87.51	-0.38	74.0	-13.51	Peak	84.00	100	Vertical	N/A
4	4682.58	53.78	13.17	74.0	20.22	Peak	40.00	100	Vertical	Pass
5	12356.91	52.60	20.64	74.0	21.40	Peak	214.00	100	Vertical	Pass
6	19229.62	50.02	13.94	74.0	23.98	Peak	260.00	100	Vertical	Pass

□/4-DQPSK MIDDLE CHANNEL 1 GHz to 25 GHz, ANT H

RE Test case\_FCC 15C 1GHz-25GHz

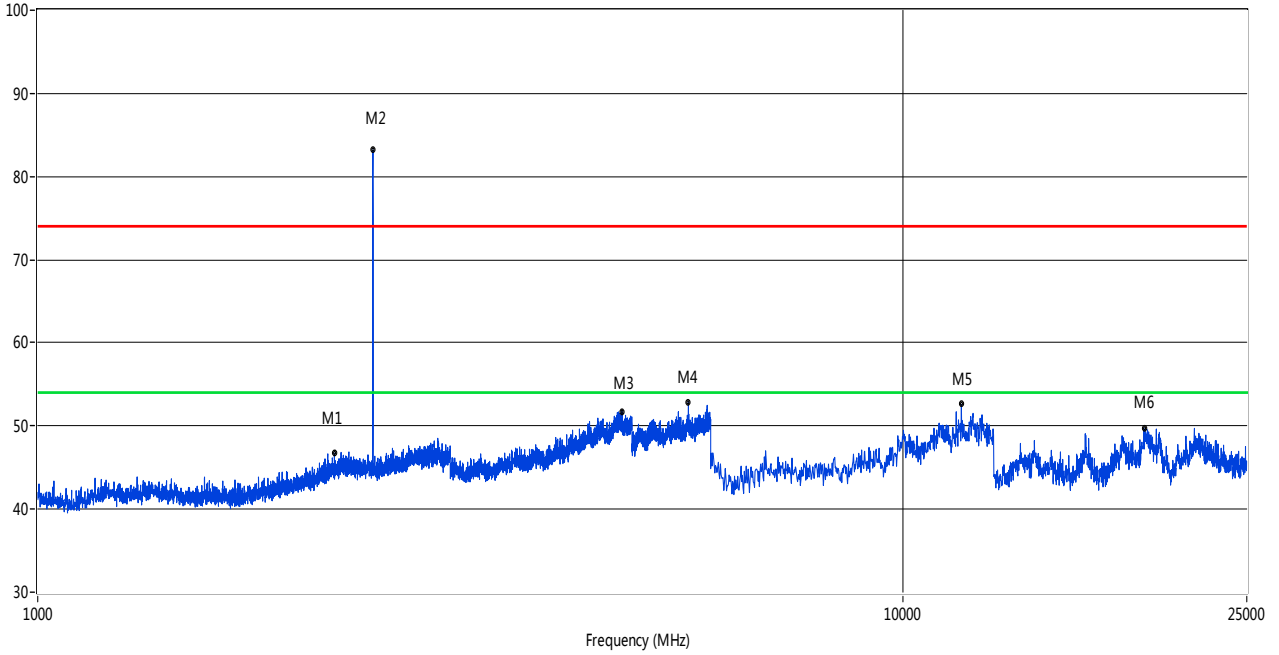

No.	Frequency (MHz)	Results (dBuV/m)	Factor (dB)	Limit (dBuV/m)	Margin (dB)	Detector	Table (o)	Height (cm)	ANT	Verdict
1	2203.20	46.69	-0.35	74.0	27.31	Peak	157.00	100	Horizontal	Pass
2	2441.14	83.18	-0.38	74.0	-9.18	Peak	162.00	100	Horizontal	N/A
3	4736.57	51.73	13.61	74.0	22.27	Peak	237.00	100	Horizontal	Pass
4	5653.59	52.90	15.62	74.0	21.10	Peak	345.00	100	Horizontal	Pass
5	11694.26	52.60	20.51	74.0	21.40	Peak	47.00	100	Horizontal	Pass
6	19059.90	49.66	13.60	74.0	24.34	Peak	255.00	100	Horizontal	Pass

Π/4-DQPSK HIGH CHANNEL 1 GHz to 25 GHz, ANT V

RE Test case\_FCC 15C 1GHz-25GHz

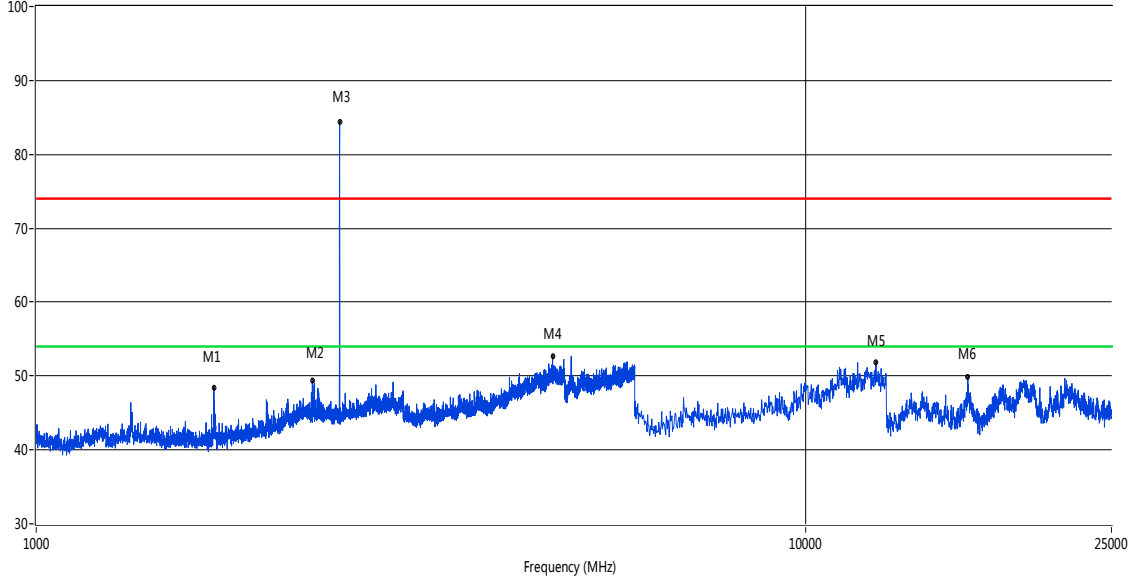

No.	Frequency (MHz)	Results (dBuV/m)	Factor (dB)	Limit (dBuV/m)	Margin (dB)	Detector	Table (o)	Height (cm)	ANT
1	1702.32	48.44	-4.12	74.0	25.56	Peak	296.00	100	Vertical
2	2285.18	49.34	-0.54	74.0	24.66	Peak	175.00	100	Vertical
3	2480.13	84.40	-0.60	74.0	-10.40	Peak	192.00	100	Vertical
4	4693.08	52.59	13.24	74.0	21.41	Peak	317.00	100	Vertical
5	12356.91	51.81	20.64	74.0	22.19	Peak	177.00	100	Vertical
6	16264.98	49.83	11.53	74.0	24.17	Peak	299.00	100	Vertical



□/4-DQPSK HIGH CHANNEL 1 GHz to 25 GHz, ANT H

RE Test case\_FCC 15C 1GHz-25GHz

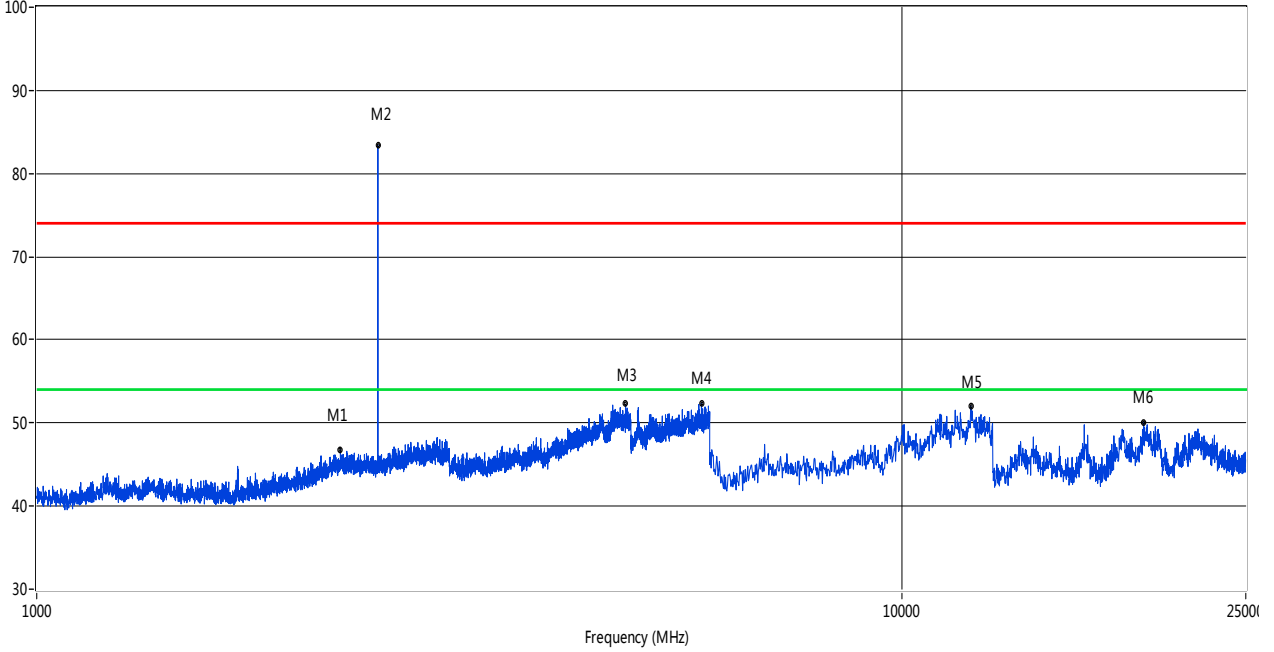

No.	Frequency (MHz)	Results (dBuV/m)	Factor (dB)	Limit (dBuV/m)	Margin (dB)	Detecto r	Table (o)	Height (cm)	ANT	Verdict
1	2245.19	46.78	-0.25	74.0	27.22	Peak	318.00	100	Horizontal	Pass
2	2480.13	83.37	-0.60	74.0	-9.37	Peak	6.00	100	Horizontal	N/A
3	4797.30	52.27	13.69	74.0	21.73	Peak	289.00	100	Horizontal	Pass
4	5870.28	52.31	15.45	74.0	21.69	Peak	2.00	100	Horizontal	Pass
5	12019.97	52.06	20.86	74.0	21.94	Peak	194.00	100	Horizontal	Pass
6	19049.92	49.99	13.57	74.0	24.01	Peak	295.00	100	Horizontal	Pass

## 8-DPSK LOW CHANNEL 1 GHz to 25 GHz, ANT V

RE Test case\_FCC 15C 1GHz-25GHz

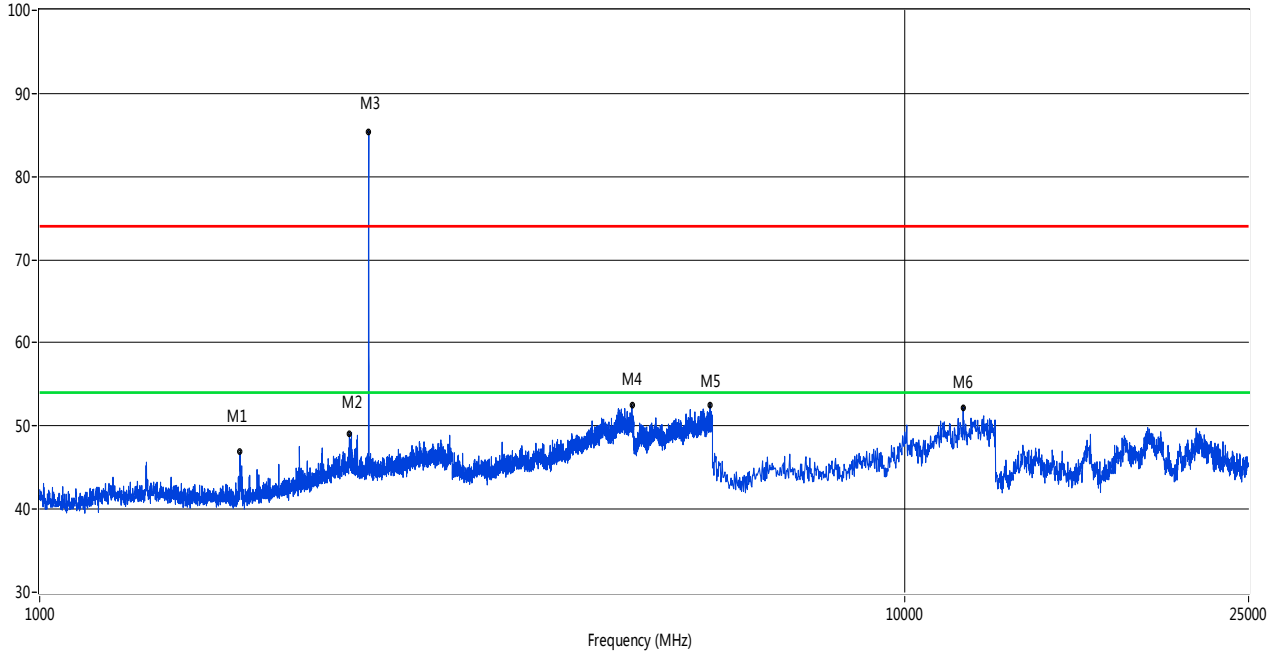

No.	Frequency (MHz)	Results (dBuV/m)	Factor (dB)	Limit (dBuV/m)	Margin (dB)	Detector	Table (o)	Height (cm)	ANT	Verdict
1	1705.82	46.89	-4.15	74.0	27.11	Peak	173.00	100	Vertical	Pass
2	2281.68	49.05	-0.47	74.0	24.95	Peak	26.00	100	Vertical	Pass
3	2402.15	85.43	-0.34	74.0	-11.43	Peak	354.00	100	Vertical	N/A
4	4840.79	52.45	13.71	74.0	21.55	Peak	104.00	100	Vertical	Pass
5	5960.26	52.58	15.72	74.0	21.42	Peak	325.00	100	Vertical	Pass
6	11694.26	52.23	20.51	74.0	21.77	Peak	92.00	100	Vertical	Pass

8-DPSK LOW CHANNEL 1 GHz to 25 GHz, ANT H

RE Test case\_FCC 15C 1GHz-25GHz

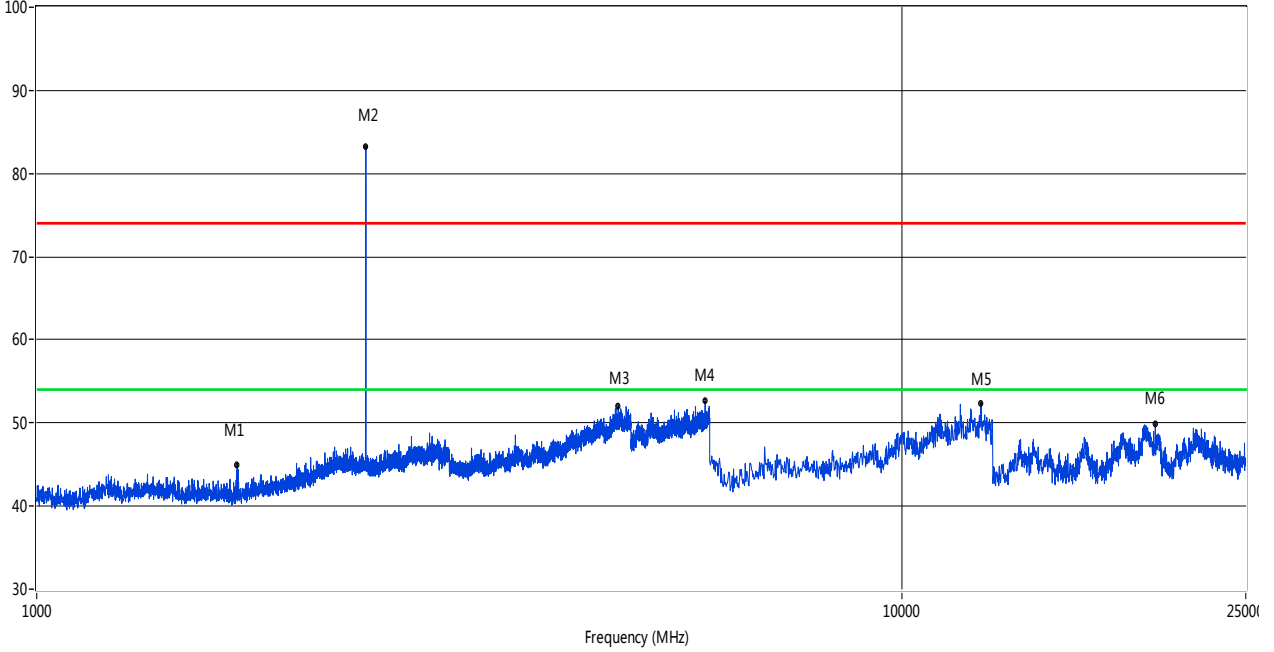

No.	Frequency (MHz)	Results (dBuV/m)	Factor (dB)	Limit (dBuV/m)	Margin (dB)	Detector	Table (o)	Height (cm)	ANT	Verdict
1	1705.32	45.02	-4.10	74.0	28.98	Peak	72.00	100	Horizontal	Pass
2	2402.15	83.27	-0.34	74.0	-9.27	Peak	77.00	100	Horizontal	N/A
3	4702.07	51.99	13.30	74.0	22.01	Peak	297.00	100	Horizontal	Pass
4	5928.02	52.62	15.74	74.0	21.38	Peak	282.00	100	Horizontal	Pass
5	12356.91	52.40	20.64	74.0	21.60	Peak	237.00	100	Horizontal	Pass
6	19648.92	49.86	12.99	74.0	24.14	Peak	262.00	100	Horizontal	Pass

8-DPSK MIDDLE CHANNEL 1 GHz to 25 GHz, ANT V

RE Test case\_FCC 15C 1GHz-25GHz

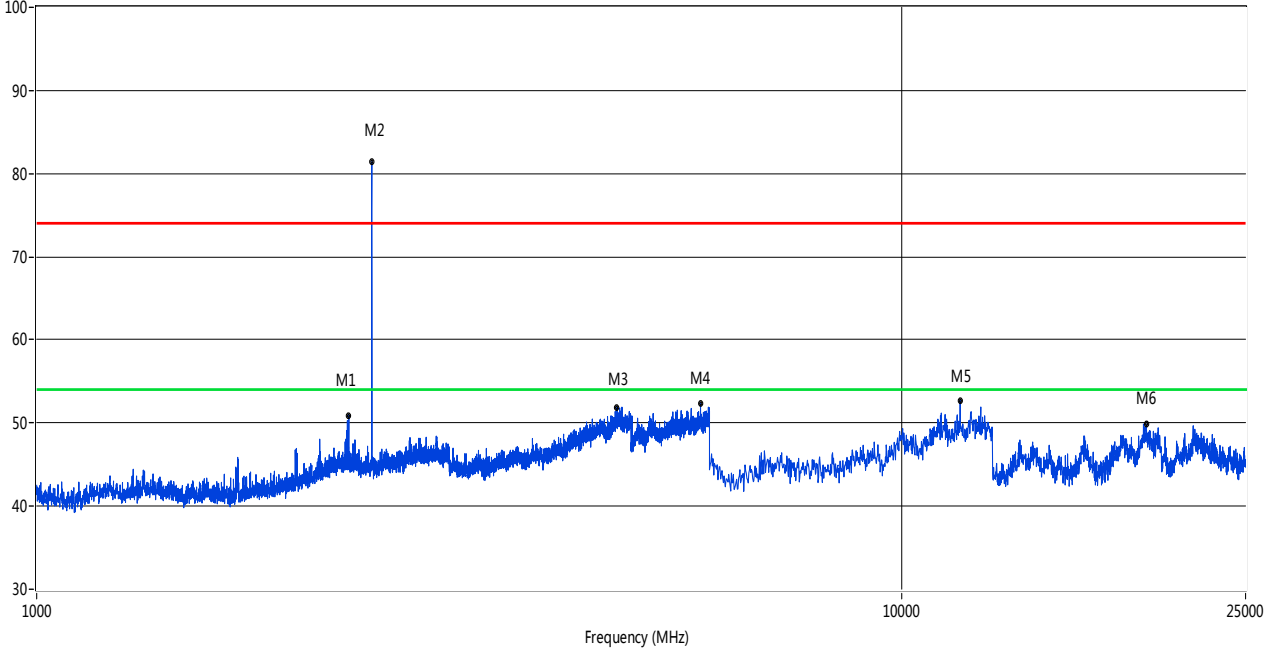

No.	Frequency (MHz)	Results (dBuV/m)	Factor (dB)	Limit (dBuV/m)	Margin (dB)	Detector	Table (o)	Height (cm)	ANT	Verdict
1	2296.18	50.94	-0.34	74.0	23.06	Peak	338.00	100	Vertical	Pass
2	2441.14	81.42	-0.38	74.0	-7.42	Peak	111.00	100	Vertical	N/A
3	4690.08	51.91	13.22	74.0	22.09	Peak	358.00	100	Vertical	Pass
4	5856.79	52.31	15.60	74.0	21.69	Peak	347.00	100	Vertical	Pass
5	11694.26	52.72	20.51	74.0	21.28	Peak	25.00	100	Vertical	Pass
6	19199.67	49.83	14.12	74.0	24.17	Peak	40.00	100	Vertical	Pass

8-DPSK MIDDLE CHANNEL 1 GHz to 25 GHz, ANT H

RE Test case\_FCC 15C 1GHz-25GHz

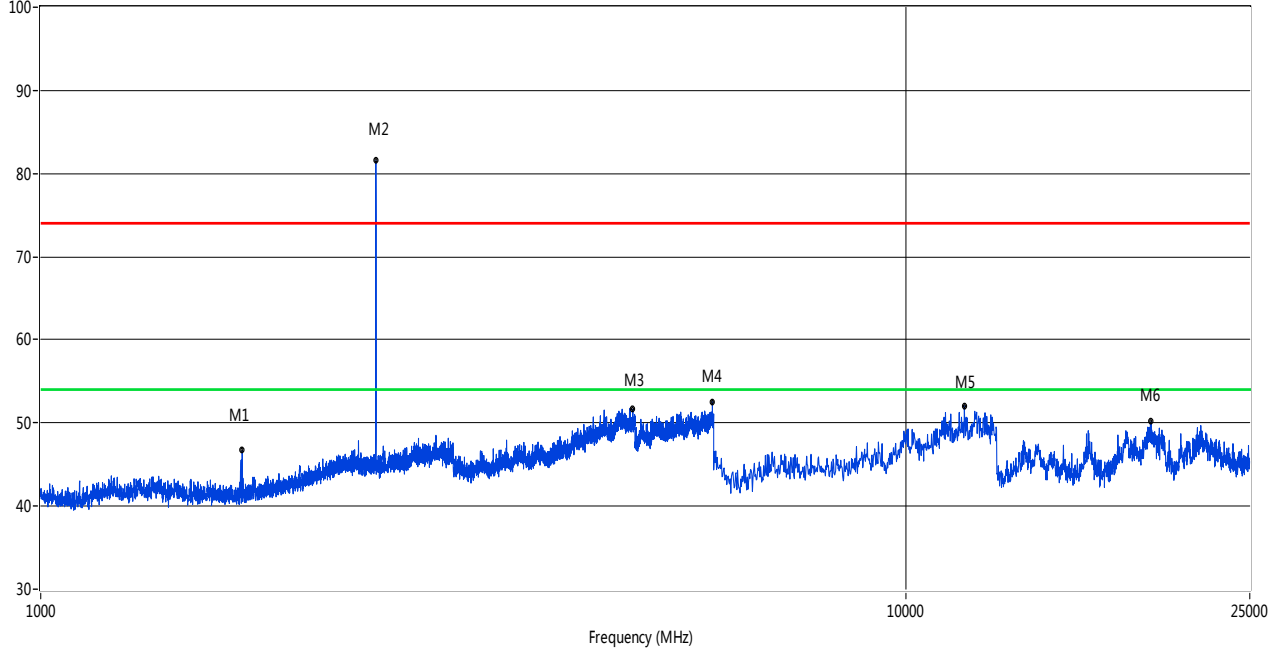

No.	Frequency (MHz)	Results (dBuV/m)	Factor (dB)	Limit (dBuV/m)	Margin (dB)	Detector	Table (o)	Height (cm)	ANT	Verdict
1	1709.82	46.69	-4.07	74.0	27.31	Peak	210.00	100	Horizontal	Pass
2	2441.14	81.53	-0.38	74.0	-7.53	Peak	273.00	100	Horizontal	N/A
3	4837.79	51.65	13.64	74.0	22.35	Peak	73.00	100	Horizontal	Pass
4	5979.01	52.52	15.74	74.0	21.48	Peak	90.00	100	Horizontal	Pass
5	11694.26	52.05	20.51	74.0	21.95	Peak	196.00	100	Horizontal	Pass
6	19229.62	50.17	13.94	74.0	23.83	Peak	76.00	100	Horizontal	Pass

8-DPSK HIGH CHANNEL 1 GHz to 25 GHz, ANT V

RE Test case\_FCC 15C 1GHz-25GHz

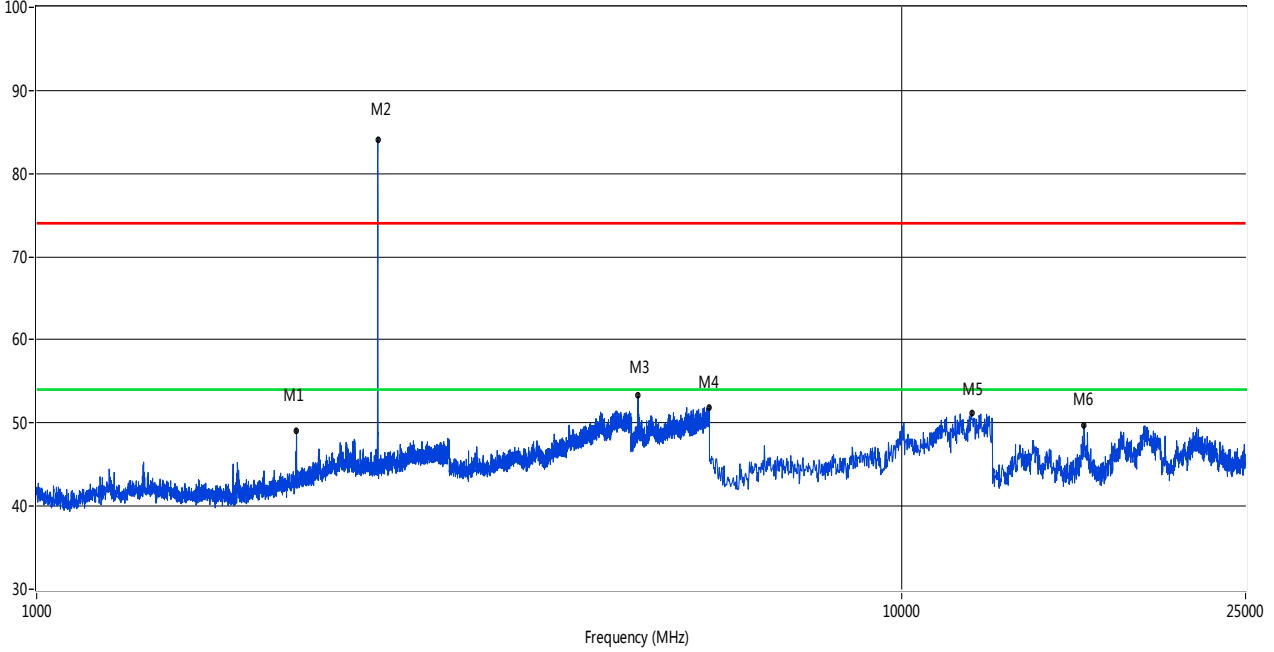

No.	Frequency (MHz)	Results (dBuV/m)	Factor (dB)	Limit (dBuV/m)	Margin (dB)	Detector	Table (o)	Height (cm)	ANT	Verdict
1	1997.75	49.10	-2.46	74.0	24.90	Peak	145.00	100	Vertical	Pass
2	2480.13	84.11	-0.60	74.0	-10.11	Peak	110.00	100	Vertical	N/A
3	4960.01	53.25	14.22	74.0	20.75	Peak	67.00	100	Vertical	Pass
4	6000.00	51.83	15.85	74.0	22.17	Peak	204.00	100	Vertical	Pass
5	12053.66	51.20	20.82	74.0	22.80	Peak	17.00	100	Vertical	Pass
6	16264.98	49.77	11.53	74.0	24.23	Peak	152.00	100	Vertical	Pass

8-DPSK HIGH CHANNEL 1 GHz to 25 GHz, ANT H

RE Test case\_FCC 15C 1GHz-25GHz

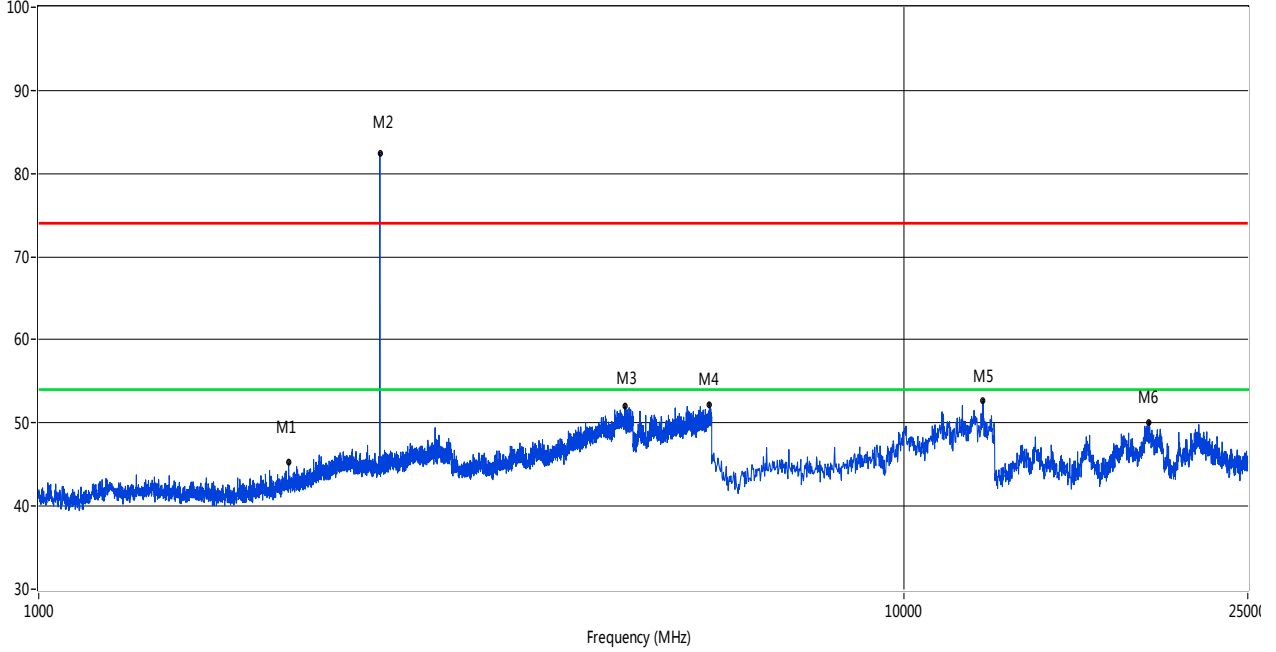

No.	Frequency (MHz)	Results (dBuV/m)	Factor (dB)	Limit (dBuV/m)	Margin (dB)	Detector	Table (o)	Height (cm)	ANT	Verdict
1	1945.76	45.23	-2.42	74.0	28.77	Peak	209.00	100	Horizontal	Pass
2	2480.13	82.49	-0.60	74.0	-8.49	Peak	257.00	100	Horizontal	N/A
3	4763.56	52.00	13.55	74.0	22.00	Peak	57.00	100	Horizontal	Pass
4	5963.26	52.24	15.67	74.0	21.76	Peak	299.00	100	Horizontal	Pass
5	12356.91	52.70	20.64	74.0	21.30	Peak	156.00	100	Horizontal	Pass
6	19229.62	49.99	13.94	74.0	24.01	Peak	83.00	100	Horizontal	Pass

Hopping Mode:

GFSK MODE 1 GHz to 25 GHz, ANT V

RE Test case\_FCC 15C 1GHz-25GHz

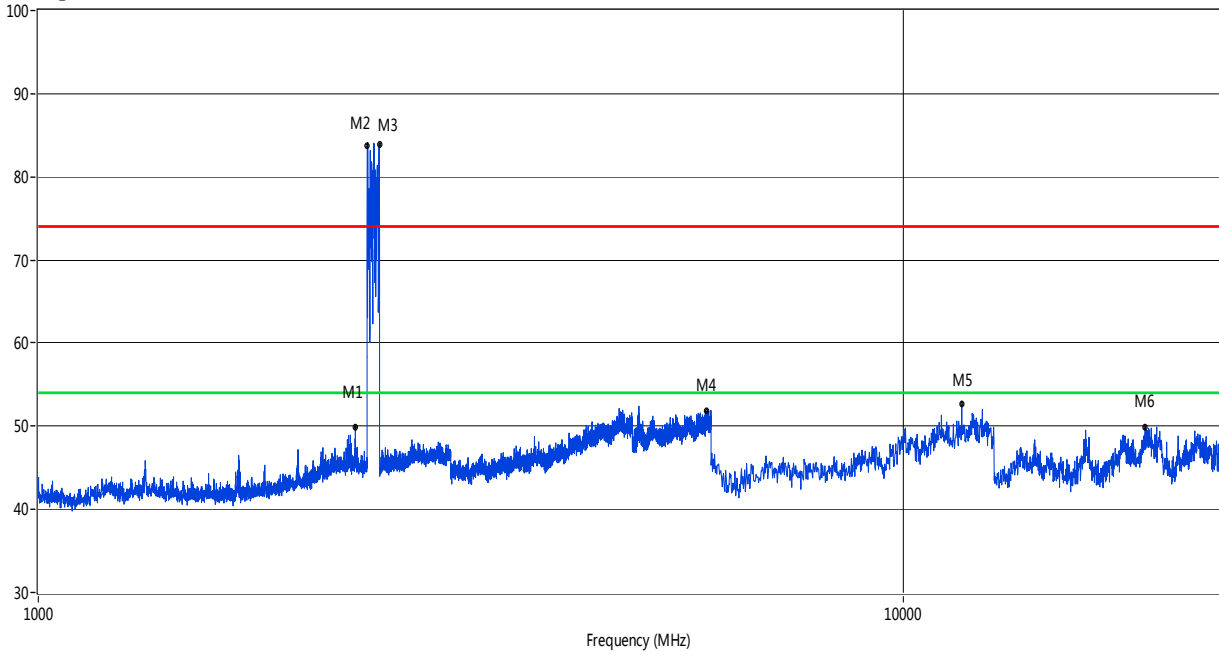

No.	Frequency (MHz)	Results (dBuV/m)	Factor (dB)	Limit (dBuV/m)	Margin (dB)	Detector	Table (o)	Height (cm)	ANT	Verdict
1	2327.17	49.93	-0.52	74.0	24.07	Peak	126.00	100	Vertical	Pass
2	2402.15	83.73	-0.34	74.0	-9.73	Peak	191.00	100	Vertical	N/A
3	2480.63	83.91	-0.60	74.0	-9.91	Peak	353.00	100	Vertical	N/A
4	5918.27	51.85	15.90	74.0	22.15	Peak	116.00	100	Vertical	Pass
5	11694.26	52.62	20.51	74.0	21.38	Peak	30.00	100	Vertical	Pass
6	19059.90	49.85	13.60	74.0	24.15	Peak	71.00	100	Vertical	Pass



GFSK MODE 1 GHz to 25 GHz, ANT H

RE Test case\_FCC 15C 1GHz-25GHz

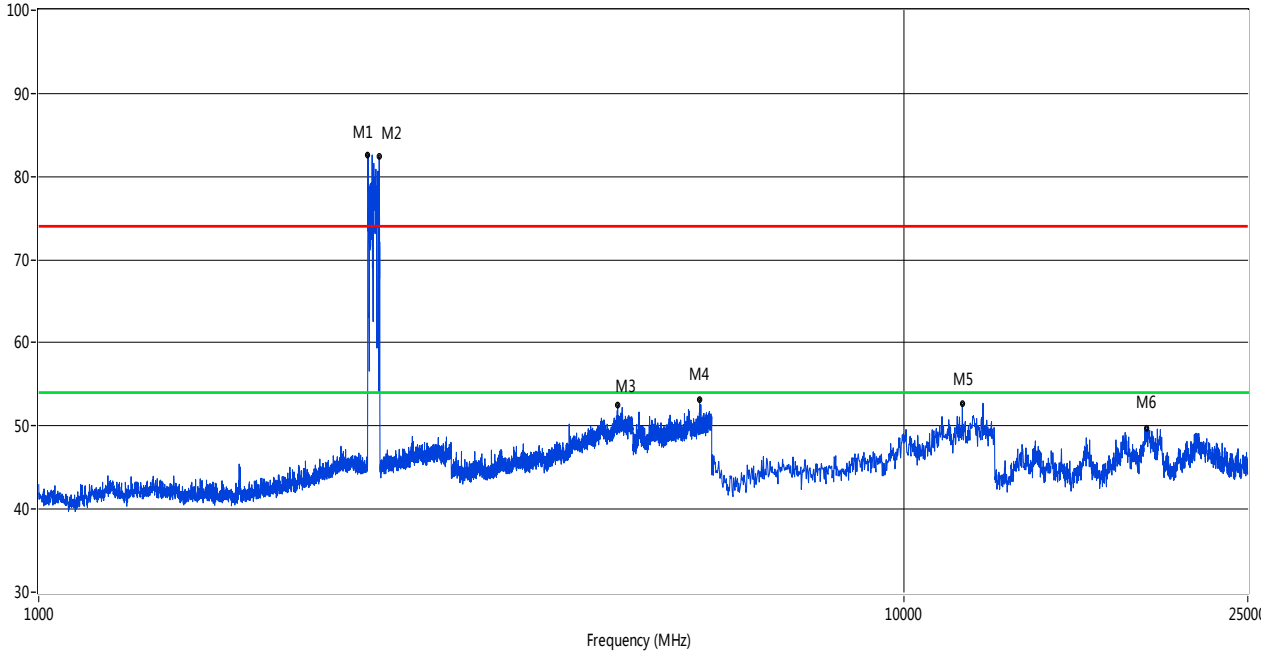

No.	Frequency (MHz)	Results (dBuV/m)	Factor (dB)	Limit (dBuV/m)	Margin (dB)	Detector	Table (o)	Height (cm)	ANT	Verdict
1	2403.15	82.61	-0.20	74.0	-8.61	Peak	300.00	100	Horizontal	N/A
2	2476.13	82.37	-0.55	74.0	-8.37	Peak	37.00	100	Horizontal	N/A
3	4670.58	52.45	13.09	74.0	21.55	Peak	121.00	100	Horizontal	Pass
4	5809.55	53.14	15.49	74.0	20.86	Peak	46.00	100	Horizontal	Pass
5	11694.26	52.60	20.51	74.0	21.40	Peak	42.00	100	Horizontal	Pass
6	19109.82	49.64	13.79	74.0	24.36	Peak	301.00	100	Horizontal	Pass

Π/4-DQPSK MODE 1 GHz to 25 GHz, ANT V

RE Test case\_FCC 15C 1GHz-25GHz

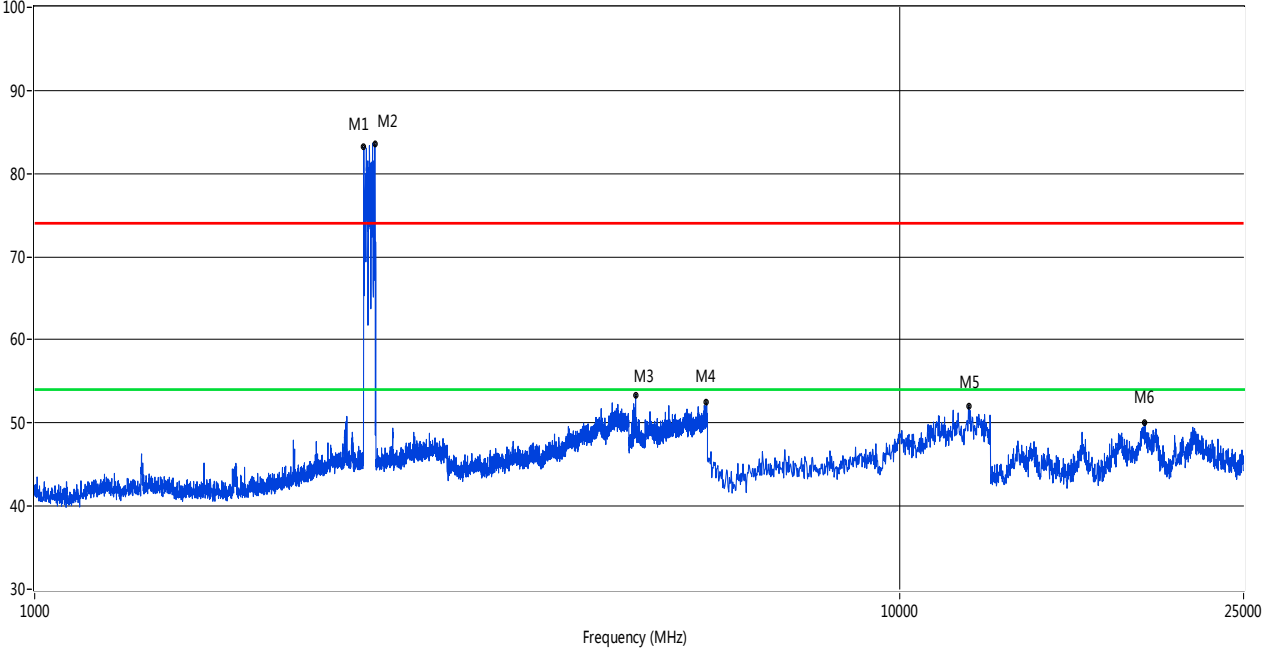

No.	Frequency (MHz)	Results (dBuV/m)	Factor (dB)	Limit (dBuV/m)	Margin (dB)	Detector	Table (o)	Height (cm)	ANT	Verdict
1	2403.15	83.19	-0.20	74.0	-9.19	Peak	195.00	100	Vertical	N/A
2	2474.13	83.58	-0.49	74.0	-9.58	Peak	217.00	100	Vertical	N/A
3	4954.01	53.36	14.09	74.0	20.64	Peak	271.00	100	Vertical	Pass
4	5982.75	52.45	15.82	74.0	21.55	Peak	356.00	100	Vertical	Pass
5	12019.97	52.09	20.86	74.0	21.91	Peak	131.00	100	Vertical	Pass
6	19189.68	49.97	14.08	74.0	24.03	Peak	22.00	100	Vertical	Pass

□/4-DQPSK MODE 1 GHz to 25 GHz, ANT H

RE Test case\_FCC 15C 1GHz-25GHz

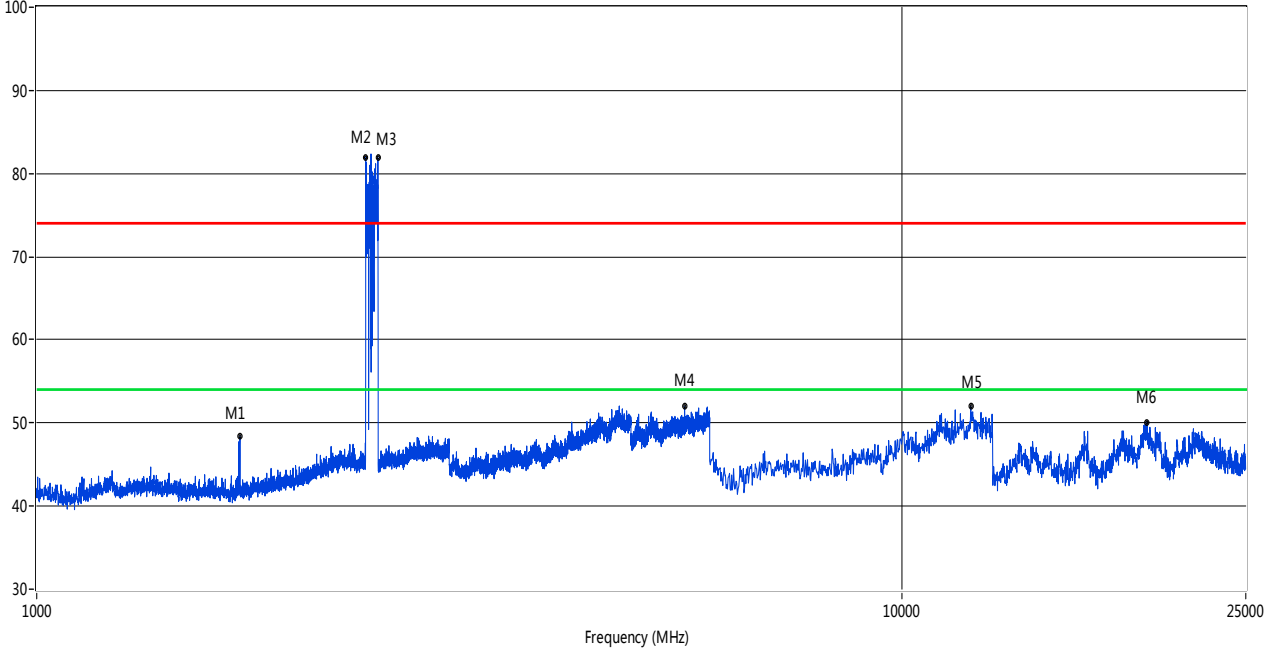

No.	Frequency (MHz)	Results (dBuV/m)	Factor (dB)	Limit (dBuV/m)	Margin (dB)	Detector	Table (o)	Height (cm)	ANT	Verdict
1	1717.82	48.39	-4.02	74.0	25.61	Peak	38.00	100	Horizontal	Pass
2	2401.65	81.95	-0.27	74.0	-7.95	Peak	34.00	100	Horizontal	N/A
3	2480.13	81.88	-0.60	74.0	-7.88	Peak	276.00	100	Horizontal	N/A
4	5613.10	51.97	15.33	74.0	22.03	Peak	109.00	100	Horizontal	Pass
5	12019.97	51.96	20.86	74.0	22.04	Peak	291.00	100	Horizontal	Pass
6	19189.68	50.02	14.08	74.0	23.98	Peak	313.00	100	Horizontal	Pass

8-DPSK MODE 1 GHz to 25 GHz, ANT V

RE Test case\_FCC 15C 1GHz-25GHz

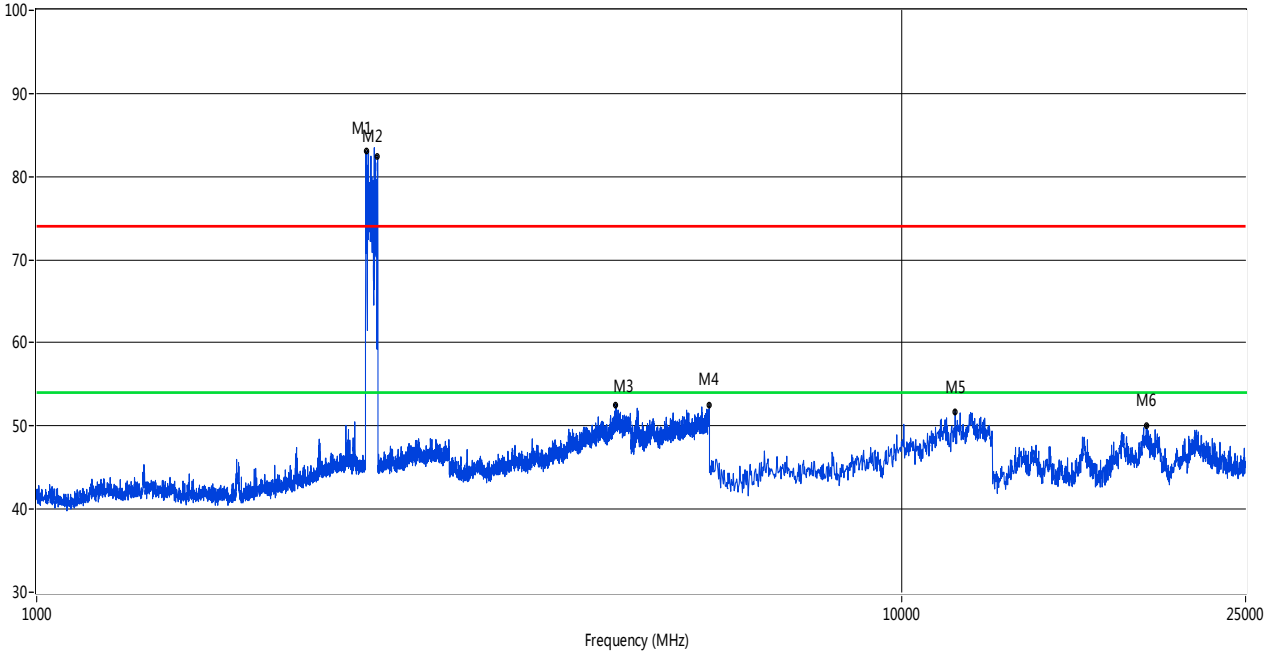

No.	Frequency (MHz)	Results (dBuV/m)	Factor (dB)	Limit (dBuV/m)	Margin (dB)	Detector	Table (o)	Height (cm)	ANT	Verdict
1	2408.15	82.99	-0.15	74.0	-8.99	Peak	261.00	100	Vertical	N/A
2	2479.63	82.39	-0.63	74.0	-8.39	Peak	164.00	100	Vertical	N/A
3	4677.33	52.57	13.13	74.0	21.43	Peak	4.00	100	Vertical	Pass
4	5995.50	52.53	15.74	74.0	21.47	Peak	167.00	100	Vertical	Pass
5	11537.02	51.77	20.17	74.0	22.23	Peak	282.00	100	Vertical	Pass
6	19189.68	49.97	14.08	74.0	24.03	Peak	351.00	100	Vertical	Pass

8-DPSK MODE 1 GHz to 25 GHz, ANT H

RE Test case\_FCC 15C 1GHz-25GHz

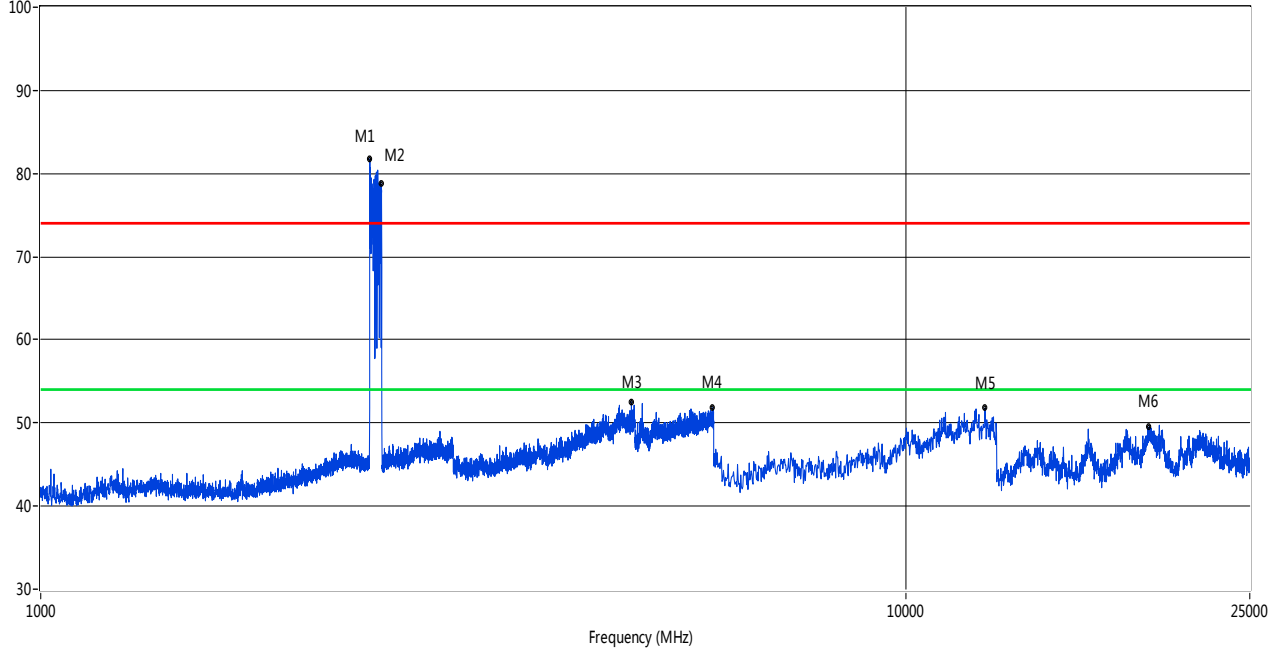

No.	Frequency (MHz)	Results (dBuV/m)	Factor (dB)	Limit (dBuV/m)	Margin (dB)	Detector	Table (o)	Height (cm)	ANT	Verdict
1	2402.15	81.76	-0.34	74.0	-7.76	Peak	127.00	100	Horizontal	N/A
2	2477.13	78.73	-0.64	74.0	-4.73	Peak	219.00	100	Horizontal	N/A
3	4820.55	52.52	13.83	74.0	21.48	Peak	81.00	100	Horizontal	Pass
4	5982.75	51.82	15.82	74.0	22.18	Peak	94.00	100	Horizontal	Pass
5	12356.91	51.79	20.64	74.0	22.21	Peak	318.00	100	Horizontal	Pass
6	19119.80	49.55	13.82	74.0	24.45	Peak	87.00	100	Horizontal	Pass

## A.9 Band Edge

### Test Data

Note 1: The lowest and highest channels are tested to verify the band edge emissions. Please refer to the following the plots for emissions values.

Note 2: The test data all are tested in the vertical and horizontal antenna which the trace is max hold. So these plots have shown the worst case.

Note 3: The average levels were calculated from the peak level corrected with duty cycle correction factor (16.54 dB) derived from  $20\log(\text{dwell time}/100 \text{ ms})$ .

For example: Average level = 57.32 dBuV/m - 16.54 (dB) = 40.78 dBuV/m.

Test Mode	Test Channel	Frequency (MHz)	Level (dBuV/m)	Limit Line (dBuV/m)	Margin (dB)	Remark	Verdict
GFSK	Low	2390.00	57.32	74	16.68	PEAK	Pass
		2390.00	40.78	54	13.22	AVERAGE	Pass
GFSK	HIGH	2483.50	63.77	74	10.23	PEAK	Pass
		2483.50	47.23	54	6.77	AVERAGE	Pass
π/4DQPSK	Low	2390.00	55.51	74	18.49	PEAK	Pass
		2390.00	38.97	54	15.03	AVERAGE	Pass
π/4DQPSK	HIGH	2483.50	60.73	74	13.27	PEAK	Pass
		2483.50	44.19	54	9.81	AVERAGE	Pass
8-DPSK	Low	2390.00	54.86	74	19.14	PEAK	Pass
		2390.00	38.32	54	15.68	AVERAGE	Pass
8-DPSK	HIGH	2483.50	62.40	74	11.60	PEAK	Pass
		2483.50	45.86	54	8.14	AVERAGE	Pass
GFSK(Hopping)	Low	2390.00	56.15	74	17.85	PEAK	Pass
		2390.00	39.61	54	14.39	AVERAGE	Pass
GFSK(Hopping)	HIGH	2483.50	55.45	74	18.55	PEAK	Pass
		2483.50	38.91	54	15.09	AVERAGE	Pass
π/4DQPSK (Hopping)	Low	2390.00	54.67	74	19.33	PEAK	Pass
		2390.00	38.13	54	15.87	AVERAGE	Pass
π/4DQPSK (Hopping)	HIGH	2483.50	55.44	74	18.56	PEAK	Pass
		2483.50	38.9	54	15.10	AVERAGE	Pass
8-DPSK (Hopping)	Low	2390.00	54.22	74	19.78	PEAK	Pass
		2390.00	37.68	54	16.32	AVERAGE	Pass
8-DPSK (Hopping)	HIGH	2483.50	54.56	74	19.44	PEAK	Pass
		2483.50	38.02	54	15.98	AVERAGE	Pass

## Test Plots

## GFSK LOW CHANNEL , PEAK

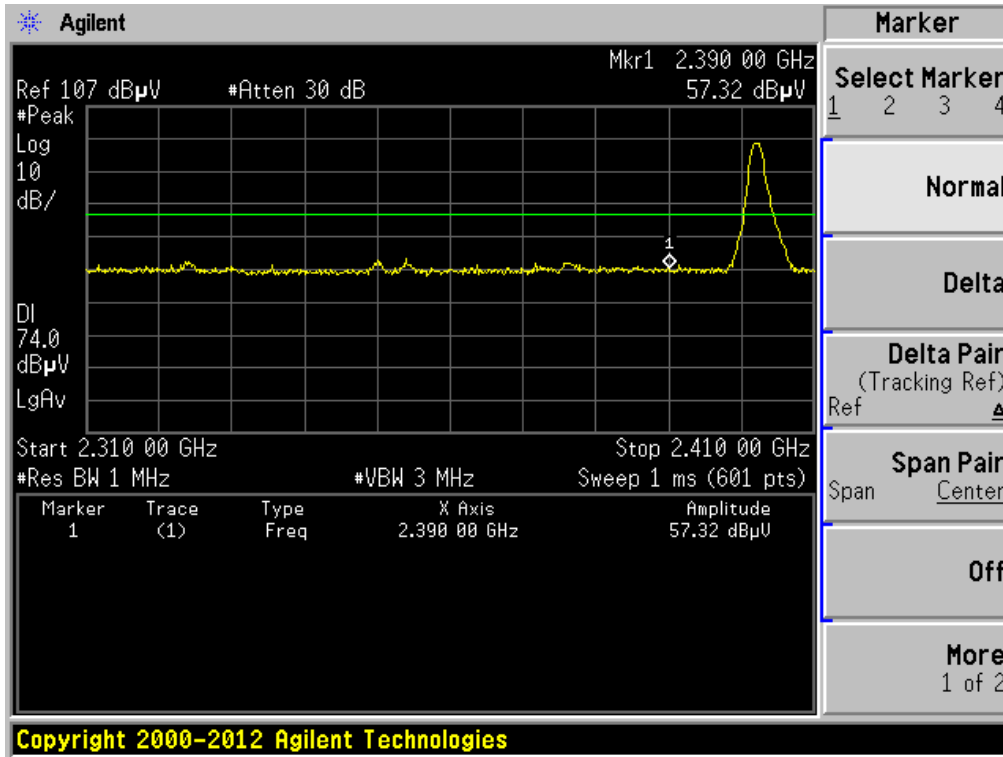

## GFSK HIGH CHANNEL , PEAK

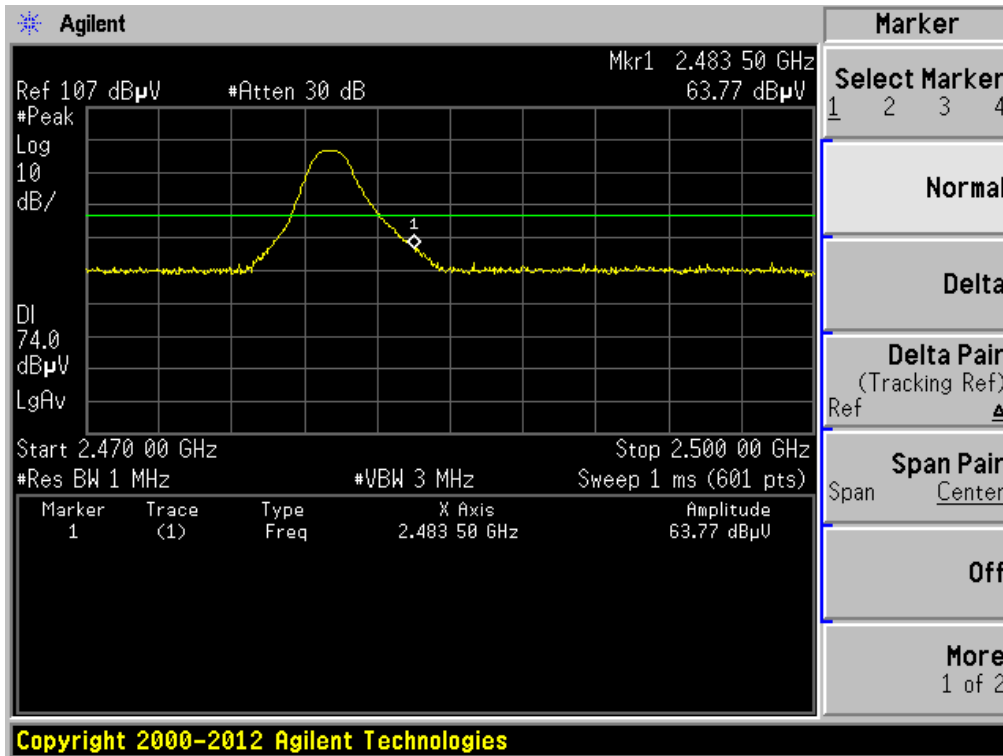

## □/4-DQPSK LOW CHANNEL , PEAK

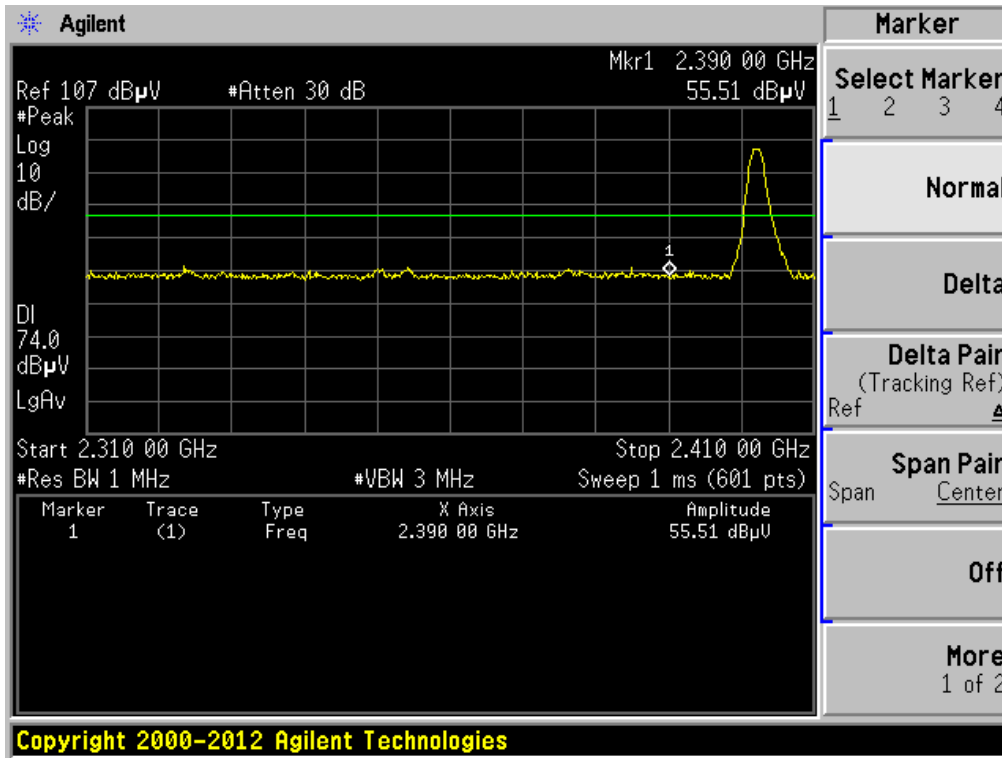

## □/4-DQPSK HIGH CHANNEL , PEAK

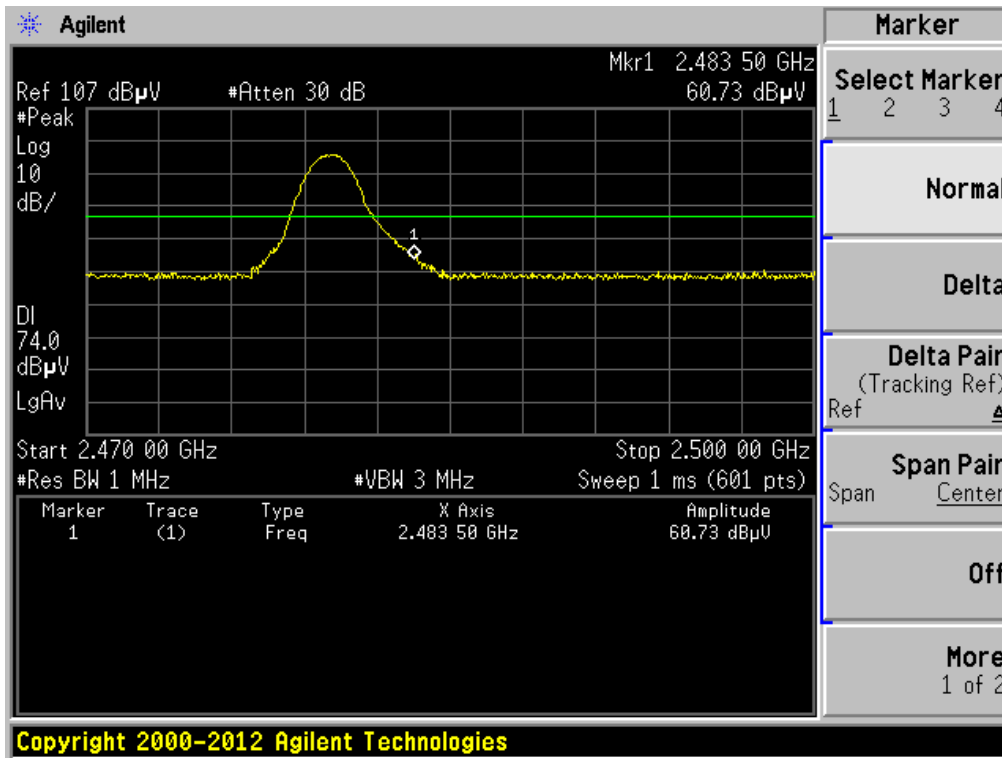



## 8-DPSK LOW CHANNEL , PEAK

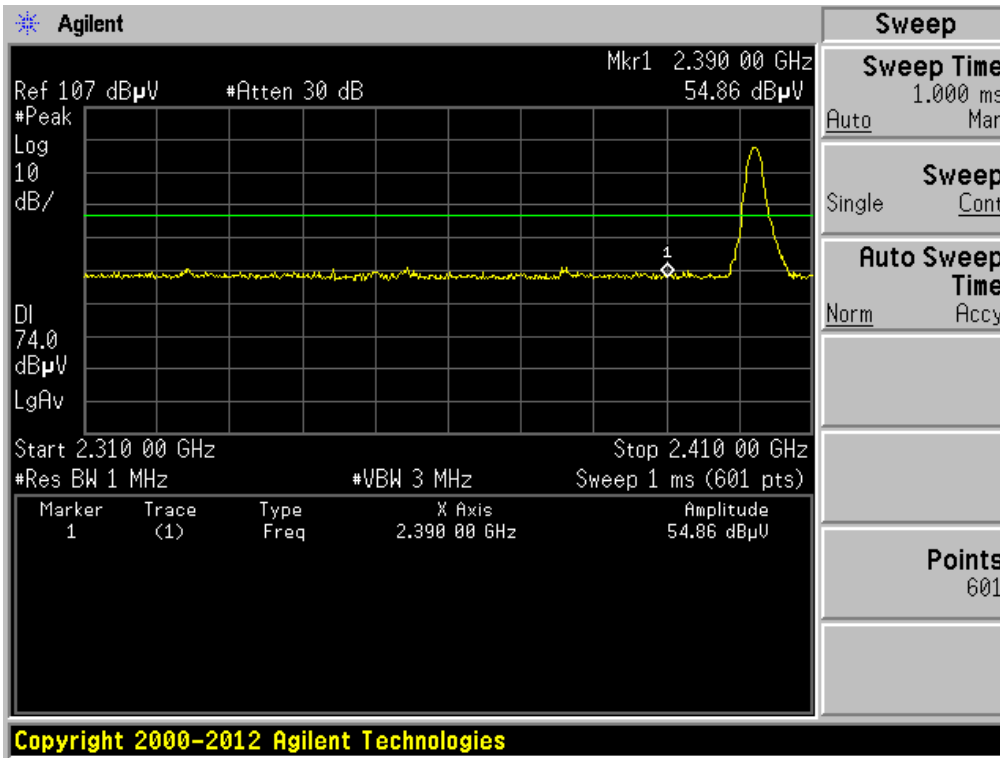

## 8-DPSK HIGH CHANNEL , PEAK

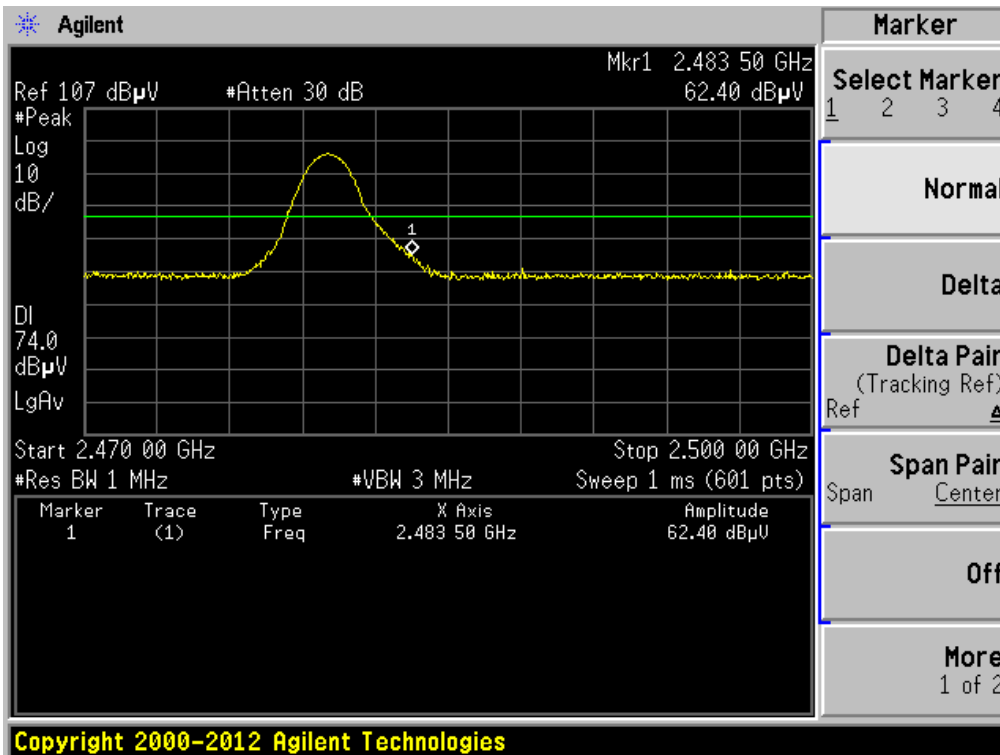

Hopping Mode:

## GFSK LOW FREQUENCY BAND, PEAK

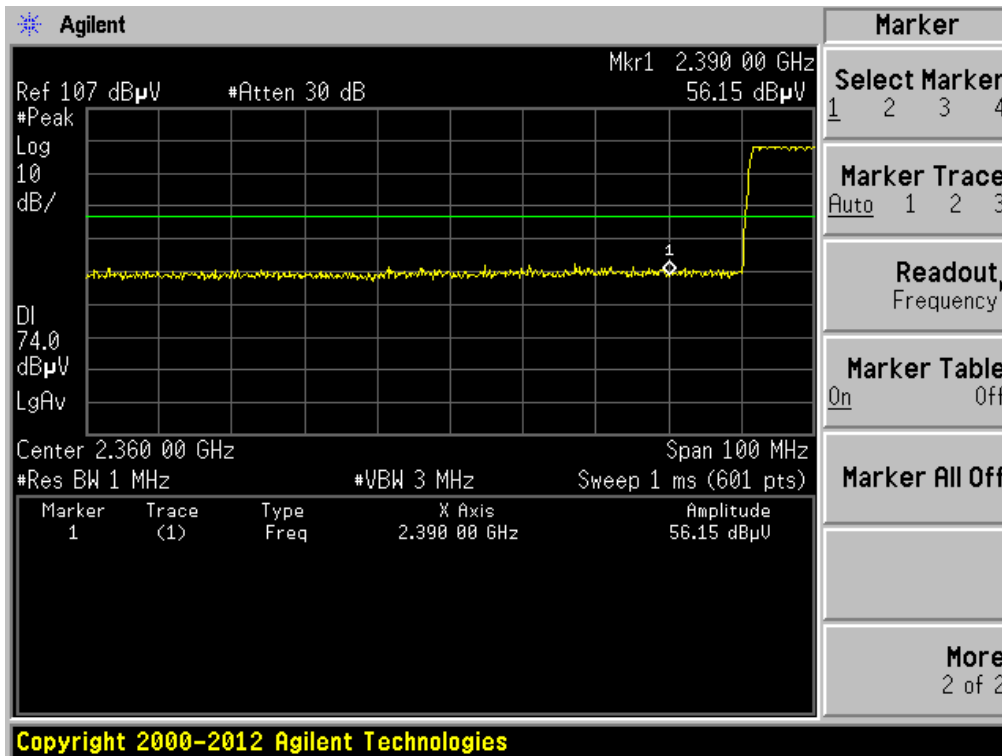

## GFSK HIGH FREQUENCY BAND, PEAK

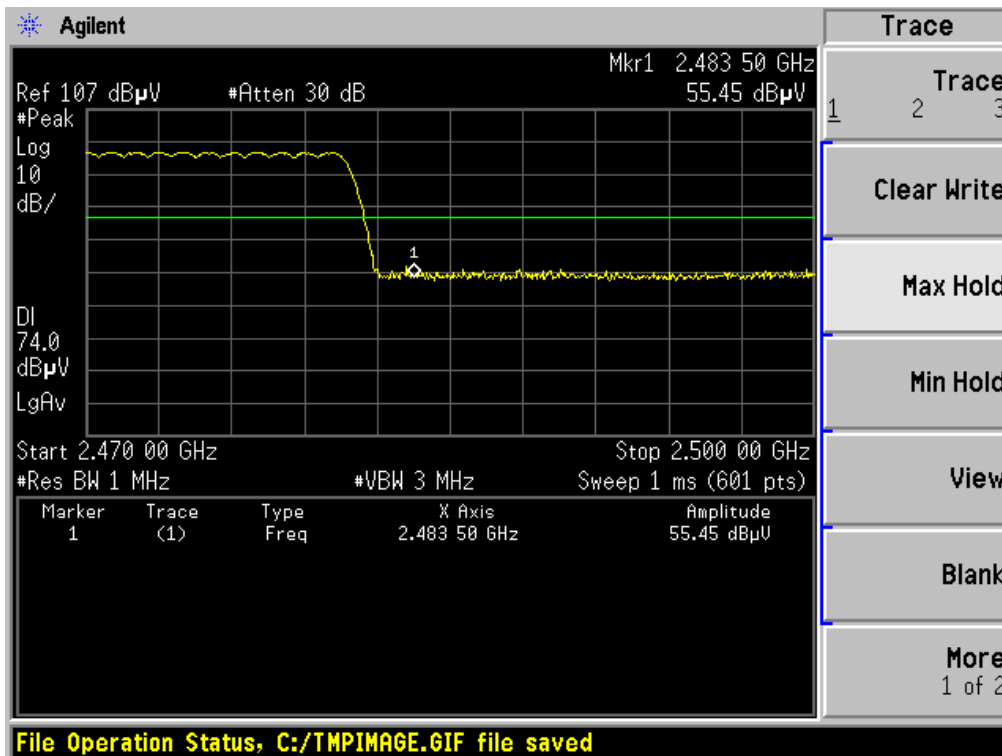

## □/4-DQPSK LOW FREQUENCY BAND, PEAK

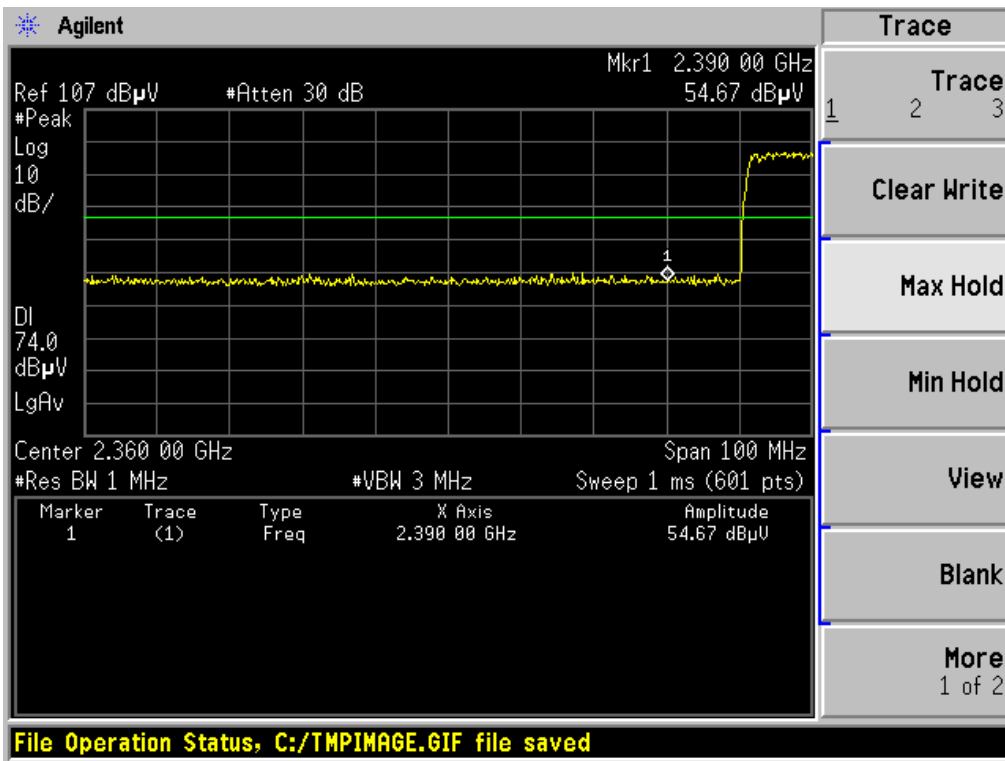

## □/4-DQPSK HIGH FREQUENCY BAND, PEAK

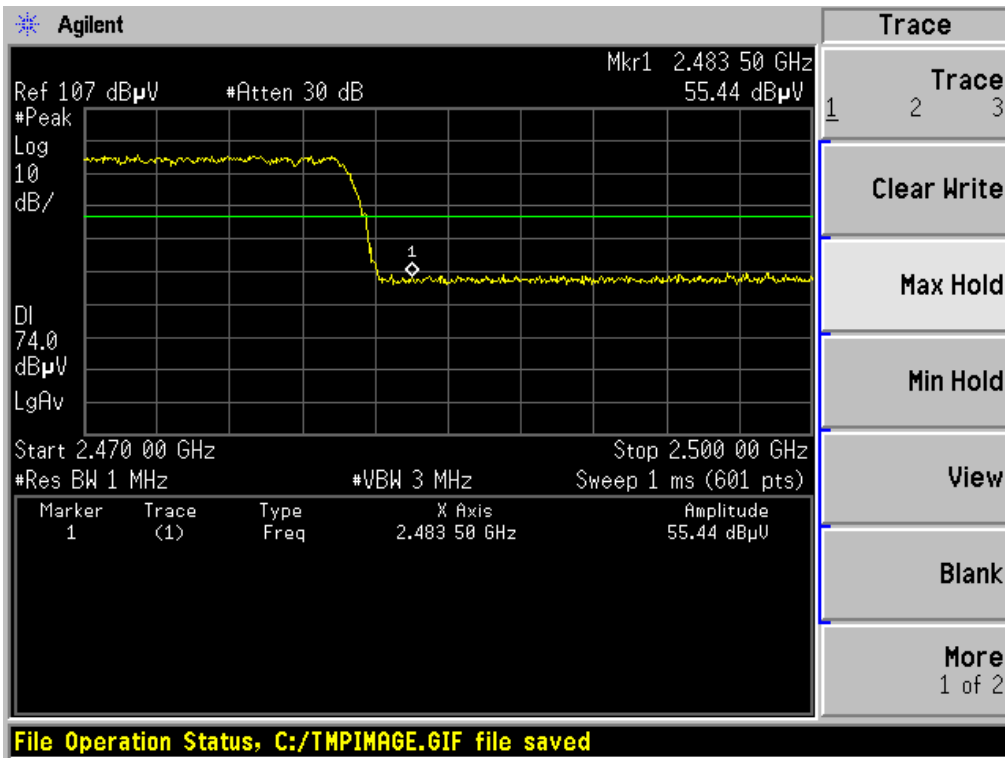

## 8-DPSK LOW FREQUENCY BAND, PEAK

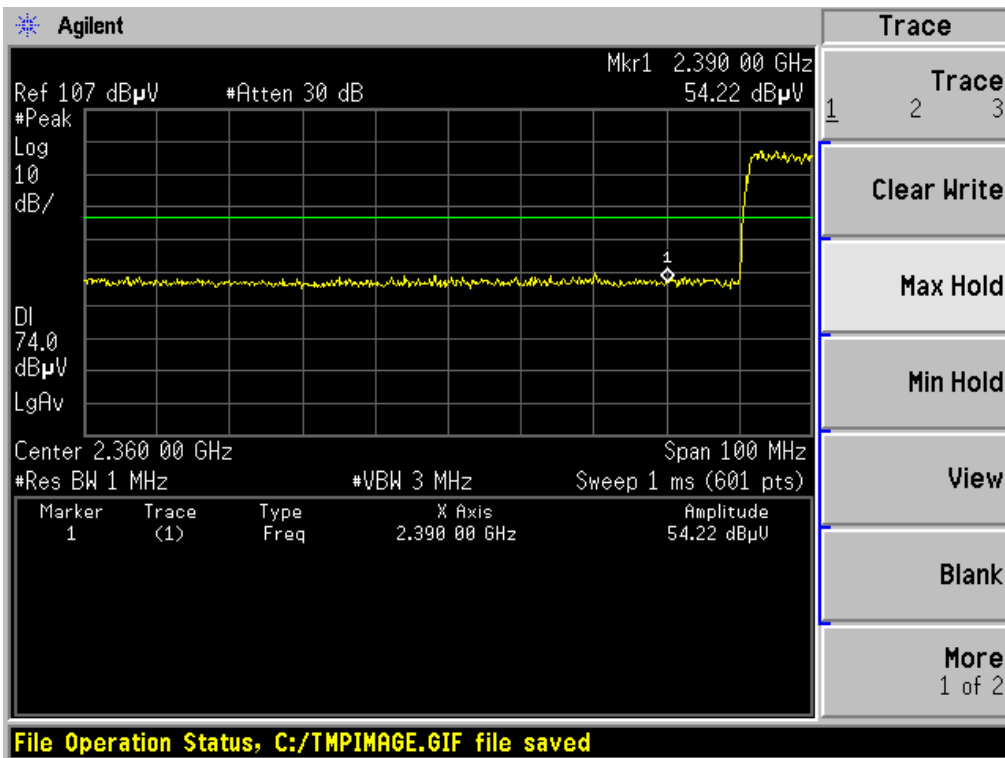

## 8-DPSK HIGH FREQUENCY BAND, PEAK

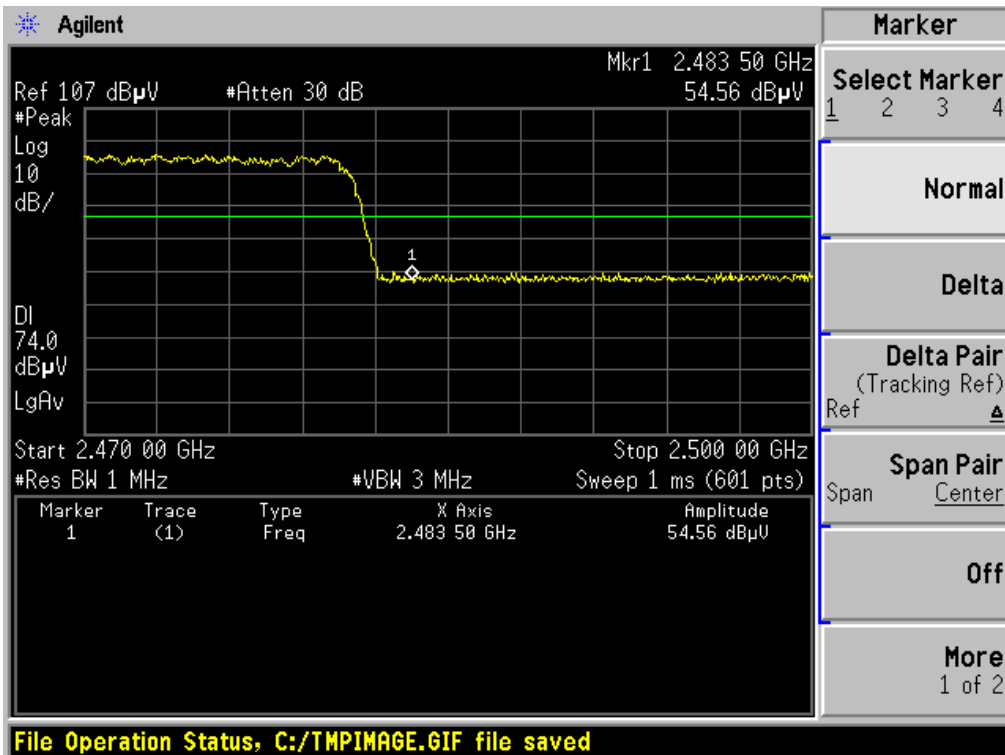

## ANNEX B TEST SETUP PHOTOS

Please refer the document “ANNEX B TEST SETUP PHOTOS”.

## ANNEX C EUT EXTERNAL PHOTOS

Please refer the document “ANNEX C EUT EXTERNAL PHOTOS”.

## ANNEX D EUT INTERNAL PHOTOS

Please refer the document “ANNEX D EUT INTERNAL PHOTOS”.

--END OF REPORT--