



RF TEST REPORT

Applicant Shanghai Xiaoyi Technology Co., Ltd.
FCC ID 2AFIB-YY3218
Product Kami Indoor Camera
Brand Kami
Model YYS.3218
Report No. R1806A0311-R2V1
Issue Date March 5, 2019

TA Technology (Shanghai) Co., Ltd. tested the above equipment in accordance with the requirements in **FCC CFR47 Part 15E (2018)**. The test results show that the equipment tested is capable of demonstrating compliance with the requirements as documented in this report.

Performed by: Peng Tao

Approved by: Kai Xu

TA Technology (Shanghai) Co., Ltd.

No.145, Jintang Rd, Tangzhen Industry Park, Pudong Shanghai, China

TEL: +86-021-50791141/2/3

FAX: +86-021-50791141/2/3-8000



TABLE OF CONTENT

1. Test Laboratory	4
1.1. Notes of the test report.....	4
1.2. Test facility	4
1.3. Testing Location.....	5
2. General Description of Equipment under Test.....	6
3. Applied Standards	7
4. Test Configuration	8
5. Test Case Results	10
5.1. Occupied Bandwidth	10
5.2. Average Power Output –Conducted.....	21
5.3. Frequency Stability.....	25
5.4. Power Spectral Density	28
5.5. Unwanted Emission	38
5.6. Conducted Emission	84
6. Main Test Instruments.....	86
ANNEX A: EUT Appearance and Test Setup	87
A.1 EUT Appearance	87
A.2 Test Setup	89



Summary of measurement results

Number	Summary of measurements of results	Clause in FCC rules	Verdict
1	Average conducted output power	15.407(a)	PASS
2	Occupied bandwidth	15.407(e)	PASS
3	Frequency stability	15.407(g)	PASS
4	Maximum power spectral density	15.407(a)	PASS
5	Unwanted Emissions	15.407(b)	PASS
6	Conducted Emissions	15.207	PASS
Date of Testing: July 26, 2018~ August 13, 2018			

1. Test Laboratory

1.1. Notes of the test report

This report shall not be reproduced in full or partial, without the written approval of **TA technology (shanghai) co., Ltd.** The results documented in this report apply only to the tested sample, under the conditions and modes of operation as described herein. Measurement Uncertainties were not taken into account and are published for informational purposes only. This report is written to support regulatory compliance of the applicable standards stated above.

1.2. Test facility

CNAS (accreditation number: L2264)

TA Technology (Shanghai) Co., Ltd. has obtained the accreditation of China National Accreditation Service for Conformity Assessment (CNAS).

FCC (Designation number: CN1179, Test Firm Registration Number: 446626)

TA Technology (Shanghai) Co., Ltd. has been listed on the US Federal Communications Commission list of test facilities recognized to perform electromagnetic emissions measurements.

IC (recognition number is 8510A)

TA Technology (Shanghai) Co., Ltd. has been listed by industry Canada to perform electromagnetic emission measurement.

VCCI (recognition number is C-4595, T-2154, R-4113, G-10766)

TA Technology (Shanghai) Co., Ltd. has been listed by industry Japan to perform electromagnetic emission measurement.

A2LA (Certificate Number: 3857.01)

TA Technology (Shanghai) Co., Ltd. has been listed by American Association for Laboratory Accreditation to perform electromagnetic emission measurement.



1.3. Testing Location

Company: TA Technology (Shanghai) Co., Ltd.
Address: No.145, Jintang Rd, Tangzhen Industry Park, Pudong
City: Shanghai
Post code: 201201
Country: P. R. China
Contact: Xu Kai
Telephone: +86-021-50791141/2/3
Fax: +86-021-50791141/2/3-8000
Website: <http://www.ta-shanghai.com>
E-mail: xukai@ta-shanghai.com

2. General Description of Equipment under Test

Client Information

Applicant	Shanghai Xiaoyi Technology Co., Ltd.
Applicant address	16F, Building 1 , No. 515, Huanke Road, Shanghai, China
Manufacturer	Shanghai Xiaoyi Technology Co., Ltd.
Manufacturer address	16F, Building 1 , No. 515, Huanke Road, Shanghai, China

General information

EUT Description	
Model	YYS.3218
IMEI	/
Hardware Version	1.0
Software Version	Ver1.0
Power Supply	AC adapter
Antenna Type	Internal Antenna
Antenna Gain	5100MHz:2.86 dBi 5300MHz:2.80 dBi 5700MHz:2.60 dBi 5900MHz:2.19 dBi
additional beamforming gain	NA
Test Mode(s)	U-NII-1(5150MHz-5250MHz) U-NII-3(5725MHz-5850MHz)
Modulation Type	802.11a/n (HT20/HT40) : OFDM 802.11ac (VHT20/VHT40/VHT80): OFDM
Max. Conducted Power	11.95 dBm
Operating Frequency Range(s)	U-NII-1: 5150-5250MHz U-NII-3: 5725-5850MHz
Operating temperature range:	0 ° C to 40° C
Operating voltage range:	4.5V to 5.5 V
State AC voltage:	5.0V
EUT Accessory	
Adapter	Manufacturer: DONGGUAN AOHAI POWER TECHNOLOGY CO., LTD. Model: A8-501000
Note: The information of the EUT is declared by the manufacturer.	



3. Applied Standards

According to the specifications of the manufacturer, it must comply with the requirements of the following standards:

FCC CFR47 Part 15E (2018) Unlicensed National Information Infrastructure Devices

ANSI C63.10 (2013)

KDB 789033 D02 General UNII Test Procedures New Rules v02r01

4. Test Configuration

Test Mode

The EUT has been associated with peripherals and configuration operated in a manner tended to maximize its emission characteristics in a typical application.

The radiated emission was measured in the following position: EUT stand-up position (Z axis), lie-down position (X, Y axis). The worst emission was found in stand-up position (Z axis) and the worst case was recorded.

In order to find the worst case condition, Pre-tests are needed at the presence of different data rate. Preliminary tests have been done on all the configuration for confirming worst case. Data rate below means worst-case rate of each test item.

Worst-case data rates are shown as following table.

Band	Data Rate
802.11a	6 Mbps
802.11n HT20	MCS0
802.11n HT40	MCS0
802.11ac VHT20	MCS0
802.11ac VHT40	MCS0
802.11ac VHT80	MCS0



Wireless Technology and Frequency Range

Wireless Technology		Bandwidth	Channel	Frequency
Wi-Fi	U-NII-1	20 MHz	36	5180MHz
			40	5200MHz
			44	5220MHz
			48	5240MHz
		40 MHz	38	5190MHz
			46	5230MHz
	U-NII-3	20 MHz	42	5210MHz
			149	5745MHz
			153	5765MHz
			157	5785MHz
			161	5805MHz
			165	5825MHz
		40 MHz	151	5755MHz
			159	5795MHz
80 MHz	155	5775MHz		
Does this device support TPC Function? <input type="checkbox"/> Yes <input checked="" type="checkbox"/> No				
Does this device support TDWR Band? <input type="checkbox"/> Yes <input checked="" type="checkbox"/> No				

5. Test Case Results

5.1. Occupied Bandwidth

Ambient condition

Temperature	Relative humidity	Pressure
23°C ~25°C	45%~50%	101.5kPa

Method of Measurement

The EUT was connected to the spectrum analyzer through an external attenuator (20dB) and a known loss cable.

For U-NII-1/U-NII-2A/U-NII-2C, set RBW \approx 1% OCB kHz, VBW \geq 3 \times RBW, measure the maximum width of the emission that is constrained by the frequencies associated with the two outermost amplitude points (upper and lower frequencies) that are attenuated by 26 dB relative to the maximum level measured in the fundamental emission.

For U-NII-3, Set RBW = 100 kHz, VBW \geq 3 \times RBW, measure the maximum width of the emission that is constrained by the frequencies associated with the two outermost amplitude points (upper and lower frequencies) that are attenuated by 6 dB relative to the maximum level measured in the fundamental emission.

Note: The automatic bandwidth measurement capability of a spectrum analyzer or EMI receiver may be employed if it implements the functionality described above.

Use the 99 % power bandwidth function of the instrument

Test Setup

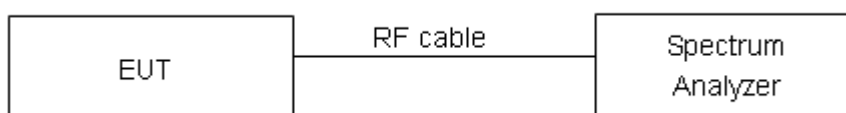

Limits

Rule FCC Part §15.407(e)

Within the 5.725-5.85 GHz band, the minimum 6 dB bandwidth of U-NII devices shall be at least 500 kHz.

Measurement Uncertainty

The assessed measurement uncertainty to ensure 95% confidence level for the normal distribution is with the coverage factor $k = 2$, $U = 936$ Hz.

**Test Results:****U-NII-1**

Network Standards	Carrier frequency (MHz)	99% bandwidth (MHz)	Minimum 26 dB bandwidth (MHz)	Conclusion
802.11a	5180	16.522	20.10	PASS
	5200	16.458	19.83	PASS
	5240	16.441	19.92	PASS
802.11n HT20	5180	17.497	20.00	PASS
	5200	17.512	19.94	PASS
	5240	17.499	19.95	PASS
802.11n HT40	5190	35.920	40.16	PASS
	5230	35.846	40.04	PASS
802.11ac VHT20	5180	17.511	19.68	PASS
	5200	17.497	19.87	PASS
	5240	17.499	20.00	PASS
802.11ac VHT40	5190	35.915	39.99	PASS
	5230	35.868	39.98	PASS
802.11ac VHT80	5210	75.464	81.47	PASS

U-NII-3

Network Standards	Carrier frequency (MHz)	99% bandwidth (MHz)	Minimum 6 dB bandwidth (MHz)	Limit (kHz)	Conclusion
802.11a	5745	16.490	16.33	500	PASS
	5785	16.504	16.42	500	PASS
	5825	16.485	16.33	500	PASS
802.11n HT20	5745	17.671	17.34	500	PASS
	5785	17.625	17.25	500	PASS
	5825	17.614	17.07	500	PASS
802.11n HT40	5755	36.154	35.72	500	PASS
	5795	36.184	36.11	500	PASS
802.11ac VHT20	5745	16.673	16.32	500	PASS
	5785	16.593	16.35	500	PASS
	5825	16.614	16.35	500	PASS
802.11ac VHT40	5755	35.870	35.08	500	PASS
	5795	35.920	35.15	500	PASS
802.11ac VHT80	5775	75.144	75.18	500	PASS

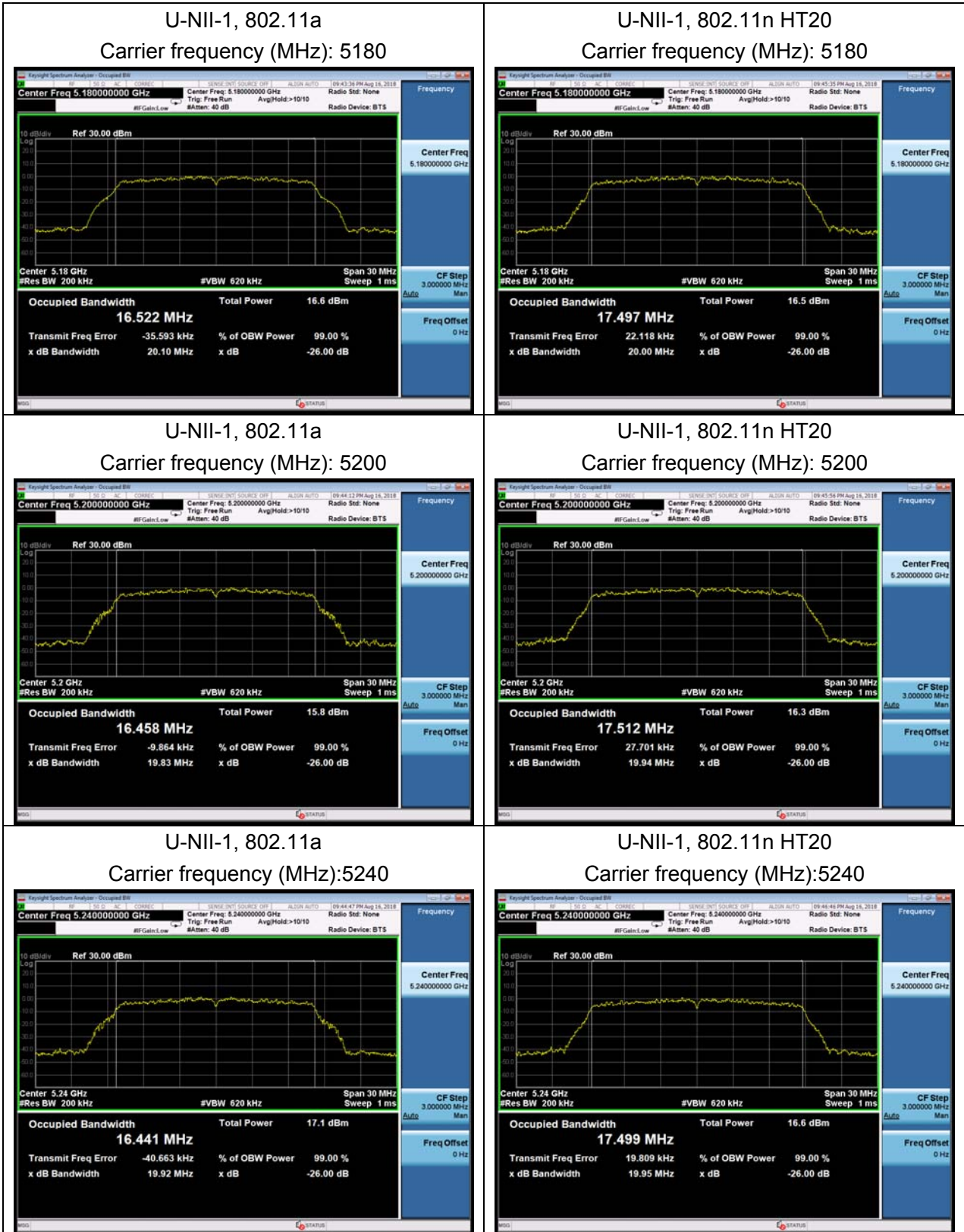

U-NII-1, 802.11n HT40
Carrier frequency (MHz): 5190



U-NII-1, 802.11ac VHT20
Carrier frequency (MHz): 5180



U-NII-1, 802.11n HT40
Carrier frequency (MHz): 5230



U-NII-1, 802.11ac VHT20
Carrier frequency (MHz): 5200



U-NII-1, 802.11ac VHT40
Carrier frequency (MHz): 5190



U-NII-1, 802.11ac VHT20
Carrier frequency (MHz): 5240





U-NII-1, 802.11ac VHT40
Carrier frequency (MHz): 5230

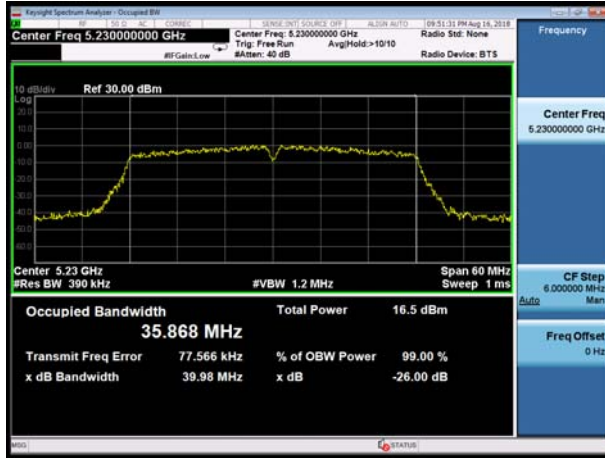

U-NII-1, 802.11ac VHT80
Carrier frequency (MHz): 5210





99% bandwidth

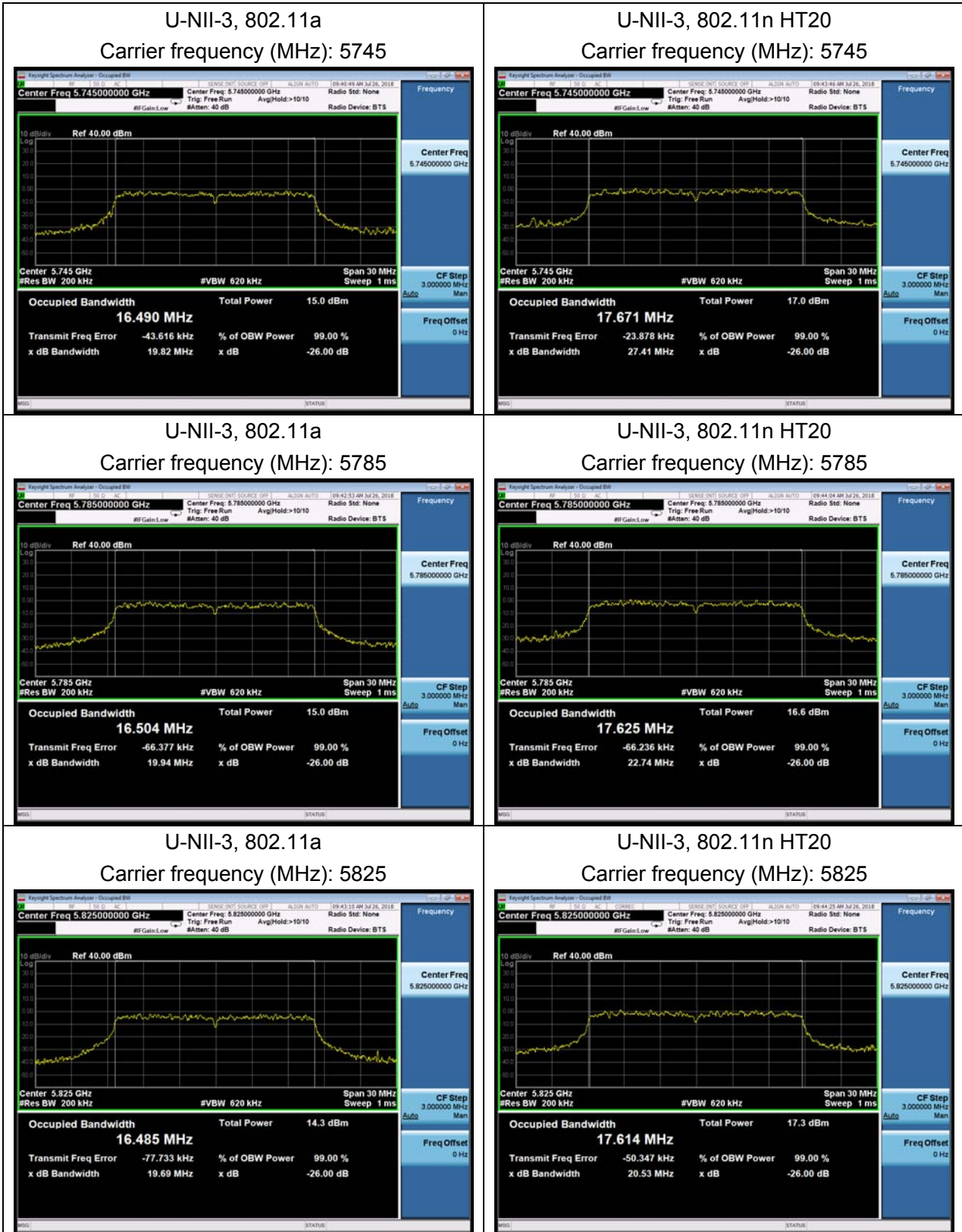

U-NII-3, 802.11n HT40
Carrier frequency (MHz): 5755



U-NII-3, 802.11ac VHT20
Carrier frequency (MHz): 5745



U-NII-3, 802.11n HT40
Carrier frequency (MHz): 5795



U-NII-3, 802.11ac VHT20
Carrier frequency (MHz): 5785



U-NII-3, 802.11ac VHT40
Carrier frequency (MHz): 5755



U-NII-3, 802.11ac VHT20
Carrier frequency (MHz): 5825





U-NII-3, 802.11ac VHT40
Carrier frequency (MHz): 5795



U-NII-3, 802.11ac VHT80
Carrier frequency (MHz): 5775





Minimum 6 dB bandwidth

U-NII-3, 802.11a

Carrier frequency (MHz): 5745



U-NII-3, 802.11n HT20

Carrier frequency (MHz): 5745

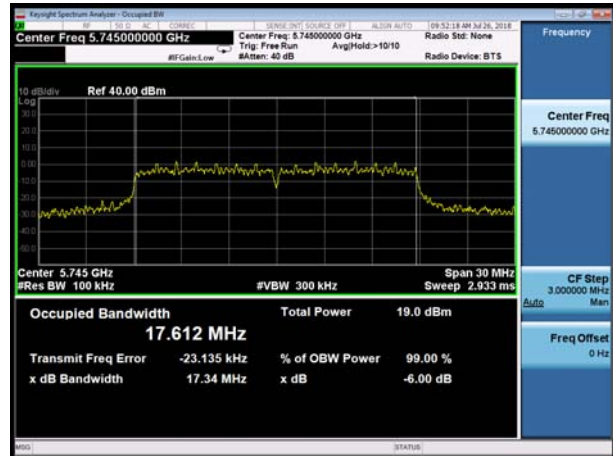

U-NII-3, 802.11a

Carrier frequency (MHz): 5785



U-NII-3, 802.11n HT20

Carrier frequency (MHz): 5785

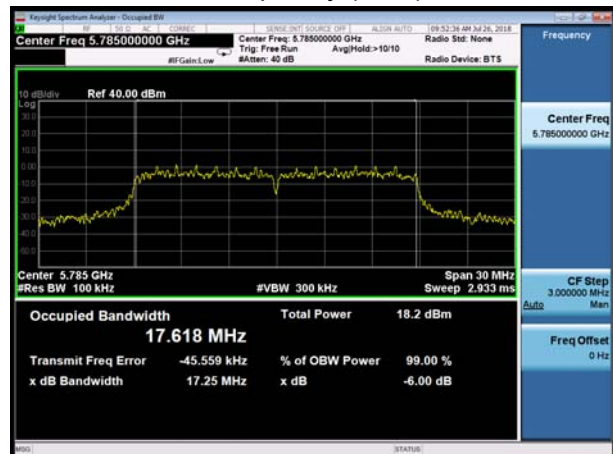

U-NII-3, 802.11a

Carrier frequency (MHz): 5825

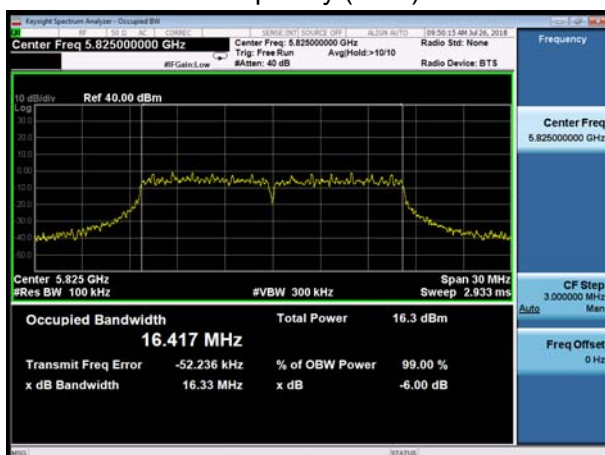

U-NII-3, 802.11n HT20

Carrier frequency (MHz): 5825

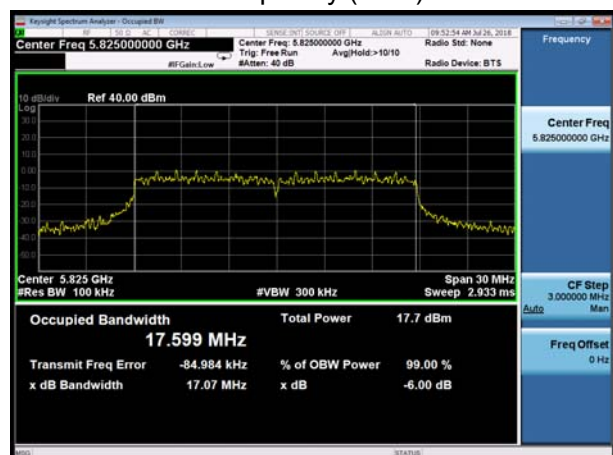

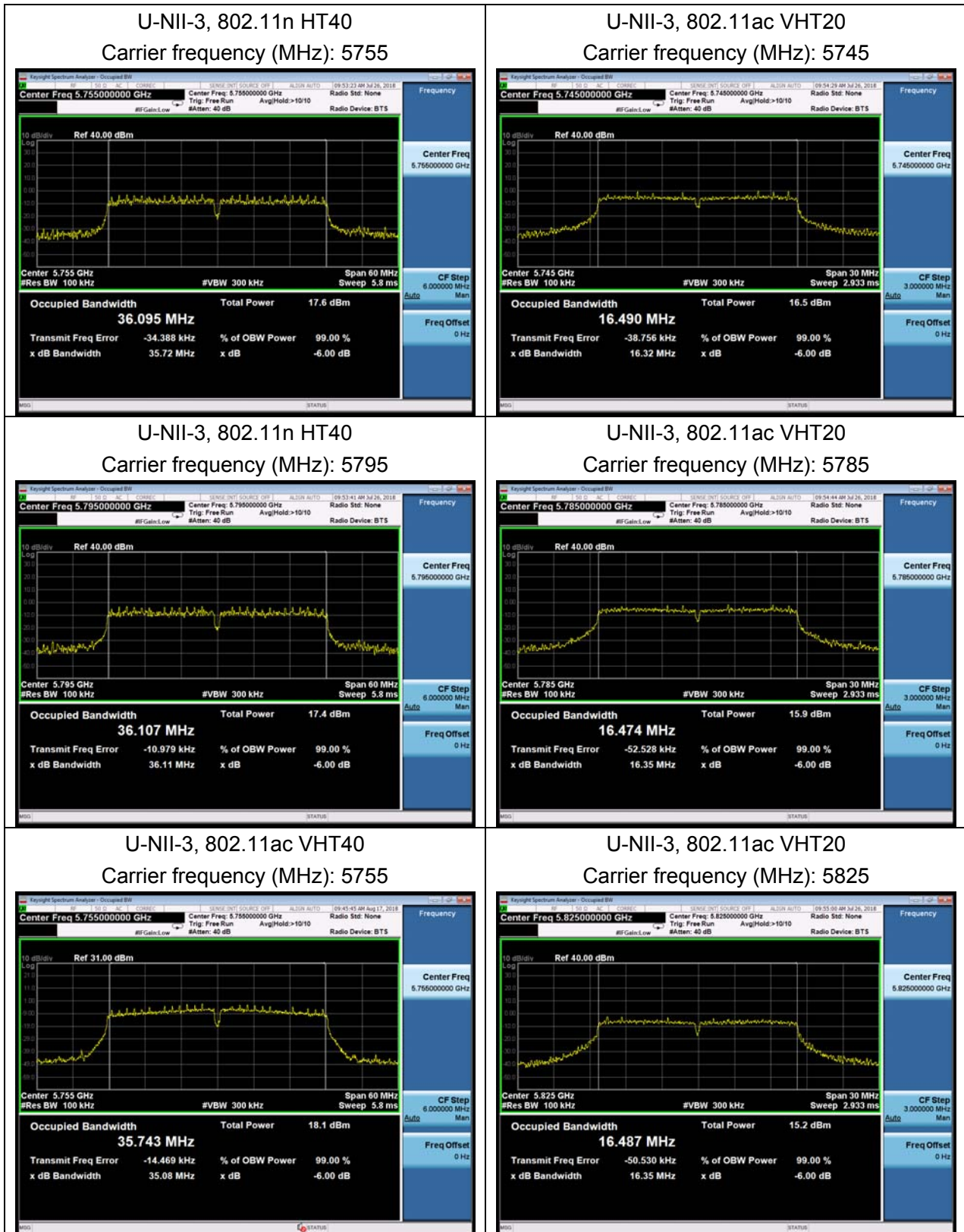



U-NII-3, 802.11ac VHT40
Carrier frequency (MHz): 5795



U-NII-3, 802.11ac VHT80
Carrier frequency (MHz): 5775

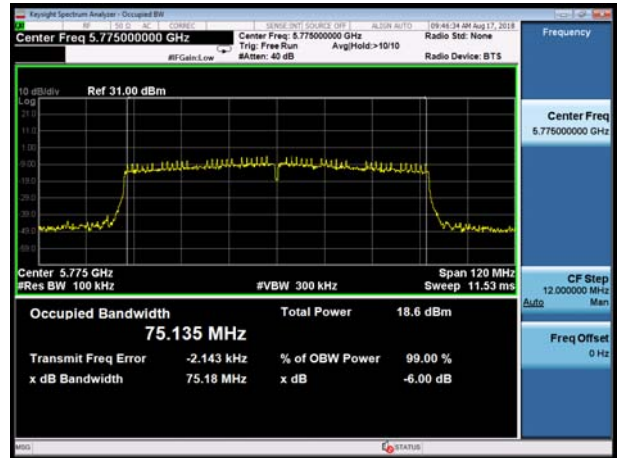

5.2. Average Power Output –Conducted

Ambient condition

Temperature	Relative humidity	Pressure
23°C ~25°C	45%~50%	101.5kPa

Methods of Measurement

During the process of the testing, The EUT was connected to the average power meter through an external attenuator and a known loss cable. The EUT is max power transmission with proper modulation. We use Maximum average Conducted Output Power Level Method in KDB789033 for this test

Test Setup

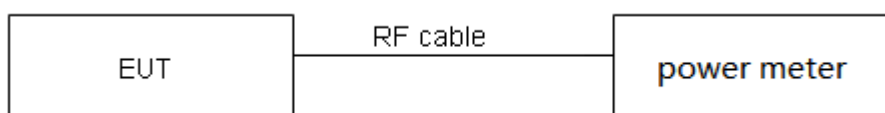

Limits

Rule FCC Part 15.407(a)(1)(2)(3)

For client devices in the 5.15-5.25 GHz band, the maximum conducted output power over the frequency band of operation shall not exceed 250 mW provided the maximum antenna gain does not exceed 6 dBi. In addition, the maximum power spectral density shall not exceed 11 dBm in any 1 megahertz band. If transmitting antennas of directional gain greater than 6 dBi are used, both the maximum conducted output power and the maximum power spectral density shall be reduced by the amount in dB that the directional gain of the antenna exceeds 6 dBi.

For the band 5.725-5.85 GHz, the maximum conducted output power over the frequency band of operation shall not exceed 1 W. In addition, the maximum power spectral density shall not exceed 30 dBm in any 500-kHz band. If transmitting antennas of directional gain greater than 6 dBi are used, both the maximum conducted output power and the maximum power spectral density shall be reduced by the amount in dB that the directional gain of the antenna exceeds 6 dBi.

Measurement Uncertainty

The assessed measurement uncertainty to ensure 95% confidence level for the normal distribution is with the coverage factor $k = 2$, $U = 0.44$ dB.

Test Results

Band	T _{on} (ms)	T _(on+off) (ms)	Duty cycle	Duty cycle correction Factor(dB)
802.11a	0.25	0.39	0.63	2.01
802.11n HT20	0.23	0.29	0.78	1.07
802.11n HT40	0.13	0.24	0.54	2.69
802.11ac VHT20	2.06	2.18	0.95	0.23
802.11ac VHT40	2.06	2.18	0.95	0.23
802.11ac VHT80	2.06	2.22	0.93	0.32

Antenna Power Index						
Packet Type	CH36	CH40	CH48	CH149	CH157	CH165
802.11a	59	59	59	45	45	45
802.11n HT20	62	62	62	48	48	48
802.11ac VHT20	60	59	60	45	45	46
Packet Type	CH38	CH46	CH151	CH159	/	/
802.11n HT40	61	60	45	45	/	/
802.11ac VHT40	60	60	46	46	/	/
Packet Type	CH42	CH155	/	/	/	/
802.11ac VHT80	60	46	/	/	/	/

**Test results****U-NII-1**

Network Standards	Channel/ Frequency (MHz)	Average Power Measured (dBm)	Average Power with duty factor (dBm)	Limit (dBm)	Conclusion
802.11a	36/5180	9.20	11.21	24	PASS
	40/5200	9.33	11.34	24	PASS
	48/5240	9.91	11.92	24	PASS
802.11n HT20	36/5180	10.06	11.13	24	PASS
	40/5200	10.33	11.40	24	PASS
	48/5240	10.88	11.95	24	PASS
802.11n HT40	38/5190	9.00	11.69	24	PASS
	46/5230	9.06	11.75	24	PASS
802.11ac VHT20	36/5180	10.50	10.73	24	PASS
	40/5200	10.01	10.24	24	PASS
	48/5240	10.34	10.57	24	PASS
802.11ac VHT40	38/5190	9.84	10.07	24	PASS
	46/5230	10.32	10.55	24	PASS
802.11ac VHT80	42/5210	10.11	10.43	24	PASS

Note: Average Power with duty factor = Average Power Measured +Duty cycle correction factor



U-NII-3

Network Standards	Channel/ Frequency (MHz)	Average Power Measured (dBm)	Average Power with duty factor (dBm)	Limit (dBm)	Conclusion
802.11a	149/5745	9.22	11.23	30	PASS
	157/5785	9.19	11.20	30	PASS
	165/5825	8.84	10.85	30	PASS
802.11n HT20	149/5745	10.22	11.29	30	PASS
	157/5785	10.18	11.25	30	PASS
	165/5825	9.88	10.95	30	PASS
802.11n HT40	151/5755	8.34	11.03	30	PASS
	159/5795	8.24	10.93	30	PASS
802.11ac VHT20	149/5745	10.14	10.37	30	PASS
	157/5785	10.08	10.31	30	PASS
	165/5825	9.89	10.12	30	PASS
802.11ac VHT40	151/5755	10.15	10.38	30	PASS
	159/5795	9.98	10.21	30	PASS
802.11ac VHT80	155/5775	9.88	10.20	30	PASS

Note: Average Power with duty factor = Average Power Measured +Duty cycle correction factor

5.3. Frequency Stability

Ambient condition

Temperature	Relative humidity	Pressure
23°C ~25°C	45%~50%	101.5kPa

Method of Measurement

1. Frequency stability with respect to ambient temperature

a) Supply the EUT with a nominal ac voltage or install a new or fully charged battery in the EUT. If possible, a dummy load shall be connected to the EUT because an antenna near the metallic walls of an environmental test chamber could affect the output frequency of the EUT. If the EUT is equipped with a permanently attached, adjustable-length antenna, then the EUT shall be placed in the center of the chamber with the antenna adjusted to the shortest length possible. Turn ON the EUT and tune it to one of the number of frequencies shown in 5.6.

b) Couple the unlicensed wireless device output to the measuring instrument by connecting an antenna to the measuring instrument with a suitable length of coaxial cable and placing the measuring antenna near the EUT (e.g., 15 cm away), or by connecting a dummy load to the measuring instrument, through an attenuator if necessary.

c) Adjust the location of the measurement antenna and the controls on the measurement instrument to obtain a suitable signal level (i.e., a level that will not overload the measurement instrument but is strong enough to allow measurement of the operating or fundamental frequency of the EUT).

d) Turn the EUT OFF and place it inside the environmental temperature chamber. For devices that have oscillator heaters, energize only the heater circuit.

e) Set the temperature control on the chamber to the highest specified in the regulatory requirements for the type of device and allow the oscillator heater and the chamber temperature to stabilize.

f) While maintaining a constant temperature inside the environmental chamber, turn the EUT ON and record the operating frequency at startup, and at 2 minutes, 5 minutes, and 10 minutes after the EUT is energized. Four measurements in total are made.

g) Measure the frequency at each of frequencies specified in 5.6.

h) Switch OFF the EUT but do not switch OFF the oscillator heater.

i) Lower the chamber temperature by not more than 10 C, and allow the temperature inside the chamber to stabilize.

j) Repeat step f) through step i) down to the lowest specified temperature.

2. Frequency stability when varying supply voltage

Unless otherwise specified, these tests shall be made at ambient room temperature (+15 C to +25

C). An antenna shall be connected to the antenna output terminals of the EUT if possible. If the EUT is equipped with or uses an adjustable-length antenna, then it shall be fully extended.

a) Supply the EUT with nominal voltage or install a new or fully charged battery in the EUT. Turn ON the EUT and couple its output to a frequency counter or other frequency-measuring instrument.



- b) Tune the EUT to one of the number of frequencies required in 5.6. Adjust the location of the measurement antenna and the controls on the measurement instrument to obtain a suitable signal level (i.e., a level that will not overload the measurement instrument but is strong enough to allow measurement of the operating or fundamental frequency of the EUT).
- c) Measure the frequency at each of the frequencies specified in 5.6.
- d) Repeat the above procedure at 85% and 115% of the nominal supply voltage.

Limit

Manufacturers of U-NII devices are responsible for ensuring frequency stability such that an emission is maintained within the band of operation under all conditions of normal operation as specified in the users manual.

Measurement Uncertainty

The assessed measurement uncertainty to ensure 95% confidence level for the normal distribution is with the coverage factor $k = 2$, $U = 936\text{Hz}$

**Test Results**

Voltage (V)	Temperature (°C)	U-NII-1 Test Results			
		5200MHz			
		1min	2min	5min	10min
5	0	5199.996945	5199.995862	5199.989178	5199.982484
5	5	5200.003200	5199.995208	5199.987818	5199.981983
5	10	5199.999186	5199.986816	5199.984312	5199.981830
5	20	5199.998481	5199.978371	5199.977908	5199.972485
5	25	5199.991306	5199.970963	5199.975607	5199.965973
5	30	5199.985306	5199.960993	5199.971825	5199.963753
5	35	5199.980167	5199.952132	5199.971432	5199.956152
5	40	5199.973027	5199.944188	5199.965702	5199.954438
4.5	20	5199.965283	5199.939348	5199.960082	5199.944635
5.5	20	5199.961978	5199.938839	5199.955044	5199.940406
MHz		-0.038022	-0.061161	-0.044956	-0.059594
PPM		-7.311844	-11.761665	-8.645294	-11.460398

Voltage (V)	Temperature (°C)	U-NII-3 Test Results			
		5785MHz			
		1min	2min	5min	10min
5	0	5785.003339	5785.002952	5784.999930	5784.997462
5	5	5784.999666	5784.992955	5784.995814	5784.990128
5	10	5784.990372	5784.988493	5784.991794	5784.987128
5	20	5784.987737	5784.982533	5784.990088	5784.981020
5	25	5784.980384	5784.981838	5784.984587	5784.979059
5	30	5784.974483	5784.980889	5784.982639	5784.978815
5	35	5784.967278	5784.975514	5784.978073	5784.969015
5	40	5784.961768	5784.970635	5784.971772	5784.963316
4.5	20	5784.960586	5784.962602	5784.968404	5784.962503
5.5	20	5784.959788	5784.954260	5784.960535	5784.960978
MHz		-0.040212	-0.045740	-0.039465	-0.039022
PPM		-6.951014	-7.906651	-6.821890	-6.745349

5.4. Power Spectral Density

Ambient condition

Temperature	Relative humidity	Pressure
23°C ~25°C	45%~50%	101.5kPa

Method of Measurement

The EUT was connected to the spectrum analyzer through an external attenuator (20dB) and a known loss cable.

Set RBW = 500 kHz, VBW =1.5MHz for the band 5.725-5.85 GHz

Set RBW = 1 MHz, VBW =3MHz for the band 5.150-5.250 GHz

The conducted PSD is measured at each antenna port. The measured results at the various antenna ports are then summed mathematically.

Test setup

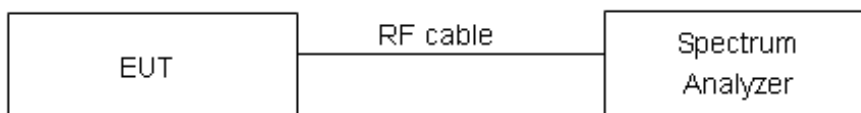

Limits

Rule FCC Part 15.407(a)(1)/ Part 15.407(a)(2) / Part 15.407(a)(3)

For an indoor access point operating in the band 5.15-5.25 GHz, the maximum power spectral density shall not exceed 17 dBm in any 1 megahertz band. If transmitting antennas of directional gain greater than 6 dBi are used, both the maximum conducted output power and the maximum power spectral density shall be reduced by the amount in dB that the directional gain of the antenna exceeds 6 dBi.

(iv) For client devices in the 5.15-5.25 GHz band, the maximum conducted output power over the frequency band of operation shall not exceed 250 mW provided the maximum antenna gain does not exceed 6 dBi. In addition, the maximum power spectral density shall not exceed 11 dBm in any 1 megahertz band. If transmitting antennas of directional gain greater than 6 dBi are used, both the maximum conducted output power and the maximum power spectral density shall be reduced by the amount in dB that the directional gain of the antenna exceeds 6 dBi.

For the 5.25-5.35 GHz and 5.47-5.725 GHz bands, the maximum power spectral density shall not exceed 11 dBm in any 1 megahertz band. If transmitting antennas of directional gain greater than 6 dBi are used, both the maximum conducted output power and the maximum power spectral density shall be reduced by the amount in dB that the directional gain of the antenna exceeds 6 dBi.

For the band 5.725-5.85 GHz, the maximum power spectral density shall not exceed 30 dBm in any 500-kHz band. If transmitting antennas of directional gain greater than 6 dBi are used, both the maximum conducted output power and the maximum power spectral density shall be reduced by the amount in dB that the directional gain of the antenna exceeds 6 dBi.



Frequency Bands/MHz	Limits
5150-5250	11dBm/MHz
5725-5850	30dBm/500kHz

Measurement Uncertainty

The assessed measurement uncertainty to ensure 95% confidence level for the normal distribution is with the coverage factor $k = 2$, $U = 0.75\text{dB}$.

**Test Results:**

Note: Power Spectral Density =Read Value+Duty cycle correction factor

U-NII-1

Network Standards	Channel Number	Read Value (dBm /MHz)	Power Spectral Density (dBm /MHz)	Limit (dBm /MHz)	Conclusion
802.11a	36	-1.31	0.70	11	PASS
	40	-1.33	0.68	11	PASS
	48	-0.69	1.32	11	PASS
802.11n HT20	36	-0.91	0.16	11	PASS
	40	-0.67	0.40	11	PASS
	48	-0.71	0.36	11	PASS
802.11n HT40	38	-4.30	-1.61	11	PASS
	46	-4.33	-1.64	11	PASS
802.11ac VHT20	36	-0.56	-0.33	11	PASS
	40	-0.23	0.00	11	PASS
	48	-0.38	-0.15	11	PASS
802.11ac VHT40	38	-3.21	-2.98	11	PASS
	46	-3.51	-3.28	11	PASS
802.11ac VHT80	42	-5.76	-5.43	11	PASS



U-NII-3

Network Standards	Channel Number	Read Value (dBm/500kHz)	Power Spectral Density (dBm/500kHz)	Limit (dBm/500kHz)	Conclusion
802.11a	149	-4.35	-2.34	30	PASS
	157	-5.19	-3.18	30	PASS
	165	-5.67	-3.66	30	PASS
802.11n HT20	149	-3.40	-2.33	30	PASS
	157	-3.35	-2.27	30	PASS
	165	-4.37	-3.30	30	PASS
802.11n HT40	151	-7.64	-4.95	30	PASS
	159	-8.08	-5.38	30	PASS
802.11ac VHT20	149	-5.07	-4.84	30	PASS
	157	-4.64	-4.41	30	PASS
	165	-4.60	-4.37	30	PASS
802.11ac VHT40	151	-5.54	-5.31	30	PASS
	159	-5.45	-5.22	30	PASS
802.11ac VHT80	155	-8.76	-8.43	30	PASS



U-NII-1, 802.11a, Channel No.: 36



U-NII-1, 802.11n HT20, Channel No.: 36



U-NII-1, 802.11a, Channel No.: 40



U-NII-1, 802.11n HT20, Channel No.: 40



U-NII-1, 802.11a, Channel No.: 48



U-NII-1, 802.11n HT20, Channel No.: 48





U-NII-1, 802.11n HT40, Channel No.: 38



U-NII-1, 802.11ac VHT20, Channel No.: 36

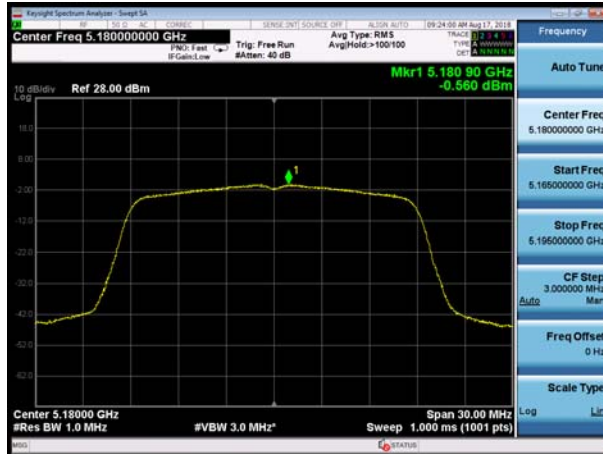

U-NII-1, 802.11n HT40, Channel No.: 46



U-NII-1, 802.11ac VHT20, Channel No.: 40



U-NII-1, 802.11ac VHT40, Channel No.: 38



U-NII-1, 802.11ac VHT20, Channel No.: 48



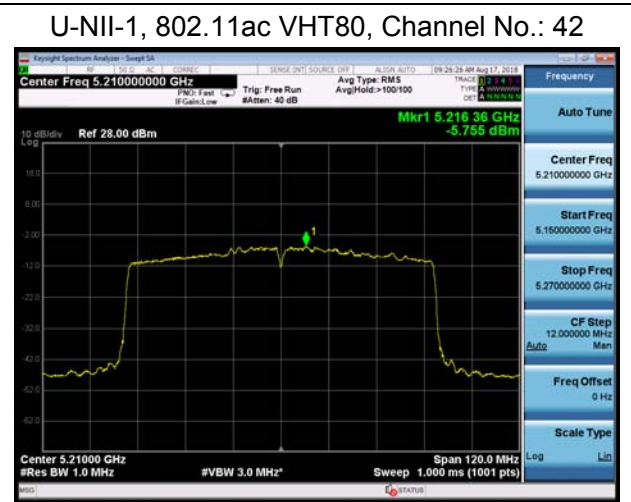
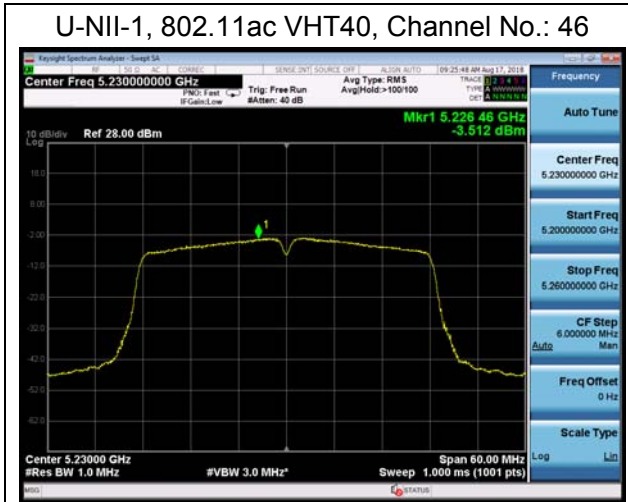



U-NII-3, 802.11a, Channel No.: 149



U-NII-3, 802.11n HT20, Channel No.: 149



U-NII-3, 802.11a, Channel No.: 157

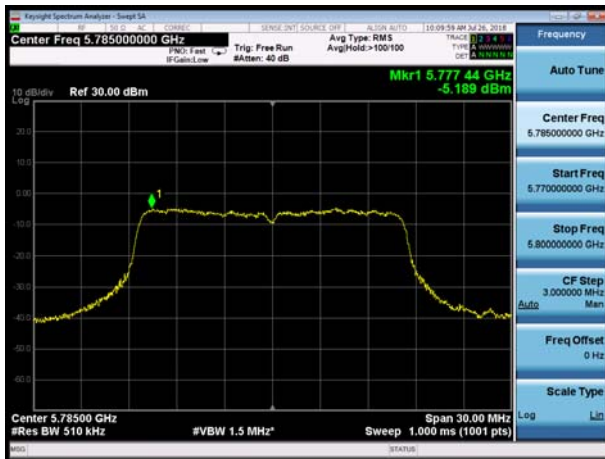

U-NII-3, 802.11n HT20, Channel No.: 157



U-NII-3, 802.11a, Channel No.: 165



U-NII-3, 802.11n HT20, Channel No.: 165



U-NII-3, 802.11n HT40, Channel No.: 151



U-NII-3, 802.11ac VHT20, Channel No.: 149



U-NII-3, 802.11n HT40, Channel No.: 159



U-NII-3, 802.11ac VHT20, Channel No.: 157

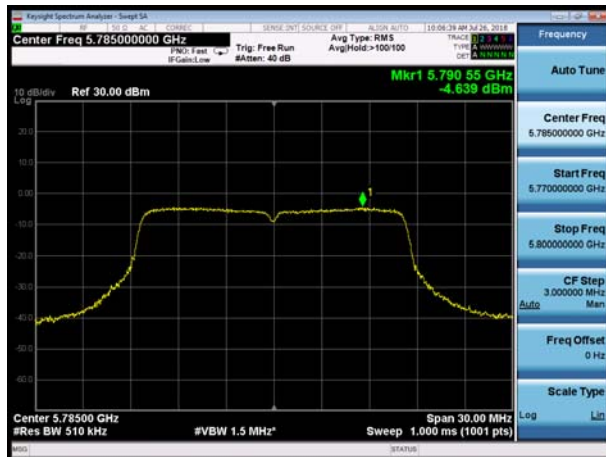

U-NII-3, 802.11ac VHT40, Channel No.: 151



U-NII-3, 802.11ac VHT20, Channel No.: 165





U-NII-3, 802.11ac VHT40, Channel No.: 159



U-NII-3, 802.11ac VHT80, Channel No.: 155



5.5. Unwanted Emission

Ambient condition

Temperature	Relative humidity	Pressure
23°C ~25°C	45%~50%	101.5kPa

Method of Measurement

The test set-up was made in accordance to the general provisions of ANSI C63.10-2013. The Equipment Under Test (EUT) was set up on a non-conductive table in the semi-anechoic chamber. The test was performed at the distance of 3 m between the EUT and the receiving antenna. The radiated emissions measurements were made in a typical installation configuration. Sweep the whole frequency band range from 9kHz to the 10th harmonic of the carrier, and the emissions less than 20 dB below the permissible value are reported.

During the test, the height of receive antenna shall be moved from 1 to 4 meters, and the antenna shall be performed under horizontal and vertical polarization. The turntable shall be rotated from 0 to 360 degrees for detecting the maximum of radiated spurious signal level. The measurements shall be repeated with orthogonal polarization of the test antenna. The data of cable loss and antenna factor has been calibrated in full testing frequency range before the testing.

Set the spectrum analyzer in the following:

Below 1GHz (detector: Peak and Quasi-Peak)

RBW=100kHz / VBW=300kHz / Sweep=AUTO

Above 1GHz (detector: Peak):

I) Peak emission levels are measured by setting the instrument as follows:

1) RBW = 1 MHz.

2) VBW \geq [3 \times RBW]

3) Detector = peak.

4) Sweep time = auto.

5) Trace mode = max hold.

6) Allow sweeps to continue until the trace stabilizes. Note that if the transmission is not continuous, then the time required for the trace to stabilize will increase by a factor of approximately 1 / D, where D is the duty cycle.

II) Average emission levels are measured by setting the instrument as follows:

a) RBW = 1 MHz.

b) VBW \geq [3 \times RBW].

c) Detector = RMS (power averaging), if [span / (# of points in sweep)] \leq RBW / 2. Satisfying this condition can require increasing the number of points in the sweep or reducing the span. If the condition is not satisfied, then the detector mode shall be set to peak.

d) Averaging type = power (i.e., rms) (As an alternative, the detector and averaging type may be set for linear voltage averaging. Some instruments require linear display mode to use linear voltage averaging. Log or dB averaging shall not be used.)



e) Sweep time = auto.

f) Perform a trace average of at least 100 traces if the transmission is continuous. If the transmission is not continuous, then the number of traces shall be increased by a factor of $1 / D$, where D is the duty cycle. For example, with 50% duty cycle, at least 200 traces shall be averaged. (If a specific emission is demonstrated to be continuous—i.e., 100% duty cycle—then rather than turning ON and OFF with the transmit cycle, at least 100 traces shall be averaged.)

g) If tests are performed with the EUT transmitting at a duty cycle less than 98%, then a correction factor shall be added to the measurement results prior to comparing with the emission limit, to compute the emission level that would have been measured had the test been performed at 100% duty cycle. The correction factor is computed as follows:

1) If power averaging (rms) mode was used in the preceding step e), then the correction factor is $[10 \log (1 / D)]$, where D is the duty cycle. For example, if the transmit duty cycle was 50%, then 3 dB shall be added to the measured emission levels.

2) If linear voltage averaging mode was used in the preceding step e), then the correction factor is $[20 \log (1 / D)]$, where D is the duty cycle. For example, if the transmit duty cycle was 50%, then 6 dB shall be added to the measured emission levels.

3) If a specific emission is demonstrated to be continuous (100% duty cycle) rather than turning ON and OFF with the transmit cycle, then no duty cycle correction is required for that emission.

The field strength of spurious emission was measured in the following position: EUT stand-up position (Z axis), lie-down position (X, Y axis). The worst emission was found in stand-up position (Z axis) and the antenna is vertical.

The test is in transmitting mode.

9KHz~~~30MHz

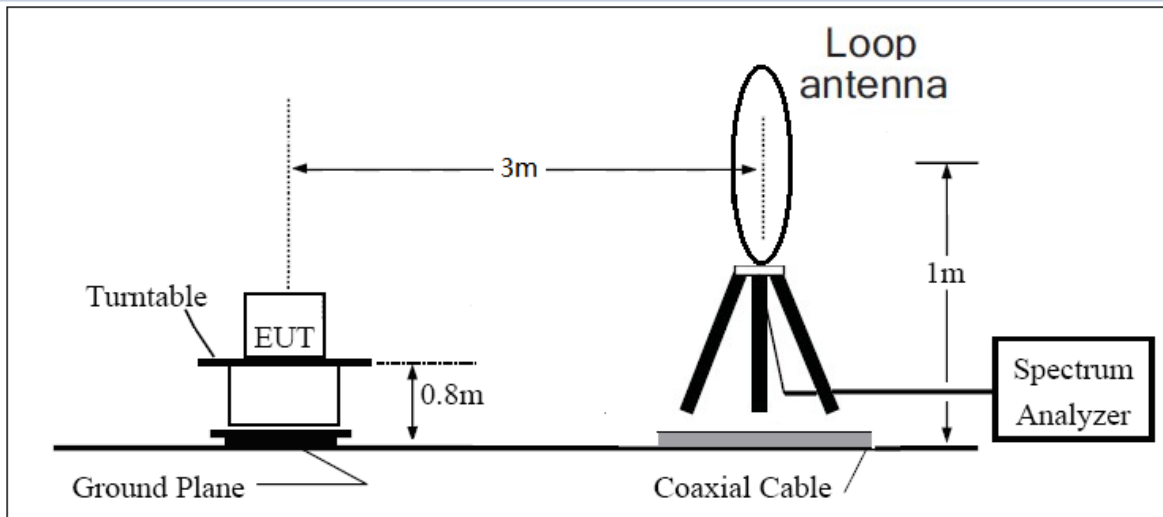

30MHz~~~ 1GHz

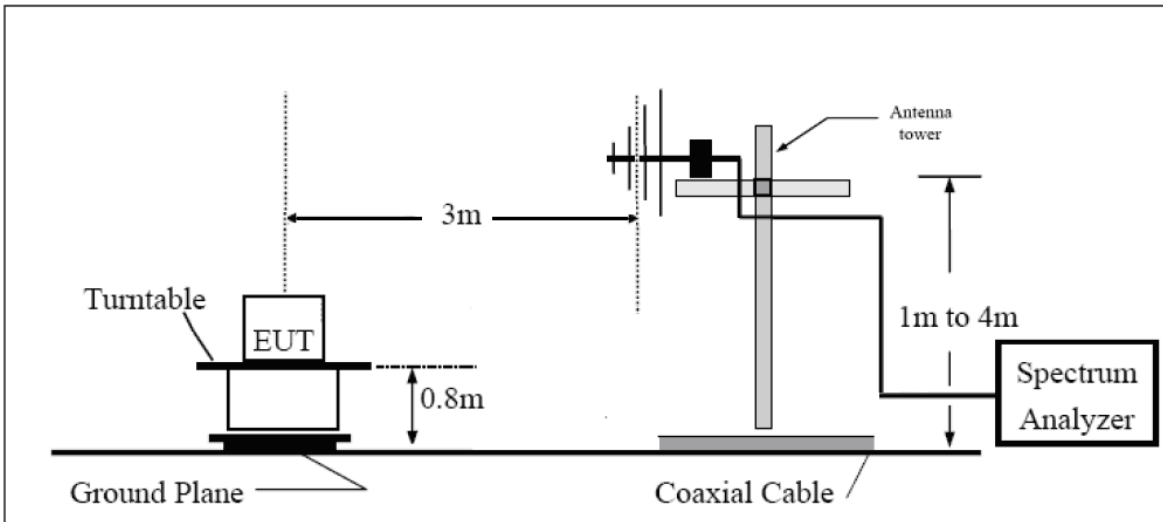

Above 1GHz

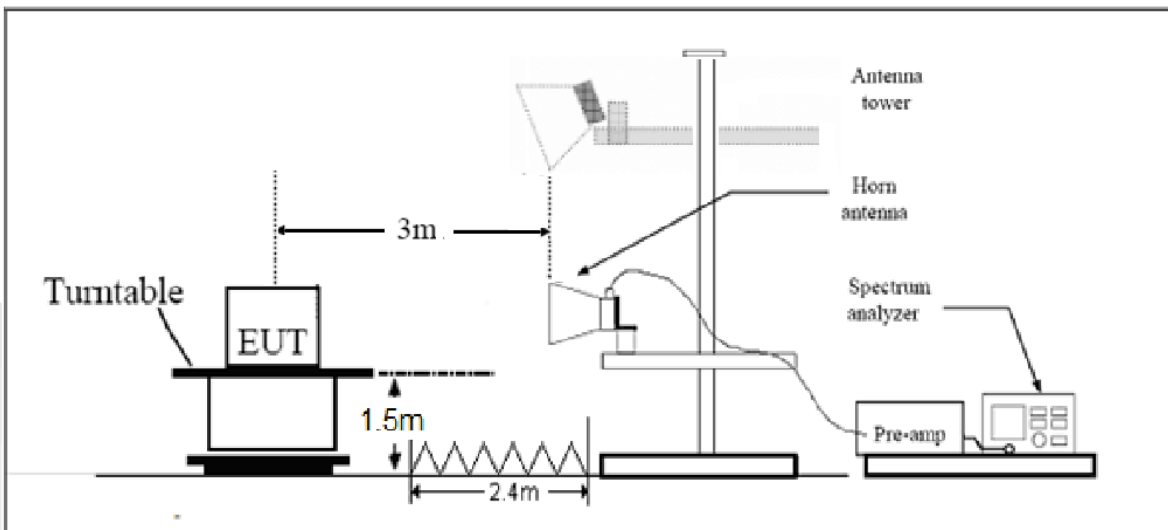

Note: Area side:2.4mX3.6m

Limits

- (1) For transmitters operating in the 5725-5850 MHz band: All emissions shall be limited to a level of -27 dBm/MHz at 75 MHz or more above or below the band edge increasing linearly to 10 dBm/MHz at 25 MHz above or below the band edge, and from 25 MHz above or below the band edge increasing linearly to a level of 15.6 dBm/MHz at 5 MHz above or below the band edge, and from 5 MHz above or below the band edge increasing linearly to a level of 27 dBm/MHz at the band edge.
- (2) For transmitters operating in the 5.15-5.25 GHz band: All emissions outside of the 5.15-5.35 GHz band shall not exceed an e.i.r.p. of -27 dBm/MHz(68.2dBμV/m).
- (3) Unwanted spurious emissions fallen in restricted bands per FCC Part15.205 shall comply with the general field strength limits set forth in § 15.209 as below table.

Frequency of emission (MHz)	Field strength(uV/m)	Field strength(dBuV/m)
0.009-0.490	2400/F(kHz)	/
0.490-1.705	24000/F(kHz)	/
1.705-30.0	30	/
30-88	100	40
88-216	150	43.5
216-960	200	46
Above960	500	54

MHz	MHz	MHz	GHz
0.090 - 0.110	16.42 - 16.423	399.9 - 410	4.5 - 5.15
0.495 - 0.505	16.69475 - 16.69525	608 - 614	5.35 - 5.46
2.1735 - 2.1905	16.80425 - 16.80475	960 - 1240	7.25 - 7.75
4.125 - 4.128	25.5 - 25.67	1300 - 1427	8.025 - 8.5
4.17725 - 4.17775	37.5 - 38.25	1435 - 1626.5	9.0 - 9.2
4.20725 - 4.20775	73 - 74.6	1645.5 - 1646.5	9.3 - 9.5
6.215 - 6.218	74.8 - 75.2	1660 - 1710	10.6 - 12.7
6.26775 - 6.26825	108 - 121.94	1718.8 - 1722.2	13.25 - 13.4
6.31175 - 6.31225	123 - 138	2200 - 2300	14.47 - 14.5
8.291 - 8.294	149.9 - 150.05	2310 - 2390	15.35 - 16.2
8.362 - 8.366	156.52475 - 156.52525	2483.5 - 2500	17.7 - 21.4
8.37625 - 8.38675	156.7 - 156.9	2690 - 2900	22.01 - 23.12
8.41425 - 8.41475	162.0125 - 167.17	3260 - 3267	23.6 - 24.0
12.29 - 12.293	167.72 - 173.2	3332 - 3339	31.2 - 31.8
12.51975 - 12.52025	240 - 285	3345.8 - 3358	36.43 - 36.5
12.57675 - 12.57725	322 - 335.4	3600 - 4400	(²)
13.36 - 13.41			

**Measurement Uncertainty**

The assessed measurement uncertainty to ensure 95% confidence level for the normal distribution is with the coverage factor $k = 1.96$.

Frequency	Uncertainty
9KHz-30MHz	3.55 dB
30MHz-200MHz	4.19 dB
200MHz-1GHz	3.63 dB
1GHz-26.5G	3.68 dB
26.5G-40GHz	4.76dB



Test Results:

The signal beyond the limit is carrier.

U-NII-1

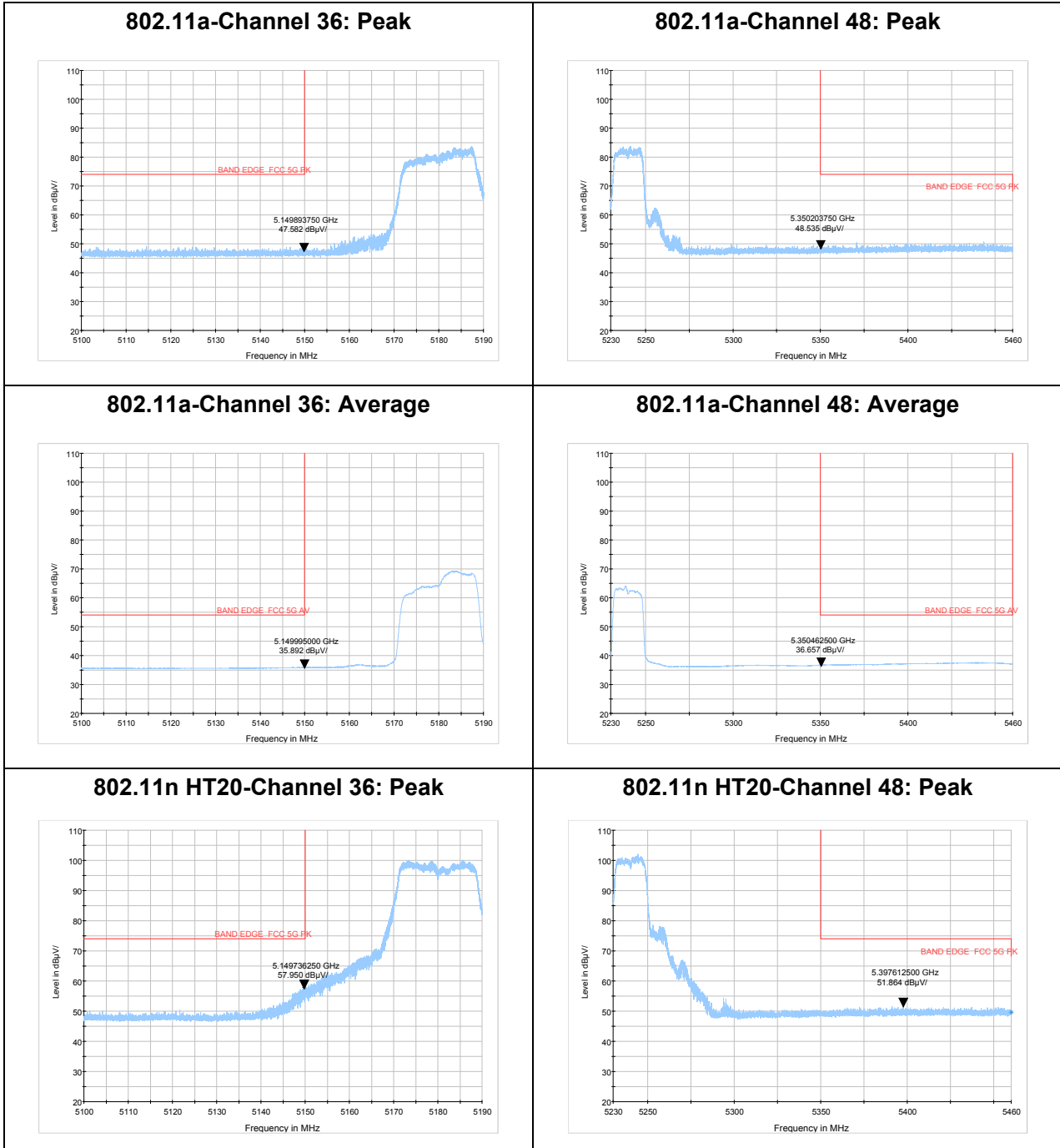



802.11n HT20-Channel 36: Average

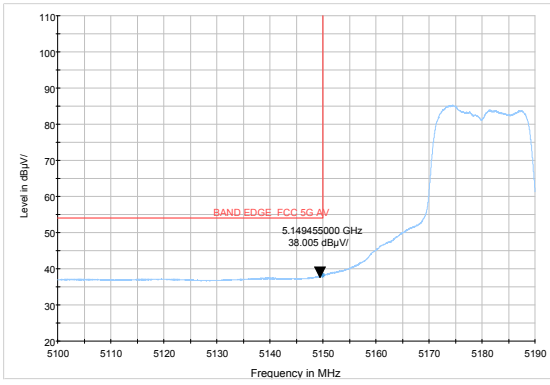

802.11n HT20-Channel 48: Average

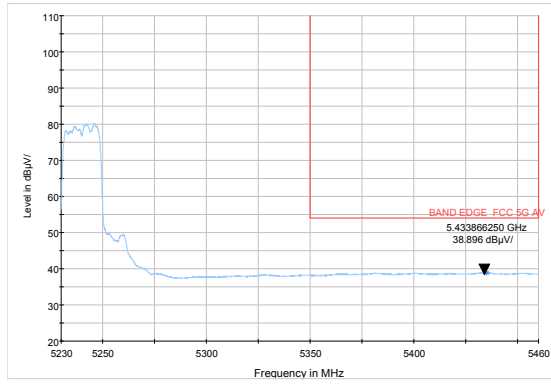

802.11n HT40-Channel 38: Peak

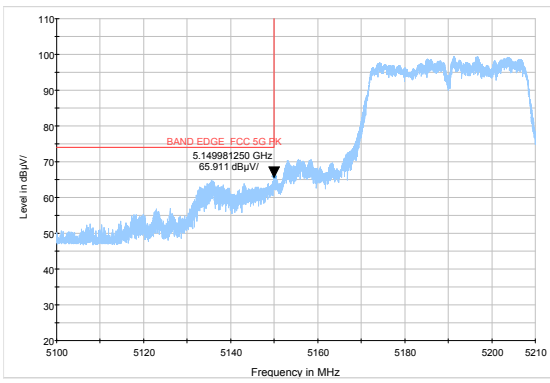

802.11n HT40-Channel 46: Peak

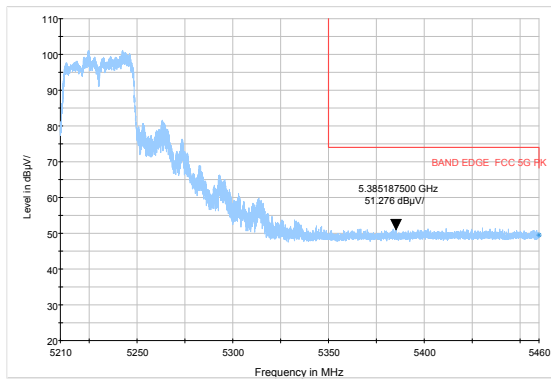

802.11n HT40-Channel 38: Average

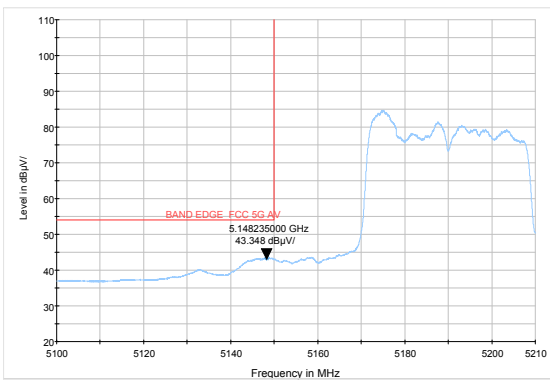

802.11n HT40-Channel 46: Average

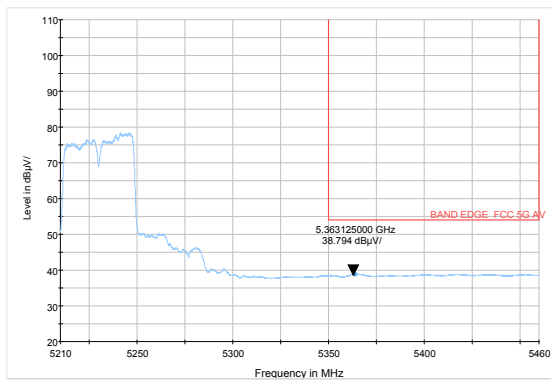



802.11ac VHT80 –Channel 42: Peak

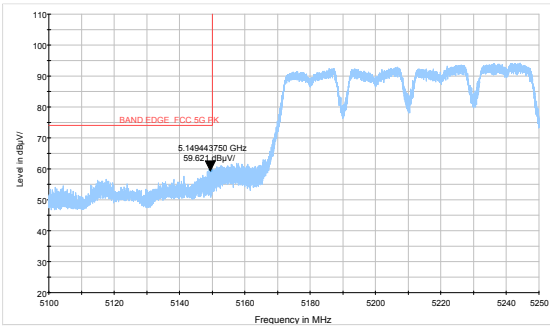

802.11ac VHT80- Channel 42: Average

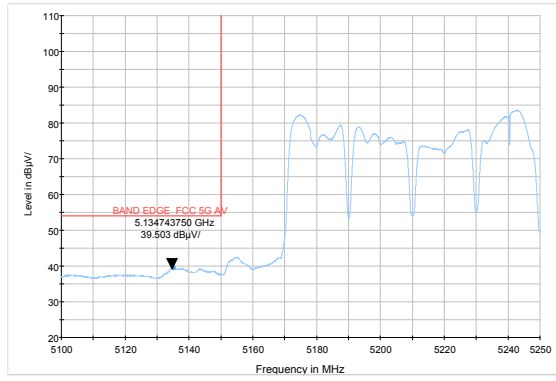



U-NII-3

802.11a-Channel 149: Peak

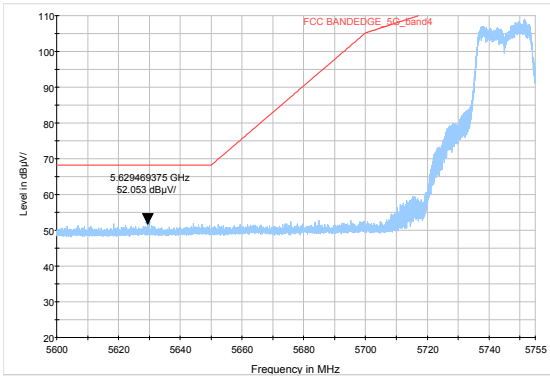

802.11a-Channel 165: Peak

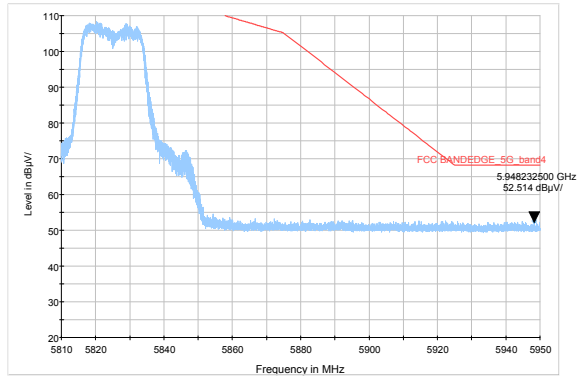

802.11n HT20-Channel 149: Peak

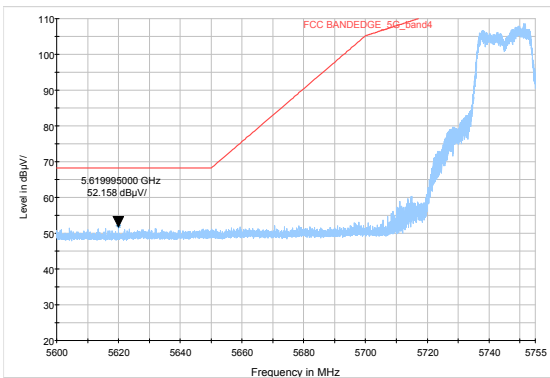

802.11n HT20-Channel 165: Peak

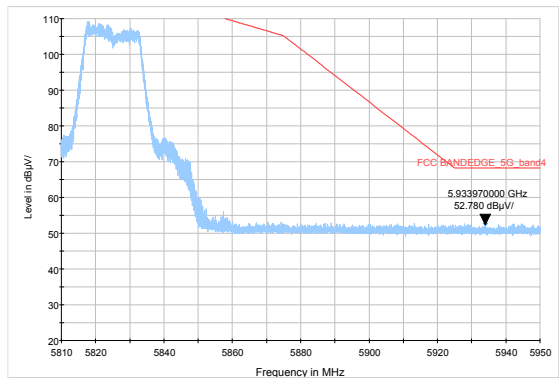

802.11n HT40-Channel 151: Peak

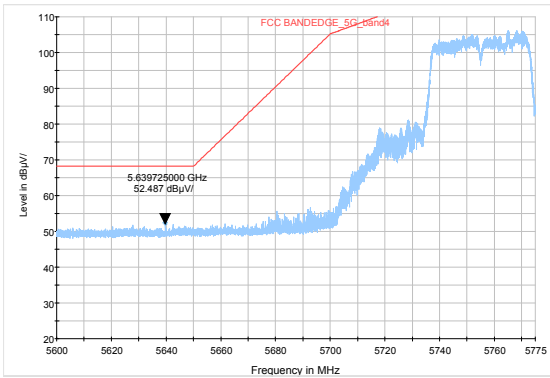

802.11n HT40-Channel 159: Peak

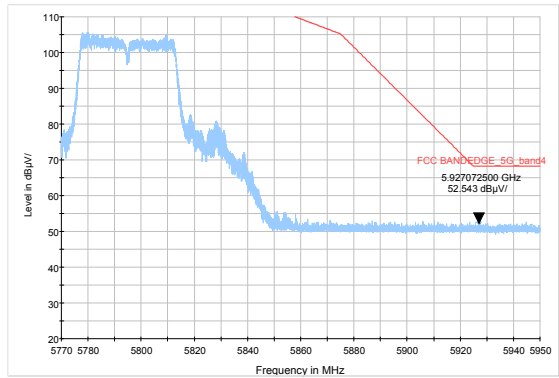

802.11ac VHT80- Channel 155: Peak

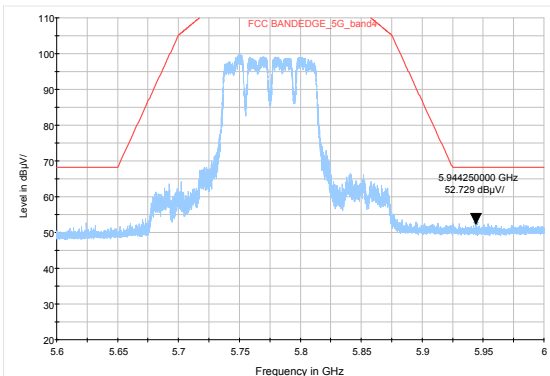

Result of RE

Test result

Sweep the whole frequency band through the range from 9kHz to the 10th harmonic of the carrier, the Emissions in the frequency band 9kHz-30MHz and 18GHz-40GHz are more than 20dB below the limit are not reported.

During the test, the Radiates Emission from 30MHz to 1GHz was performed in all modes with all channels, 802.11a, Channel 36 are selected as the worst condition. The test data of the worst-case condition was recorded in this report.

Continuous TX mode:

RE 30M-1GHz QP

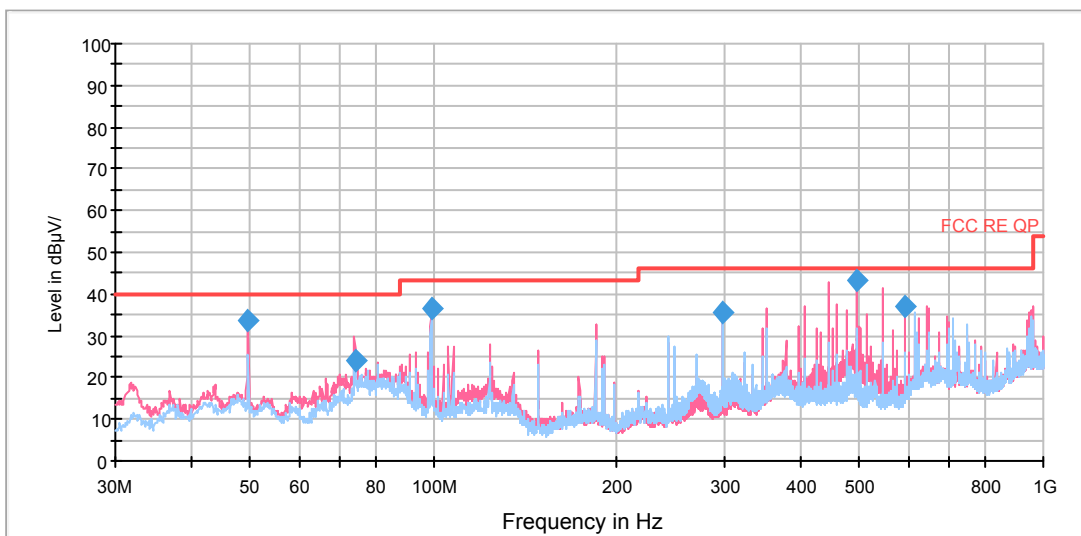

Radiates Emission from 30MHz to 1GHz

Frequency (MHz)	Quasi-Peak (dBuV/m)	Reading value (dBuV/m)	Height (cm)	Polarization	Azimuth (deg)	Correct Factor (dB)	Margin (dB)	Limit (dBuV/m)
49.517447	33.8	52.2	125.0	V	62.0	-18.4	6.2	40.0
74.269662	23.9	51.1	175.0	V	71.0	-27.2	16.1	40.0
98.983772	36.6	60.5	100.0	V	139.0	-23.9	6.9	43.5
297.010000	35.8	58.8	100.0	H	278.0	-23.0	10.2	46.0
494.996250	43.3	63.5	100.0	V	206.0	-20.2	2.7	46.0
594.010000	37.2	56.3	100.0	V	227.0	-19.1	8.8	46.0

- Remark:**
1. Quasi-Peak = Reading value + Correction factor
 2. Correction Factor = Antenna factor+ Insertion loss(cable loss+amplifier gain)
 3. Margin = Limit – Quasi-Peak

802.11a CH36

RE 1G-3GHz PK+AV

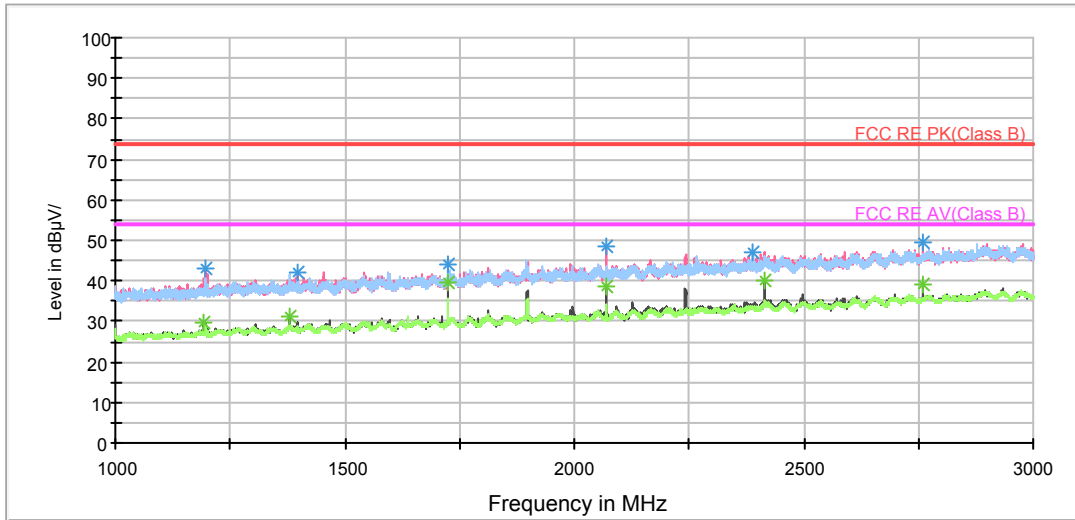

Radiates Emission from 1GHz to 3GHz

RE 3-18GHz PK+AV

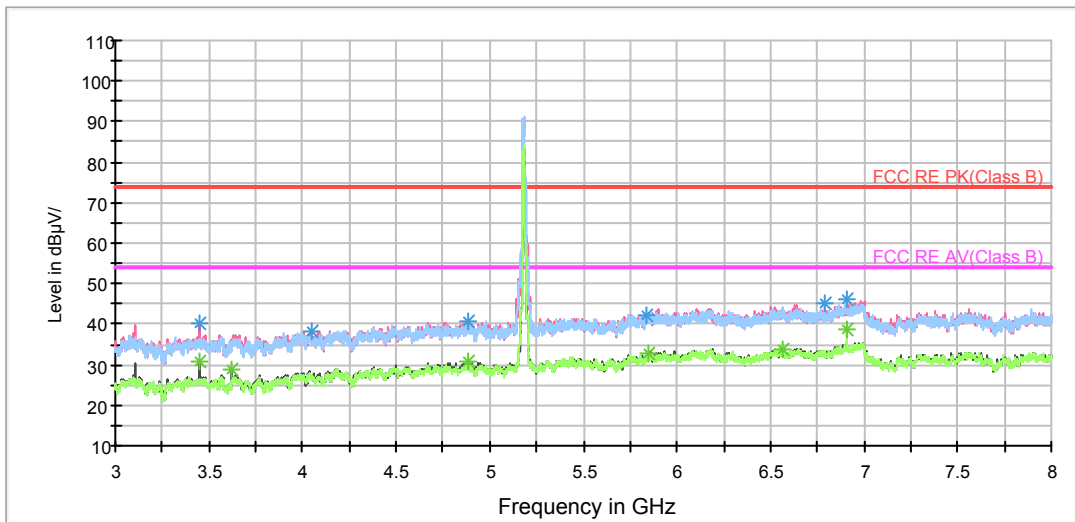

Note: The signal beyond the limit is carrier.

Radiates Emission from 3GHz to 8GHz

RE 3-18GHz PK+AV

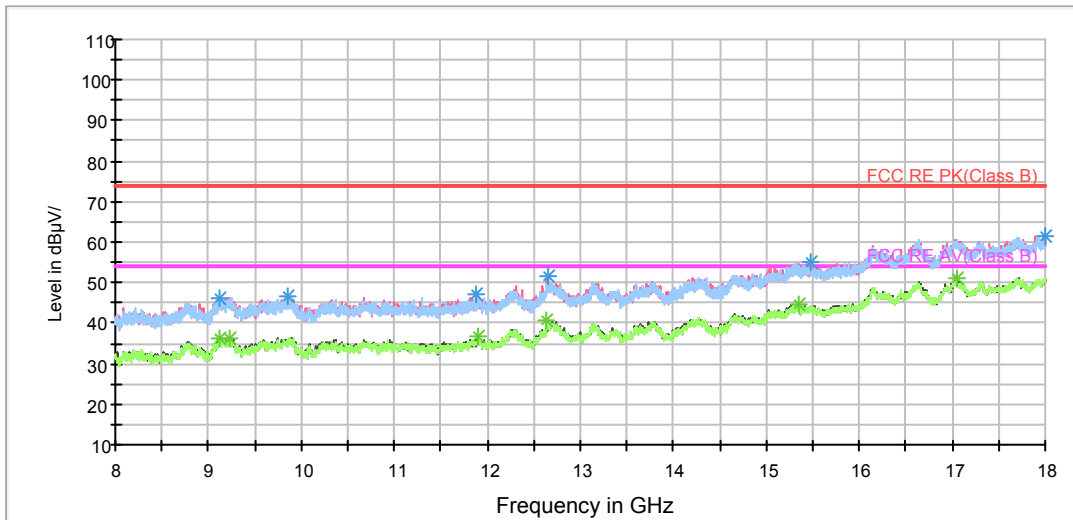

Radiates Emission from 8GHz to 18GHz

Frequency (MHz)	Peak (dBuV/m)	Height (cm)	Polarization	Azimuth (deg)	Reading value (dBuV/m)	Correct Factor (dB)	Margin (dB)	Limit (dBuV/m)
3450.000000	40.2	100.0	V	291.0	42.4	-2.2	33.8	74
4046.250000	38.0	200.0	V	13.0	39.0	-1.0	36.0	74
4881.250000	40.5	100.0	V	281.0	38.7	1.8	33.5	74
5838.125000	42.1	200.0	V	3.0	37.6	4.5	31.9	74
6788.125000	44.9	200.0	H	281.0	39.2	5.7	29.1	74
6906.875000	46.0	200.0	H	299.0	39.7	6.3	28.0	74

Remark: 1. Correction Factor = Antenna factor+ Insertion loss (cable loss + amplifier gain)

Frequency (MHz)	Average (dBuV/m)	Height (cm)	Polarization	Azimuth (deg)	Reading value (dBuV/m)	Correct Factor (dB)	Margin (dB)	Limit (dBuV/m)
3449.375000	30.6	100.0	V	291.0	32.8	-2.2	23.4	54
3622.500000	29.0	100.0	V	291.0	31.0	-2.0	25.0	54
4884.375000	30.7	200.0	V	62.0	28.8	1.9	23.3	54
5847.500000	32.9	200.0	V	170.0	28.3	4.6	21.1	54
6561.875000	34.0	200.0	V	0.0	28.2	5.8	20.0	54
6906.875000	38.6	200.0	H	299.0	32.3	6.3	15.4	54

Remark: 1. Correction Factor = Antenna factor+ Insertion loss (cable loss + amplifier gain)

802.11a CH40

RE 1G-3GHz PK+AV

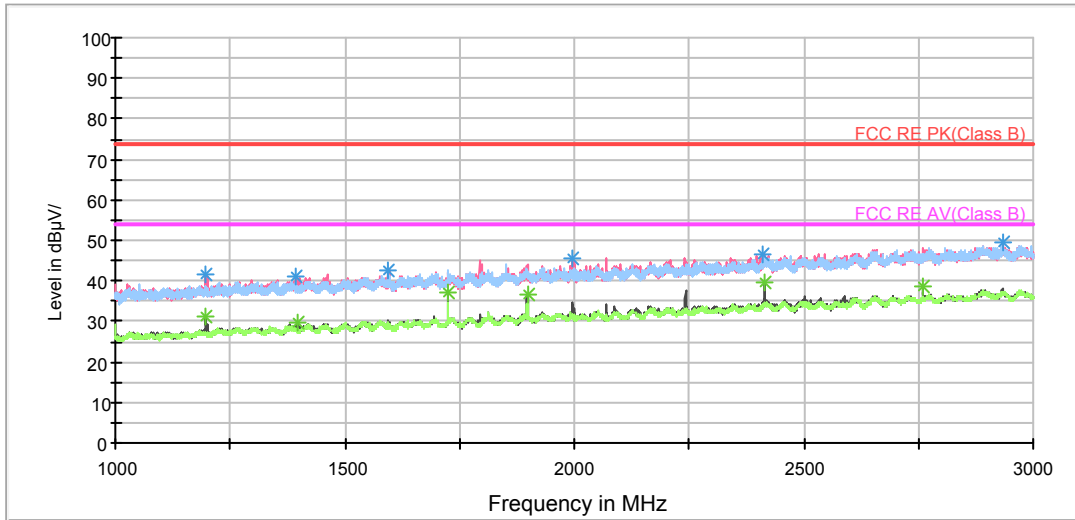

Radiates Emission from 1GHz to 3GHz

RE 3-18GHz PK+AV

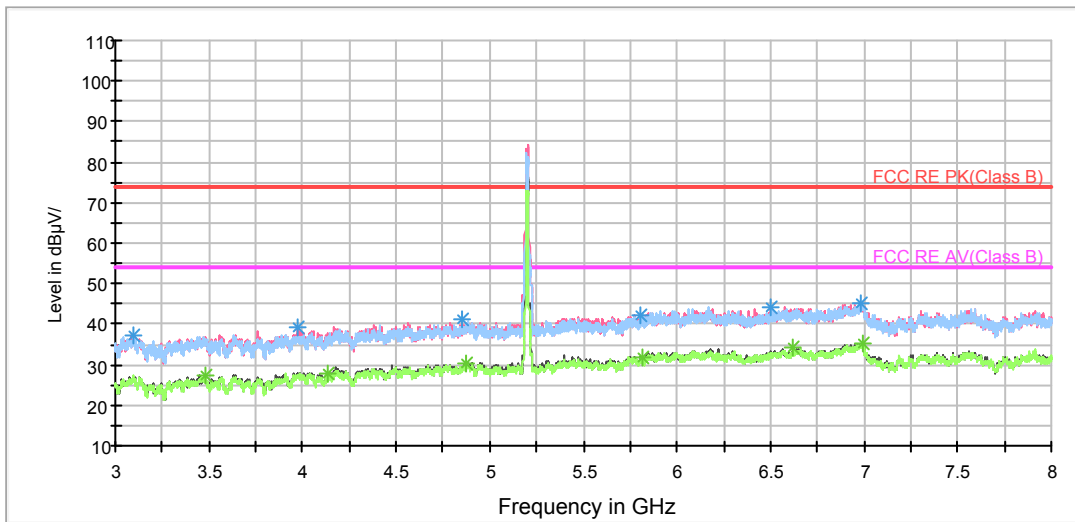

Note: The signal beyond the limit is carrier.

Radiates Emission from 3GHz to 8GHz

RE 3-18GHz PK+AV

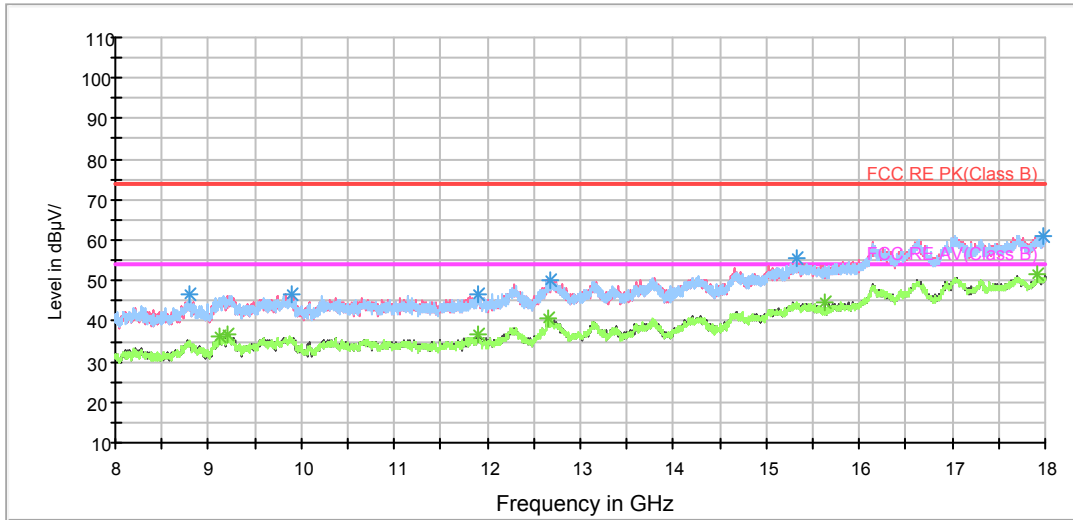

Radiates Emission from 8GHz to 18GHz

Frequency (MHz)	Peak (dBuV/m)	Height (cm)	Polarization	Azimuth (deg)	Reading value (dBuV/m)	Correct Factor (dB)	Margin (dB)	Limit (dBuV/m)
3096.250000	37.3	100.0	V	332.0	40.1	-2.8	36.7	74
3976.250000	39.3	100.0	V	245.0	40.2	-0.9	34.7	74
4855.625000	41.2	100.0	V	254.0	39.6	1.6	32.8	74
5808.125000	42.1	100.0	H	78.0	37.8	4.3	31.9	74
6504.375000	44.3	100.0	V	342.0	39.0	5.3	29.7	74
6982.500000	45.3	200.0	H	348.0	38.9	6.4	28.7	74

Remark: 1. Correction Factor = Antenna factor+ Insertion loss (cable loss + amplifier gain)

Frequency (MHz)	Average (dBuV/m)	Height (cm)	Polarization	Azimuth (deg)	Reading value (dBuV/m)	Correct Factor (dB)	Margin (dB)	Limit (dBuV/m)
3478.750000	27.2	200.0	V	294.0	29.2	-2.0	26.8	54
4138.750000	28.0	100.0	V	313.0	28.3	-0.3	26.0	54
4873.750000	30.4	100.0	V	313.0	28.6	1.8	23.6	54
5813.125000	32.0	200.0	V	14.0	27.6	4.4	22.0	54
6621.250000	34.1	200.0	H	329.0	28.6	5.5	19.9	54
6992.500000	35.3	100.0	V	323.0	28.8	6.5	18.7	54

Remark: 1. Correction Factor = Antenna factor+ Insertion loss (cable loss + amplifier gain)

802.11a CH48

RE 1G-3GHz PK+AV

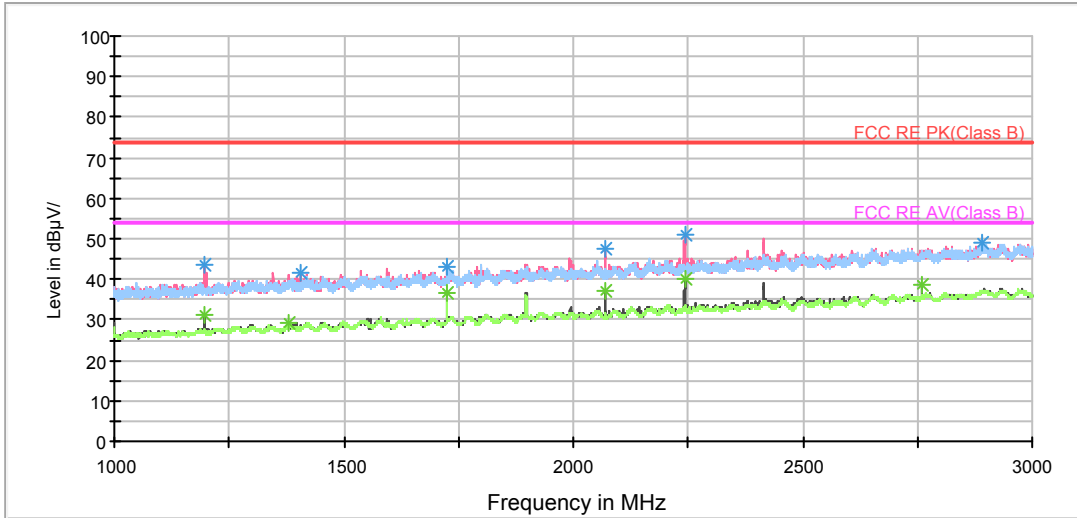

Radiates Emission from 1GHz to 3GHz

RE 3-18GHz PK+AV

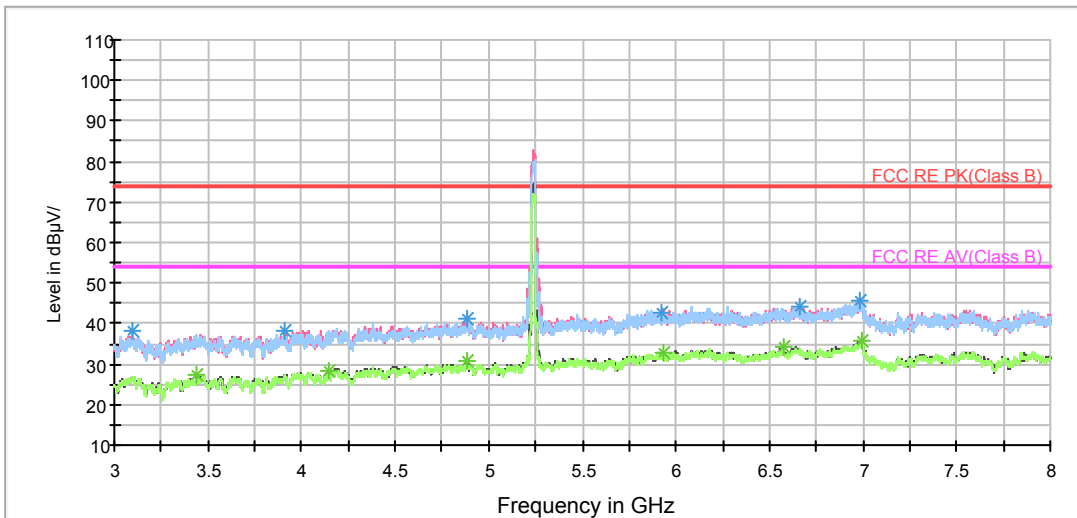

Note: The signal beyond the limit is carrier.

Radiates Emission from 3GHz to 8GHz

RE 3-18GHz PK+AV

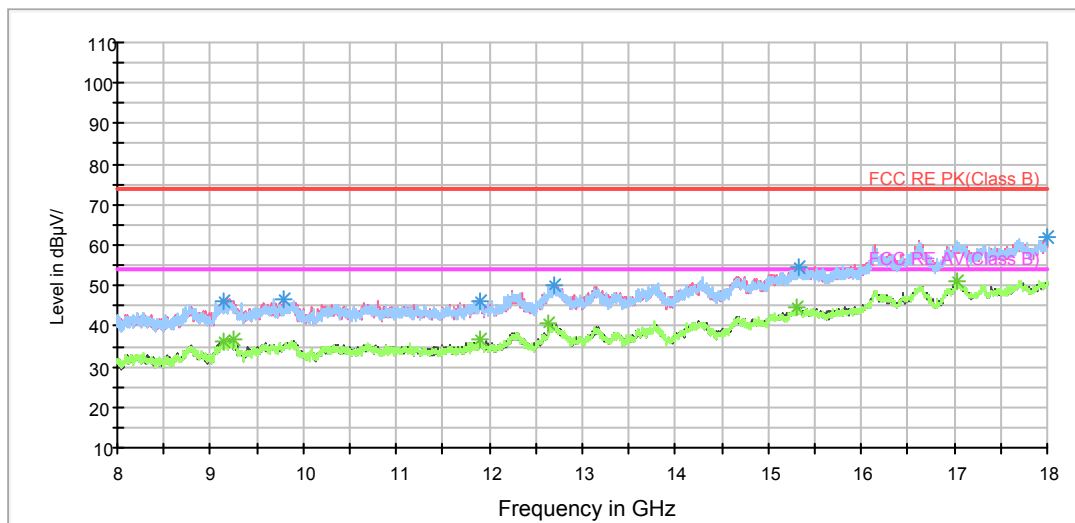

Radiates Emission from 8GHz to 18GHz

Frequency (MHz)	Peak (dBuV/m)	Height (cm)	Polarization	Azimuth (deg)	Reading value (dBuV/m)	Correct Factor (dB)	Margin (dB)	Limit (dBuV/m)
3098.125000	38.2	200.0	H	277.0	41.0	-2.8	35.8	74
3906.250000	38.4	200.0	V	27.0	39.6	-1.2	35.6	74
4888.750000	41.0	200.0	H	287.0	39.1	1.9	33.0	74
5920.000000	42.8	200.0	V	65.0	37.9	4.9	31.2	74
6660.000000	44.3	100.0	H	21.0	38.8	5.5	29.7	74
6983.125000	45.4	200.0	V	0.0	39.0	6.4	28.6	74

Remark: 1. Correction Factor = Antenna factor+ Insertion loss (cable loss + amplifier gain)

Frequency (MHz)	Average (dBuV/m)	Height (cm)	Polarization	Azimuth (deg)	Reading value (dBuV/m)	Correct Factor (dB)	Margin (dB)	Limit (dBuV/m)
3440.000000	27.2	200.0	V	338.0	29.5	-2.3	26.8	54
4141.875000	28.3	200.0	V	0.0	28.5	-0.2	25.7	54
4881.250000	30.6	200.0	V	254.0	28.8	1.8	23.4	54
5933.750000	32.9	200.0	V	142.0	28.1	4.8	21.1	54
6573.750000	34.2	200.0	H	33.0	28.6	5.6	19.8	54
6994.375000	35.7	200.0	V	46.0	29.2	6.5	18.3	54

Remark: 1. Correction Factor = Antenna factor+ Insertion loss (cable loss + amplifier gain)

802.11a CH149

RE 1G-3GHz PK+AV

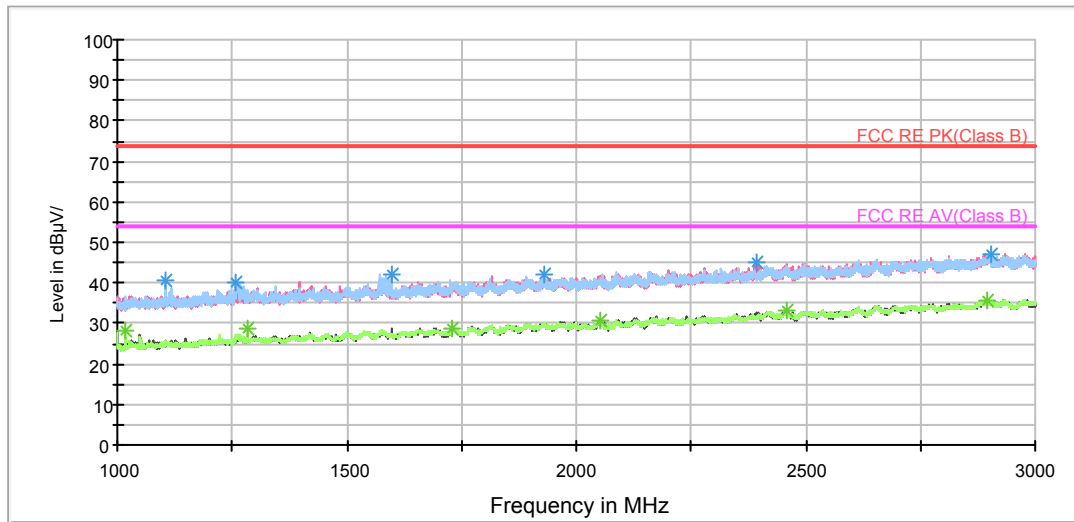

Radiates Emission from 1GHz to 3GHz

RE 3-18GHz PK+AV

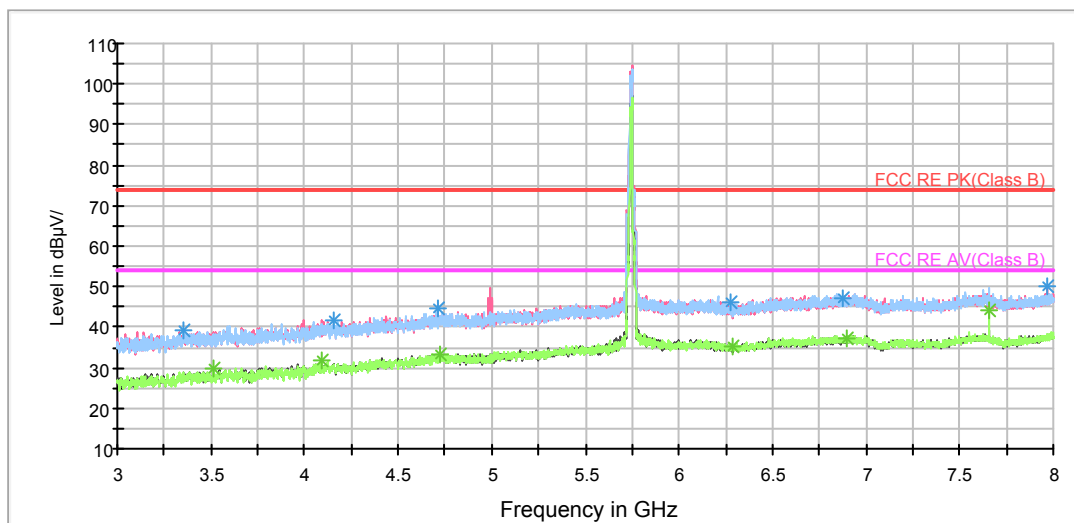

Note: The signal beyond the limit is carrier.

Radiates Emission from 3GHz to 8GHz

RE 3-18GHz PK+AV

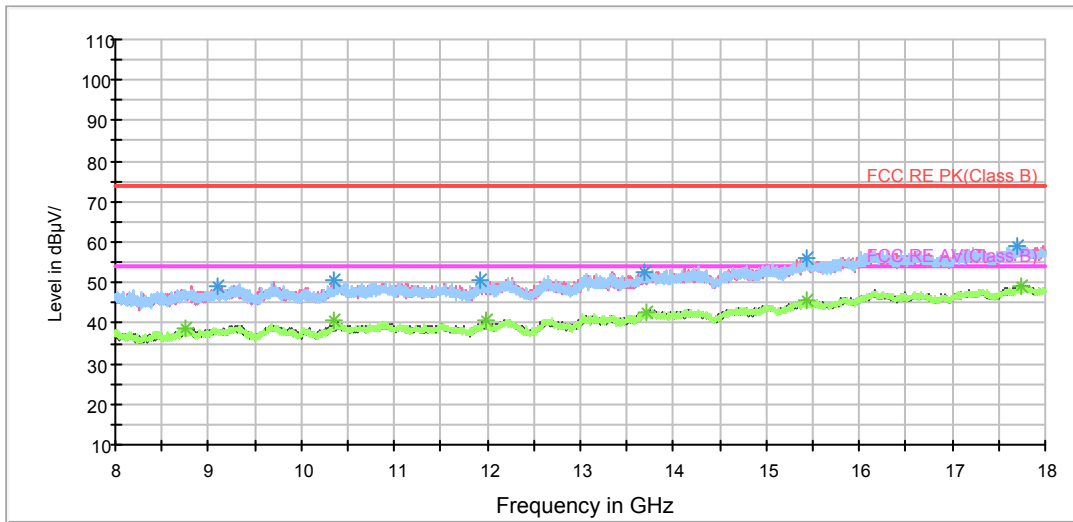

Radiates Emission from 8GHz to 18GHz

Frequency (MHz)	Peak (dBuV/m)	Height (cm)	Polarization	Azimuth (deg)	Reading value (dBuV/m)	Correct Factor (dB)	Margin (dB)	Limit (dBuV/m)
3352.500000	39.2	100.0	H	0.0	41.3	-2.1	34.8	74
4158.125000	41.7	200.0	H	292.0	41.6	0.1	32.3	74
4715.625000	44.4	100.0	H	17.0	42.9	1.5	29.6	74
6273.125000	46.2	100.0	V	0.0	40.8	5.4	27.8	74
6875.000000	47.2	100.0	V	224.0	40.8	6.4	26.8	74
7968.750000	49.9	100.0	V	126.0	42.8	7.1	24.1	74

Remark: 1. Correction Factor = Antenna factor+ Insertion loss (cable loss + amplifier gain)

Frequency (MHz)	Average (dBuV/m)	Height (cm)	Polarization	Azimuth (deg)	Reading value (dBuV/m)	Correct Factor (dB)	Margin (dB)	Limit (dBuV/m)
3510.000000	29.7	200.0	H	341.0	31.3	-1.6	24.3	54
4090.625000	31.6	100.0	V	95.0	31.8	-0.2	22.4	54
4719.375000	33.4	100.0	V	254.0	31.9	1.5	20.6	54
6290.625000	35.4	200.0	V	127.0	30.0	5.4	18.6	54
6899.375000	37.1	100.0	V	315.0	30.7	6.4	16.9	54
7660.625000	44.2	200.0	H	341.0	37.3	6.9	9.8	54

Remark: 1. Correction Factor = Antenna factor+ Insertion loss (cable loss + amplifier gain)

802.11a CH157

RE 1G-3GHz PK+AV

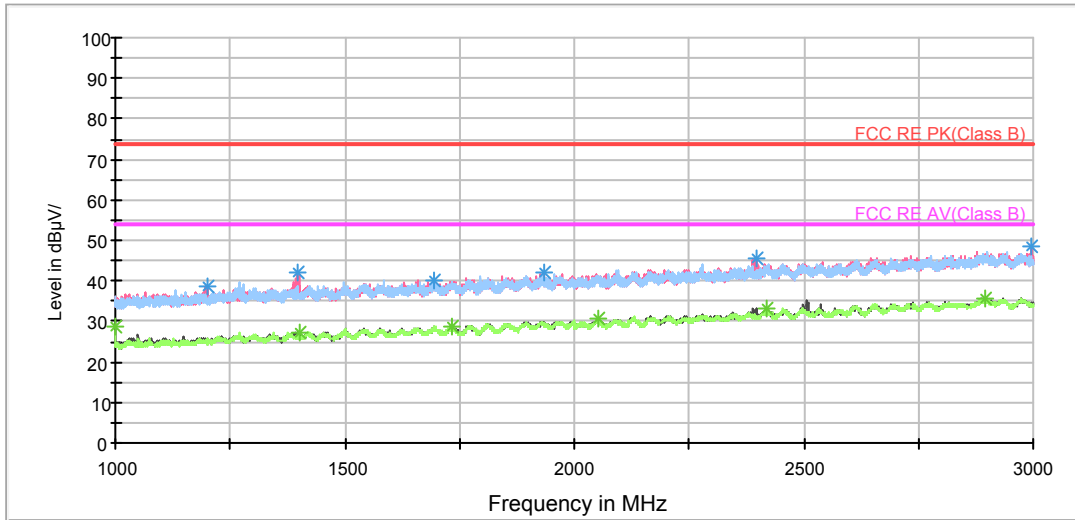

Radiates Emission from 1GHz to 3GHz

RE 3-18GHz PK+AV

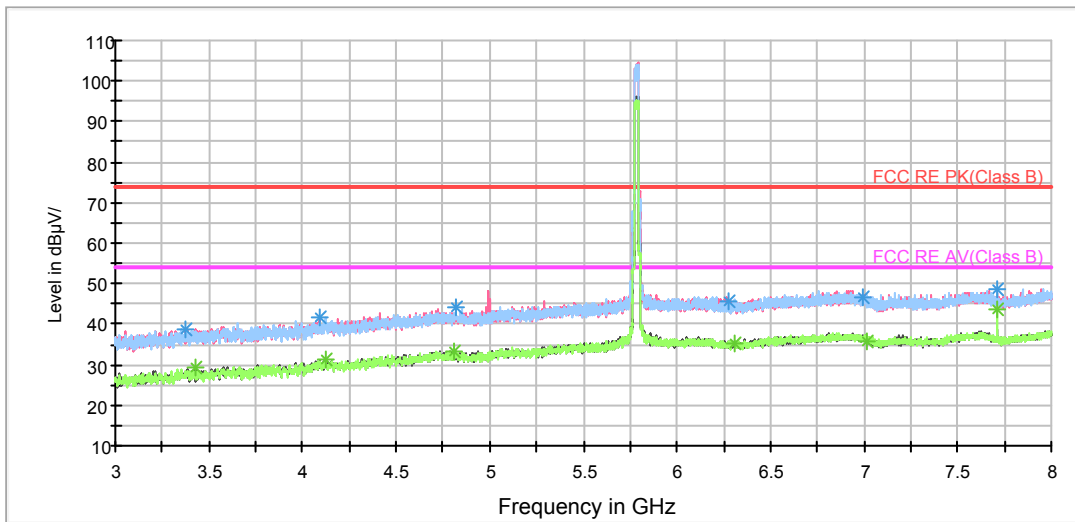

Note: The signal beyond the limit is carrier.

Radiates Emission from 3GHz to 8GHz

RE 3-18GHz PK+AV

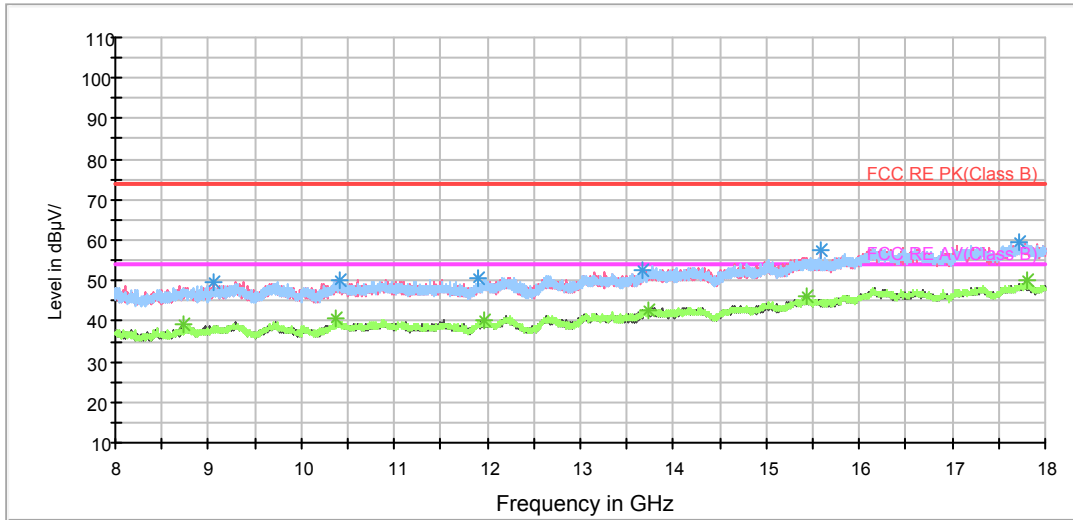

Radiates Emission from 8GHz to 18GHz

Frequency (MHz)	Peak (dBuV/m)	Height (cm)	Polarization	Azimuth (deg)	Reading value (dBuV/m)	Correct Factor (dB)	Margin (dB)	Limit (dBuV/m)
3372.500000	38.9	100.0	V	0.0	40.9	-2.0	35.1	74
4087.500000	41.6	100.0	V	346.0	41.8	-0.2	32.4	74
4821.250000	44.1	101.0	H	61.0	42.4	1.7	29.9	74
6279.375000	45.6	200.0	V	1.0	40.2	5.4	28.4	74
6991.250000	46.4	200.0	V	215.0	39.9	6.5	27.6	74
7713.750000	48.6	200.0	H	324.0	41.6	7.0	25.4	74

Remark: 1. Correction Factor = Antenna factor+ Insertion loss (cable loss + amplifier gain)

Frequency (MHz)	Average (dBuV/m)	Height (cm)	Polarization	Azimuth (deg)	Reading value (dBuV/m)	Correct Factor (dB)	Margin (dB)	Limit (dBuV/m)
3423.750000	29.2	100.0	V	128.0	31.1	-1.9	24.8	54
4120.000000	31.3	100.0	V	336.0	31.4	-0.1	22.7	54
4805.000000	33.3	100.0	V	276.0	31.6	1.7	20.7	54
6303.750000	35.3	100.0	V	336.0	29.9	5.4	18.7	54
7015.000000	35.9	100.0	V	166.0	29.4	6.5	18.1	54
7713.750000	43.4	200.0	H	324.0	36.4	7.0	10.6	54

Remark: 1. Correction Factor = Antenna factor+ Insertion loss (cable loss + amplifier gain)

802.11a CH165

RE 1G-3GHz PK+AV

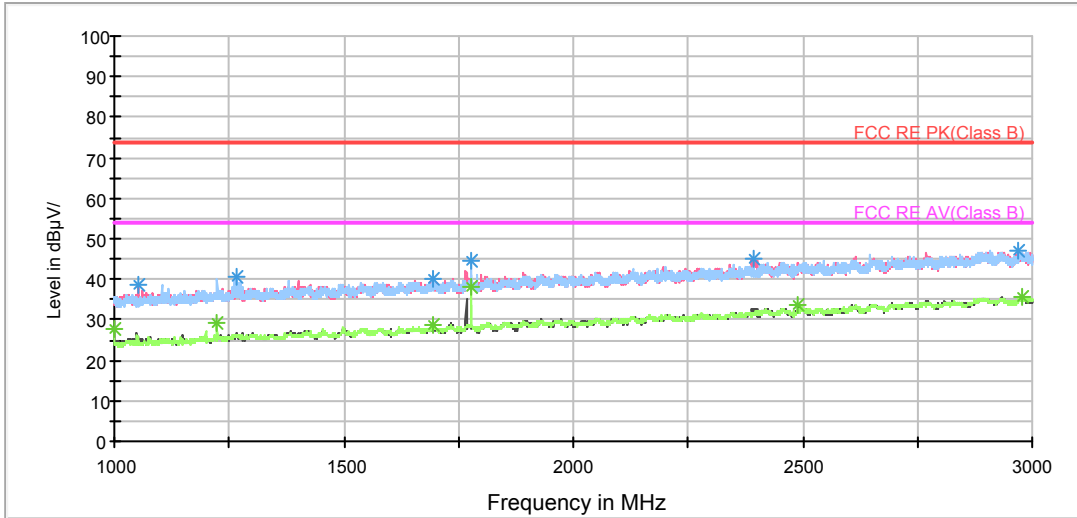

Radiates Emission from 1GHz to 3GHz

RE 3-18GHz PK+AV

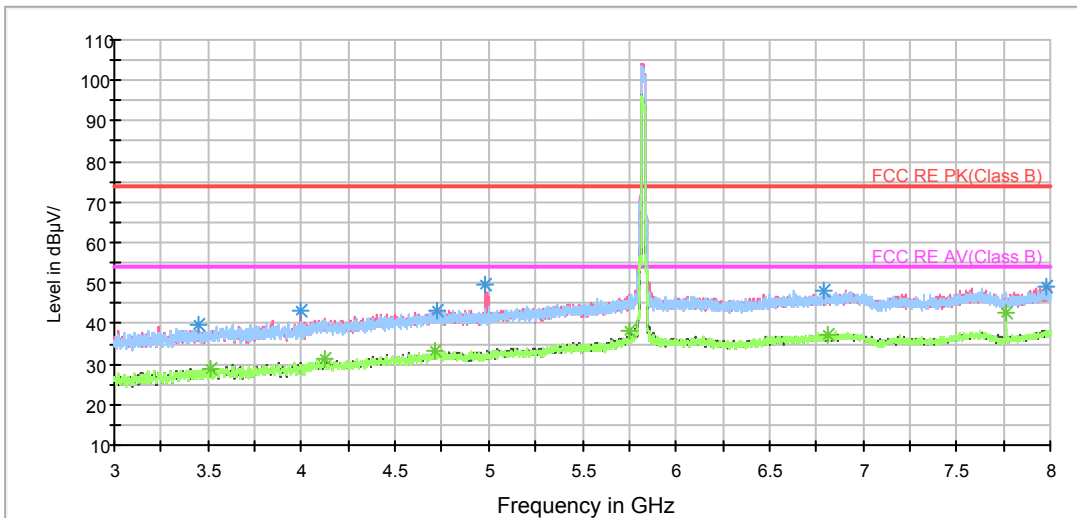

Note: The signal beyond the limit is carrier.

Radiates Emission from 3GHz to 8GHz

RE 3-18GHz PK+AV

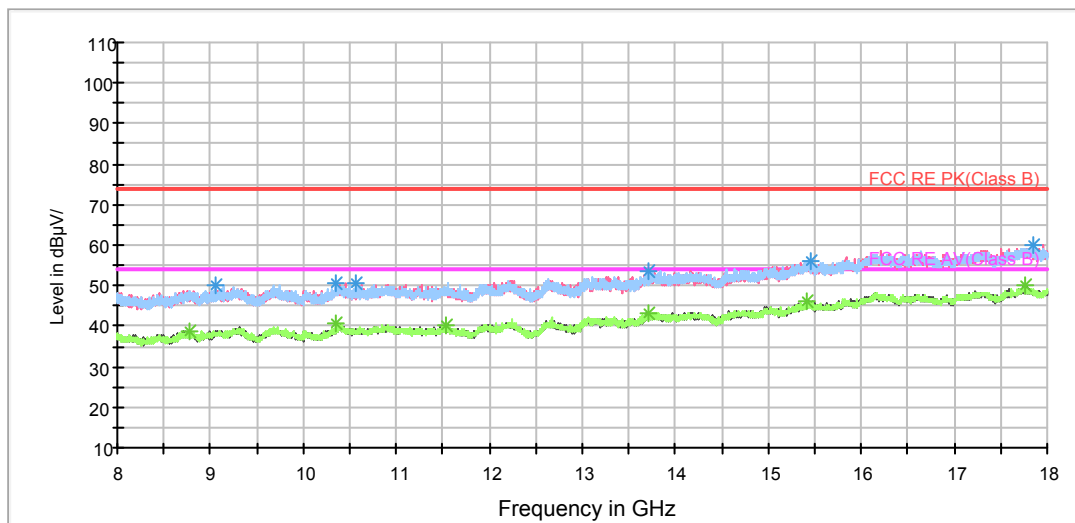

Radiates Emission from 8GHz to 18GHz

Frequency (MHz)	Peak (dBuV/m)	Height (cm)	Polarization	Azimuth (deg)	Reading value (dBuV/m)	Correct Factor (dB)	Margin (dB)	Limit (dBuV/m)
3446.875000	39.6	100.0	H	253.0	41.4	-1.8	34.4	74
3998.750000	43.2	101.0	V	338.0	43.8	-0.6	30.8	74
4723.125000	43.4	101.0	V	328.0	41.9	1.5	30.6	74
4984.375000	49.6	101.0	V	298.0	47.7	1.9	24.4	74
6785.625000	48.1	200.0	V	190.0	41.8	6.3	25.9	74
7978.750000	49.0	101.0	V	180.0	41.9	7.1	25.0	74

Remark: 1. Correction Factor = Antenna factor+ Insertion loss (cable loss + amplifier gain)

Frequency (MHz)	Average (dBuV/m)	Height (cm)	Polarization	Azimuth (deg)	Reading value (dBuV/m)	Correct Factor (dB)	Margin (dB)	Limit (dBuV/m)
3513.750000	29.0	100.0	H	94.0	30.6	-1.6	25.0	54
4120.625000	31.1	200.0	H	266.0	31.2	-0.1	22.9	54
4718.125000	33.3	200.0	H	34.0	31.8	1.5	20.7	54
5751.250000	38.3	200.0	V	239.0	33.8	4.5	15.7	54
6815.625000	37.2	200.0	V	0.0	30.9	6.3	16.8	54
7766.875000	42.6	200.0	H	335.0	35.5	7.1	11.4	54

Remark: 1. Correction Factor = Antenna factor+ Insertion loss (cable loss + amplifier gain)

802.11n (HT20) CH36

RE 1G-3GHz PK+AV

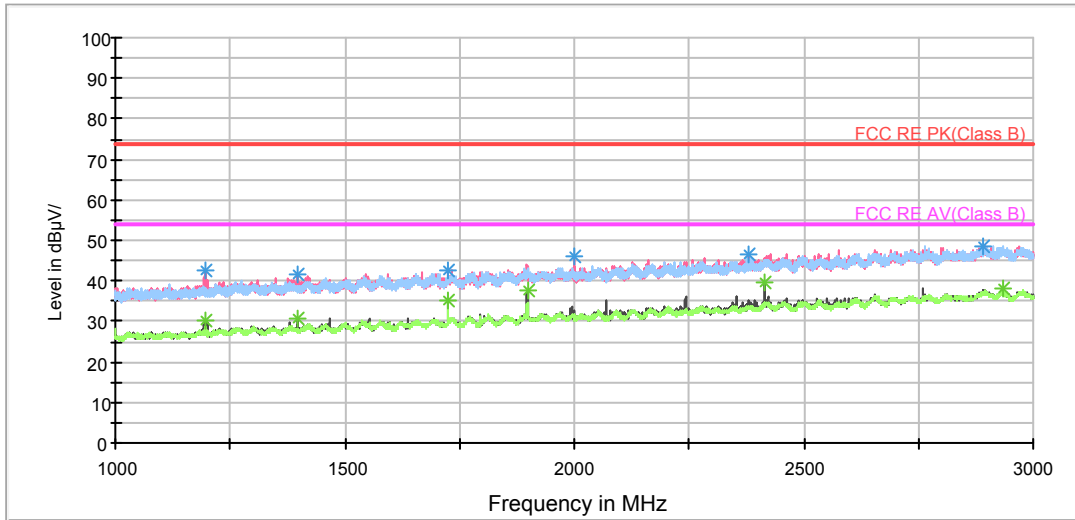

Radiates Emission from 1GHz to 3GHz

RE 3-18GHz PK+AV

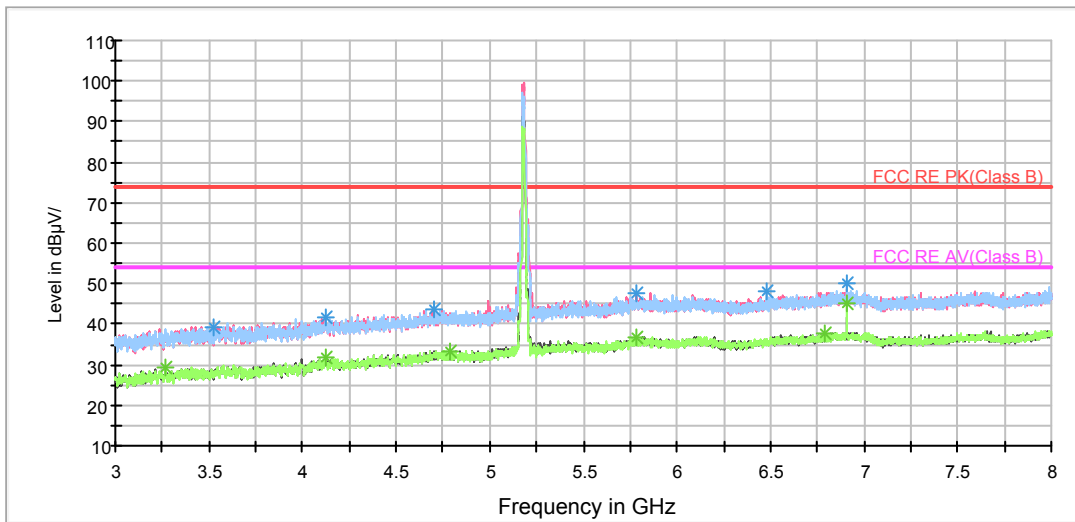

Note: The signal beyond the limit is carrier.

Radiates Emission from 3GHz to 8GHz

RE 3-18GHz PK+AV

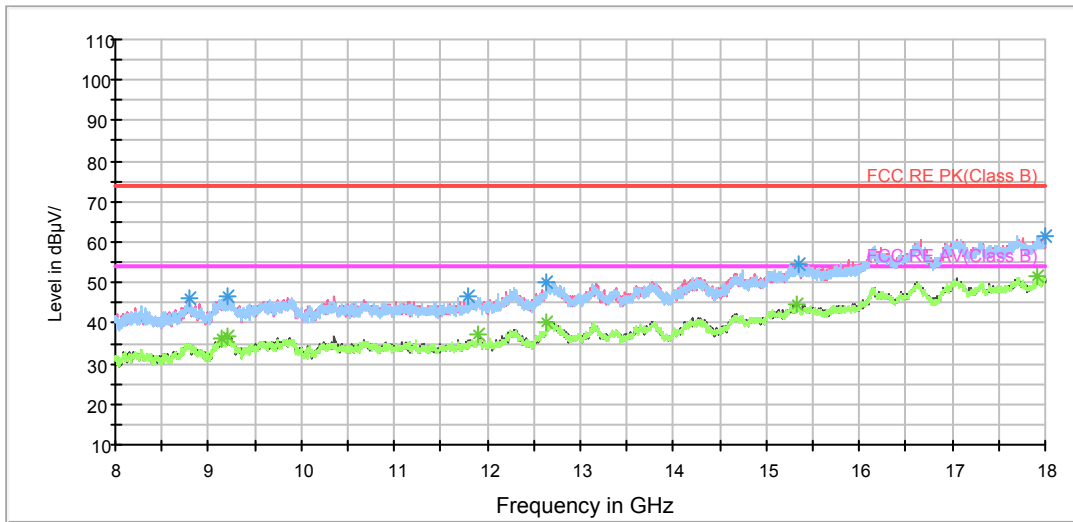

Radiates Emission from 8GHz to 18GHz

Frequency (MHz)	Peak (dBuV/m)	Height (cm)	Polarization	Azimuth (deg)	Reading value (dBuV/m)	Correct Factor (dB)	Margin (dB)	Limit (dBuV/m)
3528.125000	39.4	200.0	H	9.0	41.0	-1.6	34.6	74
4122.500000	41.5	200.0	V	313.0	41.6	-0.1	32.5	74
4698.750000	43.8	200.0	V	226.0	42.3	1.5	30.2	74
6483.125000	48.0	200.0	H	47.0	42.4	5.6	26.0	74
6906.875000	50.1	200.0	H	326.0	43.7	6.4	23.9	74
5787.500000	47.7	200.0	V	157.0	43.0	4.7	26.3	74

Remark: 1. Correction Factor = Antenna factor+ Insertion loss (cable loss + amplifier gain)

Frequency (MHz)	Average (dBuV/m)	Height (cm)	Polarization	Azimuth (deg)	Reading value (dBuV/m)	Correct Factor (dB)	Margin (dB)	Limit (dBuV/m)
3266.875000	29.2	200.0	H	351.0	31.5	-2.3	24.8	54
4120.000000	31.6	200.0	H	0.0	31.7	-0.1	22.4	54
4786.250000	33.4	200.0	V	323.0	31.8	1.6	20.6	54
6785.000000	37.6	200.0	H	67.0	31.3	6.3	16.4	54
6906.875000	45.3	200.0	H	326.0	38.9	6.4	8.7	54
5783.750000	36.7	200.0	H	77.0	32.0	4.7	17.3	54

Remark: 1. Correction Factor = Antenna factor+ Insertion loss (cable loss + amplifier gain)

802.11n (HT20) CH40

RE 1G-3GHz PK+AV

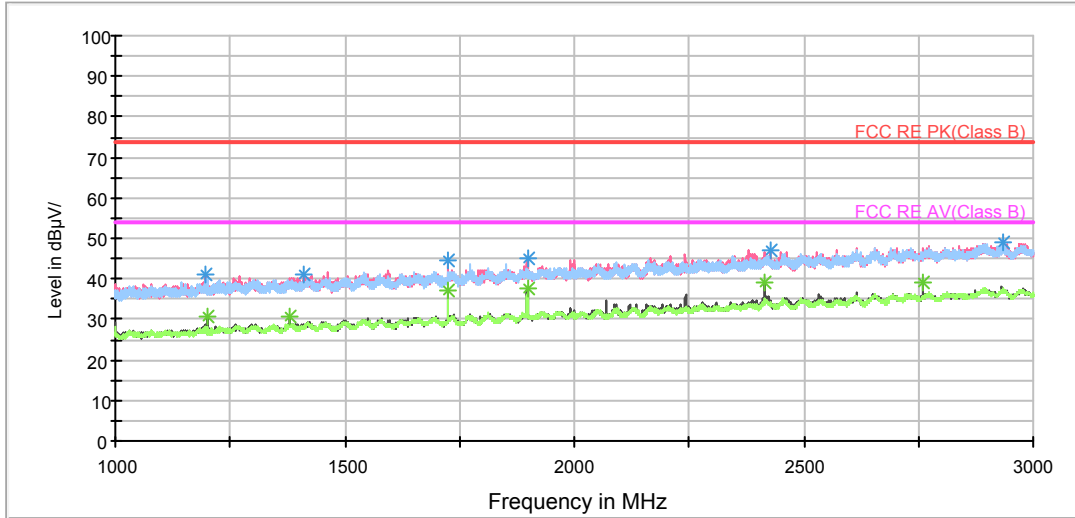

Radiates Emission from 1GHz to 3GHz

RE 3-18GHz PK+AV

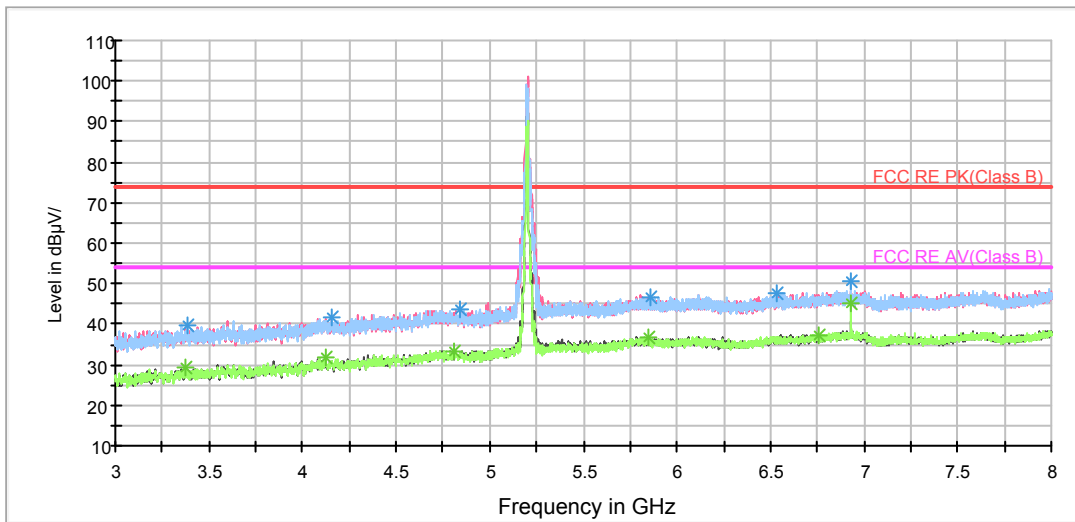

Note: The signal beyond the limit is carrier.

Radiates Emission from 3GHz to 8GHz

RE 3-18GHz PK+AV

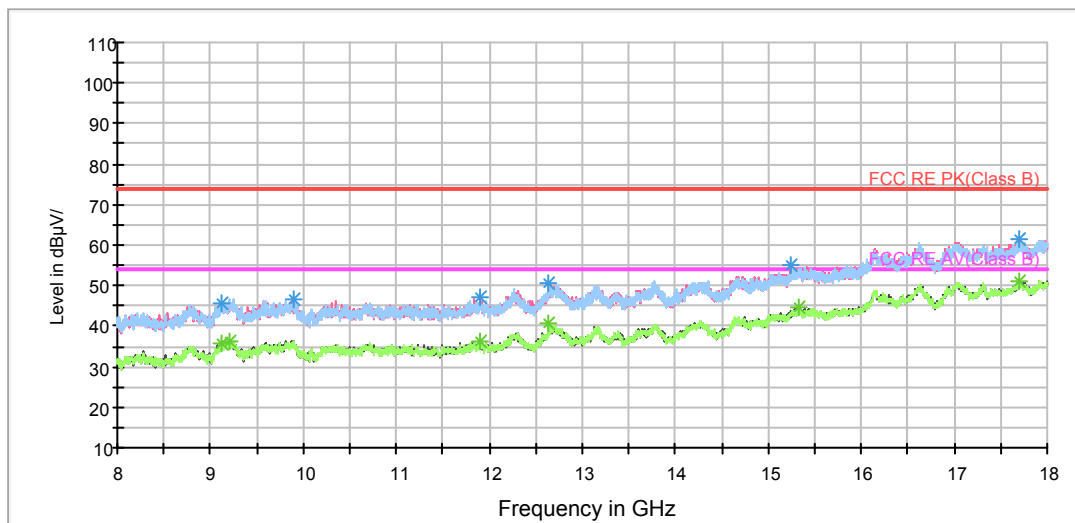

Radiates Emission from 8GHz to 18GHz

Frequency (MHz)	Peak (dBuV/m)	Height (cm)	Polarization	Azimuth (deg)	Reading value (dBuV/m)	Correct Factor (dB)	Margin (dB)	Limit (dBuV/m)
3385.000000	39.8	200.0	H	87.0	41.8	-2.0	34.2	74
4153.125000	41.7	200.0	H	284.0	41.7	0.0	32.3	74
4842.500000	43.5	200.0	H	164.0	41.8	1.7	30.5	74
6536.875000	47.7	200.0	V	196.0	42.0	5.7	26.3	74
6933.750000	50.4	200.0	H	315.0	43.9	6.5	23.6	74
5854.375000	46.6	200.0	V	314.0	41.7	4.9	27.4	74

Remark: 1. Correction Factor = Antenna factor+ Insertion loss (cable loss + amplifier gain)

Frequency (MHz)	Average (dBuV/m)	Height (cm)	Polarization	Azimuth (deg)	Reading value (dBuV/m)	Correct Factor (dB)	Margin (dB)	Limit (dBuV/m)
3372.500000	29.2	200.0	V	314.0	31.2	-2.0	24.8	54
4123.750000	31.5	200.0	V	166.0	31.6	-0.1	22.5	54
4805.000000	33.5	200.0	V	275.0	31.8	1.7	20.5	54
6761.250000	37.5	200.0	V	285.0	31.2	6.3	16.5	54
6933.750000	45.3	200.0	H	315.0	38.8	6.5	8.7	54
5847.500000	36.7	200.0	V	236.0	31.8	4.9	17.3	54

Remark: 1. Correction Factor = Antenna factor+ Insertion loss (cable loss + amplifier gain)

802.11n (HT20) CH48

RE 1G-3GHz PK+AV

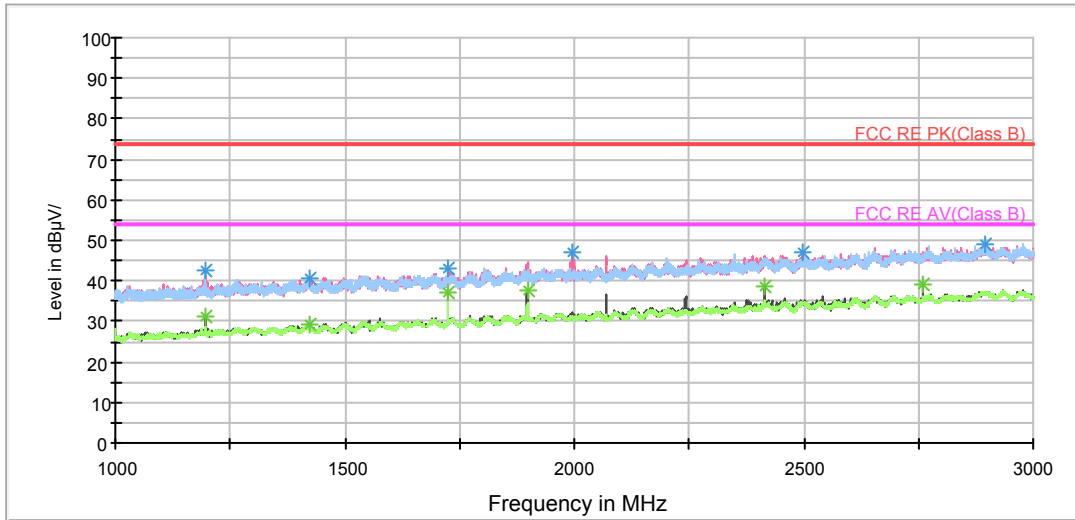

Radiates Emission from 1GHz to 3GHz

RE 3-18GHz PK+AV

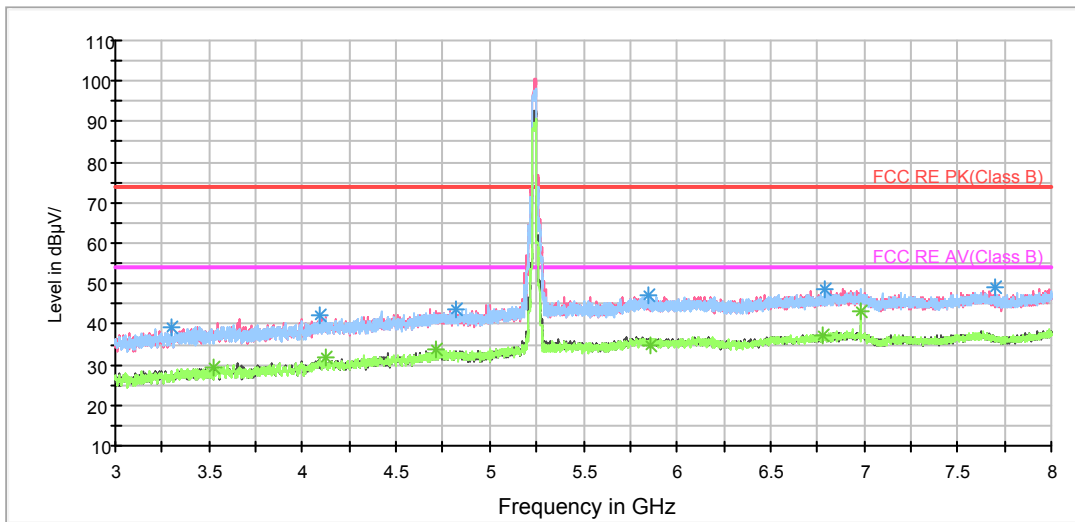

Note: The signal beyond the limit is carrier.

Radiates Emission from 3GHz to 8GHz

RE 3-18GHz PK+AV

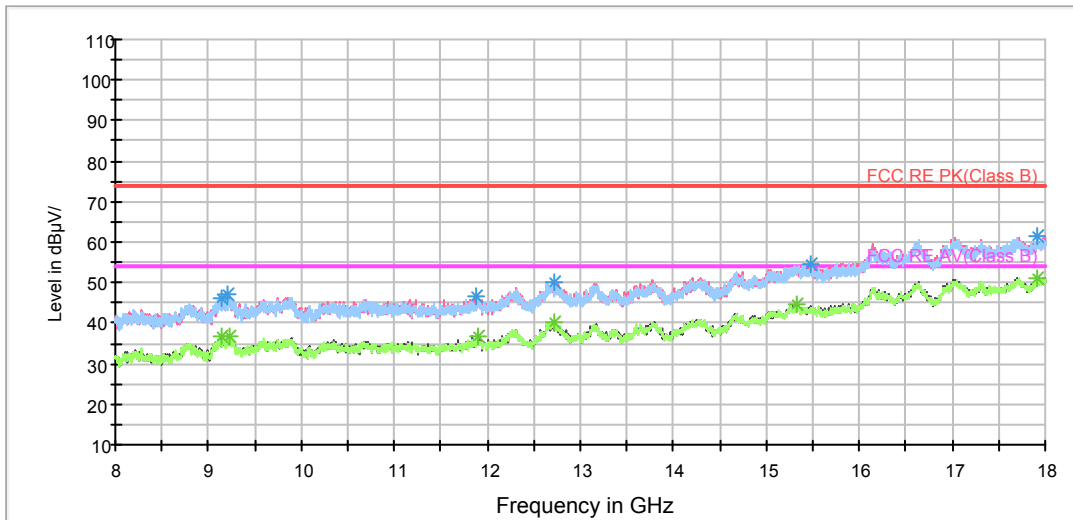

Radiates Emission from 8GHz to 18GHz

Frequency (MHz)	Peak (dBuV/m)	Height (cm)	Polarization	Azimuth (deg)	Reading value (dBuV/m)	Correct Factor (dB)	Margin (dB)	Limit (dBuV/m)
3301.875000	39.4	200.0	V	269.0	41.6	-2.2	34.6	74
4089.375000	42.0	200.0	H	72.0	42.2	-0.2	32.0	74
4820.000000	43.9	200.0	V	110.0	42.2	1.7	30.1	74
6786.250000	48.6	200.0	H	72.0	42.3	6.3	25.4	74
7700.000000	49.0	200.0	H	4.0	42.0	7.0	25.0	74
5853.125000	47.2	200.0	V	0.0	42.3	4.9	26.8	74

Remark: 1. Correction Factor = Antenna factor+ Insertion loss (cable loss + amplifier gain)

Frequency (MHz)	Average (dBuV/m)	Height (cm)	Polarization	Azimuth (deg)	Reading value (dBuV/m)	Correct Factor (dB)	Margin (dB)	Limit (dBuV/m)
3520.000000	29.1	200.0	V	355.0	30.7	-1.6	24.9	54
4120.000000	31.7	200.0	H	0.0	31.8	-0.1	22.3	54
4715.625000	33.6	200.0	H	23.0	32.1	1.5	20.4	54
6780.625000	37.4	200.0	H	305.0	31.1	6.3	16.6	54
6986.875000	43.3	200.0	H	327.0	36.8	6.5	10.7	54
5863.750000	34.9	200.0	V	210.0	30.0	4.9	19.1	54

Remark: 1. Correction Factor = Antenna factor+ Insertion loss (cable loss + amplifier gain)

802.11n (HT20) CH149

RE 1G-3GHz PK+AV

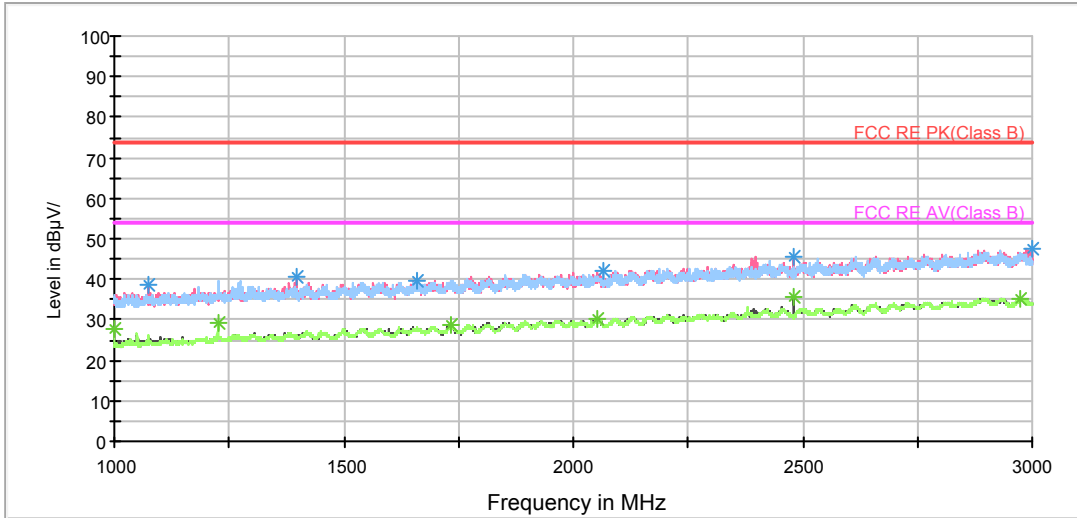

Radiates Emission from 1GHz to 3GHz

RE 3-18GHz PK+AV

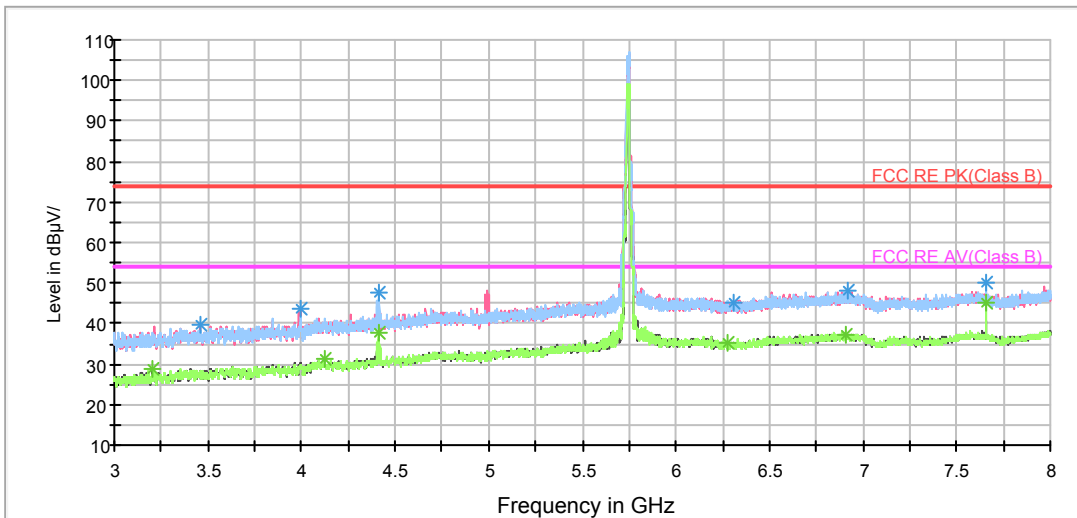

Note: The signal beyond the limit is carrier.

Radiates Emission from 3GHz to 8GHz

RE 3-18GHz PK+AV

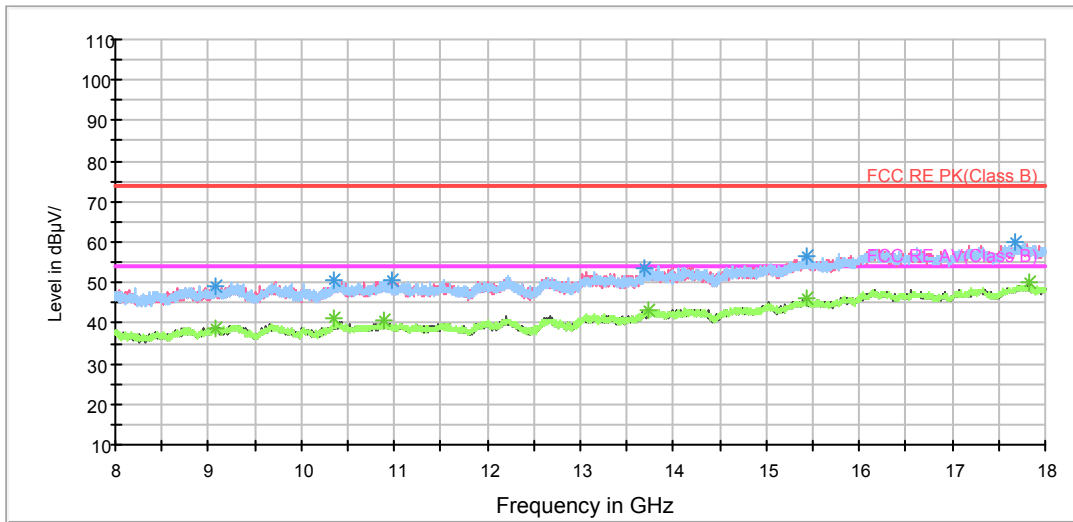

Radiates Emission from 8GHz to 18GHz

Frequency (MHz)	Peak (dBuV/m)	Height (cm)	Polarization	Azimuth (deg)	Reading value (dBuV/m)	Correct Factor (dB)	Margin (dB)	Limit (dBuV/m)
3455.625000	39.8	200.0	V	135.0	41.6	-1.8	34.2	74
3998.750000	43.5	100.0	V	345.0	44.1	-0.6	30.5	74
4415.625000	47.6	200.0	H	243.0	46.8	0.8	26.4	74
7660.000000	50.1	200.0	H	330.0	43.2	6.9	23.9	74
6303.125000	45.4	101.0	H	46.0	40.0	5.4	28.6	74
6918.750000	48.0	200.0	H	272.0	41.6	6.4	26.0	74

Remark: 1. Correction Factor = Antenna factor+ Insertion loss (cable loss + amplifier gain)

Frequency (MHz)	Average (dBuV/m)	Height (cm)	Polarization	Azimuth (deg)	Reading value (dBuV/m)	Correct Factor (dB)	Margin (dB)	Limit (dBuV/m)
3199.375000	28.9	200.0	V	2.0	31.4	-2.5	25.1	54
4123.750000	31.4	200.0	V	295.0	31.5	-0.1	22.6	54
4413.750000	37.9	200.0	H	243.0	37.1	0.8	16.1	54
7660.000000	45.3	200.0	H	330.0	38.4	6.9	8.7	54
6278.750000	35.4	101.0	H	16.0	30.0	5.4	18.6	54
6904.375000	37.1	200.0	V	2.0	30.7	6.4	16.9	54

Remark: 1. Correction Factor = Antenna factor+ Insertion loss (cable loss + amplifier gain)

802.11n (HT20) CH157

RE 1G-3GHz PK+AV

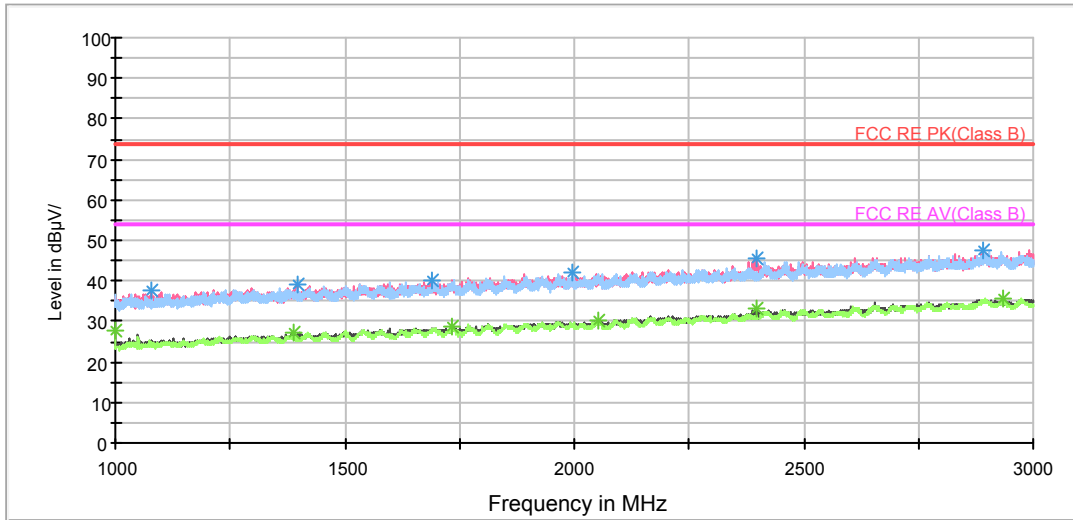

Radiates Emission from 1GHz to 3GHz

RE 3-18GHz PK+AV

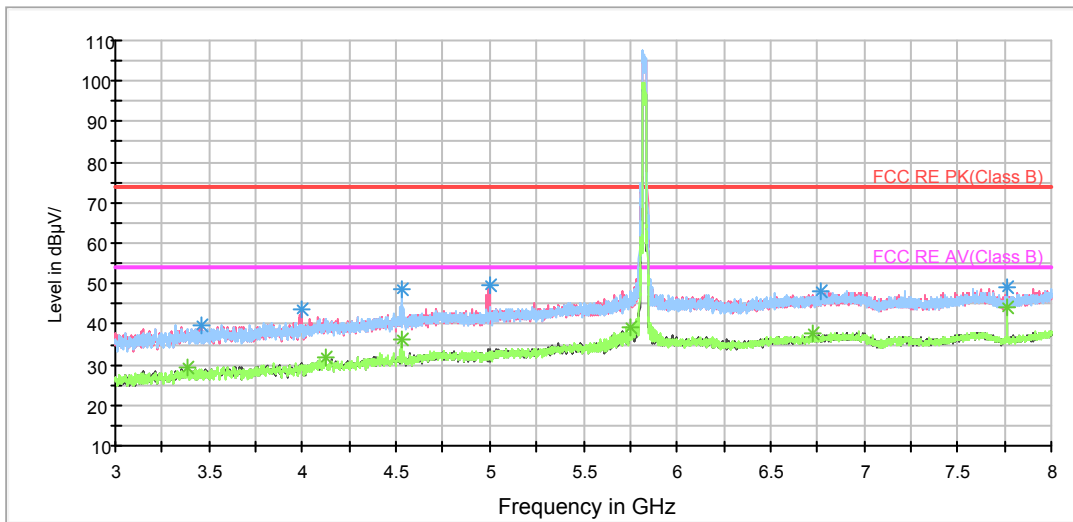

Note: The signal beyond the limit is carrier.

Radiates Emission from 3GHz to 8GHz

RE 3-18GHz PK+AV

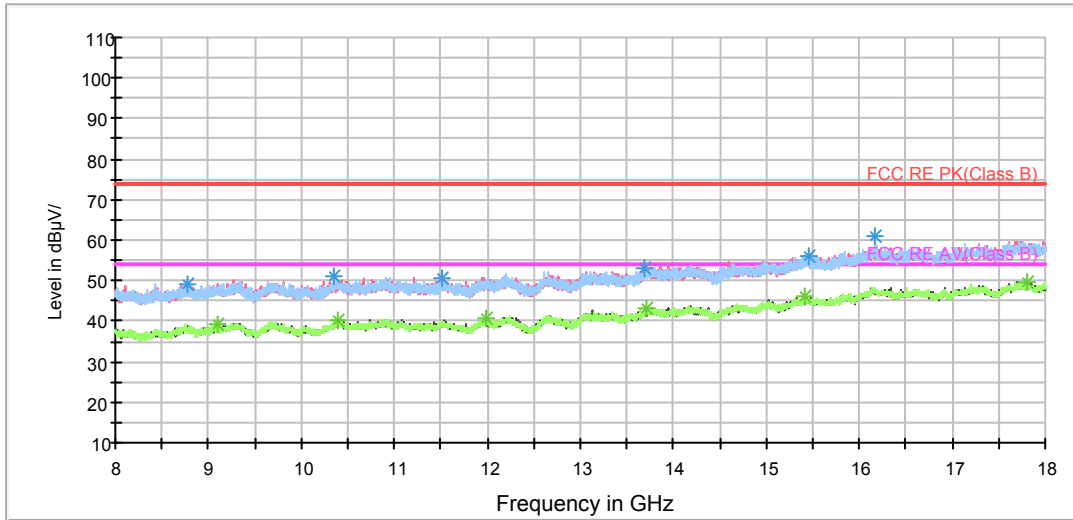

Radiates Emission from 8GHz to 18GHz

Frequency (MHz)	Peak (dBuV/m)	Height (cm)	Polarization	Azimuth (deg)	Reading value (dBuV/m)	Correct Factor (dB)	Margin (dB)	Limit (dBuV/m)
3458.750000	39.6	100.0	V	84.0	41.4	-1.8	34.4	74
3996.875000	43.6	100.0	V	338.0	44.2	-0.6	30.4	74
4527.500000	48.5	200.0	H	247.0	47.5	1.0	25.5	74
4998.125000	49.7	100.0	V	309.0	47.8	1.9	24.3	74
7766.875000	48.9	200.0	H	343.0	41.8	7.1	25.1	74
6763.750000	48.0	100.0	H	157.0	41.7	6.3	26.0	74

Remark: 1. Correction Factor = Antenna factor+ Insertion loss (cable loss + amplifier gain)

Frequency (MHz)	Average (dBuV/m)	Height (cm)	Polarization	Azimuth (deg)	Reading value (dBuV/m)	Correct Factor (dB)	Margin (dB)	Limit (dBuV/m)
3388.125000	29.2	200.0	H	266.0	31.2	-2.0	24.8	54
4121.250000	31.5	100.0	H	127.0	31.6	-0.1	22.5	54
4527.500000	36.2	200.0	H	247.0	35.2	1.0	17.8	54
5753.750000	39.2	200.0	H	247.0	34.6	4.6	14.8	54
7766.875000	44.1	200.0	H	343.0	37.0	7.1	9.9	54
6726.875000	37.7	100.0	V	309.0	31.5	6.2	16.3	54

Remark: 1. Correction Factor = Antenna factor+ Insertion loss (cable loss + amplifier gain)

802.11n (HT20) CH165

RE 1G-3GHz PK+AV

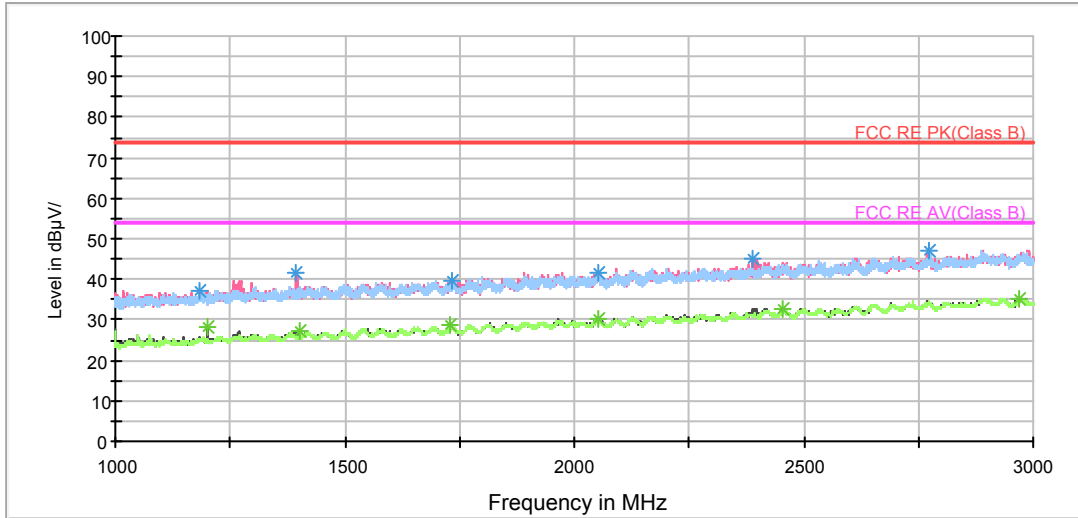

Radiates Emission from 1GHz to 3GHz

RE 3-18GHz PK+AV

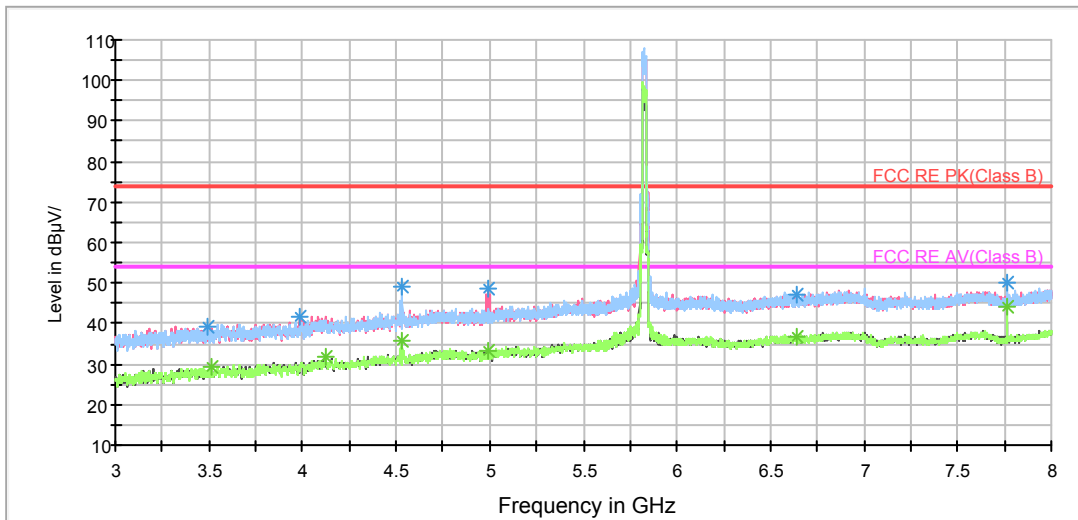

Note: The signal beyond the limit is carrier.

Radiates Emission from 3GHz to 8GHz

RE 3-18GHz PK+AV

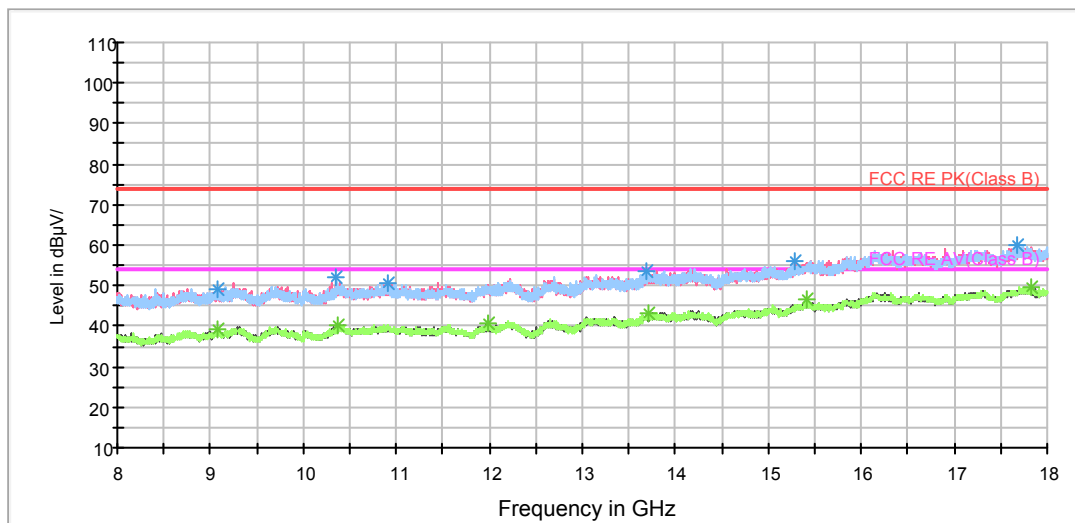

Radiates Emission from 8GHz to 18GHz

Frequency (MHz)	Peak (dBuV/m)	Height (cm)	Polarization	Azimuth (deg)	Reading value (dBuV/m)	Correct Factor (dB)	Margin (dB)	Limit (dBuV/m)
3494.375000	39.2	200.0	H	294.0	40.9	-1.7	34.8	74
3982.500000	41.8	100.0	V	0.0	42.5	-0.7	32.2	74
4528.125000	49.0	200.0	H	245.0	48.0	1.0	25.0	74
4993.750000	48.7	100.0	V	308.0	46.8	1.9	25.3	74
7766.875000	50.2	200.0	H	322.0	43.1	7.1	23.8	74
6641.250000	47.0	200.0	V	0.0	41.0	6.0	27.0	74

Remark: 1. Correction Factor = Antenna factor+ Insertion loss (cable loss + amplifier gain)

Frequency (MHz)	Average (dBuV/m)	Height (cm)	Polarization	Azimuth (deg)	Reading value (dBuV/m)	Correct Factor (dB)	Margin (dB)	Limit (dBuV/m)
3513.125000	29.1	100.0	H	176.0	30.7	-1.6	24.9	54
4120.625000	32.0	100.0	V	280.0	32.1	-0.1	22.0	54
4526.875000	35.8	200.0	H	245.0	34.8	1.0	18.2	54
7766.875000	44.3	200.0	H	322.0	37.2	7.1	9.7	54
4995.625000	33.4	100.0	H	156.0	31.5	1.9	20.6	54
6640.625000	36.6	100.0	V	280.0	30.6	6.0	17.4	54

Remark: 1. Correction Factor = Antenna factor+ Insertion loss (cable loss + amplifier gain)

802.11n (HT40) CH38

RE 1G-3GHz PK+AV

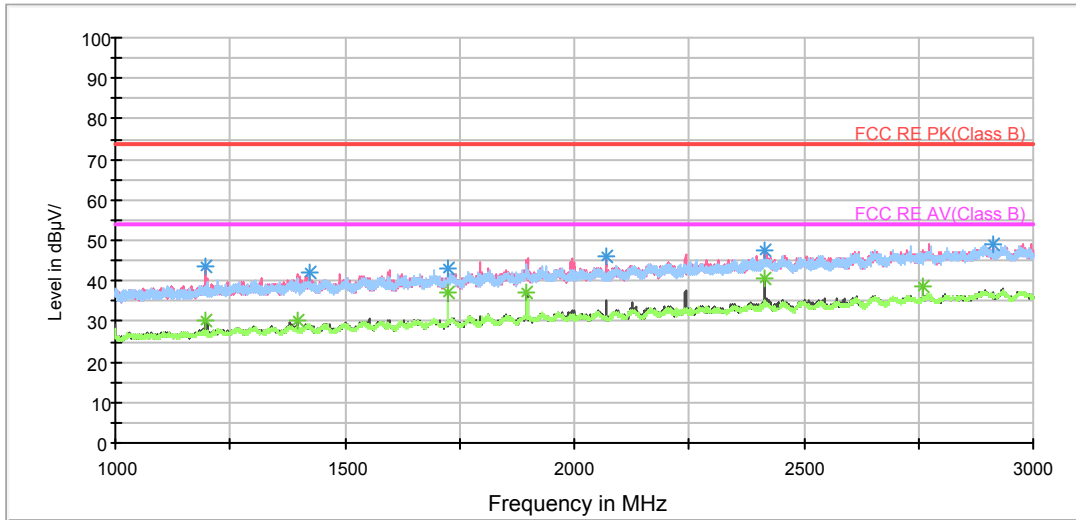

Radiates Emission from 1GHz to 3GHz

RE 3-18GHz PK+AV

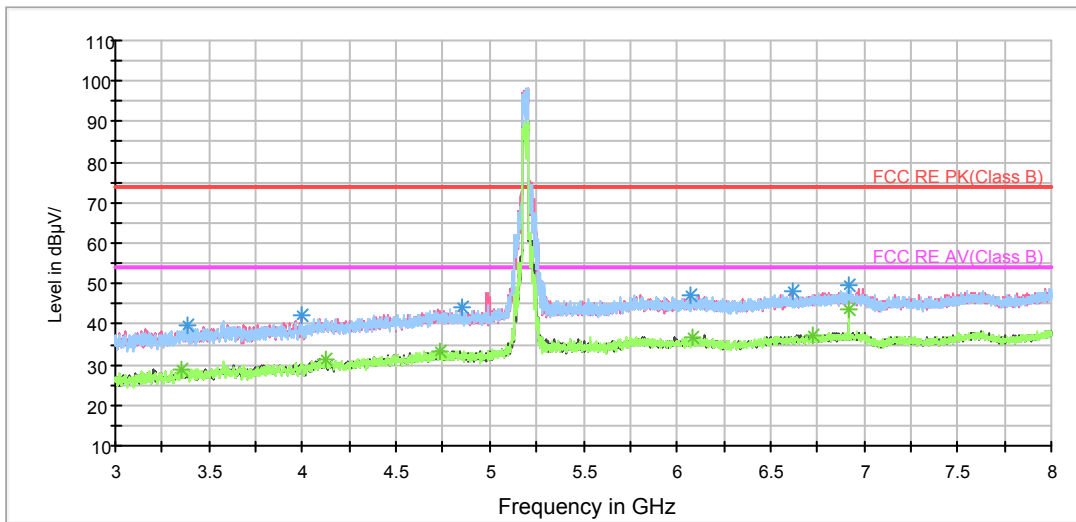

Note: The signal beyond the limit is carrier.

Radiates Emission from 3GHz to 8GHz

RE 3-18GHz PK+AV

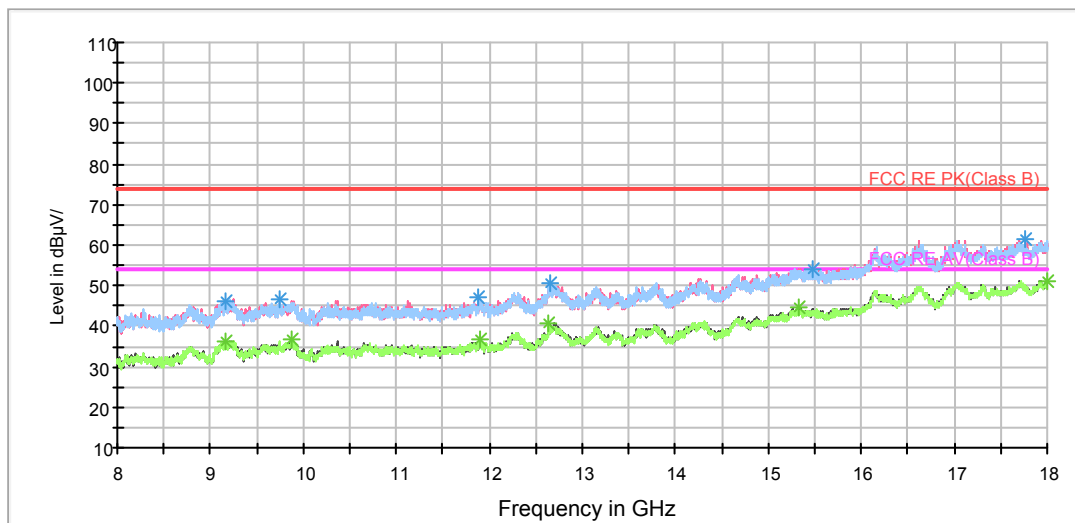

Radiates Emission from 8GHz to 18GHz

Frequency (MHz)	Peak (dBuV/m)	Height (cm)	Polarization	Azimuth (deg)	Reading value (dBuV/m)	Correct Factor (dB)	Margin (dB)	Limit (dBuV/m)
3387.500000	39.8	200.0	V	98.0	41.8	-2.0	34.2	74
3996.875000	42.1	100.0	V	0.0	42.7	-0.6	31.9	74
4854.375000	43.9	200.0	H	134.0	42.2	1.7	30.1	74
6623.125000	47.9	100.0	V	357.0	41.9	6.0	26.1	74
6920.625000	49.7	200.0	H	329.0	43.3	6.4	24.3	74
6067.500000	47.3	100.0	V	222.0	42.1	5.2	26.7	74

Remark: 1. Correction Factor = Antenna factor+ Insertion loss (cable loss + amplifier gain)

Frequency (MHz)	Average (dBuV/m)	Height (cm)	Polarization	Azimuth (deg)	Reading value (dBuV/m)	Correct Factor (dB)	Margin (dB)	Limit (dBuV/m)
3353.750000	28.9	200.0	V	274.0	31.0	-2.1	25.1	54
4121.875000	31.4	200.0	H	329.0	31.5	-0.1	22.6	54
4734.375000	33.5	200.0	H	202.0	32.0	1.5	20.5	54
6725.625000	37.4	100.0	H	0.0	31.2	6.2	16.6	54
6920.000000	43.7	200.0	H	320.0	37.3	6.4	10.3	54
6088.125000	36.6	200.0	V	0.0	31.4	5.2	17.4	54

Remark: 1. Correction Factor = Antenna factor+ Insertion loss (cable loss + amplifier gain)

802.11n (HT40) CH46

RE 1G-3GHz PK+AV

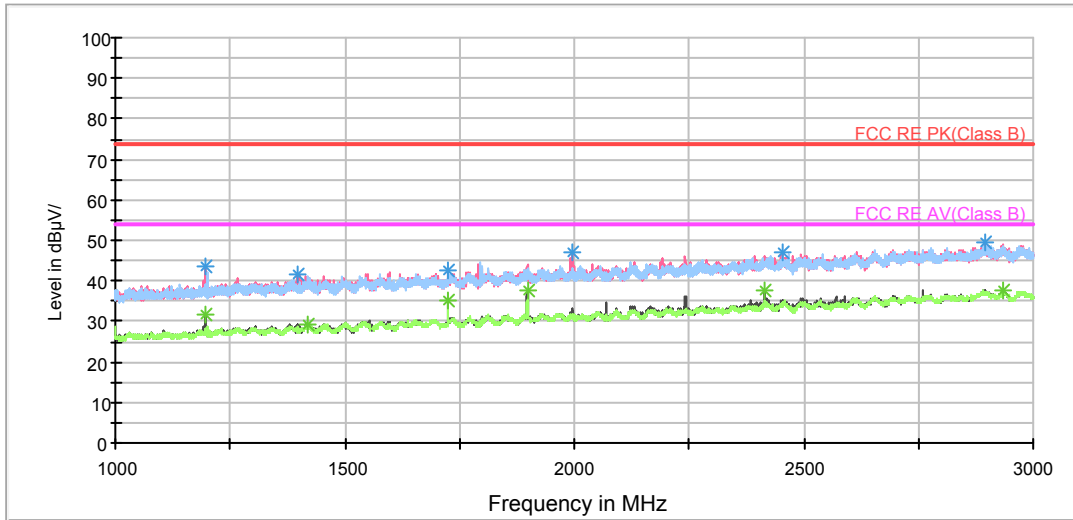

Radiates Emission from 1GHz to 3GHz

RE 3-18GHz PK+AV

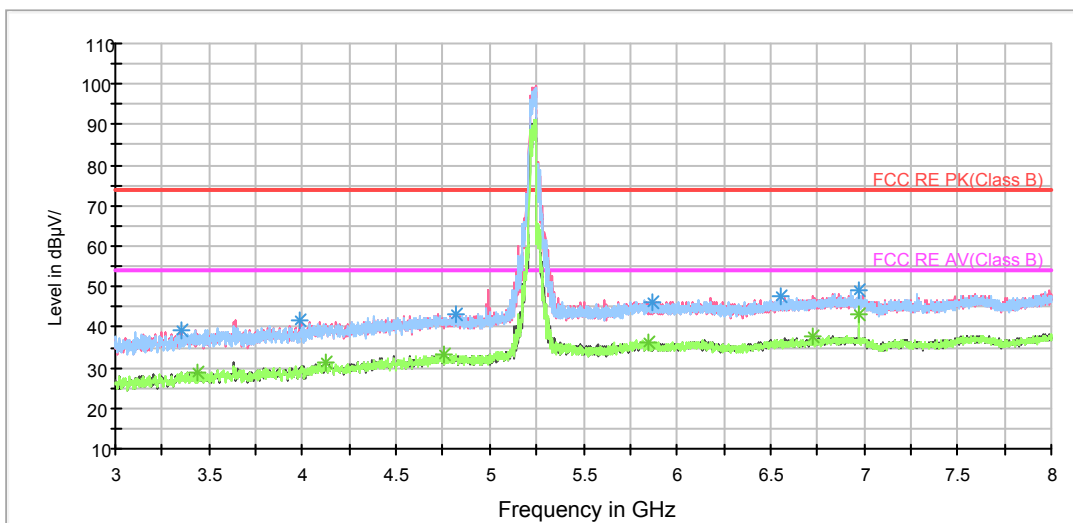

Note: The signal beyond the limit is carrier.

Radiates Emission from 3GHz to 8GHz

RE 3-18GHz PK+AV

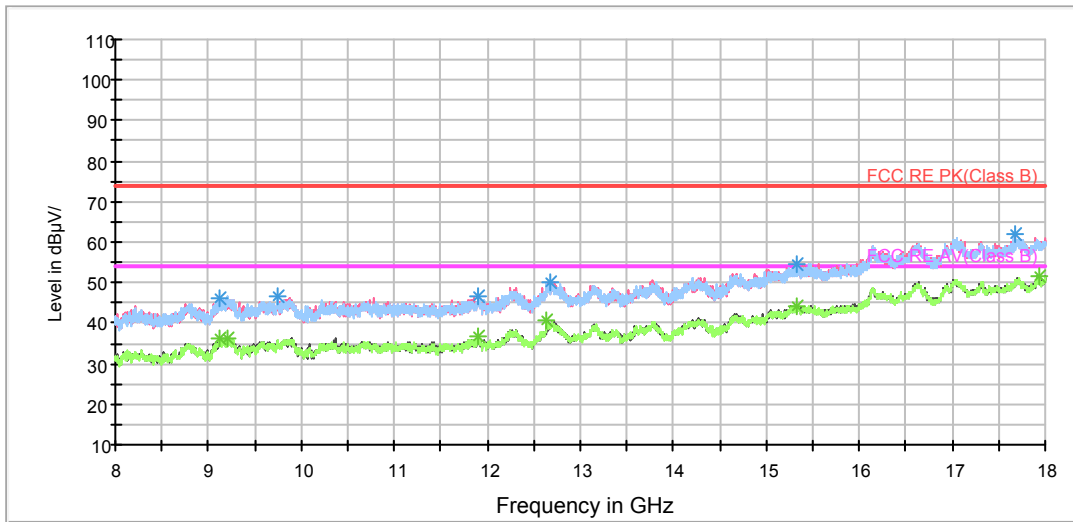

Radiates Emission from 8GHz to 18GHz

Frequency (MHz)	Peak (dBuV/m)	Height (cm)	Polarization	Azimuth (deg)	Reading value (dBuV/m)	Correct Factor (dB)	Margin (dB)	Limit (dBuV/m)
3355.625000	39.5	100.0	V	343.0	41.6	-2.1	34.5	74
3990.000000	41.7	100.0	V	343.0	42.3	-0.6	32.3	74
4818.125000	43.1	200.0	V	165.0	41.4	1.7	30.9	74
6551.875000	47.4	100.0	V	0.0	41.6	5.8	26.6	74
6973.750000	49.1	200.0	H	322.0	42.6	6.5	24.9	74
5874.375000	46.1	200.0	V	77.0	41.2	4.9	27.9	74

Remark: 1. Correction Factor = Antenna factor+ Insertion loss (cable loss + amplifier gain)

Frequency (MHz)	Average (dBuV/m)	Height (cm)	Polarization	Azimuth (deg)	Reading value (dBuV/m)	Correct Factor (dB)	Margin (dB)	Limit (dBuV/m)
3443.750000	28.9	200.0	H	263.0	30.7	-1.8	25.1	54
4123.750000	31.3	100.0	H	84.0	31.4	-0.1	22.7	54
4751.250000	33.2	200.0	V	0.0	31.6	1.6	20.8	54
6730.000000	37.6	200.0	H	342.0	31.3	6.3	16.4	54
6973.750000	43.4	200.0	H	322.0	36.9	6.5	10.6	54
5852.500000	36.3	100.0	H	136.0	31.4	4.9	17.7	54

Remark: 1. Correction Factor = Antenna factor+ Insertion loss (cable loss + amplifier gain)

802.11n (HT40) CH151

RE 1G-3GHz PK+AV

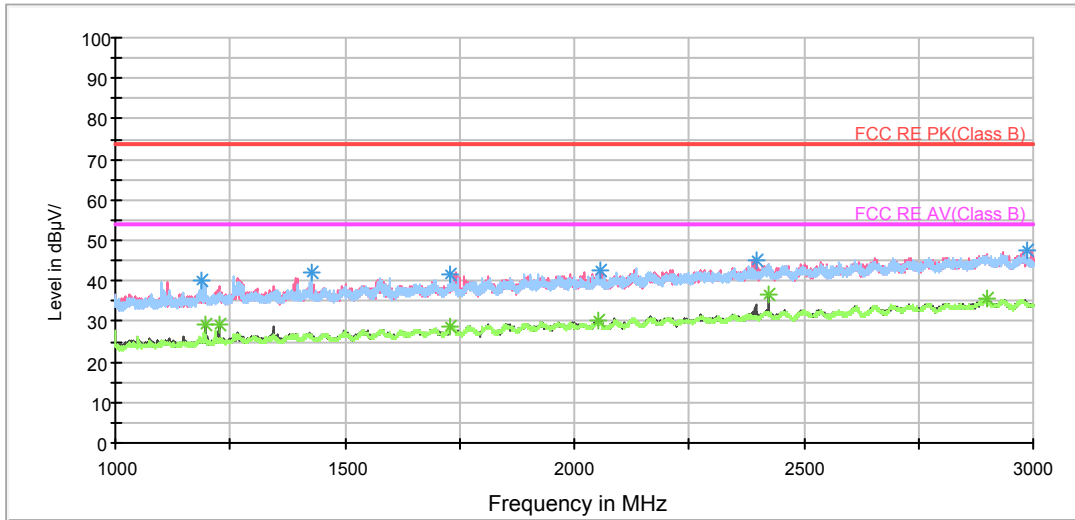

Radiates Emission from 1GHz to 3GHz

RE 3-18GHz PK+AV

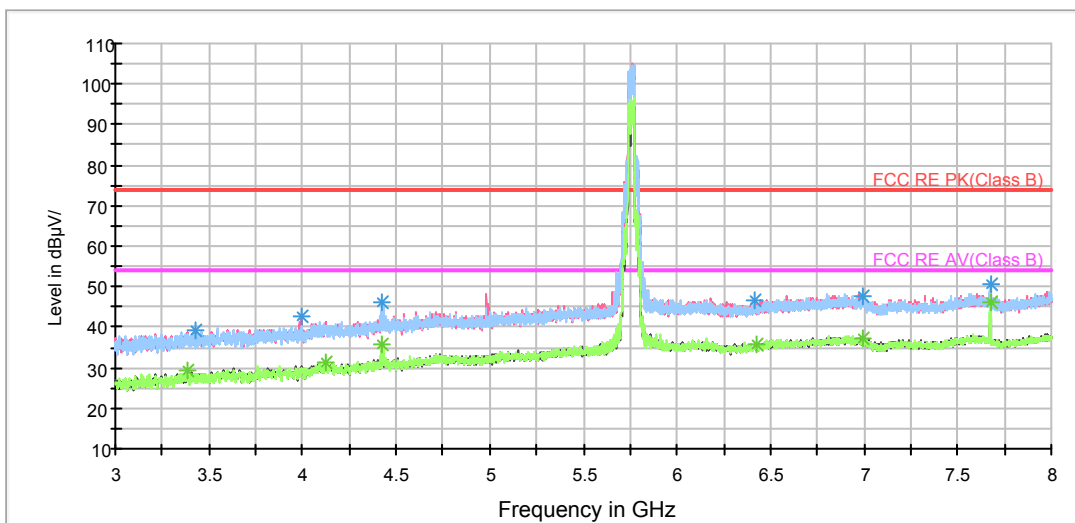

Note: The signal beyond the limit is carrier.

Radiates Emission from 3GHz to 8GHz

RE 3-18GHz PK+AV

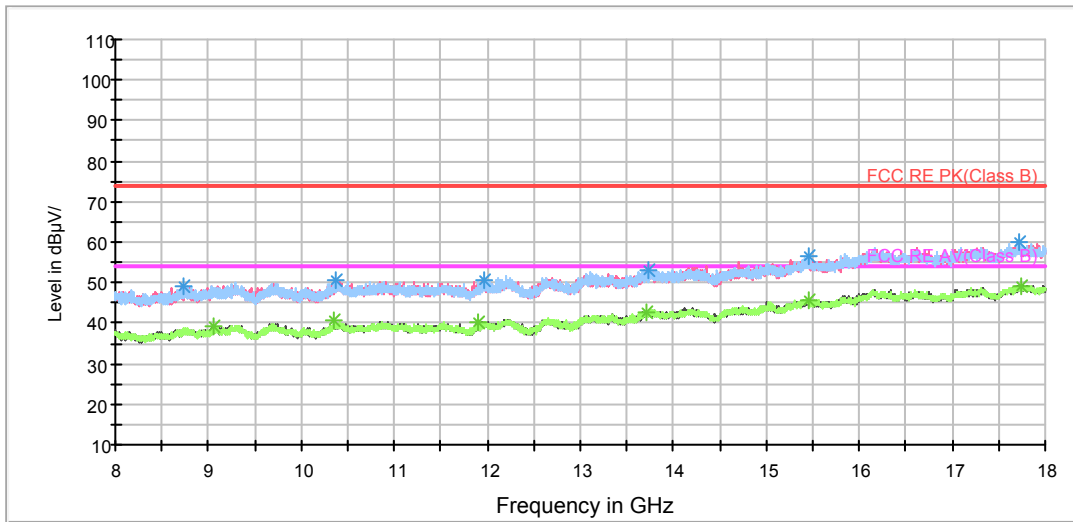

Radiates Emission from 8GHz to 18GHz

Frequency (MHz)	Peak (dBuV/m)	Height (cm)	Polarization	Azimuth (deg)	Reading value (dBuV/m)	Correct Factor (dB)	Margin (dB)	Limit (dBuV/m)
3423.750000	39.3	100.0	V	273.0	41.2	-1.9	34.7	74
3996.250000	42.9	100.0	V	353.0	43.5	-0.6	31.1	74
4422.500000	46.2	200.0	H	245.0	45.4	0.8	27.8	74
7673.750000	50.6	200.0	H	345.0	43.7	6.9	23.4	74
6419.375000	46.6	200.0	V	0.0	41.1	5.5	27.4	74
6995.625000	47.5	100.0	V	283.0	41.0	6.5	26.5	74

Remark: 1. Correction Factor = Antenna factor+ Insertion loss (cable loss + amplifier gain)

Frequency (MHz)	Average (dBuV/m)	Height (cm)	Polarization	Azimuth (deg)	Reading value (dBuV/m)	Correct Factor (dB)	Margin (dB)	Limit (dBuV/m)
3388.750000	29.3	100.0	H	113.0	31.3	-2.0	24.7	54
4123.125000	31.3	200.0	H	306.0	31.4	-0.1	22.7	54
4428.750000	35.9	200.0	H	245.0	35.1	0.8	18.1	54
7673.750000	46.1	200.0	H	345.0	39.2	6.9	7.9	54
6431.250000	35.6	100.0	V	235.0	30.1	5.5	18.4	54
6994.375000	37.2	100.0	V	147.0	30.7	6.5	16.8	54

Remark: 1. Correction Factor = Antenna factor+ Insertion loss (cable loss + amplifier gain)

802.11n (HT40) CH159

RE 1G-3GHz PK+AV

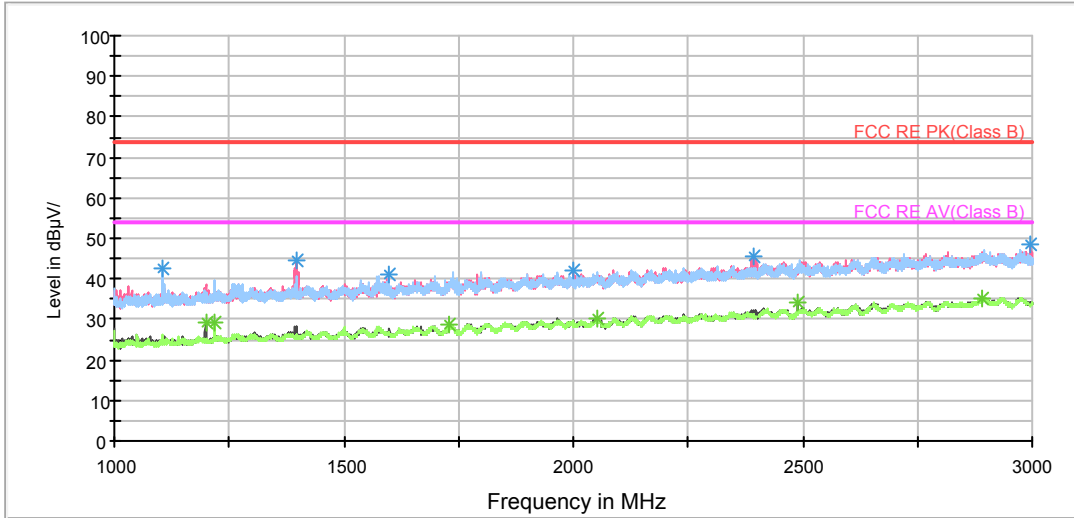

Radiates Emission from 1GHz to 3GHz

RE 3-18GHz PK+AV

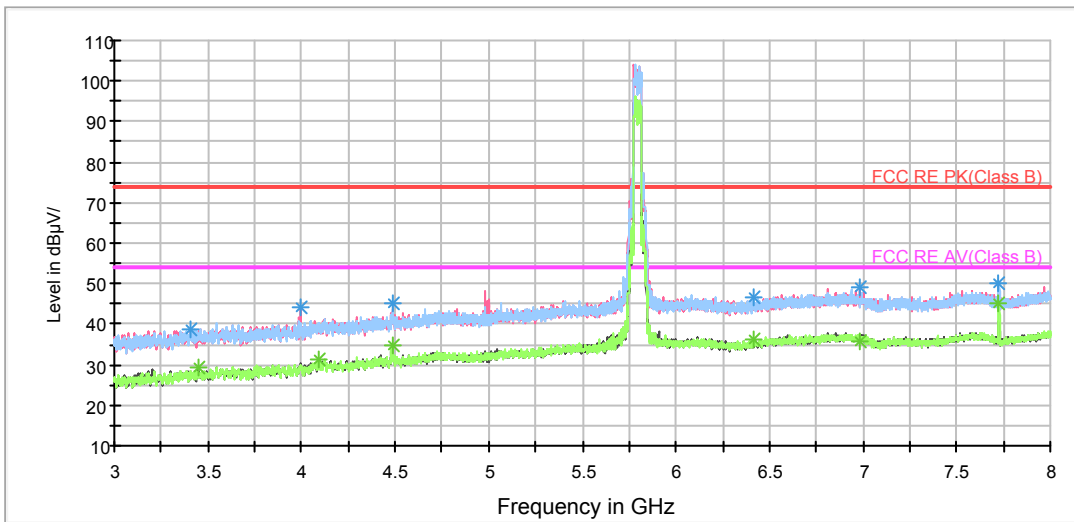

Note: The signal beyond the limit is carrier.

Radiates Emission from 3GHz to 8GHz

RE 3-18GHz PK+AV

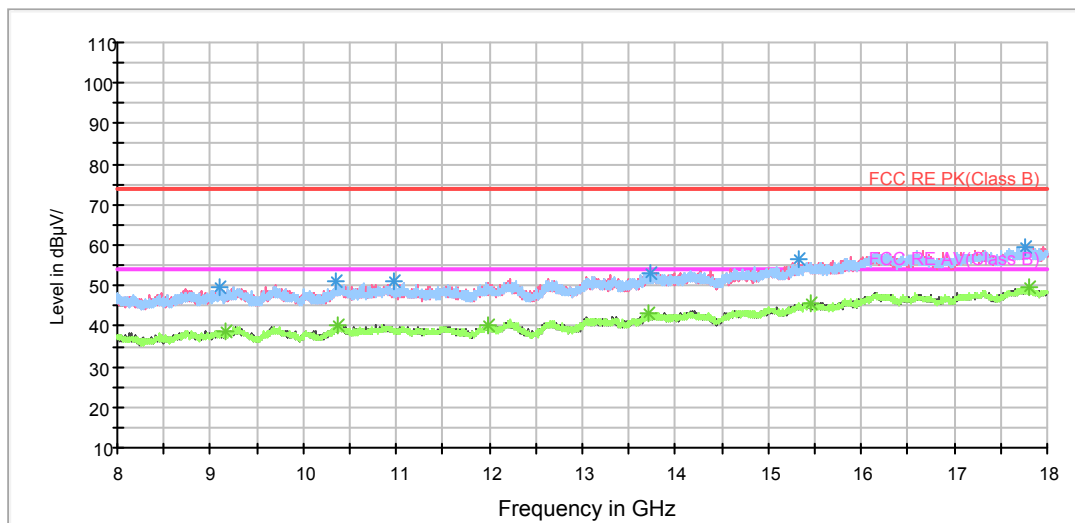

Radiates Emission from 8GHz to 18GHz

Frequency (MHz)	Peak (dBuV/m)	Height (cm)	Polarization	Azimuth (deg)	Reading value (dBuV/m)	Correct Factor (dB)	Margin (dB)	Limit (dBuV/m)
3408.125000	38.9	100.0	V	254.0	40.8	-1.9	35.1	74
3998.750000	44.2	100.0	V	350.0	44.8	-0.6	29.8	74
4486.875000	45.4	200.0	H	247.0	44.4	1.0	28.6	74
7726.875000	49.9	200.0	H	344.0	42.9	7.0	24.1	74
6417.500000	46.6	200.0	H	275.0	41.1	5.5	27.4	74
6987.500000	49.2	100.0	V	55.0	42.7	6.5	24.8	74

Remark: 1. Correction Factor = Antenna factor+ Insertion loss (cable loss + amplifier gain)

Frequency (MHz)	Average (dBuV/m)	Height (cm)	Polarization	Azimuth (deg)	Reading value (dBuV/m)	Correct Factor (dB)	Margin (dB)	Limit (dBuV/m)
3444.375000	29.2	100.0	V	22.0	31.0	-1.8	24.8	54
4088.750000	31.3	200.0	V	305.0	31.5	-0.2	22.7	54
4486.875000	34.9	200.0	H	247.0	33.9	1.0	19.1	54
7726.875000	45.0	200.0	H	344.0	38.0	7.0	9.0	54
6411.875000	36.0	100.0	V	234.0	30.5	5.5	18.0	54
6982.500000	35.5	100.0	V	322.0	29.0	6.5	18.5	54

Remark: 1. Correction Factor = Antenna factor+ Insertion loss (cable loss + amplifier gain)

802.11ac (HT80) CH42

RE 1G-3GHz PK+AV

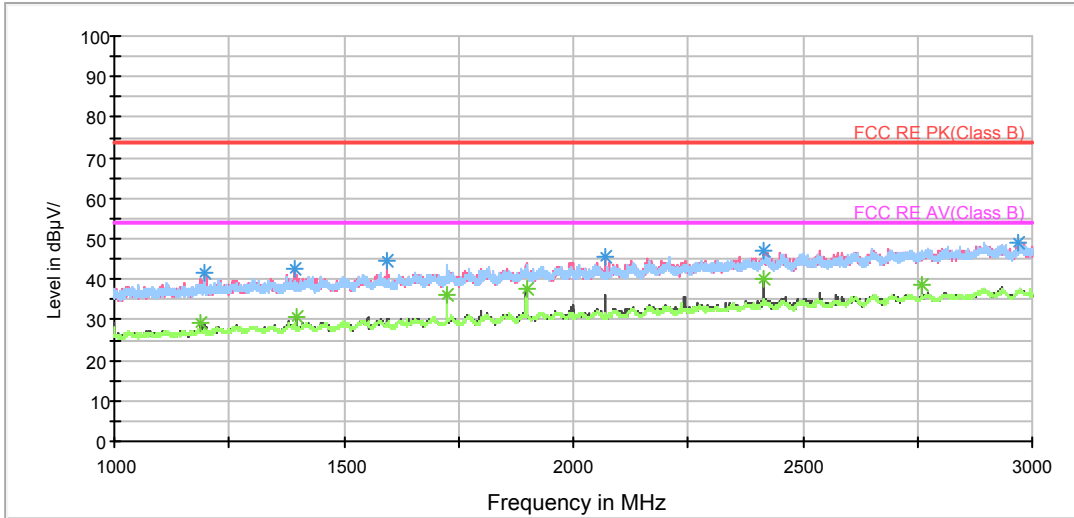

Radiates Emission from 1GHz to 3GHz

RE 3-18GHz PK+AV

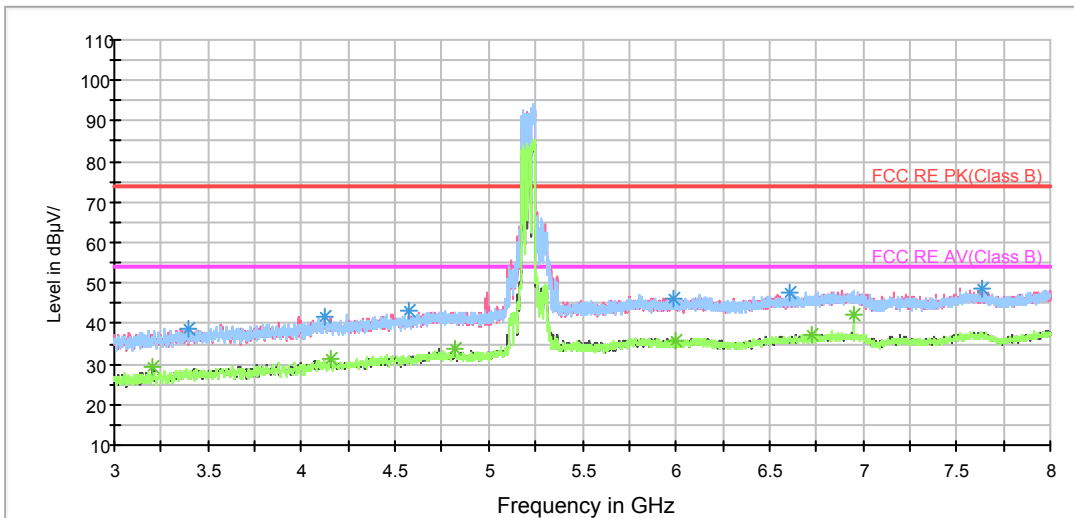

Note: The signal beyond the limit is carrier.

Radiates Emission from 3GHz to 8GHz

RE 3-18GHz PK+AV

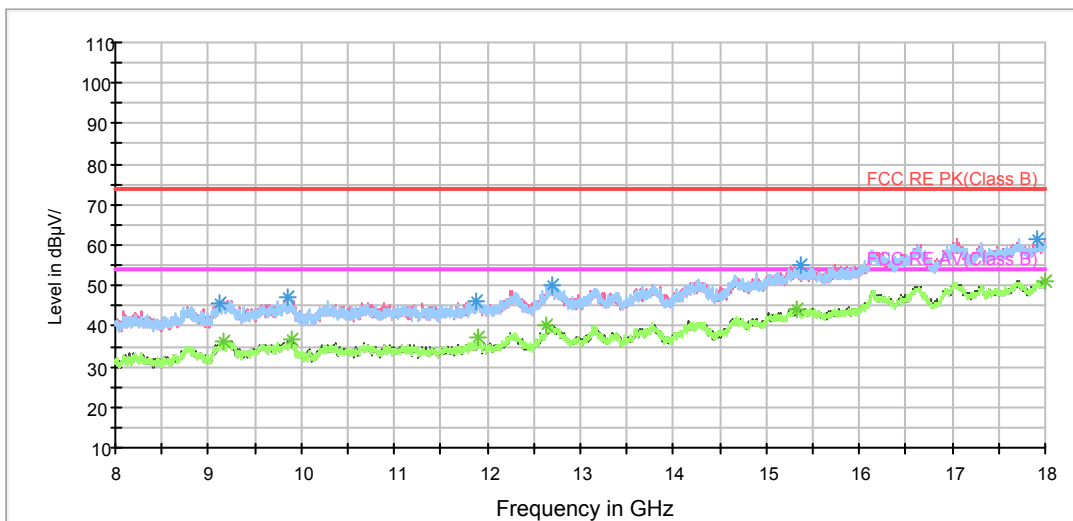

Radiates Emission from 8GHz to 18GHz

Frequency (MHz)	Peak (dBuV/m)	Height (cm)	Polarization	Azimuth (deg)	Reading value (dBuV/m)	Correct Factor (dB)	Margin (dB)	Limit (dBuV/m)
3393.125000	38.7	100.0	H	0.0	40.7	-2.0	35.3	74
4123.125000	41.9	200.0	V	77.0	42.0	-0.1	32.1	74
4575.625000	43.4	200.0	V	16.0	42.2	1.2	30.6	74
6608.125000	47.8	200.0	H	107.0	41.9	5.9	26.2	74
7636.875000	48.4	200.0	H	217.0	41.6	6.8	25.6	74
5988.125000	46.0	200.0	H	327.0	40.8	5.2	28.0	74

Remark: 1. Correction Factor = Antenna factor+ Insertion loss (cable loss + amplifier gain)

Frequency (MHz)	Average (dBuV/m)	Height (cm)	Polarization	Azimuth (deg)	Reading value (dBuV/m)	Correct Factor (dB)	Margin (dB)	Limit (dBuV/m)
3199.375000	29.2	100.0	V	0.0	31.7	-2.5	24.8	54
4158.125000	31.1	100.0	V	237.0	31.0	0.1	22.9	54
4820.625000	33.7	100.0	H	275.0	32.0	1.7	20.3	54
6730.625000	37.3	100.0	V	266.0	31.0	6.3	16.7	54
6946.875000	42.3	200.0	H	318.0	35.8	6.5	11.7	54
5998.750000	35.5	200.0	V	64.0	30.2	5.3	18.5	54

Remark: 1. Correction Factor = Antenna factor+ Insertion loss (cable loss + amplifier gain)

802.11ac (HT80) CH155

RE 1G-3GHz PK+AV

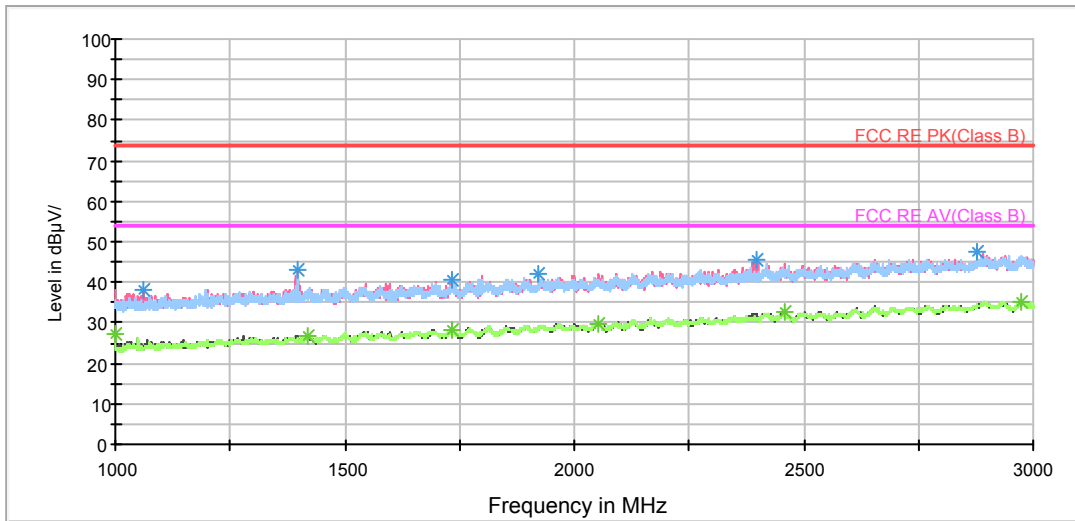

Radiates Emission from 1GHz to 3GHz

RE 3-18GHz PK+AV

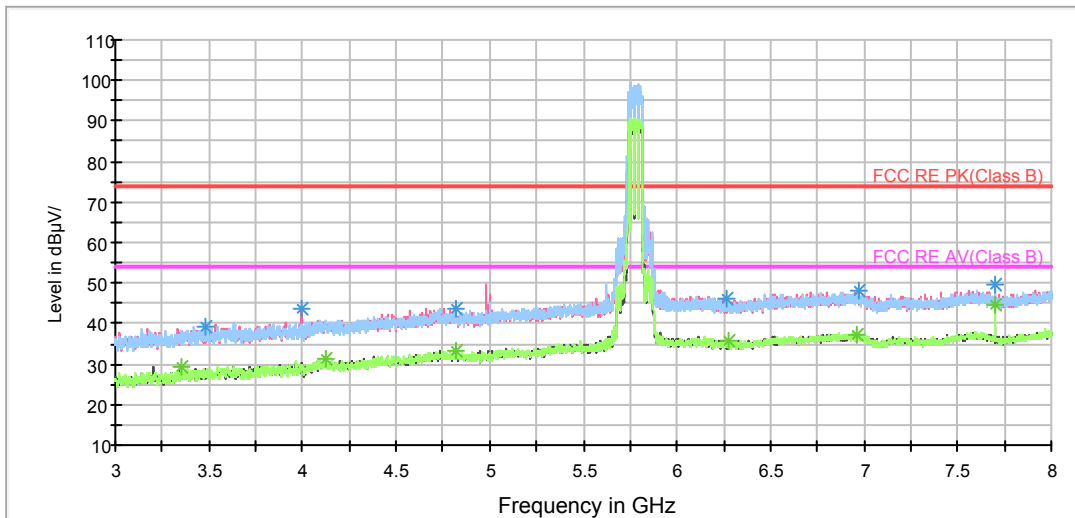

Note: The signal beyond the limit is carrier.

Radiates Emission from 3GHz to 8GHz

RE 3-18GHz PK+AV

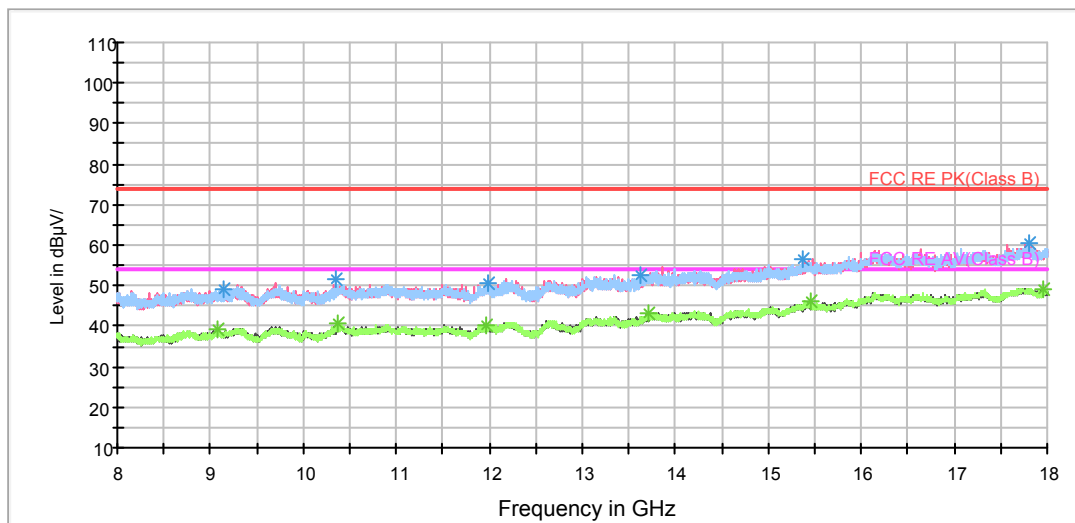

Radiates Emission from 8GHz to 18GHz

Frequency (MHz)	Peak (dBuV/m)	Height (cm)	Polarization	Azimuth (deg)	Reading value (dBuV/m)	Correct Factor (dB)	Margin (dB)	Limit (dBuV/m)
3482.500000	39.1	100.0	V	0.0	40.8	-1.7	34.9	74
3996.875000	43.5	100.0	V	354.0	44.1	-0.6	30.5	74
4822.500000	43.9	200.0	H	337.0	42.2	1.7	30.1	74
7700.000000	49.8	200.0	H	337.0	42.8	7.0	24.2	74
6270.000000	46.1	100.0	H	223.0	40.7	5.4	27.9	74
6972.500000	48.3	100.0	V	217.0	41.8	6.5	25.7	74

Remark: 1. Correction Factor = Antenna factor+ Insertion loss (cable loss + amplifier gain)

Frequency (MHz)	Average (dBuV/m)	Height (cm)	Polarization	Azimuth (deg)	Reading value (dBuV/m)	Correct Factor (dB)	Margin (dB)	Limit (dBuV/m)
3354.375000	29.4	200.0	V	35.0	31.5	-2.1	24.6	54
4120.625000	31.1	200.0	H	199.0	31.2	-0.1	22.9	54
4823.750000	33.5	200.0	H	359.0	31.8	1.7	20.5	54
7700.625000	44.4	200.0	H	337.0	37.4	7.0	9.6	54
6274.375000	35.6	100.0	V	306.0	30.2	5.4	18.4	54
6956.875000	37.1	200.0	H	89.0	30.6	6.5	16.9	54

Remark: 1. Correction Factor = Antenna factor+ Insertion loss (cable loss + amplifier gain)

5.6. Conducted Emission

Ambient condition

Temperature	Relative humidity	Pressure
23°C ~25°C	45%~50%	101.5kPa

Methods of Measurement

The EUT IS placed on a non-metallic table of 80cm height above the horizontal metal reference ground plane. During the test, the EUT was operating in its typical mode. The test method is according to ANSI C63.10-2013. Connect the AC power line of the EUT to the LISN Use EMI receiver to detect the average and Quasi-peak value. RBW is set to 9kHz, VBW is set to 30kHz The measurement result should include both L line and N line.

The test is in transmitting mode.

Test Setup

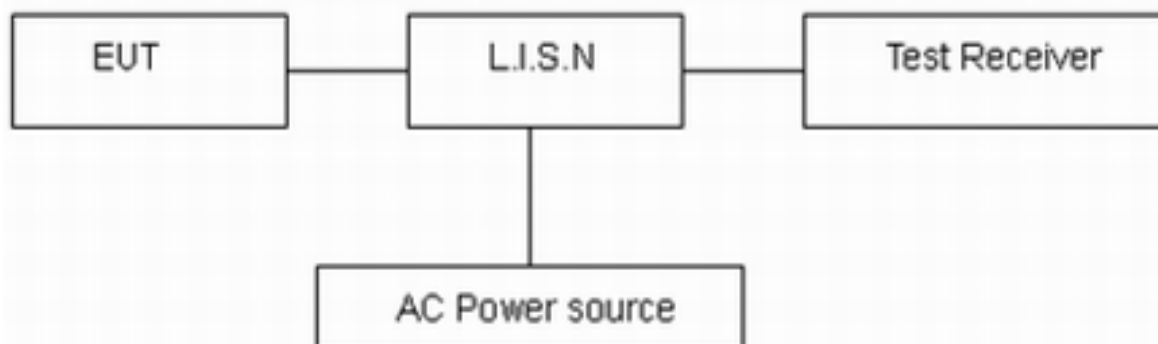

Note: AC Power source is used to change the voltage 110V/60Hz.

Limits

Frequency (MHz)	Conducted Limits(dBμV)	
	Quasi-peak	Average
0.15 - 0.5	66 to 56 *	56 to 46 *
0.5 - 5	56	46
5 - 30	60	50

*: Decreases with the logarithm of the frequency.

Measurement Uncertainty

The assessed measurement uncertainty to ensure 95% confidence level for the normal distribution is with the coverage factor $k = 1.96$, $U = 2.69$ dB.



Test Results:

Following plots, Blue trace uses the peak detection and Green trace uses the average detection. During the test, the Conducted Emission was performed in all modes with all channels, 802.11a, Channel 36 are selected as the worst condition. The test data of the worst-case condition was recorded in this report.

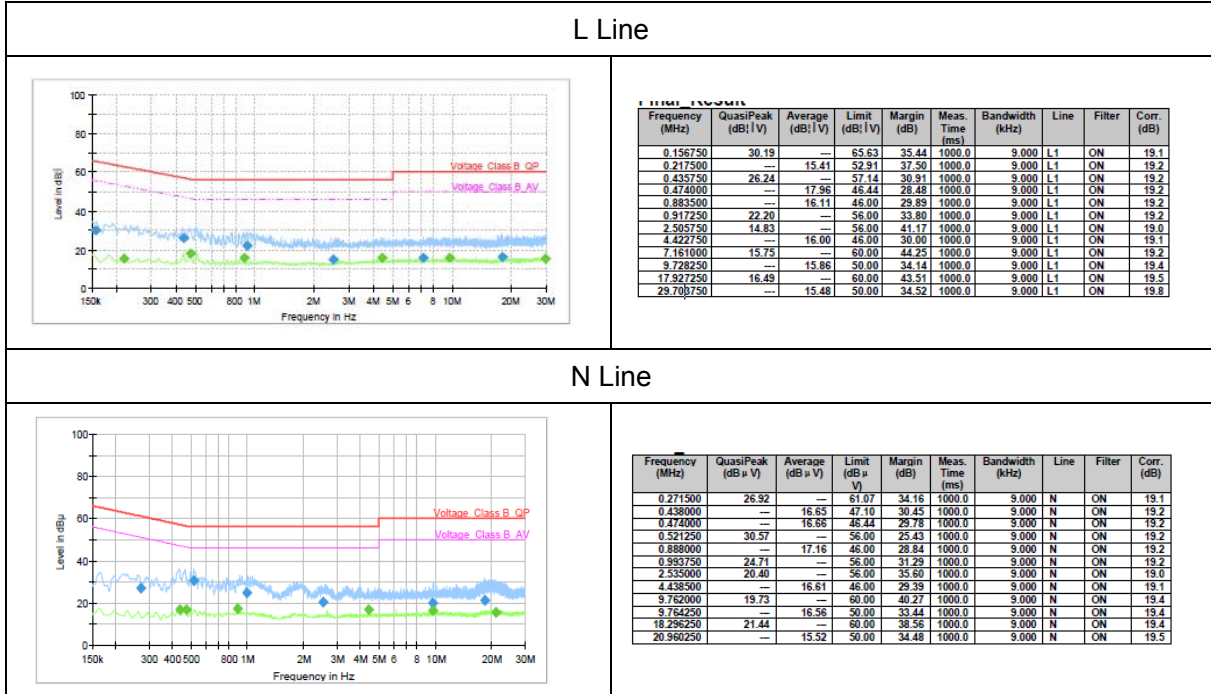



6. Main Test Instruments

Name	Manufacturer	Type	Serial Number	Calibration Date	Expiration Date
Spectrum Analyzer	R&S	FSV40	15195-01-00	2017-09-06	2018-09-05
EMI Test Receiver	R&S	ESCI	100948	2018-05-20	2019-05-19
Loop Antenna	SCHWARZBECK	FMZB1519	1519-047	2017-02-18	2020-02-17
TRILOG Broadband Antenna	Schwarzbeck	VULB 9163	9163-201	2017-11-18	2020-11-17
Double Ridged Waveguide Horn Antenna	R&S	HF907	100126	2014-12-06	2019-12-05
Standard Gain Horn	ETS-Lindgren	3160-09	00102644	2015-01-30	2020-01-29
Standard Gain Horn	STEATITE	QSH-SL-26-40 -K-15	16779	2016-03-21	2019-03-20
Broadband Horn Antenna	Schwarzbeck	BBHA9170	MRTSUE06024	2016-11-24	2019-11-23
EMI Test Receiver	R&S	ESR	101667	2017-09-06	2018-09-05
LISN	R&S	ENV216	101171	2016-12-16	2019-12-15
Spectrum Analyzer	KEYSIGHT	N9020A	MY54420163	2017-12-17	2018-12-16
RF Cable	Agilent	SMA 15cm	0001	2018-06-18	2018-09-17
TEMPERATURE CHAMBER	WEISS	VT4002	582261194500 10	2017-12-17	2018-12-16
AV Power Meter	R&S	NRP	104306	2018-05-20	2019-05-19
Power Probe	R&S	NRP-Z21	104799	2018-05-20	2019-05-19
DC Power Supply	GWINSTEK	GPS-3030D	GEP882653	2018-05-20	2020-05-19
Software (CE)	ROHDE&SCHW ARZ	EMC32	9.26.0	/	/
Software (RE)	ROHDE&SCHW ARZ	EMC32	8.52.0	/	/

*****END OF REPORT *****

ANNEX A: EUT Appearance and Test Setup

A.1 EUT Appearance



Front Side



Back Side

a: EUT



b: Adapter

Picture 1 EUT and Accessory

A.2 Test Setup

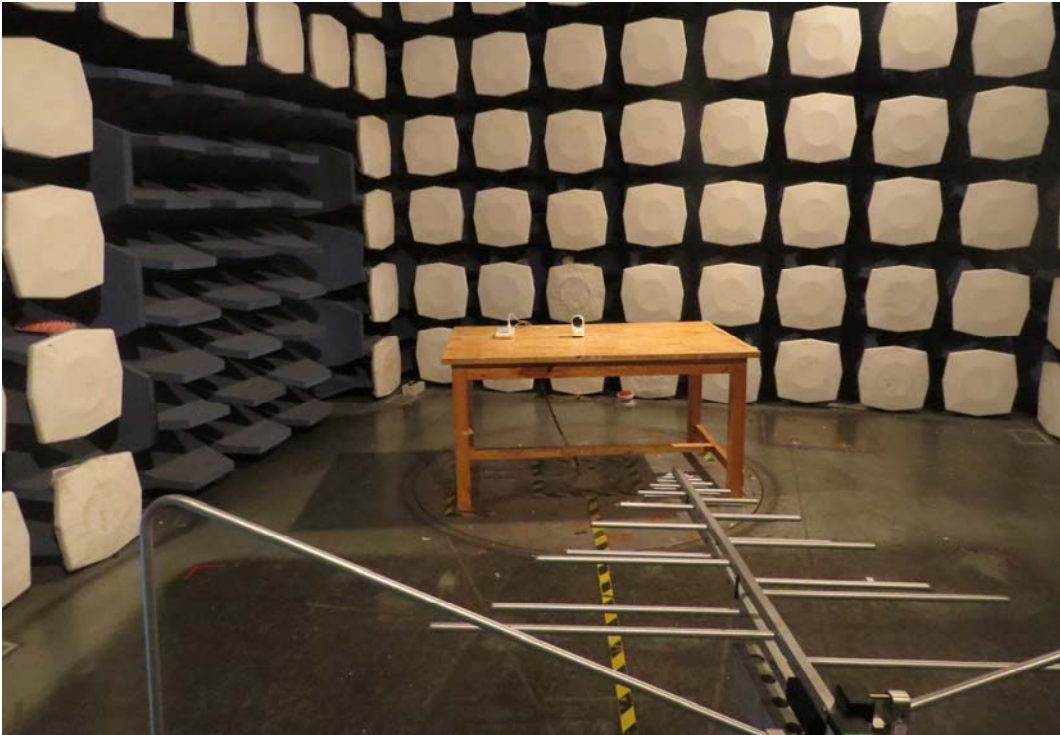

30MHz-1GHz

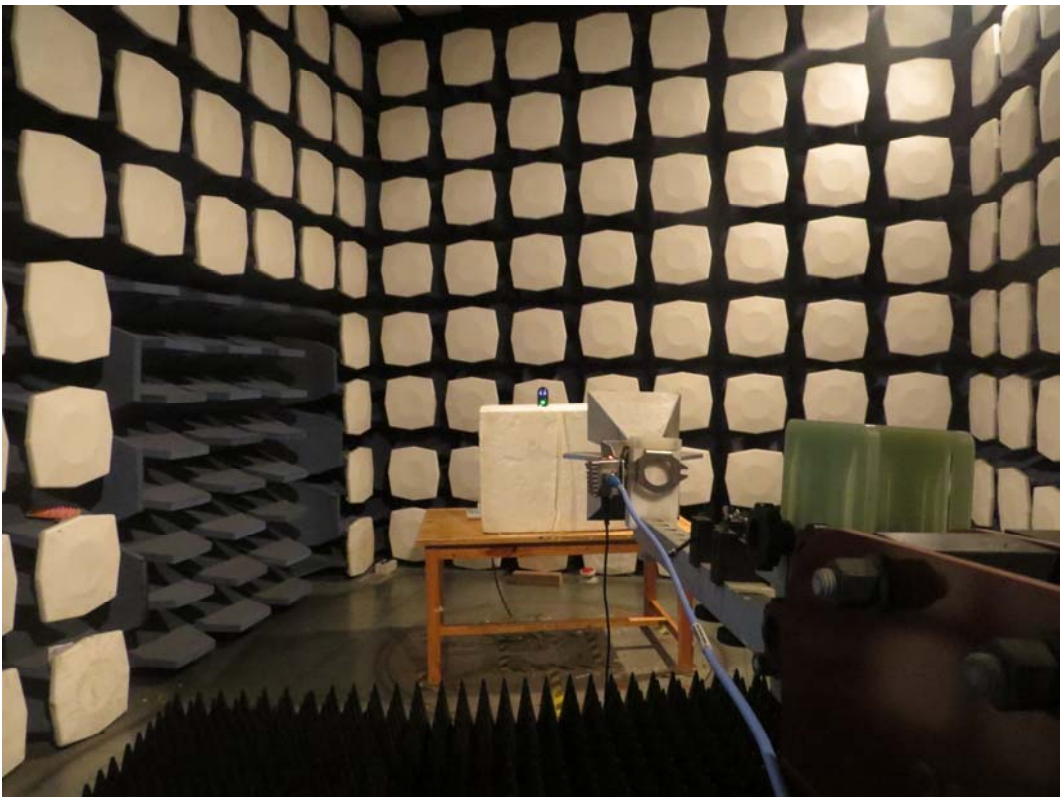

Above 1GHz

Picture 2 Radiated Emission Test Setup



Picture 3 Conducted Emission Test Setup