

FCC 47 CFR PART15 SUBPART E

Test Report

For

Product Name: YI Halo Camera

Brand Name: YI

Model No.: YVR.1717

Series Model.: N/A

FCC ID: 2AFIB-YVR1717

Test Report Number:

C161220R01-RPW2

Issued for

Shanghai Xiaoyi Technology Co., Ltd.

6F,Building E,No.2889,Jinke Road,Shanghai,China

Issued by

Compliance Certification Services Inc.

Kun shan Laboratory

No.10 Weiye Rd., Innovation park, Eco&Tec,
Development Zone, Kunshan City, Jiangsu, China

TEL: 86-512-57355888

FAX: 86-512-57370818



TESTING CERT #2541.01

Note: This report shall not be reproduced except in full, without the written approval of Compliance Certification Services Inc. This document may be altered or revised by Compliance Certification Services Inc. personnel only, and shall be noted in the revision section of the document. The client should not use it to claim product endorsement by A2LA or any government agencies. The test results in the report only apply to the tested sample.

TABLE OF CONTENTS

1	TEST RESULT CERTIFICATION	4
2	EUT DESCRIPTION.....	5
3	TEST METHODOLOGY.....	6
3.1	EUT CONFIGURATION	6
3.2	EUT EXERCISE.....	6
3.3	GENERAL TEST PROCEDURES.....	6
3.4	FCC PART 15.205 RESTRICTED BANDS OF OPERATIONS	7
3.5	DESCRIPTION OF TEST MODES.....	8
3.6	ANTENNA DESCRIPTION.....	9
4	INSTRUMENT CALIBRATION	10
4.1	MEASUREMENT EQUIPMENT USED	10
4.2	MEASUREMENT UNCERTAINTY	11
5	FACILITIES AND ACCREDITATIONS	12
5.1	FACILITIES.....	12
5.2	EQUIPMENT.....	12
5.3	TABLE OF ACCREDITATIONS AND LISTINGS	12
5.4	TABLE OF ACCREDITATIONS AND LISTINGS.....	13
6	SETUP OF EQUIPMENT UNDER TEST	14
6.1	SETUP CONFIGURATION OF EUT.....	14
6.2	SUPPORT EQUIPMENT.....	14
7	FCC PART 15 REQUIREMENTS	15
7.1	6 DB BANDWIDTH MEASUREMENT	15
7.2	MAXIMUM CONDUCTED OUTPUT POWER	21
7.3	BAND EDGES MEASUREMENT	23
7.4	POWER SPECTRAL DENSITY.....	26
7.5	FREQUENCY STABILITY MEASUREMENT.....	34
7.6	RADIATED UNDESIRABLE EMISSION	36
7.7	POWERLINE CONDUCTED EMISSIONS	44

Revision History

Rev.	Issue Date	Report NO.	Effect Page	Contents
00	April 25, 2017	C161220R01-RPW2	ALL	N/A

1 TEST RESULT CERTIFICATION

Product Name:	YI Halo Camera
Trade Name:	YI
Model Name.:	YVR.1717
Series Model:	N/A
Applicant Discrepancy:	Initial
Device Category:	Mobile unit
Date of Test:	March 12, 2017 ~ March 14, 2017
Applicant:	Shanghai Xiaoyi Technology Co., Ltd. 6F,Building E,No.2889,Jinke Road,Shanghai,China
Manufacturer:	Shanghai Xiaoyi Technology Co., Ltd. 6F,Building E,No.2889,Jinke Road,Shanghai,China
Application Type:	Certification

APPLICABLE STANDARDS	
STANDARD	TEST RESULT
FCC 47 CFR Part 15 Subpart E	No non-compliance noted

The above equipment was tested by Compliance Certification Services Inc. The test data, data evaluation, test procedures, and equipment configurations shown in this report were made in accordance with the procedures given in ANSI C63.10: 2013 and the energy emitted by the sample EUT tested as described in this report is in compliance with the requirements of FCC Rules Part 15.207, 15.209, 15.407 and KDB 789033.

The test results of this report relate only to the tested sample EUT identified in this report.

Approved by:

Tested by:

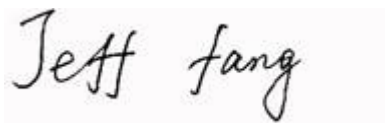
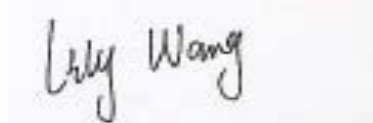
Jeff.Fang
RF Manager
Compliance Certification Service Inc.

Lily.Wang
Test Engineer
Compliance Certification Service Inc.

2 EUT DESCRIPTION

Product Name:	YI Halo Camera
Brand Name:	YI
Model Name:	YVR.1717
Series Model:	N/A
Model Discrepancy:	N/A
Power Adapter:	Model:HKA09024038-8A INPUT: 100-240V~50/60Hz 1.5A Max OUTPUT : 24 V ---3.75A
Frequency Range :	5725MHz-5850MHz
Transmit Power :	IEEE 802.11a:17.93dBm IEEE 802.11n HT20 MHz Channel Mode: 17.80dBm
Modulation Technique :	IEEE 802.11a mode: OFDM IEEE 802.11n HT20 MHz Mode: OFDM
Number of Channels :	IEEE 802.11a/n HT20 mode: 5 Channels
Antenna Specification:	FPC Antenna Gain: -3.09 dBi
Devices:	The YI Halo Camera consists of 18 cameras,but only six camera has WiFi function transmit at the time,each camera has one antenna,so the YI Halo Camera has six antenna

Remark:

1. The sample selected for test was engineering sample that approximated to production product and was provided by manufacturer.
2. This submittal(s) (test report) is intended for **FCC ID: 2AFIB-YVR1717** filing to comply with FCC Part 15, Subpart E Rules.

3 TEST METHODOLOGY

The tests documented in this report were performed in accordance with ANSI C63.10:2013 and FCC CFR 47 15.207, 15.209 and 15.407.

3.1 EUT CONFIGURATION

The EUT configuration for testing is installed for RF field strength measurement to meet the Commissions requirement, and is operated in a manner intended to generate the maximum emission in a continuous normal application.

3.2 EUT EXERCISE

The EUT is operated in the engineering mode to fix the Tx frequency for the purposes of measurement.

According to its specifications, the EUT must comply with the requirements of Section 15.407 under the FCC Rules Part 15 Subpart E.

3.3 GENERAL TEST PROCEDURES

Conducted Emissions

The EUT is placed on the turntable, which is positioned at 0.8 m above the ground plane. According to the requirements in Section 13.3 of ANSI C63.10:2013, the conducted emission from the EUT is measured in the frequency range between 0.15 MHz and 30MHz, using the CISPR Quasi-Peak detector mode.

Radiated Emissions

Under 1GHz

The EUT is placed on a turn table, which is 0.8 m above ground plane. The turntable shall rotate 360 degrees to determine the position of maximum emission level. EUT is set 3m away from the receiving antenna, which varied from 1m to 4m to find out the highest emission. And also, each emission was to be maximized by changing the polarization of receiving antenna both horizontal and vertical. In order to find out the maximum emissions, exploratory radiated emission measurements were made according to the requirements in Section 13.1.4.1 of ANSI C63.10:2013.

Above 1GHz

The EUT is placed on a turn table, which is 1.5 m above ground plane. The turntable shall rotate 360 degrees to determine the position of maximum emission level. EUT is set 3m away from the receiving antenna, which varied from 1m to 4m to find out the highest emission. And also, each emission was to be maximized by changing the polarization of receiving antenna both horizontal and vertical. In order to find out the maximum emissions, exploratory radiated emission measurements were made according to the requirements in Section 13.1.4.1 of ANSI C63.10:2013.

3.4 FCC PART 15.205 RESTRICTED BANDS OF OPERATIONS

(a) Except as shown in paragraph (d) of this section, only spurious emissions are permitted in any of the frequency bands listed below:

MHz	MHz	MHz	GHz
0.090 - 0.110	16.42 - 16.423	399.9 - 410	4.50 - 5.15
0.495 - 0.505 ⁽¹⁾	16.69475 - 16.69525	608 - 614	5.35 - 5.46
2.1735 - 2.1905	16.80425 - 16.80475	960.0 - 1240	7.25 - 7.75
4.125 - 4.128	25.50 - 25.67	1300 - 1427	8.025 - 8.500
4.17725 - 4.17775	37.50 - 38.25	1435.0 - 1626.5	9.0 - 9.2
4.20725 - 4.20775	73.00 - 74.60	1645.5 - 1646.5	9.3 - 9.5
6.215 - 6.218	74.80 - 75.20	1660 - 1710	10.6 - 12.7
6.26775 - 6.26825	108.00 - 121.94	1718.8 - 1722.2	13.25 - 13.4
6.31175 - 6.31225	123 - 138	2200 - 2300	14.47 - 14.5
8.291 - 8.294	149.90 - 150.05	2310 - 2390	15.35 - 16.2
8.362 - 8.366	156.52475 - 156.52525	2483.5 - 2500.0	17.7 - 21.4
8.37625 - 8.38675	156.70 - 156.90	2655 - 2900	22.01 - 23.12
8.41425 - 8.41475	162.0125 - 167.1700	3260 - 3267	23.6 - 24.0
12.29 - 12.293	167.72 - 173.20	3332 - 3339	31.2 - 31.8
12.51975 - 12.52025	240 - 285	3345.8 - 3358.0	36.43 - 36.5 ⁽²⁾
12.57675 - 12.57725	322.0 - 335.4	3600 - 4400	
13.36 - 13.41			

¹ Until February 1, 1999, this restricted band shall be 0.490-0.510 MHz.

² Above 38.6

(b) Except as provided in paragraphs (d) and (e), the field strength of emissions appearing within these frequency bands shall not exceed the limits shown in Section 15.209. At frequencies equal to or less than 1000 MHz, compliance with the limits in Section 15.209 shall be demonstrated using measurement instrumentation employing a CISPR quasi-peak detector. Above 1000 MHz, compliance with the emission limits in Section 15.209 shall be demonstrated based on the average value of the measured emissions. The provisions in Section 15.35 apply to these measurements.

3.5 DESCRIPTION OF TEST MODES

Description	Modulation Technology	Modulation Type
6dB Bandwidth	OFDM	BPSK
Maximum conducted output power	OFDM	BPSK
Band edges measurement	OFDM	BPSK
Peak Power Spectral Density	OFDM	BPSK
Radiated undesirable emission	OFDM	BPSK
Conducted undesirable emission	OFDM	BPSK
Powerline conducted emission	OFDM	BPSK

IEEE 802.11a mode:

Channel Low (5745MHz), Channel Mid (5785MHz) and Channel High (5825MHz) with 6Mbps data rate were chosen for full testing.

IEEE 802.11n HT20 mode:

Channel Low (5745MHz), Channel Mid (5785MHz) and Channel High (5825MHz) with MCS0 data rate were chosen for full testing.

3.6 ANTENNA DESCRIPTION

an intentional radiator antenna shall be designed to ensure that no antenna other than that furnished by the responsible party can be used with the device. The use of a permanently attached or an antenna that uses a unique coupling to the intentional radiator shall be considered sufficient to comply with the provisions of this section”

* the antenna of this EUT is a unique(FPC Antenna for WiFi)

* the EUT complies with the requirement of 15.203.

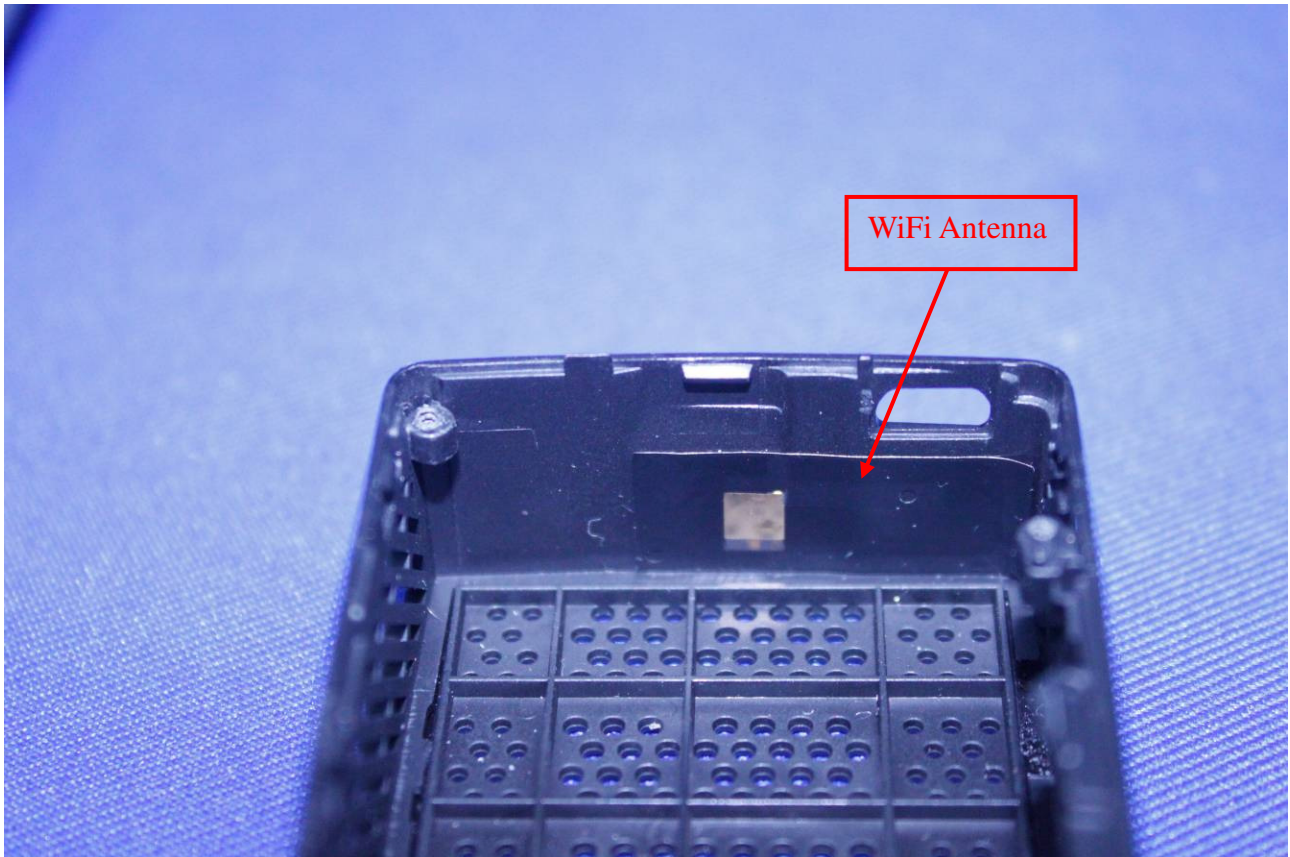

4 INSTRUMENT CALIBRATION

The measuring equipment, which was utilized in performing the tests documented herein, has been calibrated in accordance with the manufacturer's recommendations for utilizing calibration equipment, which is traceable to recognized national standards.

4.1 MEASUREMENT EQUIPMENT USED

Conducted Emissions Test Site					
Name of Equipment	Manufacturer	Model	Serial Number	Calibration Date	Calibration Due
Spectrum Analyzer	Agilent	E4446A	MY44020154	2016-9-10	2017-9-9
Spectrum Analyzer	RS	FSU26	200789	2016-7-21	2017-7-20
Power meter	Anritsu	ML2495A	1445010	2016-5-16	2017-5-15
Power sensor	Anritsu	MA2411B	1339220	2016-5-16	2017-5-15
Power SPLITTER	Mini-Circuits	ZN2PD-9G	SF078500430	N.C.R	N.C.R
DC Power Supply	AGILENT	E3632A	MY50340053	N.C.R	N.C.R
Temp. / Humidity Gauge	Anymetre	TH603	CCS007	2016-11-1	2017-10-31

977 Chamber					
Name of Equipment	Manufacturer	Model	Serial Number	Calibration Date	Calibration Due
Spectrum Analyzer	Agilent	E4446A	MY44020154	2016-9-10	2017-9-9
Spectrum Analyzer	RS	FSU26	200789	2016-7-21	2017-7-20
EMI Test Receiver	R&S	ESCI	101378	2017-1-5	2018-1-4
Pre-Amplifier	MINI	ZFL-1000VH2	070306	2017-1-5	2018-1-4
Pre-Amplifier	Miteq	JS41-00101800-32-10P	1675713	2016-7-21	2017-7-20
Bilog Antenna	Sunol	JB1	A062604	2016-5-29	2017-5-28
Bilog Antenna	Sunol	JB1	A110204-1	2016-5-29	2017-5-28
Loop Antenna	SCHWARZBECK	HXYZ9170	9170-108	2017-3-4	2018-3-3
Horn-antenna	SCHWARZBECK	9120D	D:266	2017-3-5	2018-3-4
Horn-antenna	SCHWARZBECK	9120D	D:267	2016-11-10	2017-11-9
Turn Table	CT	CT123	4165	N.C.R	N.C.R
Antenna Tower	CT	CTERG23	3256	N.C.R	N.C.R
Controller	CT	CT100	95637	N.C.R	N.C.R
Test Software			EZ-EMC		

Conducted Emission					
Name of Equipment	Manufacturer	Model	Serial Number	Calibration Date	Calibration Due
EMI TEST RECEIVER	R&S	ESCI	100781	2017-2-28	2018-2-27
V (V-LISN)	SCHWARZBECK	NNLK 8129	8129-143	2016-11-1	2017-10-31
TWO-LINE V-NETWORK	R&S	ENV216	101604	2016-11-1	2017-10-31
Pulse LIMITER	R&S	ESH3-Z2	100524	2017-1-5	2018-1-4
Test Software	EZ-EMC				

Remark: Each piece of equipment is scheduled for calibration once a year.

4.2 MEASUREMENT UNCERTAINTY

For the test methods, according to the present document, the measurement uncertainty figures shall be calculated in accordance with TR 100 028-1 [2] and shall correspond to an expansion factor (coverage factor) $k = 1.96$ or $k = 2$ (which provide confidence levels of respectively 95 % and 95.45 % in the case where the distributions characterizing the actual measurement uncertainties are normal (Gaussian)).

Table 6 is based on such expansion factors.

Table 6: Maximum measurement uncertainty

Parameter	UNCERTAINTY
Radio frequency	$\pm 0.8 \times 10^{-7}$
RF power, conducted	0.2054
Maximum frequency deviation:	
-within 300 Hz and 6 kHz of audio frequency	1.3%
-within 6 kHz and 25 kHz of audio frequency	0.65 dB
Adjacent channel power	0.2054
Conducted spurious emission of transmitter, valid up to 6 GHz	0.2892
Conducted emission of receivers	+1.2/-1.1 dB
Radiated emission of transmitter, valid up to 6 GHz	± 3.94 dB
Radiated emission of receiver, valid up to 6 GHz	± 3.94 dB
RF level uncertainty for a given BER	± 0.3 dB
Temperature	0.1979
Humidity	± 1 %

5 FACILITIES AND ACCREDITATIONS

5.1 FACILITIES

All measurement facilities used to collect the measurement data are located at

No.10Weiye Rd., Innovation park, Eco&Tec, Development Zone, Kunshan City, Jiangsu, China.

The sites are constructed in conformance with the requirements of ANSI C63.10:2013 and CISPR Publication 22. All receiving equipment conforms to CISPR Publication 16-1, "Radio Interference Measuring Apparatus and Measurement Methods."

5.2 EQUIPMENT

Radiated emissions are measured with one or more of the following types of linearly polarized antennas: tuned dipole, biconical, log periodic, bi-log, and/or ridged waveguide, horn. Spectrum analyzers with preselectors and quasi-peak detectors are used to perform radiated measurements.

Conducted emissions are measured with Line Impedance Stabilization Networks and EMI Test Receivers.



Calibrated wideband preamplifiers, coaxial cables, and coaxial attenuators are also used for making measurements.

All receiving equipment conforms to CISPR Publication 16-1, "Radio Interference Measuring Apparatus and Measurement Methods."

5.3 TABLE OF ACCREDITATIONS AND LISTINGS

The test facilities used to perform radiated and conducted emissions tests are accredited by American Association for Laboratory Accreditation Program for the specific scope accreditation under Lab Code: 200581-0 to perform Electromagnetic Interference tests according to FCC Part 15 and CISPR 22 requirements. In addition, the test facilities are listed with Industry Canada, Certification and Engineering Bureau, 2324E-1 for 10m chamber 10m, 2324E-2 for 10m chamber 3m; the test facilities are listed with USA, Certification and Engineering Bureau, 424105 for 10m chamber 10m, 238958 for 10m chamber 3m.

5.4 TABLE OF ACCREDITATIONS AND LISTINGS

Country	Agency	Scope of Accreditation	Logo
USA	A2LA	47 CFR FCC Part 15/18 (using ANSI C63.10 :2013); VCCI V3; CNS 13438; CNS 13439; CNS 13803; CISPR 11; EN 55011; CISPR 13; EN 55013; CISPR 22:2005; CISPR 22:1997 +A1 :2000+A2 :2002; EN 55022:2006; EN55022 :1998 +A1 :2001+A2 :2003; EN 61000-6-3 (excluding discontinuous interference); EN 61000-6-4; AS/NZS CISPR 22; CAN/CSA-CEI/IEC CISPR 22; EN 61000-3-2; EN 61000-3-3; EN550024; EN 61000-4-2; EN 61000-4-3; EN61000-4-4; EN 61000-4-5; EN 61000-4-6; IEC 61000-4-8; EN 61000-4-11; IEC61000-3-2; IEC61000-3-3; IEC 61000-4-2; IEC 61000-4-3; IEC 61000-4-4; IEC 61000-4-5; IEC 61000-4-6; IEC 61000-4-8; IEC 61000-4-11; EN 300 220-3; EN 300 328; EN 300 330-2; EN 300 440-1; EN 300-440-2; EN 300 893; EN 301 489-01; EN 301 489-3; EN 301 489-07; EN 301 489-17; 47 CFR FCC Part 15, 22, 24	
USA	FCC	3/10 meter Sites to perform FCC Part 15/18 measurements	 93105, 90471
Japan	VCCI	3/10 meter Sites and conducted test sites to perform radiated/conducted measurements	VCCI R-1600 C-1707 G-216

** No part of this report may be used to claim or imply product endorsement by A2LA or any agency of the US Government.*

6 SETUP OF EQUIPMENT UNDER TEST

6.1 SETUP CONFIGURATION OF EUT

See test photographs attached in Appendix 1 for the actual connections between EUT and support equipment.

6.2 SUPPORT EQUIPMENT

No.	Equipment	Model No.	Serial No.
	N/A		

Remark:

1. All the equipment/cables were placed in the worst-case configuration to maximize the emission during the test.
2. Grounding was established in accordance with the manufacturer's requirements and conditions for the intended use.

7 FCC PART 15 REQUIREMENTS

7.1 6 DB BANDWIDTH MEASUREMENT

LIMIT

Section 15.407(e) specifies the minimum 6 dB emission bandwidth of at least 500 KHz for the band 5.725-5.85 GHz.

Test Configuration

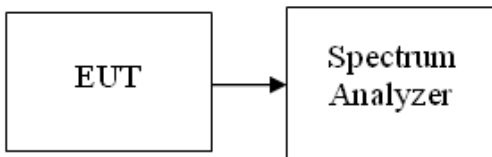

TEST PROCEDURE

1. Place the EUT on the table and set it in the transmitting mode.
2. Remove the antenna from the EUT and then connect a low-loss RF cable from the antenna port to the spectrum analyzer.
3. Set the spectrum analyzer as RBW =100KHz, VBW ≥ 3RBW, Detector = Peak. Trace mode = max hold.
4. Measure the maximum width of the emission that is 6 dB down from the peak of the emission.
5. Measure and record the results in the test report

TEST RESULTS

No non-compliance noted

Test Data

**Test mode: IEEE 802.11a mode
chain 0:**

Channel	Frequency (MHz)	6 dB Bandwidth (MHz)	FCC 6 dB Bandwidth Min. Limit (MHz)
Low	5745	16.109	0.5
Mid	5785	16.433	0.5
High	5825	15.458	0.5

chain 1:

Channel	Frequency (MHz)	6 dB Bandwidth (MHz)	FCC 6 dB Bandwidth Min. Limit (MHz)
Low	5745	16.394	0.5
Mid	5785	16.346	0.5
High	5825	16.346	0.5

chain 2:

Channel	Frequency (MHz)	6 dB Bandwidth (MHz)	FCC 6 dB Bandwidth Min. Limit (MHz)
Low	5745	16.382	0.5
Mid	5785	16.364	0.5
High	5825	16.364	0.5

chain 3:

Channel	Frequency (MHz)	6 dB Bandwidth (MHz)	FCC 6 dB Bandwidth Min. Limit (MHz)
Low	5745	16.412	0.5
Mid	5785	16.412	0.5
High	5825	16.412	0.5

chain 4:

Channel	Frequency (MHz)	6 dB Bandwidth (MHz)	FCC 6 dB Bandwidth Min. Limit (MHz)
Low	5745	16.269	0.5
Mid	5785	16.257	0.5
High	5825	16.361	0.5

chain 5:

Channel	Frequency (MHz)	6 dB Bandwidth (MHz)	FCC 6 dB Bandwidth Min. Limit (MHz)
Low	5745	16.247	0.5
Mid	5785	16.247	0.5
High	5825	16.324	0.5

Test mode: IEEE 802.11n HT20 mode
chain 0:

Channel	Frequency (MHz)	6 dB Bandwidth (MHz)	FCC 6 dB Bandwidth Min. Limit (MHz)
Low	5745	17.629	0.5
Mid	5785	17.378	0.5
High	5825	17.379	0.5

chain 1:

Channel	Frequency (MHz)	6 dB Bandwidth (MHz)	FCC 6 dB Bandwidth Min. Limit (MHz)
Low	5745	17.644	0.5
Mid	5785	17.644	0.5
High	5825	17.596	0.5

chain 2:

Channel	Frequency (MHz)	6 dB Bandwidth (MHz)	FCC 6 dB Bandwidth Min. Limit (MHz)
Low	5745	17.644	0.5
Mid	5785	17.594	0.5
High	5825	17.642	0.5

chain 3:

Channel	Frequency (MHz)	6 dB Bandwidth (MHz)	FCC 6 dB Bandwidth Min. Limit (MHz)
Low	5745	17.624	0.5
Mid	5785	17.624	0.5
High	5825	17.526	0.5

chain 4:

Channel	Frequency (MHz)	6 dB Bandwidth (MHz)	FCC 6 dB Bandwidth Min. Limit (MHz)
Low	5745	17.427	0.5
Mid	5785	17.465	0.5
High	5825	17.607	0.5

chain 5:

Channel	Frequency (MHz)	6 dB Bandwidth (MHz)	FCC 6 dB Bandwidth Min. Limit (MHz)
Low	5745	17.471	0.5
Mid	5785	17.503	0.5
High	5825	17.439	0.5

The Worse Test Plot

IEEE 802.11a mode

6dB Bandwidth (CH Low)

Agilent

R T

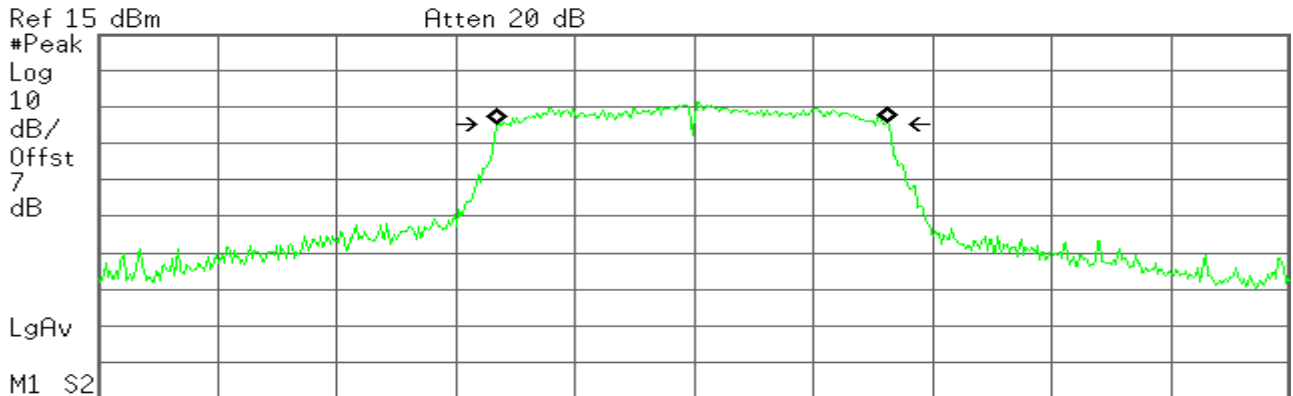

Ref 15 dBm Atten 20 dB
 #Peak Log 10 dB/ Offst 7 dB
 LgAv
 M1 S2
 Center 5.745 00 GHz Span 50 MHz
 #Res BW 100 kHz #VBW 300 kHz Sweep 4.8 ms (601 pts)

Occupied Bandwidth
16.3191 MHz

Occ BW % Pwr 99.00 %
x dB -6.00 dB

Transmit Freq Error -49.610 kHz
x dB Bandwidth 16.109 MHz

6dB Bandwidth (CH Mid)

Agilent

R T

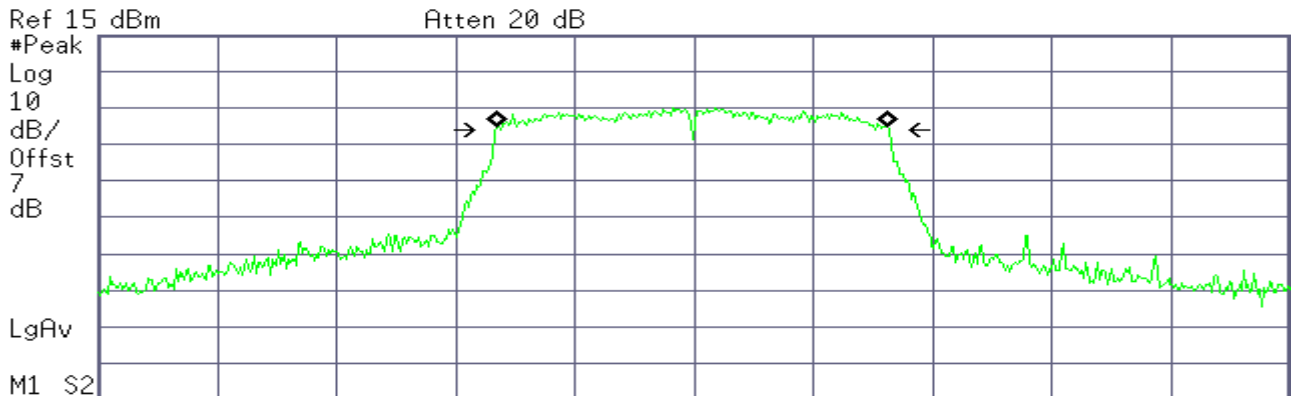

Ref 15 dBm Atten 20 dB
 #Peak Log 10 dB/ Offst 7 dB
 LgAv
 M1 S2
 Center 5.785 00 GHz Span 50 MHz
 #Res BW 100 kHz #VBW 300 kHz Sweep 4.8 ms (601 pts)

Occupied Bandwidth
16.3473 MHz

Occ BW % Pwr 99.00 %
x dB -6.00 dB

Transmit Freq Error -69.064 kHz
x dB Bandwidth 16.433 MHz

6dB Bandwidth (CH High)

Agilent

R T

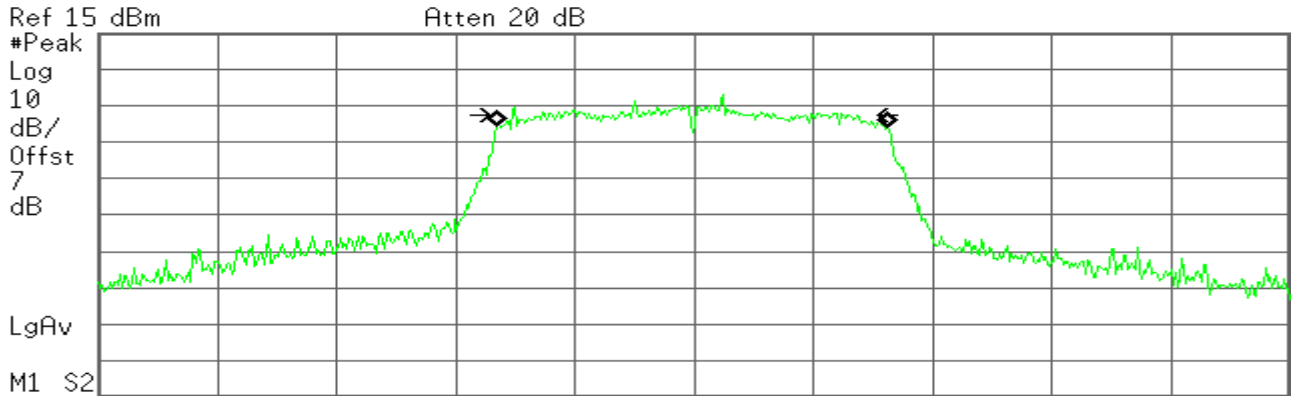

Ref 15 dBm Atten 20 dB
 #Peak Log 10 dB/ Offst 7 dB
 Center 5.825 00 GHz Span 50 MHz
 #Res BW 100 kHz #VBW 300 kHz Sweep 4.8 ms (601 pts)

Occupied Bandwidth
16.3548 MHz

Occ BW % Pwr 99.00 %
x dB -6.00 dB

Transmit Freq Error -61.636 kHz
x dB Bandwidth 15.458 MHz

IEEE 802.11n HT20 mode

6dB Bandwidth (CH Low)

Agilent

R T

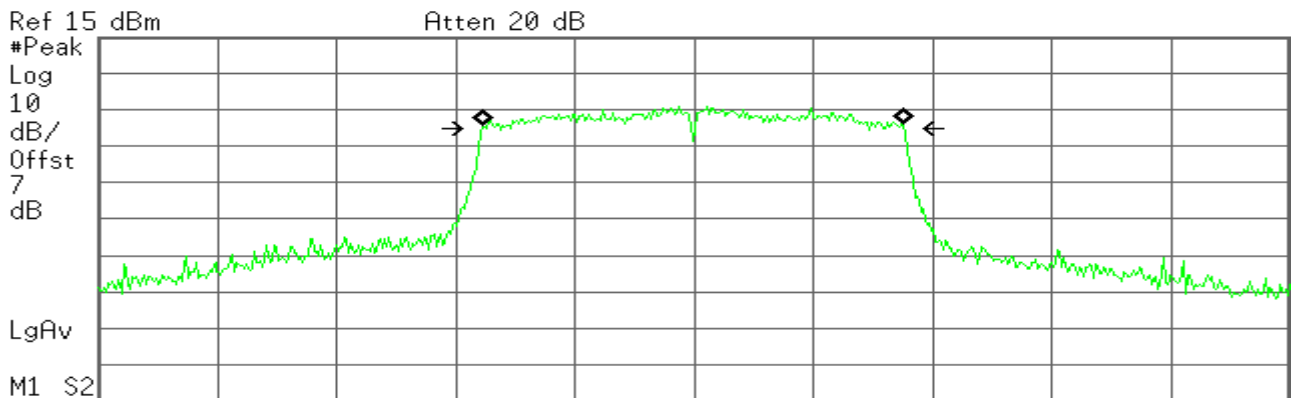

Ref 15 dBm Atten 20 dB
 #Peak Log 10 dB/ Offst 7 dB
 Center 5.745 00 GHz Span 50 MHz
 #Res BW 100 kHz #VBW 300 kHz Sweep 4.8 ms (601 pts)

Occupied Bandwidth
17.5327 MHz

Occ BW % Pwr 99.00 %
x dB -6.00 dB

Transmit Freq Error -44.541 kHz
x dB Bandwidth 17.629 MHz

6dB Bandwidth (CH Mid)

Agilent

R T

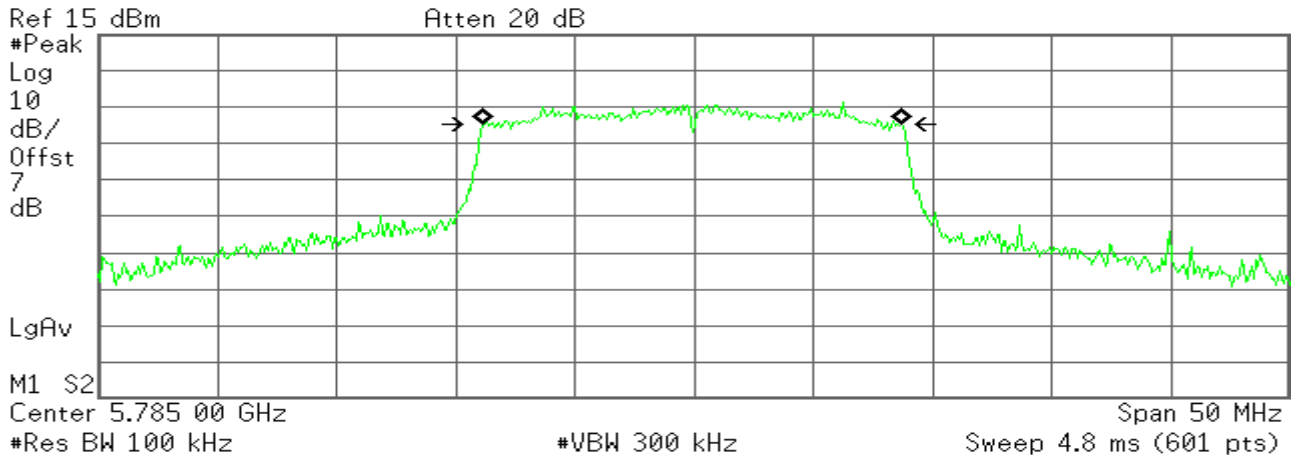

Occupied Bandwidth
17.5151 MHz

Occ BW % Pwr 99.00 %
x dB -6.00 dB

Transmit Freq Error -58.142 kHz
x dB Bandwidth 17.378 MHz

6dB Bandwidth (CH High)

Agilent

R T

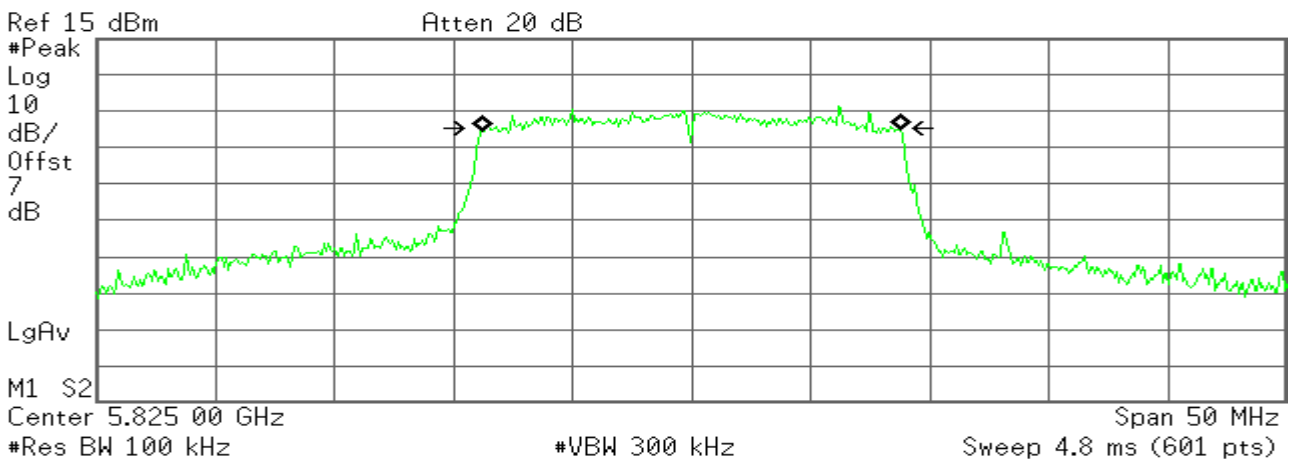

Occupied Bandwidth
17.5130 MHz

Occ BW % Pwr 99.00 %
x dB -6.00 dB

Transmit Freq Error -39.208 kHz
x dB Bandwidth 17.379 MHz

7.2 MAXIMUM CONDUCTED OUTPUT POWER

LIMIT

According to §15.407(a),

For the band 5.725–5.85 GHz, the maximum conducted output power over the frequency band of operation shall not exceed 1 W.

If transmitting antennas of directional gain greater than 6dBi are used, both the peak transmit power and the peak power spectral density shall be reduced by the amount in dB that the directional gain of the antenna exceeds 6dBi.

The peak power shall not exceed the limit as follow:

Test Configuration

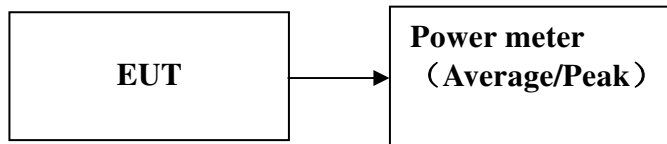

The EUT was connected to a spectrum analyzer through a 50Ω RF cable.

TEST PROCEDURE

The testing follows Method PM of FCC KDB 789033 D02 General UNII Test Procedures New Rules v01.

Method PM (Measurement using an RF average power meter):

1. Measurement is performed using a wideband RF power meter.
2. The EUT is configured to transmit continuously with a consistent duty cycle at its maximum power control level.
3. Measure the average power of the transmitter, and the average power is corrected with duty factor, $10 \log(1/x)$, where x is the duty cycle.

TEST RESULTS

No non-compliance noted

Test Data

Test mode: IEEE 802.11a mode

5725~5850MHz

Channel	Frequency (MHz)	Chain 0 Output Power (dBm)	Chain 1 Output Power (dBm)	Chain 2 Output Power (dBm)	Chain 3 Output Power (dBm)	Chain 4 Output Power (dBm)	Chain 5 Output Power (dBm)	Total Maximum Average Conducted Output Power (dBm)	Limit (dBm)
Low	5745	10.24	9.89	10.12	10.23	10.18	10.22	17.93	30.00
Mid	5785	9.79	9.25	9.46	9.53	9.56	9.55	17.31	30.00
High	5825	9.41	9.36	9.47	9.51	9.41	9.35	17.20	30.00

Remark: Total Output Power (dBm) = 10*LOG (10^(Chain 0 Output Power / 10)+10^(Chain 1 Output Power /10)+10^(Chain 2 Output Power /10)+10^(Chain 3 Output Power /10) +10^(Chain 4 Output Power /10) +10^(Chain 5 Output Power /10))

Test mode: IEEE 802.11n HT20 mode

5725~5850MHz

Channel	Frequency (MHz)	Chain 0 Output Power (dBm)	Chain 1 Output Power (dBm)	Chain 2 Output Power (dBm)	Chain 3 Output Power (dBm)	Chain 4 Output Power (dBm)	Chain 5 Output Power (dBm)	Total Maximum Average Conducted Output Power (dBm)	Limit (dBm)
Low	5745	10.05	10.05	9.98	9.99	10.01	10.02	17.80	30.00
Mid	5785	9.69	9.57	9.54	9.56	9.57	9.62	17.37	30.00
High	5825	9.35	9.26	9.34	9.35	9.26	9.38	17.11	30.00

Remark: Total Output Power (dBm) = 10*LOG (10^(Chain 0 Output Power / 10)+10^(Chain 1 Output Power /10)+10^(Chain 2 Output Power /10)+10^(Chain 3 Output Power /10) +10^(Chain 4 Output Power /10) +10^(Chain 5 Output Power /10))

Note:Duty factor has been offsetted with cableloss

7.3 BAND EDGES MEASUREMENT

LIMIT

According to §15.407(b)(4)(i),

- (1) The provisions of Section 15.205 of this part apply to intentional radiators operating under this section.
- (2) When measuring the emission limits, the nominal carrier frequency shall be adjusted as close to the upper and lower frequency block edges as the design of the equipment permits.

All emissions shall be limited to a level of -27 dBm/MHz at 75 MHz or more above or below the band edge increasing linearly to 10 dBm/MHz at 25 MHz above or below the band edge, and from 25 MHz above or below the band edge increasing linearly to a level of 15.6 dBm/MHz at 5 MHz above or below the band edge, and from 5 MHz above or below the band edge increasing linearly to a level of 27 dBm/MHz at the band edge.

Test Configuration

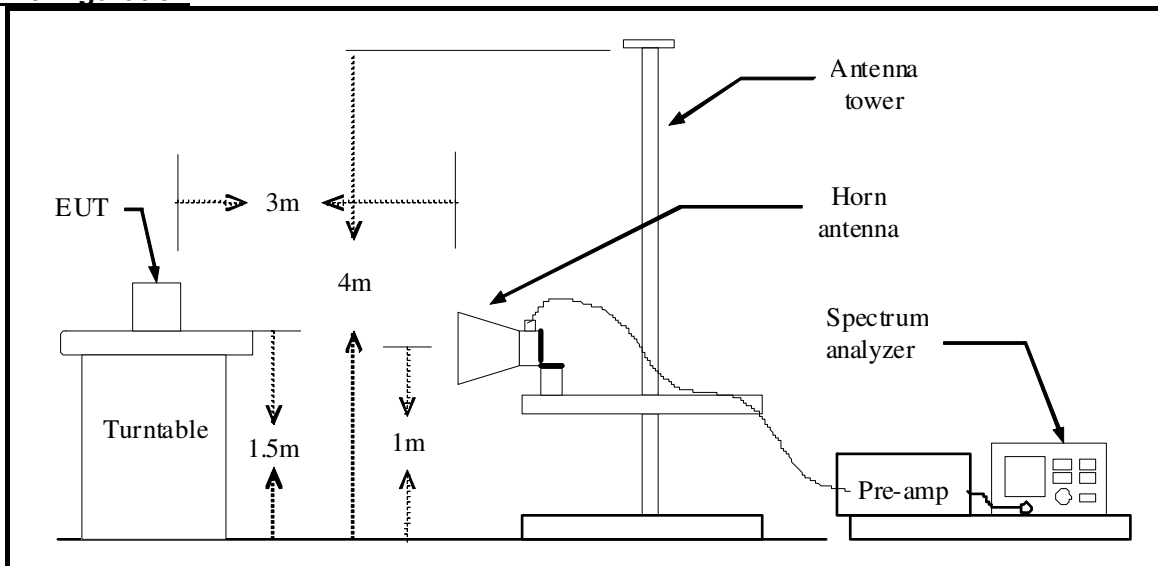

TEST PROCEDURE

1. The EUT is placed on a turntable, which is 1.5m above the ground plane.
2. The turntable shall be rotated for 360 degrees to determine the position of maximum emission level.
3. EUT is set 3m away from the receiving antenna, which is varied from 1m to 4m to find out the highest emission.
4. Set the spectrum analyzer in the following setting in order to capture the lower and upper band-edges of the emission:
 - (a) PEAK: RBW=VBW=1MHz / Sweep=AUTO
 - (b) AVERAGE: RBW=1MHz / Sweep=AUTO

VBW=10Hz,when duty cycle is no less than 98 percent.

VBW ≥ 1/T,when duty cycle is less than 98 percent,where T is the minimum transmission duration over which the transmitter is on and is transmitting at its maximum power control level for the tested mode of operation.

Band	Duty Cycle(%)	T(ms)	1/T(kHz)	VBW Setting
IEEE 802.11 a	99	-	-	10Hz
IEEE 802.11n HT20	99	-	-	10Hz

5. Repeat the procedures until all the PEAK and AVERAGE versus POLARIZATION are measured.

TEST RESULTS

Refer to attach spectrum analyzer data chart.

Operation Mode:	Tx / IEEE 802.11a mode CH/ Low	Test Date:	2017-3-12
Temperature:	25°C	Tested by:	Lily.Wang
Humidity:	55% RH	Polarity:	Ver. / Hor.

Vertical

No.	Frequency (MHz)	Reading (dBuV)	Correct Factor(dB/m)	Result (dBuV/m)	Limit (dBuV/m)	Margin (dB)	Height (cm)	Degree (deg.)	Remark
1	5694.750	53.40	-0.21	53.19	101.31	-48.12	100	16	peak
2	5717.625	62.19	-0.17	62.02	110.13	-48.11	100	288	peak
3	N/A								

Horizontal

No.	Frequency (MHz)	Reading (dBuV)	Correct Factor(dB/m)	Result (dBuV/m)	Limit (dBuV/m)	Margin (dB)	Height (cm)	Degree (deg.)	Remark
1	5671.500	54.56	-0.24	54.32	84.11	-29.79	100	189	peak
2	5694.375	58.08	-0.21	57.87	101.04	-43.17	100	201	peak
3	5718.375	60.28	-0.17	60.11	110.34	-50.23	100	197	peak

Operation Mode:	Tx / IEEE 802.11a mode/ CH High	Test Date:	2017-3-12
Temperature:	25°C	Tested by:	Lily.Wang
Humidity:	55% RH	Polarity:	Ver. / Hor.

Vertical

No.	Frequency (MHz)	Reading (dBuV)	Correct Factor(dB/m)	Result (dBuV/m)	Limit (dBuV/m)	Margin (dB)	Height (cm)	Degree (deg.)	Remark
1	5852.250	58.02	0.02	58.04	117.07	-59.03	100	351	peak
2	5875.500	51.67	0.05	51.72	104.83	-53.11	100	335	peak
3	N/A								

Horizontal

No.	Frequency (MHz)	Reading (dBuV)	Correct Factor(dB/m)	Result (dBuV/m)	Limit (dBuV/m)	Margin (dB)	Height (cm)	Degree (deg.)	Remark
1	5853.000	59.47	0.02	59.49	115.36	-55.87	100	130	peak
2	5858.625	57.41	0.03	57.44	109.78	-52.34	100	130	peak
3	N/A								

Operation Mode:	Tx / IEEE 802.11n HT20 mode/ CH Low	Test Date:	2017-3-12
Temperature:	25°C	Tested by:	Lily.Wang
Humidity:	55% RH	Polarity:	Ver. / Hor.

Vertical

No.	Frequency (MHz)	Reading (dBuV)	Correct Factor(dB/m)	Result (dBuV/m)	Limit (dBuV/m)	Margin (dB)	Height (cm)	Degree (deg.)	Remark
1	5700.750	46.00	-0.20	45.80	105.41	-59.61	100	30	peak
2	5724.375	53.52	-0.16	53.36	120.78	-67.42	100	229	peak
3	N/A								

Horizontal

No.	Frequency (MHz)	Reading (dBuV)	Correct Factor(dB/m)	Result (dBuV/m)	Limit (dBuV/m)	Margin (dB)	Height (cm)	Degree (deg.)	Remark
1	5722.125	53.09	-0.17	52.92	115.64	-62.72	100	130	peak
2	5730.000	60.32	-0.16	60.16	135.00	-74.84	100	130	peak
3	N/A								

Operation Mode:	Tx / IEEE 802.11n HT20 mode/ CH High	Test Date:	2017-3-12
Temperature:	25°C	Tested by:	Lily.Wang
Humidity:	55% RH	Polarity:	Ver. / Hor.

Vertical

No.	Frequency (MHz)	Reading (dBuV)	Correct Factor(dB/m)	Result (dBuV/m)	Limit (dBuV/m)	Margin (dB)	Height (cm)	Degree (deg.)	Remark
1	5850.750	64.71	0.02	64.73	120.49	-55.76	100	358	peak
2	5875.500	52.15	0.05	52.20	104.83	-52.63	100	20	peak
3	N/A								

Horizontal

No.	Frequency (MHz)	Reading (dBuV)	Correct Factor(dB/m)	Result (dBuV/m)	Limit (dBuV/m)	Margin (dB)	Height (cm)	Degree (deg.)	Remark
1	5851.125	69.49	0.02	69.51	119.64	-50.13	100	144	peak
2	5880.750	56.24	0.06	56.30	100.95	-44.65	100	22	peak
3	N/A								

7.4 POWER SPECTRAL DENSITY

LIMIT

According to §15.407(a),

For the band 5.725–5.85 GHz, the maximum power spectral density shall not exceed 30 dBm in any 500-kHz band.

If transmitting antennas of directional gain greater than 6dBi are used, both the maximum transmit power and the maximum power spectral density shall be reduced by the amount in dB that the directional gain of the antenna exceeds 6dBi.

Test Configuration

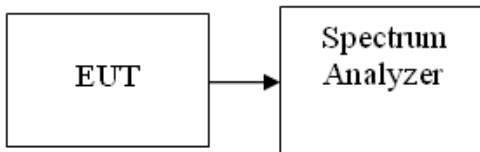

TEST PROCEDURE

1. The testing follows Method SA-2 of FCC KDB 789033 D01 General UNII Test Procedures v01r04.
2. Measure the duty cycle, Set span to encompass the entire emission bandwidth (EBW) of the signal. Set RBW = 300 kHz. Set VBW \geq 1 MHz. Number of points in sweep \geq 2 Span / RBW. Sweep time = auto. Detector = RMS, Trace average at least 100 traces in power averaging mode. Add $10 \log(500\text{kHz}/\text{RBW})$ to the test result. Add $10 \log(1/x)$, where x is the duty cycle, to the measured power in order to compute the average power during the actual transmission times. For example, add $10 \log(1/0.25) = 6$ dB if the duty cycle is 25 percent.
3. The RF output of EUT was connected to the spectrum analyzer by a low loss cable.
4. Each plot has already offset with cable loss, and attenuator loss. Measure the PPSD and record it.
5. For MIMO mode, calculation method follows FCC KDB 662911 D01 Multiple Transmitter Output v02r01.

Method (1): Measure and sum the spectra across the outputs. The total final Power Spectral Density is from a device with 2 transmitter outputs. The spectrum measurements of the individual outputs are all performed with the same span and number of points, the spectrum value in the first spectral bin of output 1 is summed with that in the first spectral bin of output 2 to obtain the value for the first frequency bin of the summed spectrum.

TEST RESULTS

No non-compliance noted

Test Data
Test mode: IEEE 802.11a mode
5725~5850MHz
chain 0:

Channel	Frequency (MHz)	Average PSD(dBm /300kHz)	10log (500kHz /RBW) Factor(dB)	Average PSD (dBm/500kHz)	Result
Low	5745	1.10	2.22	3.32	PASS
Mid	5785	1.19	2.22	3.41	PASS
High	5825	0.14	2.22	2.36	PASS

chain 1:

Channel	Frequency (MHz)	Average PSD(dBm /300kHz)	10log (500kHz /RBW) Factor(dB)	Average PSD (dBm/500kHz)	Result
Low	5745	1.08	2.22	3.30	PASS
Mid	5785	1.15	2.22	3.37	PASS
High	5825	0.13	2.22	2.35	PASS

chain 2:

Channel	Frequency (MHz)	Average PSD(dBm /300kHz)	10log (500kHz /RBW) Factor(dB)	Average PSD (dBm/500kHz)	Result
Low	5745	1.09	2.22	3.31	PASS
Mid	5785	1.15	2.22	3.37	PASS
High	5825	0.11	2.22	2.33	PASS

chain 3:

Channel	Frequency (MHz)	Average PSD(dBm /300kHz)	10log (500kHz /RBW) Factor(dB)	Average PSD (dBm/500kHz)	Result
Low	5745	1.08	2.22	3.30	PASS
Mid	5785	1.13	2.22	3.35	PASS
High	5825	0.09	2.22	2.31	PASS

chain 4:

Channel	Frequency (MHz)	Average PSD(dBm /300kHz)	10log (500kHz /RBW) Factor(dB)	Average PSD (dBm/500kHz)	Result
Low	5745	1.10	2.22	3.32	PASS
Mid	5785	1.17	2.22	3.41	PASS
High	5825	0.13	2.22	2.36	PASS

chain 5:

Channel	Frequency (MHz)	Average PSD(dBm /300kHz)	10log (500kHz /RBW) Factor(dB)	Average PSD (dBm/500kHz)	Result
Low	5745	1.08	2.22	3.32	PASS
Mid	5785	1.16	2.22	3.41	PASS
High	5825	0.12	2.22	2.36	PASS

Channel	Frequency (MHz)	Chain 0 Average PSD (dBm/500k Hz)	Chain 1 Average PSD (dBm/500k Hz)	Chain 2 Average PSD (dBm/500k Hz)	Chain 3 Average PSD (dBm/500k Hz)	Chain 4 Average PSD (dBm/500k Hz)	Chain 5 Average PSD (dBm/500k Hz)	Total Maximum Average PSD (dBm/500k Hz)	Average PSD Limit (dBm/500kHz)
Low	5745	3.32	3.30	3.31	3.30	3.32	3.32	11.09	30.00
Mid	5785	3.41	3.37	3.37	3.35	3.41	3.41	11.17	30.00
High	5825	2.36	2.35	2.33	2.31	2.36	2.36	10.13	30.00

Test mode: IEEE 802.11n HT20 mode
5725~5850MHz
chain 0:

Channel	Frequency (MHz)	Average PSD(dBm /300kHz)	10log (500kHz /RBW) Factor(dB)	Average PSD (dBm/500kHz)	Result
Low	5745	1.15	2.22	3.37	PASS
Mid	5785	0.08	2.22	2.30	PASS
High	5825	-0.69	2.22	1.53	PASS

chain 1:

Channel	Frequency (MHz)	Average PSD(dBm /300kHz)	10log (500kHz /RBW) Factor(dB)	Average PSD (dBm/500kHz)	Result
Low	5745	1.10	2.22	3.32	PASS
Mid	5785	0.09	2.22	2.31	PASS
High	5825	-0.47	2.22	1.75	PASS

chain 2:

Channel	Frequency (MHz)	Average PSD(dBm /300kHz)	10log (500kHz /RBW) Factor(dB)	Average PSD (dBm/500kHz)	Result
Low	5745	1.14	2.22	3.36	PASS
Mid	5785	0.12	2.22	2.34	PASS
High	5825	-0.52	2.22	1.70	PASS

chain 3:

Channel	Frequency (MHz)	Average PSD(dBm /300kHz)	10log (500kHz /RBW) Factor(dB)	Average PSD (dBm/500kHz)	Result
Low	5745	1.13	2.22	3.35	PASS
Mid	5785	0.09	2.22	2.31	PASS
High	5825	-0.68	2.22	1.54	PASS

chain 4:

Channel	Frequency (MHz)	Average PSD(dBm /300kHz)	10log (500kHz /RBW) Factor(dB)	Average PSD (dBm/500kHz)	Result
Low	5745	1.12	2.22	3.34	PASS
Mid	5785	0.10	2.22	2.32	PASS
High	5825	-0.52	2.22	1.70	PASS

chain 5:

Channel	Frequency (MHz)	Average PSD(dBm /300kHz)	10log (500kHz /RBW) Factor(dB)	Average PSD (dBm/500kHz)	Result
Low	5745	1.15	2.22	3.37	PASS
Mid	5785	0.06	2.22	2.28	PASS
High	5825	-0.57	2.22	1.65	PASS

Channel	Frequency (MHz)	Chain 0 Average PSD (dBm/500k Hz)	Chain 1 Average PSD (dBm/500k Hz)	Chain 2 Average PSD (dBm/500k Hz)	Chain 3 Average PSD (dBm/500k Hz)	Chain 4 Average PSD (dBm/500k Hz)	Chain 5 Average PSD (dBm/500k Hz)	Total Maximum Average PSD (dBm/500k Hz)	Average PSD Limit (dBm/500kHz)
Low	5745	3.37	3.32	3.36	3.35	3.34	3.37	11.13	30.00
Mid	5785	2.30	2.31	2.34	2.31	2.32	2.28	10.09	30.00
High	5825	1.53	1.75	1.70	1.54	1.70	1.65	9.43	30.00

Note:Duty factor has been offseted with cableloss

Remark: Total Output Power (dBm) = 10*LOG (10^(Chain 0 Average PSD / 10)+10^(Chain 1 Average PSD /10)+10^(Chain 2 Average PSD /10)+10^(Chain 3 Average PSD /10) +10^(Chain 4 Average PSD /10) +10^(Chain 5 Average PSD /10))

The Worst Test Plot

IEEE 802.11a mode
5725~5850MHz

CH Low

Agilent

R T

Mkr1 5.745 95 GHz
 1.10 dBm

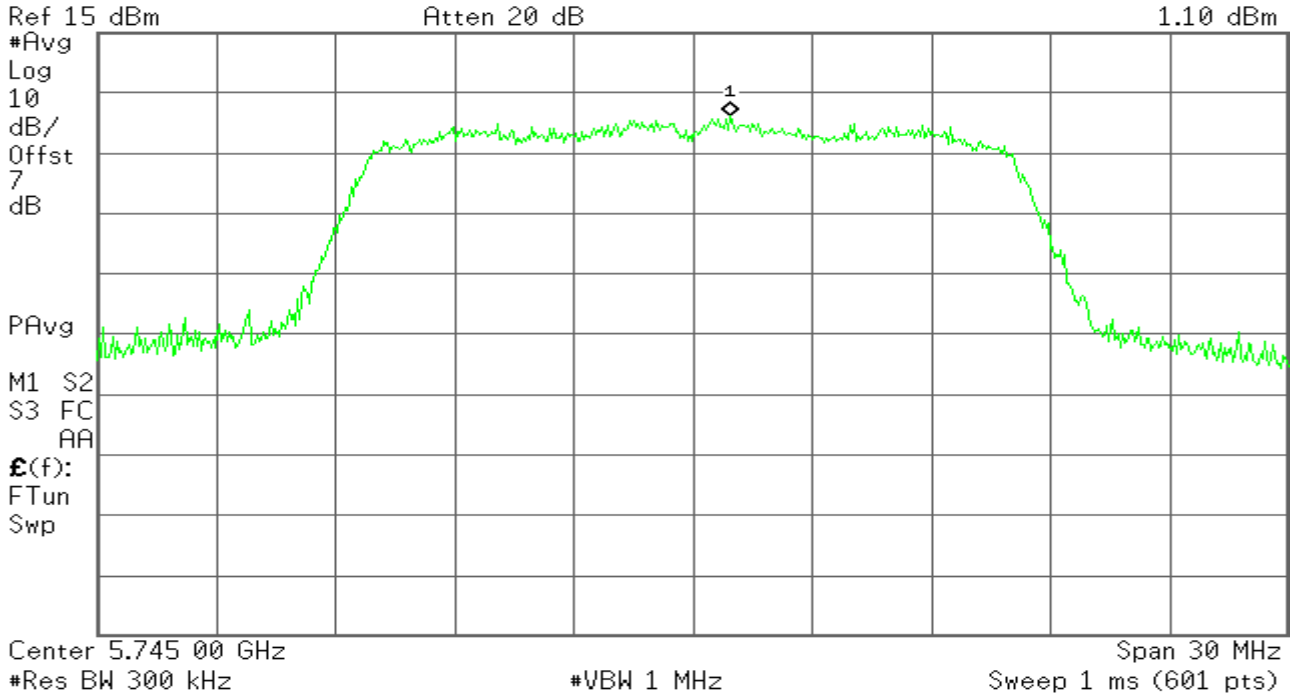

CH Mid

Agilent

R T

Mkr1 5.784 05 GHz
 1.19 dBm

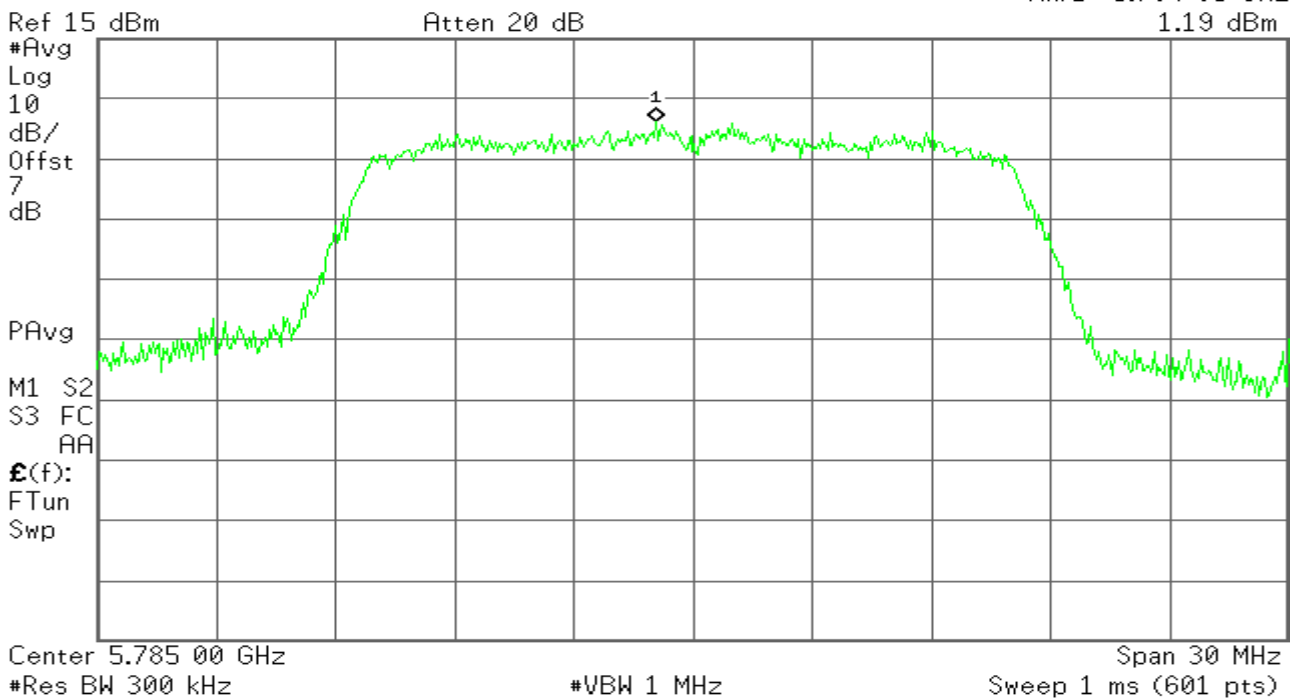

CH High

Agilent

R T

Mkr1 5.823 95 GHz
 0.14 dBm

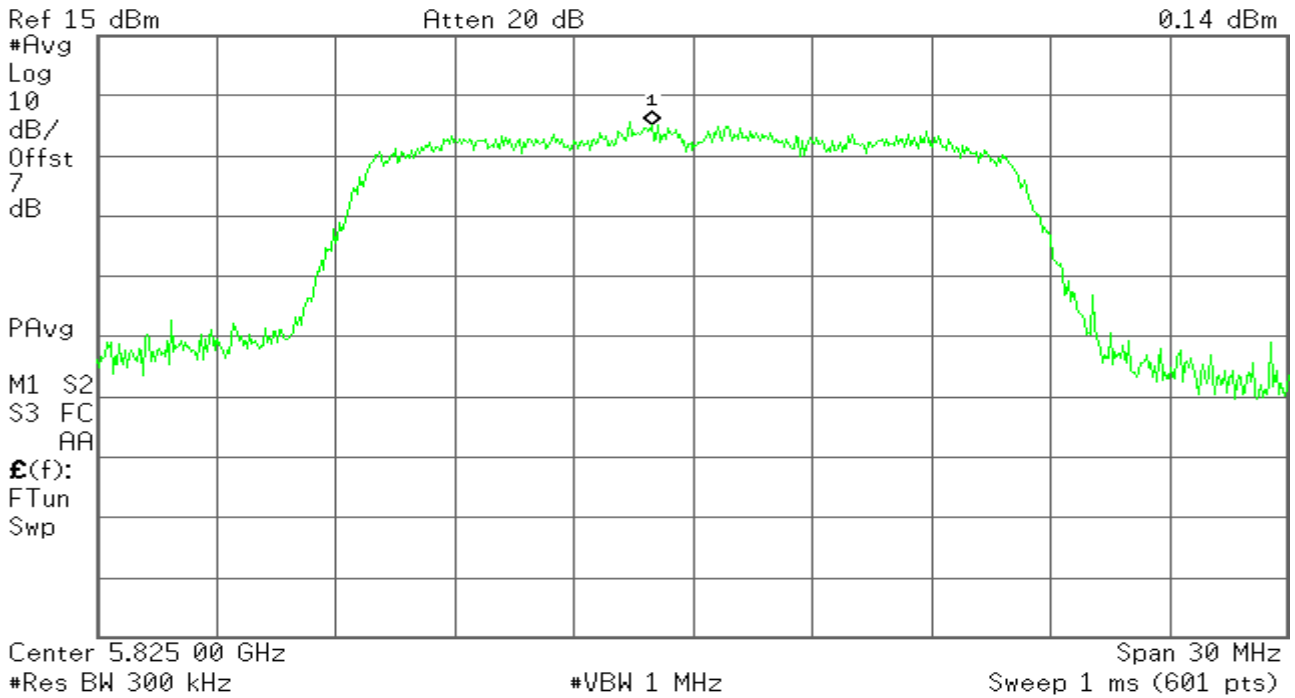

**IEEE 802.11n HT20 mode
 5725~5850MHz**

CH Low

Agilent

R T

Mkr1 5.744 40 GHz
 1.15 dBm

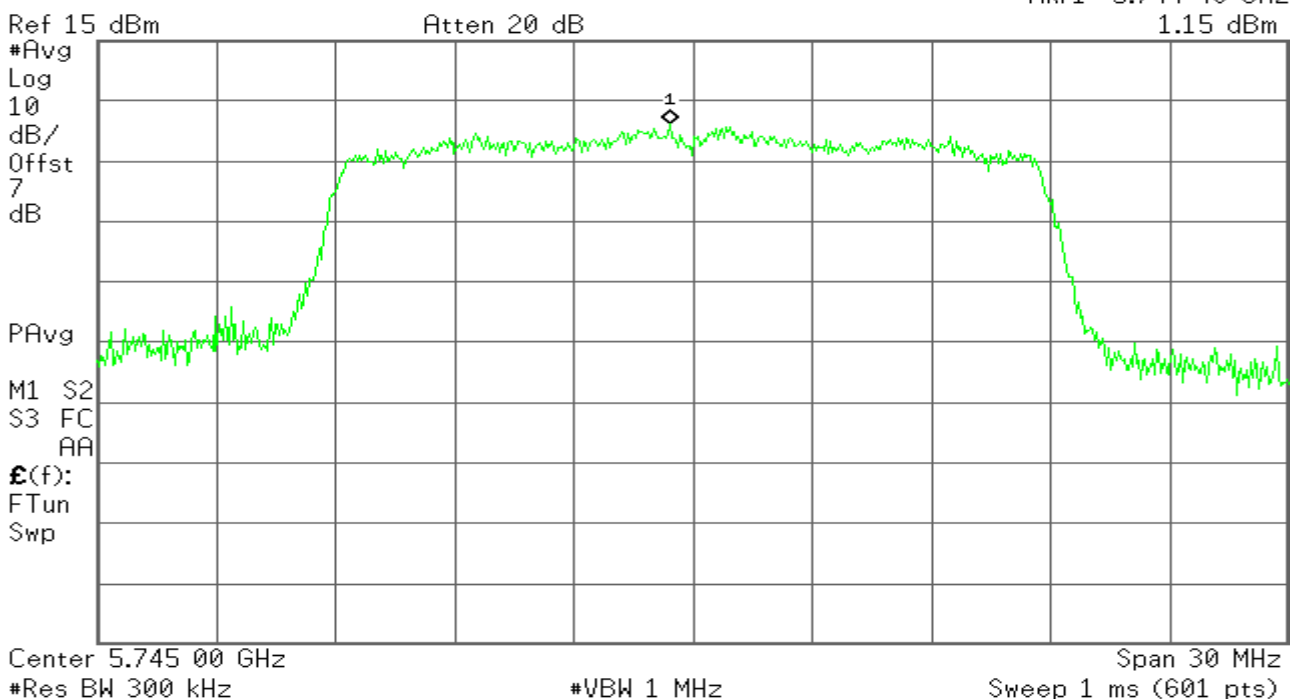

CH Mid

Agilent

R T

Mkr1 5.786 30 GHz
 0.08 dBm

Ref 15 dBm

Atten 20 dB

#Avg
 Log
 10
 dB/
 Offst
 7
 dB

PAvg

M1 S2
 S3 FC
 AA

£(f):
 FTun
 Swp

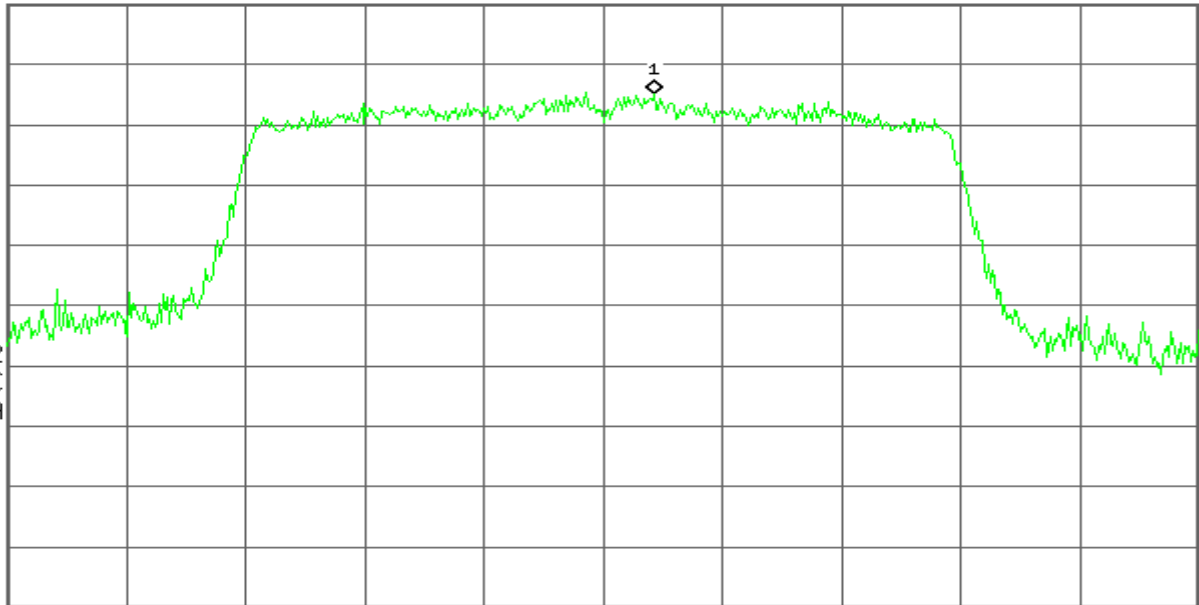

Center 5.785 00 GHz

#Res BW 300 kHz

#VBW 1 MHz

Span 30 MHz

Sweep 1 ms (601 pts)

CH High

Agilent

R T

Mkr1 5.823 65 GHz
 -0.69 dBm

Ref 15 dBm

Atten 20 dB

#Avg
 Log
 10
 dB/
 Offst
 7
 dB

PAvg

M1 S2
 S3 FC
 AA

£(f):
 FTun
 Swp

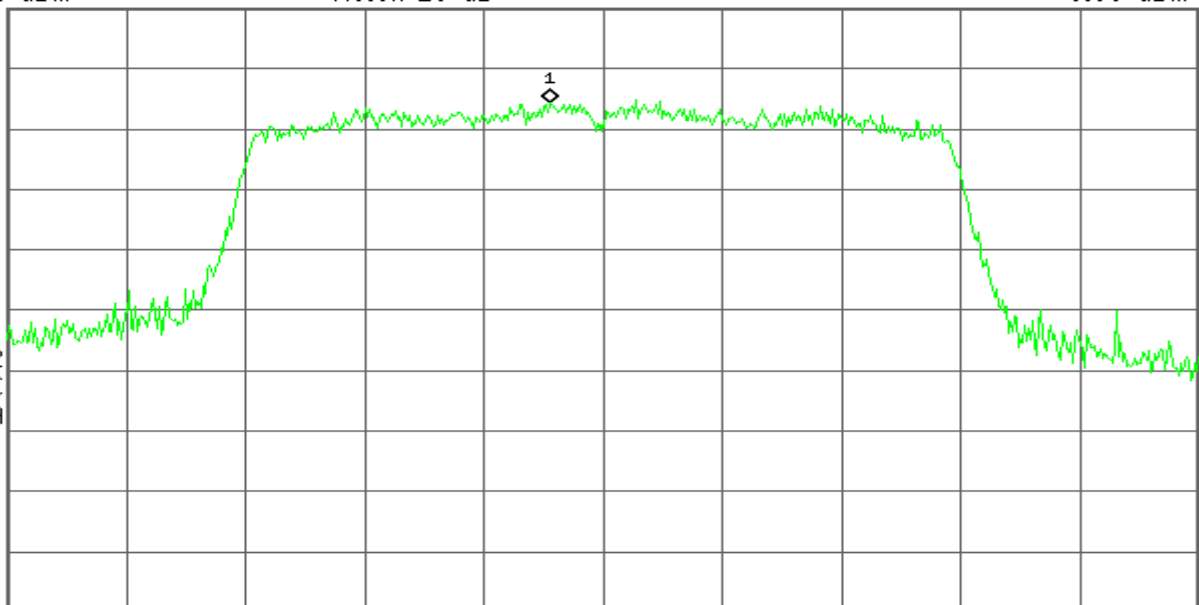

Center 5.825 00 GHz

#Res BW 300 kHz

#VBW 1 MHz

Span 30 MHz

Sweep 1 ms (601 pts)

7.5 FREQUENCY STABILITY MEASUREMENT

LIMIT

According to §15.407(g), Manufacturers of U-NII devices are responsible for ensuring frequency stability such that an emission is maintained within the band of operation under all conditions of normal operation as specified in the user's manual.

TEST CONFIGURATION

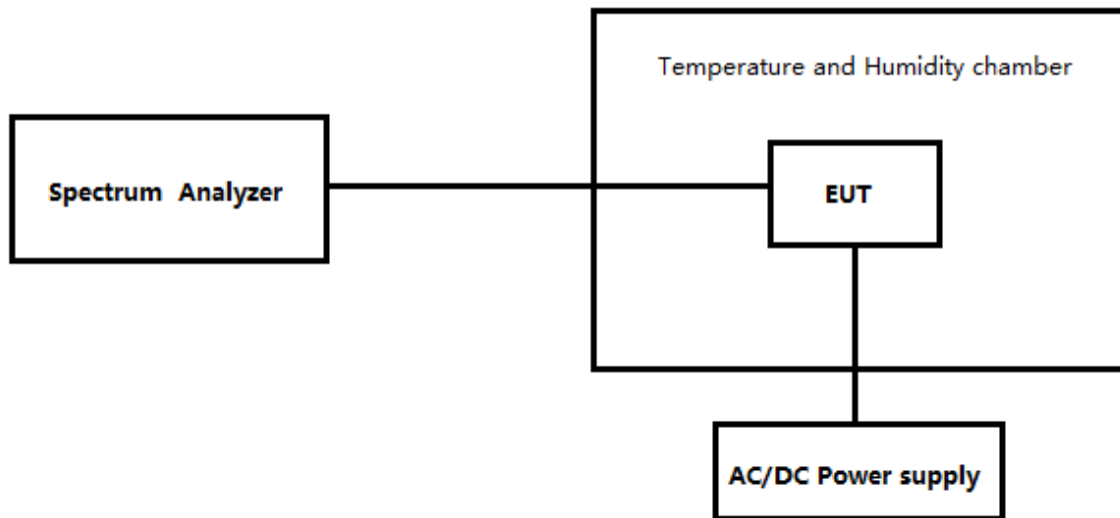

TEST PROCEDURE

1. To ensure emission at the band edge is maintained within the authorized band, those values shall be measured by radiation emissions at upper and lower frequency points, and finally compensated by frequency deviation as procedures below.
2. The EUT was operated at the maximum output power, and connected to the spectrum analyzer, which is set to maximum hold function and peak detector. The peak value of the power envelope was measured and noted. The upper and lower frequency points were respectively measured relatively 10dB lower than the measured peak value.
3. The frequency deviation was calculated by adding the upper frequency point and the lower frequency point divided by two. Those detailed values of frequency deviation are provided in table below.

THE WORSE TEST RESULTS

U-NII-3-(5725MHz-5850MHz)					
Freq.(MHz)	Center Frequency (MHz)	Frequency Deviation (MHz)	Frequency Stability (ppm)	Temperature (°C)	Voltage (V)
5745	5745.000	0.000	0.00	25	V _{min}
5745	5745.000	0.000	0.00	25	V _{max}
5745	5745.000	0.000	0.00	25	V _{nor}
5745	5745.000	0.000	0.00	-10	V _{nor}
5745	5744.992	-0.008	-1.39	50	V _{nor}

7.6 RADIATED UNDESIRABLE EMISSION

LIMIT

Radiated emissions from 9 kHz to 25 GHz were measured according to the methods defines in ANSI C63.10-2013. The EUT was placed above the ground plane, 0.8 meter for frequency below 1GHz and 1.5 meter for frequency above 1GHz. The interface cables and equipment positions were varied within limits of reasonable applications to determine the positions producing maximum radiated emissions.

1. For transmitters operating in the 5725-5850 MHz band: all emissions within the frequency range from the band edge to 10 MHz above or below the band edge shall not exceed an EIRP of -17 dBm/MHz (78.3dBµV/m); for frequencies 10 MHz or greater above or below the band edge, emissions shall not exceed an EIRP of -27 dBm/MHz (68.3dBµV/m).
2. KDB789033 v01 G)2)c) As specified in 15.407(b), emissions above 1000 MHz that are outside of the restricted bands are subject to a peak emission limit of -27 dBm/MHz (or -17 dBm/MHz as specified in 15.407(b)(4)). However, an out-of-band emission that complies with both the average and peak limits of 15.209 is not required to satisfy the -27 dBm/MHz or -17 dBm/MHz peak emission limit.
3. According to APPENDIX A Final Rules of FCC-16-24A1, For transmitters operating in the 5.725-5.85 GHz band:

All emissions shall be limited to a level of -27 dBm/MHz at 75 MHz or more above or below the band edge increasing linearly to 10 dBm/MHz at 25 MHz above or below the band edge, and from 25 MHz above or below the band edge increasing linearly to a level of 15.6 dBm/MHz at 5 MHz above or below the band edge, and from 5 MHz above or below the band edge increasing linearly to a level of 27 dBm/MHz at the band edge.

4. According to §15.209(a), except as provided elsewhere in this Subpart, the emissions from an intentional radiator shall not exceed the field strength levels specified in the following table:

FREQUENCIES(MHz)	FIELD STRENGTH (microvolts/meter)	MEASUREMENT DISTANCE(meters)
0.009~0.490	2400/F(kHz)	300
0.490~1.705	24000/F(kHz)	30
1.705~30.0	30	30
30~88	100	3
88~216	150	3
216~960	200	3
Above 960	500	3

Remark: Except as provided in paragraph (g), fundamental emissions from intentional radiators operating under this Section shall not be located in the frequency bands 54-72 MHz, 76-88 MHz, 174-216 MHz or 470-806 MHz. However, operation within these frequency bands is permitted under other sections of this Part, e.g., Sections 15.231 and 15.241.

5. In the emission table above, the tighter limit applies at the band edges.

Frequency (MHz)	Field Strength (µV/m at 3-meter)	Field Strength (dBµV/m at 3-meter)
30-88	100	40
88-216	150	43.5
216-960	200	46
Above 960	500	54

Test Configuration

Below 30MHz

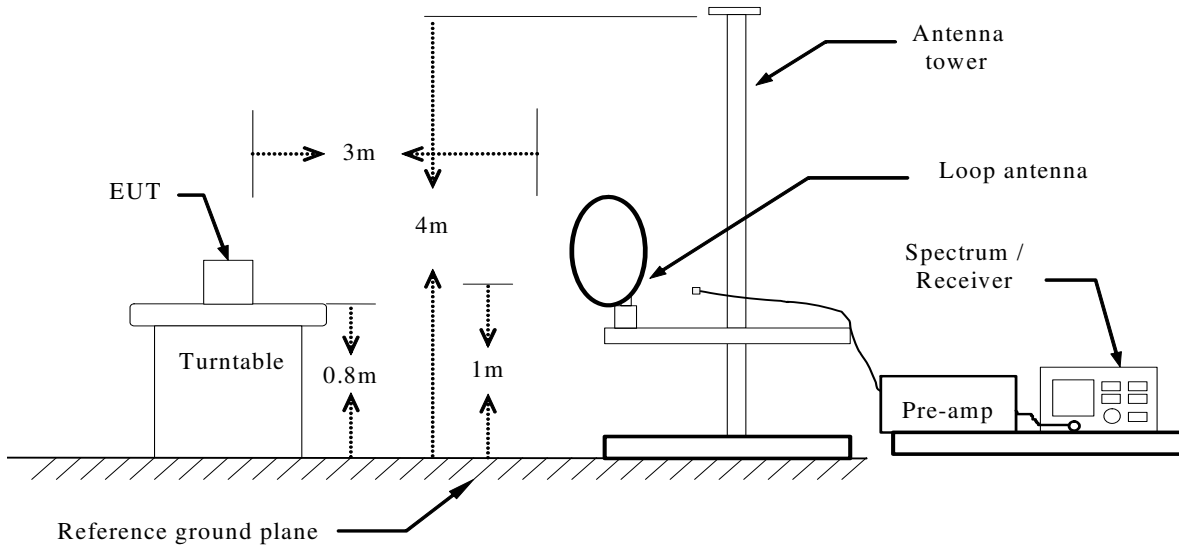

Below 1 GHz

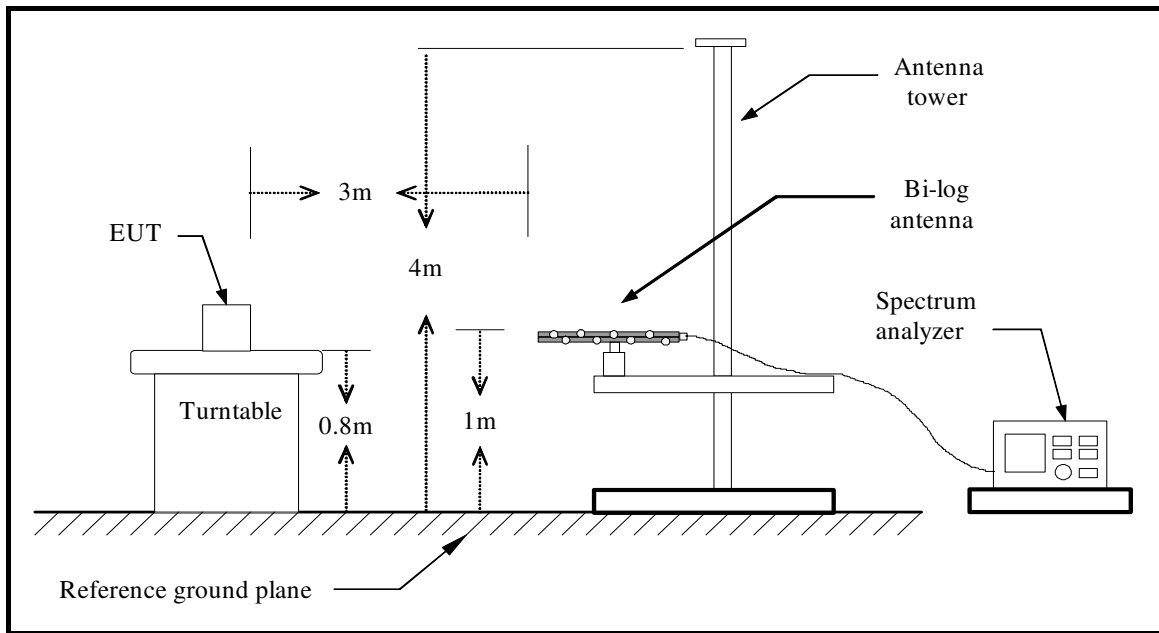

Above 1 GHz

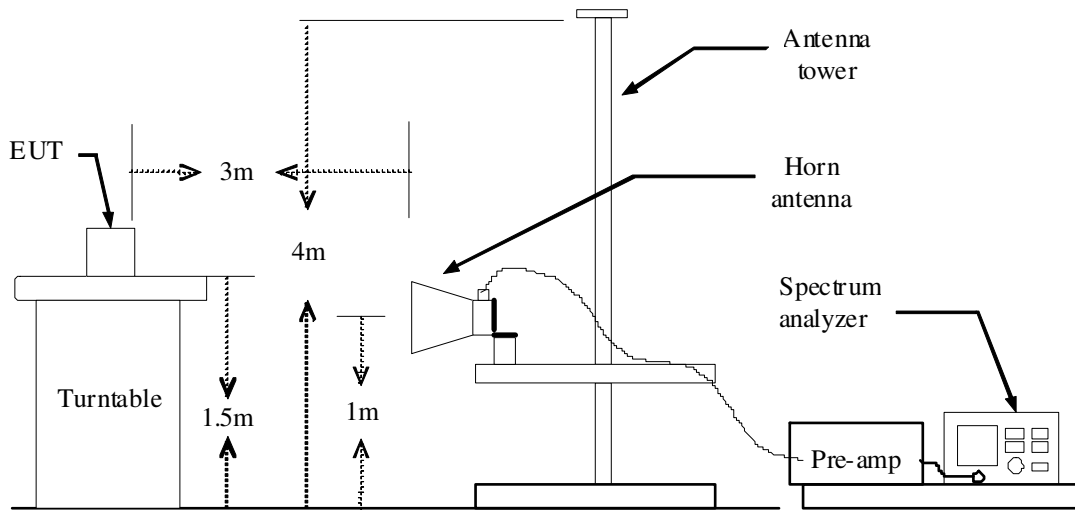

TEST PROCEDURE

1. The EUT is placed on a turntable above ground plane, which is 0.8 meter for frequency below 1GHz and 1.5 meter for frequency above 1GHz.
2. The turntable shall be rotated for 360 degrees to determine the position of maximum emission level.
3. EUT is set 3m away from the receiving antenna, which is varied from 1m to 4m to find out the highest emissions.
4. Maximum procedure was performed on the six highest emissions to ensure EUT compliance.
5. And also, each emission was to be maximized by changing the polarization of receiving antenna both horizontal and vertical.
6. Set the spectrum analyzer in the following setting as:

Below 1GHz:

RBW=100kHz / VBW=300kHz / Sweep=AUTO

Above 1GHz:

(a) PEAK: RBW=VBW=1MHz / Sweep=AUTO

(b) AVERAGE: RBW=1MHz / Sweep=AUTO

VBW=10Hz,when duty cycle is no less than 98 percent.

VBW $\geq 1/T$,when duty cycle is less than 98 percent,where T is the minimum transmission duration over which the transmitter is on and is transmitting at its maximum power control level for the tested mode of operation.

Band	Duty Cycle(%)	T(ms)	1/T(kHz)	VBW Setting
IEEE 802.11 a	99	-	-	10Hz
IEEE 802.11n HT20	99	-	-	10Hz

7. Repeat above procedures until the measurements for all frequencies are complete.

Test Result of Radiated Emission
Below 30MHz

The interference of the frequency value is lower than the limit below 20 db, measured as the background noise values and will not be recorded.

30MHz-1GHz

Operation Mode:	Normal Link	Test Date:	2017-3-12
Temperature:	25°C	Tested by:	Lily.Wang
Humidity:	48% RH	Polarity:	Ver. / Hor.

Frequency (MHz)	Ant. Pol. (H/V)	Reading (dBuV)	Correction Factor (dB/m)	Result (dBuV/m)	Limit (dBuV/m)	Margin (dB)	Remark
30.1500	V	14.32	22.21	36.53	40.00	-3.47	QP
41.7500	V	20.42	16.20	36.62	40.00	-3.38	QP
61.0400	V	24.96	10.91	35.87	40.00	-4.13	QP
206.5400	V	18.08	16.40	34.48	40.00	-5.52	peak
971.8700	V	11.07	27.34	38.41	47.00	-8.59	peak
991.2700	V	14.43	27.64	42.07	47.00	-4.93	peak
206.3850	H	20.92	16.40	37.32	40.00	-2.68	QP
212.2150	H	19.66	16.32	35.98	40.00	-4.02	QP
213.3300	H	21.23	16.31	37.54	40.00	-2.46	QP
216.2400	H	20.28	16.27	36.55	40.00	-3.45	QP
216.2450	H	19.41	16.27	35.68	40.00	-4.32	QP
991.2700	H	11.88	27.64	39.52	47.00	-7.48	peak

Remark:

1. Measuring frequencies from 30 MHz to the 1GHz.(no emission found from the lowest internal used/generated frequency to 30MHz)
2. Radiated emissions measured were made with an instrument using peak/quasi-peak detector mode.
3. Quasi-peak test would be performed if the peak result were greater than the quasi-peak limit or as required by the applicant.
4. Measurements above show only up to 6 maximum emissions noted, or would be lesser, with " N/A " remark, if no specific emissions from the EUT are recorded (ie: margin>20dB from the applicable limit) and considered that's already beyond the background noise floor.
5. Margin (dB) = Remark result (dBuV/m) – Quasi-peak limit (dBuV/m).

Above 1 GHz

Operation Mode:	Tx / IEEE 802.11a mode CH Low	Test Date:	2017-3-12
Temperature:	25°C	Tested by:	Lily.Wang
Humidity:	55% RH	Polarity:	Ver. / Hor.

Horizontal

No.	Frequency (MHz)	Reading (dBuV)	Correct Factor(dB/m)	Result (dBuV/m)	Limit (dBuV/m)	Margin (dB)	Height (cm)	Degree (deg.)	Remark
1	11353.000	38.63	12.35	50.98	74.00	-23.02	100	281	peak
2	15943.000	37.13	12.22	49.35	74.00	-24.65	100	61	peak
3	N/A								
4									
5									
6									

Vertical

No.	Frequency (MHz)	Reading (dBuV)	Correct Factor(dB/m)	Result (dBuV/m)	Limit (dBuV/m)	Margin (dB)	Height (cm)	Degree (deg.)	Remark
1	11557.000	37.47	12.16	49.63	74.00	-24.37	100	343	peak
2	16674.000	37.73	13.42	51.15	74.00	-22.85	100	278	peak
3	N/A								
4									
5									
6									

Operation Mode:	Tx / IEEE 802.11a mode CH Mid	Test Date:	2017-3-12
Temperature:	25°C	Tested by:	Lily.Wang
Humidity:	55% RH	Polarity:	Ver. / Hor.

Horizontal

No.	Frequency (MHz)	Reading (dBuV)	Correct Factor(dB/m)	Result (dBuV/m)	Limit (dBuV/m)	Margin (dB)	Height (cm)	Degree (deg.)	Remark
1	11727.000	37.80	12.00	49.80	74.00	-24.20	100	124	peak
2	16538.000	37.35	13.11	50.46	74.00	-23.54	100	103	peak
3	N/A								
4									
5									
6									

Vertical

No.	Frequency (MHz)	Reading (dBuV)	Correct Factor(dB/m)	Result (dBuV/m)	Limit (dBuV/m)	Margin (dB)	Height (cm)	Degree (deg.)	Remark
1	11523.000	36.88	12.19	49.07	74.00	-24.93	100	134	peak
2	16334.000	38.08	12.65	50.73	74.00	-23.27	100	313	peak
3	N/A								
4									
5									
6									

Operation Mode:	Tx / IEEE 802.11a mode CH High	Test Date:	2017-3-12
Temperature:	25°C	Tested by:	Lily.Wang
Humidity:	55% RH	Polarity:	Ver. / Hor.

Horizontal

No.	Frequency (MHz)	Reading (dBuV)	Correct Factor(dB/m)	Result (dBuV/m)	Limit (dBuV/m)	Margin (dB)	Height (cm)	Degree (deg.)	Remark
1	11710.000	40.00	12.02	52.02	74.00	-21.98	100	349	peak
2	16334.000	38.29	12.65	50.94	74.00	-23.06	100	341	peak
3	N/A								
4									
5									
6									

Vertical

No.	Frequency (MHz)	Reading (dBuV)	Correct Factor(dB/m)	Result (dBuV/m)	Limit (dBuV/m)	Margin (dB)	Height (cm)	Degree (deg.)	Remark
1	12458.000	37.58	12.81	50.39	74.00	-23.61	100	62	peak
2	16929.000	37.99	13.99	51.98	74.00	-22.02	100	156	peak
3	N/A								
4									
5									
6									

Operation Mode:	TX / IEEE 802.11n HT20 mode /CH Low	Test Date:	2017-3-12
Temperature:	25°C	Tested by:	Lily.Wang
Humidity:	55% RH	Polarity:	Ver. / Hor.

Horizontal

No.	Frequency (MHz)	Reading (dBuV)	Correct Factor(dB/m)	Result (dBuV/m)	Limit (dBuV/m)	Margin (dB)	Height (cm)	Degree (deg.)	Remark
1	12458.000	39.78	12.81	52.59	74.00	-21.41	100	262	peak
2	16283.000	39.24	12.54	51.78	74.00	-22.22	100	38	peak
3	N/A								
4									
5									
6									

Vertical

No.	Frequency (MHz)	Reading (dBuV)	Correct Factor(dB/m)	Result (dBuV/m)	Limit (dBuV/m)	Margin (dB)	Height (cm)	Degree (deg.)	Remark
1	12067.000	39.85	11.90	51.75	74.00	-22.25	100	236	peak
2	16249.000	39.71	12.46	52.17	74.00	-21.83	100	97	peak
3	N/A								
4									
5									
6									

Operation Mode:	TX / IEEE 802.11n HT20 mode /CH Mid	Test Date:	2017-3-12
Temperature:	25°C	Tested by:	Lily.Wang
Humidity:	55% RH	Polarity:	Ver. / Hor.

Horizontal

No.	Frequency (MHz)	Reading (dBuV)	Correct Factor(dB/m)	Result (dBuV/m)	Limit (dBuV/m)	Margin (dB)	Height (cm)	Degree (deg.)	Remark
1	12322.000	38.52	12.49	51.01	74.00	-22.99	100	272	peak
2	16215.000	38.36	12.38	50.74	74.00	-23.26	100	349	peak
3	N/A								
4									
5									
6									

Vertical

No.	Frequency (MHz)	Reading (dBuV)	Correct Factor(dB/m)	Result (dBuV/m)	Limit (dBuV/m)	Margin (dB)	Height (cm)	Degree (deg.)	Remark
1	12101.000	39.43	11.98	51.41	74.00	-22.59	100	359	peak
2	16555.000	36.44	13.15	49.59	74.00	-24.41	100	359	peak
3	N/A								
4									
5									
6									

Operation Mode:	TX / IEEE 802.11n HT20 mode /CH High	Test Date:	2017-3-12
Temperature:	25°C	Tested by:	Lily.Wang
Humidity:	55% RH	Polarity:	Ver. / Hor.

Horizontal

No.	Frequency (MHz)	Reading (dBuV)	Correct Factor(dB/m)	Result (dBuV/m)	Limit (dBuV/m)	Margin (dB)	Height (cm)	Degree (deg.)	Remark
1	11727.000	38.15	12.00	50.15	74.00	-23.85	100	274	peak
2	16283.000	38.50	12.54	51.04	74.00	-22.96	100	197	peak
3	N/A								
4									
5									
6									

Vertical

No.	Frequency (MHz)	Reading (dBuV)	Correct Factor(dB/m)	Result (dBuV/m)	Limit (dBuV/m)	Margin (dB)	Height (cm)	Degree (deg.)	Remark
1	12458.000	38.24	12.81	51.05	74.00	-22.95	100	101	peak
2	16521.000	35.62	13.07	48.69	74.00	-25.31	100	49	peak
3	N/A								
4									
5									
6									

Remark:

1. *Measuring frequencies from 1 GHz to the 10th harmonic of highest fundamental frequency.*
2. *Radiated emissions measured in frequency above 1000MHz were made with an instrument using peak/average detector mode.*
3. *Average test would be performed if the peak result were greater than the average limit.*
4. *Data of measurement within this frequency range shown “ --- ” in the table above means the reading of emissions are attenuated more than 20dB below the permissible limits or the field strength is too small to be measured.*
5. *Measurements above show only up to 3 maximum emissions noted, or would be lesser, with “ N/A ” remark, if no specific emissions from the EUT are recorded (ie: margin>20dB from the applicable limit) and considered that's already beyond the background noise floor.*
6. *Margin (dB) = Remark result (dBuV/m) – Average limit (dBuV/m).*

7.7 POWERLINE CONDUCTED EMISSIONS

LIMIT

For equipment that is designed to be connected to the public utility (AC) power line, the radio frequency voltage that is conducted back onto the AC power line on any frequency or frequencies within the band 150 kHz to 30 MHz shall not exceed the limits in the following table.

Frequency Range (MHz)	Limits (dB μ V)	
	Quasi-peak	Average
0.15 to 0.50	66 to 56*	56 to 46*
0.50 to 5	56	46
5 to 30	60	50

* Decreases with the logarithm of the frequency.

TEST CONFIGURATION

See test photographs attached in Appendix 1 for the actual connections between EUT and support equipment.

TEST PROCEDURE

1. The EUT was placed on a table, which is 0.8m above ground plane.
2. Maximum procedure was performed on the six highest emissions to ensure EUT compliance.
3. Repeat above procedures until all frequency measured were complete.

TEST RESULTS

The initial step in collecting conducted data is a spectrum analyzer peak scan of the measurement range. Significant peaks are then marked as shown on the following data page, and these signals are then quasi-peaked.

Test Data

Job No.:	C161220R01	Date:	2017-3-14
Model No.:	YVR.1717	Time:	PM 04:32:43
Standard:	FCC Class B	Temp.(C)/Hum.(%):	22(C)/48%
Test item:	Conduction test	Test By:	Lily.Wang
Line:	L1	Test Voltage:	AC 120V/60Hz
Model:		Description:	

L1

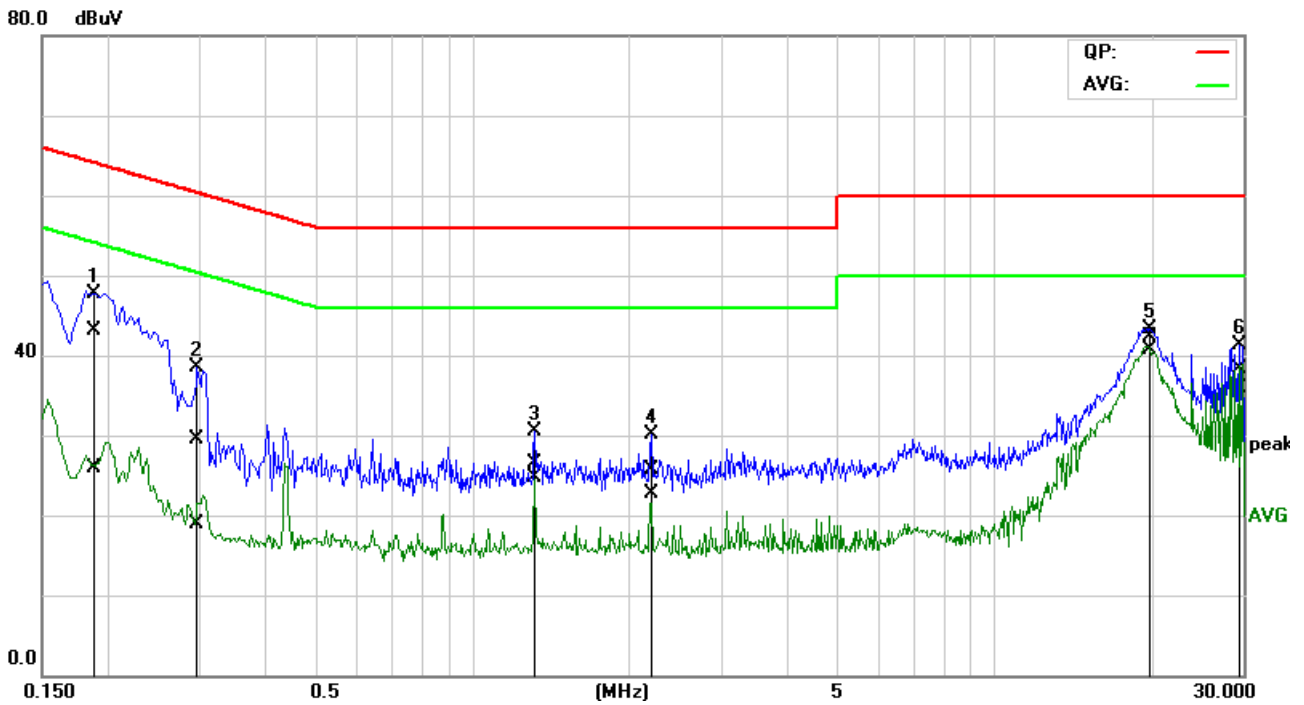

No.	Frequency (MHz)	QuasiPeak reading (dBuV)	Average reading (dBuV)	Correction factor (dB)	QuasiPeak result (dBuV)	Average result (dBuV)	QuasiPeak limit (dBuV)	Average limit (dBuV)	QuasiPeak margin (dB)	Average margin (dB)	Remark
1	0.1855	23.30	6.06	19.79	43.09	25.85	64.23	54.24	-21.14	-28.39	Pass
2	0.2991	9.76	-0.93	19.80	29.56	18.87	60.27	50.27	-30.71	-31.40	Pass
3	1.3194	6.68	4.81	19.81	26.49	24.62	56.00	46.00	-29.51	-21.38	Pass
4	2.1991	5.89	2.89	19.85	25.74	22.74	56.00	46.00	-30.26	-23.26	Pass
5*	19.9158	22.11	20.66	20.11	42.22	40.77	60.00	50.00	-17.78	-9.23	Pass
6	29.4679	18.13	15.56	20.27	38.40	35.83	60.00	50.00	-21.60	-14.17	Pass

Note: 1. L1 = Line One (Live Line) / L2 = Line Two (Neutral Line).

Job No.:	C161220R01	Date:	2017-3-14
Model No.:	YVR.1717	Time:	PM 04:37:24
Standard:	FCC Class B	Temp.(C)/Hum.(%):	22(C)/48%
Test item:	Conduction test	Test By:	Lily.Wang
Line:	L2	Test Voltage:	AC 120V/60Hz
Model:		Description:	

L2

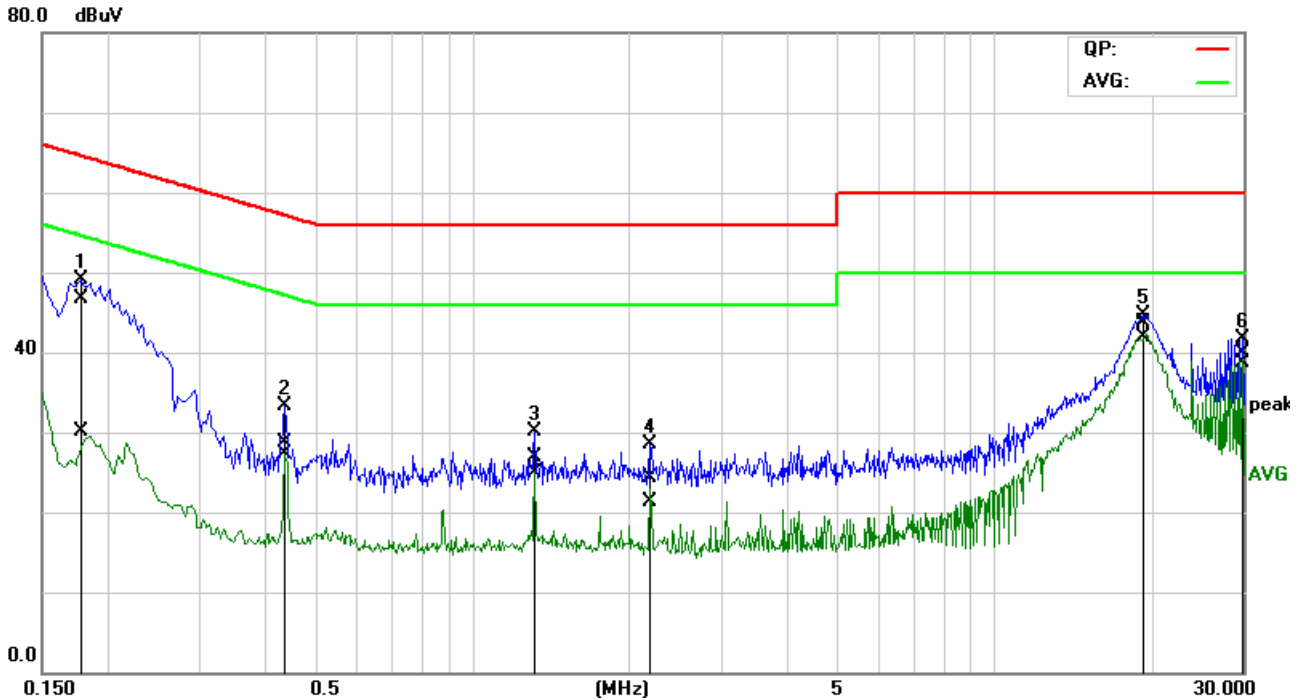

No.	Frequency (MHz)	QuasiPeak reading (dBuV)	Average reading (dBuV)	Correction factor (dB)	QuasiPeak result (dBuV)	Average result (dBuV)	QuasiPeak limit (dBuV)	Average limit (dBuV)	QuasiPeak margin (dB)	Average margin (dB)	Remark
1	0.1782	26.90	10.32	19.74	46.64	30.06	64.56	54.57	-17.92	-24.51	Pass
2	0.4378	8.88	7.51	19.75	28.63	27.26	57.10	47.10	-28.47	-19.84	Pass
3	1.3192	7.09	5.20	19.75	26.84	24.95	56.00	46.00	-29.16	-21.05	Pass
4	2.2004	4.56	1.44	19.77	24.33	21.21	56.00	46.00	-31.67	-24.79	Pass
5*	19.2495	23.26	21.52	20.38	43.64	41.90	60.00	50.00	-16.36	-8.10	Pass
6	29.8850	19.38	18.19	20.57	39.95	38.76	60.00	50.00	-20.05	-11.24	Pass

Note: 1. L1 = Line One (Live Line) / L2 = Line Two (Neutral Line).

Job No.:	C161220R01	Date:	2017-3-14
Model No.:	YVR.1717	Time:	PM 04:42:46
Standard:	FCC Class B	Temp.(C)/Hum.(%):	22(C)/48%
Test item:	Conduction test	Test By:	Lily.Wang
Line:	L1	Test Voltage:	AC 240V/60Hz
Model:		Description:	

L1

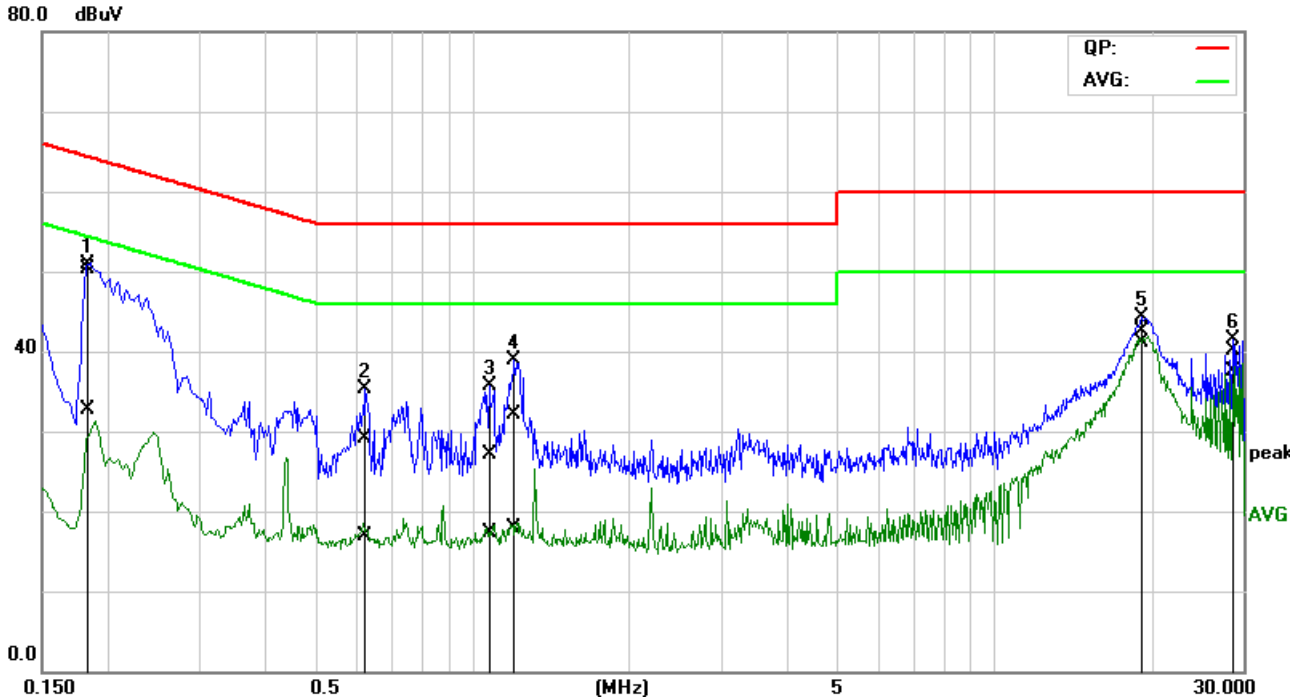

No.	Frequency (MHz)	QuasiPeak reading (dBuV)	Average reading (dBuV)	Correction factor (dB)	QuasiPeak result (dBuV)	Average result (dBuV)	QuasiPeak limit (dBuV)	Average limit (dBuV)	QuasiPeak margin (dB)	Average margin (dB)	Remark
1	0.1814	30.51	12.82	19.79	50.30	32.61	64.42	54.42	-14.12	-21.81	Pass
2	0.6274	9.35	-2.83	19.80	29.15	16.97	56.00	46.00	-26.85	-29.03	Pass
3	1.0788	7.22	-2.51	19.79	27.01	17.28	56.00	46.00	-28.99	-28.72	Pass
4	1.1973	12.38	-1.90	19.80	32.18	17.90	56.00	46.00	-23.82	-28.10	Pass
5*	19.1404	22.34	20.96	20.10	42.44	41.06	60.00	50.00	-17.56	-8.94	Pass
6	28.6004	19.80	17.22	20.25	40.05	37.47	60.00	50.00	-19.95	-12.53	Pass

Note: 1. L1 = Line One (Live Line) / L2 = Line Two (Neutral Line).

Job No.:	C161220R01	Date:	2017-3-14
Model No.:	YVR.1717	Time:	PM 04:47:18
Standard:	FCC Class B	Temp.(C)/Hum.(%):	22(C)/48%
Test item:	Conduction test	Test By:	Lily.Wang
Line:	L2	Test Voltage:	AC 240V/60Hz
Model:		Description:	

L2

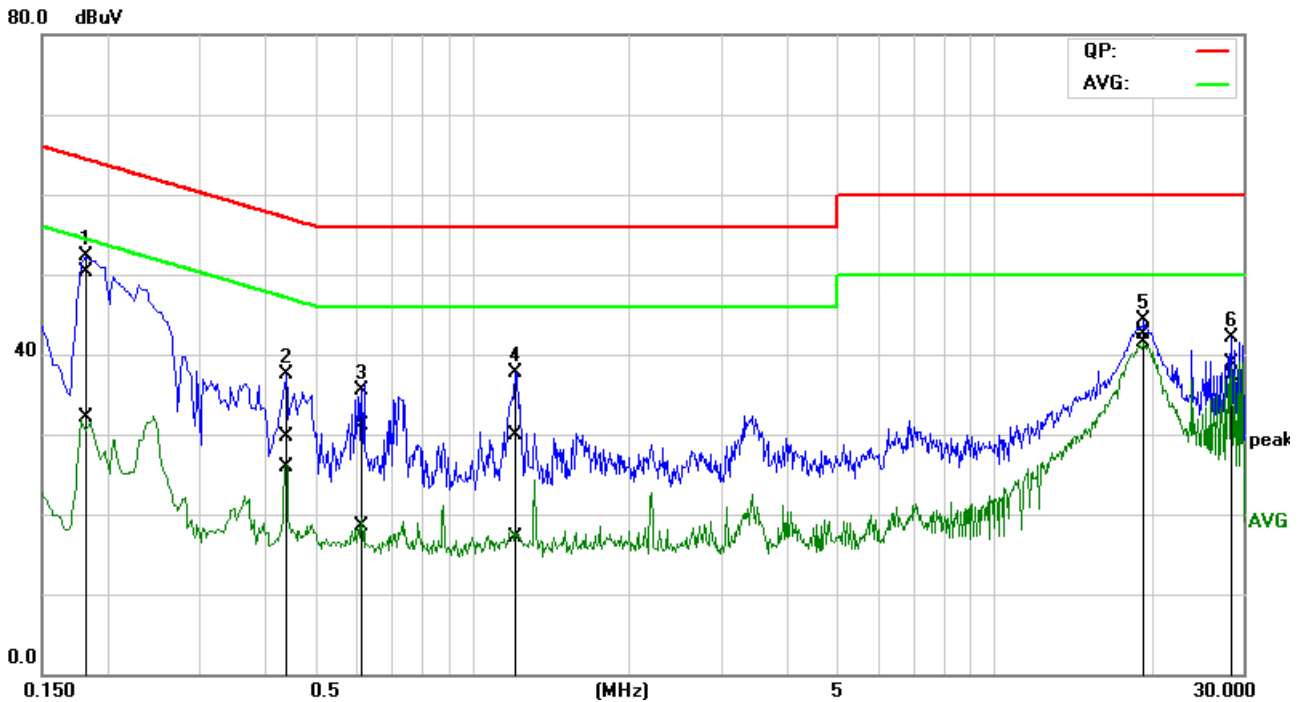

No.	Frequency (MHz)	QuasiPeak reading (dBuV)	Average reading (dBuV)	Correction factor (dB)	QuasiPeak result (dBuV)	Average result (dBuV)	QuasiPeak limit (dBuV)	Average limit (dBuV)	QuasiPeak margin (dB)	Average margin (dB)	Remark
1	0.1816	30.47	12.45	19.74	50.21	32.19	64.41	54.41	-14.20	-22.22	Pass
2	0.4415	9.86	6.18	19.75	29.61	25.93	57.03	47.03	-27.42	-21.10	Pass
3	0.6102	11.37	-1.28	19.75	31.12	18.47	56.00	46.00	-24.88	-27.53	Pass
4	1.2055	10.16	-2.59	19.74	29.90	17.15	56.00	46.00	-26.10	-28.85	Pass
5*	19.3375	22.18	21.06	20.38	42.56	41.44	60.00	50.00	-17.44	-8.56	Pass
6	28.5813	18.28	16.78	20.54	38.82	37.32	60.00	50.00	-21.18	-12.68	Pass

Note: 1. L1 = Line One (Live Line) / L2 = Line Two (Neutral Line).

Remark:

- 1.The measuring frequencies range between 0.15 MHz and 30 MHz.
- 2.The emissions measured in the frequency range between 0.15 MHz and 30MHz were made with an instrument using Quasi-peak detector and Average detector.
- 3.“---” denotes the emission level was or more than 2dB below the Average limit, and no re-check was made.
- 4.The IF bandwidth of SPA between 0.15MHz and 30MHz was 10KHz. The IF bandwidth of Test Receiver between 0.15MHz and 30MHz was 9kHz.

END OF REPORT