

# FCC 47 CFR PART15 SUBPART E

For

Prepared by

Product Name: YI 360 VR Camera

Brand Name: YI

Model No.: YVR.1017

Series Model.: N/A

FCC ID: 2AFIB-YVR1017

Test Report Number:

C170630R01-RPW1

Issued for

Shanghai Xiaoyi Technology Co., Ltd.

6F,Building E,No.2889,Jinke Road,Shanghai,China

Issued by

Compliance Certification Services Inc.

Kun shan Laboratory

No.10 Weiye Rd., Innovation park, Eco&Tec,  
Development Zone, Kunshan City, Jiangsu, China

TEL: 86-512-57355888

FAX: 86-512-57370818



**Note:** This report shall not be reproduced except in full, without the written approval of Compliance Certification Services Inc. This document may be altered or revised by Compliance Certification Services Inc. personnel only, and shall be noted in the revision section of the document. The client should not use it to claim product endorsement by A2LA or any government agencies. The test results in the report only apply to the tested sample.

## TABLE OF CONTENTS

<b>1</b>	<b>TEST RESULT CERTIFICATION .....</b>	<b>4</b>
<b>2</b>	<b>EUT DESCRIPTION.....</b>	<b>5</b>
<b>3</b>	<b>TEST METHODOLOGY.....</b>	<b>6</b>
3.1	EUT CONFIGURATION .....	6
3.2	EUT EXERCISE.....	6
3.3	GENERAL TEST PROCEDURES.....	6
3.4	FCC PART 15.205 RESTRICTED BANDS OF OPERATIONS .....	7
3.5	DESCRIPTION OF TEST MODES.....	8
3.6	ANTENNA DESCRIPTION.....	9
<b>4</b>	<b>INSTRUMENT CALIBRATION .....</b>	<b>10</b>
4.1	MEASUREMENT EQUIPMENT USED .....	10
4.2	MEASUREMENT UNCERTAINTY .....	11
<b>5</b>	<b>FACILITIES AND ACCREDITATIONS .....</b>	<b>12</b>
5.1	FACILITIES.....	12
5.2	EQUIPMENT.....	12
5.3	TABLE OF ACCREDITATIONS AND LISTINGS .....	12
5.4	TABLE OF ACCREDITATIONS AND LISTINGS.....	13
<b>6</b>	<b>SETUP OF EQUIPMENT UNDER TEST .....</b>	<b>14</b>
6.1	SETUP CONFIGURATION OF EUT.....	14
6.2	SUPPORT EQUIPMENT.....	14
<b>7</b>	<b>FCC PART 15 REQUIREMENTS .....</b>	<b>15</b>
7.1	26 DB EMISSION BANDWIDTH.....	15
7.2	99% DB EMISSION BANDWIDTH.....	20
7.3	MAXIMUM CONDUCTED OUTPUT POWER .....	25
7.4	BAND EDGES MEASUREMENT .....	27
7.5	MAXIMUM POWER SPECTRAL DENSITY.....	30
7.6	FREQUENCY STABILITY MEASUREMENT.....	35
7.7	RADIATED UNDESIRABLE EMISSION .....	37
7.8	POWERLINE CONDUCTED EMISSIONS .....	44

### Revision History

Rev.	Issue Date	Report NO.	Effect Page	Contents
00	August 10, 2017	C170630R01-RPW1	ALL	N/A
01	August 23, 2017	C170630R01-RPW1	P5	Update antenna gain information

# 1 TEST RESULT CERTIFICATION

<b>Product Name:</b>	YI 360 VR Camera
<b>Trade Name:</b>	YI
<b>Model Name.:</b>	YVR.1017
<b>Series Model:</b>	N/A
<b>Applicant Discrepancy:</b>	Initial
<b>Device Category:</b>	Portable unit
<b>Date of Test:</b>	July 22, 2017 ~ August 09, 2017
<b>Applicant:</b>	<b>Shanghai Xiaoyi Technology Co., Ltd.</b> 6F,Building E,No.2889,Jinke Road,Shanghai,China
<b>Manufacturer:</b>	<b>Shanghai Xiaoyi Technology Co., Ltd.</b> 6F,Building E,No.2889,Jinke Road,Shanghai,China
<b>Application Type:</b>	Certification

APPLICABLE STANDARDS	
STANDARD	TEST RESULT
FCC 47 CFR Part 15 Subpart E	No non-compliance noted

The above equipment was tested by Compliance Certification Services Inc. The test data, data evaluation, test procedures, and equipment configurations shown in this report were made in accordance with the procedures given in ANSI C63.10: 2013 and the energy emitted by the sample EUT tested as described in this report is in compliance with the requirements of FCC Rules Part 15.207, 15.209, 15.407 and KDB 789033.

The test results of this report relate only to the tested sample EUT identified in this report.

**Approved by:**

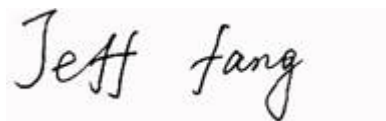

Jeff.Fang  
RF Manager  
Compliance Certification Service Inc.

**Tested by:**

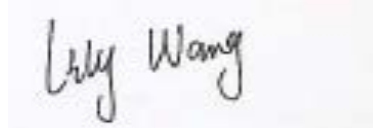

Lily.Wang  
Test Engineer  
Compliance Certification Service Inc.

## 2 EUT DESCRIPTION

<b>Product Name:</b>	YI 360 VR Camera			
<b>Brand Name:</b>	YI			
<b>Model Name:</b>	YVR.1017			
<b>Series Model:</b>	N/A			
<b>Model Discrepancy:</b>	N/A			
<b>Power Adapter:</b>	From PC			
<b>Frequency Range :</b>	Band	Mode	Frequency Range(MHz)	Number of Channels
	Band I UNII-I	IEEE802.11a mode IEEE802.11an HT20 mode	5150 MHz~5250 MHz	4 4
<b>Transmit Power :</b>	IEEE802.11a mode:9.52dBm IEEE802.11an HT20 mode: 8.27dBm			
<b>Modulation Technique :</b>	IEEE802.11a mode: OFDM (6,9,12,18,24,36,48 and 54 Mbps) IEEE802.11an HT20 mode: OFDM (MCS0~MCS7)			
<b>Antenna Specification:</b>	FPC Antenna Gain: 2.53dBi			

**Remark:**

1. The sample selected for test was engineering sample that approximated to production product and was provided by manufacturer.
2. This submittal(s) (test report) is intended for **FCC ID: 2AFIB-YVR1017** filing to comply with FCC Part 15, Subpart E Rules.

### 3 TEST METHODOLOGY

The tests documented in this report were performed in accordance with ANSI C63.10:2013 and FCC CFR 47 15.207, 15.209 and 15.407.

#### 3.1 EUT CONFIGURATION

The EUT configuration for testing is installed for RF field strength measurement to meet the Commissions requirement, and is operated in a manner intended to generate the maximum emission in a continuous normal application.

#### 3.2 EUT EXERCISE

The EUT is operated in the engineering mode to fix the Tx frequency for the purposes of measurement.

According to its specifications, the EUT must comply with the requirements of Section 15.407 under the FCC Rules Part 15 Subpart E.

#### 3.3 GENERAL TEST PROCEDURES

##### Conducted Emissions

The EUT is placed on the turntable, which is positioned at 0.8 m above the ground plane. According to the requirements in Section 13.3 of ANSI C63.10:2013, the conducted emission from the EUT is measured in the frequency range between 0.15 MHz and 30MHz, using the CISPR Quasi-Peak detector mode.

##### Radiated Emissions

Under 1GHz

The EUT is placed on a turn table, which is 0.8 m above ground plane. The turntable shall rotate 360 degrees to determine the position of maximum emission level. EUT is set 3m away from the receiving antenna, which varied from 1m to 4m to find out the highest emission. And also, each emission was to be maximized by changing the polarization of receiving antenna both horizontal and vertical. In order to find out the maximum emissions, exploratory radiated emission measurements were made according to the requirements in Section 13.1.4.1 of ANSI C63.10:2013.

Above 1GHz

The EUT is placed on a turn table, which is 1.5 m above ground plane. The turntable shall rotate 360 degrees to determine the position of maximum emission level. EUT is set 3m away from the receiving antenna, which varied from 1m to 4m to find out the highest emission. And also, each emission was to be maximized by changing the polarization of receiving antenna both horizontal and vertical. In order to find out the maximum emissions, exploratory radiated emission measurements were made according to the requirements in Section 13.1.4.1 of ANSI C63.10:2013.

### 3.4 FCC PART 15.205 RESTRICTED BANDS OF OPERATIONS

(a) Except as shown in paragraph (d) of this section, only spurious emissions are permitted in any of the frequency bands listed below:

MHz	MHz	MHz	GHz
0.090 - 0.110	16.42 - 16.423	399.9 - 410	4.50 - 5.15
0.495 - 0.505 <sup>(1)</sup>	16.69475 - 16.69525	608 - 614	5.35 - 5.46
2.1735 - 2.1905	16.80425 - 16.80475	960.0 - 1240	7.25 - 7.75
4.125 - 4.128	25.50 - 25.67	1300 - 1427	8.025 - 8.500
4.17725 - 4.17775	37.50 - 38.25	1435.0 - 1626.5	9.0 - 9.2
4.20725 - 4.20775	73.00 - 74.60	1645.5 - 1646.5	9.3 - 9.5
6.215 - 6.218	74.80 - 75.20	1660 - 1710	10.6 - 12.7
6.26775 - 6.26825	108.00 - 121.94	1718.8 - 1722.2	13.25 - 13.4
6.31175 - 6.31225	123 - 138	2200 - 2300	14.47 - 14.5
8.291 - 8.294	149.90 - 150.05	2310 - 2390	15.35 - 16.2
8.362 - 8.366	156.52475 - 156.52525	2483.5 - 2500.0	17.7 - 21.4
8.37625 - 8.38675	156.70 - 156.90	2655 - 2900	22.01 - 23.12
8.41425 - 8.41475	162.0125 - 167.1700	3260 - 3267	23.6 - 24.0
12.29 - 12.293	167.72 - 173.20	3332 - 3339	31.2 - 31.8
12.51975 - 12.52025	240 - 285	3345.8 - 3358.0	36.43 - 36.5 <sup>(2)</sup>
12.57675 - 12.57725	322.0 - 335.4	3600 - 4400	
13.36 - 13.41			

<sup>1</sup> Until February 1, 1999, this restricted band shall be 0.490-0.510MHz.

<sup>2</sup> Above 38.6

(b) Except as provided in paragraphs (d) and (e), the field strength of emissions appearing within these frequency bands shall not exceed the limits shown in Section 15.209. At frequencies equal to or less than 1000 MHz, compliance with the limits in Section 15.209 shall be demonstrated using measurement instrumentation employing a CISPR quasi-peak detector. Above 1000 MHz, compliance with the emission limits in Section 15.209 shall be demonstrated based on the average value of the measured emissions. The provisions in Section 15.35 apply to these measurements.

### 3.5 DESCRIPTION OF TEST MODES

Description	Modulation Technology	Modulation Type
26dB Bandwidth and 99% bandwidth	OFDM	BPSK
Maximum conducted output power	OFDM	BPSK
Band edges measurement	OFDM	BPSK
Peak Power Spectral Density	OFDM	BPSK
Radiated undesirable emission	OFDM	BPSK
Powerline conducted emission	OFDM	BPSK

**IEEE 802.11a mode:**

Channel (5180MHz),Channel (5200MHz) and Channel (5240MHz) with 6Mbps data rate were chosen for full testing.

**IEEE 802.11an HT20 mode:**

Channel (5180MHz),Channel (5200MHz) and Channel (5240MHz) with MCS0 data rate were chosen for full testing.



### 3.6 ANTENNA DESCRIPTION

an intentional radiator antenna shall be designed to ensure that no antenna other than that furnished by the responsible party can be used with the device. The use of a permanently attached or an antenna that uses a unique coupling to the intentional radiator shall be considered sufficient to comply with the provisions of this section”

- \* the antenna of this EUT is a unique(FPC Antenna for WiFi).
- \* the EUT complies with the requirement of 15.203.



## 4 INSTRUMENT CALIBRATION

The measuring equipment, which was utilized in performing the tests documented herein, has been calibrated in accordance with the manufacturer's recommendations for utilizing calibration equipment, which is traceable to recognized national standards.

### 4.1 MEASUREMENT EQUIPMENT USED

Conducted Emissions Test Site					
Name of Equipment	Manufacturer	Model	Serial Number	Calibration Date	Calibration Due
Spectrum Analyzer	Agilent	E4446A	MY44020154	2016-9-10	2017-9-9
Spectrum Analyzer	RS	FSU26	200789	2016-7-21	2017-7-20
Spectrum Analyzer	RS	FSU26	200789	2017-7-20	2018-7-19
Power meter	Anritsu	ML2495A	1445010	2017-4-26	2018-4-25
Power sensor	Anritsu	MA2411B	1339220	2017-4-26	2018-4-25
Power SPLITTER	Mini-Circuits	ZN2PD-9G	SF078500430	N.C.R	N.C.R
DC Power Supply	AGILENT	E3632A	MY50340053	N.C.R	N.C.R
Temp. / Humidity Gauge	Anymetre	TH603	CCS007	2016-11-1	2017-10-31
Test Software			EZ-EMC		

977 Chamber					
Name of Equipment	Manufacturer	Model	Serial Number	Calibration Date	Calibration Due
Spectrum Analyzer	Agilent	E4446A	MY44020154	2016-9-10	2017-9-9
Spectrum Analyzer	RS	FSU26	200789	2016-7-21	2017-7-20
Spectrum Analyzer	RS	FSU26	200789	2017-7-20	2018-7-19
EMI Test Receiver	R&S	ESCI	101378	2017-1-5	2018-1-4
Pre-Amplifier	MITEQ	AMF-6F-260400-40-8P	1037496	2016-11-15	2017-11-14
Amplifier	MITEQ	JS41-00101800-32-10P	1675713	2017-7-20	2018-7-19
Broad-Band Horn Antenna	SCHWARZBECK	BBHA 9170	9170-515	2017-3-6	2018-3-5
Bilog Antenna	Sunol	JB1	A062604	2017-5-27	2018-5-26
Bilog Antenna	Sunol	JB1	A110204-1	2017-5-27	2018-5-26
Loop Antenna	Hengweiyi	39501C	2014012	2017-1-5	2018-1-4
Horn-antenna	SCHWARZBECK	9120D	D:266	2017-2-28	2018-2-27
Horn-antenna	SCHWARZBECK	9120D	D:267	2016-11-10	2017-11-9
Turn Table	CT	CT123	4165	N.C.R	N.C.R
Antenna Tower	CT	CTERG23	3256	N.C.R	N.C.R
Controller	CT	CT100	95637	N.C.R	N.C.R
Test Software			EZ-EMC		

Conducted Emission					
Name of Equipment	Manufacturer	Model	Serial Number	Calibration Date	Calibration Due
EMI TEST RECEIVER	R&S	ESCI	100781	2017-2-28	2018-2-27
V (V-LISN)	SCHWARZBECK	NNLK 8129	8129-143	2016-11-1	2017-10-31
TWO-LINE V-NETWORK	R&S	ENV216	101604	2016-11-1	2017-10-31
Pulse LIMITER	R&S	ESH3-Z2	100524	2017-1-5	2018-1-4
Test Software	EZ-EMC				

**Remark:** Each piece of equipment is scheduled for calibration once a year.

## 4.2 MEASUREMENT UNCERTAINTY

For the test methods, according to the present document, the measurement uncertainty figures shall be calculated in accordance with TR 100 028-1 [2] and shall correspond to an expansion factor (coverage factor)  $k = 1,96$  or  $k = 2$  (which provide confidence levels of respectively 95 % and 95,45 % in the case where the distributions characterizing the actual measurement uncertainties are normal (Gaussian)).

Table 6 is based on such expansion factors.

**Table 6: Maximum measurement uncertainty**

Parameter	UNCERTAINTY
Radio frequency	$\pm 0.8 \times 10^{-7}$
RF power, conducted	0.2054
Maximum frequency deviation:	
-within 300 Hz and 6 kHz of audio frequency	1.3%
-within 6 kHz and 25 kHz of audio frequency	0.65 dB
Adjacent channel power	0.2054
Conducted spurious emission of transmitter, valid up to 6 GHz	0.2892
Conducted emission of receivers	+1.2/-1.1 dB
Radiated emission of transmitter, valid up to 6 GHz	$\pm 3.94$ dB
Radiated emission of receiver, valid up to 6 GHz	$\pm 3.94$ dB
RF level uncertainty for a given BER	$\pm 0.3$ dB
Temperature	0.1979
Humidity	$\pm 1$ %

## 5 FACILITIES AND ACCREDITATIONS

### 5.1 FACILITIES

All measurement facilities used to collect the measurement data are located at

**No.10Weiye Rd., Innovation park, Eco&Tec, Development Zone, Kunshan City, Jiangsu, China.**

The sites are constructed in conformance with the requirements of ANSI C63.10:2013 and CISPR Publication 22. All receiving equipment conforms to CISPR Publication 16-1, "Radio Interference Measuring Apparatus and Measurement Methods."

### 5.2 EQUIPMENT

Radiated emissions are measured with one or more of the following types of linearly polarized antennas: tuned dipole, biconical, log periodic, bi-log, and/or ridged waveguide, horn. Spectrum analyzers with preselectors and quasi-peak detectors are used to perform radiated measurements.

Conducted emissions are measured with Line Impedance Stabilization Networks and EMI Test Receivers.

Calibrated wideband preamplifiers, coaxial cables, and coaxial attenuators are also used for making measurements.

All receiving equipment conforms to CISPR Publication 16-1, "Radio Interference Measuring Apparatus and Measurement Methods."

### 5.3 TABLE OF ACCREDITATIONS AND LISTINGS

FCC –Designation Number: CN1172.

Compliance Certification Services Inc. Kun shan Laboratory has been registered and fully described in a report filed with the (FCC) Federal Communications Commission. The acceptance letter from the FCC is maintained in our files and the Designation Number: CN1172.

### 5.4 TABLE OF ACCREDITATIONS AND LISTINGS

Country	Agency	Scope of Accreditation	Logo
USA	A2LA	47 CFR FCC Part 15/18 (using ANSI C63.10 :2013); VCCI V3; CNS 13438; CNS 13439; CNS 13803; CISPR 11; EN 55011; CISPR 13; EN 55013; CISPR 22:2005; CISPR 22:1997 +A1 :2000+A2 :2002; EN 55022:2006; EN55022 :1998 +A1 :2001+A2 :2003; EN 61000-6-3 (excluding discontinuous interference); EN 61000-6-4; AS/NZS CISPR 22; CAN/CSA-CEI/IEC CISPR 22; EN 61000-3-2; EN 61000-3-3; EN550024; EN 61000-4-2; EN 61000-4-3; EN61000-4-4; EN 61000-4-5; EN 61000-4-6; IEC 61000-4-8; EN 61000-4-11; IEC61000-3-2; IEC61000-3-3; IEC 61000-4-2; IEC 61000-4-3; IEC 61000-4-4; IEC 61000-4-5; IEC 61000-4-6; IEC 61000-4-8; IEC 61000-4-11; EN 300 220-3; EN 300 328; EN 300 330-2; EN 300 440-1; EN 300-440-2; EN 300 893; EN 301 489-01; EN 301 489-3; EN 301 489-07; EN 301 489-17; 47 CFR FCC Part 15, 22, 24	
USA	FCC	3/10 meter Sites to perform FCC Part 15/18 measurements	
Japan	VCCI	3/10 meter Sites and conducted test sites to perform radiated/conducted measurements	

*\* No part of this report may be used to claim or imply product endorsement by A2LA or any agency of the US Government.*

## 6 SETUP OF EQUIPMENT UNDER TEST

### 6.1 SETUP CONFIGURATION OF EUT

See test photographs attached in Appendix 1 for the actual connections between EUT and support equipment.

### 6.2 SUPPORT EQUIPMENT

No.	Equipment	Model No.	Serial No.
1	N/A		

**Remark:**

1. All the equipment/cables were placed in the worst-case configuration to maximize the emission during the test.
2. Grounding was established in accordance with the manufacturer's requirements and conditions for the intended use.

## 7 FCC PART 15 REQUIREMENTS

### 7.1 26 DB EMISSION BANDWIDTH

#### LIMIT

According to §15.403(i), for purposes of this subpart the emission bandwidth shall be determined by measuring the width of the signal between two points, one below the carrier center frequency and one above the carrier center frequency, that are 26 dB down relative to the maximum level of the modulated carrier. Compliance with the emissions limits is based on the use of measurement instrumentation employing a peak detector function with an instrument resolutions bandwidth approximately equal to 1.0 percent of the emission bandwidth of the device under measurement.

#### Test Configuration

#### TEST PROCEDURE

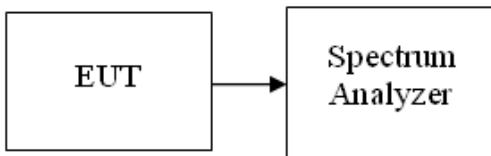

1. Place the EUT on the table and set it in the transmitting mode.
2. Remove the antenna from the EUT and then connect a low-loss RF cable from the antenna port to the spectrum analyzer.
3. Set the spectrum analyzer as RBW = approximately 1% of the emission bandwidth, VBW > RBW, Detector = Peak, Span >26dB bandwidth, and Sweep = auto, Trace mode = max hold.
4. Measure the maximum width of the emission that is 26 dB down from the maximum of the emission. Compare this with the RBW setting of the analyzer. Readjust RBW and repeat measurement as needed until the RBW/EBW ratio is approximately 1%.
5. Repeat until all the rest channels were investigated.

#### TEST RESULTS

*No non-compliance noted*

#### Test Data

**Test mode: IEEE 802.11a mode**

Channel	Frequency (MHz)	Bandwidth (B) (MHz)
Low	5180	21.795
Mid	5200	21.554
High	5240	21.554

**Test mode: IEEE 802.11n HT20MHz mode**

Channel	Frequency (MHz)	Bandwidth (B) (MHz)
Low	5180	21.875
Mid	5200	22.035
High	5240	22.115



## Test Plot

IEEE 802.11a mode:

### CH Low

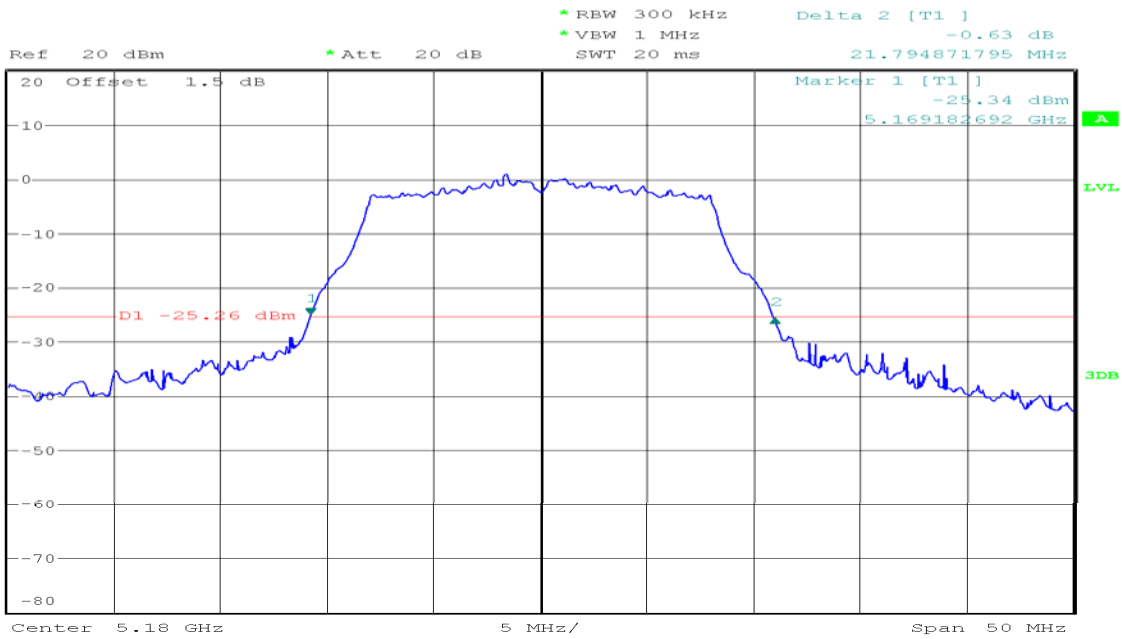

Date: 9.AUG.2017 19:24:17

### CH Mid

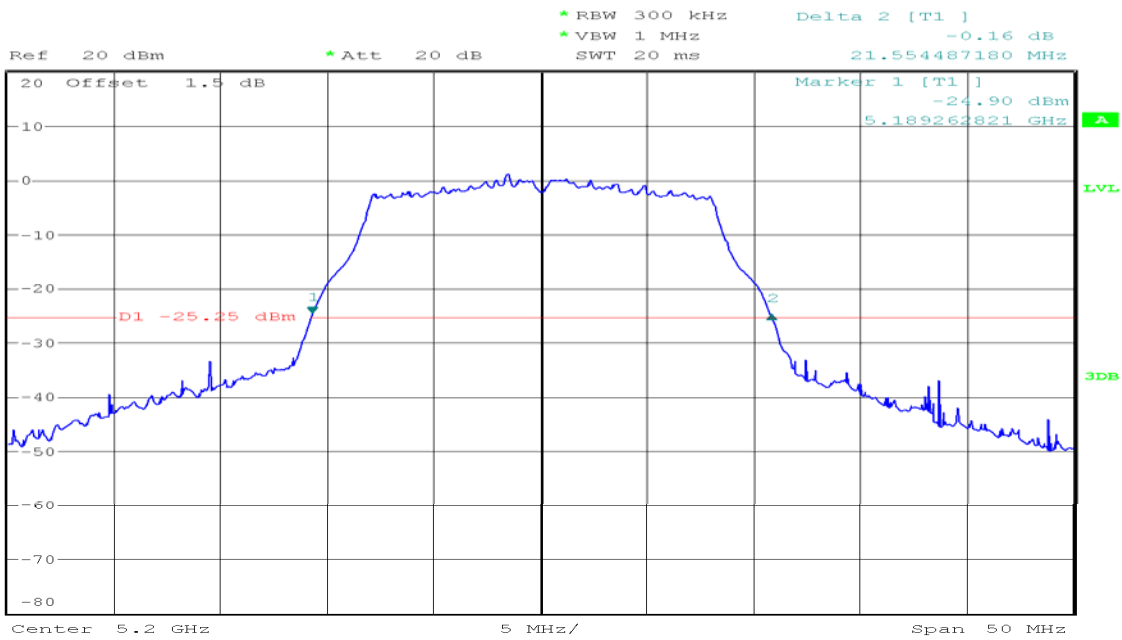

Date: 9.AUG.2017 19:27:28

## CH High

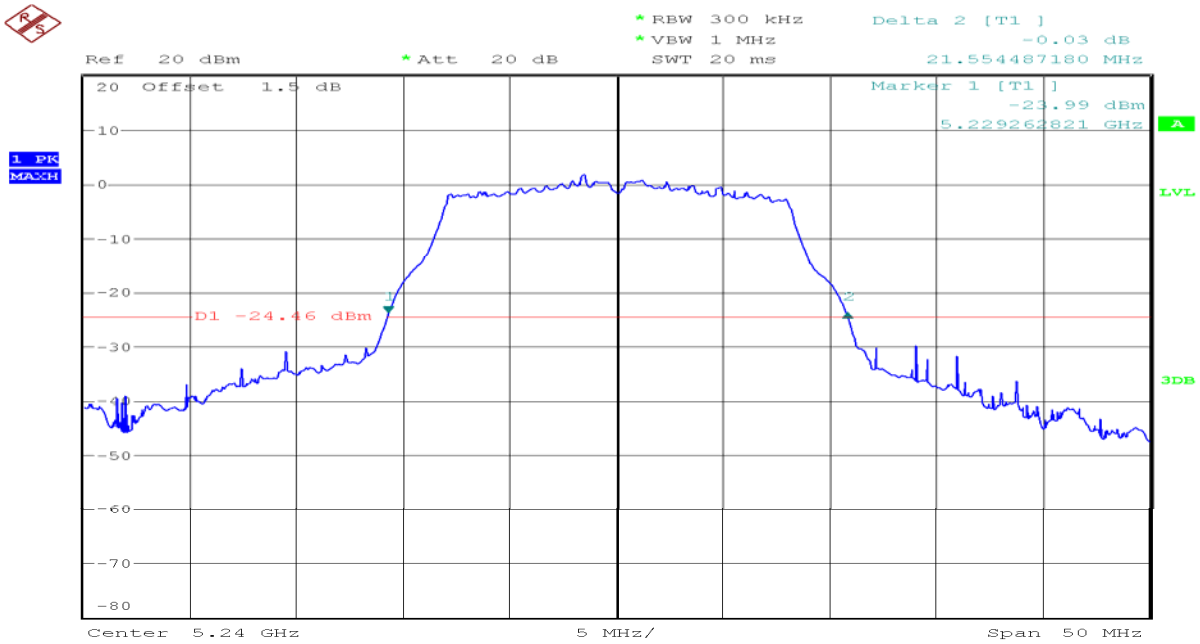

Date: 8.AUG.2017 11:23:31

## IEEE 802.11n HT20 mode

### CH Low

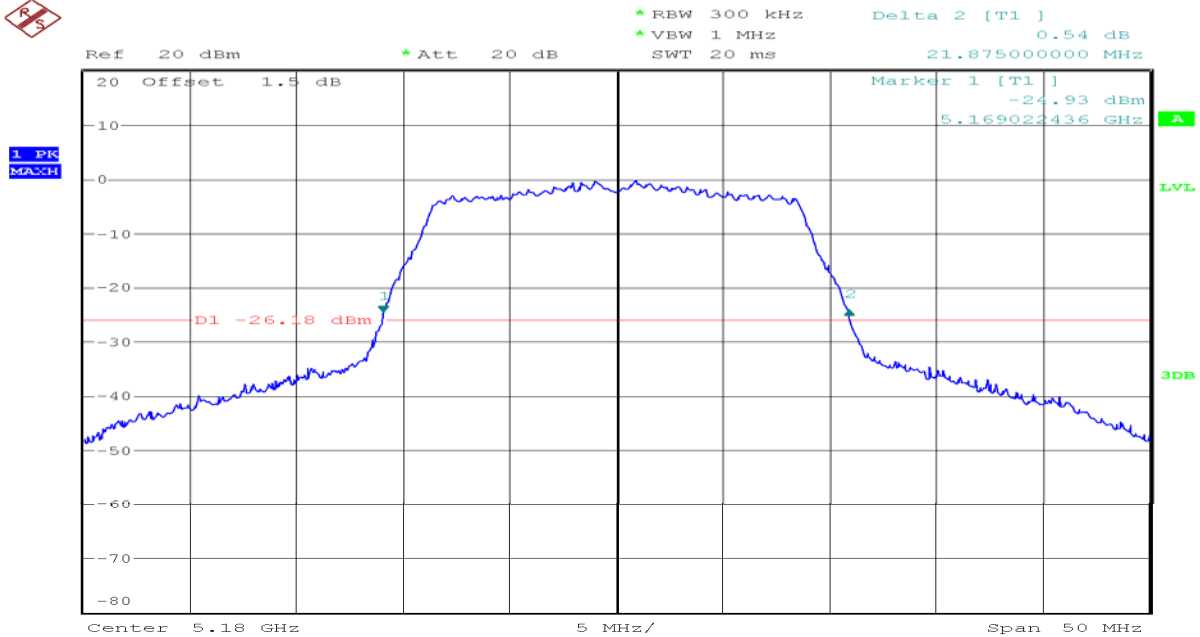

Date: 8.AUG.2017 19:08:51

## CH Mid

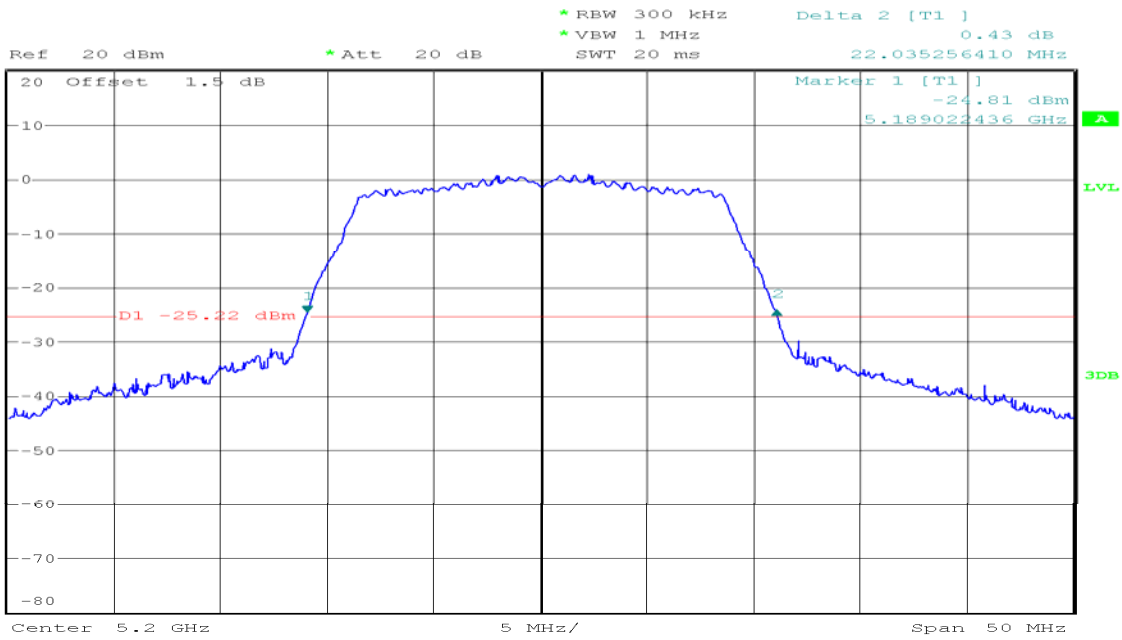

Date: 8.AUG.2017 19:05:15

## CH High

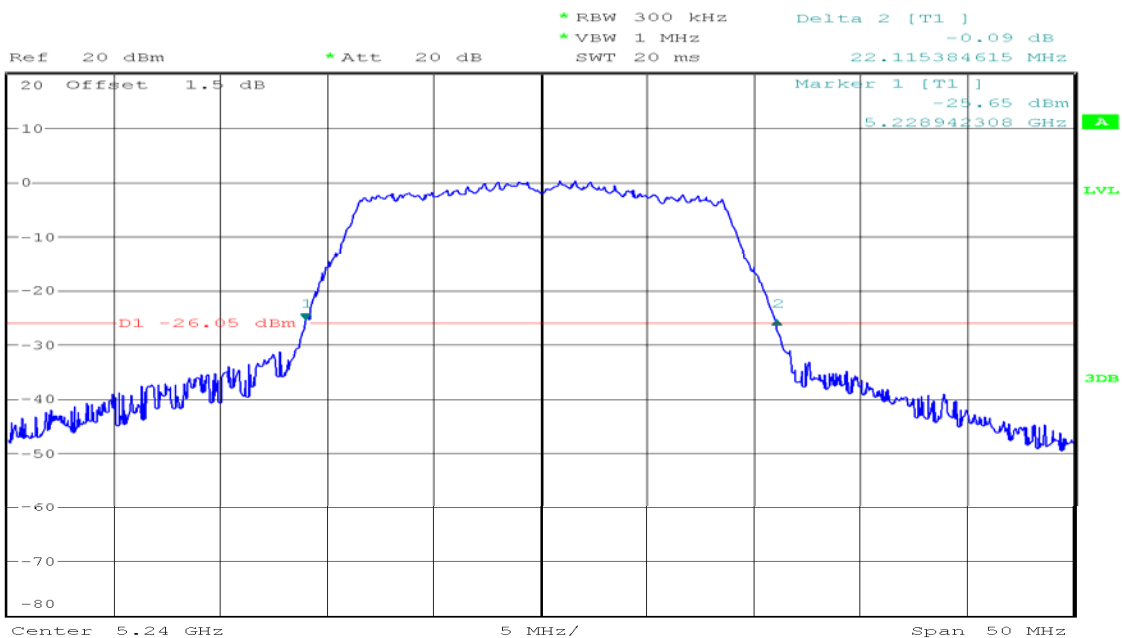

Date: 8.AUG.2017 11:26:33

## 7.2 99% DB EMISSION BANDWIDTH

### LIMIT

None; for reporting purposes only.

### Test Configuration

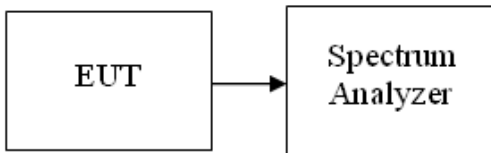

### Test Procedure

1. Set center frequency to the nominal EUT channel center frequency.
2. Set span = 1.5 times to 5.0 times the OBW.
3. Set RBW = 1 % to 5 % of the OBW
4. Set VBW  $\geq 3 \cdot$  RBW
5. Video averaging is not permitted. Where practical, a sample detection and single sweep mode shall be used. Otherwise, peak detection and max hold mode (until the trace stabilizes) shall be used.
6. Use the 99 % power bandwidth function of the instrument (if available).

### TEST RESULTS

*No non-compliance noted*

### Test Data

Test mode: IEEE 802.11a mode

5150~5250MHz

Channel	Frequency (MHz)	Bandwidth (MHz)
Low	5180	18.75
Mid	5200	18.75
High	5240	18.75

Test mode: IEEE 802.11n HT20MHz mode

5150~5250MHz

Channel	Frequency (MHz)	Bandwidth (MHz)
Low	5180	19.631
Mid	5200	19.631
High	5240	19.631

### Test Plot

IEEE 802.11a mode:

5150~5250MHz

### CH Low

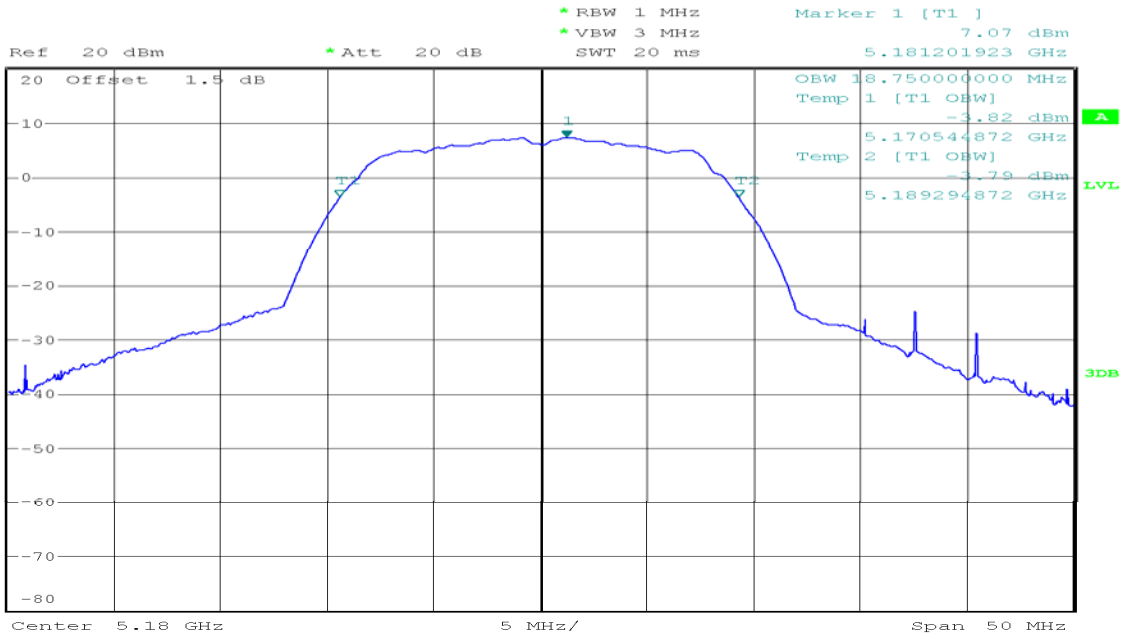

Date: 8.AUG.2017 19:29:26

### CH Mid

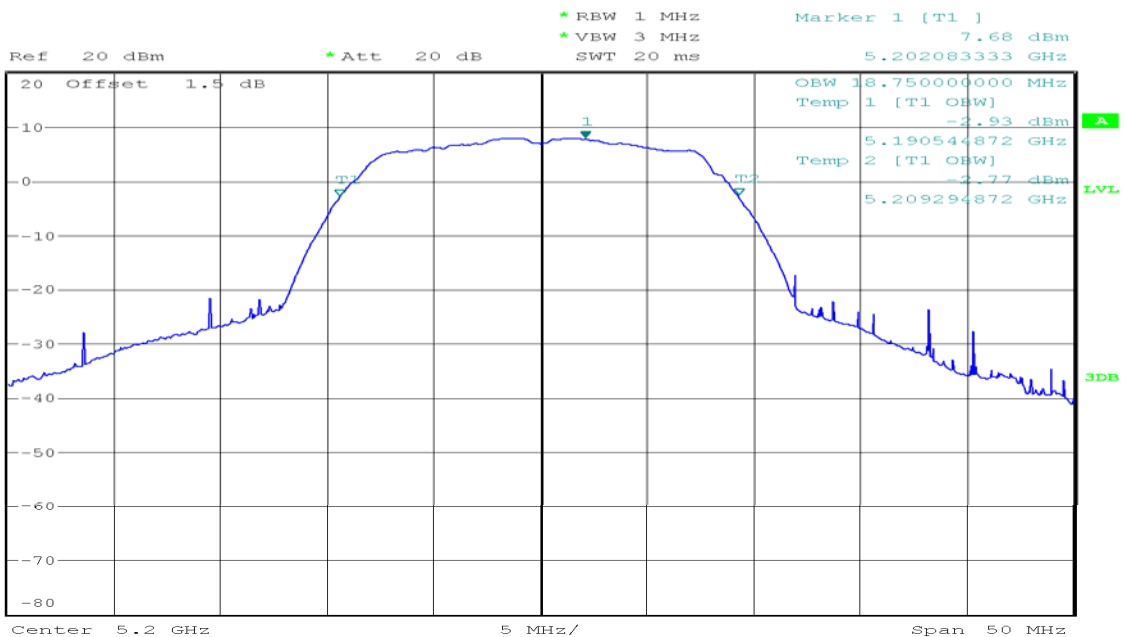

Date: 8.AUG.2017 19:31:13

## CH High

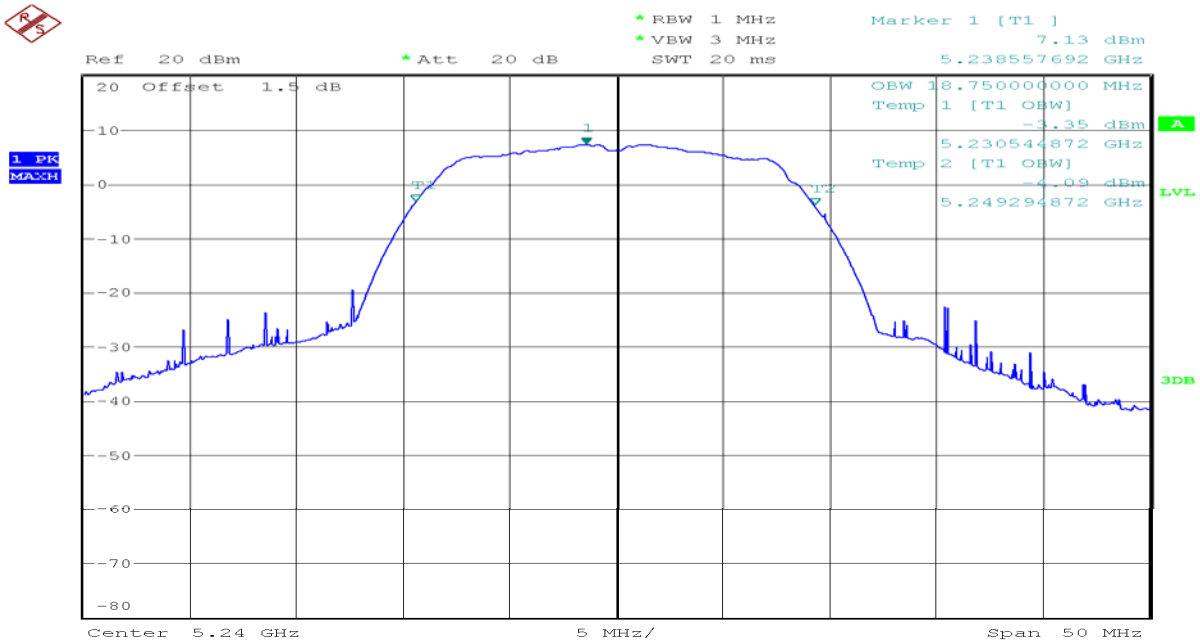

Date: 8.AUG.2017 19:33:40

## IEEE 802.11n HT20 mode

5150~5250MHz

## CH Low

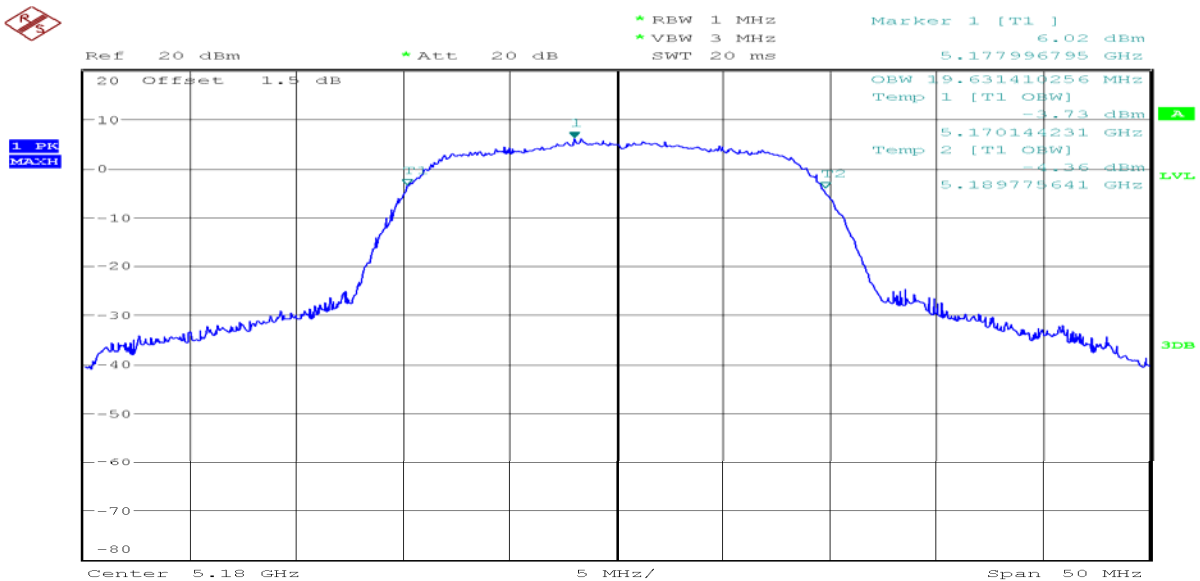

Date: 8.AUG.2017 19:27:19

## CH Mid

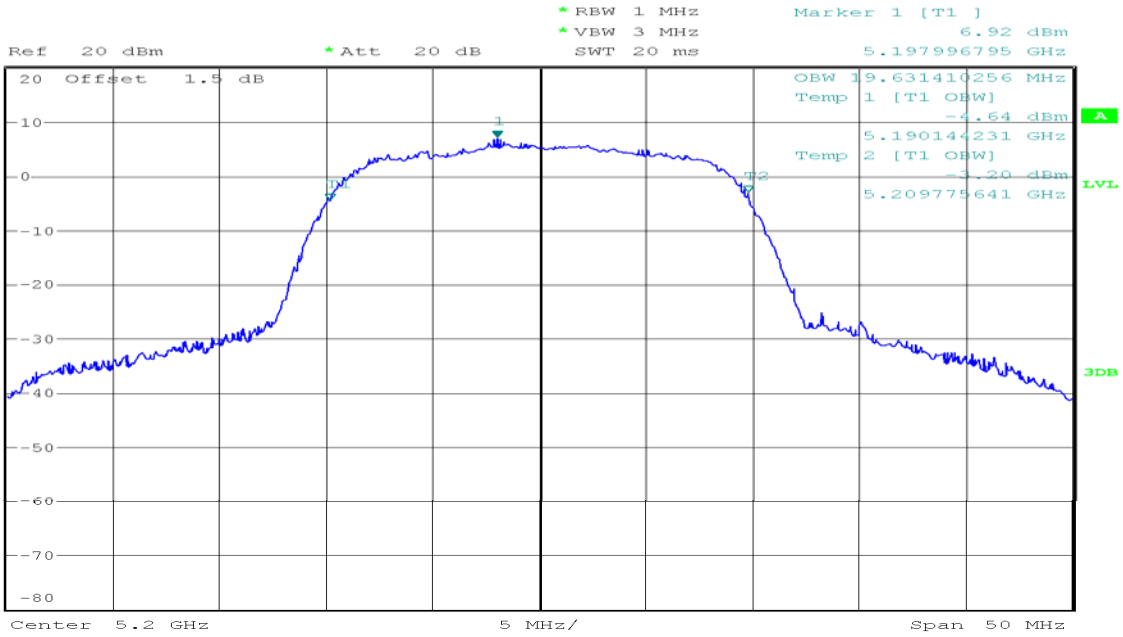

Date: 8.AUG.2017 19:23:55

## CH High

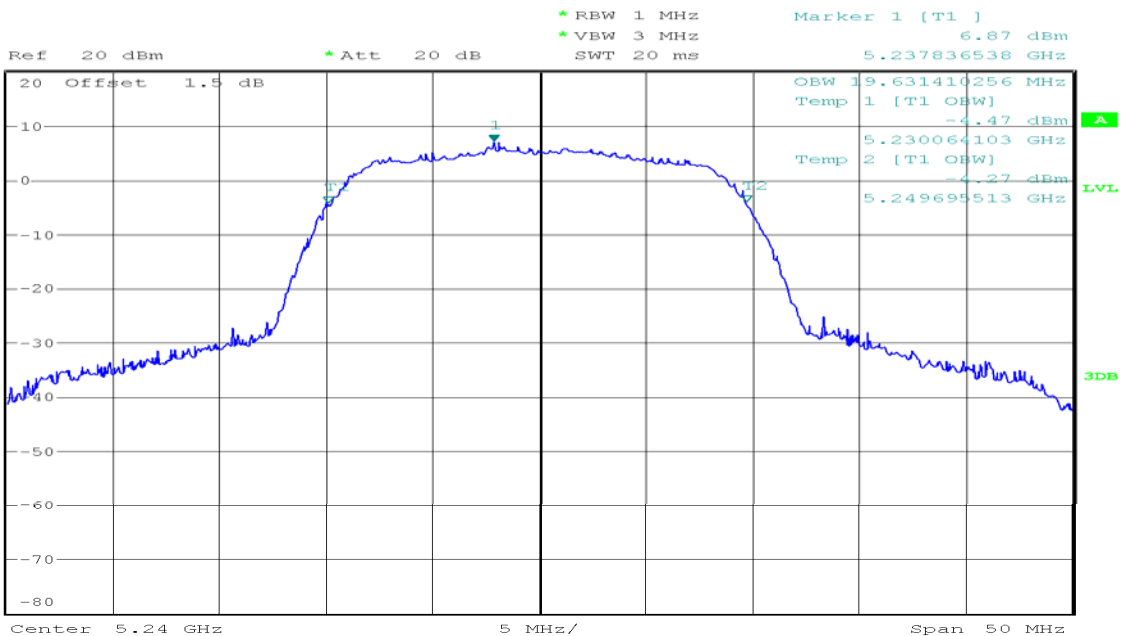

Date: 8.AUG.2017 19:25:19



## 7.3 MAXIMUM CONDUCTED OUTPUT POWER

### LIMIT

According to §15.407(a),

(iv) For mobile and portable client devices in the 5.15-5.25 GHz band, the maximum conducted output power over the frequency band of operation shall not exceed 250 mW provided the maximum antenna gain does not exceed 6 dBi.

If transmitting antennas of directional gain greater than 6dBi are used, both the peak transmit power and the peak power spectral density shall be reduced by the amount in dB that the directional gain of the antenna exceeds 6dBi.

The peak power shall not exceed the limit as follow:

### Test Configuration

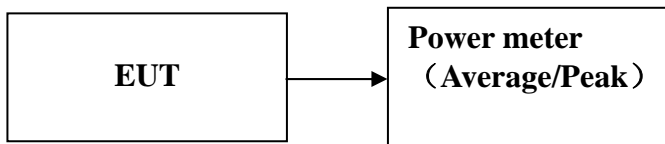

*The EUT was connected to a spectrum analyzer through a 50Ω RF cable.*

### TEST PROCEDURE

The testing follows Method PM of FCC KDB 789033 D02 General UNII Test Procedures New Rules v01.

Method PM (Measurement using an RF average power meter):

1. Measurement is performed using a wideband RF power meter.
2. The EUT is configured to transmit continuously with a consistent duty cycle at its maximum power control level.
3. Measure the average power of the transmitter, and the average power is corrected with duty factor,  $10 \log(1/x)$ , where x is the duty cycle.

### TEST RESULTS

*No non-compliance noted*

### TEST RESULTS

*No non-compliance noted*

**Test Data****Test mode: IEEE 802.11a mode**

Channel	Frequency (MHz)	Average Output Power (dBm)	Limit (dBm)
Low	5180	9.25	30.00
Mid	5200	9.28	30.00
High	5240	9.52	30.00

**Test mode: IEEE 802.11n HT20MHz mode**

Channel	Frequency (MHz)	Average Output Power (dBm)	Limit (dBm)
Low	5180	7.93	30.00
Mid	5200	7.97	30.00
High	5240	8.27	30.00

**Note:Duty factor has been offsetted with cableloss**

## 7.4 BAND EDGES MEASUREMENT

### LIMIT

According to §15.407(b),

- (1) The provisions of Section 15.205 of this part apply to intentional radiators operating under this section.
- (2) When measuring the emission limits, the nominal carrier frequency shall be adjusted as close to the upper and lower frequency block edges as the design of the equipment permits.

### Test Configuration

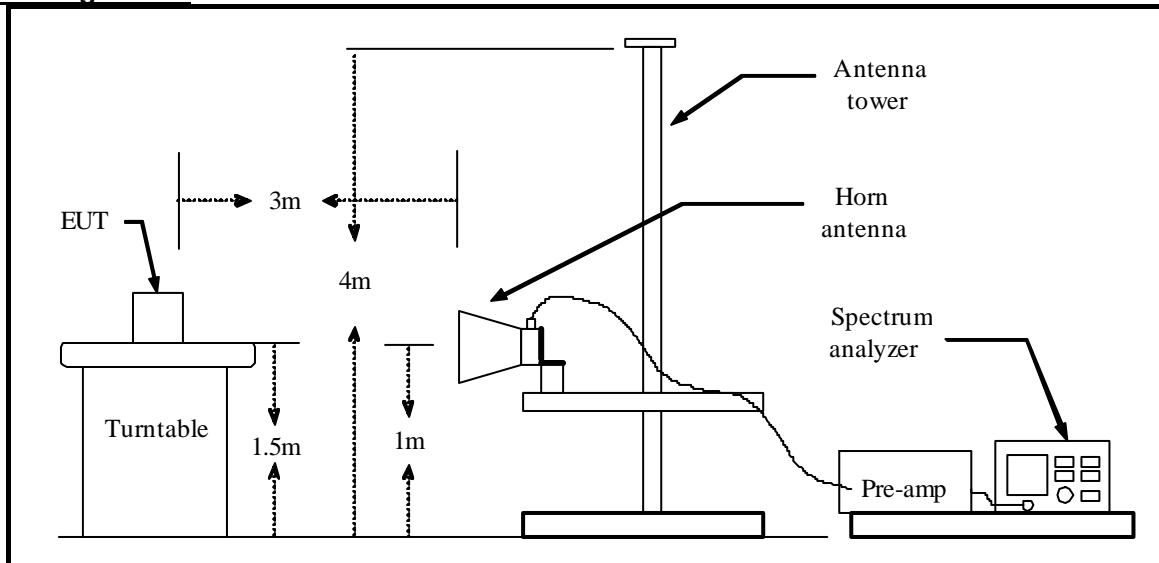

### TEST PROCEDURE

1. The EUT is placed on a turntable, which is 1.5m above the ground plane.
2. The turntable shall be rotated for 360 degrees to determine the position of maximum emission level.
3. EUT is set 3m away from the receiving antenna, which is varied from 1m to 4m to find out the highest emission.
4. Set the spectrum analyzer in the following setting in order to capture the lower and upper band-edges of the emission:
  - (a) PEAK: RBW=VBW=1MHz / Sweep=AUTO
  - (b) AVERAGE: RBW=1MHz / Sweep=AUTO

VBW=10Hz, when duty cycle is no less than 98 percent.

$VBW \geq 1/T$ , when duty cycle is less than 98 percent, where T is the minimum transmission duration over which the transmitter is on and is transmitting at its maximum power control level for the tested mode of operation.

Band	Duty Cycle(%)	T(ms)	1/T(kHz)	VBW Setting
IEEE 802.11 a	99	-	-	10Hz
IEEE 802.11n HT20	99	-	-	10Hz

### TEST RESULTS

Refer to attach spectrum analyzer data chart.

### Band Edges (IEEE 802.11a mode)

Polarity: Vertical

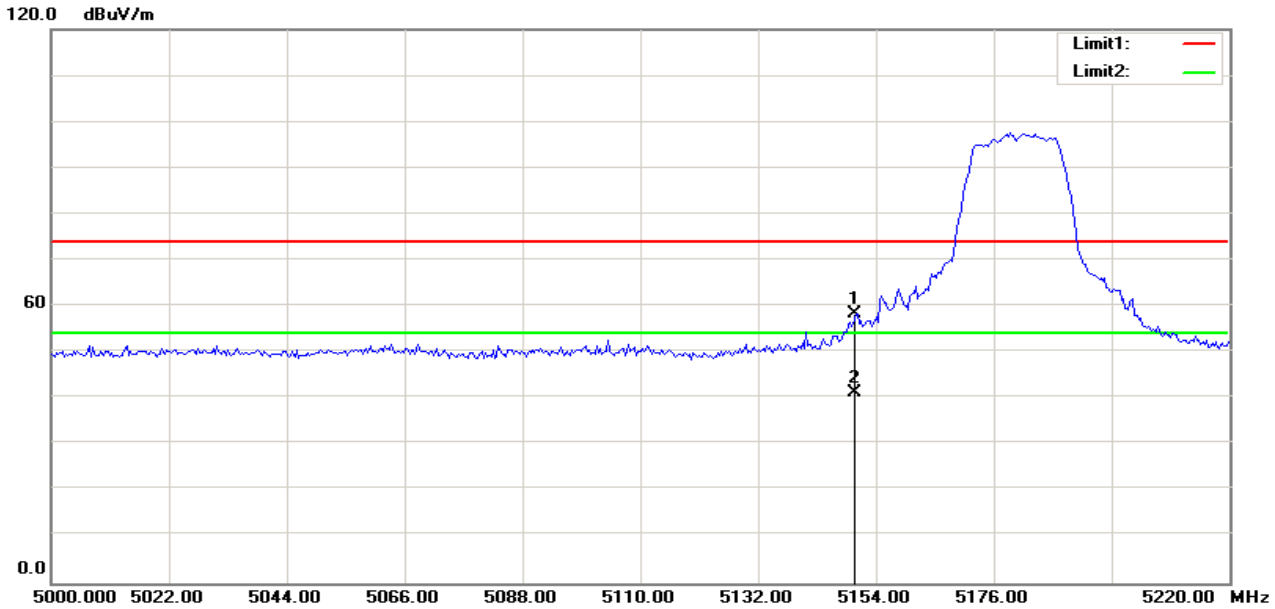

No.	Frequency (MHz)	Reading (dBuV)	Correct Factor(dB/m)	Result (dBuV/m)	Limit (dBuV/m)	Margin (dB)	Height (cm)	Degree (deg.)	Remark
1	5150.000	62.71	-4.40	58.31	74.00	-15.69	100	7	peak
2	5150.000	45.59	-4.40	41.19	54.00	-12.81	100	7	AVG

Polarity: Horizontal

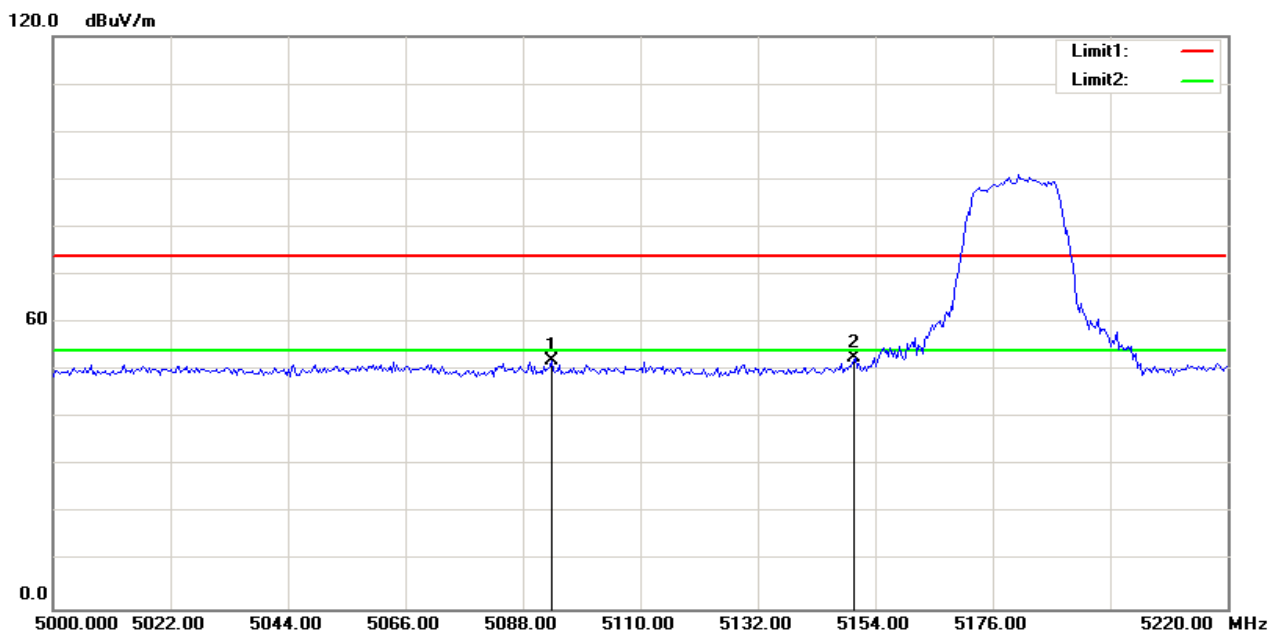

No.	Frequency (MHz)	Reading (dBuV)	Correct Factor(dB/m)	Result (dBuV/m)	Limit (dBuV/m)	Margin (dB)	Height (cm)	Degree (deg.)	Remark
1	5093.430	56.76	-4.67	52.09	74.00	-21.91	100	3	peak
2	5150.000	56.92	-4.40	52.52	74.00	-21.48	100	9	peak

### Band Edges (IEEE 802.11n HT20 mode)

Polarity: Vertical

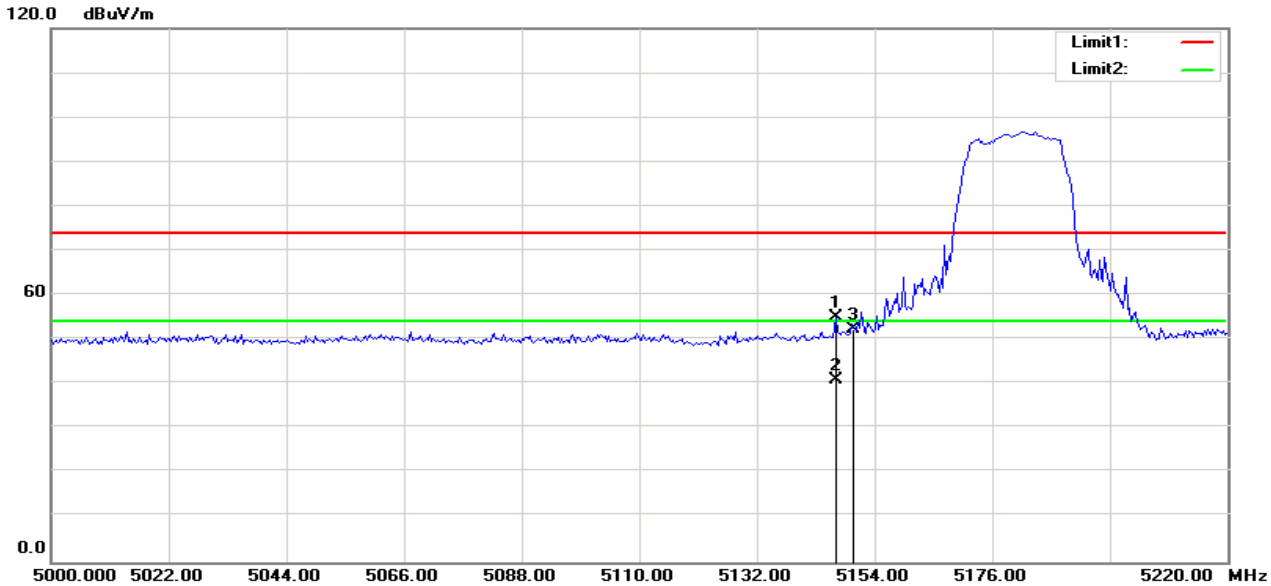

No.	Frequency (MHz)	Reading (dBuV)	Correct Factor(dB/m)	Result (dBuV/m)	Limit (dBuV/m)	Margin (dB)	Height (cm)	Degree (deg.)	Remark
1	5146.667	59.47	-4.41	55.06	74.00	-18.94	100	139	peak
2	5146.667	45.29	-4.41	40.88	54.00	-13.12	100	140	AVG
3	5150.000	56.84	-4.40	52.44	74.00	-21.56	100	142	peak

Polarity: Horizontal

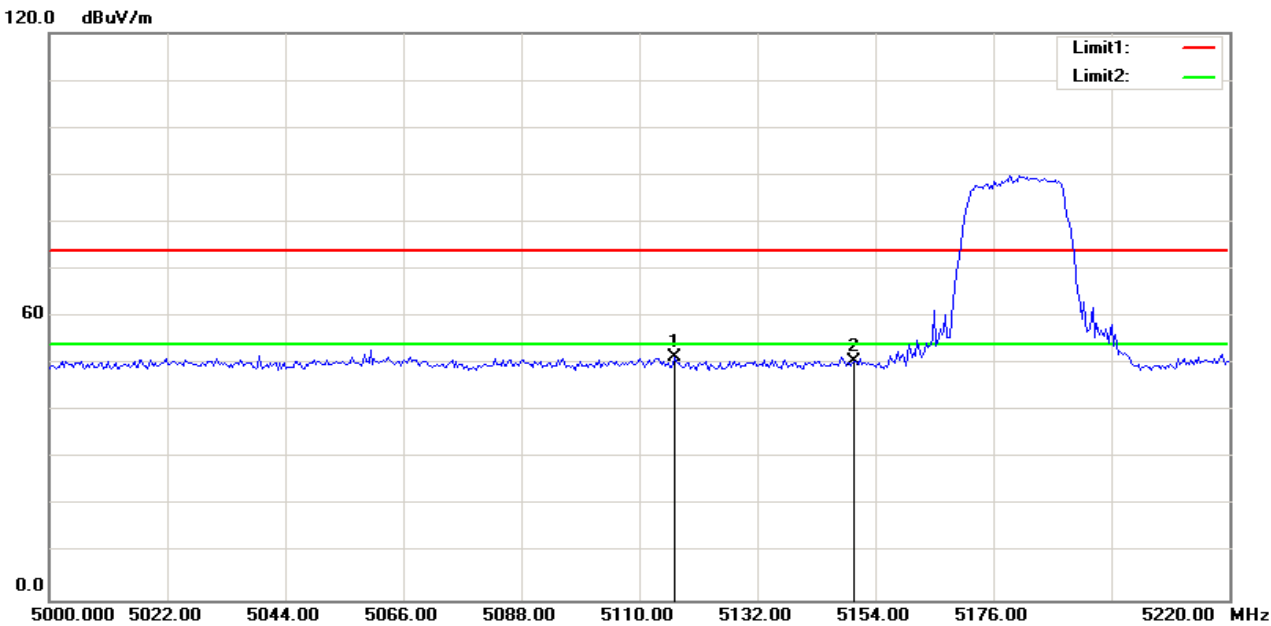

No.	Frequency (MHz)	Reading (dBuV)	Correct Factor(dB/m)	Result (dBuV/m)	Limit (dBuV/m)	Margin (dB)	Height (cm)	Degree (deg.)	Remark
1	5116.699	56.02	-4.55	51.47	74.00	-22.53	100	240	peak
2	5150.000	54.89	-4.40	50.49	74.00	-23.51	100	107	peak

## 7.5 MAXIMUM POWER SPECTRAL DENSITY

### LIMIT

According to §15.407(a),

For mobile and portable client devices in the 5.15-5.25 GHz band, the maximum conducted output power over the frequency band of operation shall not exceed 250 mW provided the maximum antenna gain does not exceed 6 dBi. In addition, the maximum power spectral density shall not exceed 11 dBm in any 1 megahertz band. If transmitting antennas of directional gain greater than 6 dBi are used, both the maximum conducted output power and the maximum power spectral density shall be reduced by the amount in dB that the directional gain of the antenna exceeds 6 dBi.

*If transmitting antennas of directional gain greater than 6dBi are used, both the peak transmit power and the peak power spectral density shall be reduced by the amount in dB that the directional gain of the antenna exceeds 6dBi.*

### Test Configuration

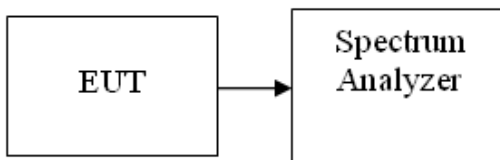

### TEST PROCEDURE

1. Place the EUT on the table and set it in transmitting mode.  
Remove the antenna from the EUT and then connect a low loss RF cable from the antenna port to the spectrum analyzer.
2. Set the spectrum analyzer as RBW = 1MHz, VBW = 3MHz, Span must be greater than 26dB bandwidth, adjust as necessary, Sweep= auto, Detector RMS
3. Record the max. reading.

### TEST RESULTS

*No non-compliance noted*

### Test Data

**Test mode: IEEE 802.11a mode**

Channel	Frequency (MHz)	PPSD (dBm)	Limit (dBm)	Result
Low	5180	5.87	17.00	PASS
Mid	5200	6.20	17.00	PASS
High	5240	7.37	17.00	PASS

**Test mode: IEEE 802.11n HT20MHz mode**

Channel	Frequency (MHz)	PPSD (dBm)	Limit (dBm)	Result
Low	5180	6.52	17.00	PASS
Mid	5200	7.00	17.00	PASS
High	5240	7.11	17.00	PASS

**Note:**Duty factor has been offsetted with cableloss







## CH Mid

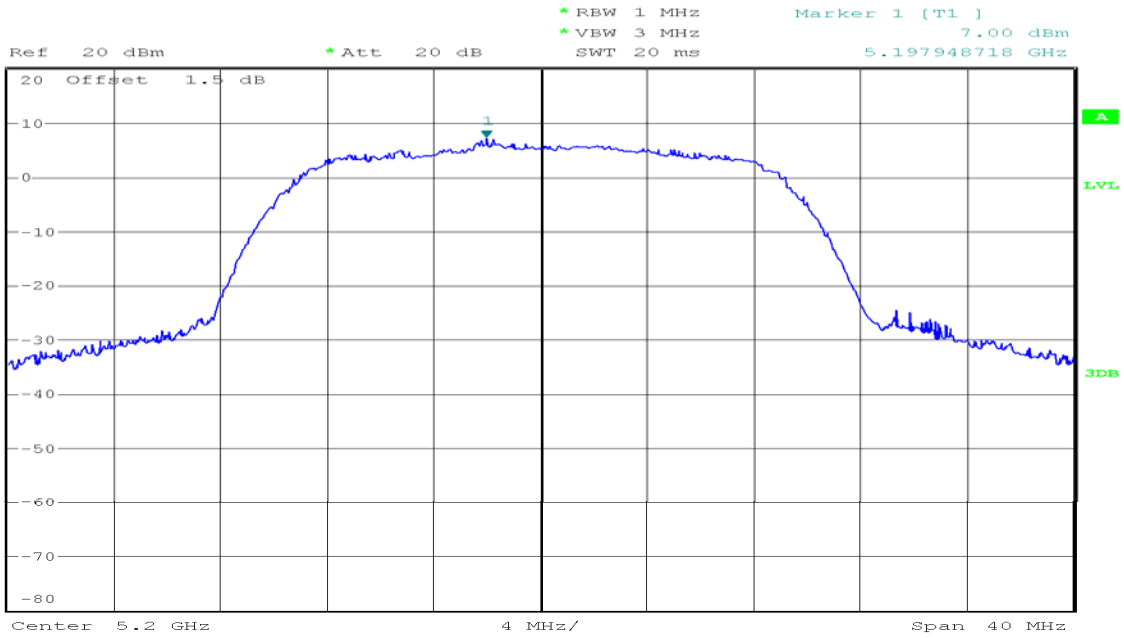

Date: 8.AUG.2017 19:46:32

## CH High

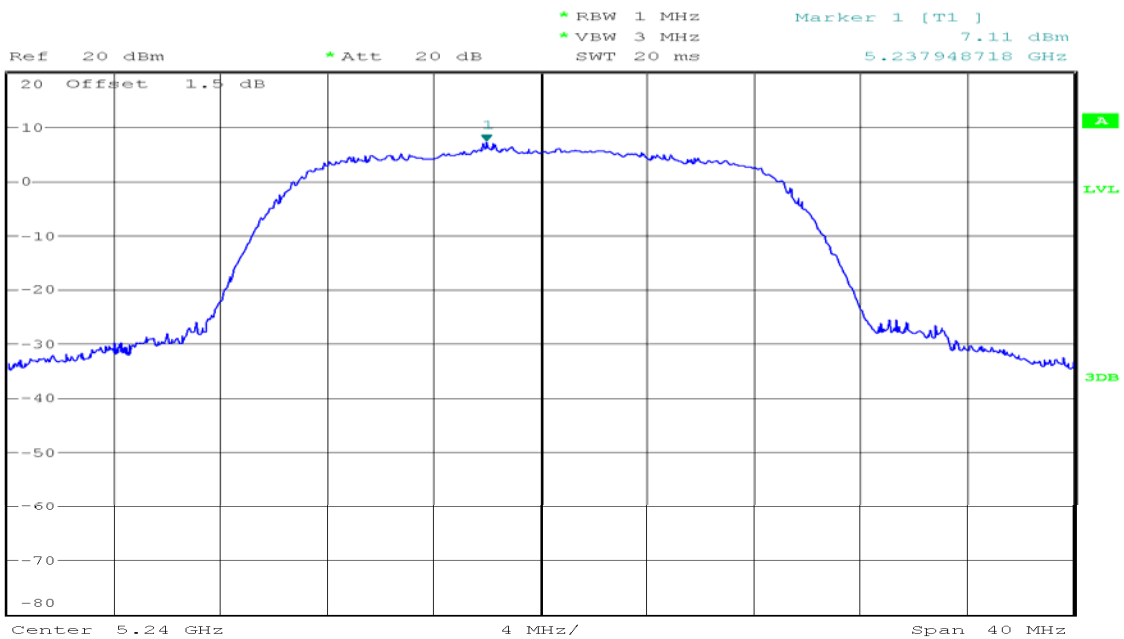

Date: 8.AUG.2017 19:48:38

## 7.6 FREQUENCY STABILITY MEASUREMENT

### LIMIT

According to §15.407(g), Manufacturers of U-NII devices are responsible for ensuring frequency stability such that an emission is maintained within the band of operation under all conditions of normal operation as specified in the user's manual.

### TEST CONFIGURATION

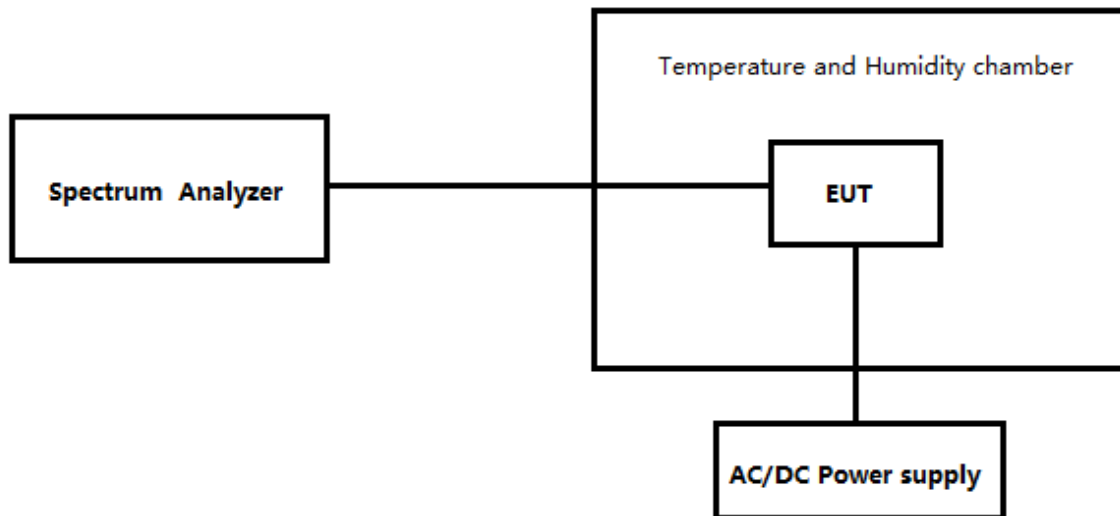

### TEST PROCEDURE

1. To ensure emission at the band edge is maintained within the authorized band, those values shall be measured by radiation emissions at upper and lower frequency points, and finally compensated by frequency deviation as procedures below.
2. The EUT was operated at the maximum output power, and connected to the spectrum analyzer, which is set to maximum hold function and peak detector. The peak value of the power envelope was measured and noted. The upper and lower frequency points were respectively measured relatively 10dB lower than the measured peak value.
3. The frequency deviation was calculated by adding the upper frequency point and the lower frequency point divided by two. Those detailed values of frequency deviation are provided in table below.

**TEST RESULTS**

U-NII-1-(5150MHz-5250MHz)					
Freq.(MHz)	Center Frequency (MHz)	Frequency Deviation (MHz)	Frequency Stability (ppm)	Temperature (°C)	Voltage (V)
5180	5180.000	0.000	0.00	25	V <sub>min</sub>
5180	5180.000	0.000	0.00	25	V <sub>max</sub>
5180	5180.039	0.000	0.08	25	V <sub>nor</sub>
5180	5180.000	0.000	0.00	0	V <sub>nor</sub>
5180	5180.061	0.061	0.12	45	V <sub>nor</sub>

## 7.7 RADIATED UNDESIRABLE EMISSION

### LIMIT

Radiated emissions from 9 kHz to 25 GHz were measured according to the methods defines in ANSI C63.10-2013. The EUT was placed above the ground plane, 0.8 meter for frequency below 1GHz and 1.5 meter for frequency above 1GHz. The interface cables and equipment positions were varied within limits of reasonable applications to determine the positions producing maximum radiated emissions.

- For transmitters operating in the 5150-5250 MHz band: all emissions outside of the 5150-5350 MHz band shall not exceed an EIRP of  $-27\text{dBm/MHz}$ .

For transmitters operating in the 5250-5350 MHz band: all emissions outside of the 5150-5350 MHz band shall not exceed an EIRP of  $-27\text{ dBm/MHz}$ . Devices operating in the 5250-5350 MHz band that generate emissions in the 5150-5250 MHz band must meet all applicable technical requirements for operation in the 5150-5250 MHz band (including indoor use) or alternatively meet an out-of-band emission EIRP limit of  $-27\text{ dBm/MHz}$  in the 5150-5250 MHz band.

For transmitters operating in the 5470-5600 MHz and 5650-5725MHz band: all emissions outside of the 5470-5600 MHz and 5650-5725MHz band shall not exceed an EIRP of  $-27\text{ dBm/MHz}$ .

- KDB 789033 v02 G)2)c) As specified in 15.407(b), emissions above 1000 MHz that are outside of the restricted bands are subject to a peak emission limit of  $-27\text{ dBm/MHz}$  (or  $-17\text{ dBm/MHz}$  as specified in 15.407(b)(4)). However, an out-of-band emission that complies with both the average and peak limits of 15.209 is not required to satisfy the  $-27\text{ dBm/MHz}$  or  $-17\text{ dBm/MHz}$  peak emission limit.
- According to §15.209(a), except as provided elsewhere in this Subpart, the emissions from an intentional radiator shall not exceed the field strength levels specified in the following table:

FREQUENCIES(MHz)	FIELD STRENGTH (microvolts/meter)	MEASUREMENT DISTANCE(meters)
0.009~0.490	2400/F(kHz)	300
0.490~1.705	24000/F(kHz)	30
1.705~30.0	30	30
30~88	100	3
88~216	150	3
216~960	200	3
Above 960	500	3

**Remark:** Except as provided in paragraph (g), fundamental emissions from intentional radiators operating under this Section shall not be located in the frequency bands 54-72 MHz, 76-88 MHz, 174-216 MHz or 470-806 MHz. However, operation within these frequency bands is permitted under other sections of this Part, e.g., Sections 15.231 and 15.241.

- In the emission table above, the tighter limit applies at the band edges.

Frequency (MHz)	Field Strength ( $\mu\text{V/m}$ at 3-meter)	Field Strength ( $\text{dB}\mu\text{V/m}$ at 3-meter)
30-88	100	40
88-216	150	43.5
216-960	200	46
Above 960	500	54

**Test Configuration**

**Below 30MHz**

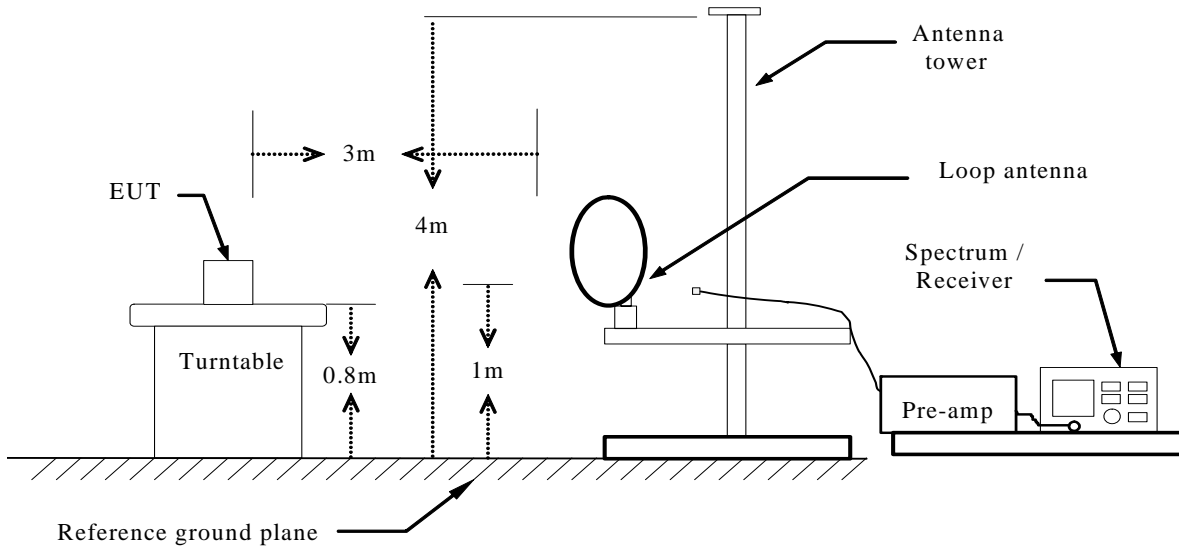

**Below 1 GHz**

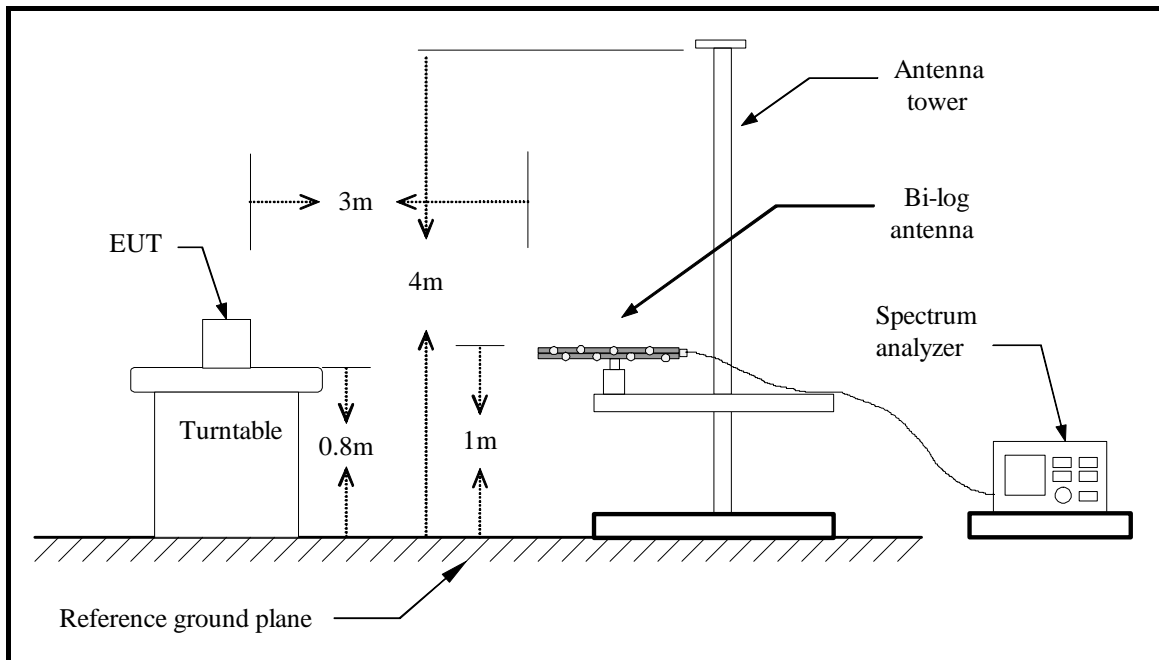

### Above 1 GHz

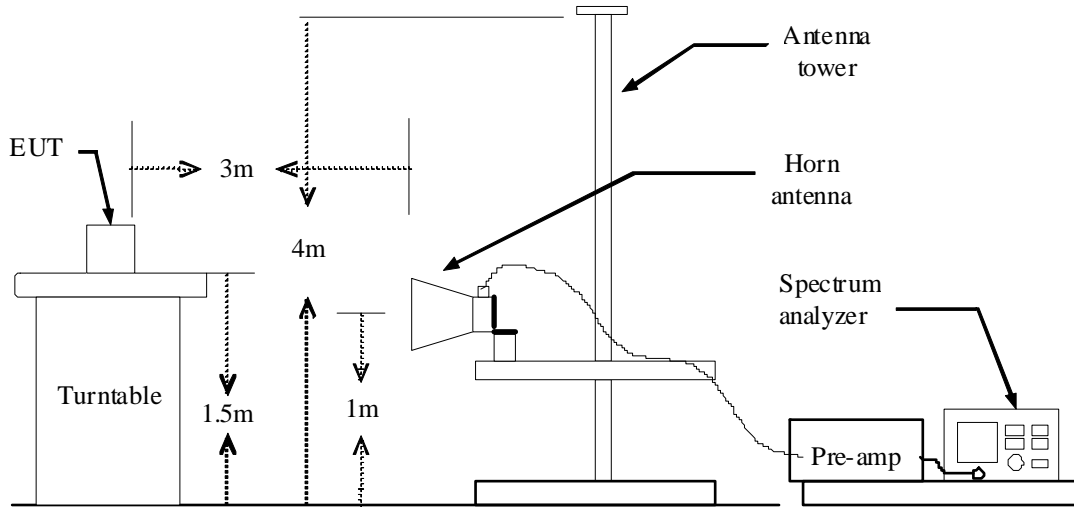

### TEST PROCEDURE

1. The EUT is placed on a turntable above ground plane, which is 0.8 meter for frequency below 1GHz and 1.5 meter for frequency above 1GHz.
2. The turntable shall be rotated for 360 degrees to determine the position of maximum emission level.
3. EUT is set 3m away from the receiving antenna, which is varied from 1m to 4m to find out the highest emissions.
4. Maximum procedure was performed on the six highest emissions to ensure EUT compliance.
5. And also, each emission was to be maximized by changing the polarization of receiving antenna both horizontal and vertical.
6. Set the spectrum analyzer in the following setting as:

Below 1GHz:

RBW=100kHz / VBW=300kHz / Sweep=AUTO

Above 1GHz:

(a) PEAK: RBW=VBW=1MHz / Sweep=AUTO

(b) AVERAGE: RBW=1MHz / Sweep=AUTO

VBW=10Hz, when duty cycle is no less than 98 percent.

VBW  $\geq 1/T$ , when duty cycle is less than 98 percent, where T is the minimum transmission duration over which the transmitter is on and is transmitting at its maximum power control level for the tested mode of operation.

Band	Duty Cycle(%)	T(ms)	1/T(kHz)	VBW Setting
IEEE 802.11 a	99	--	--	10Hz
IEEE 802.11n HT20	99	--	--	10Hz

7. Repeat above procedures until the measurements for all frequencies are complete.

**TEST RESULTS****Test Result of Radiated Emission****Below 30MHz**

The interference of the frequency value is lower than the limit below 20 db, measured as the background noise values and will not be recorded.

**30MHz-1GHz**

<b>Operation Mode:</b>	Normal Link	<b>Test Date:</b>	2017-8-2
<b>Temperature:</b>	25°C	<b>Tested by:</b>	Lily.Wang
<b>Humidity:</b>	48% RH	<b>Polarity:</b>	Ver. / Hor.

Frequency (MHz)	Ant. Pol. (H/V)	Reading (dBuV)	Correction Factor (dB/m)	Result (dBuV/m)	Limit (dBuV/m)	Margin (dB)	Remark
359.8000	V	16.49	17.71	34.20	46.00	-11.80	Peak
504.3300	V	15.72	21.61	37.33	46.00	-8.67	Peak
656.6200	V	15.24	24.49	39.73	46.00	-6.27	Peak
743.9200	V	16.17	26.26	42.43	46.00	-3.57	Peak
864.2000	V	15.79	26.09	41.88	46.00	-4.12	Peak
967.9900	V	16.10	27.07	43.17	54.00	-10.83	Peak
456.8000	H	14.14	21.00	35.14	46.00	-10.86	QP
480.0800	H	13.35	21.32	34.67	46.00	-11.33	QP
504.1100	H	20.00	21.61	41.61	46.00	-4.39	QP
528.5800	H	17.07	21.65	38.72	46.00	-7.28	QP
551.8600	H	14.23	21.71	35.94	46.00	-10.06	QP
600.3600	H	20.94	22.30	43.24	46.00	-2.76	Peak

**Remark:**

1. Measuring frequencies from 30 MHz to the 1GHz.(no emission found from the lowest internal used/generated frequency to 30MHz)
2. Radiated emissions measured were made with an instrument using peak/quasi-peak detector mode.
3. Quasi-peak test would be performed if the peak result were greater than the quasi-peak limit or as required by the applicant.
4. Measurements above show only up to 6 maximum emissions noted, or would be lesser, with " N/A " remark, if no specific emissions from the EUT are recorded (ie: margin>20dB from the applicable limit) and considered that's already beyond the background noise floor.
5. Margin (dB) = Remark result (dBuV/m) – Quasi-peak limit (dBuV/m).



**Above 1 GHz**

<b>Operation Mode:</b>	Tx / IEEE 802.11a mode CH Low	<b>Test Date:</b>	2017-8-2
<b>Temperature:</b>	25°C	<b>Tested by:</b>	Lily.Wang
<b>Humidity:</b>	48% RH	<b>Polarity:</b>	Ver. / Hor.

**Horizontal**

No.	Frequency (MHz)	Reading (dBuV)	Correct Factor(dB/m)	Result (dBuV/m)	Limit (dBuV/m)	Margin (dB)	Height (cm)	Degree (deg.)	Remark
1	10129.000	41.54	8.92	50.46	74.00	-23.54	100	33	peak
2	14855.000	38.64	15.46	54.10	74.00	-19.90	100	19	peak
N/A									

**Vertical**

No.	Frequency (MHz)	Reading (dBuV)	Correct Factor(dB/m)	Result (dBuV/m)	Limit (dBuV/m)	Margin (dB)	Height (cm)	Degree (deg.)	Remark
1	9993.000	41.67	8.20	49.87	74.00	-24.13	100	271	peak
2	14821.000	38.04	15.47	53.51	74.00	-20.49	100	197	peak
N/A									

<b>Operation Mode:</b>	Tx / IEEE 802.11a mode CH Mid	<b>Test Date:</b>	2017-8-2
<b>Temperature:</b>	25°C	<b>Tested by:</b>	Lily.Wang
<b>Humidity:</b>	48% RH	<b>Polarity:</b>	Ver. / Hor.

**Horizontal**

No.	Frequency (MHz)	Reading (dBuV)	Correct Factor(dB/m)	Result (dBuV/m)	Limit (dBuV/m)	Margin (dB)	Height (cm)	Degree (deg.)	Remark
1	10639.000	41.28	11.51	52.79	74.00	-21.21	100	269	peak
2	15348.000	36.79	12.94	49.73	74.00	-24.27	100	253	peak
N/A									

**Vertical**

No.	Frequency (MHz)	Reading (dBuV)	Correct Factor(dB/m)	Result (dBuV/m)	Limit (dBuV/m)	Margin (dB)	Height (cm)	Degree (deg.)	Remark
1	10554.000	41.55	11.18	52.73	74.00	-21.27	100	3	peak
2	15348.000	38.23	12.94	51.17	74.00	-22.83	100	10	peak
N/A									

<b>Operation Mode:</b>	Tx / IEEE 802.11a mode CH High	<b>Test Date:</b>	2017-8-2
<b>Temperature:</b>	25°C	<b>Tested by:</b>	Lily.Wang
<b>Humidity:</b>	48% RH	<b>Polarity:</b>	Ver. / Hor.

**Horizontal**

No.	Frequency (MHz)	Reading (dBuV)	Correct Factor(dB/m)	Result (dBuV/m)	Limit (dBuV/m)	Margin (dB)	Height (cm)	Degree (deg.)	Remark
1	10843.000	39.72	12.31	52.03	74.00	-21.97	100	9	peak
2	15348.000	37.57	12.94	50.51	74.00	-23.49	100	262	peak
N/A									

**Vertical**

No.	Frequency (MHz)	Reading (dBuV)	Correct Factor(dB/m)	Result (dBuV/m)	Limit (dBuV/m)	Margin (dB)	Height (cm)	Degree (deg.)	Remark
1	10996.000	40.42	12.90	53.32	74.00	-20.68	100	351	peak
2	15365.000	38.27	12.82	51.09	74.00	-22.91	100	3	peak
N/A									

<b>Operation Mode:</b>	TX / IEEE 802.11n HT20 mode /CH Low	<b>Test Date:</b>	2017-8-2
<b>Temperature:</b>	25°C	<b>Tested by:</b>	Lily.Wang
<b>Humidity:</b>	48% RH	<b>Polarity:</b>	Ver. / Hor.

**Horizontal**

No.	Frequency (MHz)	Reading (dBuV)	Correct Factor(dB/m)	Result (dBuV/m)	Limit (dBuV/m)	Margin (dB)	Height (cm)	Degree (deg.)	Remark
1	10333.000	41.22	10.05	51.27	74.00	-22.73	100	142	peak
2	14889.000	38.15	15.45	53.60	74.00	-20.40	100	2	peak
N/A									

**Vertical**

No.	Frequency (MHz)	Reading (dBuV)	Correct Factor(dB/m)	Result (dBuV/m)	Limit (dBuV/m)	Margin (dB)	Height (cm)	Degree (deg.)	Remark
1	10435.000	41.44	10.61	52.05	74.00	-21.95	100	326	peak
2	14821.000	37.90	15.47	53.37	74.00	-20.63	100	131	peak
N/A									

<b>Operation Mode:</b>	TX / IEEE 802.11n HT20 mode /CH Mid	<b>Test Date:</b>	2017-8-2
<b>Temperature:</b>	25°C	<b>Tested by:</b>	Lily.Wang
<b>Humidity:</b>	48% RH	<b>Polarity:</b>	Ver. / Hor.

**Horizontal**

No.	Frequency (MHz)	Reading (dBuV)	Correct Factor(dB/m)	Result (dBuV/m)	Limit (dBuV/m)	Margin (dB)	Height (cm)	Degree (deg.)	Remark
1	10520.000	41.28	11.05	52.33	74.00	-21.67	100	361	peak
2	15433.000	37.54	12.34	49.88	74.00	-24.12	100	0	peak
N/A									

**Vertical**

No.	Frequency (MHz)	Reading (dBuV)	Correct Factor(dB/m)	Result (dBuV/m)	Limit (dBuV/m)	Margin (dB)	Height (cm)	Degree (deg.)	Remark
1	10469.000	42.09	10.80	52.89	74.00	-21.11	100	3	peak
2	15365.000	37.87	12.82	50.69	74.00	-23.31	100	10	peak
N/A									

<b>Operation Mode:</b>	TX / IEEE 802.11n HT20 mode /CH High	<b>Test Date:</b>	2017-8-2
<b>Temperature:</b>	25°C	<b>Tested by:</b>	Lily.Wang
<b>Humidity:</b>	48% RH	<b>Polarity:</b>	Ver. / Hor.

**Horizontal**

No.	Frequency (MHz)	Reading (dBuV)	Correct Factor(dB/m)	Result (dBuV/m)	Limit (dBuV/m)	Margin (dB)	Height (cm)	Degree (deg.)	Remark
1	10809.000	40.40	12.18	52.58	74.00	-21.42	100	322	peak
2	15331.000	38.26	13.06	51.32	74.00	-22.68	100	196	peak
N/A									

**Vertical**

No.	Frequency (MHz)	Reading (dBuV)	Correct Factor(dB/m)	Result (dBuV/m)	Limit (dBuV/m)	Margin (dB)	Height (cm)	Degree (deg.)	Remark
1	10979.000	40.88	12.84	53.72	74.00	-20.28	100	348	peak
2	15348.000	37.74	12.94	50.68	74.00	-23.32	100	250	peak
N/A									

## 7.8 POWERLINE CONDUCTED EMISSIONS

### LIMIT

According to §15.207(a), except as shown in paragraphs (b) and (c) of this section, for an intentional radiator that is designed to be connected to the public utility (AC) power line, the radio frequency voltage that is conducted back onto the AC power line on any frequency or frequencies within the band 150 kHz to 30 MHz shall not exceed the limits in the following table, as measured using a 50  $\mu$ H/50 ohms line impedance stabilization network (LISN). Compliance with the provisions of this paragraph shall be based on the measurement of the radio frequency voltage between each power line and ground at the power terminal. The lower limit applies at the boundary between the frequency ranges.

Frequency Range (MHz)	Limits (dB $\mu$ V)	
	Quasi-peak	Average
0.15 to 0.50	66 to 56*	56 to 46*
0.50 to 5	56	46
5 to 30	60	50

\* Decreases with the logarithm of the frequency.

### TEST CONFIGURATION

See test photographs attached in Appendix 1 for the actual connections between EUT and support equipment.

### TEST PROCEDURE

1. The EUT was placed on a table, which is 0.8m above ground plane.
2. Maximum procedure was performed on the six highest emissions to ensure EUT compliance.
3. Repeat above procedures until all frequency measured were complete.

### TEST RESULTS

The initial step in collecting conducted data is a spectrum analyzer peak scan of the measurement range. Significant peaks are then marked as shown on the following data page, and these signals are then quasi-peaked.

### Test Data

Job No.:	C170630R01	Date:	2017-7-22
Model No.:	YVR.1017	Time:	8:56:17
Standard:	FCC Class B	Temp.(C)/Hum.(%):	22(C)/48%
Test item:	Conduction test	Test By:	Lily.Wang
Line:	L1	Test Voltage:	AC 120V/60Hz
Model:		Description:	

### L1

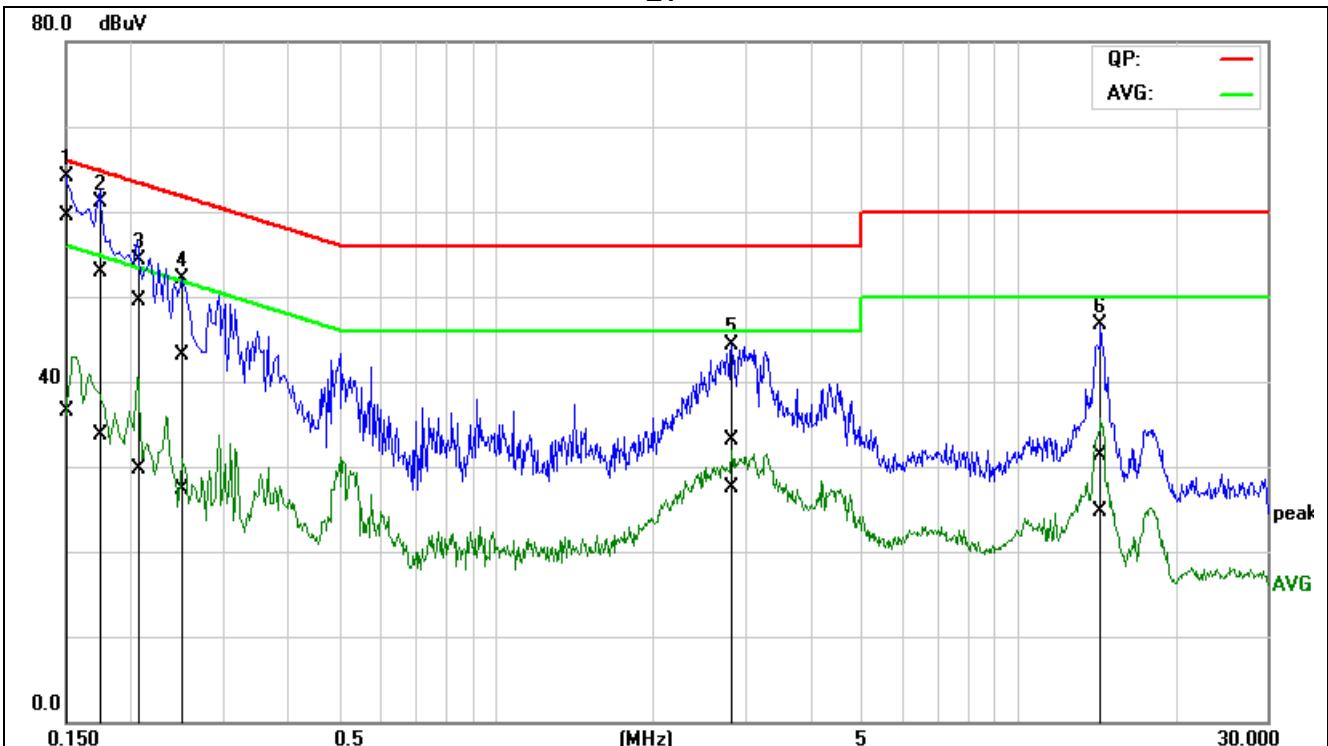

No.	Frequency (MHz)	QuasiPeak reading (dBuV)	Average reading (dBuV)	Correction factor (dB)	QuasiPeak result (dBuV)	Average result (dBuV)	QuasiPeak limit (dBuV)	Average limit (dBuV)	QuasiPeak margin (dB)	Average margin (dB)	Remark
1*	0.1515	38.92	15.92	20.59	59.51	36.51	65.92	55.92	-6.41	-19.41	Pass
2	0.1767	32.34	13.11	20.55	52.89	33.66	64.64	54.64	-11.75	-20.98	Pass
3	0.2088	28.96	9.22	20.50	49.46	29.72	63.25	53.25	-13.79	-23.53	Pass
4	0.2505	22.61	6.86	20.44	43.05	27.30	61.74	51.74	-18.69	-24.44	Pass
5	2.8211	12.66	7.08	20.51	33.17	27.59	56.00	46.00	-22.83	-18.41	Pass
6	14.4032	10.53	3.93	20.79	31.32	24.72	60.00	50.00	-28.68	-25.28	Pass

**Note:** 1. L1 = Line One (Live Line) / L2 = Line Two (Neutral Line).

Job No.:	C170630R01	Date:	2017-7-22
Model No.:	YVR.1017	Time:	9:01:08
Standard:	FCC Class B	Temp.(C)/Hum.(%):	22(C)/48%
Test item:	Conduction test	Test By:	Lily.Wang
Line:	L2	Test Voltage:	AC 120V/60Hz
Model:		Description:	

### L2

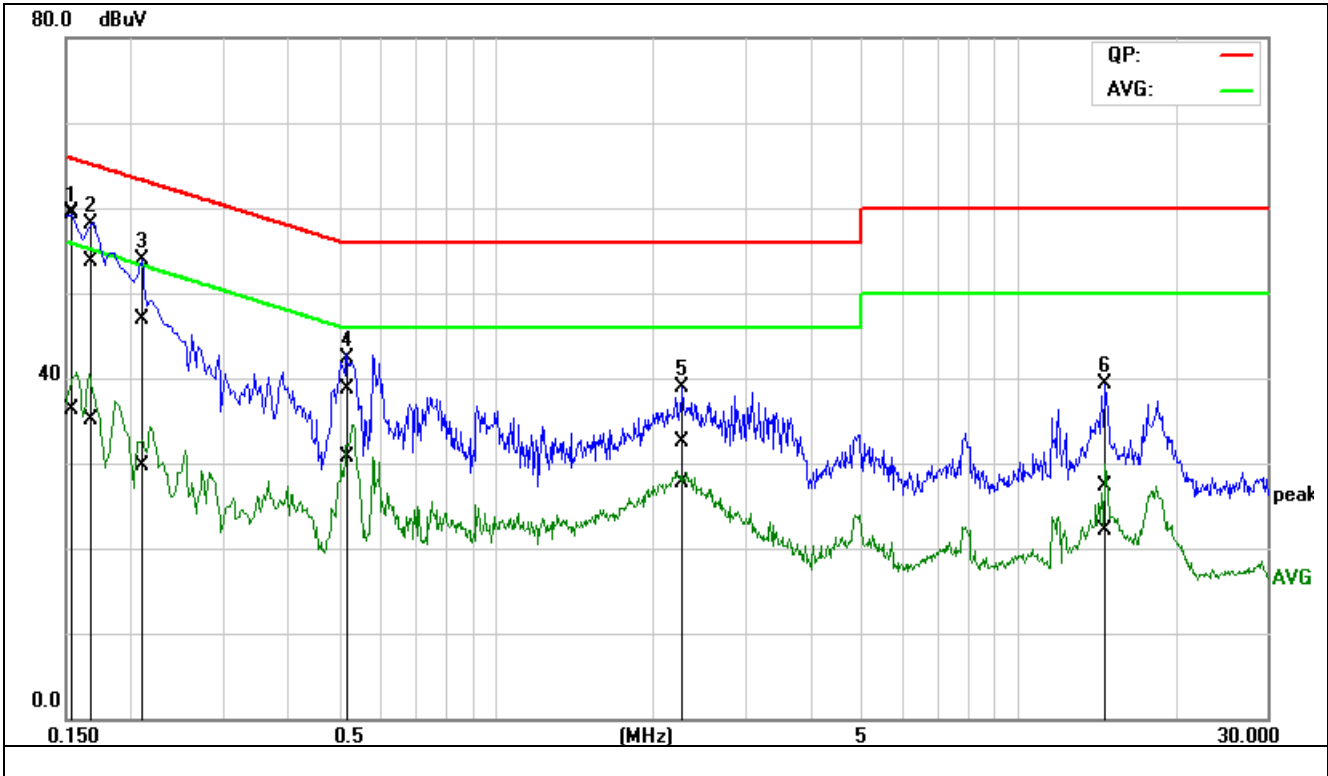

No.	Frequency (MHz)	QuasiPeak reading (dBuV)	Average reading (dBuV)	Correction factor (dB)	QuasiPeak result (dBuV)	Average result (dBuV)	QuasiPeak limit (dBuV)	Average limit (dBuV)	QuasiPeak margin (dB)	Average margin (dB)	Remark
1*	0.1500	39.15	15.86	20.36	59.51	36.22	66.00	56.00	-6.49	-19.78	Pass
2	0.1652	33.41	14.72	20.37	53.78	35.09	65.20	55.20	-11.42	-20.11	Pass
3	0.2079	26.41	9.29	20.41	46.82	29.70	63.29	53.29	-16.47	-23.59	Pass
4	0.5232	18.20	10.21	20.45	38.65	30.66	56.00	46.00	-17.35	-15.34	Pass
5	2.2806	11.99	7.11	20.55	32.54	27.66	56.00	46.00	-23.46	-18.34	Pass
6	14.7296	6.52	1.25	20.81	27.33	22.06	60.00	50.00	-32.67	-27.94	Pass

**Note:** 1. L1 = Line One (Live Line) / L2 = Line Two (Neutral Line).

**Remark:**

- The measuring frequencies range between 0.15 MHz and 30 MHz.
- The emissions measured in the frequency range between 0.15 MHz and 30MHz were made with an instrument using Quasi-peak detector and Average detector.
- "---" denotes the emission level was or more than 2dB below the Average limit, and no re-check was made.
- The IF bandwidth of SPA between 0.15MHz and 30MHz was 10KHz. The IF bandwidth of Test Receiver between 0.15MHz and 30MHz was 9kHz.

**END OF REPORT**