

FCC 47 CFR PART 15 SUBPART C**TEST REPORT****For****Product Name: YI 360 VR Camera****Brand Name: YI****Model No.:YVR.1017****Series Model.: N/A****FCC ID: 2AFIB-YVR1017****Test Report Number:
C170630R01-RPW****Issued for****Shanghai Xiaoyi Technology Co., Ltd.****6F,Building E,No.2889,Jinke Road,Shanghai,China****Issued by****Compliance Certification Services Inc.****Kun shan Laboratory****No.10 Weiye Rd., Innovation park, Eco&Tec,
Development Zone, Kunshan City, Jiangsu, China****TEL: 86-512-57355888****FAX: 86-512-57370818**

TESTING CERT #2541.01

Note: This report shall not be reproduced except in full, without the written approval of Compliance Certification Services Inc. This document may be altered or revised by Compliance Certification Services Inc. personnel only, and shall be noted in the revision section of the document. The client should not use it to claim product endorsement by A2LA or any government agencies. The test results in the report only apply to the tested sample.

TABLE OF CONTENTS

1.	TEST RESULT CERTIFICATION.....	4
2.	EUT DESCRIPTION.....	5
3.	TEST METHODOLOGY	6
3.1.	EUT CONFIGURATION	6
3.2.	EUT EXERCISE	6
3.3.	GENERAL TEST PROCEDURES.....	6
3.4.	FCC PART 15.205 RESTRICTED BANDS OF OPERATIONS.....	7
3.5.	DESCRIPTION OF TEST MODES.....	8
3.6.	ANTENNA DESCRIPTION	8
4.	INSTRUMENT CALIBRATION.....	9
4.1.	MEASURING INSTRUMENT CALIBRATION	9
5.	FACILITIES AND ACCREDITATIONS	11
5.1.	FACILITIES	11
5.2.	EQUIPMENT.....	11
5.3.	LABORATORY ACCREDITATIONS AND LISTING	11
5.4.	TABLE OF ACCREDITATIONS AND LISTINGS	12
6.	SETUP OF EQUIPMENT UNDER TEST.....	13
6.1.	SETUP CONFIGURATION OF EUT.....	13
6.2.	SUPPORT EQUIPMENT.....	13
7.	FCC PART 15.247 REQUIREMENTS.....	14
7.1.	6DB BANDWIDTH	14
7.2.	PEAK POWER	20
7.3.	PEAK POWER SPECTRAL DENSITY	22
7.4.	SPURIOUS EMISSIONS	29
7.5.	RADIATED EMISSIONS.....	47
7.6.	POWERLINE CONDUCTED EMISSIONS	62

Revision History

Rev.	Issue Date	Report NO.	Effect Page	Contents
00	August 05, 2017	C170630R01-RPW	ALL	N/A
01	August 23, 2017	C170630R01-RPW	P5	Update antenna gain information

1. TEST RESULT CERTIFICATION

Product Name:	YI 360 VR Camera
Trade Name:	YI
Model Name.:	YVR.1017
Series Model:	N/A
Applicant Discrepancy:	Initial
Device Category:	Portable unit
Date of Test:	July 22, 2017 ~ August 04, 2017
Applicant:	Shanghai Xiaoyi Technology Co., Ltd. 6F,Building E,No.2889,Jinke Road,Shanghai,China
Manufacturer:	Shanghai Xiaoyi Technology Co., Ltd. 6F,Building E,No.2889,Jinke Road,Shanghai,China
Application Type:	Certification

APPLICABLE STANDARDS

STANDARD	TEST RESULT
FCC 47 CFR Part 15 Subpart C	No non-compliance noted

We hereby certify that:

The above equipment was tested by Compliance Certification Services Inc. The test data, data evaluation, test procedures, and equipment configurations shown in this report were made in accordance with the procedures given in ANSI C63.10: 2013 and the energy emitted by the sample EUT tested as described in this report is in compliance with the requirements of FCC Rules Part 15.207, 15.209, 15.247.

The test results of this report relate only to the tested sample EUT identified in this report.

Approved by:



Jeff.Fang
RF Manager
Compliance Certification Service Inc.

Tested by:

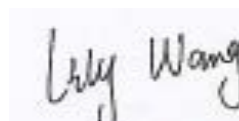

Lily.Wang
Test Engineer
Compliance Certification Service Inc.

2. EUT DESCRIPTION

Product Name:	YI 360 VR Camera
Brand Name:	YI
Model Name:	YVR.1017
Series Model:	N/A
Model Discrepancy:	N/A
Power Adapter:	From PC
Frequency Range:	IEEE 802.11b/g: 2412MHz to 2462 MHz IEEE 802.11n HT20: 2412MHz to 2462 MHz
Average Transmit Power:	IEEE 802.11b mode: 12.40 dBm IEEE 802.11g mode: 12.31 dBm IEEE 802.11n HT20 mode:12.13 dBm
Modulation Technique:	IEEE802.11b mode: DSSS (1,2,5.5 and 11 Mbps) IEEE802.11g mode: DSSS /OFDM (6,9,12,18,24,36,48 and 54 Mbps) IEEE802.11n HT20 mode: OFDM (MCS0~MCS7)
Number of Channels:	IEEE 802.11b/g mode: 11 Channels IEEE 802.11n HT20 : 11 Channels
Antenna Specification:	FPC Antenna Gain: 1.62dBi

Remark:

- 1.The sample selected for test was engineering sample that approximated to production product and was provided by manufacturer.
- 2.This submittal(s) (test report) is intended for **FCC ID: 2AFIB-YVR1017** filing to comply with Section 15.207, 15.209 and 15.247 of the FCC Part 15, Subpart C Rules.

3. TEST METHODOLOGY

The tests documented in this report were performed in accordance with ANSI C63.10 2013 and FCC CFR 47 15.207, 15.209 and 15.247.

3.1.EUT CONFIGURATION

The EUT configuration for testing is installed on RF field strength measurement to meet the Commissions requirement and operating in a manner that intends to maximize its emission characteristics in a continuous normal application.

3.2.EUT EXERCISE

The EUT was operated in the engineering mode to fix the TX frequency that was for the purpose of the measurements.

According to its specifications, the EUT must comply with the requirements of the Section 15.207, 15.209 and 15.247 under the FCC Rules Part 15 Subpart C.

3.3.GENERAL TEST PROCEDURES

Conducted Emissions

The EUT is placed on the turntable, which is 0.8 m above ground plane. According to the requirements in Section 13.1.4.1 of ANSI C63.10 2013 Conducted emissions from the EUT measured in the frequency range between 0.15 MHz and 30MHz using CISPR Quasi-peak and average detector modes.

Radiated Emissions

Under 1GHz

The EUT is placed on a turn table, which is 0.8 m above ground plane. The turntable shall rotate 360 degrees to determine the position of maximum emission level. EUT is set 3m away from the receiving antenna, which varied from 1m to 4m to find out the highest emission. And also, each emission was to be maximized by changing the polarization of receiving antenna both horizontal and vertical. In order to find out the maximum emissions, exploratory radiated emission measurements were made according to the requirements in Section 13.1.4.1 of ANSI C63.10:2013.

Above 1GHz

The EUT is placed on a turn table, which is 1.5 m above ground plane. The turntable shall rotate 360 degrees to determine the position of maximum emission level. EUT is set 3m away from the receiving antenna, which varied from 1m to 4m to find out the highest emission. And also, each emission was to be maximized by changing the polarization of receiving antenna both horizontal and vertical. In order to find out the maximum emissions, exploratory radiated emission measurements were made according to the requirements in Section 13.1.4.1 of ANSI C63.10:2013.

3.4.FCC PART 15.205 RESTRICTED BANDS OF OPERATIONS

Except as shown in paragraph (d) of this section, only spurious emissions are permitted in any of the frequency bands listed below:

MHz	MHz	MHz	GHz
0.090 - 0.110	16.42 - 16.423	399.9 - 410	4.5 - 5.15
¹ 0.495 - 0.505	16.69475 - 16.69525	608 - 614	5.35 - 5.46
2.1735 - 2.1905	16.80425 - 16.80475	960 - 1240	7.25 - 7.75
4.125 - 4.128	25.5 - 25.67	1300 - 1427	8.025 - 8.5
4.17725 - 4.17775	37.5 - 38.25	1435 - 1626.5	9.0 - 9.2
4.20725 - 4.20775	73 - 74.6	1645.5 - 1646.5	9.3 - 9.5
6.215 - 6.218	74.8 - 75.2	1660 - 1710	10.6 - 12.7
6.26775 - 6.26825	108 - 121.94	1718.8 - 1722.2	13.25 - 13.4
6.31175 - 6.31225	123 - 138	2200 - 2300	14.47 - 14.5
8.291 - 8.294	149.9 - 150.05	2310 - 2390	15.35 - 16.2
8.362 - 8.366	156.52475 - 156.52525	2483.5 - 2500	17.7 - 21.4
8.37625 - 8.38675	156.7 - 156.9	2655 - 2900	22.01 - 23.12
8.41425 - 8.41475	162.0125 - 167.17	3260 - 3267	23.6 - 24.0
12.29 - 12.293	167.72 - 173.2	3332 - 3339	31.2 - 31.8
12.51975 - 12.52025	240 - 285	3345.8 - 3358	36.43 - 36.5
12.57675 - 12.57725	322 - 335.4	3600 - 4400	(²)
13.36 - 13.41			

¹ Until February 1, 1999, this restricted band shall be 0.490-0.510 MHz.

² Above 38.6

Except as provided in paragraphs (d) and (e), the field strength of emissions appearing within these frequency bands shall not exceed the limits shown in Section 15.209. At frequencies equal to or less than 1000 MHz, compliance with the limits in Section 15.209 shall be demonstrated using measurement instrumentation employing a CISPR quasi-peak detector. Above 1000 MHz, compliance with the emission limits in Section 15.209 shall be demonstrated based on the average value of the measured emissions. The provisions in Section 15.35 apply to these measurements.

3.5. DESCRIPTION OF TEST MODES

The worst-case data rates:

IEEE802.11b mode:

Channel Low (2412MHz)

Channel Mid (2437MHz)

Channel High (2462MHz) with 1Mbps data rate was chosen for full testing.

IEEE802.11g mode:

Channel Low (2412MHz)

Channel Mid (2437MHz)

Channel High (2462MHz) with 6Mbps data rate was chosen for full testing.

IEEE 802.11n HT20 MHz Channel mode:

Channel Low (2412MHz)

Channel Mid (2437MHz)

Channel High (2462MHz) with MCS0 data rate was chosen for full testing.

3.6. ANTENNA DESCRIPTION

an intentional radiator antenna shall be designed to ensure that no antenna other than that furnished by the responsible party can be used with the device. The use of a permanently attached or an antenna that uses a unique coupling to the intentional radiator shall be considered sufficient to comply with the provisions of this section”

* the antenna of this EUT is a unique(FPC Antenna for WiFi).

* the EUT complies with the requirement of 15.203.



4. INSTRUMENT CALIBRATION

4.1. MEASURING INSTRUMENT CALIBRATION

The measuring equipment, which was utilized in performing the tests documented herein, has been calibrated in accordance with the manufacturer's recommendations for utilizing calibration equipment, which is traceable to recognized national standards.

Equipment Used for Emissions Measurement

Conducted Emissions Test Site					
Name of Equipment	Manufacturer	Model	Serial Number	Calibration Date	Calibration Due
Spectrum Analyzer	Agilent	E4446A	MY44020154	2016-9-10	2017-9-9
Spectrum Analyzer	RS	FSU26	200789	2016-7-21	2017-7-20
Spectrum Analyzer	RS	FSU26	200789	2017-7-20	2018-7-19
Power meter	Anritsu	ML2495A	1445010	2017-4-26	2018-4-25
Power sensor	Anritsu	MA2411B	1339220	2017-4-26	2018-4-25
Power SPLITTER	Mini-Circuits	ZN2PD-9G	SF078500430	N.C.R	N.C.R
DC Power Supply	AGILENT	E3632A	MY50340053	N.C.R	N.C.R
Temp. / Humidity Gauge	Anymetre	TH603	CCS007	2016-11-1	2017-10-31
Test Software			EZ-EMC		

977 Chamber					
Name of Equipment	Manufacturer	Model	Serial Number	Calibration Date	Calibration Due
Spectrum Analyzer	Agilent	E4446A	MY44020154	2016-9-10	2017-9-9
Spectrum Analyzer	RS	FSU26	200789	2016-7-21	2017-7-20
Spectrum Analyzer	RS	FSU26	200789	2017-7-20	2018-7-19
EMI Test Receiver	R&S	ESCI	101378	2017-1-5	2018-1-4
Pre-Amplifier	MITEQ	AMF-6F-260400-40-8P	1037496	2016-11-15	2017-11-14
Amplifier	MITEQ	JS41-00101800-32-10P	1675713	2017-7-20	2018-7-19
Broad-Band Horn Antenna	SCHWARZBECK	BBHA 9170	9170-515	2017-3-6	2018-3-5
Bilog Antenna	Sunol	JB1	A062604	2017-5-27	2018-5-26
Bilog Antenna	Sunol	JB1	A110204-1	2017-5-27	2018-5-26
Loop Antenna	Hengweiyi	39501C	2014012	2017-1-5	2018-1-4
Horn-antenna	SCHWARZBECK	9120D	D:266	2017-2-28	2018-2-27
Horn-antenna	SCHWARZBECK	9120D	D:267	2016-11-10	2017-11-9
Turn Table	CT	CT123	4165	N.C.R	N.C.R
Antenna Tower	CT	CTERG23	3256	N.C.R	N.C.R
Controller	CT	CT100	95637	N.C.R	N.C.R
Test Software			EZ-EMC		

Conducted Emission					
Name of Equipment	Manufacturer	Model	Serial Number	Calibration Date	Calibration Due
EMI TEST RECEIVER	R&S	ESCI	100781	2017-2-28	2018-2-27
V (V-LISN)	SCHWARZBECK	NNLK 8129	8129-143	2016-11-1	2017-10-31
TWO-LINE V-NETWORK	R&S	ENV216	101604	2016-11-1	2017-10-31
Pulse LIMITER	R&S	ESH3-Z2	100524	2017-1-5	2018-1-4
Test Software			EZ-EMC		

Remark: The measurement uncertainty is less than +/- 2.81dB, which is evaluated as per the NAMAS NIS 81 and CISPR/A/291/CDV.

Expanded Uncertainty (95% CONFIDENCE INTERVAL): K=2

5. FACILITIES AND ACCREDITATIONS

5.1.FACILITIES

All measurement facilities used to collect the measurement data are located at CCS China Kunshan Lab at 10#Weiye Rd, Innovation Park Eco. & Tec. Development Zone Kunshan city JiangSu, (215300), CHINA.

The sites are constructed in conformance with the requirements of ANSI C63.7, ANSI C63.10 2013 and CISPR Publication 22.

5.2.EQUIPMENT

Radiated emissions are measured with one or more of the following types of linearly polarized antennas: tuned dipole, biconical, log periodic, bi-log, and/or ridged waveguide, horn. Spectrum analyzers with pre-selectors and quasi-peak detectors are used to perform radiated measurements.

Conducted emissions are measured with Line Impedance Stabilization Networks and EMI Test Receivers.

Calibrated wideband preamplifiers, coaxial cables, and coaxial attenuators are also used for making measurements.

All receiving equipment conforms to CISPR Publication 16-1, "Radio Interference Measuring Apparatus and Measurement Methods."

5.3.LABORATORY ACCREDITATIONS AND LISTING

FCC –Designation Number: CN1172.

Compliance Certification Services Inc. Kun shan Laboratory has been registered and fully described in a report filed with the (FCC) Federal Communications Commission. The acceptance letter from the FCC is maintained in our files and the Designation Number: CN1172.

5.4. TABLE OF ACCREDITATIONS AND LISTINGS

Country	Agency	Scope of Accreditation	Logo
USA	A2LA	47 CFR FCC Part 15/18 (using ANSI C63.10 :2013); VCCI V3; CNS 13438; CNS 13439; CNS 13803; CISPR 11; EN 55011; CISPR 13; EN 55013; CISPR 22:2005; CISPR 22:1997 +A1 :2000+A2 :2002; EN 55022:2006; EN55022 :1998 +A1 :2001+A2 :2003; EN 61000-6-3 (excluding discontinuous interference); EN 61000-6-4; AS/NZS CISPR 22; CAN/CSA-CEI/IEC CISPR 22; EN 61000-3-2; EN 61000-3-3; EN550024; EN 61000-4-2; EN 61000-4-3; EN61000-4-4; EN 61000-4-5; EN 61000-4-6; IEC 61000-4-8; EN 61000-4-11; IEC61000-3-2; IEC61000-3-3; IEC 61000-4-2; IEC 61000-4-3; IEC 61000-4-4; IEC 61000-4-5; IEC 61000-4-6; IEC 61000-4-8; IEC 61000-4-11; EN 300 220-3; EN 300 328; EN 300 330-2; EN 300 440-1; EN 300-440-2; EN 300 893; EN 301 489-01; EN 301 489-3; EN 301 489-07; EN 301 489-17; 47 CFR FCC Part 15, 22, 24	
USA	FCC	3/10 meter Sites to perform FCC Part 15/18 measurements	
Japan	VCCI	3/10 meter Sites and conducted test sites to perform radiated/conducted measurements	

** No part of this report may be used to claim or imply product endorsement by A2LA or any agency of the US Government.*

6. SETUP OF EQUIPMENT UNDER TEST

6.1.SETUP CONFIGURATION OF EUT

See test photographs attached in Appendix 1 for the actual connections between EUT and support equipment.

6.2.SUPPORT EQUIPMENT

No.	Device Type	Brand	Model	Series No.	FCC ID
1.	N/A				

Remark:

1. *All the equipment/cables were placed in the worst-case configuration to maximize the emission during the test.*
2. *Grounding was established in accordance with the manufacturer's requirements and conditions for the intended use.*

7. FCC PART 15.247 REQUIREMENTS

7.1.6DB BANDWIDTH

LIMIT

According to §15.247(a)(2), systems using digital modulation techniques may operate in the 902 - 928 MHz, and 2400 - 2483.5 MHz bands, and 5725 - 5850 MHz bands. The minimum 6dB bandwidth shall be at least 500kHz.

Test Configuration

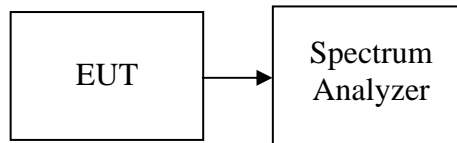

TEST PROCEDURE

The transmitter output is connected to the spectrum analyzer. The RBW is set to 1% to 3% of the selected span. The VBW is set to 3 times the RBW. The sweep time is occupied.

TEST RESULTS

No non-compliance noted

Test Data

IEEE 802.11b mode

Channel	Frequency (MHz)	Bandwidth (MHz)	Limit (kHz)	Result
Low	2412	8.125	>500	PASS
Mid	2437	8.077		PASS
High	2462	8.125		PASS

IEEE 802.11g mode

Channel	Frequency (MHz)	Bandwidth (MHz)	Limit (kHz)	Result
Low	2412	15.769	>500	PASS
Mid	2437	15.769		PASS
High	2462	15.481		PASS

IEEE 802.11n HT20 mode

Channel	Frequency (MHz)	Bandwidth (MHz)	Limit (kHz)	Result
Low	2412	17.308	>500	PASS
Mid	2437	17.067		PASS
High	2462	17.067		PASS

Test Plot

IEEE 802.11b MODE

6dB Bandwidth (CH Low)

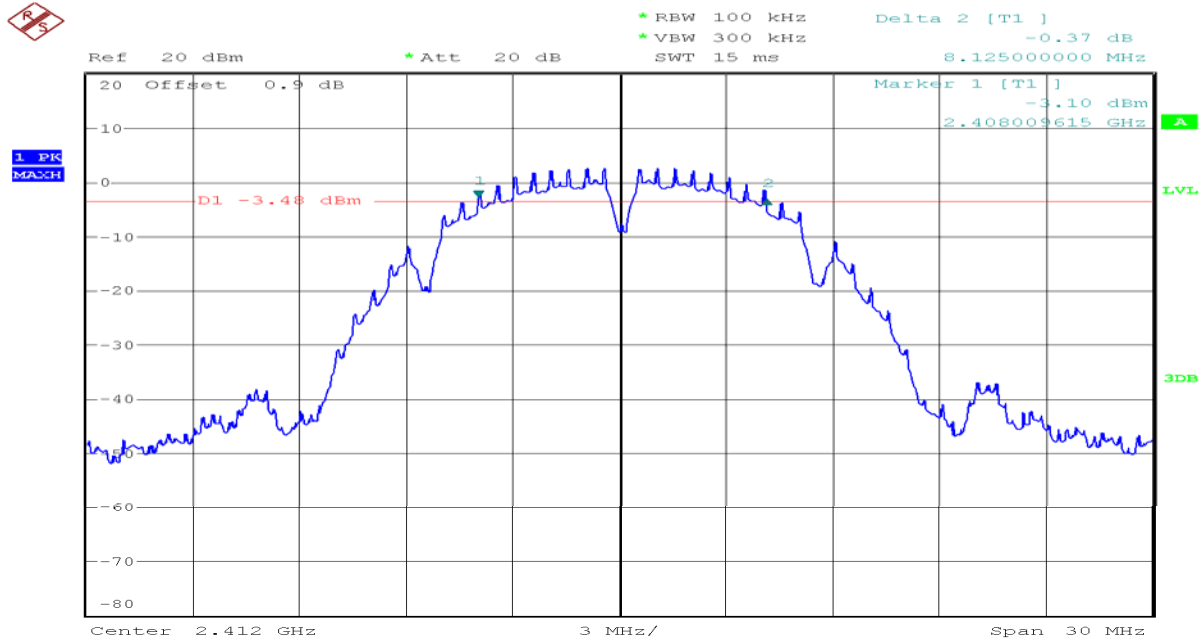

Date: 3.AUG.2017 16:54:18

6dB Bandwidth (CH Mid)

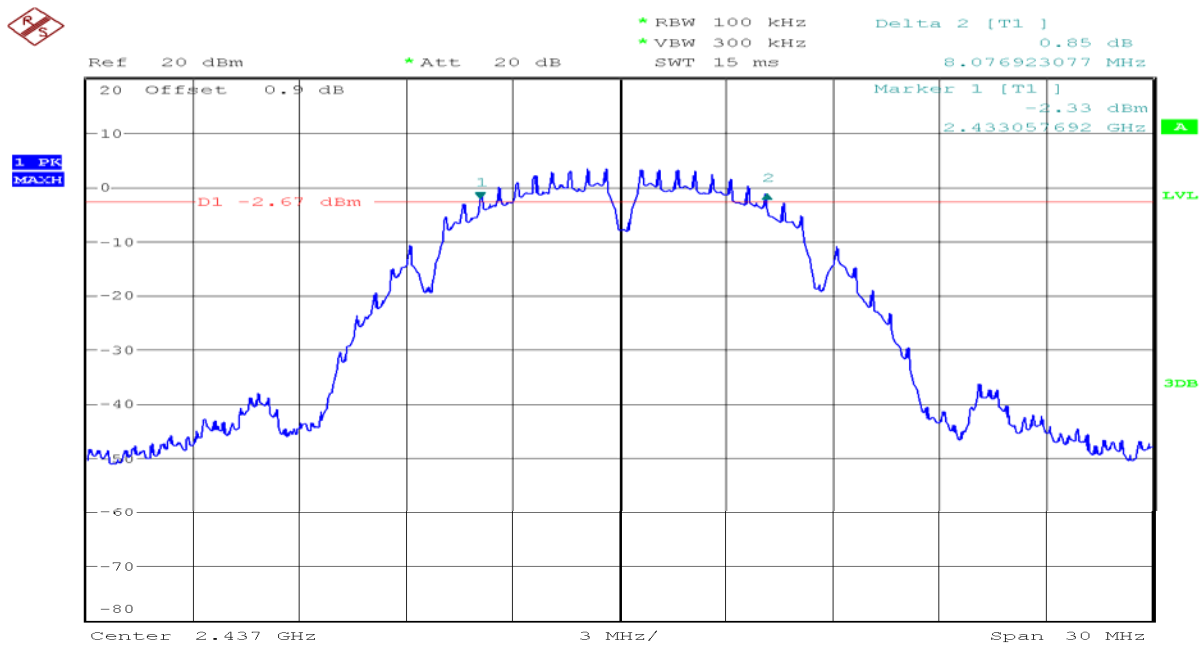

Date: 3.AUG.2017 17:02:23

6dB Bandwidth (CH High)

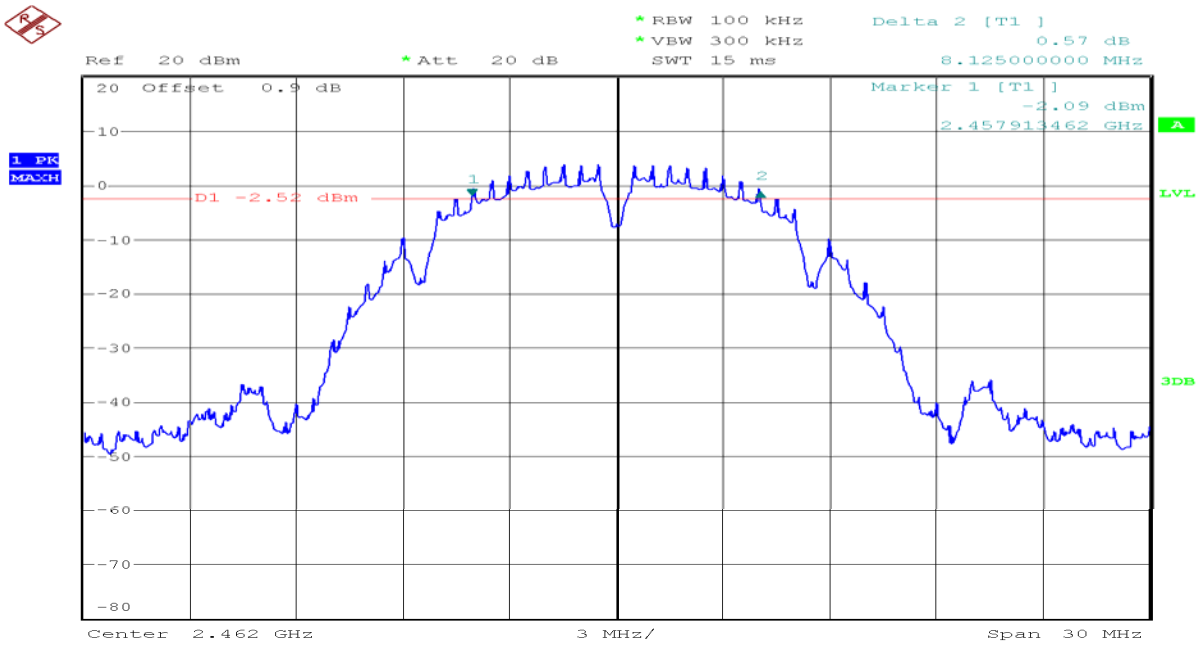

Date: 3.AUG.2017 17:05:07

IEEE 802.11g MODE

6dB Bandwidth (CH Low)

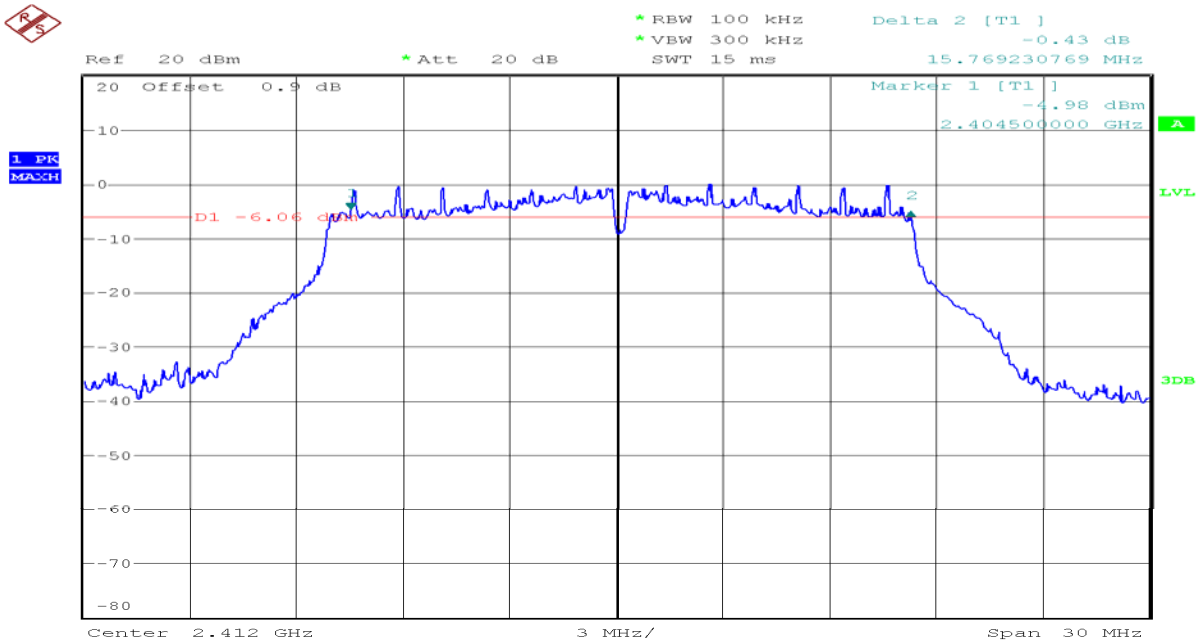

Date: 3.AUG.2017 17:16:11

6dB Bandwidth (CH Mid)

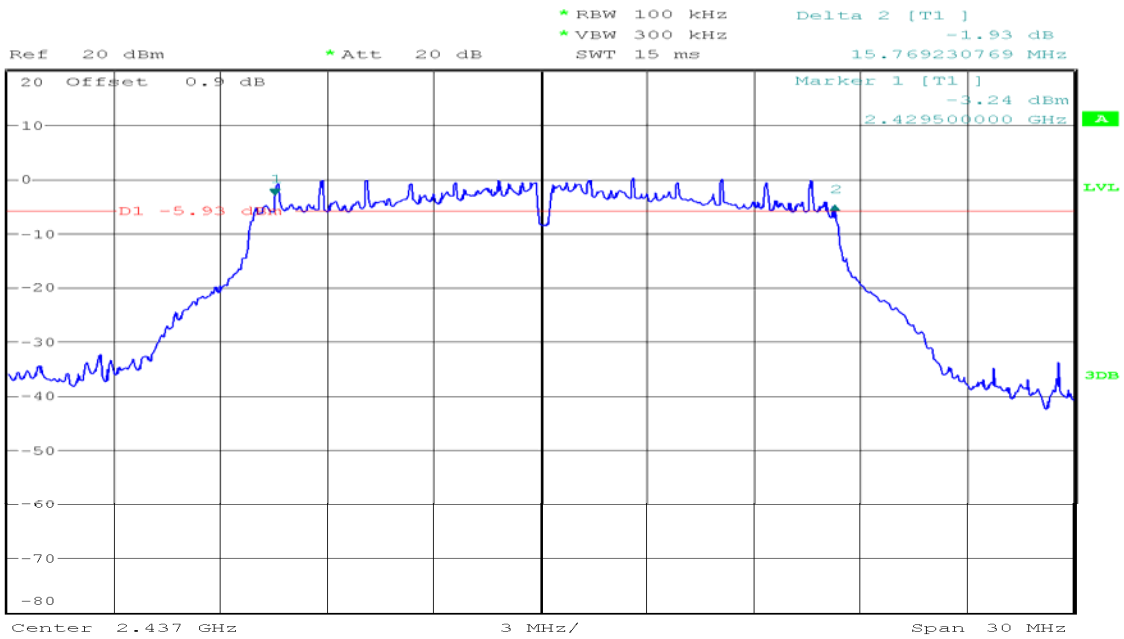

Date: 3.AUG.2017 17:12:36

6dB Bandwidth (CH High)

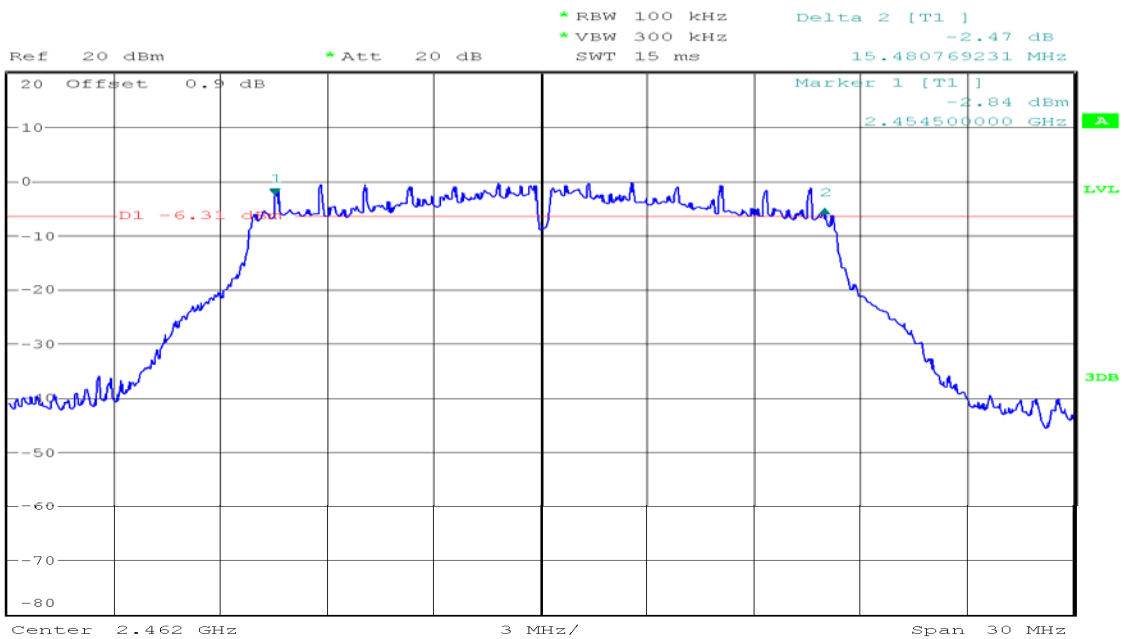

Date: 3.AUG.2017 17:08:19

IEEE 802.11n HT20 mode

6dB Bandwidth (CH Low)

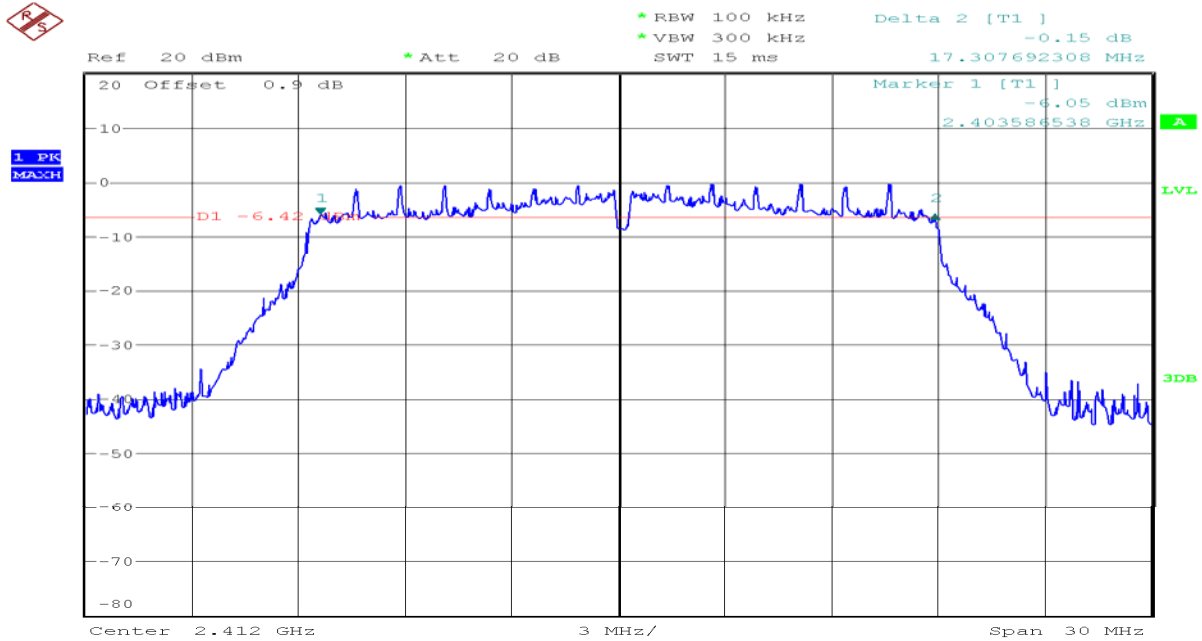

Date: 3.AUG.2017 17:19:22

6dB Bandwidth (CH Mid)

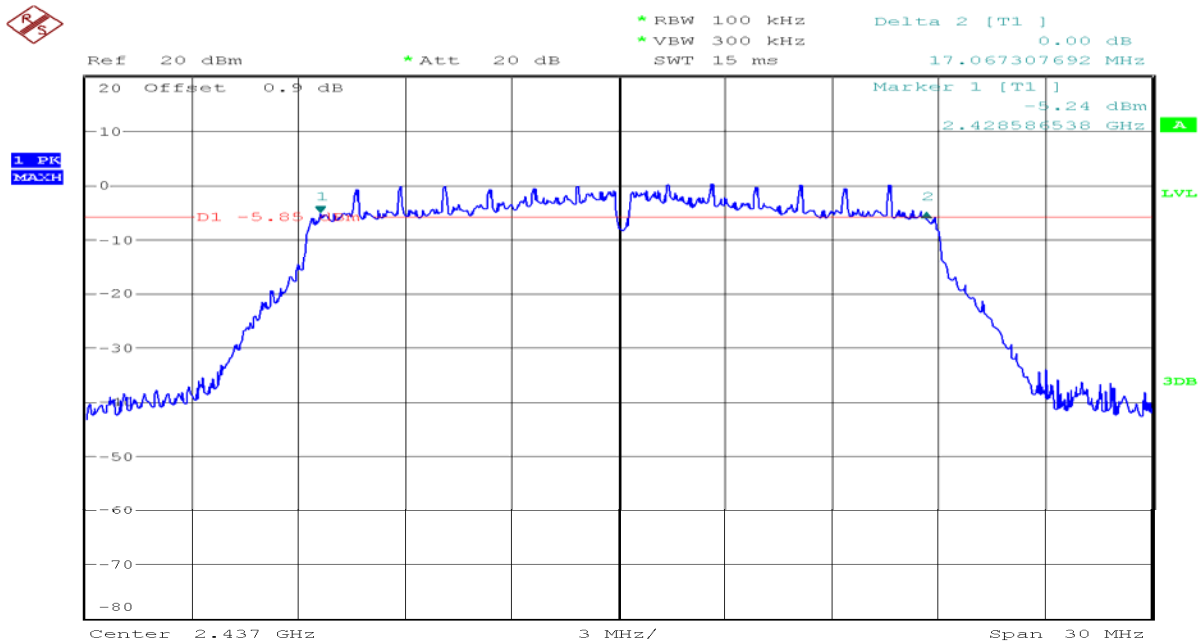

Date: 3.AUG.2017 17:24:37

6dB Bandwidth (CH High)

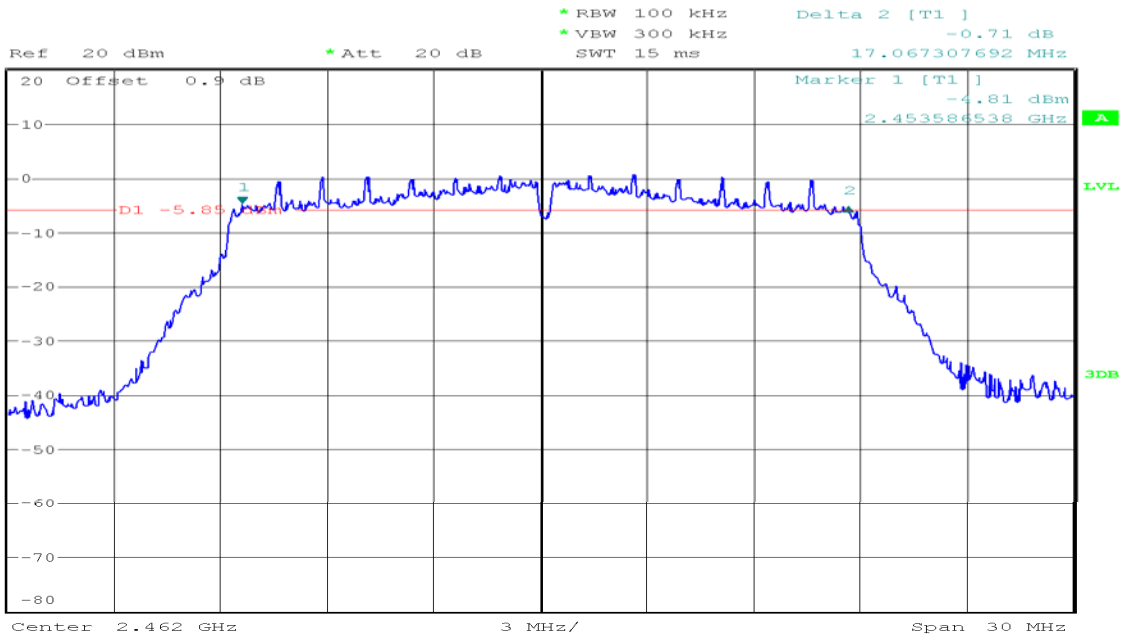

Date: 3.AUG.2017 17:27:18

7.2. PEAK POWER

LIMIT

The maximum peak output power of the intentional radiator shall not exceed the following:

1. According to §15.247(b)(3), for systems using digital modulation in the bands of 902-928 MHz, and 2400-2483.5 MHz: 1 Watt.
2. According to §15.247(b)(4), the conducted output power limit specified in paragraph (b) of this section is based on the use of antennas with directional gains that do not exceed 6 dBi. Except as shown in paragraph (c) of this section, if transmitting antennas of directional gain greater than 6 dBi are used, the conducted output power from the intentional radiator shall be reduced below the stated values in paragraphs (b)(1), (b)(2), and (b)(3) of this section, as appropriate, by the amount in dB that the directional gain of the antenna exceeds 6 dBi.

Test Configuration

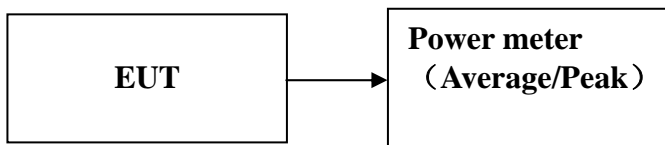

TEST PROCEDURE

1. The EUT transmitter output is connected to the Power meter. The Power meter is set to the peak power detection.
2. The testing follows the Measurement Procedure FCC KDB No. 558074 D01 DTS Meas. Guidance v04 9.1.2 PKPM1 Peak power meter method.

TEST RESULTS

No non-compliance noted

Test Data

Test mode: IEEE 802.11b mode

Channel	Frequency (MHz)	Peak Output Power (dBm)	Limit (dBm)
Low	2412	14.96	30.00
Mid	2437	15.19	30.00
High	2462	12.40	30.00

Channel	Frequency (MHz)	Average Output Power (dBm)	Limit (dBm)
Low	2412	11.80	30.00
Mid	2437	11.99	30.00
High	2462	12.40	30.00

Test mode: IEEE 802.11g mode

Channel	Frequency (MHz)	Peak Output Power (dBm)	Limit (dBm)
Low	2412	21.77	30.00
Mid	2437	22.37	30.00
High	2462	21.98	30.00

Channel	Frequency (MHz)	Average Output Power (dBm)	Limit (dBm)
Low	2412	11.73	30.00
Mid	2437	12.31	30.00
High	2462	11.38	30.00

Test mode: IEEE 802.11n HT20 mode

Channel	Frequency (MHz)	Peak Output Power (dBm)	Limit (dBm)
Low	2412	21.48	30.00
Mid	2437	21.73	30.00
High	2462	22.02	30.00

Channel	Frequency (MHz)	Average Output Power (dBm)	Limit (dBm)
Low	2412	11.30	30.00
Mid	2437	11.77	30.00
High	2462	12.13	30.00

7.3. PEAK POWER SPECTRAL DENSITY

LIMIT

1. According to §15.247(e), for digitally modulated systems, the power spectral density conducted from the intentional radiator to the antenna shall not be greater than 8 dBm in any 3 kHz band during any time interval of continuous transmission.
2. According to §15.247(f), the digital modulation operation of the hybrid system, with the frequency hopping turned off, shall comply with the power density requirements of paragraph (d) of this section.

Test Configuration

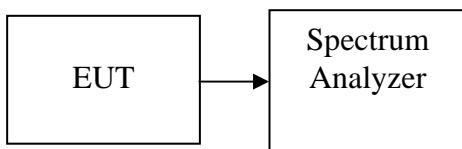

TEST PROCEDURE

1. Place the EUT on the table and set it in transmitting mode. Remove the antenna from the EUT and then connect a low loss RF cable from the antenna port to the spectrum analyzer.
2. Set the spectrum analyzer as RBW = 3 kHz, VBW = 10 kHz, Span = 1.5 times the DTS bandwidth, Sweep = auto
3. Record the max reading.
4. Repeat the above procedure until the measurements for all frequencies are completed.

TEST RESULTS

No non-compliance noted

Test Data

Test mode: IEEE 802.11b mode

Channel	Frequency (MHz)	PPSD (dBm)	Limit (dBm)	Result
Low	2412	-11.70	8.00	PASS
Mid	2437	-11.00	8.00	PASS
High	2462	-10.02	8.00	PASS

Test mode: IEEE 802.11g mode

Channel	Frequency (MHz)	PPSD (dBm)	Limit (dBm)	Result
Low	2412	-12.84	8.00	PASS
Mid	2437	-11.75	8.00	PASS
High	2462	-12.30	8.00	PASS

Test mode: IEEE 802.11n HT20 mode

Channel	Frequency (MHz)	PPSD (dBm)	Limit (dBm)	Result
Low	2412	-12.74	8.00	PASS
Mid	2437	-12.20	8.00	PASS
High	2462	-12.50	8.00	PASS

Test Plot

IEEE 802.11b mode

PPSD (CH Low)

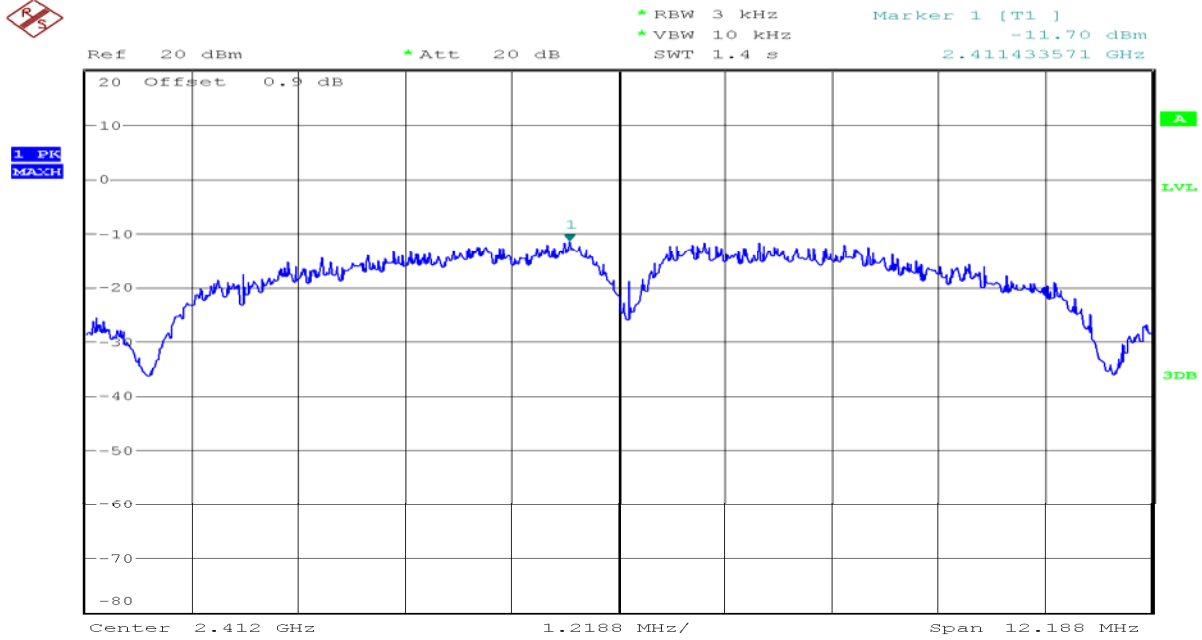

Date: 3.AUG.2017 21:29:55

PPSD(CH Mid)

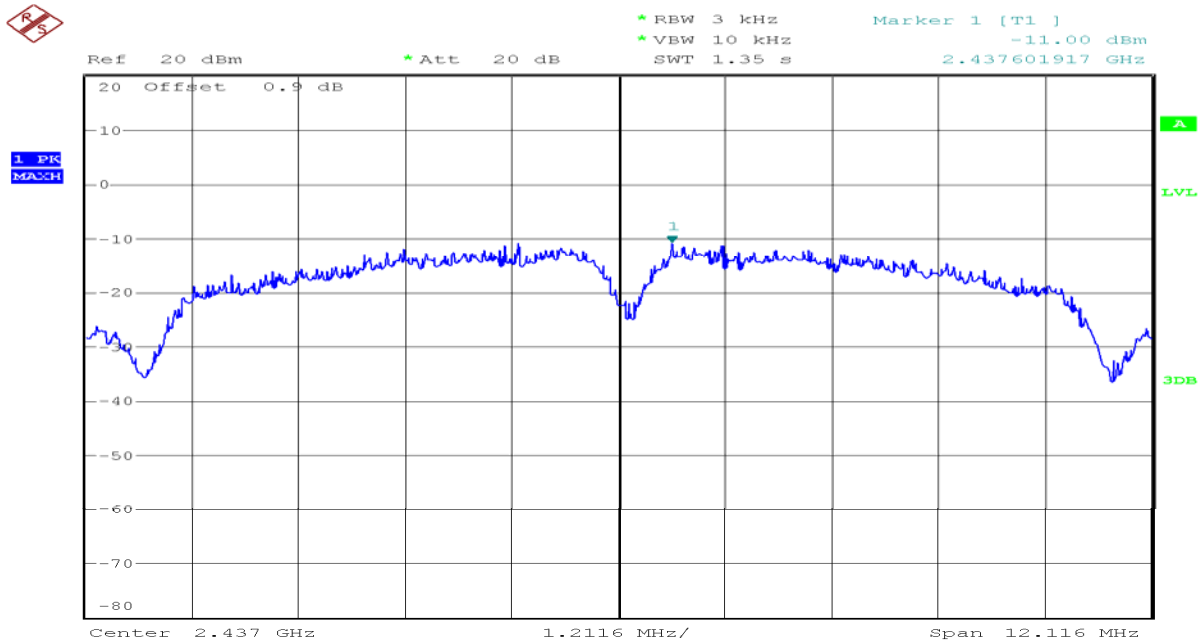

Date: 3.AUG.2017 21:32:24

PPSD (CH High)

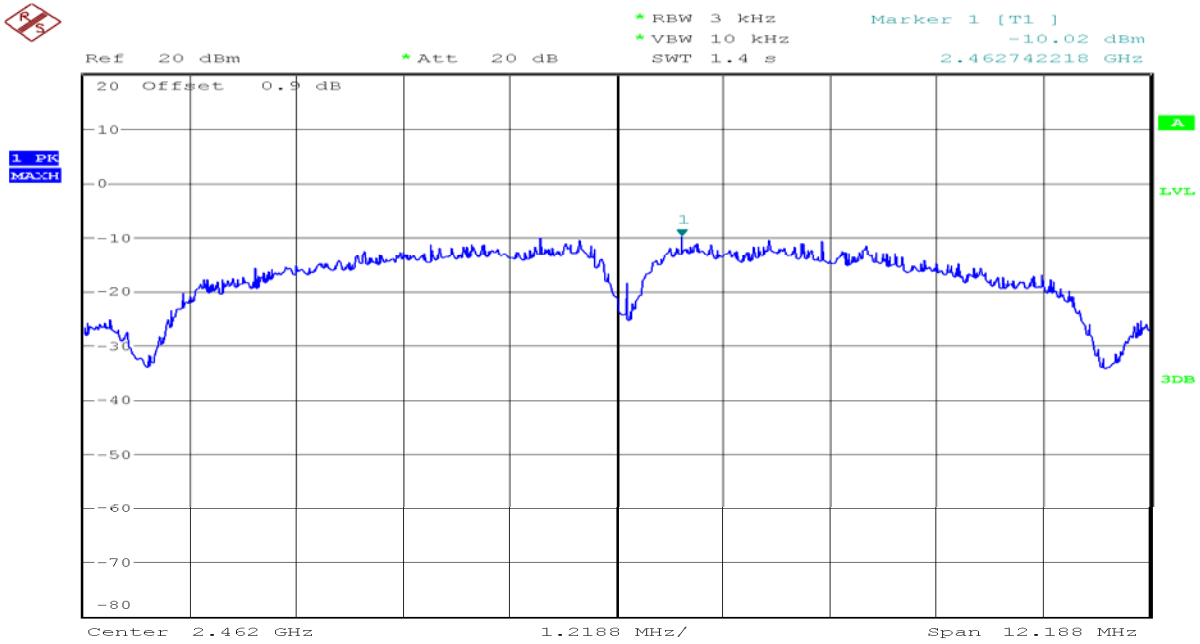

Date: 3.AUG.2017 21:31:06

IEEE 802.11g mode

PPSD (CH Low)

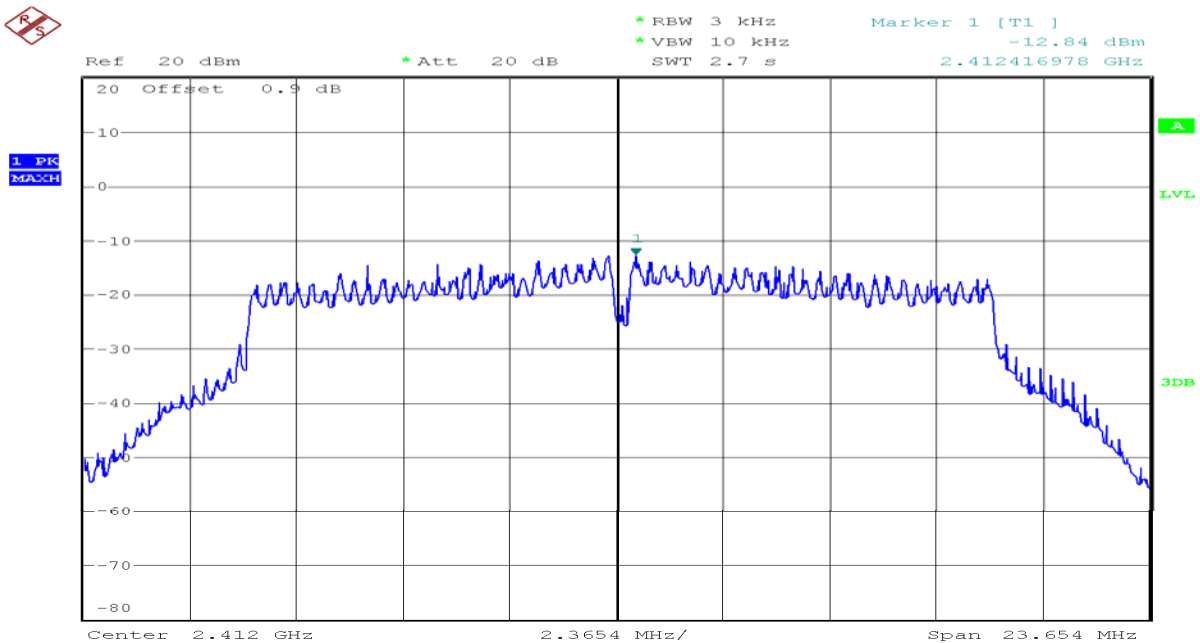

Date: 3.AUG.2017 21:28:14

PPSD (CH Mid)

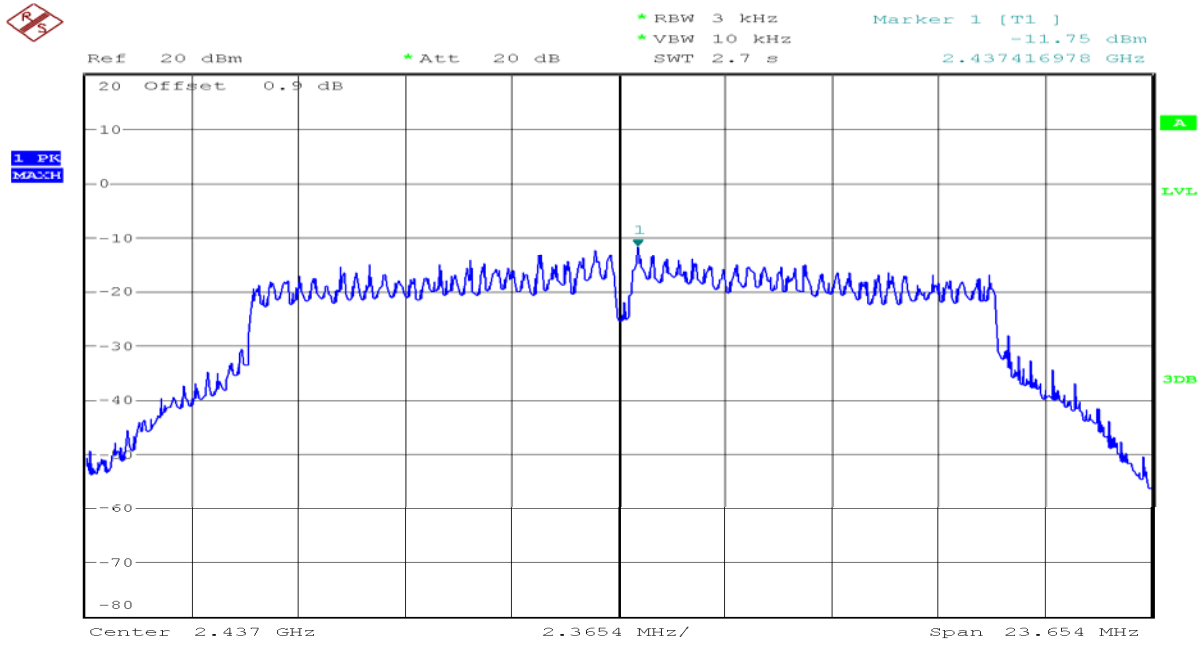

Date: 3.AUG.2017 21:26:47

PPSD (CH High)

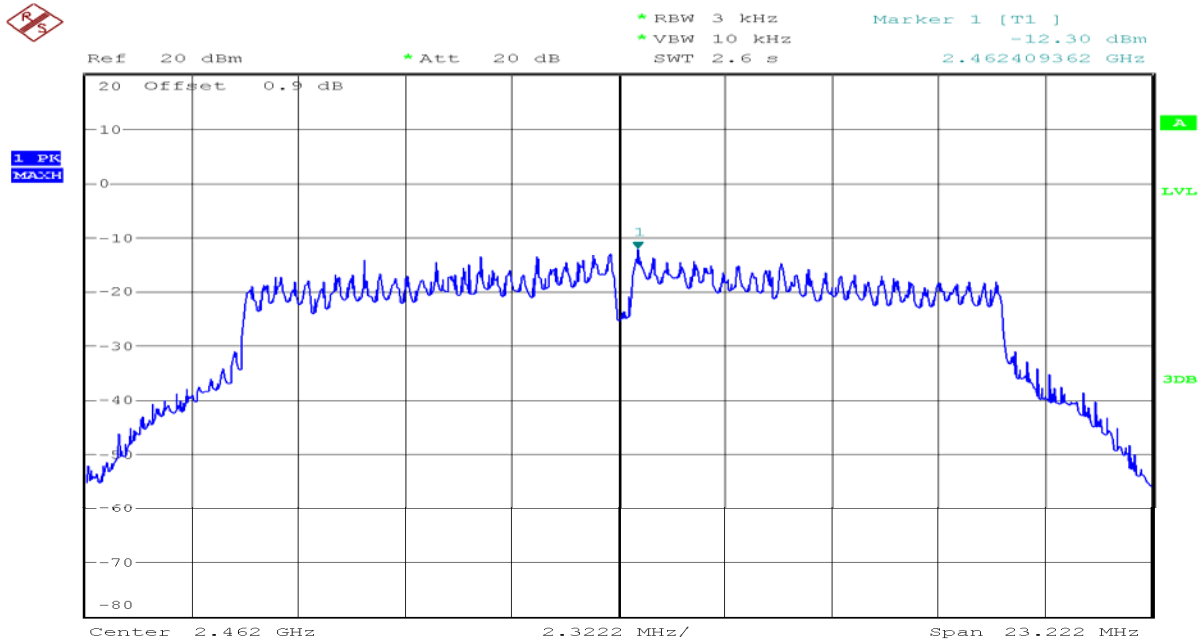

Date: 3.AUG.2017 21:25:27

IEEE 802.11n HT20 mode

PPSD (CH Low)

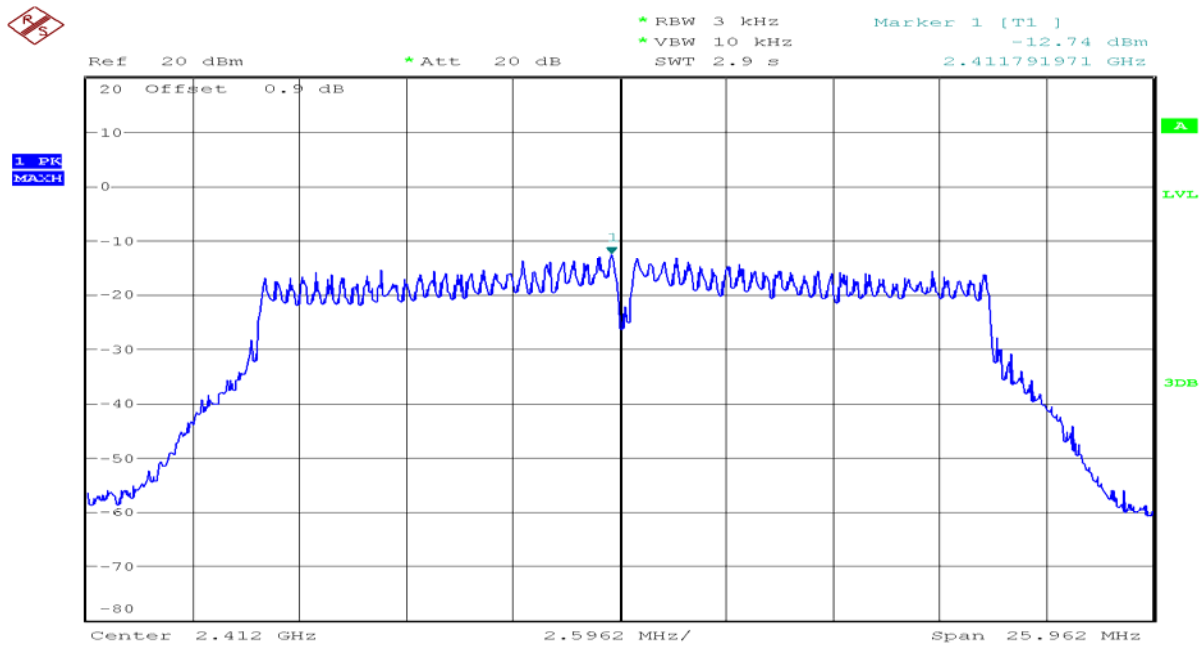

Date: 3.AUG.2017 21:20:59

PPSD (CH Mid)

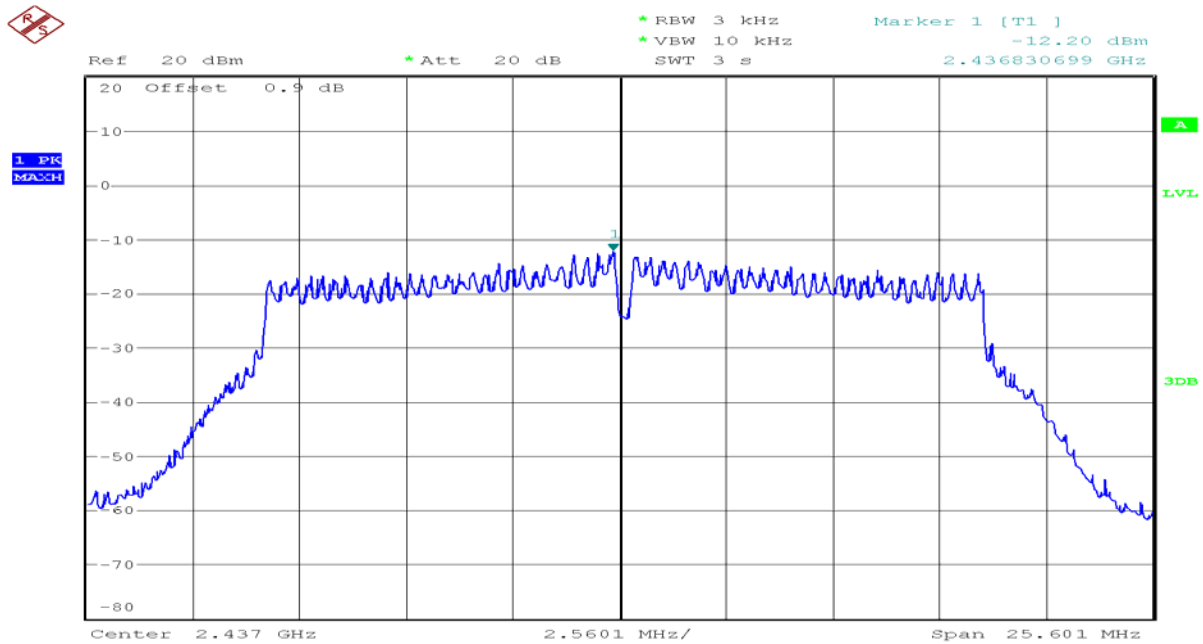

Date: 3.AUG.2017 21:23:17

PPSD (CH High)

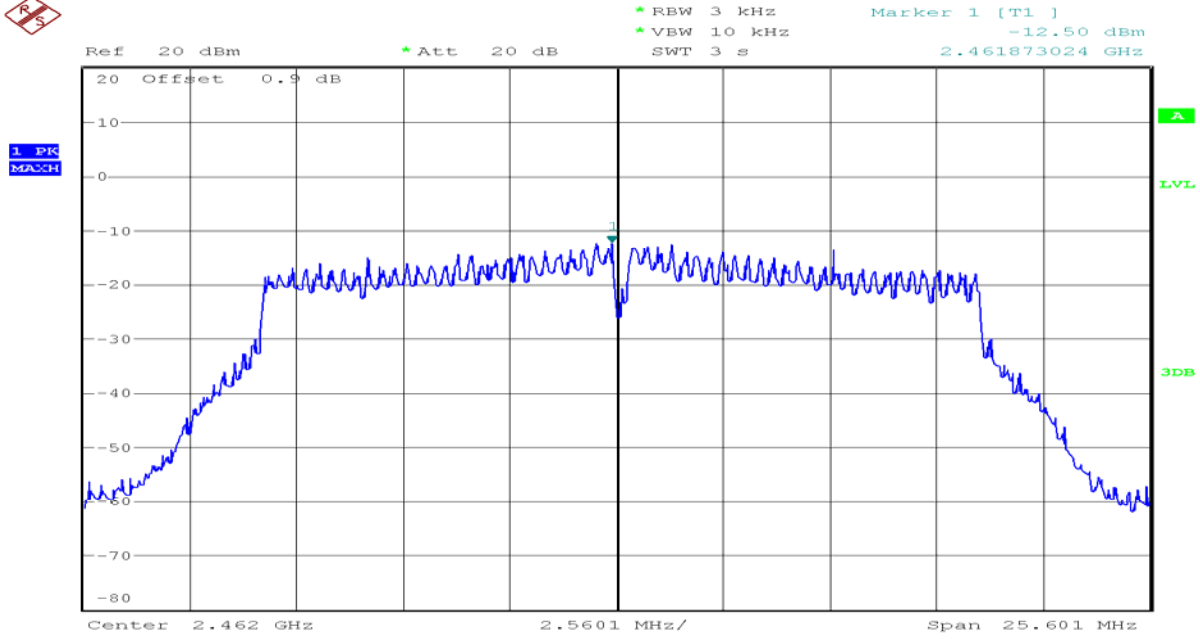

Date: 3.AUG.2017 21:24:15

7.4.SPURIOUS EMISSIONS

Conducted Measurement

LIMIT

According to §15.247(d), in any 100 kHz bandwidth outside the frequency bands in which the spread spectrum intentional radiator is operating, the radio frequency power that is produced by the intentional radiator shall be at least 20 dB below that in the 100 kHz bandwidth within the band that contains the highest level of the desired power, based on either an RF conducted or a radiated measurement, provided the transmitter demonstrates compliance with the peak conducted power limits. In addition, radiated emissions which fall in the restricted bands, as defined in §15.205(a), must also comply with the radiated emission limits specified in 15.209(a) (see Section 15.205(c)).

Test Configuration

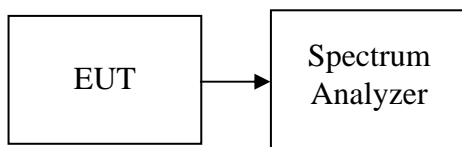

TEST PROCEDURE

Conducted RF measurements of the transmitter output were made to confirm that the EUT antenna port conducted emissions meet the specified limit and to identify any spurious signals that require further investigation or measurements on the radiated emissions site.

The transmitter output is connected to the spectrum analyzer. The resolution bandwidth is set to 100 kHz. The video bandwidth is set to 300 kHz.

Measurements are made over the 30MHz to 40GHz range with the transmitter set to the lowest, middle, and highest channels.

TEST RESULTS

No non-compliance noted

Test Plot

OUT-OF-BAND SPURIOUS EMISSIONS-CONDUCTED MEASUREMENT

IEEE 802.11b mode

CH Low

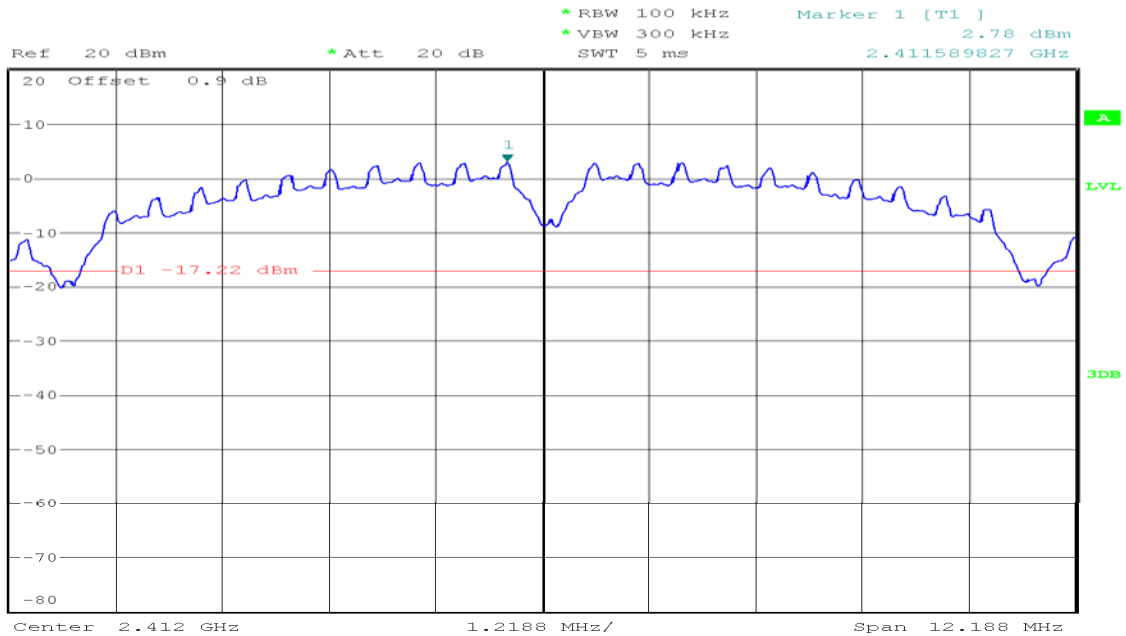

Date: 3.AUG.2017 21:51:56

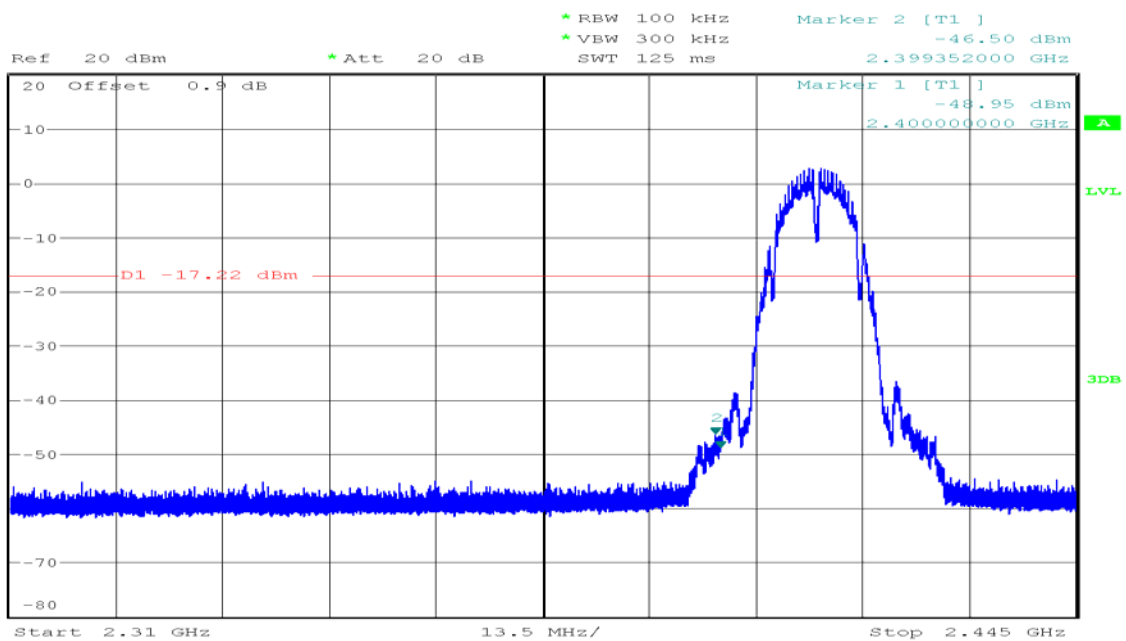

Date: 3.AUG.2017 21:53:49

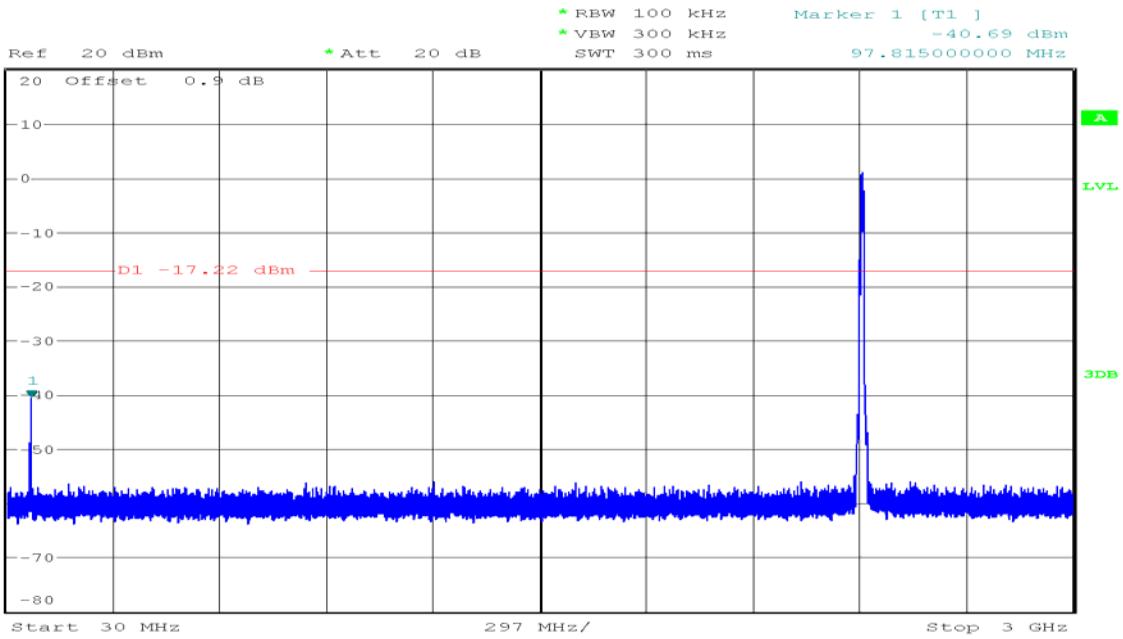

Date: 3.AUG.2017 21:55:19

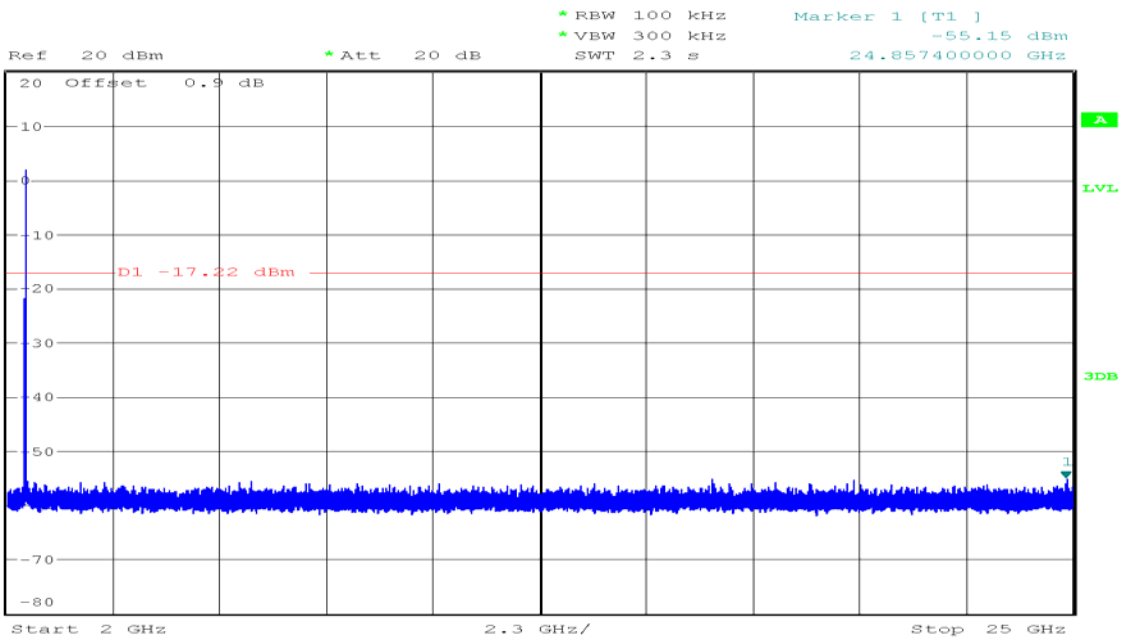

Date: 3.AUG.2017 21:56:33

CH Mid

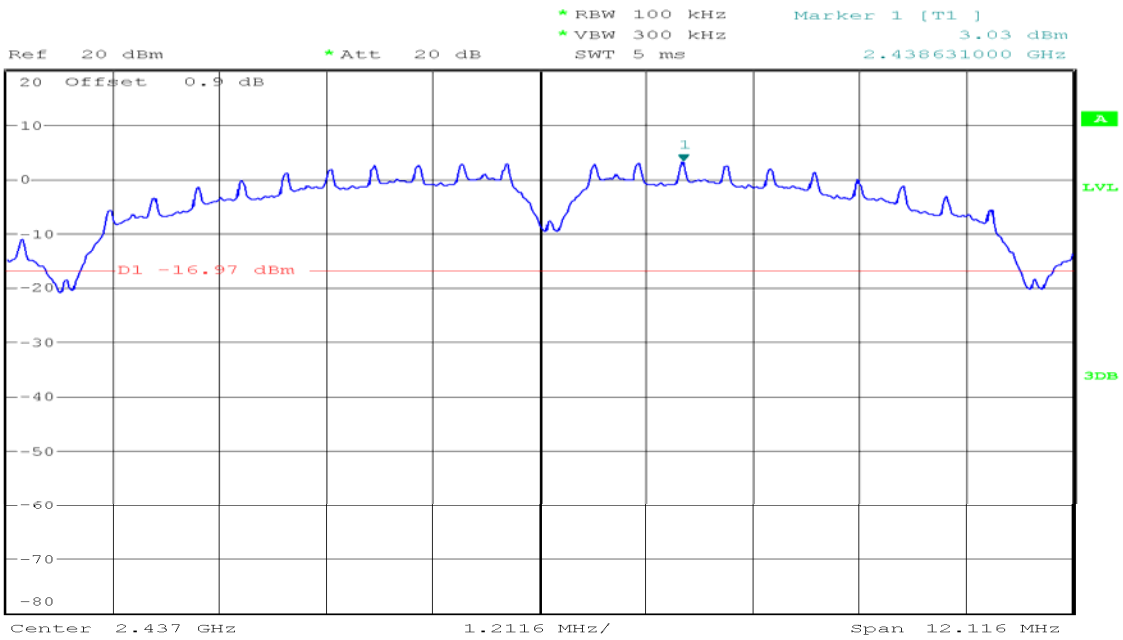

Date: 3.AUG.2017 21:35:52

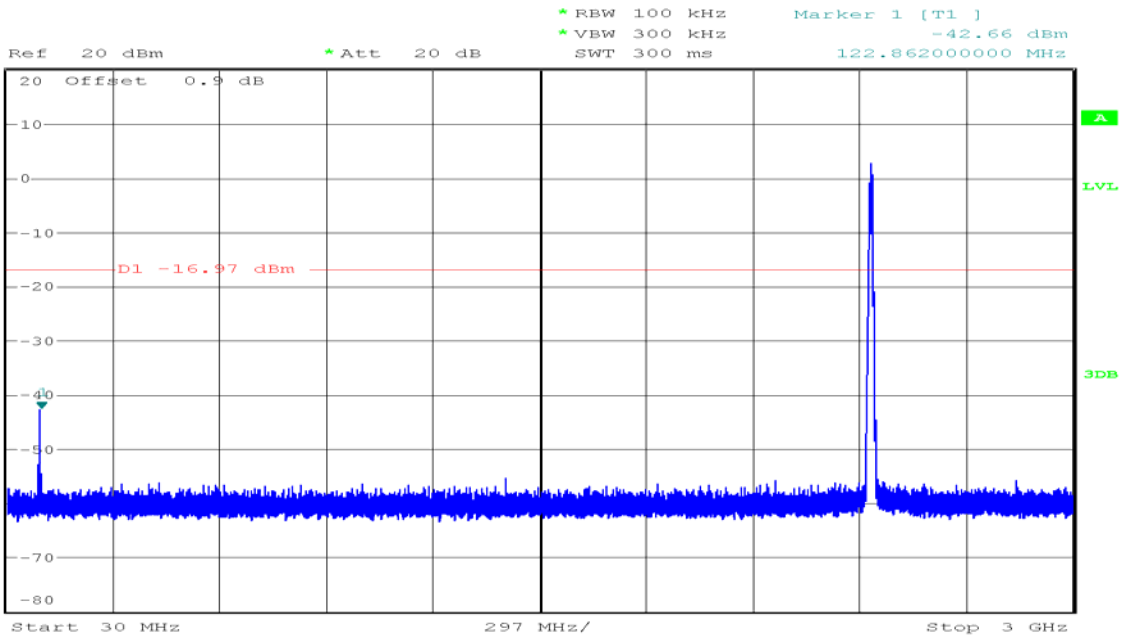

Date: 3.AUG.2017 21:37:16

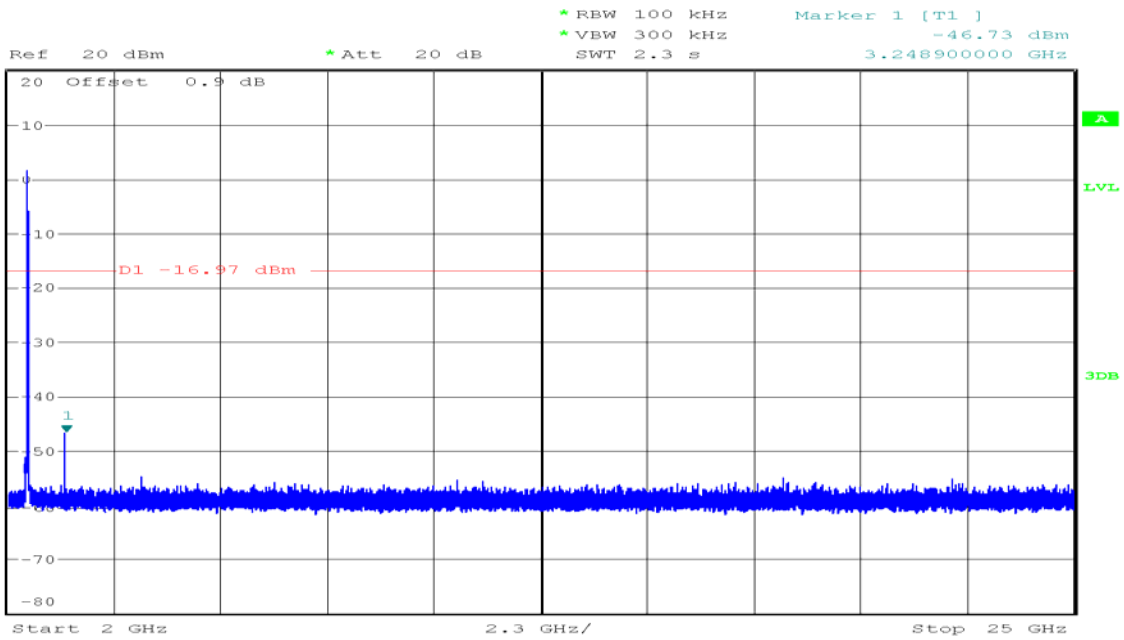

Date: 11.AUG.2017 17:59:46

CH High

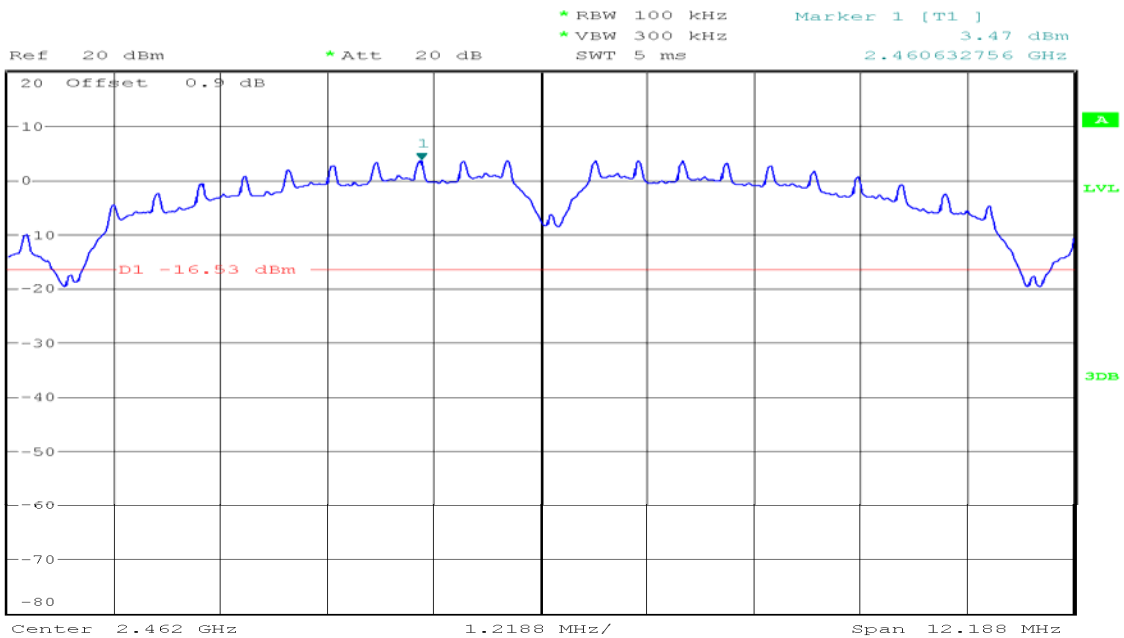

Date: 3.AUG.2017 21:44:02

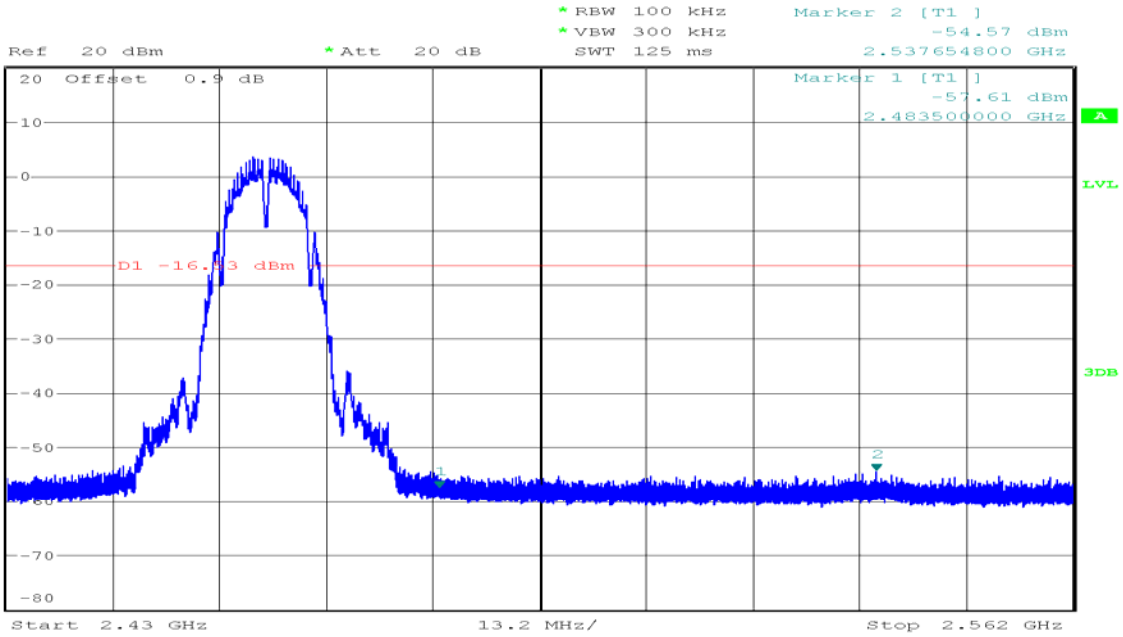

Date: 3.AUG.2017 21:46:52

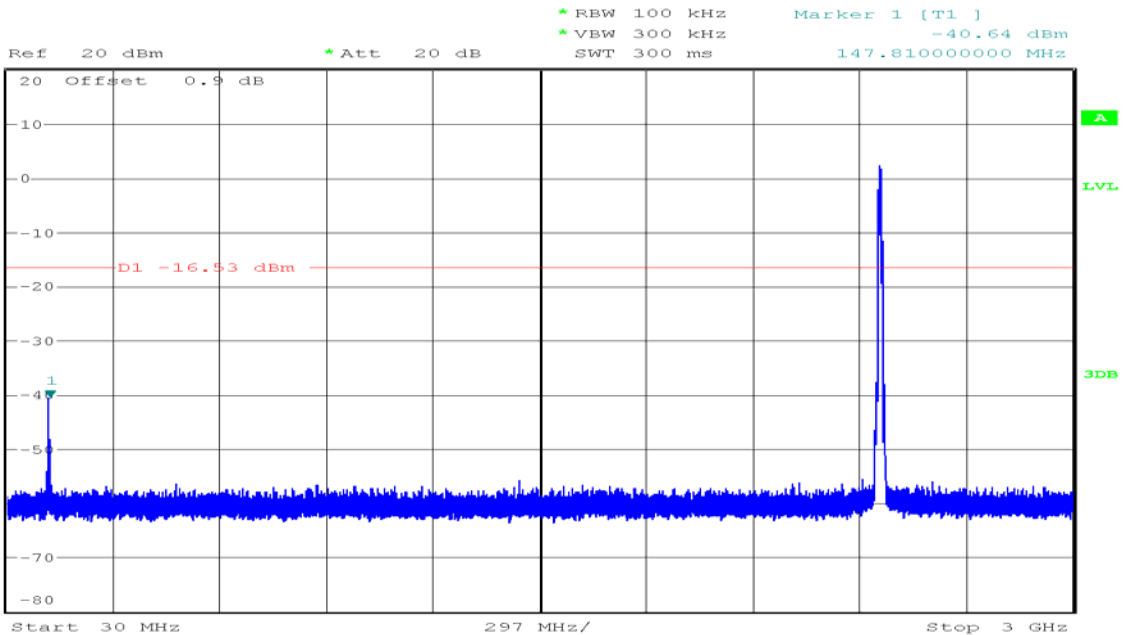

Date: 3.AUG.2017 21:47:46

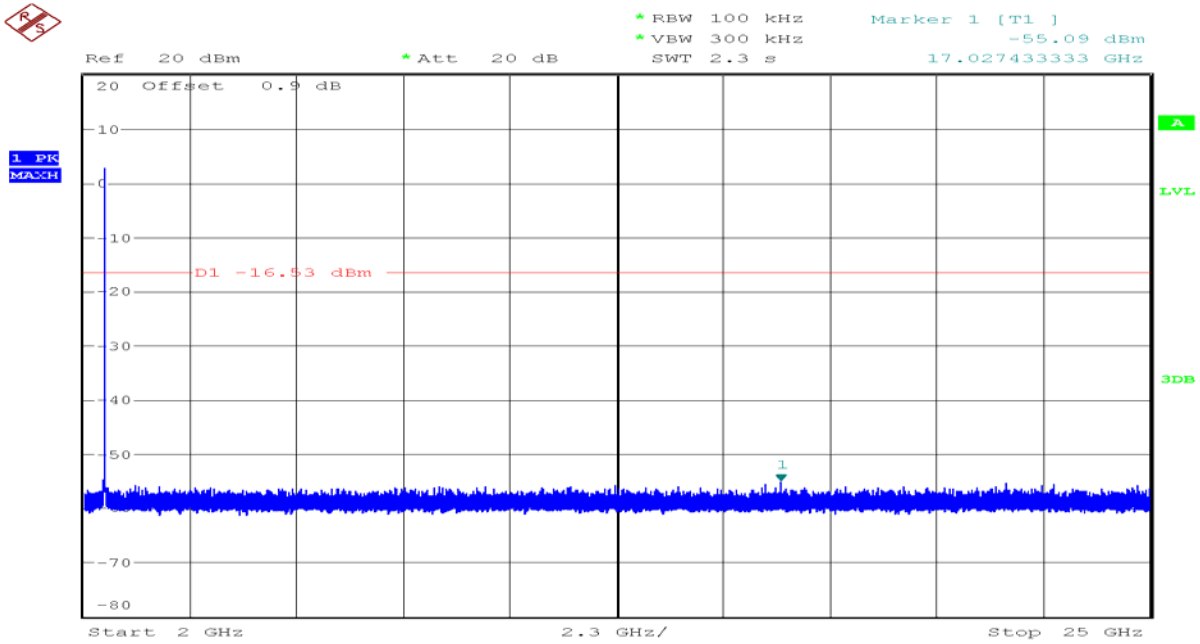

Date: 3.AUG.2017 21:49:18

IEEE 802.11g mode

CH Low

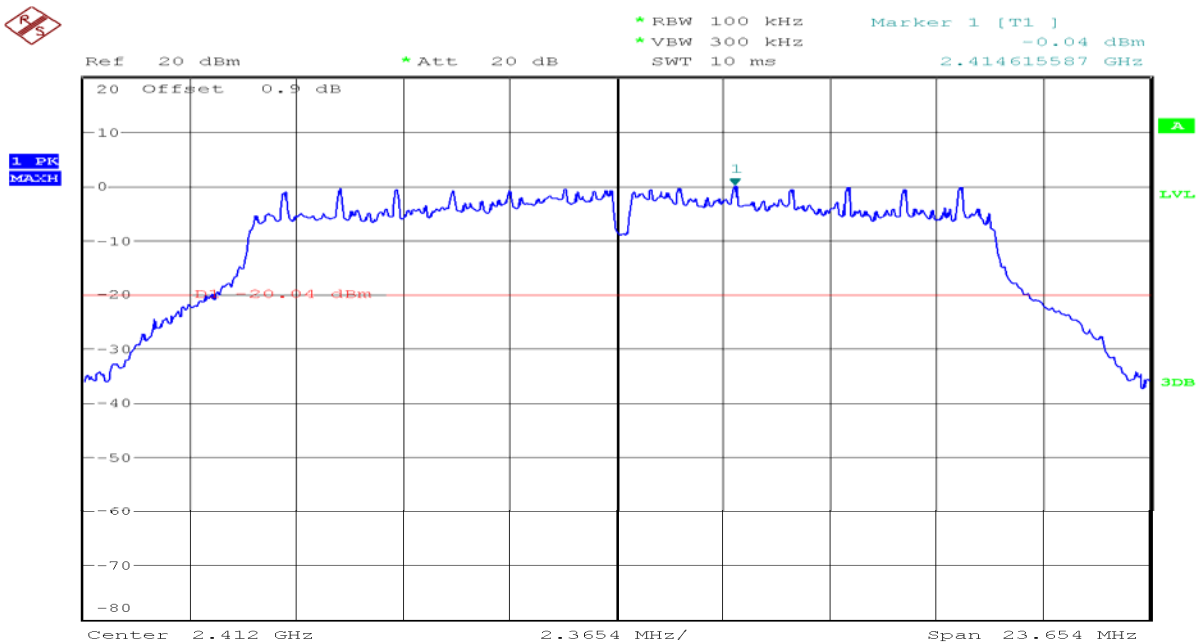

Date: 3.AUG.2017 21:58:38

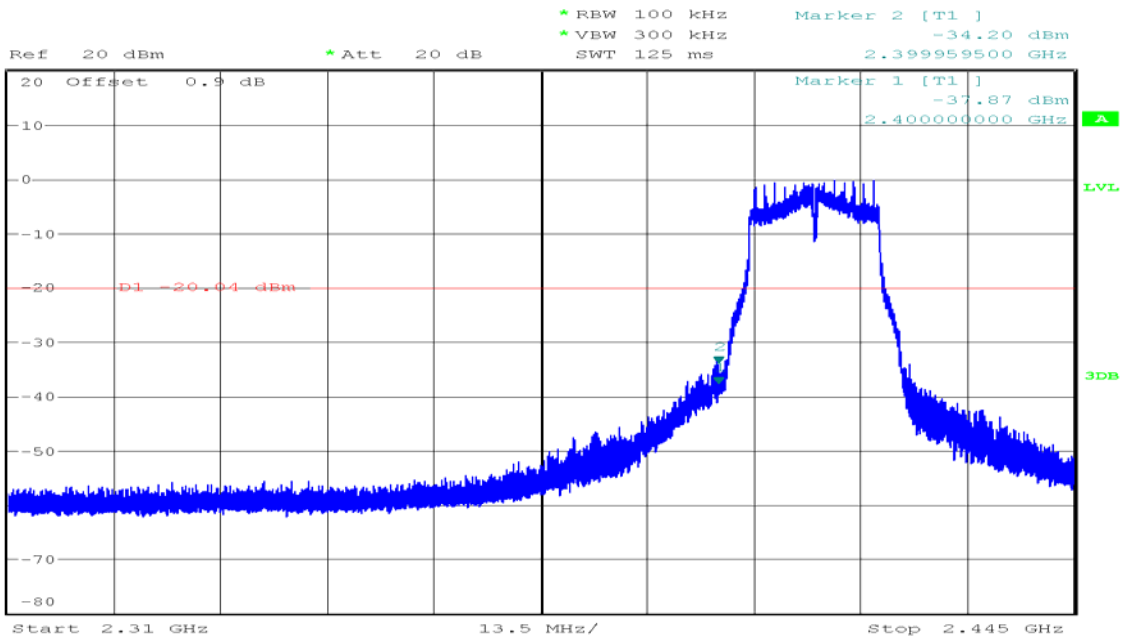

Date: 3.AUG.2017 21:59:46

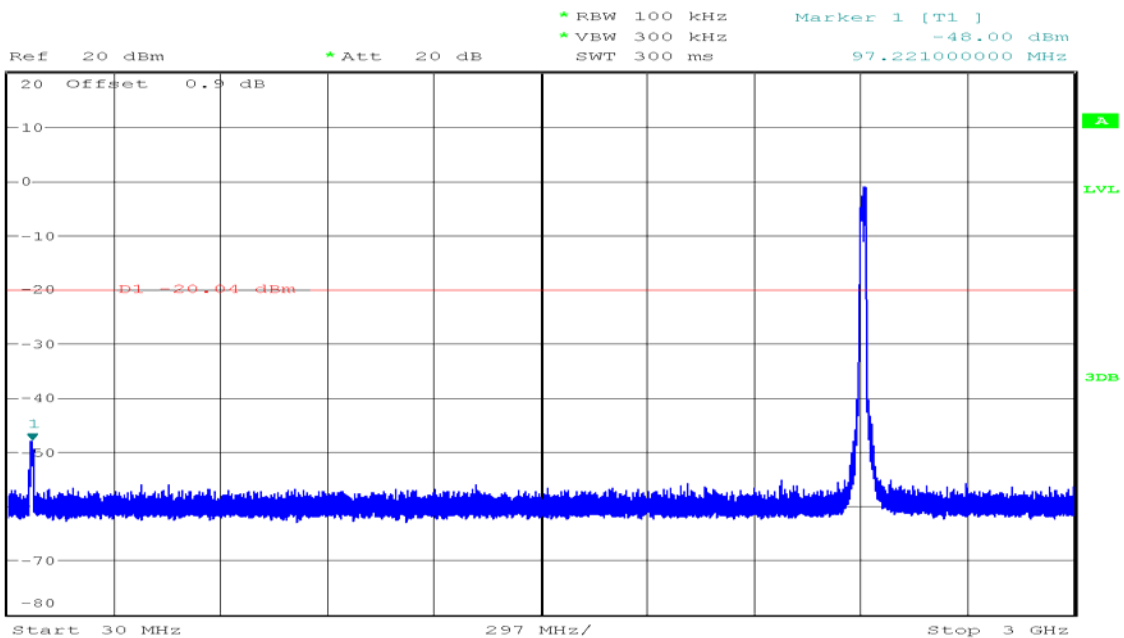

Date: 3.AUG.2017 22:01:08

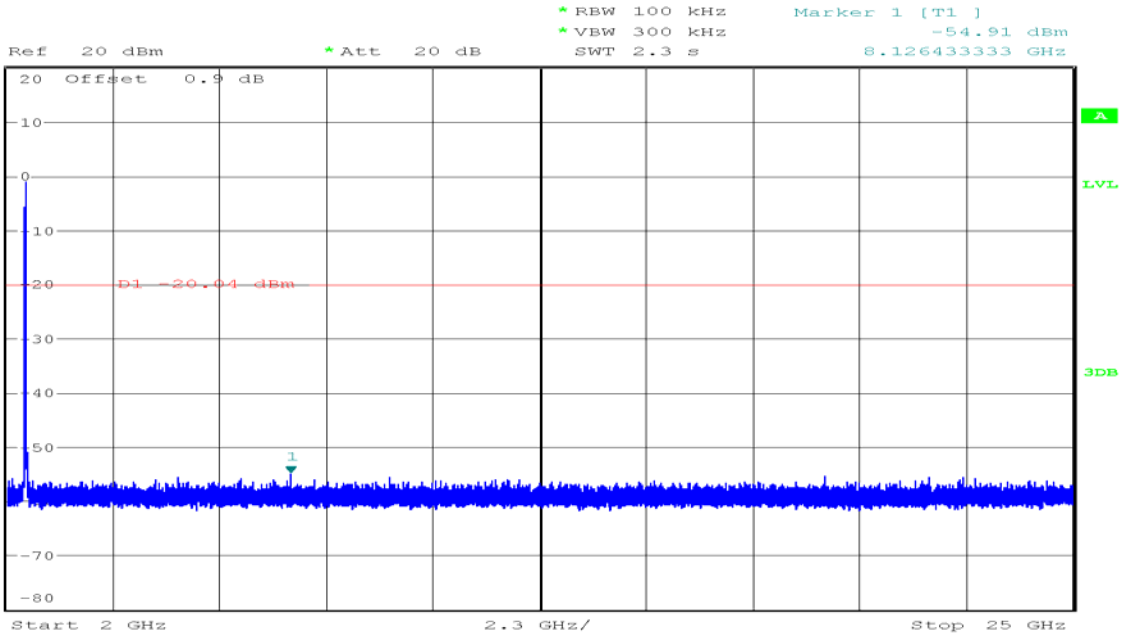

Date: 3.AUG.2017 22:02:07

CH Mid

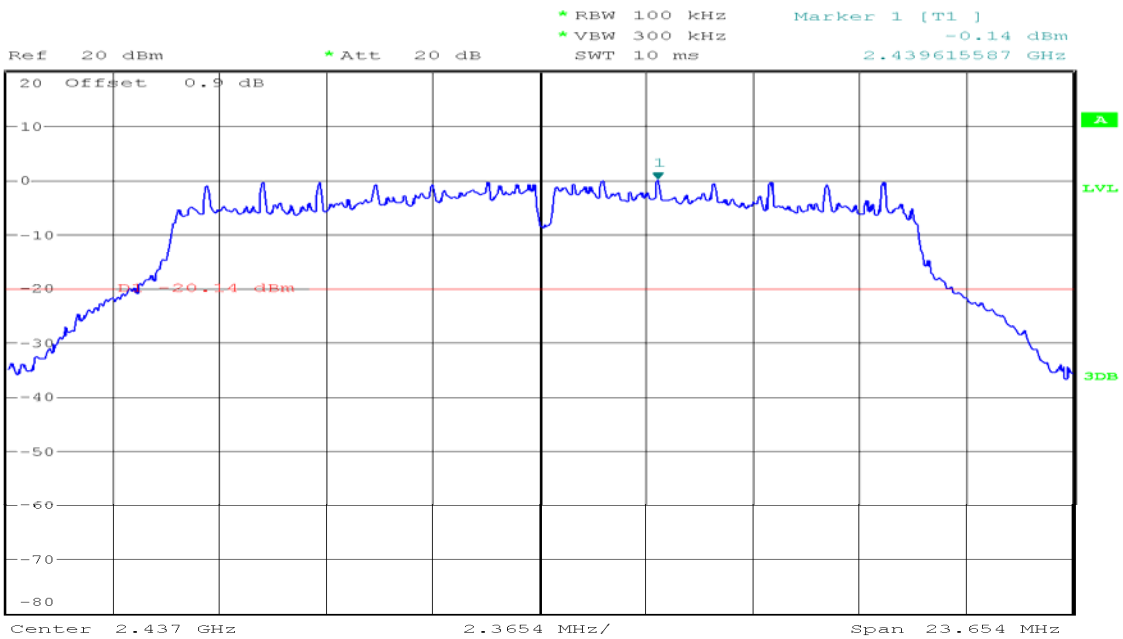

Date: 3.AUG.2017 22:04:56

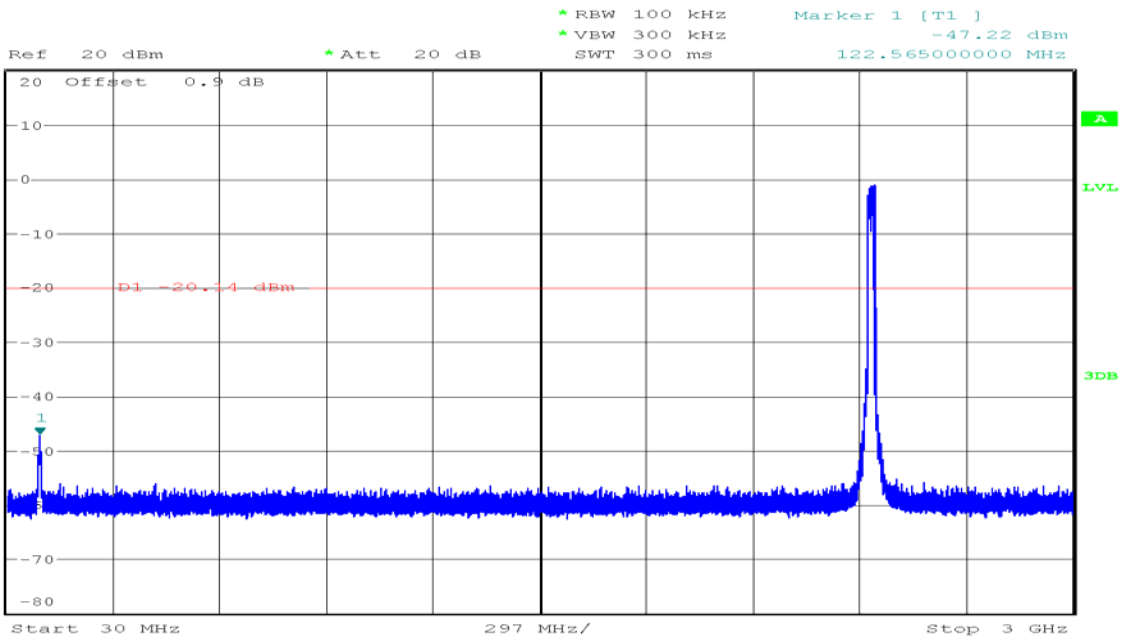

Date: 3.AUG.2017 22:06:53

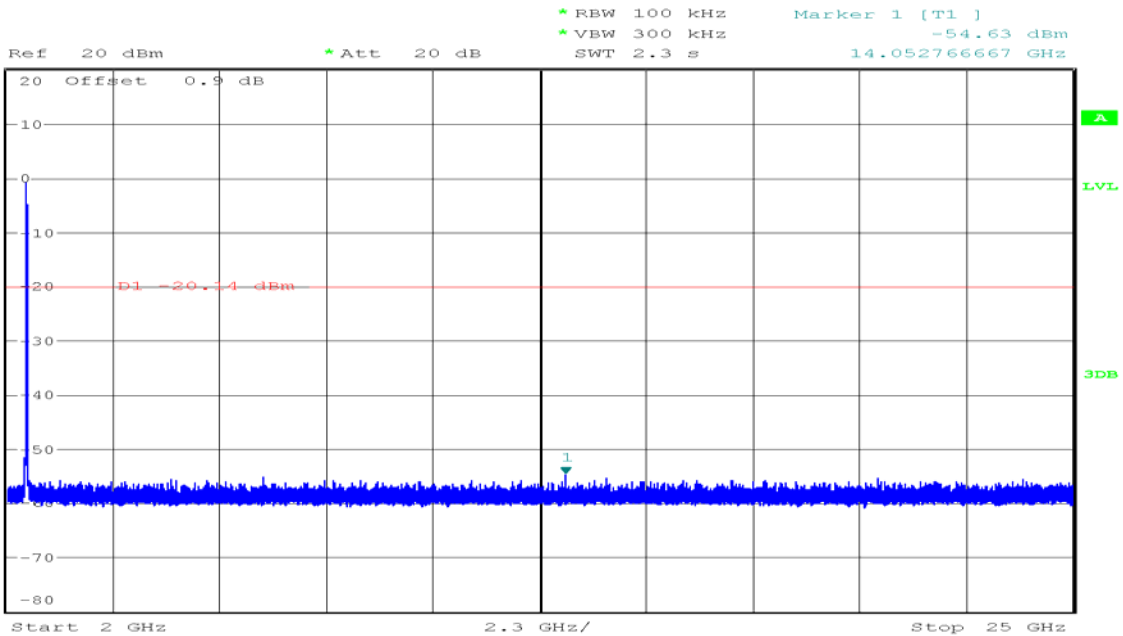

Date: 3.AUG.2017 22:09:01

CH High

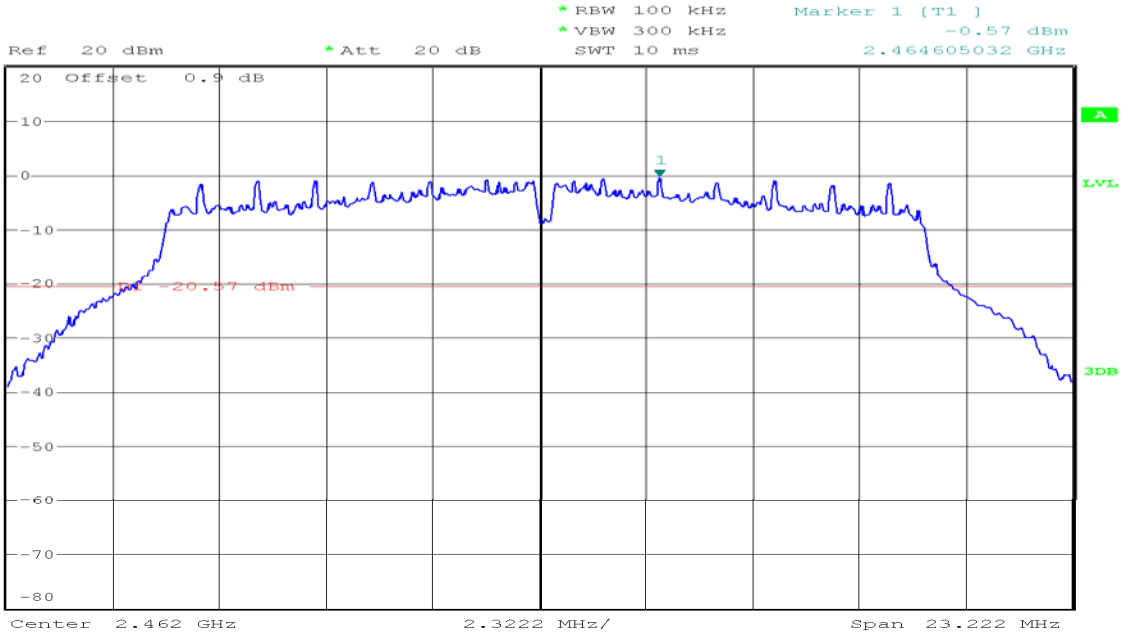

Date: 3.AUG.2017 22:10:45

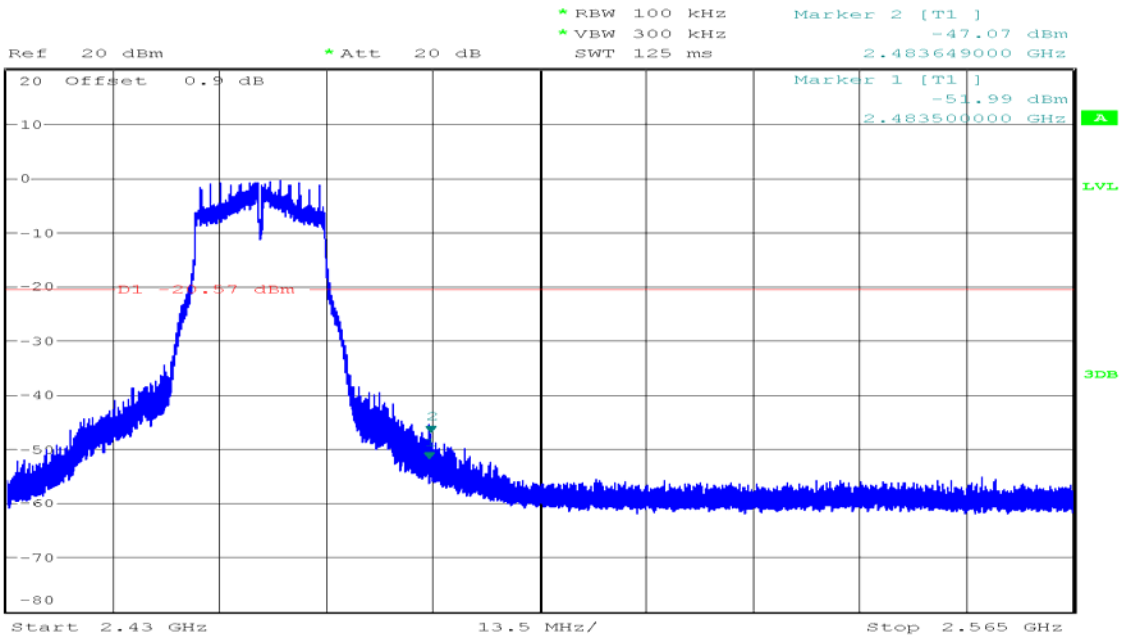

Date: 3.AUG.2017 22:12:16

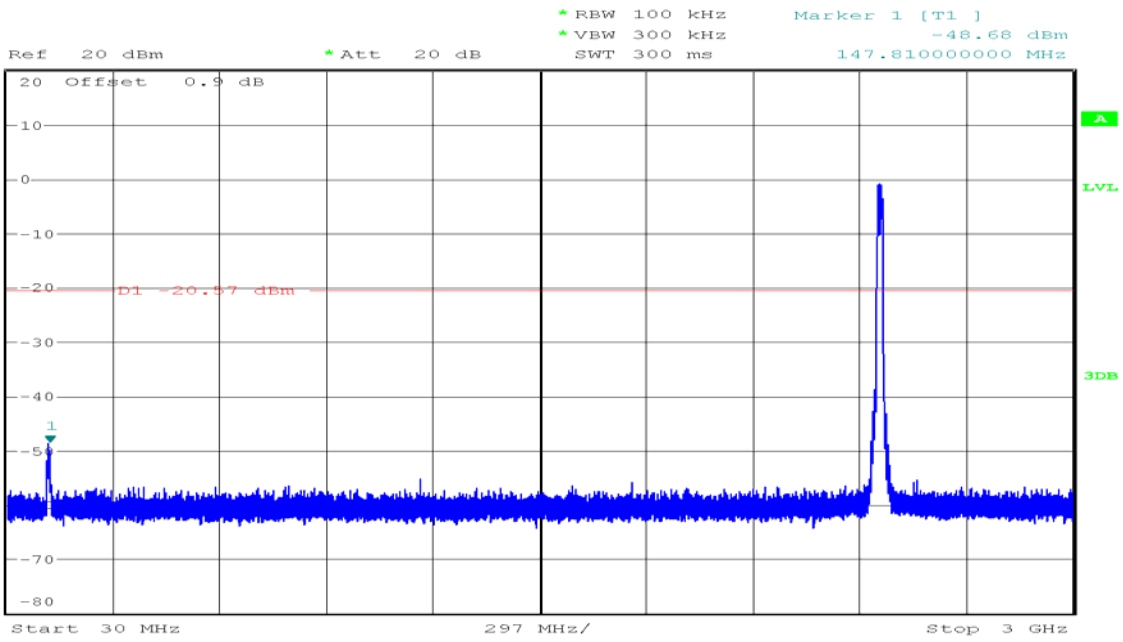

Date: 3.AUG.2017 22:13:13

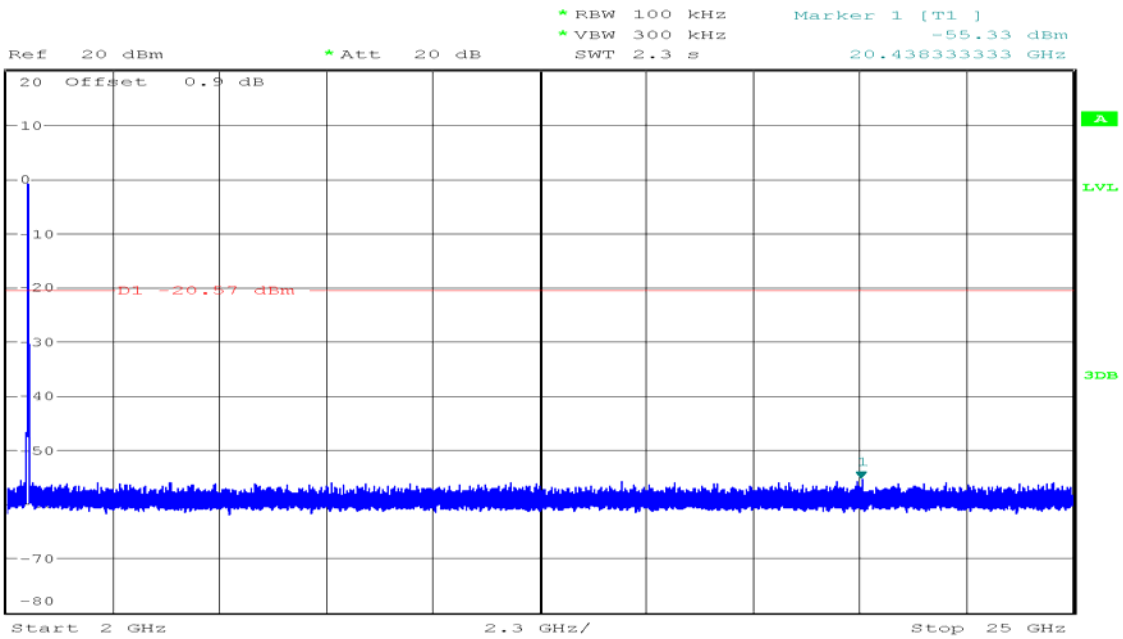

Date: 3.AUG.2017 22:14:15

IEEE 802.11n HT20 mode

CH Low

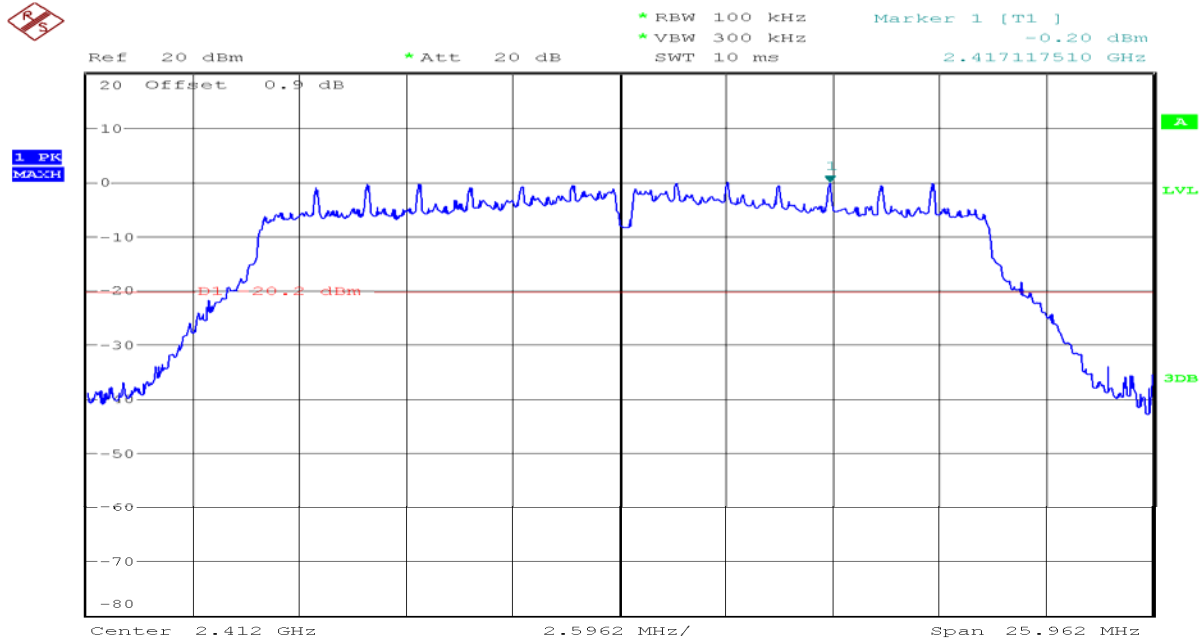

Date: 3.AUG.2017 22:30:55

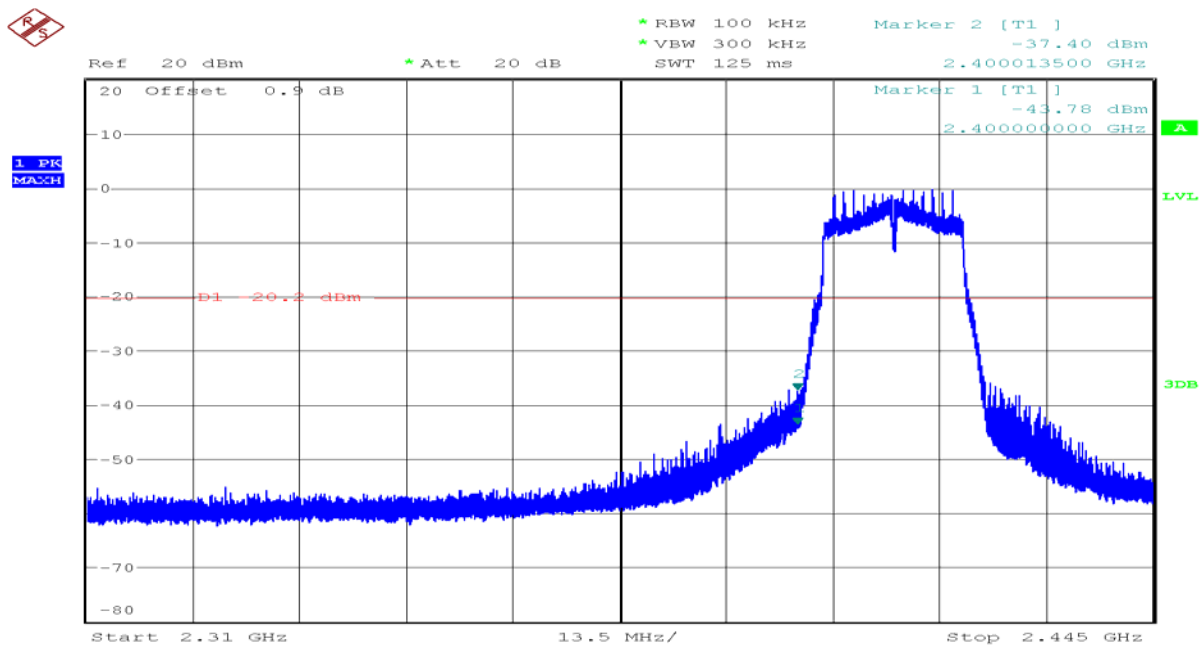

Date: 3.AUG.2017 22:32:32

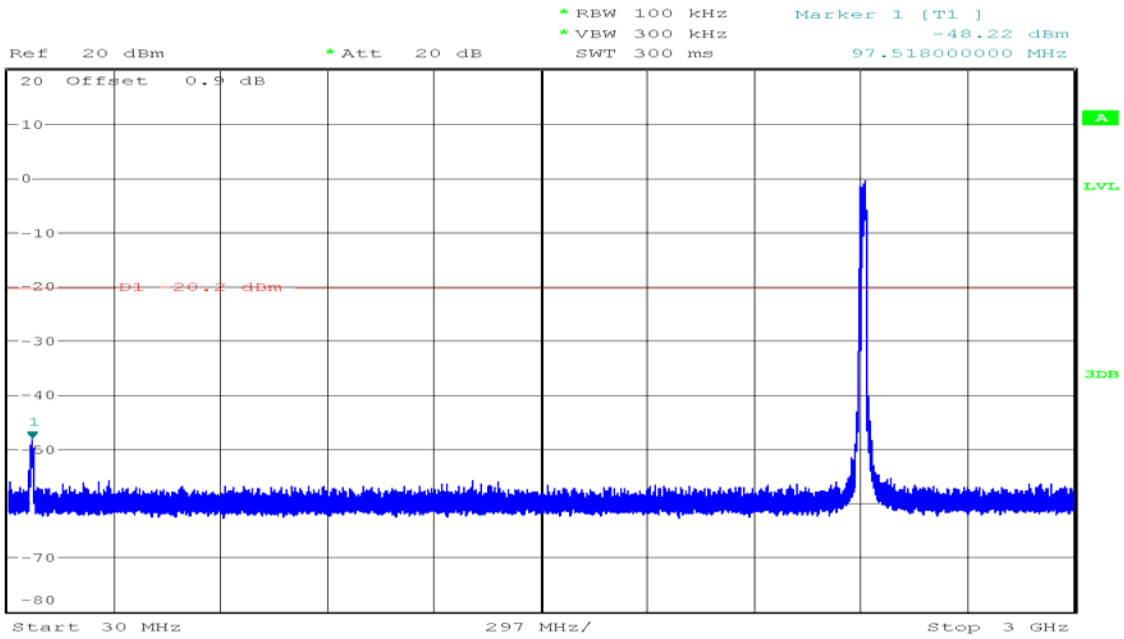

Date: 3.AUG.2017 22:34:01

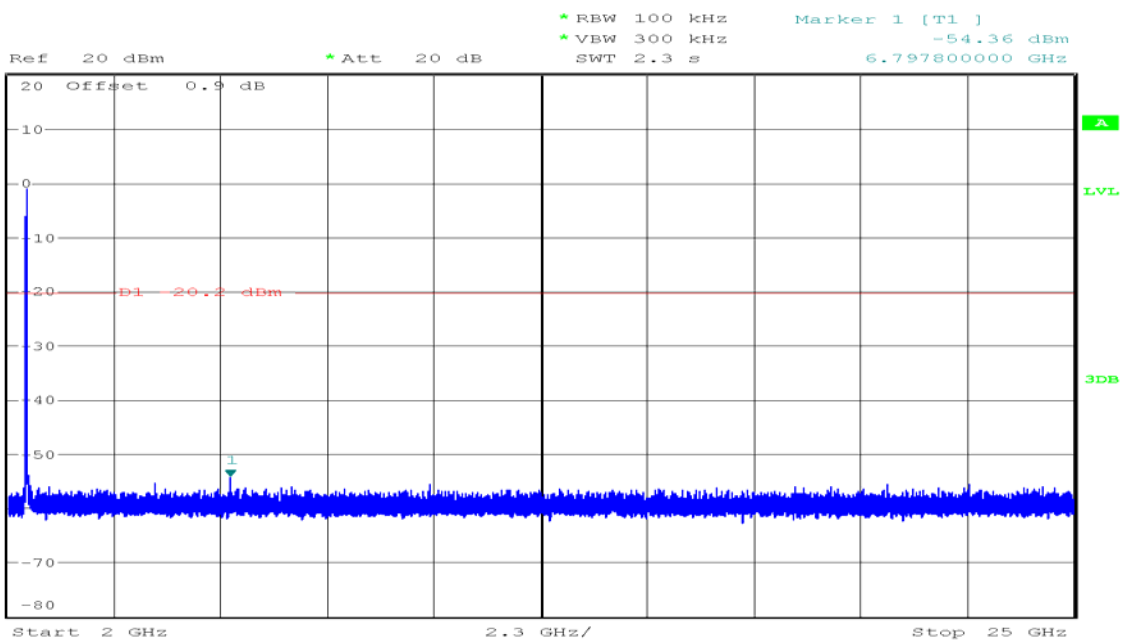

Date: 3.AUG.2017 22:34:48

CH Mid

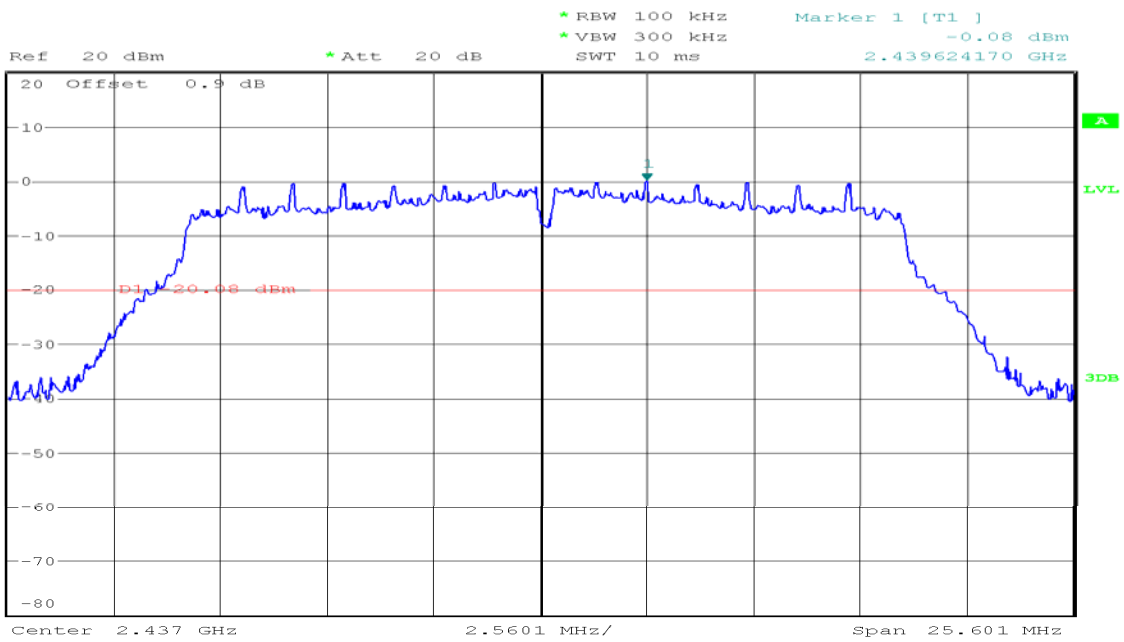

Date: 3.AUG.2017 22:25:11

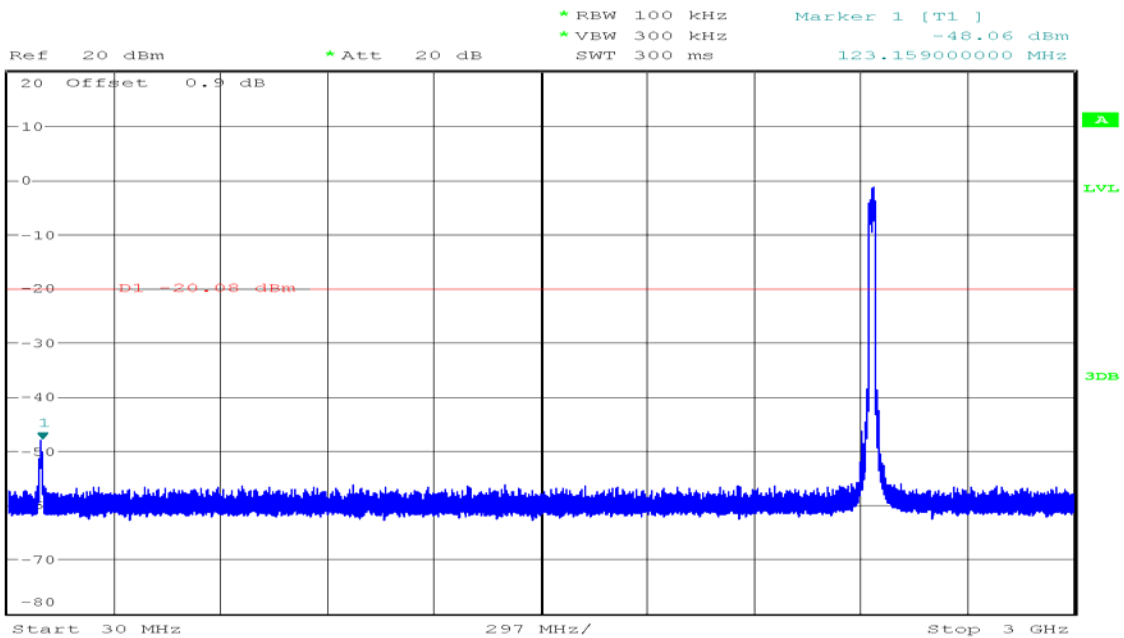

Date: 3.AUG.2017 22:27:01

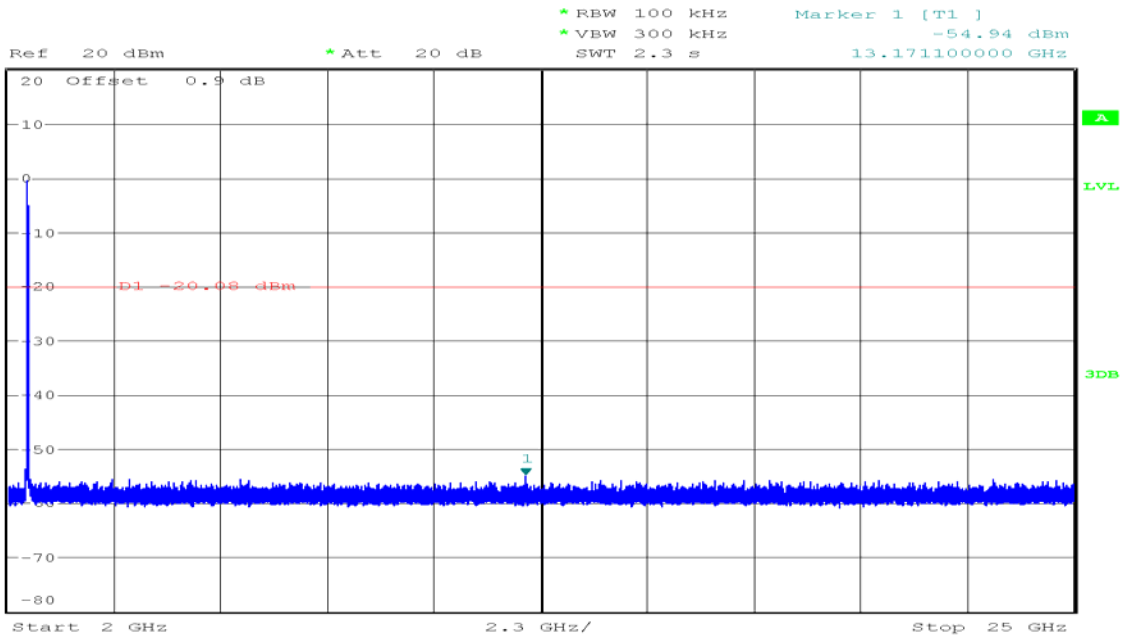

Date: 3.AUG.2017 22:29:13

CH High

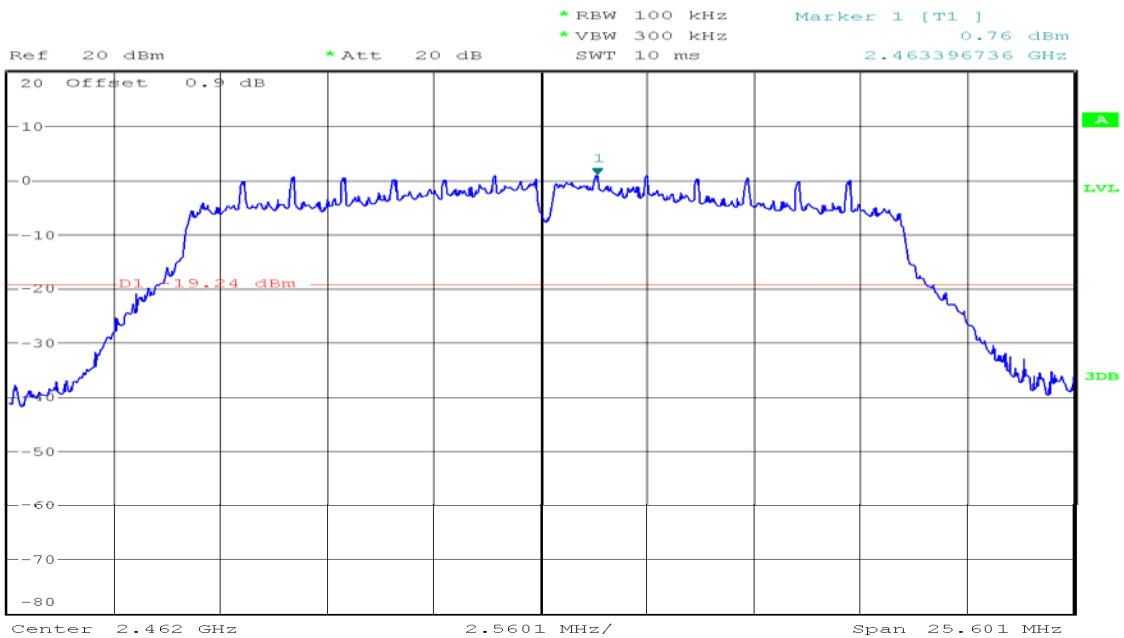

Date: 3.AUG.2017 22:16:55

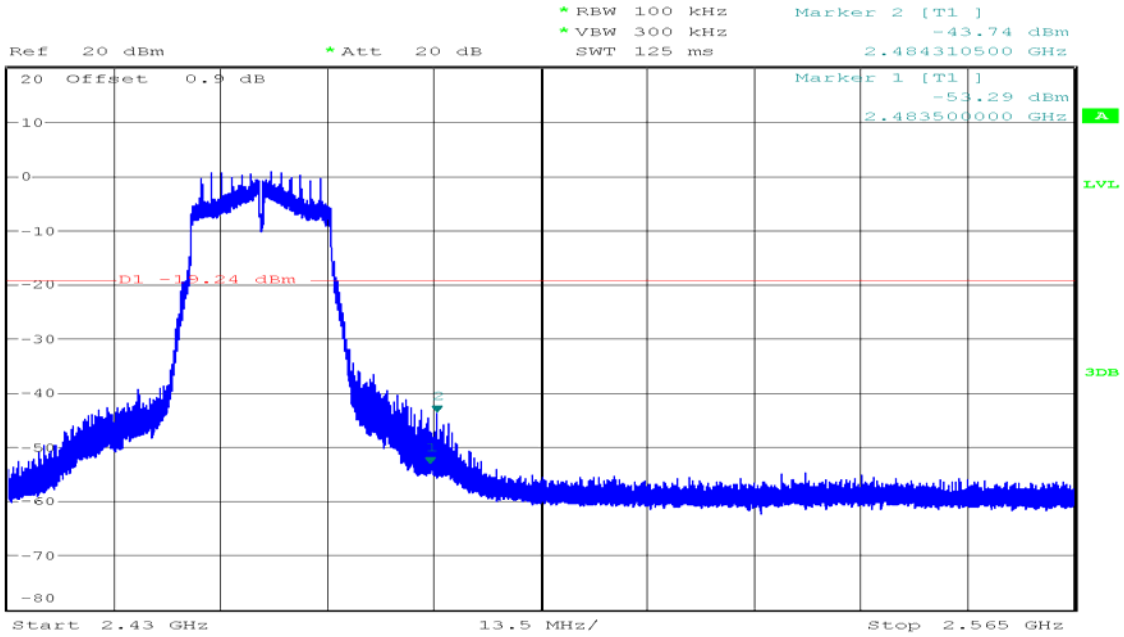

Date: 3.AUG.2017 22:18:20

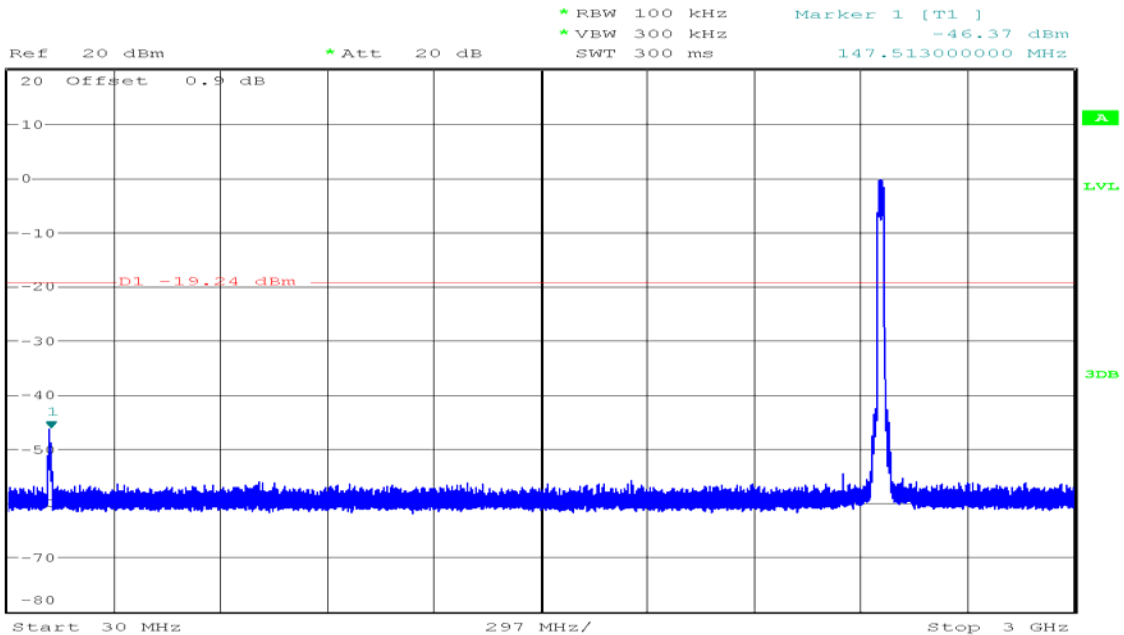

Date: 3.AUG.2017 22:21:17



* RBW 100 kHz Marker 1 [T1]
* VBW 300 kHz -54.58 dBm
SWT 2.3 s 6.565500000 GHz

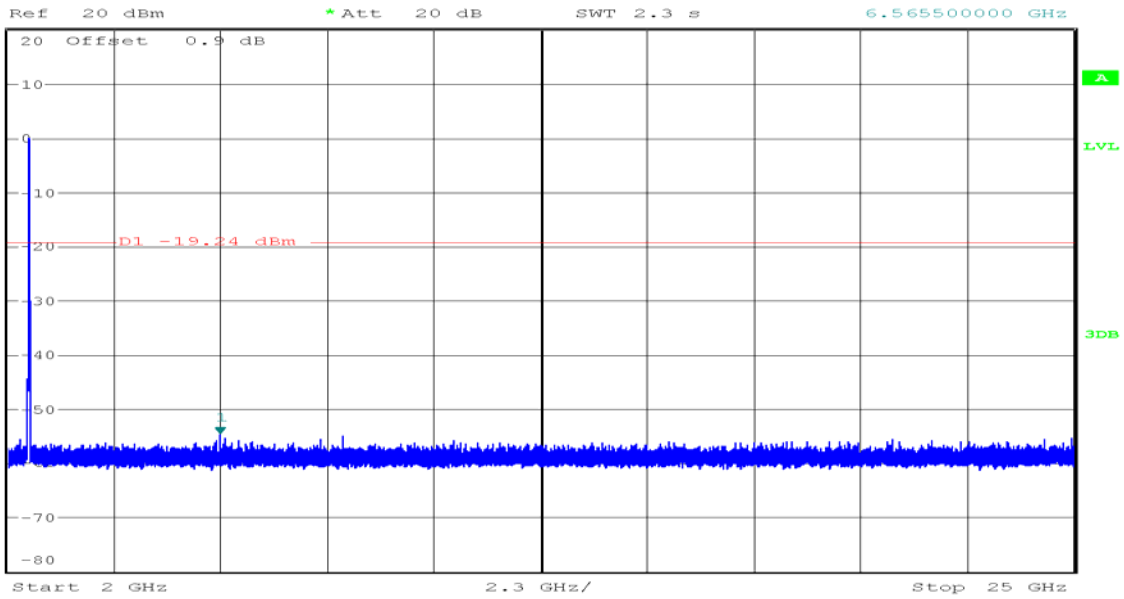

Date: 3.AUG.2017 22:22:40

7.5.RADIATED EMISSIONS

LIMIT

Radiated emissions from 9 kHz to 25 GHz were measured according to the methods defines in ANSI C63.10-2013. The EUT was placed above the ground plane, 0.8 meter for frequency below 1GHz and 1.5 meter for frequency above 1GHz. The interface cables and equipment positions were varied within limits of reasonable applications to determine the positions producing maximum radiated emissions

1. According to §15.209(a), except as provided elsewhere in this Subpart, the emissions from an intentional radiator shall not exceed the field strength levels specified in the following table:

FREQUENCIES(MHz)	FIELD STRENGTH (microvolts/meter)	MEASUREMENT DISTANCE(meters)
0.009~0.490	2400/F(kHz)	300
0.490~1.705	24000/F(kHz)	30
1.705~30.0	30	30
30~88	100	3
88~216	150	3
216~960	200	3
Above 960	500	3

Remark: Except as provided in paragraph (g), fundamental emissions from intentional radiators operating under this Section shall not be located in the frequency bands 54-72 MHz, 76-88 MHz, 174-216 MHz or 470-806 MHz. However, operation within these frequency bands is permitted under other sections of this Part, e.g., Sections 15.231 and 15.241.

2.In the emission table above, the tighter limit applies at the band edges.

Frequency (MHz)	Field Strength (μ V/m at 3-meter)	Field Strength (dB μ V/m at 3-meter)
30-88	100	40
88-216	150	43.5
216-960	200	46
Above 960	500	54

Test Configuration

Below 30MHz

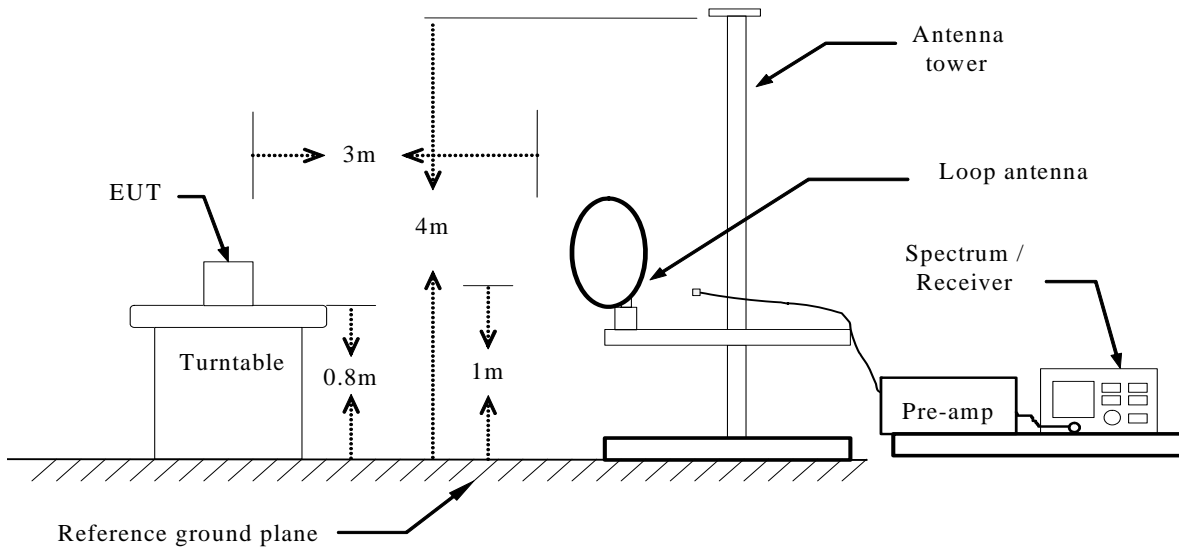

Below 1 GHz

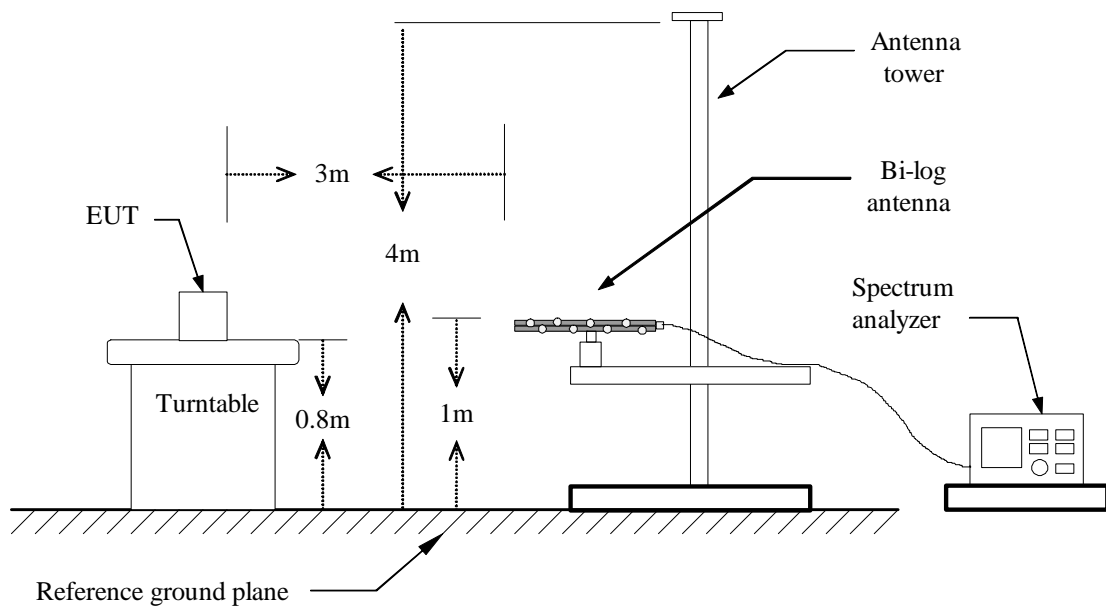

Above 1 GHz

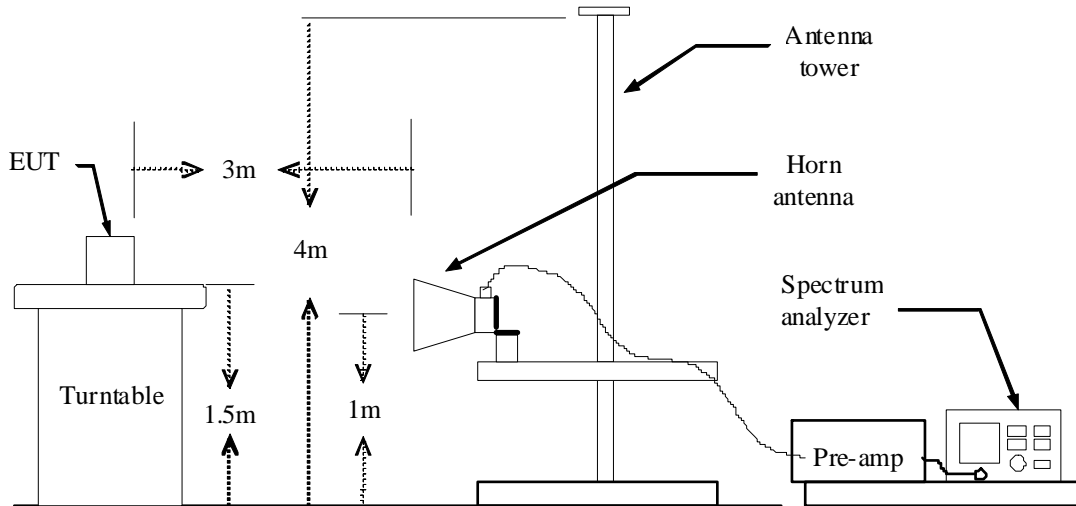

TEST PROCEDURE

1. The EUT is placed on a turntable above ground plane, which is 0.8 meter for frequency below 1GHz and 1.5 meter for frequency above 1GHz.
2. The turntable shall be rotated for 360 degrees to determine the position of maximum emission level.
3. EUT is set 3m away from the receiving antenna, which is varied from 1m to 4m to find out the highest emissions.
4. Maximum procedure was performed on the six highest emissions to ensure EUT compliance.
5. And also, each emission was to be maximized by changing the polarization of receiving antenna both horizontal and vertical.
6. Set the spectrum analyzer in the following setting as:

Below 1GHz:

RBW=100kHz / VBW=300kHz / Sweep=AUTO

Above 1GHz:

PEAK: RBW=VBW=1MHz / Sweep=AUTO

AVERAGE: RBW=1MHz / Sweep=AUTO

VBW=10Hz, when duty cycle is no less than 98 percent.

VBW $\geq 1/T$, when duty cycle is less than 98 percent, where T is the minimum transmission duration over which the transmitter is on and is transmitting at its maximum power control level for the tested mode of operation.

Band	Duty Cycle(%)	T(ms)	1/T(kHz)	VBW Setting
IEEE 802.11 b	100	--	--	10Hz
IEEE 802.11 g	99	--	--	10Hz
IEEE 802.11n HT20	99	--	--	10Hz

7. Repeat above procedures until the measurements for all frequencies are complete.

TEST RESULTS

RESTRICTED BANDEDGE (b Mode, Low Channel, Horizontal)

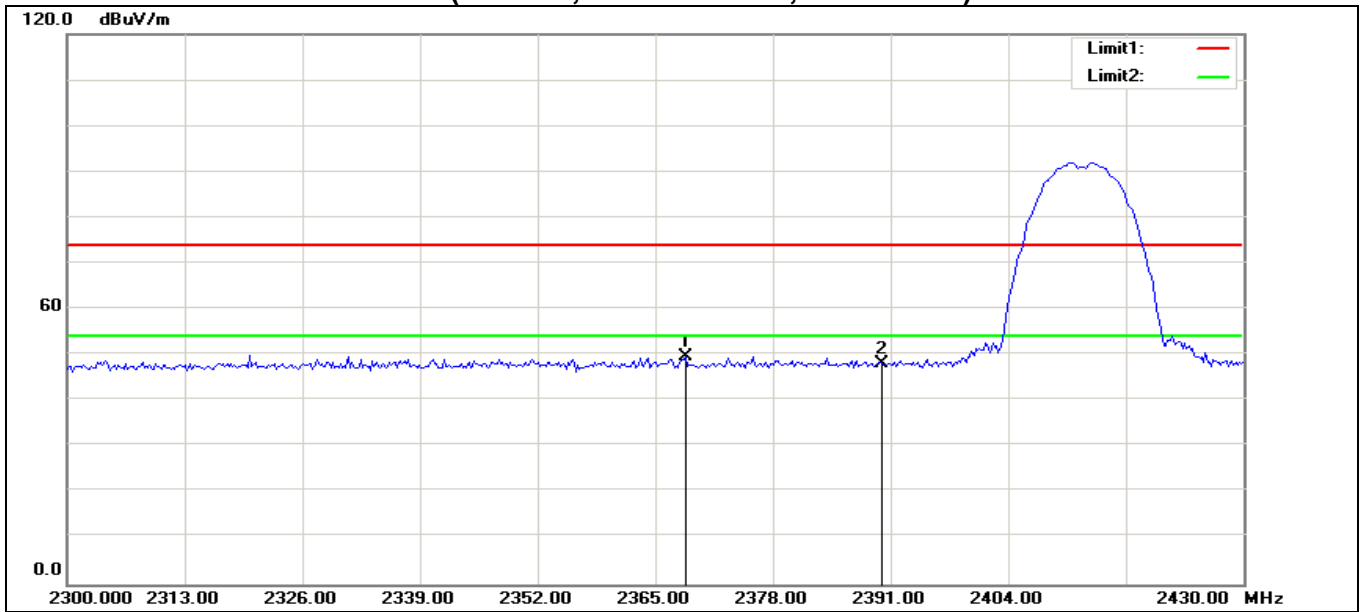

No.	Frequency (MHz)	Reading (dBuV)	Correct Factor(dB/m)	Result (dBuV/m)	Limit (dBuV/m)	Margin (dB)	Height (cm)	Degree (deg.)	Remark
1	2368.333	57.17	-7.51	49.66	74.00	-24.34	100	111	peak
2	2390.000	55.60	-7.31	48.29	74.00	-25.71	100	124	peak

RESTRICTED BANDEDGE (b Mode, Low Channel, Vertical)

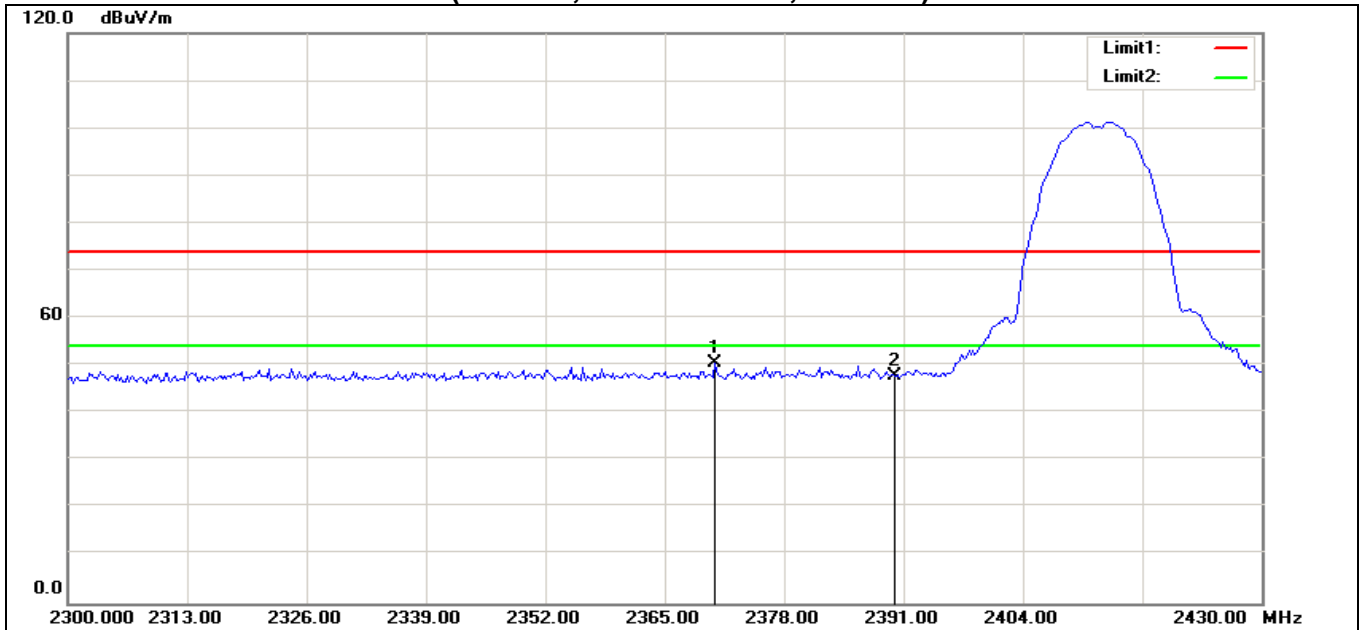

No.	Frequency (MHz)	Reading (dBuV)	Correct Factor(dB/m)	Result (dBuV/m)	Limit (dBuV/m)	Margin (dB)	Height (cm)	Degree (deg.)	Remark
1	2370.417	58.06	-7.49	50.57	74.00	-23.43	100	251	peak
2	2390.000	55.25	-7.31	47.94	74.00	-26.06	100	158	peak

RESTRICTED BANDEDGE (b Mode, High Channel, Horizontal)

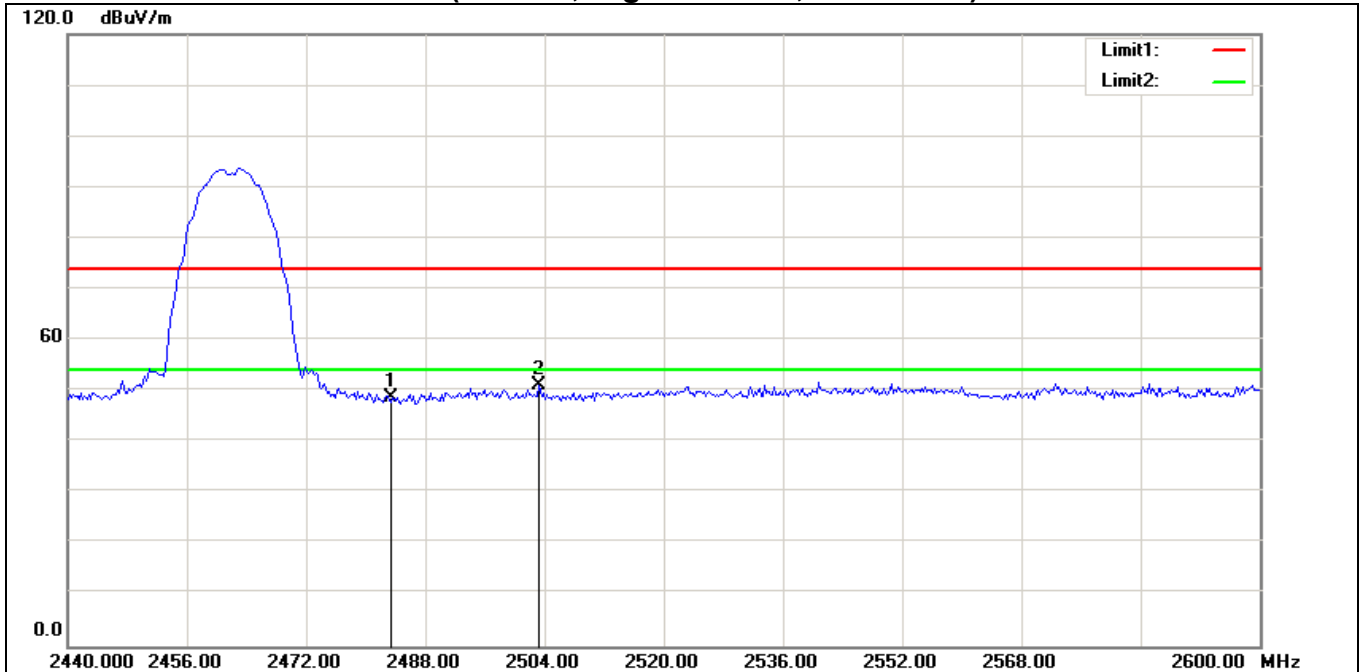

No.	Frequency (MHz)	Reading (dBuV)	Correct Factor(dB/m)	Result (dBuV/m)	Limit (dBuV/m)	Margin (dB)	Height (cm)	Degree (deg.)	Remark
1	2483.500	55.21	-6.44	48.77	74.00	-25.23	100	237	peak
2	2503.333	57.32	-6.26	51.06	74.00	-22.94	100	44	peak

RESTRICTED BANDEDGE (b Mode, High Channel, Vertical)

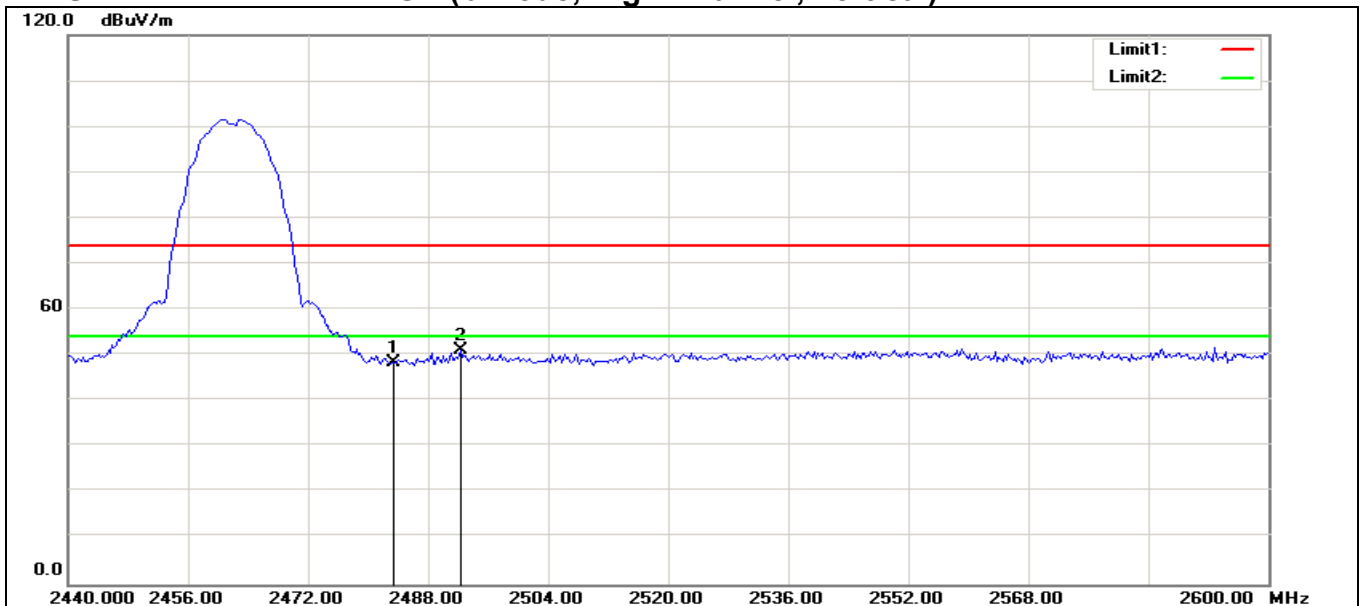

No.	Frequency (MHz)	Reading (dBuV)	Correct Factor(dB/m)	Result (dBuV/m)	Limit (dBuV/m)	Margin (dB)	Height (cm)	Degree (deg.)	Remark
1	2483.500	54.85	-6.44	48.41	74.00	-25.59	100	174	peak
2	2492.308	57.56	-6.36	51.20	74.00	-22.80	100	29	peak

RESTRICTED BANDEDGE (g Mode, Low Channel, Horizontal)

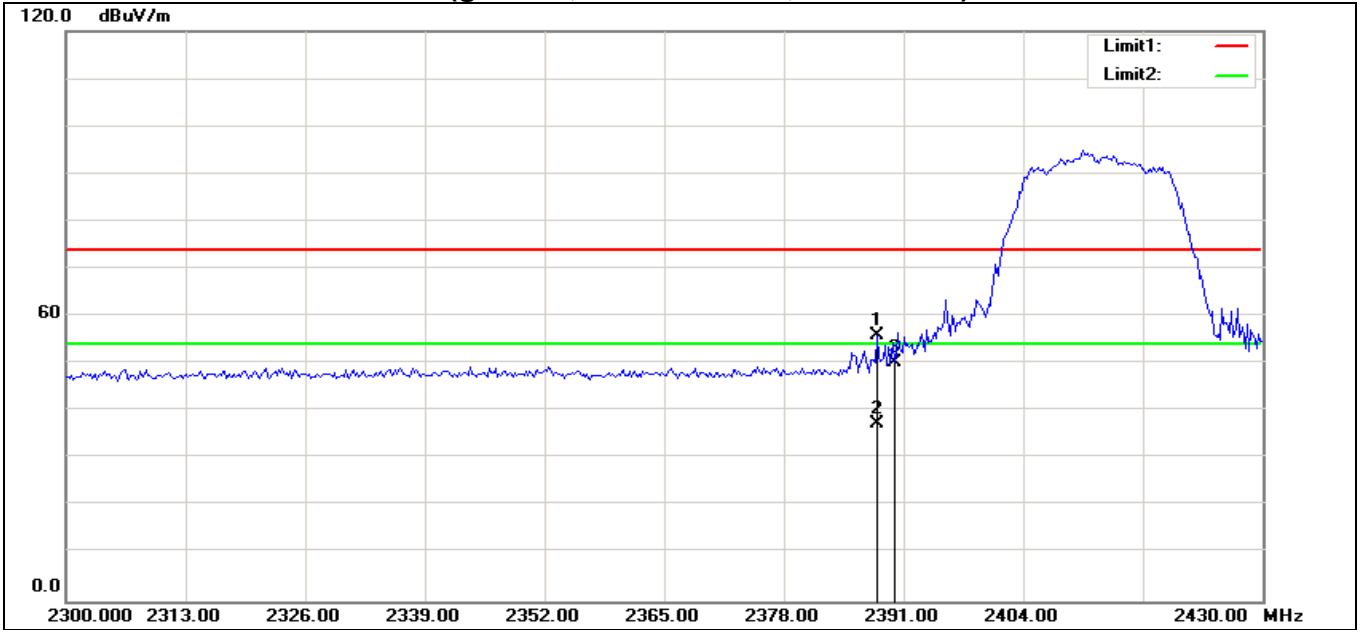

No.	Frequency (MHz)	Reading (dBuV)	Correct Factor(dB/m)	Result (dBuV/m)	Limit (dBuV/m)	Margin (dB)	Height (cm)	Degree (deg.)	Remark
1	2388.125	63.29	-7.33	55.96	74.00	-18.04	100	39	peak
2	2388.125	44.55	-7.33	37.22	54.00	-16.78	100	38	AVG
3	2390.000	57.51	-7.31	50.20	74.00	-23.80	100	141	peak

RESTRICTED BANDEDGE (g Mode, Low Channel, Vertical)

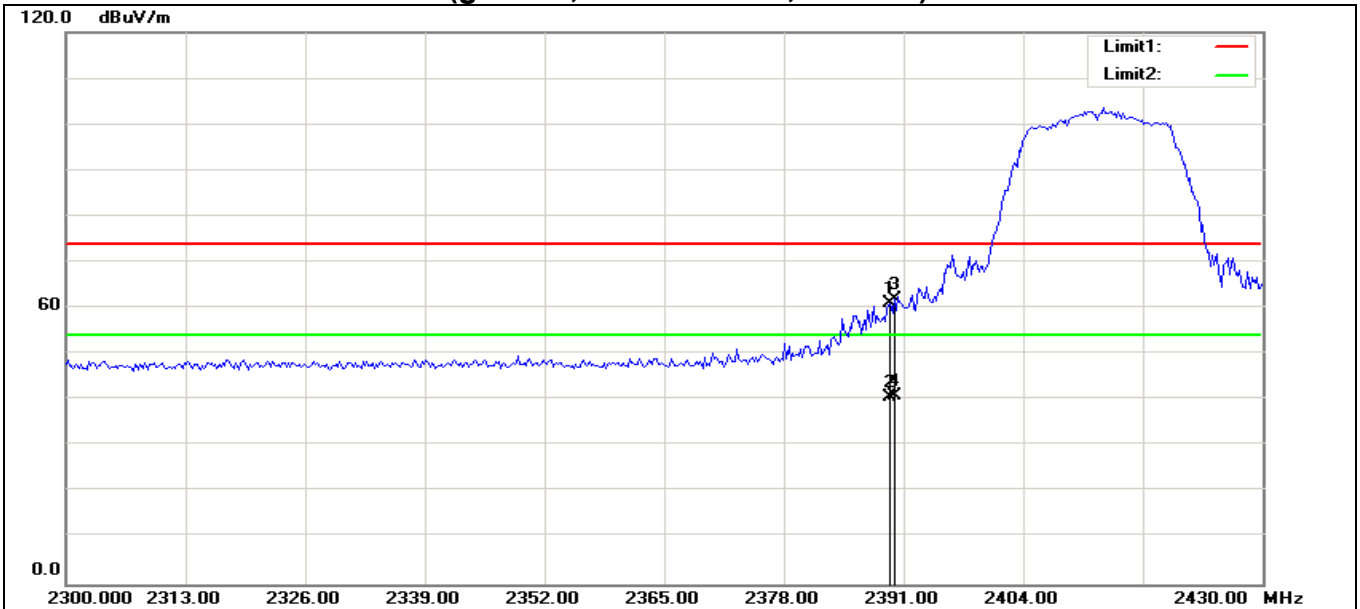

No.	Frequency (MHz)	Reading (dBuV)	Correct Factor(dB/m)	Result (dBuV/m)	Limit (dBuV/m)	Margin (dB)	Height (cm)	Degree (deg.)	Remark
1	2389.583	68.25	-7.31	60.94	74.00	-13.06	100	60	peak
2	2389.583	47.96	-7.31	40.65	54.00	-13.35	100	58	AVG
3	2390.000	69.20	-7.31	61.89	74.00	-12.11	100	60	peak
4	2390.000	48.37	-7.31	41.06	54.00	-12.94	100	60	AVG

RESTRICTED BANDEDGE (g Mode, High Channel, Horizontal)

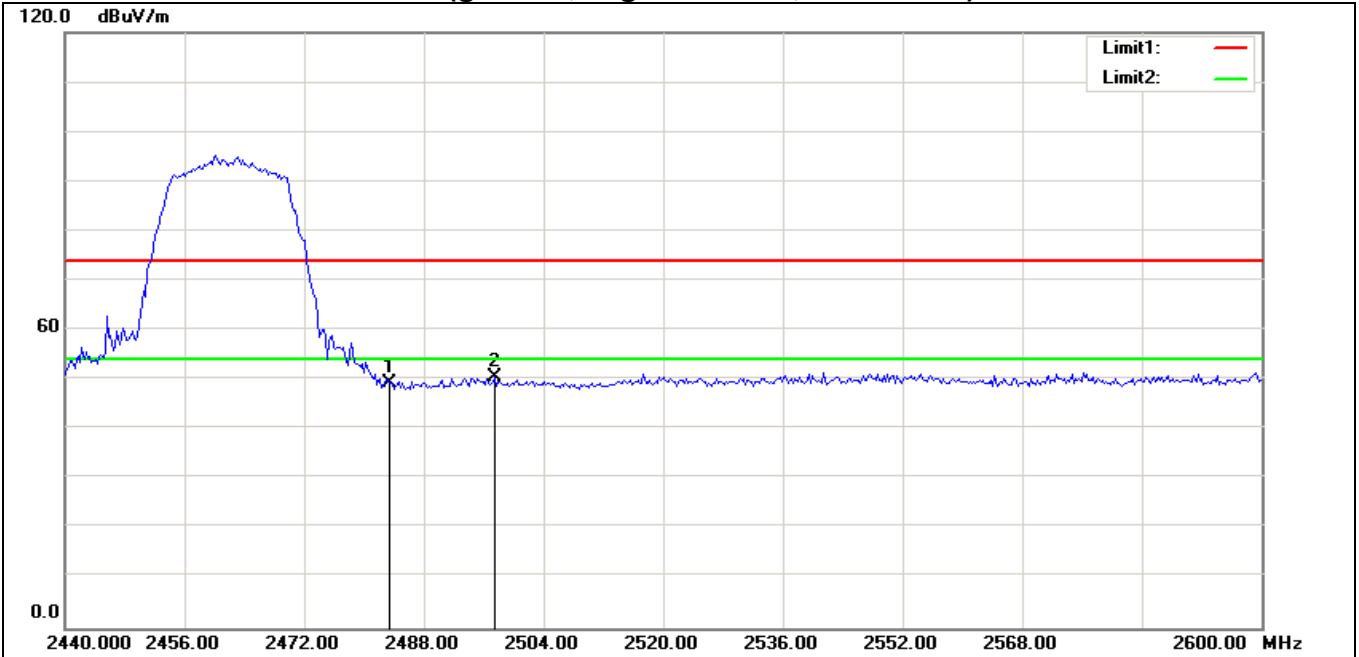

No.	Frequency (MHz)	Reading (dBuV)	Correct Factor(dB/m)	Result (dBuV/m)	Limit (dBuV/m)	Margin (dB)	Height (cm)	Degree (deg.)	Remark
1	2483.500	55.67	-6.44	49.23	74.00	-24.77	100	236	peak
2	2497.436	56.78	-6.31	50.47	74.00	-23.53	100	349	peak

RESTRICTED BANDEDGE (g Mode, High Channel, Vertical)

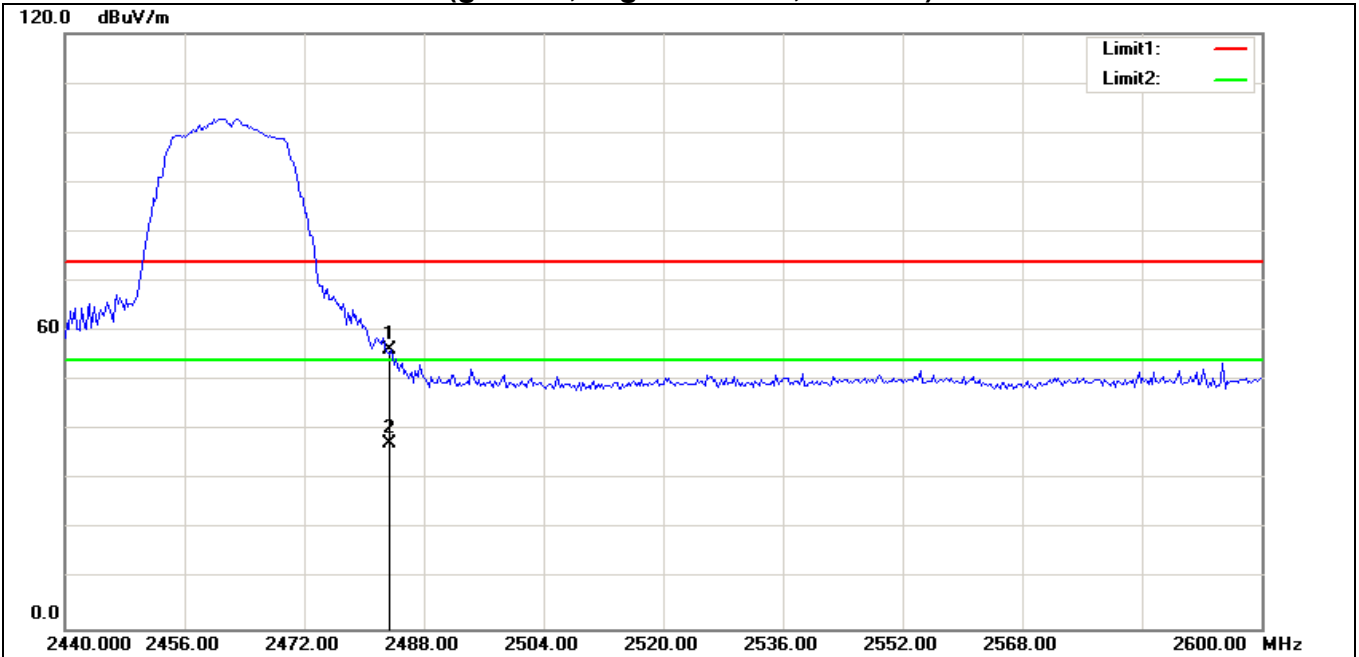

No.	Frequency (MHz)	Reading (dBuV)	Correct Factor(dB/m)	Result (dBuV/m)	Limit (dBuV/m)	Margin (dB)	Height (cm)	Degree (deg.)	Remark
1	2483.500	62.60	-6.44	56.16	74.00	-17.84	100	113	peak
2	2483.500	43.78	-6.44	37.34	54.00	-16.66	100	112	AVG

RESTRICTED BANDEDGE (IEEE 802.11n HT20 mode, Low Channel, Horizontal)

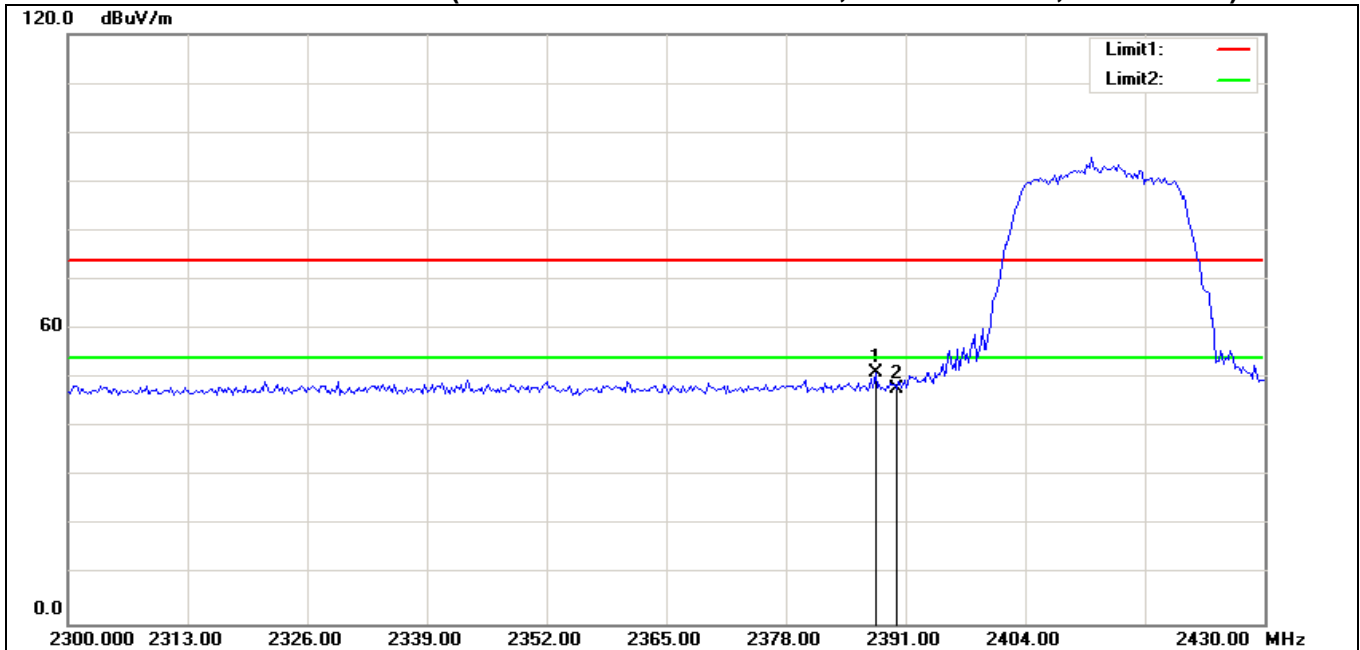

No.	Frequency (MHz)	Reading (dBuV)	Correct Factor(dB/m)	Result (dBuV/m)	Limit (dBuV/m)	Margin (dB)	Height (cm)	Degree (deg.)	Remark
1	2387.708	58.52	-7.33	51.19	74.00	-22.81	100	144	peak
2	2390.000	55.25	-7.31	47.94	74.00	-26.06	100	342	peak

RESTRICTED BANDEDGE (IEEE 802.11n HT20 mode, Low Channel, Vertical)

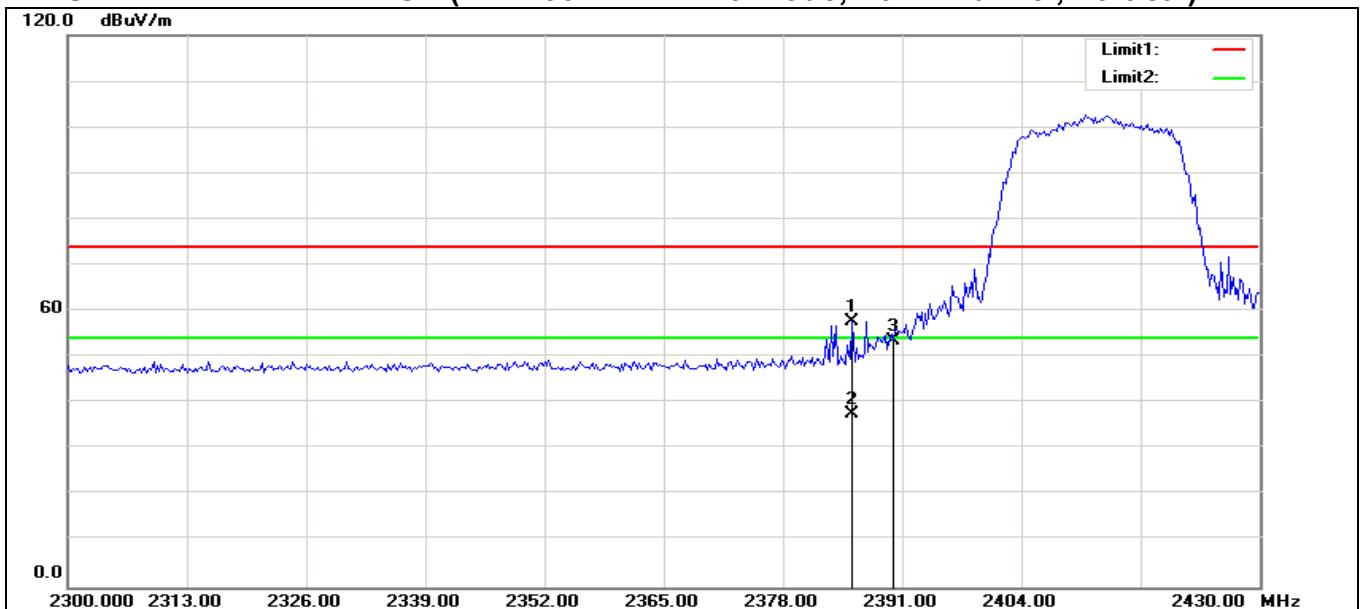

No.	Frequency (MHz)	Reading (dBuV)	Correct Factor(dB/m)	Result (dBuV/m)	Limit (dBuV/m)	Margin (dB)	Height (cm)	Degree (deg.)	Remark
1	2385.625	65.22	-7.35	57.87	74.00	-16.13	100	162	peak
2	2385.625	45.03	-7.35	37.68	54.00	-16.32	100	163	AVG
3	2390.000	60.83	-7.31	53.52	74.00	-20.48	100	108	peak

RESTRICTED BANDEDGE (IEEE 802.11n HT20 mode, High Channel, Horizontal)

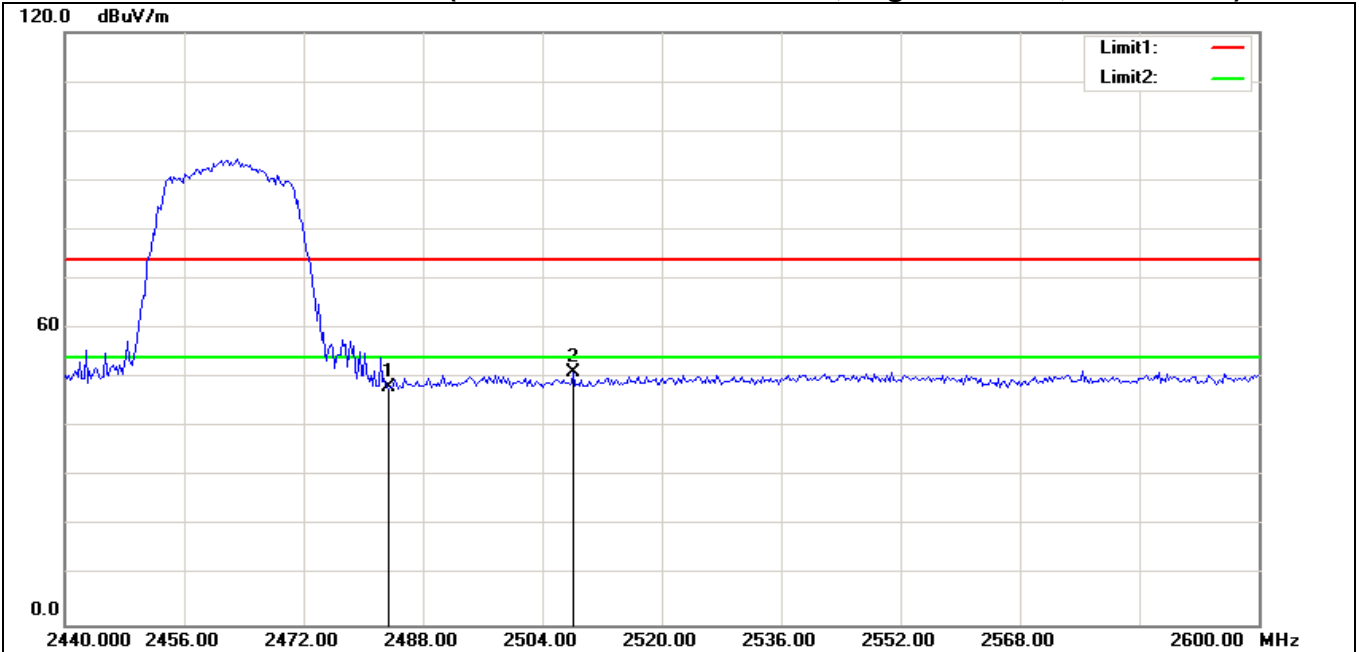

No.	Frequency (MHz)	Reading (dBuV)	Correct Factor(dB/m)	Result (dBuV/m)	Limit (dBuV/m)	Margin (dB)	Height (cm)	Degree (deg.)	Remark
1	2483.500	54.69	-6.44	48.25	74.00	-25.75	100	302	peak
2	2508.205	57.36	-6.21	51.15	74.00	-22.85	100	107	peak

RESTRICTED BANDEDGE (IEEE 802.11n HT20 mode, High Channel, Vertical)



No.	Frequency (MHz)	Reading (dBuV)	Correct Factor(dB/m)	Result (dBuV/m)	Limit (dBuV/m)	Margin (dB)	Height (cm)	Degree (deg.)	Remark
1	2483.500	58.57	-6.44	52.13	74.00	-21.87	100	208	peak
2	2485.385	63.83	-6.43	57.40	74.00	-16.60	100	327	peak
3	2485.385	44.57	-6.43	38.14	54.00	-15.86	100	329	AVG

Test Result of Radiated Emission

Below 30MHz

The interference of the frequency value is lower than the limit below 20 db, measured as the background noise values and will not be recorded.

30MHz-1GHz

Operation Mode:	Normal Link	Test Date:	2017-8-2
Temperature:	25°C	Tested by:	Lily.Wang
Humidity:	48% RH	Polarity:	Ver. / Hor.

Frequency (MHz)	Ant. Pol. (H/V)	Reading (dBuV)	Correction Factor (dB/m)	Result (dBuV/m)	Limit (dBuV/m)	Margin (dB)	Remark
359.8000	V	16.49	17.71	34.20	46.00	-11.80	peak
504.3300	V	15.72	21.61	37.33	46.00	-8.67	peak
656.6200	V	15.24	24.49	39.73	46.00	-6.27	peak
743.9200	V	16.17	26.26	42.43	46.00	-3.57	peak
864.2000	V	15.79	26.09	41.88	46.00	-4.12	peak
967.9900	V	16.10	27.07	43.17	54.00	-10.83	peak
456.8000	H	14.14	21.00	35.14	46.00	-10.86	QP
480.0800	H	13.35	21.32	34.67	46.00	-11.33	QP
504.1100	H	20.00	21.61	41.61	46.00	-4.39	QP
528.5800	H	17.07	21.65	38.72	46.00	-7.28	QP
551.8600	H	14.23	21.71	35.94	46.00	-10.06	QP
600.3600	H	20.94	22.30	43.24	46.00	-2.76	peak

Remark:

1. Measuring frequencies from 30 MHz to the 1GHz (No emission found between lowest internal used/generated frequency to 30 MHz).
2. Radiated emissions measured in frequency range from 30 MHz to 1000MHz were made with an instrument using peak/quasi-peak detector mode.
3. Measurements above show only up to 6 maximum emissions noted, or would be lesser, with "N/A" remark, if no specific emissions from the EUT are recorded (ie: margin>20dB from the applicable limit) and considered that's already beyond the background noise floor.
4. $Margin (dB) = Result (dBuV/m) - Limit (dBuV/m)$.

Above 1 GHz

Operation Mode: TX / IEEE 802.11b / CH Low

Test Date: 2017-8-2

Temperature: 24°C

Tested by: Lily.Wang

Humidity: 48 % RH

Polarity: Ver. / Hor.

Horizontal

No.	Frequency (MHz)	Reading (dBuV)	Correct Factor(dB/m)	Result (dBuV/m)	Limit (dBuV/m)	Margin (dB)	Height (cm)	Degree (deg.)	Remark
1	4740.000	43.15	-5.32	37.83	74.00	-36.17	100	150	peak
2	8021.000	42.48	7.01	49.49	74.00	-24.51	100	37	peak
N/A									

Vertical

No.	Frequency (MHz)	Reading (dBuV)	Correct Factor(dB/m)	Result (dBuV/m)	Limit (dBuV/m)	Margin (dB)	Height (cm)	Degree (deg.)	Remark
1	4944.000	42.48	-5.16	37.32	74.00	-36.68	100	360	peak
2	7868.000	44.39	6.89	51.28	74.00	-22.72	100	1	peak
N/A									

Operation Mode: TX / IEEE 802.11b / CH Mid

Test Date: 2017-8-2

Temperature: 24°C

Tested by: Lily.Wang

Humidity: 48 % RH

Polarity: Ver. / Hor.

Horizontal

No.	Frequency (MHz)	Reading (dBuV)	Correct Factor(dB/m)	Result (dBuV/m)	Limit (dBuV/m)	Margin (dB)	Height (cm)	Degree (deg.)	Remark
1	4978.000	42.78	-5.13	37.65	74.00	-36.35	100	217	peak
2	8429.000	43.10	6.99	50.09	74.00	-23.91	100	10	peak
N/A									

Vertical

No.	Frequency (MHz)	Reading (dBuV)	Correct Factor(dB/m)	Result (dBuV/m)	Limit (dBuV/m)	Margin (dB)	Height (cm)	Degree (deg.)	Remark
1	4825.000	42.38	-5.25	37.13	74.00	-36.87	100	176	peak
2	8514.000	43.61	6.98	50.59	74.00	-23.41	100	237	peak
N/A									

Operation Mode: TX / IEEE 802.11b / CH High

Test Date: 2017-8-2

Temperature: 24°C

Tested by:Lily.Wang

Humidity: 48 % RH

Polarity: Ver. / Hor.

Horizontal

No.	Frequency (MHz)	Reading (dBuV)	Correct Factor(dB/m)	Result (dBuV/m)	Limit (dBuV/m)	Margin (dB)	Height (cm)	Degree (deg.)	Remark
1	4995.000	42.52	-5.11	37.41	74.00	-36.59	100	234	peak
2	8531.000	43.10	6.98	50.08	74.00	-23.92	100	5	peak
N/A									

Vertical

No.	Frequency (MHz)	Reading (dBuV)	Correct Factor(dB/m)	Result (dBuV/m)	Limit (dBuV/m)	Margin (dB)	Height (cm)	Degree (deg.)	Remark
1	5182.000	43.83	-4.24	39.59	74.00	-34.41	100	135	peak
2	8837.000	42.73	6.97	49.70	74.00	-24.30	100	2	peak
N/A									

Operation Mode: TX / IEEE 802.11g / CH Low

Test Date: 2017-8-2

Temperature: 24°C

Tested by:Lily.Wang

Humidity: 48 % RH

Polarity: Ver. / Hor.

Horizontal

No.	Frequency (MHz)	Reading (dBuV)	Correct Factor(dB/m)	Result (dBuV/m)	Limit (dBuV/m)	Margin (dB)	Height (cm)	Degree (deg.)	Remark
1	4621.000	43.32	-5.42	37.90	74.00	-36.10	100	47	peak
2	8395.000	41.95	6.99	48.94	74.00	-25.06	100	2	peak
N/A									

Vertical

No.	Frequency (MHz)	Reading (dBuV)	Correct Factor(dB/m)	Result (dBuV/m)	Limit (dBuV/m)	Margin (dB)	Height (cm)	Degree (deg.)	Remark
1	4604.000	43.50	-5.43	38.07	74.00	-35.93	100	106	peak
2	8514.000	42.72	6.98	49.70	74.00	-24.30	100	17	peak
N/A									

Operation Mode: TX / IEEE 802.11g / CH Mid

Test Date: 2017-8-2

Temperature: 24°C

Tested by: Lily.Wang

Humidity: 48 % RH

Polarity: Ver. / Hor.

Horizontal

No.	Frequency (MHz)	Reading (dBuV)	Correct Factor(dB/m)	Result (dBuV/m)	Limit (dBuV/m)	Margin (dB)	Height (cm)	Degree (deg.)	Remark
1	4927.000	42.64	-5.17	37.47	74.00	-36.53	100	3	peak
2	8514.000	43.76	6.98	50.74	74.00	-23.26	100	3	peak
N/A									

Vertical

No.	Frequency (MHz)	Reading (dBuV)	Correct Factor(dB/m)	Result (dBuV/m)	Limit (dBuV/m)	Margin (dB)	Height (cm)	Degree (deg.)	Remark
1	4961.000	42.07	-5.14	36.93	74.00	-37.07	100	182	peak
2	8344.000	43.29	6.99	50.28	74.00	-23.72	100	241	peak
N/A									

Operation Mode: TX / IEEE 802.11g / CH High

Test Date: 2017-8-2

Temperature: 24°C

Tested by: Lily.Wang

Humidity: 48 % RH

Polarity: Ver. / Hor.

Horizontal

No.	Frequency (MHz)	Reading (dBuV)	Correct Factor(dB/m)	Result (dBuV/m)	Limit (dBuV/m)	Margin (dB)	Height (cm)	Degree (deg.)	Remark
1	4825.000	42.88	-5.25	37.63	74.00	-36.37	100	180	peak
2	8429.000	42.86	6.99	49.85	74.00	-24.15	100	106	peak
N/A									

Vertical

No.	Frequency (MHz)	Reading (dBuV)	Correct Factor(dB/m)	Result (dBuV/m)	Limit (dBuV/m)	Margin (dB)	Height (cm)	Degree (deg.)	Remark
1	4910.000	43.13	-5.18	37.95	74.00	-36.05	100	141	peak
2	8854.000	44.35	6.97	51.32	74.00	-22.68	100	126	peak
N/A									

Operation Mode: TX / IEEE 802.11n HT20 mode / CH Low

Test Date: 2017-8-2

Temperature: 24°C

Tested by: Lily.Wang

Humidity: 48 % RH

Polarity: Ver. / Hor.

Horizontal

No.	Frequency (MHz)	Reading (dBuV)	Correct Factor(dB/m)	Result (dBuV/m)	Limit (dBuV/m)	Margin (dB)	Height (cm)	Degree (deg.)	Remark
1	4638.000	43.47	-5.40	38.07	74.00	-35.93	100	209	peak
2	8514.000	42.86	6.98	49.84	74.00	-24.16	100	260	peak
N/A									

Vertical

No.	Frequency (MHz)	Reading (dBuV)	Correct Factor(dB/m)	Result (dBuV/m)	Limit (dBuV/m)	Margin (dB)	Height (cm)	Degree (deg.)	Remark
1	4655.000	43.59	-5.39	38.20	74.00	-35.80	100	242	peak
2	7953.000	43.06	6.97	50.03	74.00	-23.97	100	301	peak
N/A									

Operation Mode: TX / IEEE 802.11n HT20 mode / CH Mid

Test Date: 2017-8-2

Temperature: 24°C

Tested by: Lily.Wang

Humidity: 48 % RH

Polarity: Ver. / Hor.

Horizontal

No.	Frequency (MHz)	Reading (dBuV)	Correct Factor(dB/m)	Result (dBuV/m)	Limit (dBuV/m)	Margin (dB)	Height (cm)	Degree (deg.)	Remark
1	5012.000	42.96	-5.05	37.91	74.00	-36.09	100	203	peak
2	8446.000	41.83	6.99	48.82	74.00	-25.18	100	219	peak
N/A									

Vertical

No.	Frequency (MHz)	Reading (dBuV)	Correct Factor(dB/m)	Result (dBuV/m)	Limit (dBuV/m)	Margin (dB)	Height (cm)	Degree (deg.)	Remark
1	4978.000	43.22	-5.13	38.09	74.00	-35.91	100	2	peak
2	8837.000	44.28	6.97	51.25	74.00	-22.75	100	150	peak
N/A									

Operation Mode: TX / IEEE 802.11n HT20 mode / CH High **Test Date:** 2017-8-2

Temperature: 24°C

Tested by: Lily.Wang

Humidity: 48 % RH

Polarity: Ver. / Hor.

Horizontal

No.	Frequency (MHz)	Reading (dBuV)	Correct Factor(dB/m)	Result (dBuV/m)	Limit (dBuV/m)	Margin (dB)	Height (cm)	Degree (deg.)	Remark
1	5233.000	44.42	-4.00	40.42	74.00	-33.58	100	217	peak
2	8667.000	43.13	6.98	50.11	74.00	-23.89	100	196	peak
N/A									

Vertical

No.	Frequency (MHz)	Reading (dBuV)	Correct Factor(dB/m)	Result (dBuV/m)	Limit (dBuV/m)	Margin (dB)	Height (cm)	Degree (deg.)	Remark
1	5182.000	43.36	-4.24	39.12	74.00	-34.88	100	106	peak
2	8769.000	43.80	6.97	50.77	74.00	-23.23	100	188	peak
N/A									

7.6.POWERLINE CONDUCTED EMISSIONS

LIMIT

According to §15.207(a), except as shown in paragraphs (b) and (c) of this section, for an intentional radiator that is designed to be connected to the public utility (AC) power line, the radio frequency voltage that is conducted back onto the AC power line on any frequency or frequencies within the band 150 kHz to 30 MHz shall not exceed the limits in the following table, as measured using a 50 μ H/50 ohms line impedance stabilization network (LISN). Compliance with the provisions of this paragraph shall be based on the measurement of the radio frequency voltage between each power line and ground at the power terminal. The lower limit applies at the boundary between the frequency ranges.

Frequency Range (MHz)	Limits (dB μ V)	
	Quasi-peak	Average
0.15 to 0.50	66 to 56*	56 to 46*
0.50 to 5	56	46
5 to 30	60	50

* Decreases with the logarithm of the frequency.

Test Configuration

See test photographs attached in Appendix 1 for the actual connections between EUT and support equipment.

TEST PROCEDURE

- 1.The EUT was placed on a table, which is 0.8m above ground plane.
- 2.Maximum procedure was performed on the six highest emissions to ensure EUT compliance.
- 3.Repeat above procedures until all frequency measured were complete.

TEST RESULTS

The initial step in collecting conducted data is a spectrum analyzer peak scan of the measurement range. Significant peaks are then marked as shown on the following data page, and these signals are then quasi-peaked.

TEST DATA

Job No.:	C170630R01	Date:	2017-7-22
Model No.:	YVR.1017	Time:	8:56:17
Standard:	FCC Class B	Temp.(C)/Hum.(%):	22(C)/48%
Test item:	Conduction test	Test By:	Lily.Wang
Line:	L1	Test Voltage:	AC 120V/60Hz
Model:		Description:	

L1

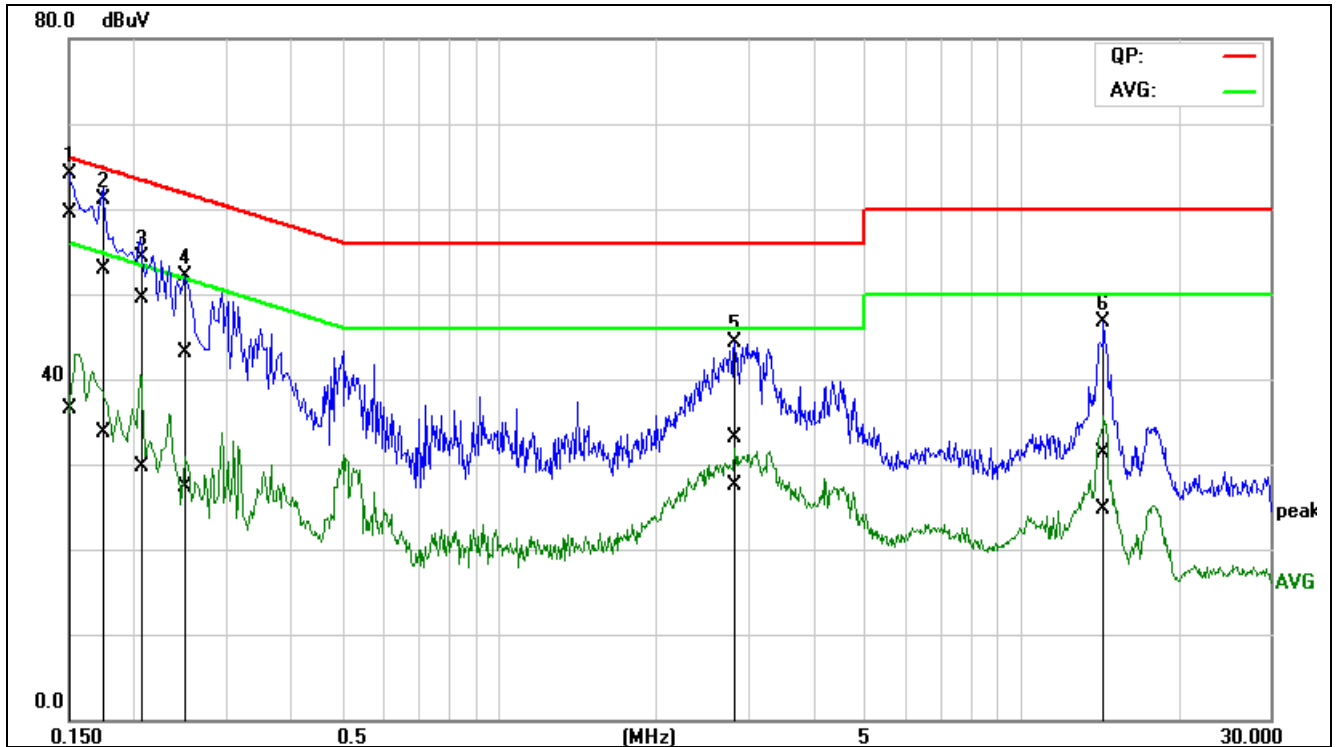

No.	Frequency (MHz)	QuasiPeak reading (dBuV)	Average reading (dBuV)	Correction factor (dB)	QuasiPeak result (dBuV)	Average result (dBuV)	QuasiPeak limit (dBuV)	Average limit (dBuV)	QuasiPeak margin (dB)	Average margin (dB)	Remark
1*	0.1515	38.92	15.92	20.59	59.51	36.51	65.92	55.92	-6.41	-19.41	Pass
2	0.1767	32.34	13.11	20.55	52.89	33.66	64.64	54.64	-11.75	-20.98	Pass
3	0.2088	28.96	9.22	20.50	49.46	29.72	63.25	53.25	-13.79	-23.53	Pass
4	0.2505	22.61	6.86	20.44	43.05	27.30	61.74	51.74	-18.69	-24.44	Pass
5	2.8211	12.66	7.08	20.51	33.17	27.59	56.00	46.00	-22.83	-18.41	Pass
6	14.4032	10.53	3.93	20.79	31.32	24.72	60.00	50.00	-28.68	-25.28	Pass

Note: 1. L1 = Line One (Live Line) / L2 = Line Two (Neutral Line).

Job No.:	C170630R01	Date:	2017-7-22
Model No.:	YVR.1017	Time:	9:01:08
Standard:	FCC Class B	Temp.(C)/Hum.(%):	22(C)/48%
Test item:	Conduction test	Test By:	Lily.Wang
Line:	L2	Test Voltage:	AC 120V/60Hz
Model:		Description:	

L2

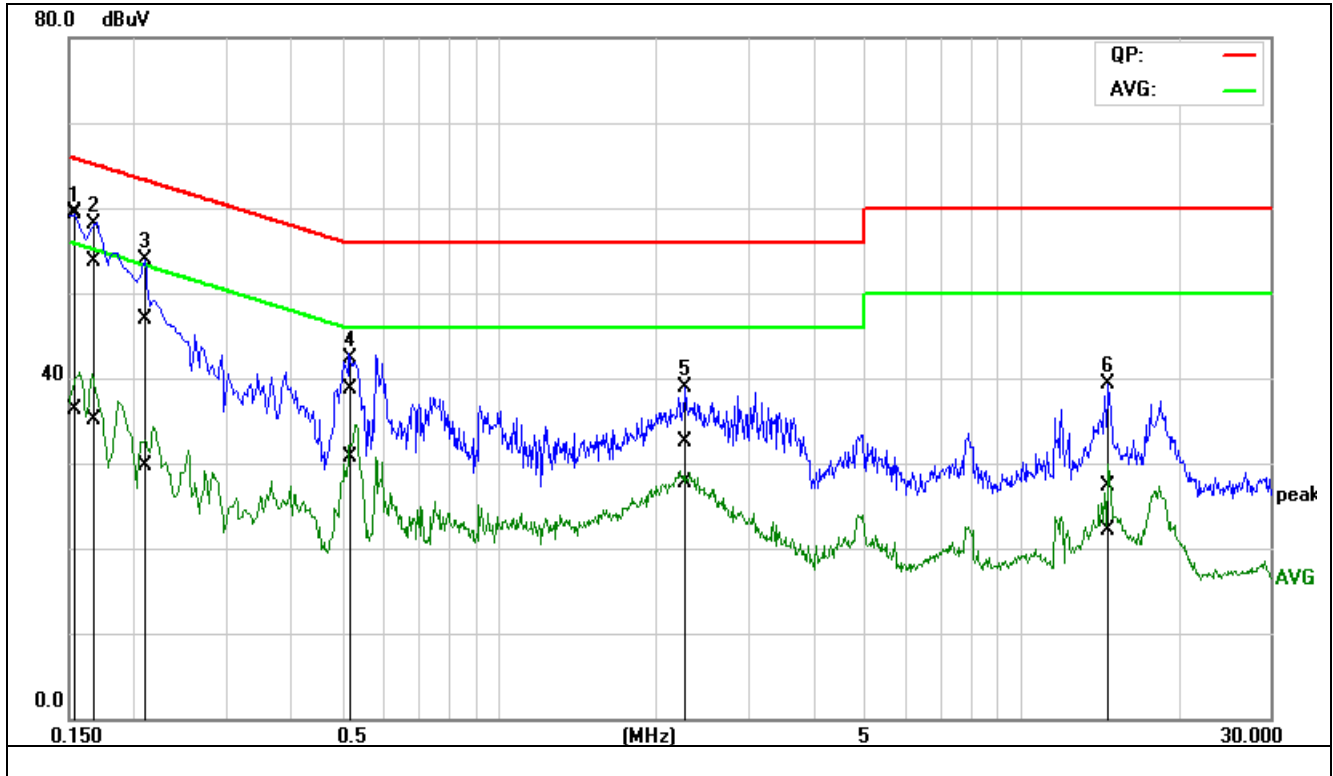

No.	Frequency (MHz)	QuasiPeak reading (dBuV)	Average reading (dBuV)	Correction factor (dB)	QuasiPeak result (dBuV)	Average result (dBuV)	QuasiPeak limit (dBuV)	Average limit (dBuV)	QuasiPeak margin (dB)	Average margin (dB)	Remark
1*	0.1500	39.15	15.86	20.36	59.51	36.22	66.00	56.00	-6.49	-19.78	Pass
2	0.1652	33.41	14.72	20.37	53.78	35.09	65.20	55.20	-11.42	-20.11	Pass
3	0.2079	26.41	9.29	20.41	46.82	29.70	63.29	53.29	-16.47	-23.59	Pass
4	0.5232	18.20	10.21	20.45	38.65	30.66	56.00	46.00	-17.35	-15.34	Pass
5	2.2806	11.99	7.11	20.55	32.54	27.66	56.00	46.00	-23.46	-18.34	Pass
6	14.7296	6.52	1.25	20.81	27.33	22.06	60.00	50.00	-32.67	-27.94	Pass

Note: 1. L1 = Line One (Live Line) / L2 = Line Two (Neutral Line).

Remark:

- 1.The measuring frequencies range between 0.15 MHz and 30 MHz.
- 2.The emissions measured in the frequency range between 0.15 MHz and 30MHz were made with an instrument using Quasi-peak detector and Average detector.
- 3.“---” denotes the emission level was or more than 2dB below the Average limit, and no re-check was made.
- 4.The IF bandwidth of SPA between 0.15MHz and 30MHz was 10KHz. The IF bandwidth of Test Receiver between 0.15MHz and 30MHz was 9kHz.

END OF REPORT