

# FCC 47 CFR PART 15 SUBPART C TEST REPORT

For

Product Name: YI 360 VR Camera

Brand Name: YI

Model No.: YVR.1017

Series Model.: N/A

FCC ID: 2AFIB-YVR1017

Test Report Number:

C170630R01-RPB1

Issued for

Shanghai Xiaoyi Technology Co., Ltd.

6F,Building E,No.2889,Jinke Road,Shanghai,China

Issued by

Compliance Certification Services Inc.

Kun shan Laboratory

No.10 Weiye Rd., Innovation park, Eco&Tec,  
Development Zone, Kunshan City, Jiangsu, China

TEL: 86-512-57355888

FAX: 86-512-57370818



**Note:** This report shall not be reproduced except in full, without the written approval of Compliance Certification Services Inc. This document may be altered or revised by Compliance Certification Services Inc. personnel only, and shall be noted in the revision section of the document. The client should not use it to claim product endorsement by A2LA or any government agencies. The test results in the report only apply to the tested sample.

## TABLE OF CONTENTS

<b>1</b>	<b>TEST RESULT CERTIFICATION .....</b>	<b>4</b>
<b>2</b>	<b>EUT DESCRIPTION .....</b>	<b>5</b>
<b>3</b>	<b>TEST METHODOLOGY .....</b>	<b>6</b>
	3.1 EUT CONFIGURATION .....	6
	3.2 EXERCISEEUT .....	6
	3.3 GENERAL TEST PROCEDURES .....	6
	3.4 TEST MODE .....	7
	3.5 FCC PART 15.205 RESTRICTED BANDS OF OPERATIONS .....	8
<b>4</b>	<b>INSTRUMENT CALIBRATION .....</b>	<b>9</b>
<b>5</b>	<b>FACILITIES AND ACCREDITATIONS .....</b>	<b>9</b>
	5.1 FACILITIES .....	9
	5.2 EQUIPMENT .....	9
	5.3 LABORATORY ACCREDITATIONS AND LISTING .....	9
	5.4 TABLE OF ACCREDITATIONS .....	10
	5.5 LIST OF MEASURING EQUIPMENT .....	11
	5.6 SETUP CONFIGURATION .....	12
	5.7 SUPPORT EQUIPMENT .....	12
<b>6</b>	<b>FCC PART 15.247 REQUIREMENTS .....</b>	<b>13</b>
	6.1 PEAK POWER .....	13
	6.2 PEAK POWER SPECTRAL DENSITY .....	15
	6.3 6DB BANDWIDTH MEASUREMENT .....	18
	6.4 CONDUCTED BAND EDGES AND SPURIOUS EMISSION MEASUREMENT .....	21
	6.5 RADIATED BAND EDGE AND SPURIOUS EMISSION MEASUREMENT .....	28
	6.6 POWERLINE CONDUCTED EMISSIONS .....	35

### Revision History

Rev.	Issue Date	Report NO.	Effect Page	Contents
00	August 5, 2017	C170630R01-RPB1	ALL	N/A
01	August 23, 2017	C170630R01-RPB1	P5	Update antenna gain information

# 1 TEST RESULT CERTIFICATION

<b>Product Name:</b>	YI 360 VR Camera
<b>Trade Name:</b>	YI
<b>Model Name:</b>	YVR.1017
<b>Series Model:</b>	N/A
<b>Applicant Discrepancy:</b>	Initial
<b>Device Category:</b>	Portable unit
<b>Date of Test:</b>	July 22, 2017 ~ August 04, 2017
<b>Applicant:</b>	<b>Shanghai Xiaoyi Technology Co., Ltd.</b> 6F,Building E,No.2889,Jinke Road,Shanghai,China
<b>Manufacturer:</b>	<b>Shanghai Xiaoyi Technology Co., Ltd.</b> 6F,Building E,No.2889,Jinke Road,Shanghai,China
<b>Application Type:</b>	Certification

APPLICABLE STANDARDS	
STANDARD	TEST RESULT
FCC 47 CFR Part 15 Subpart C	No non-compliance noted

The above equipment was tested by Compliance Certification Services Inc. The test data, data evaluation, test procedures, and equipment configurations shown in this report were made in accordance with the procedures given in ANSI C63.10:2013 and the energy emitted by the sample EUT tested as described in this report is in compliance with the requirements of FCC Rules Part 15.207, 15.209, 15.247.

The test results of this report relate only to the tested sample EUT identified in this report.

**Approved by:**

Jeff.Fang  
RF Manager  
Compliance Certification Service Inc.

**Tested by:**

Lily.Wang  
Test Engineer  
Compliance Certification Service Inc.

## 2 EUT DESCRIPTION

<b>Product Name:</b>	YI 360 VR Camera
<b>Trade Name:</b>	YI
<b>Model Name:</b>	YVR.1017
<b>Series Model:</b>	N/A
<b>Model Discrepancy:</b>	N/A
<b>Power Adapter:</b>	From PC
<b>Frequency Range :</b>	Bluetooth:2402 ~ 2480 MHz
<b>Transmit Power :</b>	Bluetooth LE4.1: 2.93dBm(1.963mW)
<b>Channel Spacing</b>	Bluetooth LE4.1: 2MHz
<b>Modulation type:</b>	Bluetooth LE4.1: GFSK
<b>Transmit Data Rate :</b>	Bluetooth LE4.1: 1 Mbps
<b>Number of Channels :</b>	Bluetooth LE4.1: 40 Channels
<b>Antenna Specification :</b>	FPC antenna
<b>Antenna Specification:</b>	FPC Antenna Gain: 1.62dBi

**Remark:**

- 1.The sample selected for test was engineering sample that approximated to production product and was provided by manufacturer.
- 2.This submittal(s) (test report) is intended for **FCC ID: 2AFIB-YVR1017** filing to comply with Section 15.207, 15.209 and 15.247 of the FCC Part 15, Subpart C Rules.

### 3 TEST METHODOLOGY

The tests documented in this report were performed in accordance with ANSI C63.10 and FCC CFR 47 2.1046, 2.1047, 2.1049, 2.1051, 2.1053, 2.1055, 2.1057, 15.207, 15.209 and 15.247.

#### 3.1 EUT CONFIGURATION

The EUT configuration for testing is installed on RF field strength measurement to meet the Commissions requirement and operating in a manner that intends to maximize its emission characteristics in a continuous normal application.

#### 3.2 EXERCISEEUT

The EUT was operated in the engineering mode to fix the TX frequency that was for the purpose of the measurements.

According to its specifications, the EUT must comply with the requirements of the Section 15.207, 15.209 and 15.247 under the FCC Rules Part 15 Subpart C.

#### 3.3 GENERAL TEST PROCEDURES

##### Conducted Emissions

The EUT is placed on the turntable, which is 0.8 m above ground plane. According to the requirements in Section 13.1.4.1 of ANSI C63.10 Conducted emissions from the EUT measured in the frequency range between 0.15 MHz and 30MHz using CISPR Quasi-peak and average detector modes.

##### Radiated Emissions

Under 1GHz

The EUT is placed on a turn table, which is 0.8 m above ground plane. The turntable shall rotate 360 degrees to determine the position of maximum emission level. EUT is set 3m away from the receiving antenna, which varied from 1m to 4m to find out the highest emission. And also, each emission was to be maximized by changing the polarization of receiving antenna both horizontal and vertical. In order to find out the maximum emissions, exploratory radiated emission measurements were made according to the requirements in Section 13.1.4.1 of ANSI C63.10.

Above 1GHz

The EUT is placed on a turn table, which is 1.5 m above ground plane. The turntable shall rotate 360 degrees to determine the position of maximum emission level. EUT is set 3m away from the receiving antenna, which varied from 1m to 4m to find out the highest emission. And also, each emission was to be maximized by changing the polarization of receiving antenna both horizontal and vertical. In order to find out the maximum emissions, exploratory radiated emission measurements were made according to the requirements in Section 13.1.4.1 of ANSI C63.10.

### 3.4 TEST Mode

Preliminary tests were performed in different data rate to find the worst radiated emission. The data rate shown in the table below is the worst-case rate with respect to the specific test item. Investigation has been done on all the possible configurations for searching the worst cases. The following table is a list of the test modes shown in this test report.

Test Items	Mode	Data Rate	Channel	Antenna
6dB Bandwidth	GFSK	1 Mbps	0/19/39	1
Peak Output Power	GFSK	1 Mbps	0/19/39	1
Power Spectral Density	GFSK	1 Mbps	0/19/39	1
Conducted Band Edges and Spurious Emission	GFSK	1 Mbps	0/19/39	1
Radiated Band Edges and Spurious Emission	GFSK	1 Mbps	0/19/39	1
AC Conducted Emission	CTX	1 Mbps	-	-

Remark: For radiated test cases below 1 GHz, the worst mode data rate channel 39 was reported only, because this data rate has the highest RF output power at preliminary tests.

### 3.5 FCC PART 15.205 RESTRICTED BANDS OF OPERATIONS

(a) Except as shown in paragraph (d) of this section, only spurious emissions are permitted in any of the frequency bands listed below:

MHz	MHz	MHz	GHz
0.0900 - 0.1100	16.420 - 16.423	399.9 - 410.0	4.50 - 5.15
0.4950 - 0.505 <sup>(1)</sup>	16.69475 - 16.69525	608 - 614	5.35 - 5.46
2.1735 - 2.1905	16.80425 - 16.80475	960.0 - 1240	7.25 - 7.75
4.1250 - 4.1280	25.50 - 25.67	1300 - 1427	8.025 - 8.500
4.17725 - 4.17775	37.50 - 38.25	1435.0 - 1626.5	9.0 - 9.2
4.20725 - 4.20775	73.0 - 74.6	1645.5 - 1646.5	9.3 - 9.5
6.2150 - 6.2180	74.8 - 75.2	1660 - 1710	10.6 - 12.7
6.26775 - 6.26825	108.00 - 121.94	1718.8 - 1722.2	13.25 - 13.40
6.31175 - 6.31225	123 - 138	2200 - 2300	14.47 - 14.50
8.2910 - 8.2940	149.90 - 150.05	2310 - 2390	15.35 - 16.20
8.3620 - 8.3660	156.52475 - 156.52525	2483.5 - 2500.0	17.7 - 21.4
8.37625 - 8.38675	156.7 - 156.9	2655 - 2900	22.01 - 23.12
8.41425 - 8.41475	162.0125 - 167.1700	3260 - 3267	23.6 - 24.0
12.2900 - 12.2930	167.72 - 173.20	3332 - 3339	31.2 - 31.8
12.51975 - 12.52025	240 - 285	3345 - 3358	36.43 - 36.5 <sup>(2)</sup>
12.57675 - 12.57725	322.0 - 335.4	3600 - 4400	
13.3600 - 13.4100			

<sup>1</sup> Until February 1, 1999, this restricted band shall be 0.490-0.510 MHz.

<sup>2</sup> Above 38.6

(b) Except as provided in paragraphs (d) and (e), the field strength of emissions appearing within these frequency bands shall not exceed the limits shown in Section 15.209. At frequencies equal to or less than 1000 MHz, compliance with the limits in Section 15.209 shall be demonstrated using measurement instrumentation employing a CISPR quasi-peak detector. Above 1000 MHz, compliance with the emission limits in Section 15.209 shall be demonstrated based on the average value of the measured emissions. The provisions in Section 15.35 apply to these measurements.



## 4 INSTRUMENT CALIBRATION

The measuring equipment, which was utilized in performing the tests documented herein, has been calibrated in accordance with the manufacturer's recommendations for utilizing calibration equipment, which is traceable to recognized national standards. facilities and accreditations

## 5 FACILITIES AND ACCREDITATIONS

### 5.1 FACILTIES

All measurement facilities used to collect the measurement data are located at CCS China Kunshan Lab at 10#Weiye Rd, Innovation Park Eco. & Tec. Development Zone Kunshan city JiangSu, (215300), CHINA.

The sites are constructed in conformance with the requirements of ANSI C63.4 and CISPR Publication 22.

### 5.2 EQUIPMENT

Radiated emissions are measured with one or more of the following types of linearly polarized antennas: tuned dipole, biconical, log periodic, bi-log, and/or ridged waveguide, horn. Spectrum analyzers with pre-selectors and quasi-peak detectors are used to perform radiated measurements.

Conducted emissions are measured with Line Impedance Stabilization Networks and EMI Test Receivers.

Calibrated wideband preamplifiers, coaxial cables, and coaxial attenuators are also used for making measurements.

All receiving equipment conforms to CISPR Publication 16-1, "Radio Interference Measuring Apparatus and Measurement Methods."

### 5.3 LABORATORY ACCREDITATIONS AND LISTING

FCC –Designation Number: CN1172.

Compliance Certification Services Inc. Kun shan Laboratory has been registered and fully described in a report filed with the (FCC) Federal Communications Commission. The acceptance letter from the FCC is maintained in our files and the Designation Number: CN1172.

## TABLE OF ACCREDITATIONS

Our laboratories are accredited and approved by the following accreditation body according to ISO/IEC 17025.

<b>Taiwan</b>	TAF
<b>USA</b>	A2LA

The measuring facility of laboratories has been authorized or registered by the following approval agencies.

<b>Canada</b>	Industry Canada
<b>Japan</b>	VCCI
<b>Taiwan</b>	BSMI
<b>USA</b>	FCC

Copies of granted accreditation certificates are available for downloading from our web site, <http://www.ccsrf.com>

## 5.4 LIST OF MEASURING EQUIPMENT

Conducted Emissions Test Site					
Name of Equipment	Manufacturer	Model	Serial Number	Calibration Date	Calibration Due
Spectrum Analyzer	Agilent	E4446A	MY44020154	2016-9-10	2017-9-9
Spectrum Analyzer	RS	FSU26	200789	2016-7-21	2017-7-20
Spectrum Analyzer	RS	FSU26	200789	2017-7-20	2018-7-19
Power meter	Anritsu	ML2495A	1445010	2017-4-26	2018-4-25
Power sensor	Anritsu	MA2411B	1339220	2017-4-26	2018-4-25
Power SPLITTER	Mini-Circuits	ZN2PD-9G	SF078500430	N.C.R	N.C.R
DC Power Supply	AGILENT	E3632A	MY50340053	N.C.R	N.C.R
Temp. / Humidity Gauge	Anymetre	TH603	CCS007	2016-11-1	2017-10-31
Test Software			EZ-EMC		

977 Chamber					
Name of Equipment	Manufacturer	Model	Serial Number	Calibration Date	Calibration Due
Spectrum Analyzer	Agilent	E4446A	MY44020154	2016-9-10	2017-9-9
Spectrum Analyzer	RS	FSU26	200789	2016-7-21	2017-7-20
Spectrum Analyzer	RS	FSU26	200789	2017-7-20	2018-7-19
EMI Test Receiver	R&S	ESCI	101378	2017-1-5	2018-1-4
Pre-Amplifier	MITEQ	AMF-6F-260400-40-8P	1037496	2016-11-15	2017-11-14
Amplifier	MITEQ	JS41-00101800-32-10P	1675713	2017-7-20	2018-7-19
Broad-Band Horn Antenna	SCHWARZBECK	BBHA 9170	9170-515	2017-3-6	2018-3-5
Bilog Antenna	Sunol	JB1	A062604	2017-5-27	2018-5-26
Bilog Antenna	Sunol	JB1	A110204-1	2017-5-27	2018-5-26
Loop Antenna	Hengweiyi	39501C	2014012	2017-1-5	2018-1-4
Horn-antenna	SCHWARZBECK	9120D	D:266	2017-2-28	2018-2-27
Horn-antenna	SCHWARZBECK	9120D	D:267	2016-11-10	2017-11-9
Turn Table	CT	CT123	4165	N.C.R	N.C.R
Antenna Tower	CT	CTERG23	3256	N.C.R	N.C.R
Controller	CT	CT100	95637	N.C.R	N.C.R
Test Software			EZ-EMC		

Conducted Emission					
Name of Equipment	Manufacturer	Model	Serial Number	Calibration Data	Calibration Due
EMI TEST RECEIVER	R&S	ESCI	100781	2017-2-28	2018-2-27
V (V-LISN)	SCHWARZBEC K	NNLK 8129	8129-143	2016-11-1	2017-10-31
TWO-LINE V-NETWORK	R&S	ENV216	101604	2016-11-1	2017-10-31
Pulse LIMITER	R&S	ESH3-Z2	100524	2017-1-5	2018-1-4
Test Software			EZ-EMC		

**Remark:** Each piece of equipment is scheduled for calibration once a year.

## 5.5 SETUP CONFIGURATION

See test photographs attached in Appendix 1 for the actual connections between EUT and support equipment.

## 5.6 SUPPORT EQUIPMENT

No.	Device Type	Brand	Model	Series No.	FCC ID
1.	N/A				

**Remark:**

- 1.All the equipment/cables were placed in the worst-case configuration to maximize the emission during the test.
- 2.Grounding was established in accordance with the manufacturer's requirements and conditions for the intended use.

## 6 FCC PART 15.247 REQUIREMENTS

### 6.1 PEAK POWER

#### Limit of peak output power

The maximum peak output power of the intentional radiator shall not exceed the following:

For systems using digital modulation in the 2400-2483.5MHz, the limit for peak output power is 30dBm. If transmitting antenna of directional gain greater than 6dBi is used, the peak output power from the intentional radiator shall be reduced below the above stated value by the amount in dB that the directional gain of the antenna exceeds 6 dBi. In case of point-to-point operation, the limit has to be reduced by 1dB for every 3dB that the directional gain of the antenna exceeds 6dBi.

#### Test Configuration

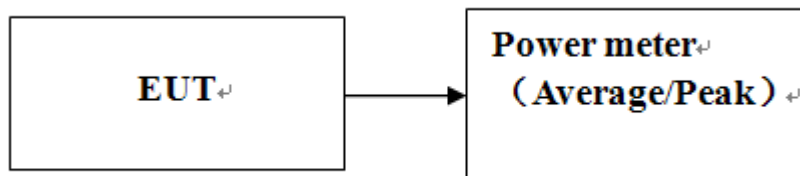

**Remark:** Each piece of equipment is scheduled for calibration once a year.

#### Test Procedure

1. The testing follows the Measurement Procedure of FCC KDB No. 558074 DTS D01 Meas. Guidance v04.
2. The RF output of EUT was connected to the power meter by RF cable and attenuator. The path loss was compensated to the results for each measurement.
3. Set to the maximum power setting and enable the EUT transmit continuously.
4. Measure the conducted output power and record the results in the test report.

**Test Results**

*No non-compliance noted*

**Test RESULTS**

**BLE4.1 GFSK Modulation 1Mbps mode**

<b>Test mode:</b>	Bluetooth LE4.1	<b>Temperature:</b>	23°C
<b>Test By:</b>	Lily.Wang	<b>Test Date:</b>	2017-7-28

Channel	Frequency (MHz)	Transmit Data Rate	Average Output Power (dBm)	Limit (dBm)	Result
00	2402	1Mbps	2.53	30	PASS
19	2440	1Mbps	2.93		PASS
39	2480	1Mbps	2.26		PASS

## 6.2 PEAK POWER SPECTRAL DENSITY

### Limit

The peak power spectral density shall not be greater than 8dBm in any 3kHz band at any time interval of continuous transmission.

### Test Configuration

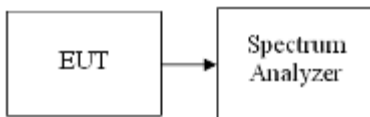

### Test Procedure

1. The testing follows Measurement Procedure 10.2 Method PKPSD of FCC KDB Publication No. 558074 D01 DTS Meas. Guidance v04.
2. The RF output of EUT was connected to the spectrum analyzer by RF cable and attenuator. The path loss was compensated to the results for each measurement.
3. Set to the maximum power setting and enable the EUT transmit continuously.
4. Make the measurement with the spectrum analyzer's resolution bandwidth (RBW) = 3 kHz. Video bandwidth VBW = 10 kHz In order to make an accurate measurement, set the span to 1.5 times DTS Channel Bandwidth. (6dB BW)
5. Detector = peak, Sweep time = auto couple, Trace mode = max hold, Allow trace to fully stabilize. Use the peak marker function to determine the maximum power level.
6. Measure and record the results in the test report.
7. The Measured power density (dBm)/ 100kHz is a reference level and used as 20dBc down limit line for Conducted Band Edges and Conducted Spurious Emission.

### Test Results of power Spectral Density

Test mode:	Bluetooth LE4.1	Temperature:	23°C
Test By:	Lily.Wang	Test Date:	2017-8-3

Channel	Frequency (MHz)	PSD/3kHz (dBm)	Limit (dBm)	Result
00	2402	-3.15	8	PASS
19	2440	-2.42		PASS
39	2480	-3.45		PASS

### Test Plot of power Spectral Density

#### Channel 00

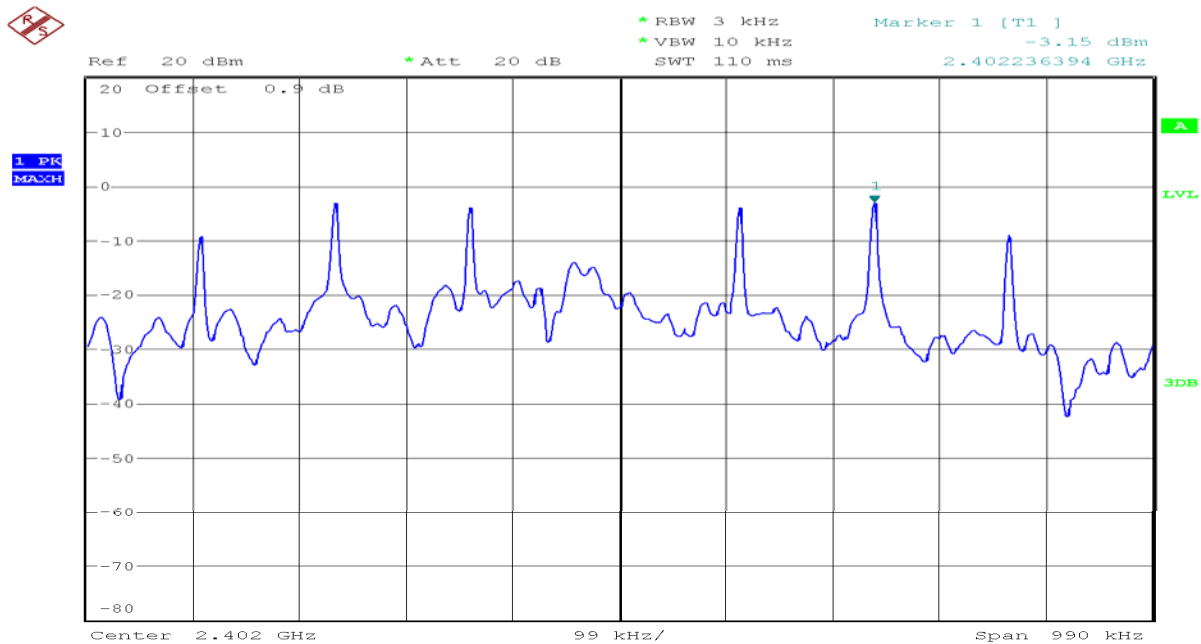

Date: 3.AUG.2017 19:41:34



### Channel 19

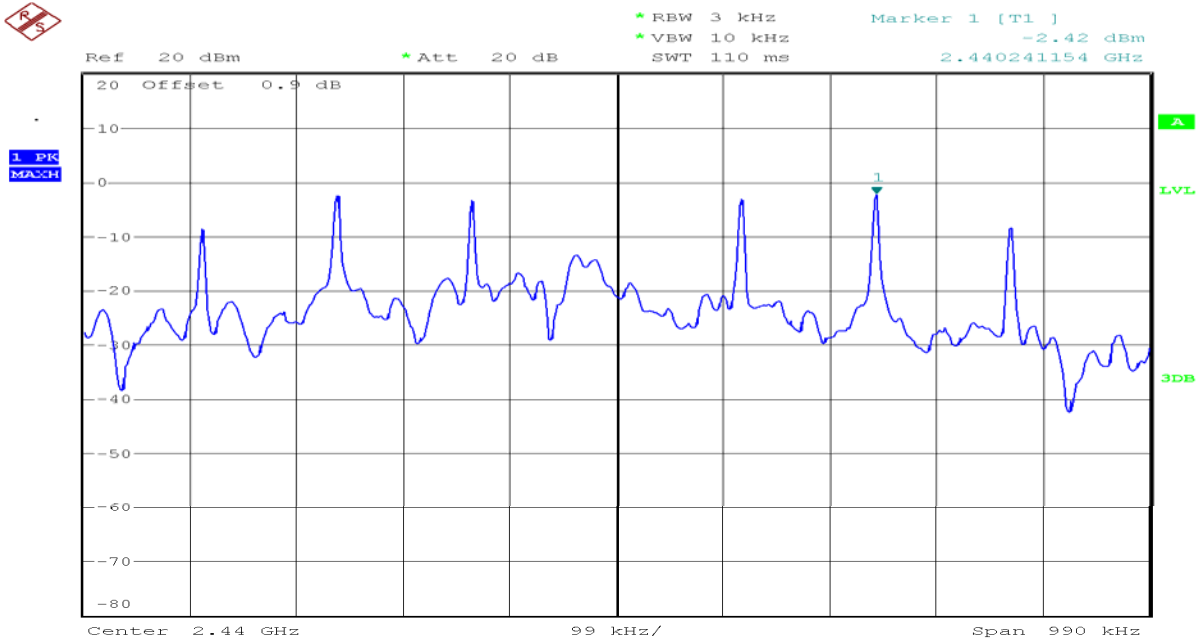

Date: 3.AUG.2017 19:36:07

### Channel 39

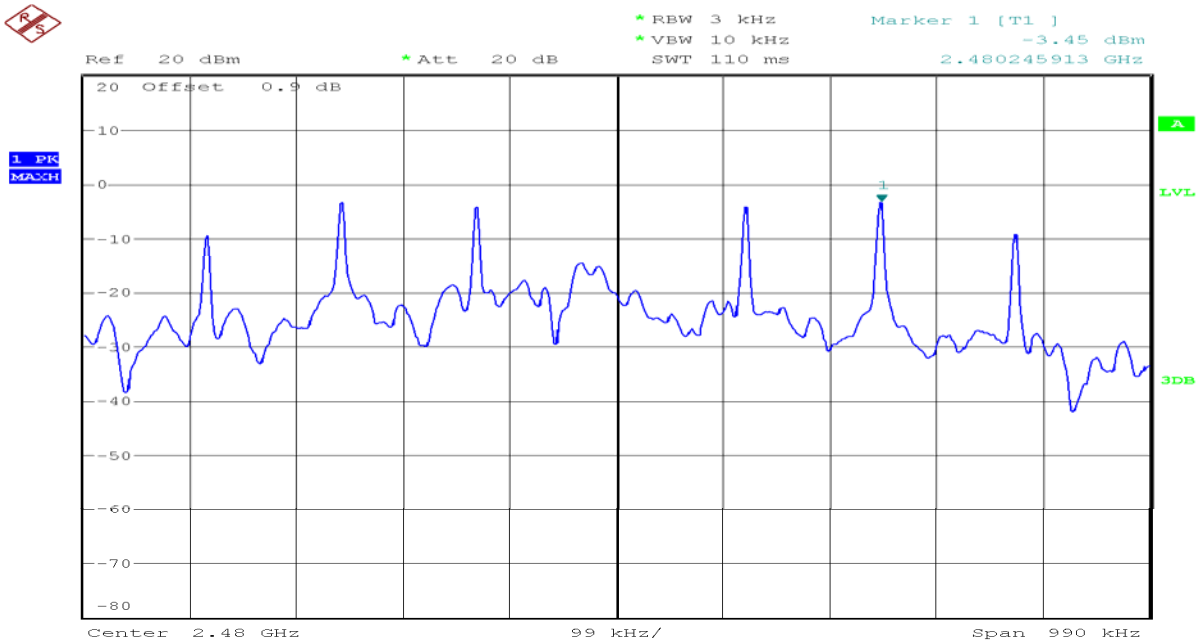

Date: 3.AUG.2017 19:39:02

## 6.3 6dB Bandwidth Measurement

### Limit of 6dB Bandwidth

The minimum 6 dB bandwidth shall be at least 500 kHz.

### Test Configuration

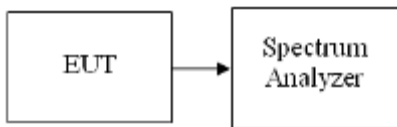

### Test Procedure

1. The testing follows FCC KDB Publication No. 558074 D01 DTS Meas. Guidance v04.
2. The RF output of EUT was connected to the spectrum analyzer by RF cable and attenuator. The path loss was compensated to the results for each measurement.
3. Set to the maximum power setting and enable the EUT transmit continuously.
4. Make the measurement with the spectrum analyzer's resolution bandwidth (RBW) = 100 kHz. Set the Video bandwidth (VBW) = 300 kHz. In order to make an accurate measurement. The 6 dB bandwidth must be greater than 500 kHz.
5. Measure and record the results in the test report.

## Test Results of Bandwidth

No non-compliance noted

<b>Test mode:</b>	Bluetooth LE4.1	<b>Temperature:</b>	23°C
<b>Test By:</b>	Lily.Wang	<b>Test Date:</b>	2017-8-3

Channel	Frequency (MHz)	6dB Bandwidth (MHz)	6dB Bandwidth Limit (MHz)	Result
00	2402	0.66	0.5	Pass
19	2440	0.66	0.5	Pass
39	2480	0.66	0.5	Pass

## Test Plot

### Channel 00

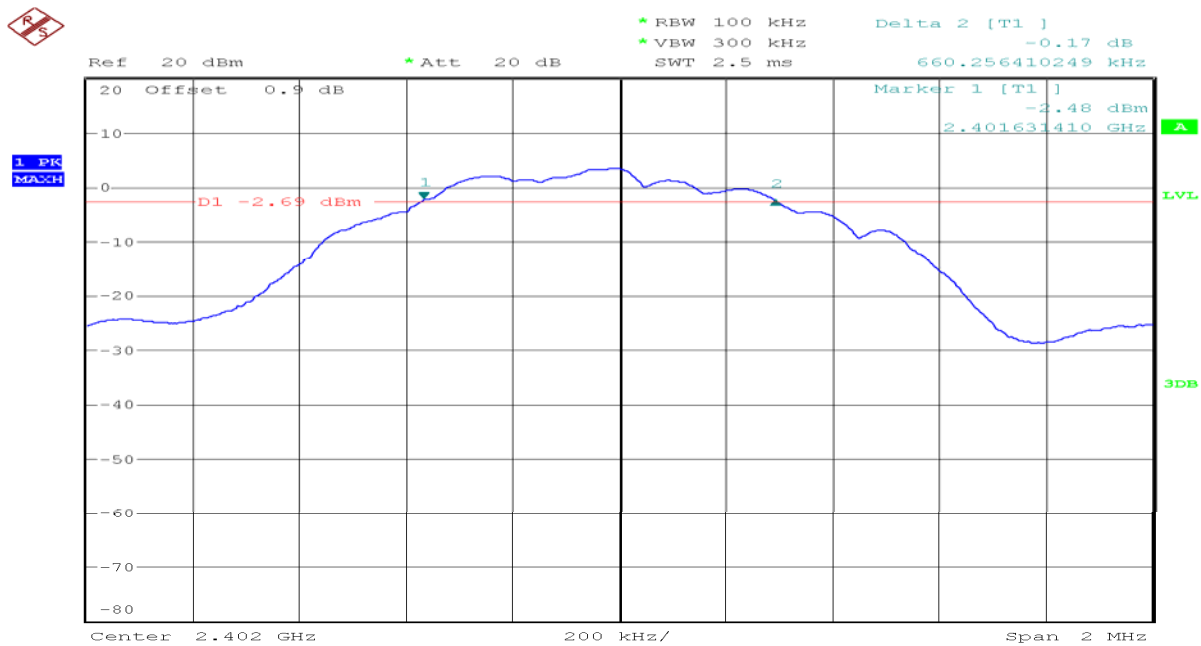

Date: 3.AUG.2017 19:08:58

## Channel 19

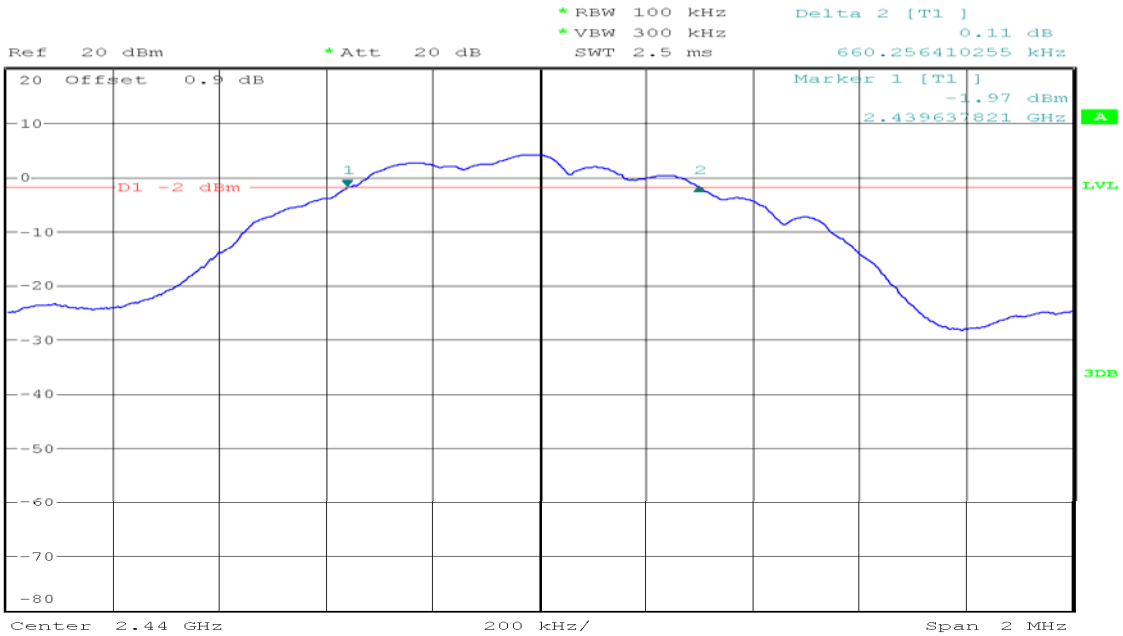

Date: 3.AUG.2017 19:31:09

## Channel 39

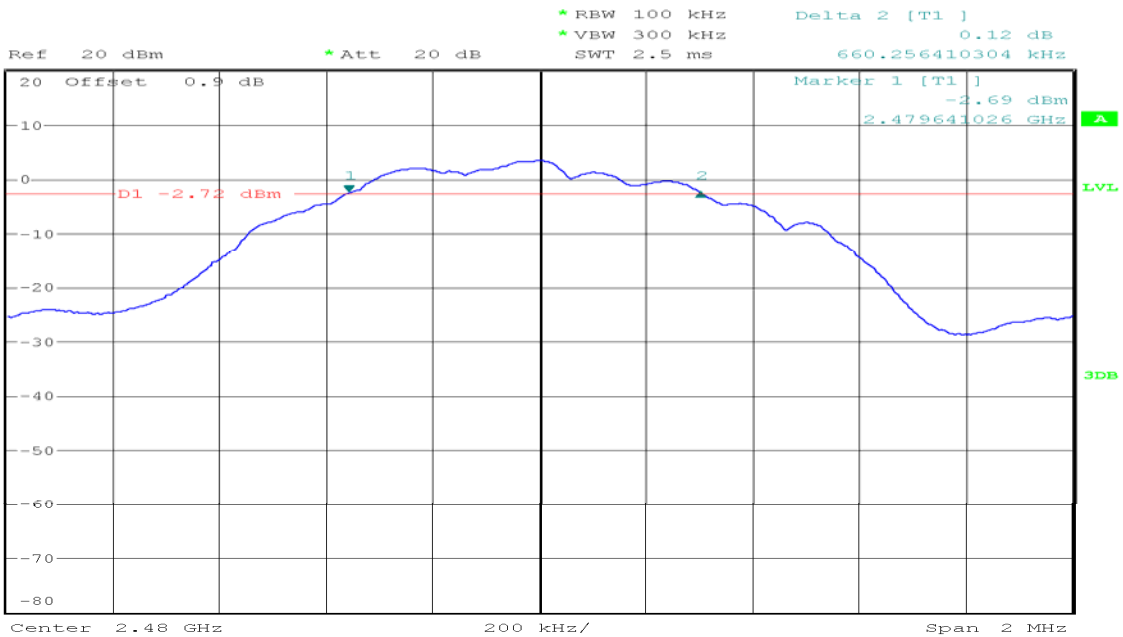

Date: 3.AUG.2017 19:18:15

## 6.4 Conducted Band Edges and Spurious Emission Measurement

### LIMIT

All harmonics/spurious must be at least 20 dB down from the highest emission level within the authorized band.

### Test Configuration

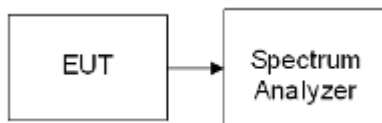

### TEST PROCEDURE

1. The testing follows FCC KDB Publication No. 558074 D01 DTS Meas. Guidance v04.
2. The RF output of EUT was connected to the spectrum analyzer by RF cable and attenuator. The path loss was compensated to the results for each measurement.
3. Set to the maximum power setting and enable the EUT transmit continuously.
4. Set RBW = 100 kHz, VBW=300 kHz, Peak Detector. Unwanted Emissions measured in any 100kHz bandwidth outside of the authorized frequency band shall be attenuated by at least 20 dB relative to the maximum in-band peak PSD level in 100 kHz when maximum peak conducted output power procedure is used. If the transmitter complies with the conducted power limits based on the use of RMS averaging over a time interval, the attenuation required under this paragraph shall be 30 dB instead of 20 dB per 15.247(d).
5. Measure and record the results in the test report.
6. The RF fundamental frequency should be excluded against the limit line in the operating frequency band.

### TEST RESULTS

*No non-compliance noted*

## Test Plot

### OUT-OF-BAND SPURIOUS EMISSIONS-CONDUCTED MEASUREMENT

CH Low

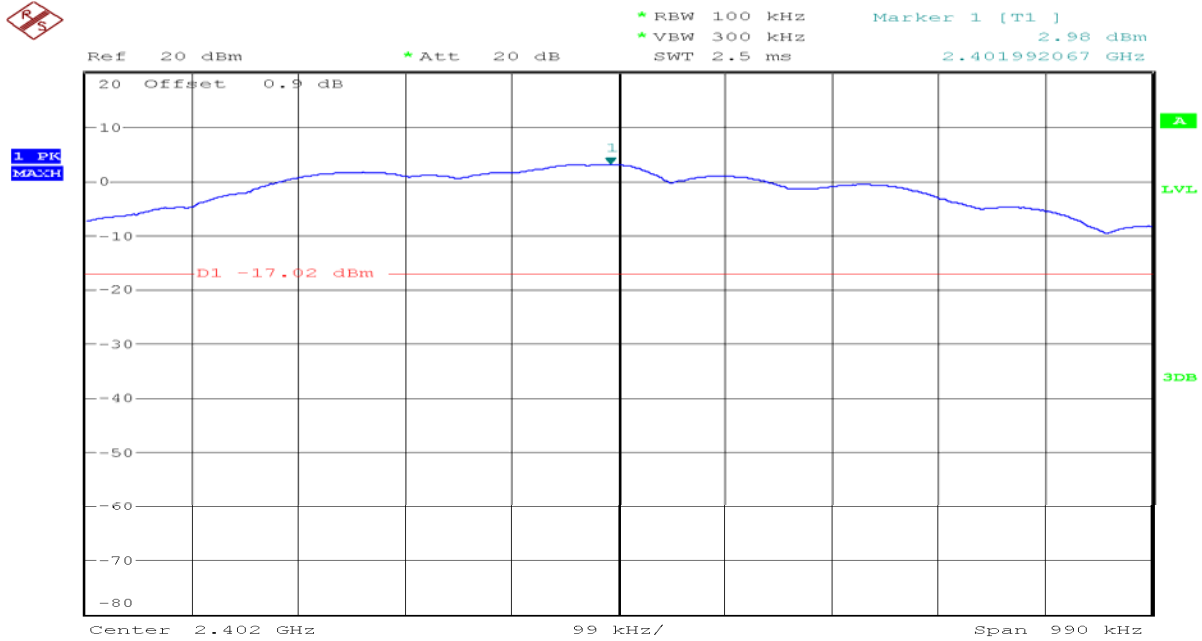

Date: 3.AUG.2017 20:09:06

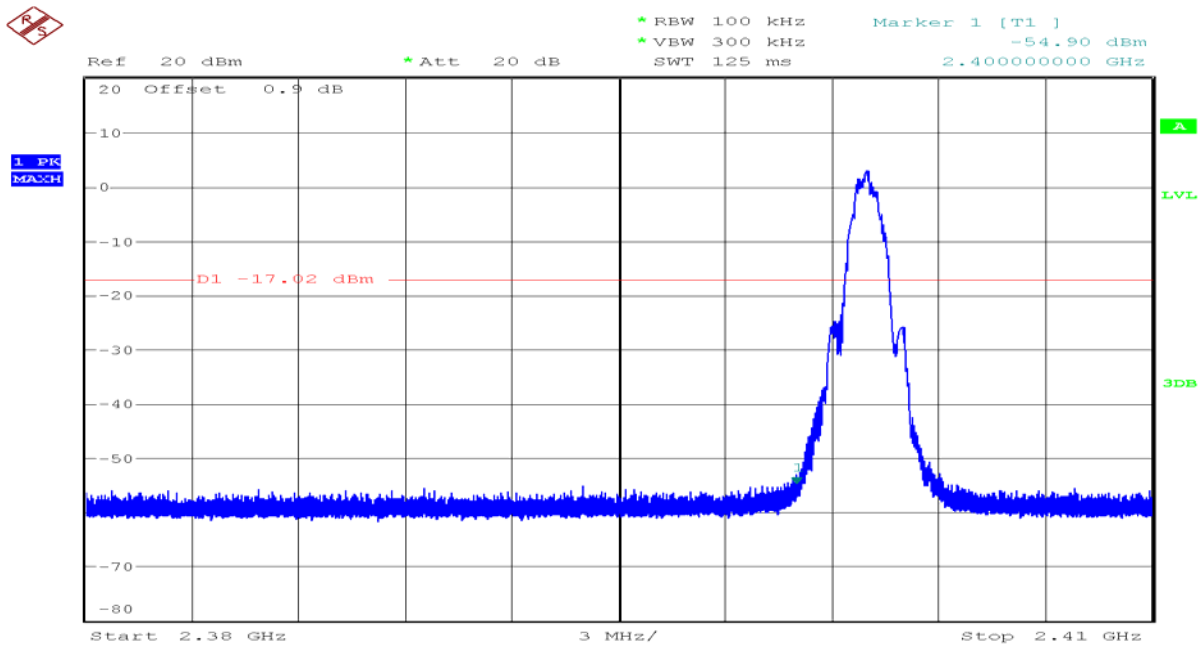

Date: 3.AUG.2017 20:12:57



Ref 20 dBm      \*Att 20 dB      \*RBW 100 kHz      Marker 1 [T1]      -55.56 dBm  
 \*VBW 300 kHz      1.686567000 GHz  
 SWT 300 ms

1 PK  
MATCH

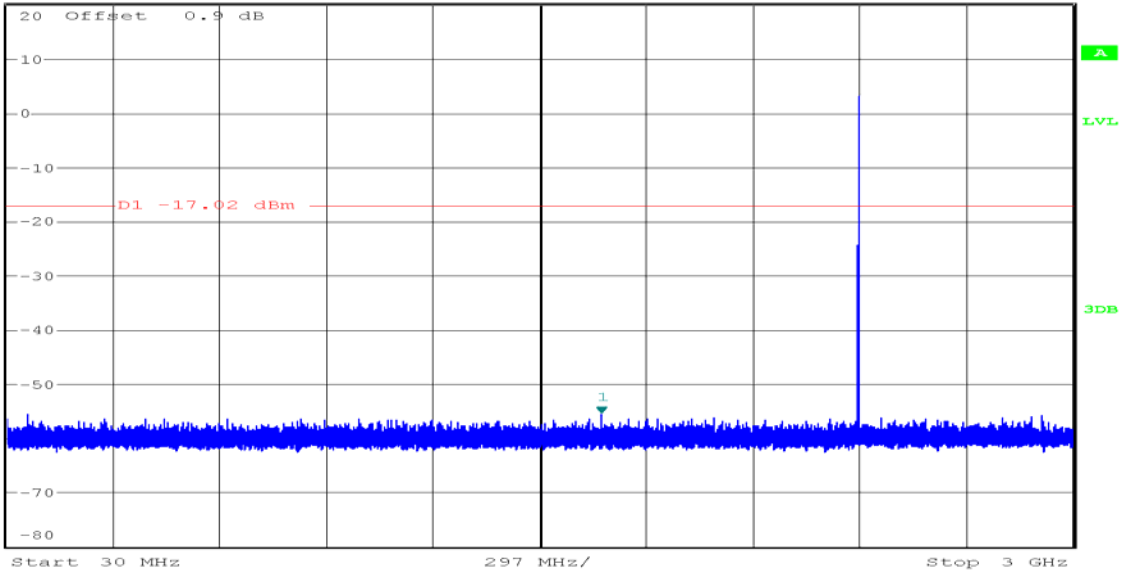

Date: 3.AUG.2017 20:14:56



Ref 20 dBm      \*Att 20 dB      \*RBW 100 kHz      Marker 1 [T1]      -54.76 dBm  
 \*VBW 300 kHz      10.949300000 GHz  
 SWT 2.3 s

1 PK  
MATCH

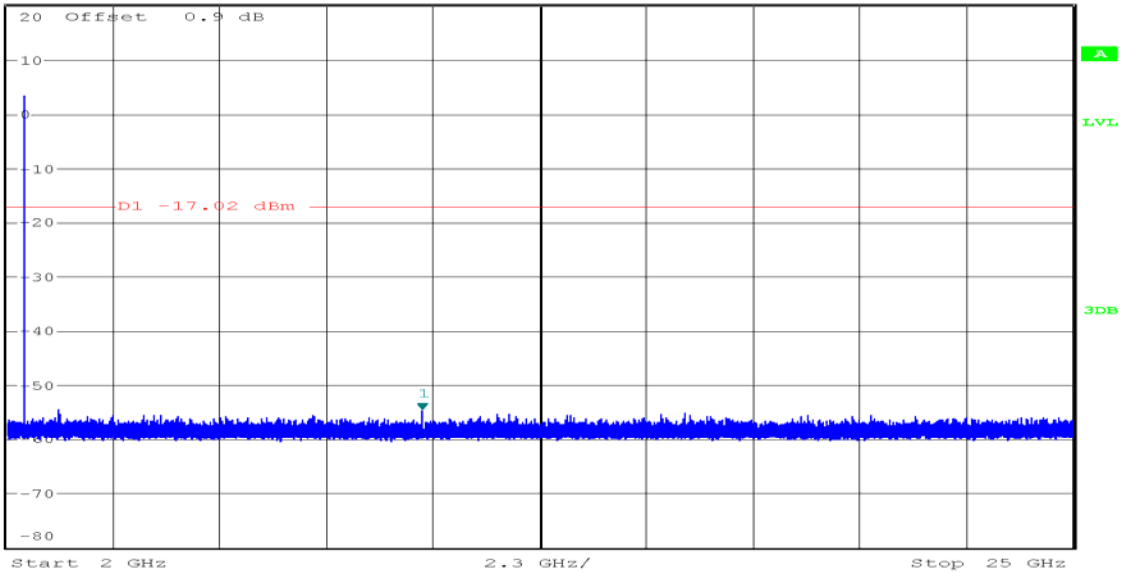

Date: 3.AUG.2017 20:18:35

## CH Mid

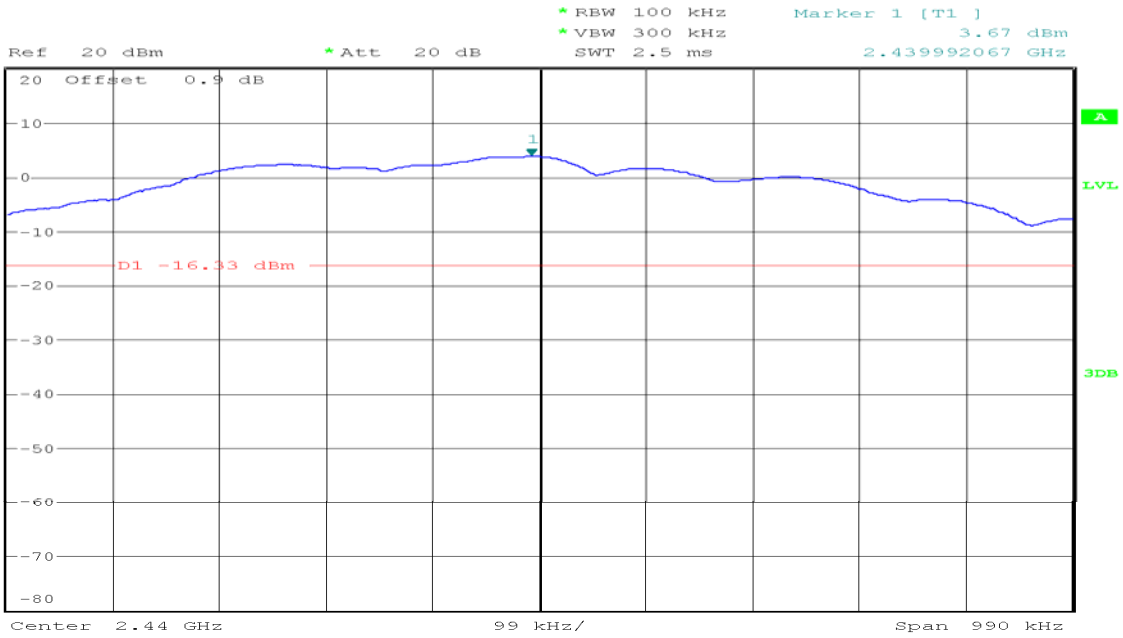

Date: 3.AUG.2017 19:47:53

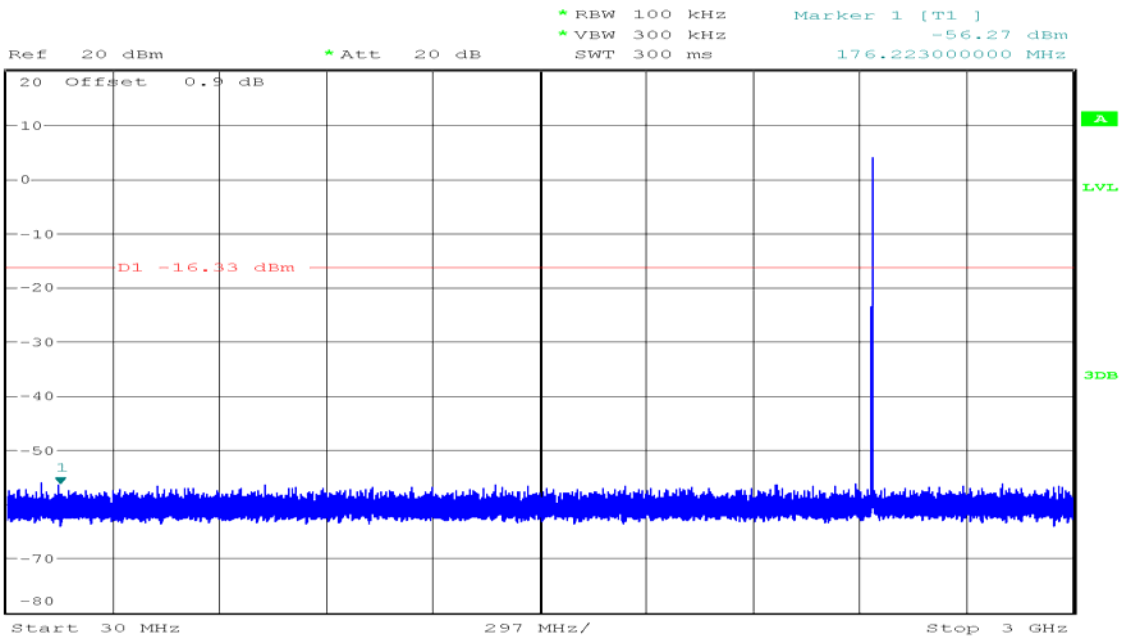

Date: 3.AUG.2017 19:50:00



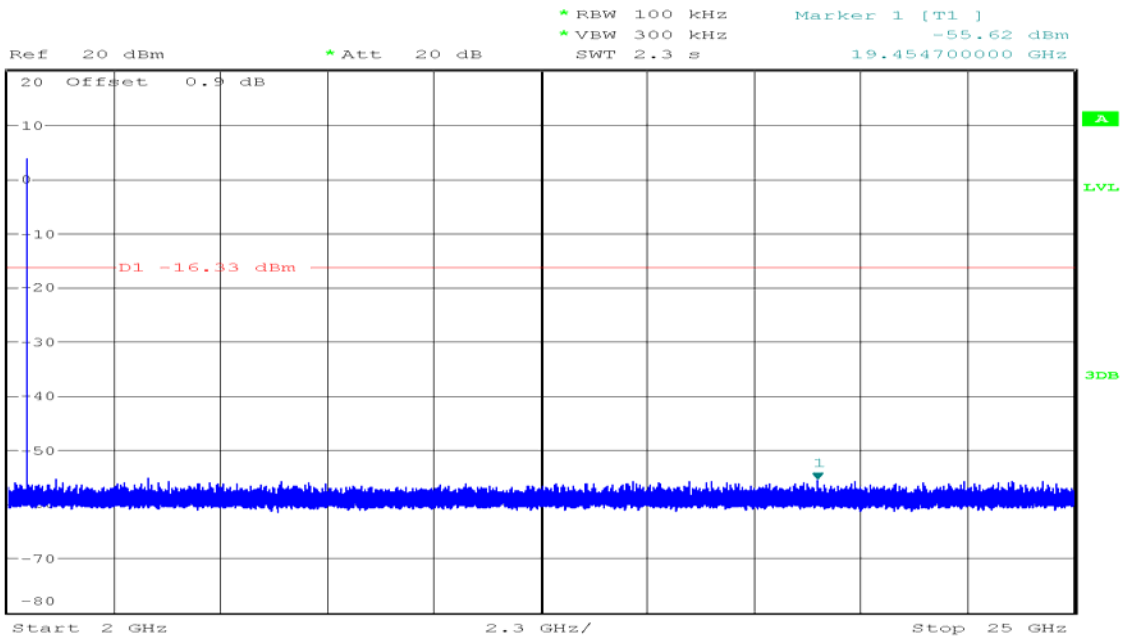

Date: 3.AUG.2017 19:52:21

## CH High

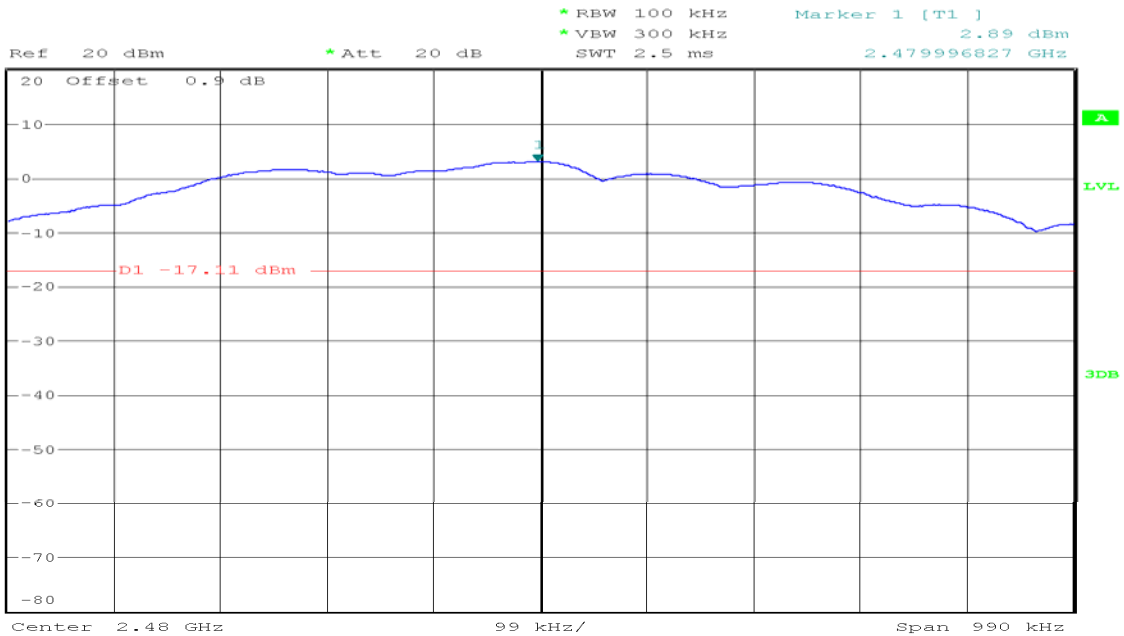

Date: 3.AUG.2017 19:55:08

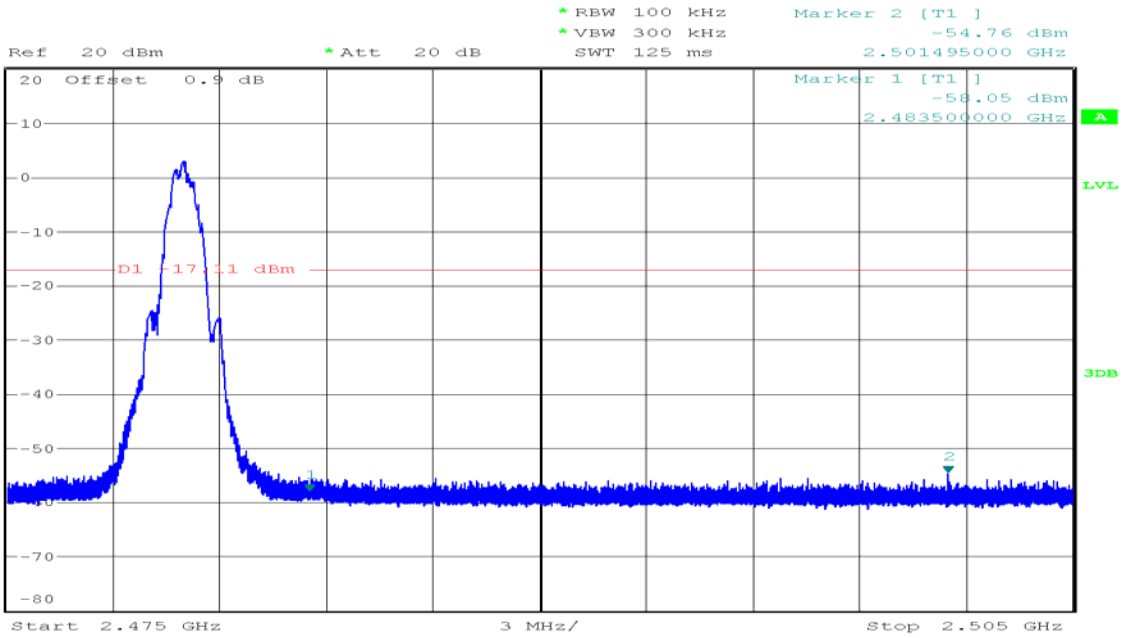

Date: 3.AUG.2017 19:59:09

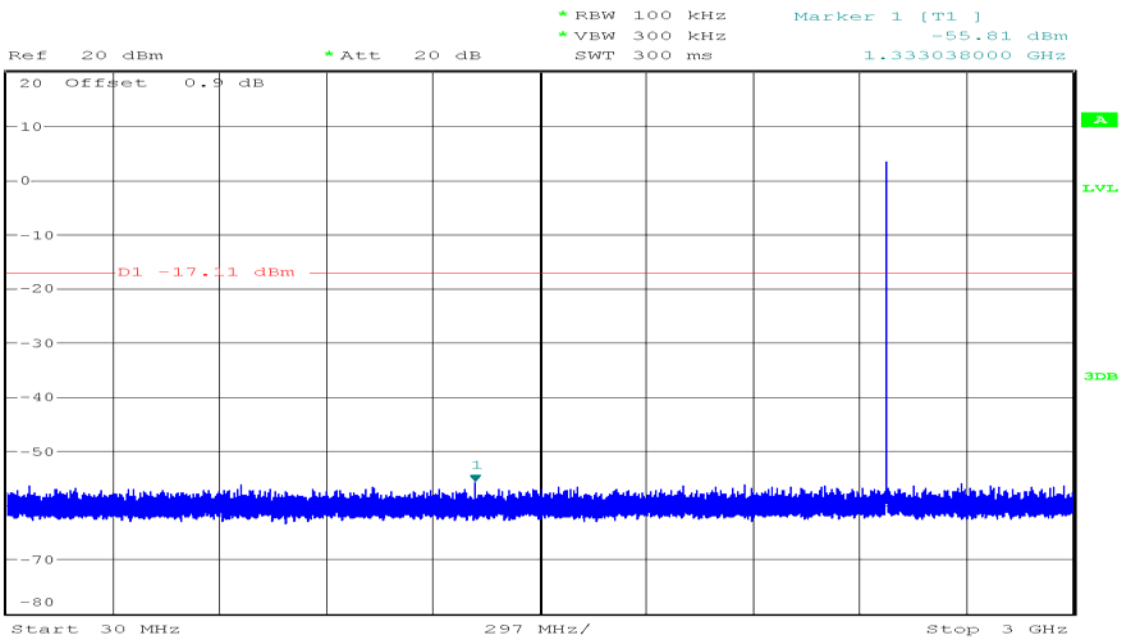

Date: 3.AUG.2017 20:02:43

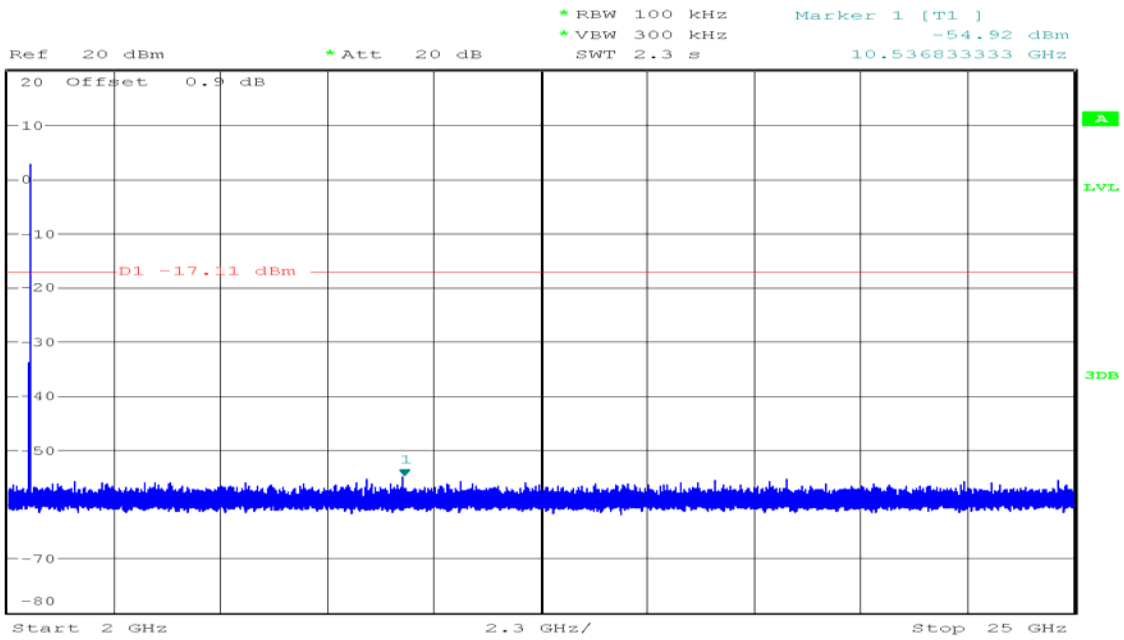

Date: 3.AUG.2017 20:04:53

## 6.5 Radiated Band Edge and Spurious Emission Measurement

### LIMIT

In any 100 kHz bandwidth outside the intentional radiator frequency band, all harmonics/spurious must be at least 20 dB below the highest emission level within the authorized band. If the output power of this device was measured by spectrum analyzer, the attenuation under this paragraph shall be 30 dB instead of 20 dB. In addition, radiated emissions which fall in the restricted bands must also comply with the FCC section 15.209 limits as below.

Frequency (MHz)	Field Strength (mV/m)	Measurement Distance (m)
30-88	100*	3
88-216	150*	3
216-960	200*	3
Above 960	500	3

**Remark:** Except as provided in paragraph (g), fundamental emissions from intentional radiators operating under this Section shall not be located in the frequency bands 54-72 MHz, 76-88 MHz, 174-216 MHz or 470-806 MHz. However, operation within these frequency bands is permitted under other sections of this Part, e.g., Sections 15.231 and 15.241.

1. In the above emission table, the tighter limit applies at the band edges.

Frequency (Hz)	Field Strength ( $\mu$ V/m at 3-meter)	Field Strength (dB $\mu$ V/m at 3-meter)
30-88	100	40
88-216	150	43.5
216-960	200	46
Above 960	500	54

## Test Configuration

### Below 30MHz

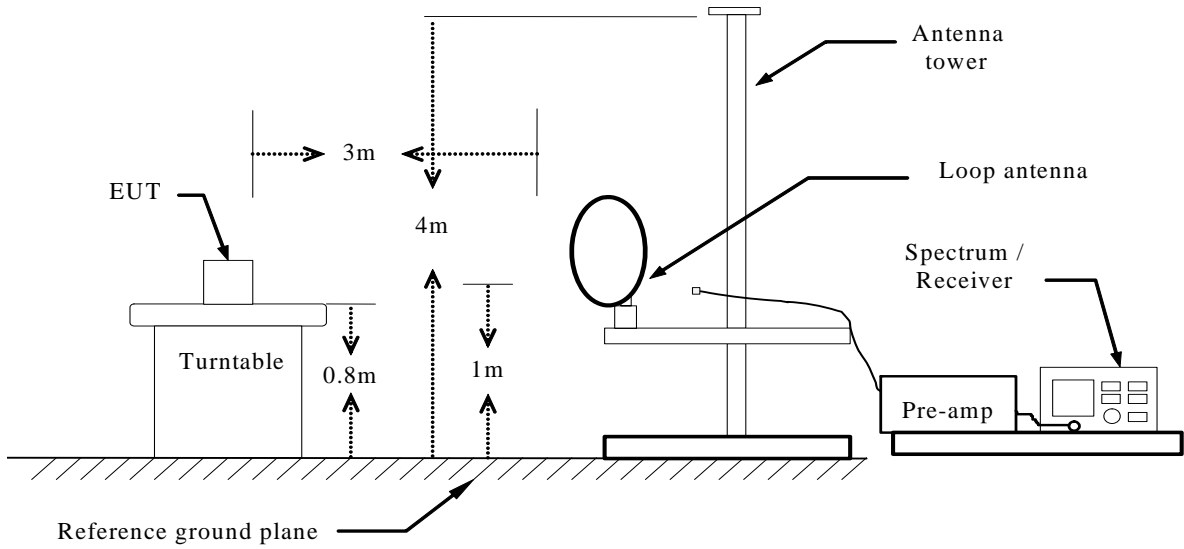

### Below 1 GHz

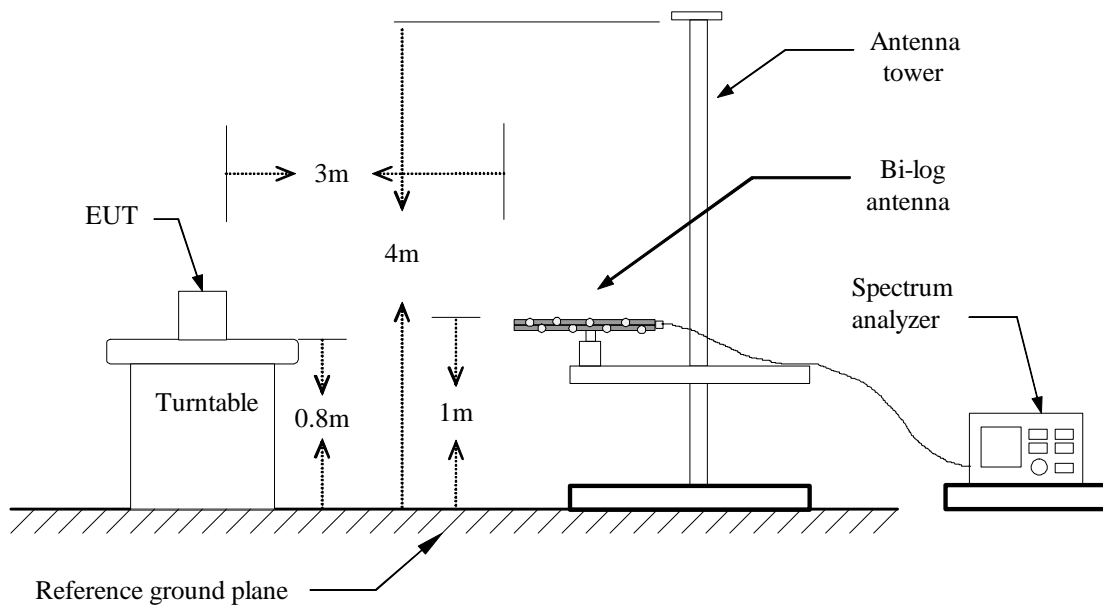

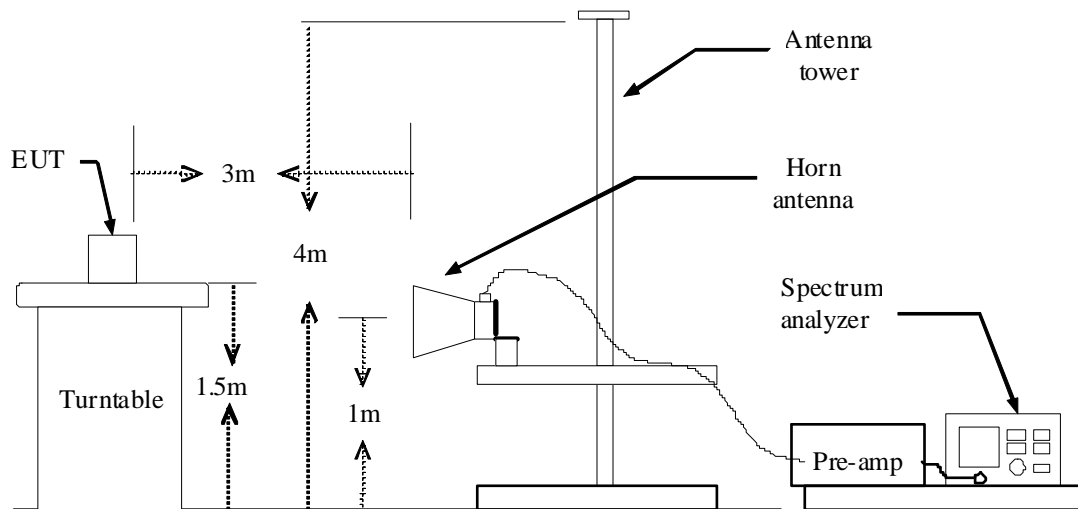
**Above 1 GHz****TEST PROCEDURE**

1. The testing follows FCC KDB Publication No. 558074 D01 DTS Meas. Guidance v04.
  2. The EUT was arranged to its worst case and then tune the antenna tower (from 1 m to 4 m) and turntable (from 0 degree to 360 degrees) to find the maximum reading. A pre-amp and a high pass filter are used for the test in order to get better signal level.
  3. The EUT is placed on a turntable above ground plane, which is 0.8 meter for frequency below 1GHz and 1.5 meter for frequency above 1GHz.
  4. The EUT was set 3 meters from the interference receiving antenna, which was mounted on the top of a variable height antenna tower.
  5. Corrected Reading: Antenna Factor + Cable Loss + Read Level - Preamp Factor = Level
  6. For measurement below 1GHz, If the emission level of the EUT measured by the peak detector is 3 dB lower than the applicable limit, the peak emission level will be reported. Otherwise, the emission measurement will be repeated using the quasi-peak detector and reported.
  7. Use the following spectrum analyzer settings:
    - (1) Span shall wide enough to fully capture the emission being measured;
    - (2) Set RBW=100 kHz for  $f < 1$  GHz; VBW =3 RBW; Sweep = auto; Detector function = peak; Trace = max hold;
    - (3) Set RBW = 1 MHz, VBW= 3MHz for  $f > 1$  GHz for peak measurement.
- For average measurement:
- VBW = 10 Hz, when duty cycle is no less than 98 percent.
  - VBW  $\geq 1/T$ , when duty cycle is less than 98 percent where T is the minimum transmission duration over which the transmitter is on and is transmitting at its maximum power control level for the tested mode of operation.

### RESTRICTED BANDEDGE (BLE4.1 on Channel 0, Horizontal)

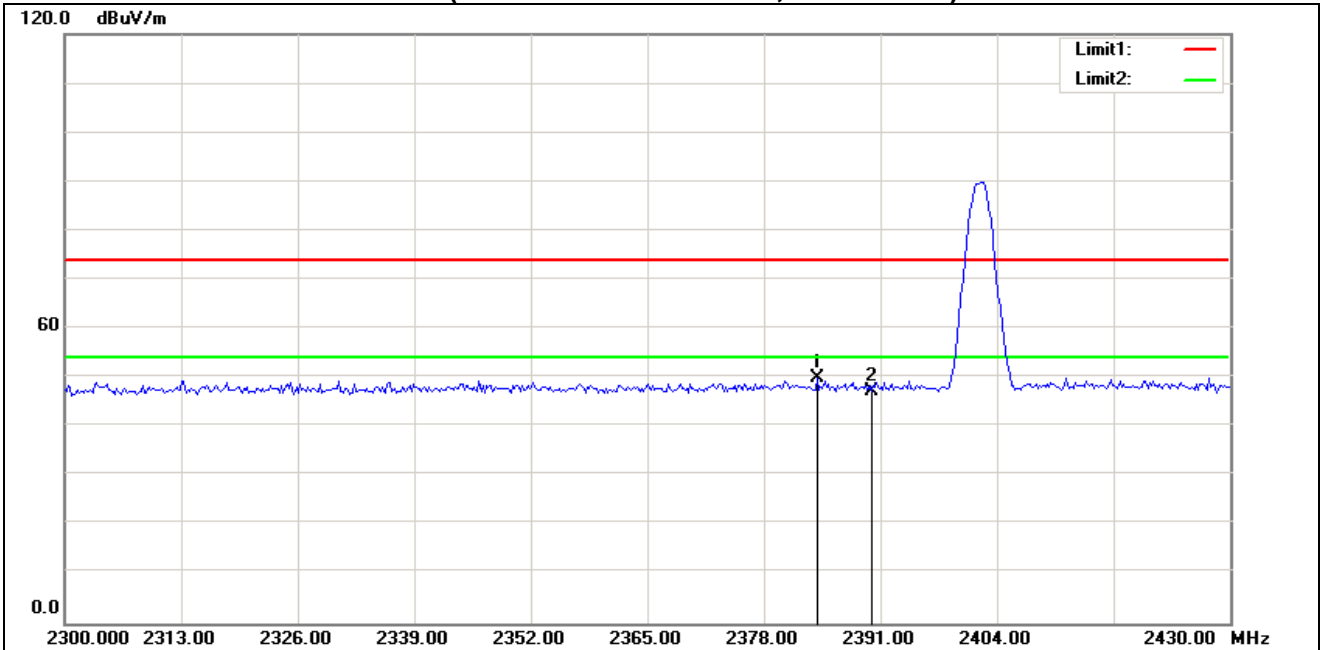

No.	Frequency (MHz)	Reading (dBuV)	Correct Factor(dB/m)	Result (dBuV/m)	Limit (dBuV/m)	Margin (dB)	Height (cm)	Degree (deg.)	Remark
1	2383.958	57.29	-7.37	49.92	74.00	-24.08	100	352	peak
2	2390.000	54.61	-7.31	47.30	74.00	-26.70	100	252	peak

### RESTRICTED BANDEDGE (BLE4.1 on Channel 0, Vertical)

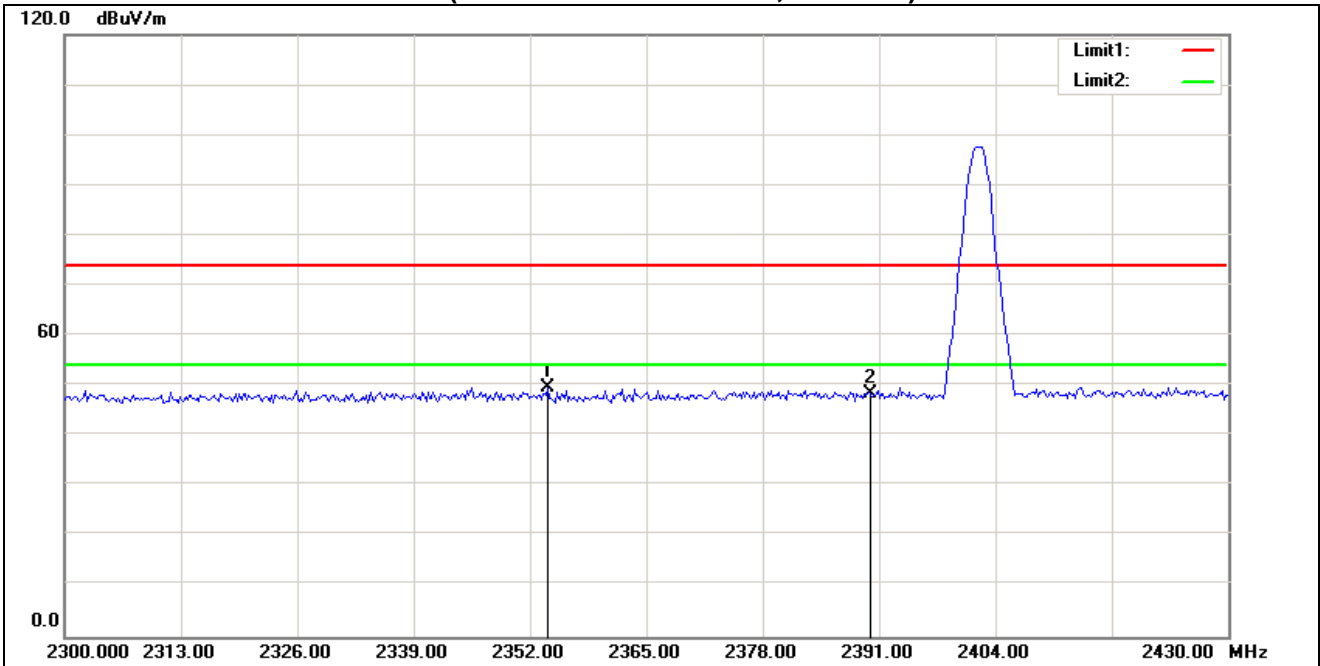

No.	Frequency (MHz)	Reading (dBuV)	Correct Factor(dB/m)	Result (dBuV/m)	Limit (dBuV/m)	Margin (dB)	Height (cm)	Degree (deg.)	Remark
1	2353.958	57.40	-7.65	49.75	74.00	-24.25	100	181	peak
2	2390.000	55.65	-7.31	48.34	74.00	-25.66	100	224	peak

### RESTRICTED BANDEDGE (BLE4.1 on Channel 39, Horizontal)

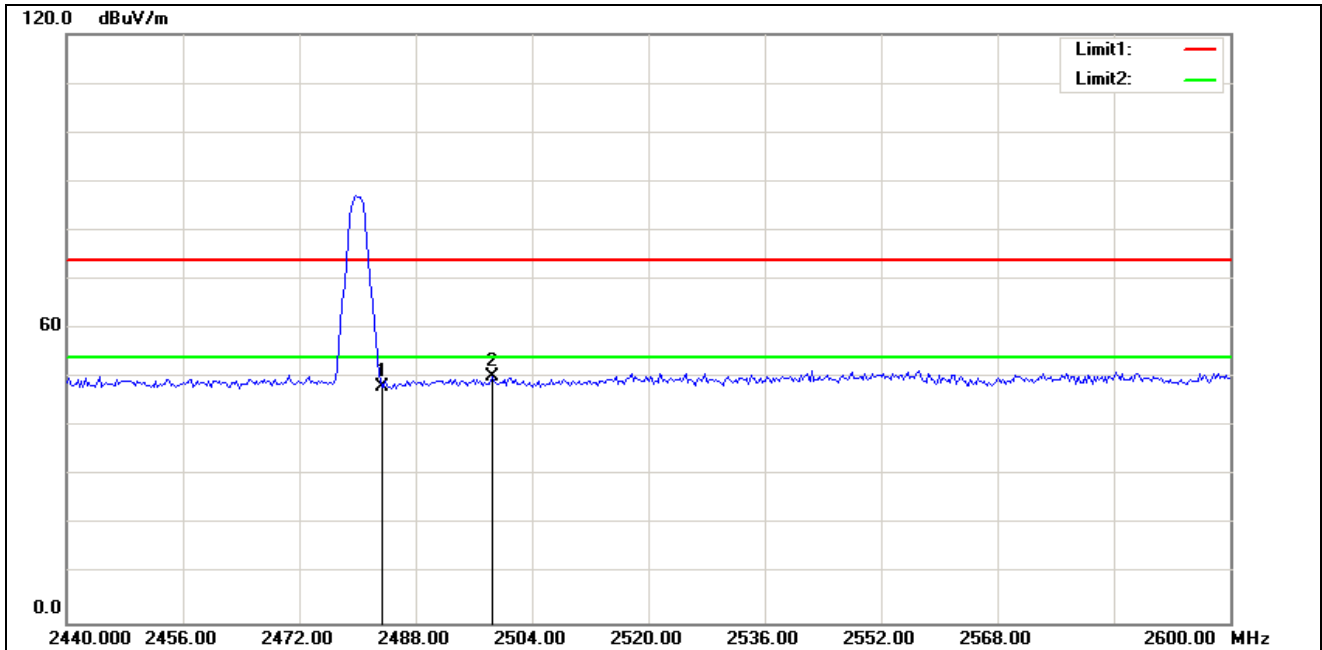

No.	Frequency (MHz)	Reading (dBuV)	Correct Factor(dB/m)	Result (dBuV/m)	Limit (dBuV/m)	Margin (dB)	Height (cm)	Degree (deg.)	Remark
1	2483.500	54.72	-6.44	48.28	74.00	-25.72	100	160	peak
2	2498.461	56.47	-6.30	50.17	74.00	-23.83	100	243	peak

### RESTRICTED BANDEDGE (BLE4.1 on Channel 39, Vertical)

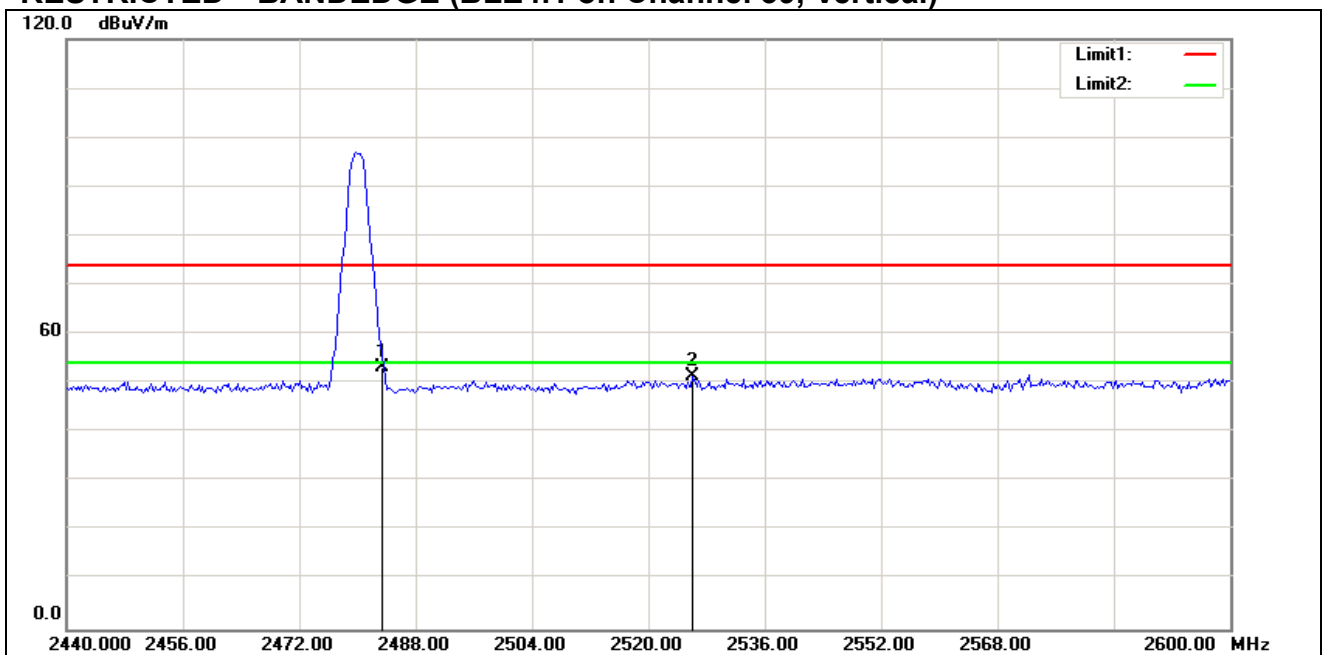

No.	Frequency (MHz)	Reading (dBuV)	Correct Factor(dB/m)	Result (dBuV/m)	Limit (dBuV/m)	Margin (dB)	Height (cm)	Degree (deg.)	Remark
1	2483.500	59.55	-6.44	53.11	74.00	-20.89	100	215	peak
2	2526.154	57.38	-6.05	51.33	74.00	-22.67	100	271	peak



**Test Result of Radiated Emission****Below 30MHz**

The interference of the frequency value is lower than the limit below 20 db, measured as the background noise values and will not be recorded.

**30MHz-1GHz**

<b>Operation Mode:</b>	Normal Link	<b>Test Date:</b>	2017-8-2
<b>Temperature:</b>	25°C	<b>Tested by:</b>	Lily.Wang
<b>Humidity:</b>	48% RH	<b>Polarity:</b>	Ver. / Hor.

Frequency (MHz)	Ant. Pol. (H/V)	Reading (dBuV)	Correction Factor (dB/m)	Result (dBuV/m)	Limit (dBuV/m)	Margin (dB)	Remark
359.8000	V	16.49	17.71	34.20	46.00	-11.80	peak
504.3300	V	15.72	21.61	37.33	46.00	-8.67	peak
656.6200	V	15.24	24.49	39.73	46.00	-6.27	peak
743.9200	V	16.17	26.26	42.43	46.00	-3.57	peak
864.2000	V	15.79	26.09	41.88	46.00	-4.12	peak
967.9900	V	16.10	27.07	43.17	54.00	-10.83	peak
456.8000	H	14.14	21.00	35.14	46.00	-10.86	QP
480.0800	H	13.35	21.32	34.67	46.00	-11.33	QP
504.1100	H	20.00	21.61	41.61	46.00	-4.39	QP
528.5800	H	17.07	21.65	38.72	46.00	-7.28	QP
551.8600	H	14.23	21.71	35.94	46.00	-10.06	QP
600.3600	H	20.94	22.30	43.24	46.00	-2.76	peak

**Notes:**

1. Measurements above show only up to maximum emissions noted, if no specific emissions from the EUT are recorded (ie: margin>20dB from the applicable limit) and considered that's already beyond the background noise floor.
2. Radiated emissions measured in frequency range from 9 KHz to 1000MHz were made with an instrument using Peak detector mode.
3. Data of measurement within this frequency range shown " --- " in the table above means the reading of emissions are attenuated more than 20dB below the permissible limits or the field strength is too small to be measured.
4. The IF bandwidth of SPA between 30MHz to 1GHz was 100kHz.

**Above 1 GHz**

**Operation Mode:** Bluetooth LE4.1      **Test Date:** 2017-8-2  
**Test Channel:** CH00      **Tested by:** Lily.Wang  
**Temperature:** 25°C      **Polarity:** Ver. / Hor.

Frequency (MHz)	Ant. Pol. (H/V)	Reading (dBuV)	Correction Factor (dB/m)	Result (dBuV/m)	Limit (dBuV/m)	Margin (dB)	Remark
4638.000	V	43.84	-5.40	38.44	74.00	-35.56	PEAK
7953.000	V	44.05	6.97	51.02	74.00	-22.98	PEAK
4621.000	H	42.84	-5.42	37.42	74.00	-36.58	PEAK
8055.000	H	42.99	7.01	50.00	74.00	-24.00	PEAK

**Operation Mode:** Bluetooth LE4.1      **Test Date:** 2017-8-2  
**Test Channel:** CH19      **Tested by:** Lily.Wang  
**Temperature:** 25°C      **Polarity:** Ver. / Hor.

Frequency (MHz)	Ant. Pol. (H/V)	Reading (dBuV)	Correction Factor (dB/m)	Result (dBuV/m)	Limit (dBuV/m)	Margin (dB)	Remark
4978.000	V	42.89	-5.13	37.76	74.00	-36.24	PEAK
8548.000	V	42.89	6.98	49.87	74.00	-24.13	PEAK
5029.000	H	42.77	-4.97	37.80	74.00	-36.20	PEAK
8514.000	H	42.50	6.98	49.48	74.00	-24.52	PEAK

**Operation Mode:** Bluetooth LE4.1      **Test Date:** 2017-8-2  
**Test Channel:** CH39      **Tested by:** Lily.Wang  
**Temperature:** 25°C      **Polarity:** Ver. / Hor.

Frequency (MHz)	Ant. Pol. (H/V)	Reading (dBuV)	Correction Factor (dB/m)	Result (dBuV/m)	Limit (dBuV/m)	Margin (dB)	Remark
5233.000	V	43.89	-4.00	39.89	74.00	-34.11	PEAK
8786.000	V	42.99	6.97	49.96	74.00	-24.04	PEAK
5165.000	H	43.62	-4.32	39.30	74.00	-34.70	PEAK
8616.000	H	43.07	6.98	50.05	74.00	-23.95	PEAK

## 6.6 POWERLINE CONDUCTED EMISSIONS

### LIMIT

For an intentional radiator which is designed to be connected to the public utility (AC) power line, the radio frequency voltage that is conducted back onto the AC power line on any frequency or frequencies within the band 150 kHz to 30 MHz shall not exceed 250 microvolts (The limit decreases linearly with the logarithm of the frequency in the range 0.15 MHz to 0.50 MHz). The limits at specific frequency range is listed as follows:

Frequency Range (MHz)	Limits (dB $\mu$ V)	
	Quasi-peak	Average
0.15 to 0.50	66 to 56	56 to 46
0.50 to 5	56	46
5 to 30	60	50

Compliance with this provision shall be based on the measurement of the radio frequency voltage between each power line (LINE and NEUTRAL) and ground at the power terminals.

### Test Configuration

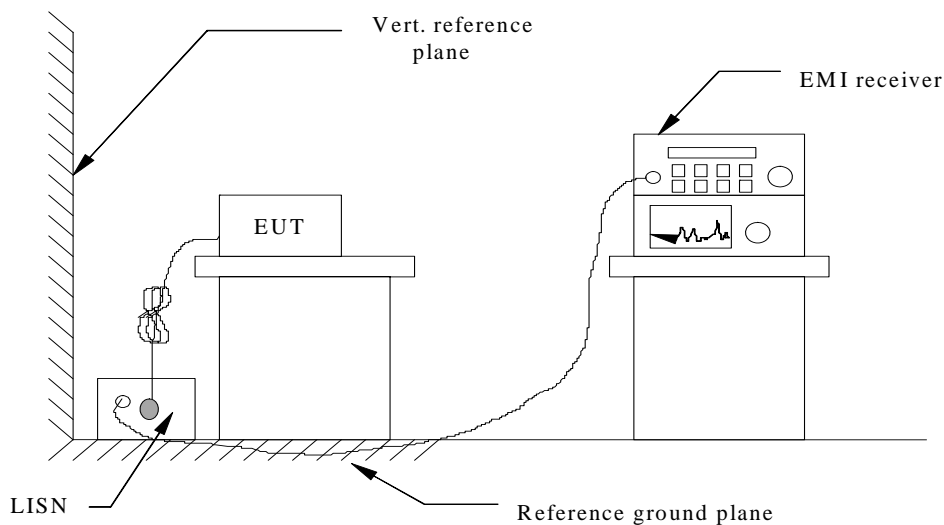

See test photographs attached in Appendix 1 for the actual connections between EUT and support equipment.

### TEST PROCEDURE

1. The EUT was placed on a table, which is 0.8m above ground plane.
2. Maximum procedure was performed on the six highest emissions to ensure EUT compliance.
3. Repeat above procedures until all frequency measured were complete.

### TEST RESULTS

The initial step in collecting conducted data is a spectrum analyzer peak scan of the measurement range. Significant peaks are then marked as shown on the following data page, and these signals are then quasi-peaked.

### Test Data

Job No.:	C170630R01	Date:	2017-7-22
Model No.:	YVR.1017	Time:	8:56:17
Standard:	FCC Class B	Temp.(C)/Hum.(%):	22(C)/48%
Test item:	Conduction test	Test By:	Lily.Wang
Line:	L1	Test Voltage:	AC 120V/60Hz
Model:		Description:	

L1

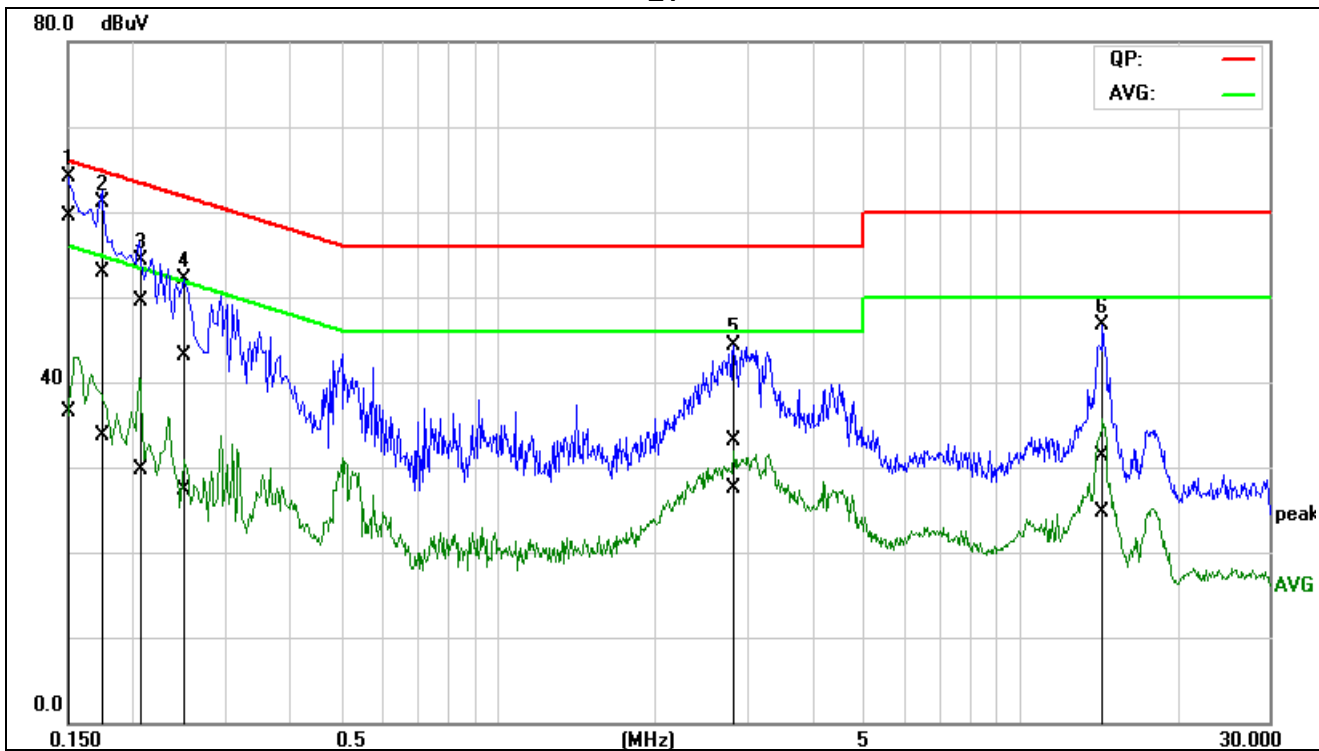

No.	Frequency (MHz)	QuasiPeak reading (dBuV)	Average reading (dBuV)	Correction factor (dB)	QuasiPeak result (dBuV)	Average result (dBuV)	QuasiPeak limit (dBuV)	Average limit (dBuV)	QuasiPeak margin (dB)	Average margin (dB)	Remark
1*	0.1515	38.92	15.92	20.59	59.51	36.51	65.92	55.92	-6.41	-19.41	Pass
2	0.1767	32.34	13.11	20.55	52.89	33.66	64.64	54.64	-11.75	-20.98	Pass
3	0.2088	28.96	9.22	20.50	49.46	29.72	63.25	53.25	-13.79	-23.53	Pass
4	0.2505	22.61	6.86	20.44	43.05	27.30	61.74	51.74	-18.69	-24.44	Pass
5	2.8211	12.66	7.08	20.51	33.17	27.59	56.00	46.00	-22.83	-18.41	Pass
6	14.4032	10.53	3.93	20.79	31.32	24.72	60.00	50.00	-28.68	-25.28	Pass

**Note:** 1. L1 = Line One (Live Line) / L2 = Line Two (Neutral Line).

Job No.:	C170630R01	Date:	2017-7-22
Model No.:	YVR.1017	Time:	9:01:08
Standard:	FCC Class B	Temp.(C)/Hum.(%):	22(C)/48%
Test item:	Conduction test	Test By:	Lily.Wang
Line:	L2	Test Voltage:	AC 120V/60Hz
Model:		Description:	

### L2

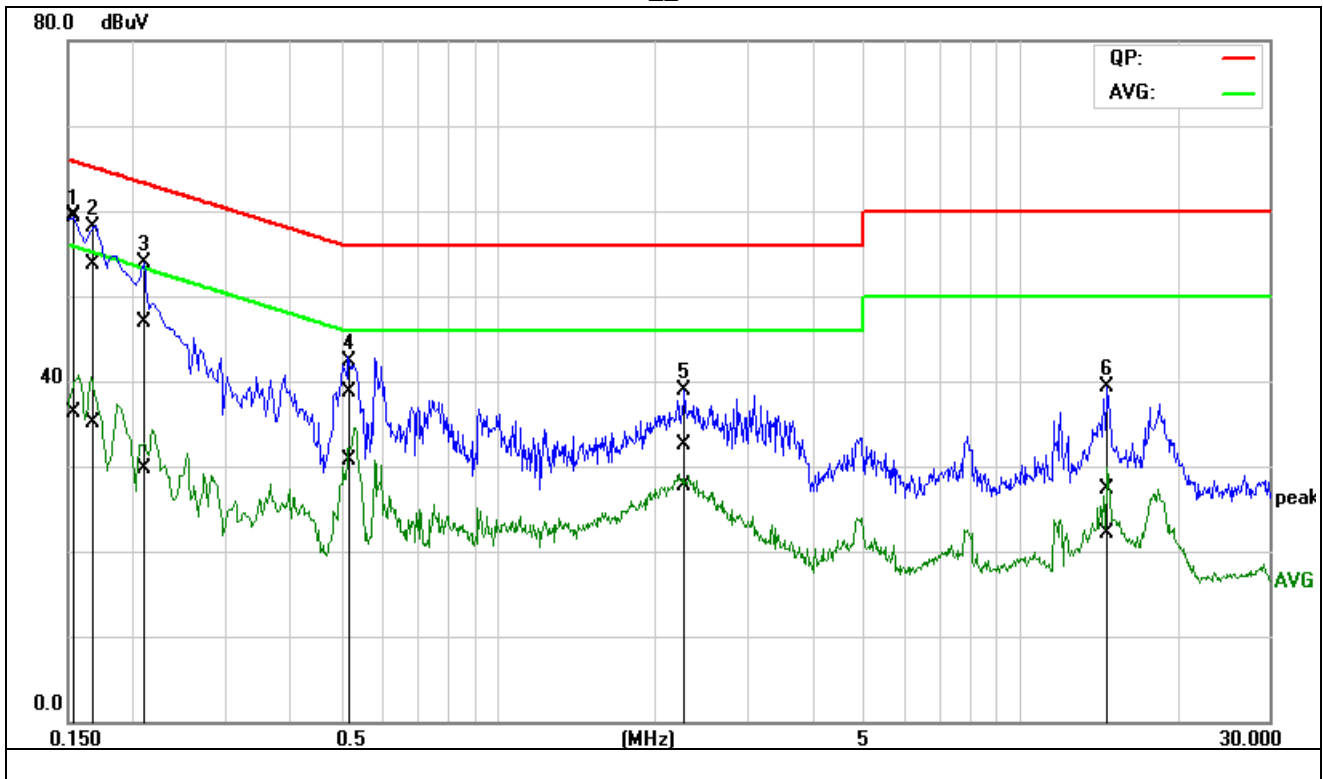

No.	Frequency (MHz)	QuasiPeak reading (dBuV)	Average reading (dBuV)	Correction factor (dB)	QuasiPeak result (dBuV)	Average result (dBuV)	QuasiPeak limit (dBuV)	Average limit (dBuV)	QuasiPeak margin (dB)	Average margin (dB)	Remark
1*	0.1500	39.15	15.86	20.36	59.51	36.22	66.00	56.00	-6.49	-19.78	Pass
2	0.1652	33.41	14.72	20.37	53.78	35.09	65.20	55.20	-11.42	-20.11	Pass
3	0.2079	26.41	9.29	20.41	46.82	29.70	63.29	53.29	-16.47	-23.59	Pass
4	0.5232	18.20	10.21	20.45	38.65	30.66	56.00	46.00	-17.35	-15.34	Pass
5	2.2806	11.99	7.11	20.55	32.54	27.66	56.00	46.00	-23.46	-18.34	Pass
6	14.7296	6.52	1.25	20.81	27.33	22.06	60.00	50.00	-32.67	-27.94	Pass

**Note:** 1. L1 = Line One (Live Line) / L2 = Line Two (Neutral Line).

Remark:

- The measuring frequencies range between 0.15 MHz and 30 MHz.
- The emissions measured in the frequency range between 0.15 MHz and 30MHz were made with an instrument using Quasi-peak detector and Average detector.
- “—” denotes the emission level was or more than 2dB below the Average limit, and no re-check was made.
- The IF bandwidth of SPA between 0.15MHz and 30MHz was 10KHz. The IF bandwidth of Test Receiver between 0.15MHz and 30MHz was 9kHz.

**END OF REPORT**