

# FCC 47 CFR PART 15 SUBPART C

## TEST REPORT

For

Product Name: YI Dome Camera

Brand Name: YI

Model No.: YHS.1916

Series Model.: N/A

FCC ID: 2AFIB-YHS1916

Test Report Number:

C160628R01-RPW

Issued for

Shanghai Xiaoyi Technology Co., Ltd.

6F,Building E,No.2889,Jinke Road,Shanghai,China

Issued by

Compliance Certification Services Inc.

Kun shan Laboratory

No.10 Weiye Rd., Innovation park, Eco&Tec,  
Development Zone, Kunshan City, Jiangsu, China

TEL: 86-512-57355888

FAX: 86-512-57370818



TESTING CERT #2541.01

**Note:** This report shall not be reproduced except in full, without the written approval of Compliance Certification Services Inc. This document may be altered or revised by Compliance Certification Services Inc. personnel only, and shall be noted in the revision section of the document. The client should not use it to claim product endorsement by A2LA or any government agencies. The test results in the report only apply to the tested sample.

## TABLE OF CONTENTS

<b>1.</b>	<b>TEST RESULT CERTIFICATION.....</b>	<b>4</b>
<b>2.</b>	<b>EUT DESCRIPTION.....</b>	<b>5</b>
<b>3.</b>	<b>TEST METHODOLOGY .....</b>	<b>6</b>
3.1.	EUT CONFIGURATION .....	6
3.2.	EUT EXERCISE .....	6
3.3.	GENERAL TEST PROCEDURES.....	6
3.4.	FCC PART 15.205 RESTRICTED BANDS OF OPERATIONS.....	7
3.5.	DESCRIPTION OF TEST MODES.....	8
3.6.	ANTENNA DESCRIPTION .....	8
<b>4.</b>	<b>INSTRUMENT CALIBRATION.....</b>	<b>9</b>
4.1.	MEASURING INSTRUMENT CALIBRATION .....	9
<b>5.</b>	<b>FACILITIES AND ACCREDITATIONS .....</b>	<b>11</b>
5.1.	FACILITIES .....	11
5.2.	EQUIPMENT.....	11
5.3.	LABORATORY ACCREDITATIONS AND LISTING .....	11
5.4.	TABLE OF ACCREDITATIONS AND LISTINGS .....	12
<b>6.</b>	<b>SETUP OF EQUIPMENT UNDER TEST.....</b>	<b>13</b>
6.1.	SETUP CONFIGURATION OF EUT.....	13
6.2.	SUPPORT EQUIPMENT.....	13
<b>7.</b>	<b>FCC PART 15.247 REQUIREMENTS.....</b>	<b>14</b>
7.1.	6DB BANDWIDTH .....	14
7.2.	PEAK POWER .....	21
7.3.	PEAK POWER SPECTRAL DENSITY .....	23
7.4.	SPURIOUS EMISSIONS .....	31
7.5.	RADIATED EMISSIONS.....	54
7.6.	POWERLINE CONDUCTED EMISSIONS .....	72



### Revision History

Rev.	Issue Date	Report NO.	Effect Page	Contents
00	July 26, 2016	C160628R01-RPW	ALL	N/A

### 1. TEST RESULT CERTIFICATION

<b>Product Name:</b>	YI Dome Camera
<b>Trade Name:</b>	YI
<b>Model Name.:</b>	YHS.1916
<b>Series Model:</b>	N/A
<b>Applicant Discrepancy:</b>	Initial
<b>Device Category:</b>	Mobile unit
<b>Date of Test:</b>	July 14, 2016 ~ July 25, 2016
<b>Applicant:</b>	<b>Shanghai Xiaoyi Technology Co., Ltd.</b> 6F,Building E,No.2889,Jinke Road,Shanghai,China
<b>Manufacturer:</b>	<b>Shanghai Xiaoyi Technology Co., Ltd.</b> 6F,Building E,No.2889,Jinke Road,Shanghai,China
<b>Application Type:</b>	Certification

APPLICABLE STANDARDS	
STANDARD	TEST RESULT
FCC 47 CFR Part 15 Subpart C	No non-compliance noted

**We hereby certify that:**

The above equipment was tested by Compliance Certification Services Inc. The test data, data evaluation, test procedures, and equipment configurations shown in this report were made in accordance with the procedures given in ANSI C63.10: 2013 and the energy emitted by the sample EUT tested as described in this report is in compliance with the requirements of FCC Rules Part 15.207, 15.209, 15.247.

The test results of this report relate only to the tested sample EUT identified in this report.

**Approved by:**

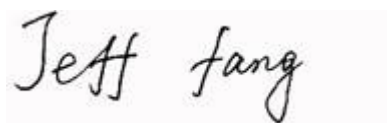

Jeff.Fang  
RF Manager  
Compliance Certification Service Inc.

**Tested by:**

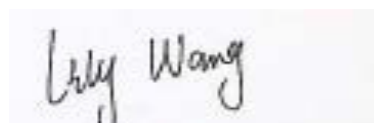

Lily.Wang  
Test Engineer  
Compliance Certification Service Inc.

## 2. EUT DESCRIPTION

<b>Product Name:</b>	YI Dome Camera
<b>Brand Name:</b>	YI
<b>Model Name:</b>	YHS.1916
<b>Series Model:</b>	N/A
<b>Model Discrepancy:</b>	N/A
<b>Power Adapter:</b>	For SUN-0500300 Model:A8-501000 INPUT: 100-240V~50/60Hz 0.2A Max OUTPUT : 5 V $\overline{\overline{=}}$ 1.0A
<b>Frequency Range:</b>	IEEE 802.11b/g: 2412MHz to 2462 MHz IEEE 802.11n HT20: 2412MHz to 2462 MHz IEEE 802.11n HT40: 2422MHz to 2452 MHz
<b>Transmit Power:</b>	IEEE 802.11b mode: 20.41dBm IEEE 802.11g mode: 17.24 dBm IEEE 802.11n HT20 mode: 16.97 dBm IEEE 802.11n HT40 mode: 16.51 dBm
<b>Modulation Technique:</b>	IEEE802.11b mode: DSSS (1,2,5.5 and 11 Mbps) IEEE802.11g mode: DSSS /OFDM (6,9,12,18,24,36,48 and 54 Mbps) IEEE802.11n HT20 mode: OFDM (MCS0~MCS7) IEEE802.11n HT40 mode: OFDM (MCS0~MCS7)
<b>Number of Channels:</b>	IEEE 802.11b/g mode: 11 Channels IEEE 802.11n HT20 : 11 Channels IEEE 802.11n HT40 : 9 Channels
<b>Antenna Specification:</b>	PIFA Antenna Gain: 2.45 dBi

### Remark:

1.The sample selected for test was engineering sample that approximated to production product and was provided by manufacturer.

2.This submittal(s) (test report) is intended for **FCC ID: 2AFIB-YHS1916** filing to comply with Section 15.207, 15.209 and 15.247 of the FCC Part 15, Subpart C Rules.

### **3. TEST METHODOLOGY**

The tests documented in this report were performed in accordance with ANSI C63.10 2013 and FCC CFR 47 15.207, 15.209 and 15.247.

#### **3.1.EUT CONFIGURATION**

The EUT configuration for testing is installed on RF field strength measurement to meet the Commissions requirement and operating in a manner that intends to maximize its emission characteristics in a continuous normal application.

#### **3.2.EUT EXERCISE**

The EUT was operated in the engineering mode to fix the TX frequency that was for the purpose of the measurements.

According to its specifications, the EUT must comply with the requirements of the Section 15.207, 15.209 and 15.247 under the FCC Rules Part 15 Subpart C.

#### **3.3.GENERAL TEST PROCEDURES**

##### **Conducted Emissions**

The EUT is placed on the turntable, which is 0.8 m above ground plane. According to the requirements in Section 13.1.4.1 of ANSI C63.10 2013 Conducted emissions from the EUT measured in the frequency range between 0.15 MHz and 30MHz using CISPR Quasi-peak and average detector modes.

##### **Radiated Emissions**

Under 1GHz

The EUT is placed on a turn table, which is 0.8 m above ground plane. The turntable shall rotate 360 degrees to determine the position of maximum emission level. EUT is set 3m away from the receiving antenna, which varied from 1m to 4m to find out the highest emission. And also, each emission was to be maximized by changing the polarization of receiving antenna both horizontal and vertical. In order to find out the maximum emissions, exploratory radiated emission measurements were made according to the requirements in Section 13.1.4.1 of ANSI C63.10:2013.

Above 1GHz

The EUT is placed on a turn table, which is 1.5 m above ground plane. The turntable shall rotate 360 degrees to determine the position of maximum emission level. EUT is set 3m away from the receiving antenna, which varied from 1m to 4m to find out the highest emission. And also, each emission was to be maximized by changing the polarization of receiving antenna both horizontal and vertical. In order to find out the maximum emissions, exploratory radiated emission measurements were made according to the requirements in Section 13.1.4.1 of ANSI C63.10:2013.

### 3.4.FCC PART 15.205 RESTRICTED BANDS OF OPERATIONS

Except as shown in paragraph (d) of this section, only spurious emissions are permitted in any of the frequency bands listed below:

MHz	MHz	MHz	GHz
0.090 - 0.110	16.42 - 16.423	399.9 - 410	4.5 - 5.15
<sup>1</sup> 0.495 - 0.505	16.69475 - 16.69525	608 - 614	5.35 - 5.46
2.1735 - 2.1905	16.80425 - 16.80475	960 - 1240	7.25 - 7.75
4.125 - 4.128	25.5 - 25.67	1300 - 1427	8.025 - 8.5
4.17725 - 4.17775	37.5 - 38.25	1435 - 1626.5	9.0 - 9.2
4.20725 - 4.20775	73 - 74.6	1645.5 - 1646.5	9.3 - 9.5
6.215 - 6.218	74.8 - 75.2	1660 - 1710	10.6 - 12.7
6.26775 - 6.26825	108 - 121.94	1718.8 - 1722.2	13.25 - 13.4
6.31175 - 6.31225	123 - 138	2200 - 2300	14.47 - 14.5
8.291 - 8.294	149.9 - 150.05	2310 - 2390	15.35 - 16.2
8.362 - 8.366	156.52475 - 156.52525	2483.5 - 2500	17.7 - 21.4
8.37625 - 8.38675	156.7 - 156.9	2655 - 2900	22.01 - 23.12
8.41425 - 8.41475	162.0125 - 167.17	3260 - 3267	23.6 - 24.0
12.29 - 12.293	167.72 - 173.2	3332 - 3339	31.2 - 31.8
12.51975 - 12.52025	240 - 285	3345.8 - 3358	36.43 - 36.5
12.57675 - 12.57725	322 - 335.4	3600 - 4400	( <sup>2</sup> )
13.36 - 13.41			

<sup>1</sup> Until February 1, 1999, this restricted band shall be 0.490-0.510 MHz.

<sup>2</sup> Above 38.6

Except as provided in paragraphs (d) and (e), the field strength of emissions appearing within these frequency bands shall not exceed the limits shown in Section 15.209. At frequencies equal to or less than 1000 MHz, compliance with the limits in Section 15.209 shall be demonstrated using measurement instrumentation employing a CISPR quasi-peak detector. Above 1000 MHz, compliance with the emission limits in Section 15.209 shall be demonstrated based on the average value of the measured emissions. The provisions in Section 15.35 apply to these measurements.

### 3.5.DESRIPTION OF TEST MODES

The worst-case data rates:

IEEE802.11b mode:

Channel Low (2412MHz)

Channel Mid (2437MHz)

Channel High (2462MHz) with 1Mbps data rate was chosen for full testing.

IEEE802.11g mode:

Channel Low (2412MHz)

Channel Mid (2437MHz)

Channel High (2462MHz) with 6Mbps data rate was chosen for full testing.

IEEE 802.11n HT20 MHz Channel mode:

Channel Low (2412MHz)

Channel Mid (2437MHz)

Channel High (2462MHz) with MCS0 data rate was chosen for full testing.

IEEE 802.11n HT40 MHz Channel mode:

Channel Low (2422MHz)

Channel Mid (2437MHz)

Channel High (2452MHz) with MCS0 data rate was chosen for full testing.

### 3.6.ANTENNA DESCRIPTION

an intentional radiator antenna shall be designed to ensure that no antenna other than that furnished by the responsible party can be used with the device. The use of a permanently attached or an antenna that uses a unique coupling to the intentional radiator shall be considered sufficient to comply with the provisions of this section”

\* the antenna of this EUT is a unique(PIFA Antenna for WiFi and Bluetooth).

\* the EUT complies with the requirement of 15.203.

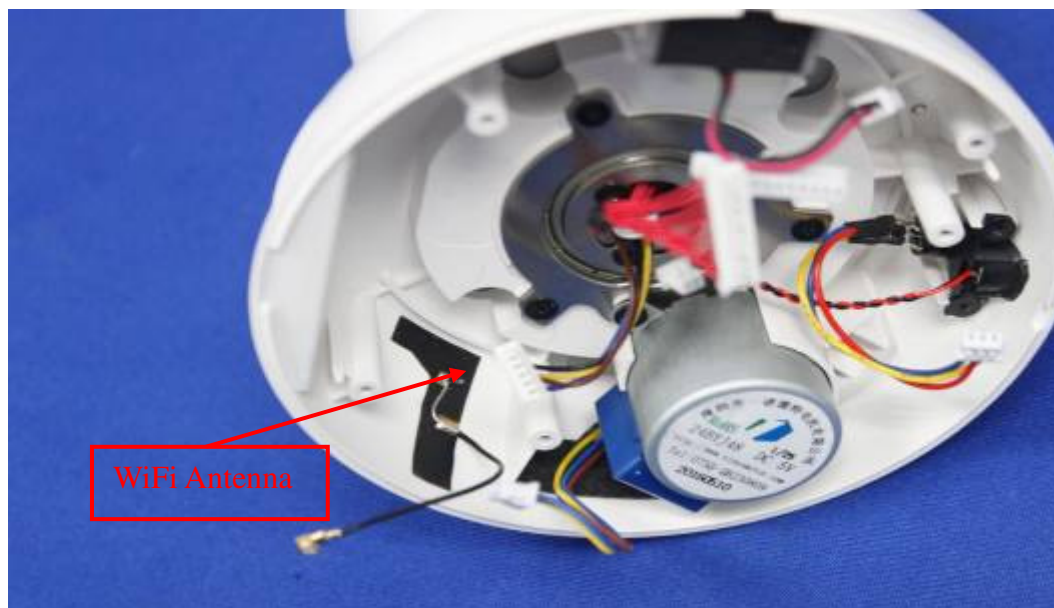



## 4. INSTRUMENT CALIBRATION

### 4.1.MEASURING INSTRUMENT CALIBRATION

The measuring equipment, which was utilized in performing the tests documented herein, has been calibrated in accordance with the manufacturer's recommendations for utilizing calibration equipment, which is traceable to recognized national standards.

#### Equipment Used for Emissions Measurement

Conducted Emissions Test Site					
Name of Equipment	Manufacturer	Model	Serial Number	Calibration Date	Calibration Due
Spectrum Analyzer	Agilent	E4446A	MY44020154	2015-9-11	2016-9-10
Spectrum Analyzer	RS	FSU26	200789	2015-8-10	2016-8-9
OSCILLOSCOPE	Agilent	DSO6104A	MY44002585	2016-3-2	2017-3-1
Power meter	Anritsu	ML2495A	1445010	2016-5-16	2017-5-15
Power sensor	Anritsu	MA2411B	1339220	2016-5-16	2017-5-15
Power SPLITTER	Mini-Circuits	ZN2PD-9G	SF078500430	N.C.R	N.C.R
DC Power Supply	AGILENT	E3632A	MY50340053	N.C.R	N.C.R
Temp. / Humidity Gauge	Anymetre	TH603	CCS007	2015-11-4	2016-11-3
Test Software			EZ-EMC		

977 Chamber					
Name of Equipment	Manufacturer	Model	Serial Number	Calibration Date	Calibration Due
Spectrum Analyzer	Agilent	E4446A	MY44020154	2015-9-11	2016-9-10
Spectrum Analyzer	RS	FSU26	200789	2015-8-10	2016-8-9
EMI Test Receiver	R&S	ESCI	101378	2016-1-6	2017-1-5
Pre-Amplfier	MINI	ZFL-1000VH2	070306	2016-1-13	2017-1-12
Pre-Amplfier	Miteq	JS41-00101800-32-10P	1675713	2015-8-10	2016-8-9
Bilog Antenna	Sunol	JB1	A062604	2016-5-29	2017-5-28
Bilog Antenna	Sunol	JB1	A110204-1	2016-7-16	2017-7-15
Loop Antenna	SCHWARZBECK	HXYZ9170	9170-108	2016-4-7	2017-4-6
Horn-antenna	SCHWARZBECK	9120D	D:266	2016-3-6	2017-3-5
Horn-antenna	SCHWARZBECK	9120D	D:267	2015-11-10	2016-11-9
Turn Table	CT	CT123	4165	N.C.R	N.C.R
Antenna Tower	CT	CTERG23	3256	N.C.R	N.C.R
Controller	CT	CT100	95637	N.C.R	N.C.R
Test Software			EZ-EMC		

Conducted Emission					
Name of Equipment	Manufacturer	Model	Serial Number	Calibration Date	Calibration Due
EMI TEST RECEIVER	R&S	ESCI	100781	2016-3-2	2017-3-1
V (V-LISN)	SCHWARZBECK	NNLK 8129	8129-143	2015-11-2	2016-11-1
LISN (EUT)	FCC	FCC-LISN-50/250-50-2-02	05012	2015-9-16	2016-9-15
Pulse LIMITER	R&S	ESH3-Z2	100524	2016-1-6	2017-1-5
Test Software			EZ-EMC		

**Remark:** The measurement uncertainty is less than +/- 2.81dB, which is evaluated as per the NAMAS NIS 81 and CISPR/A/291/CDV.

Expanded Uncertainty (95% CONFIDENCE INTERVAL): K=2

## **5. FACILITIES AND ACCREDITATIONS**

### **5.1.FACILITIES**

All measurement facilities used to collect the measurement data are located at CCS China Kunshan Lab at 10#Weiye Rd, Innovation Park Eco. & Tec. Development Zone

Kunshan city JiangSu, (215300), CHINA.

The sites are constructed in conformance with the requirements of ANSI C63.7, ANSI C63.10 2013 and CISPR Publication 22.

### **5.2.EQUIPMENT**

Radiated emissions are measured with one or more of the following types of linearly polarized antennas: tuned dipole, biconical, log periodic, bi-log, and/or ridged waveguide, horn. Spectrum analyzers with pre-selectors and quasi-peak detectors are used to perform radiated measurements.

Conducted emissions are measured with Line Impedance Stabilization Networks and EMI Test Receivers.



Calibrated wideband preamplifiers, coaxial cables, and coaxial attenuators are also used for making measurements.

All receiving equipment conforms to CISPR Publication 16-1, "Radio Interference Measuring Apparatus and Measurement Methods."

### **5.3.LABORATORY ACCREDITATIONS AND LISTING**

The test facilities used to perform radiated and conducted emissions tests are accredited by American Association for Laboratory Accreditation Program for the specific scope accreditation under Lab Code: 200581-0 to perform Electromagnetic Interference tests according to FCC Part 15 and CISPR 22 requirements. In addition, the test facilities are listed with Industry Canada, Certification and Engineering Bureau, 2324E-1 for 10m chamber 10m, 2324E-2 for 10m chamber 3m; the test facilities are listed with USA, Certification and Engineering Bureau, 424105 for 10m chamber 10m, 238958 for 10m chamber 3m.

**5.4.TABLE OF ACCREDITATIONS AND LISTINGS**

Country	Agency	Scope of Accreditation	Logo
USA	A2LA	47 CFR FCC Part 15/18 (using ANSI C63.10 :2013); VCCI V3; CNS 13438; CNS 13439; CNS 13803; CISPR 11; EN 55011; CISPR 13; EN 55013; CISPR 22:2005; CISPR 22:1997 +A1 :2000+A2 :2002; EN 55022:2006; EN55022 :1998 +A1 :2001+A2 :2003; EN 61000-6-3 (excluding discontinuous interference); EN 61000-6-4; AS/NZS CISPR 22; CAN/CSA-CEI/IEC CISPR 22; EN 61000-3-2; EN 61000-3-3; EN550024; EN 61000-4-2; EN 61000-4-3; EN61000-4-4; EN 61000-4-5; EN 61000-4-6; IEC 61000-4-8; EN 61000-4-11; IEC61000-3-2; IEC61000-3-3; IEC 61000-4-2; IEC 61000-4-3; IEC 61000-4-4; IEC 61000-4-5; IEC 61000-4-6; IEC 61000-4-8; IEC 61000-4-11; EN 300 220-3; EN 300 328; EN 300 330-2; EN 300 440-1; EN 300-440-2; EN 300 893; EN 301 489-01; EN 301 489-3; EN 301 489-07; EN 301 489-17; 47 CFR FCC Part 15, 22, 24	
USA	FCC	3/10 meter Sites to perform FCC Part 15/18 measurements	 93105, 90471
Japan	VCCI	3/10 meter Sites and conducted test sites to perform radiated/conducted measurements	<b>VCCI</b> R-1600 C-1707 G-216

*\* No part of this report may be used to claim or imply product endorsement by A2LA or any agency of the US Government.*

## 6. SETUP OF EQUIPMENT UNDER TEST

### 6.1.SETUP CONFIGURATION OF EUT

See test photographs attached in Appendix 1 for the actual connections between EUT and support equipment.

### 6.2.SUPPORT EQUIPMENT

No.	Device Type	Brand	Model	Series No.	FCC ID
1.	N/A				

**Remark:**

2. All the equipment/cables were placed in the worst-case configuration to maximize the emission during the test.
3. Grounding was established in accordance with the manufacturer's requirements and conditions for the intended use.

**7. FCC PART 15.247 REQUIREMENTS**

**7.1.6DB BANDWIDTH**

**LIMIT**

According to §15.247(a)(2), systems using digital modulation techniques may operate in the 902 - 928 MHz, and 2400 - 2483.5 MHz bands, and 5725 - 5850 MHz bands. The minimum 6dB bandwidth shall be at least 500kHz.

**Test Configuration**

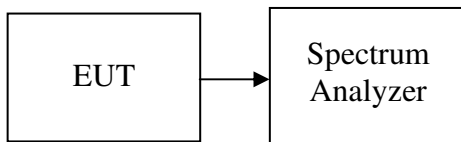

**TEST PROCEDURE**

The transmitter output is connected to the spectrum analyzer. The RBW set as 100kHz., The VBW set as 3 times the RBW, set detector as Peak, the sweep time is auto.

**TEST RESULTS**

*No non-compliance noted*

**Test Data**

**IEEE 802.11b mode**

Channel	Frequency (MHz)	Bandwidth (MHz)	Limit (kHz)	Result
Low	2412	7.762	>500	PASS
Mid	2437	7.684		PASS
High	2462	7.551		PASS

**IEEE 802.11g mode**

Channel	Frequency (MHz)	Bandwidth (MHz)	Limit (kHz)	Result
Low	2412	15.702	>500	PASS
Mid	2437	16.070		PASS
High	2462	15.767		PASS

**IEEE 802.11n HT20 mode**

Channel	Frequency (MHz)	Bandwidth (MHz)	Limit (kHz)	Result
Low	2412	16.994	>500	PASS
Mid	2437	17.275		PASS
High	2462	17.218		PASS

**IEEE 802.11n HT40 mode**

Channel	Frequency (MHz)	Bandwidth (MHz)	Limit (kHz)	Result
Low	2422	35.225	>500	PASS
Mid	2437	35.217		PASS
High	2452	35.213		PASS

**Test Plot**

**IEEE 802.11b MODE**

**6dB Bandwidth (CH Low)**

Agilent

R T

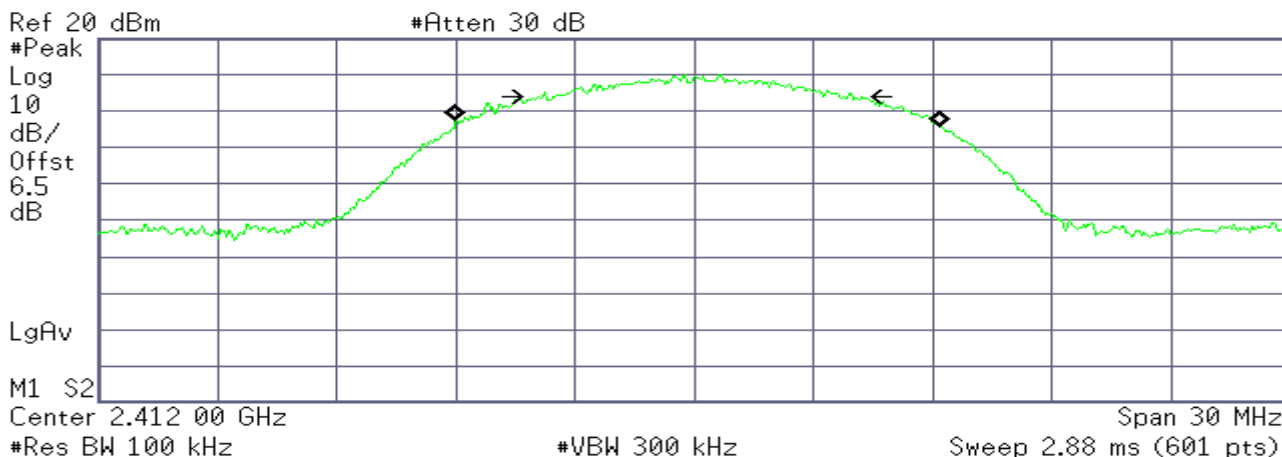

**Occupied Bandwidth**  
**12.1798 MHz**

**Occ BW % Pwr** 99.00 %  
**x dB** -6.00 dB

**Transmit Freq Error** 103.449 kHz  
**x dB Bandwidth** 7.762 MHz

**6dB Bandwidth (CH Mid)**

Agilent

R T

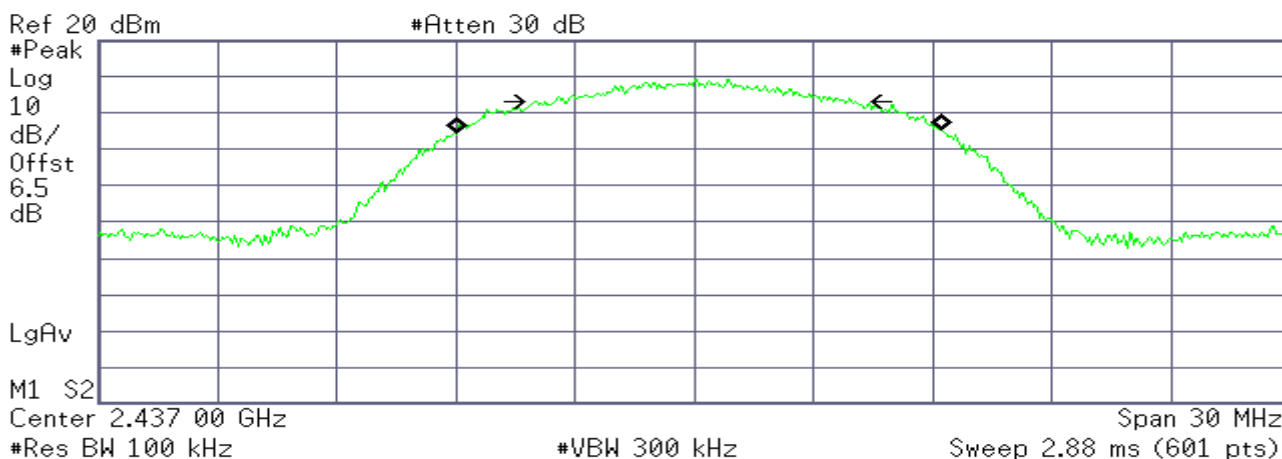

**Occupied Bandwidth**  
**12.2060 MHz**

**Occ BW % Pwr** 99.00 %  
**x dB** -6.00 dB

**Transmit Freq Error** 131.622 kHz  
**x dB Bandwidth** 7.684 MHz

**6dB Bandwidth (CH High)**

Agilent

R T

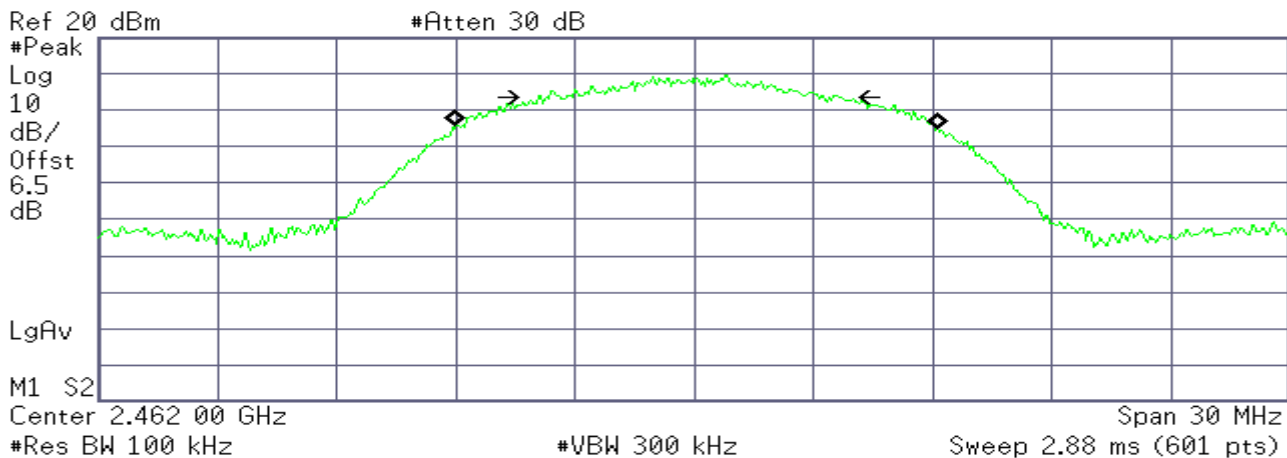

**Occupied Bandwidth**  
 12.1156 MHz

**Occ BW % Pwr** 99.00 %  
**x dB** -6.00 dB

**Transmit Freq Error** 82.226 kHz  
**x dB Bandwidth** 7.551 MHz

**IEEE 802.11g MODE**

**6dB Bandwidth (CH Low)**

Agilent

R T

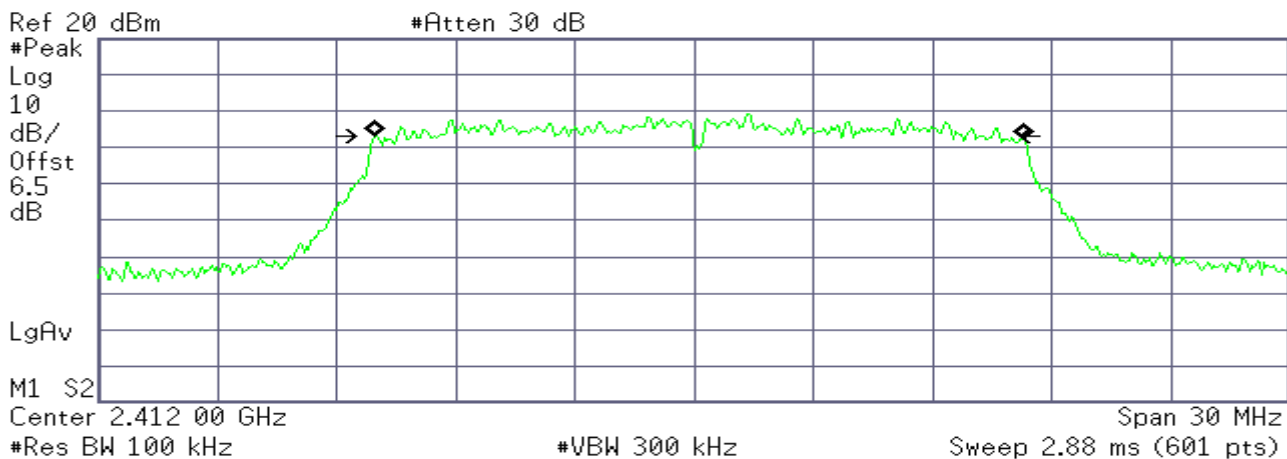

**Occupied Bandwidth**  
 16.3186 MHz

**Occ BW % Pwr** 99.00 %  
**x dB** -6.00 dB

**Transmit Freq Error** 118.405 kHz  
**x dB Bandwidth** 15.702 MHz



**6dB Bandwidth (CH Mid)**

Agilent

R T

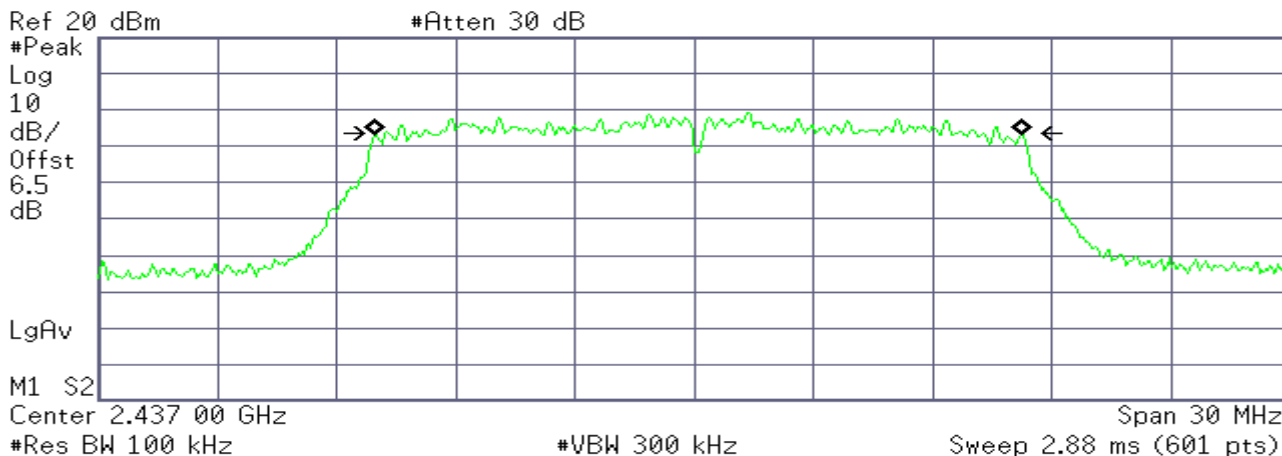

**Occupied Bandwidth**  
 16.3178 MHz

**Occ BW % Pwr** 99.00 %  
**x dB** -6.00 dB

**Transmit Freq Error** 112.621 kHz  
**x dB Bandwidth** 16.070 MHz

**6dB Bandwidth (CH High)**

Agilent

R T

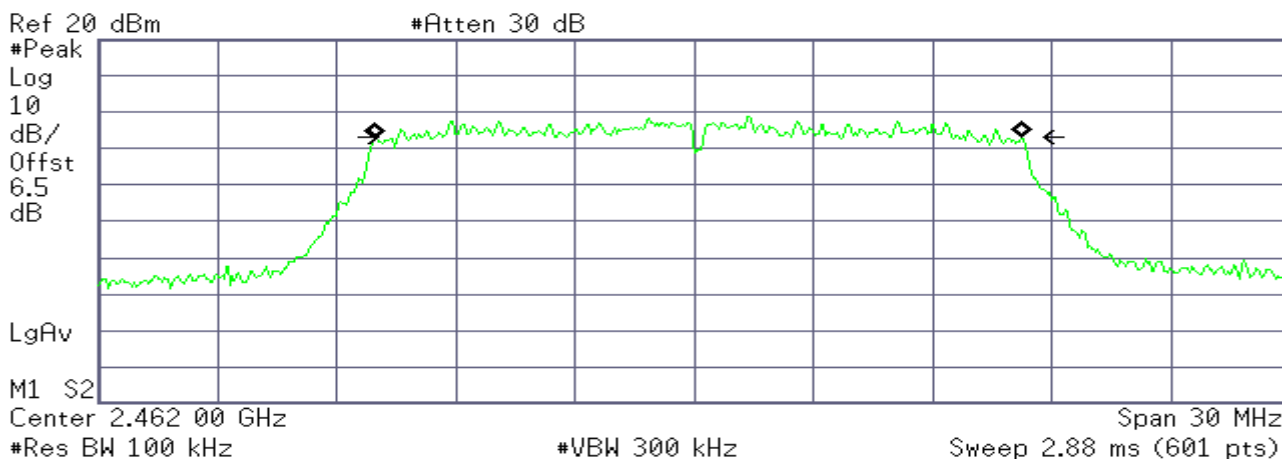

**Occupied Bandwidth**  
 16.3213 MHz

**Occ BW % Pwr** 99.00 %  
**x dB** -6.00 dB

**Transmit Freq Error** 109.786 kHz  
**x dB Bandwidth** 15.767 MHz

**IEEE 802.11n HT20 mode**

**6dB Bandwidth (CH Low)**

Agilent

R T

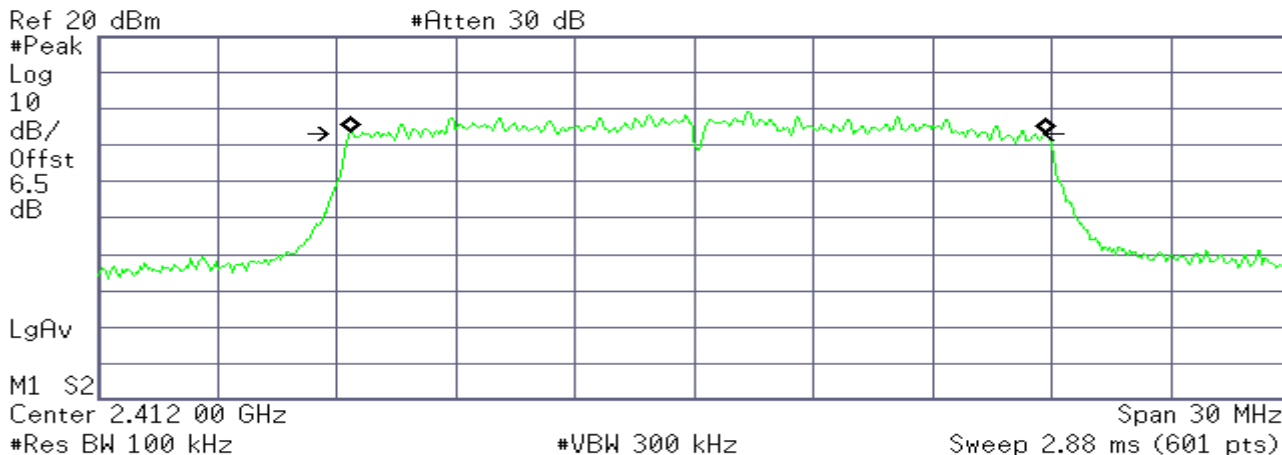

**Occupied Bandwidth**  
 17.5046 MHz

**Occ BW % Pwr** 99.00 %  
**x dB** -6.00 dB

**Transmit Freq Error** 109.330 kHz  
**x dB Bandwidth** 16.994 MHz

**6dB Bandwidth (CH Mid)**

Agilent

R T

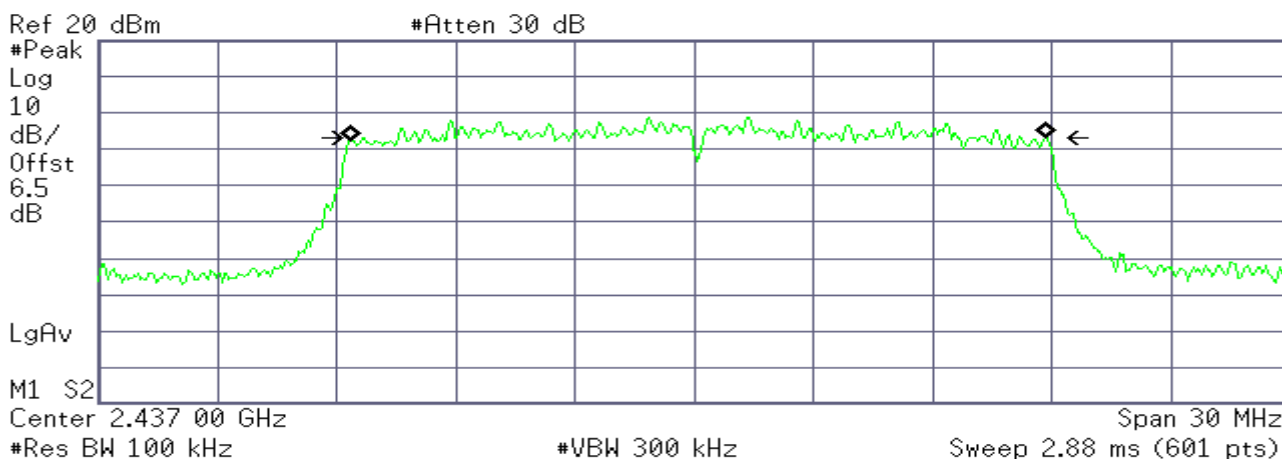

**Occupied Bandwidth**  
 17.5115 MHz

**Occ BW % Pwr** 99.00 %  
**x dB** -6.00 dB

**Transmit Freq Error** 118.305 kHz  
**x dB Bandwidth** 17.275 MHz

**6dB Bandwidth (CH High)**

**Agilent**

**R T**

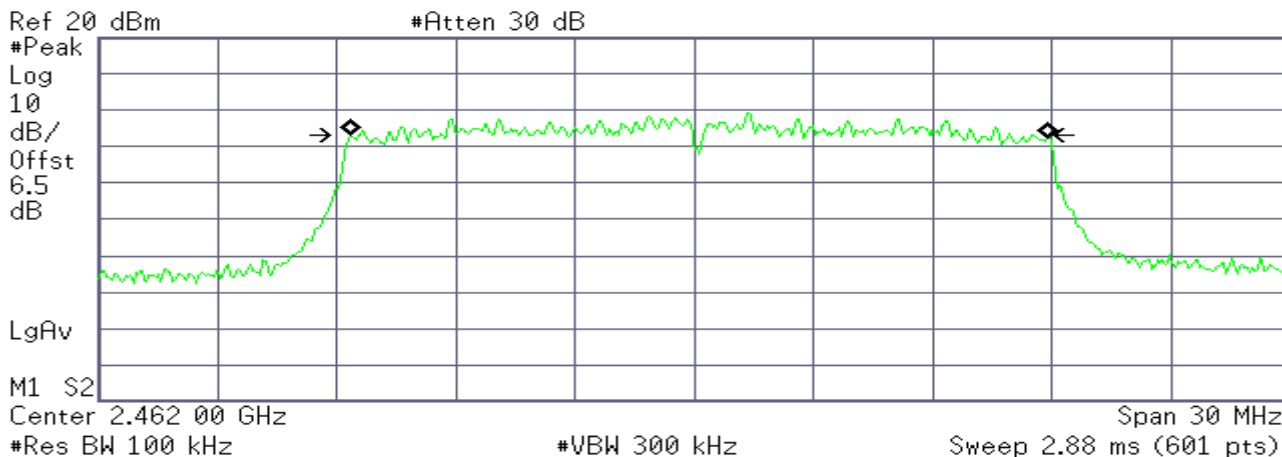

**Occupied Bandwidth**  
**17.5275 MHz**

**Occ BW % Pwr** 99.00 %  
**x dB** -6.00 dB

**Transmit Freq Error** 123.197 kHz  
**x dB Bandwidth** 17.218 MHz

**IEEE 802.11n HT40 mode**

**6dB Bandwidth (CH Low)**

**Agilent**

**R T**

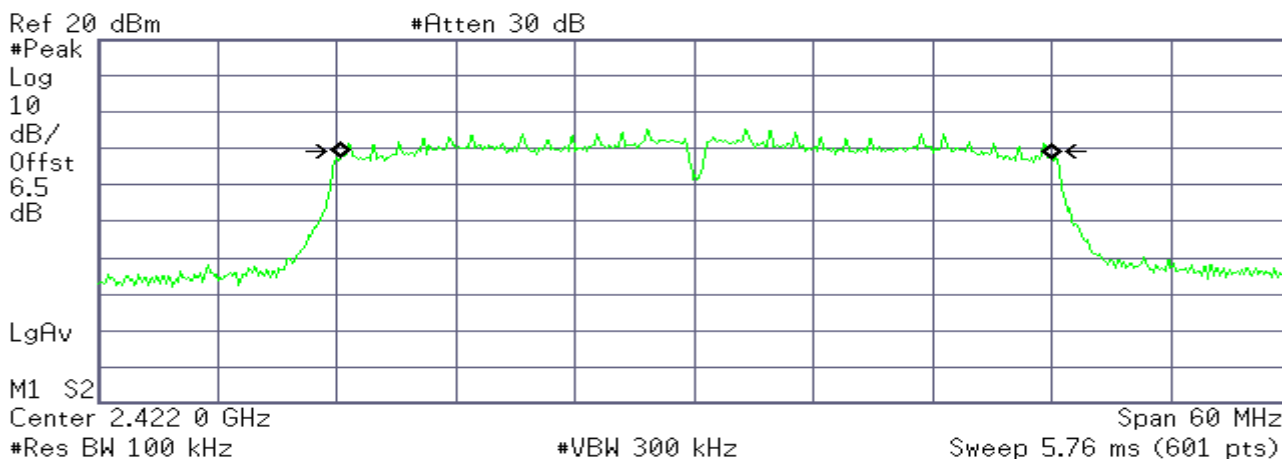

**Occupied Bandwidth**  
**35.8557 MHz**

**Occ BW % Pwr** 99.00 %  
**x dB** -6.00 dB

**Transmit Freq Error** 109.133 kHz  
**x dB Bandwidth** 35.225 MHz

**6dB Bandwidth (CH Mid)**

Agilent

R T

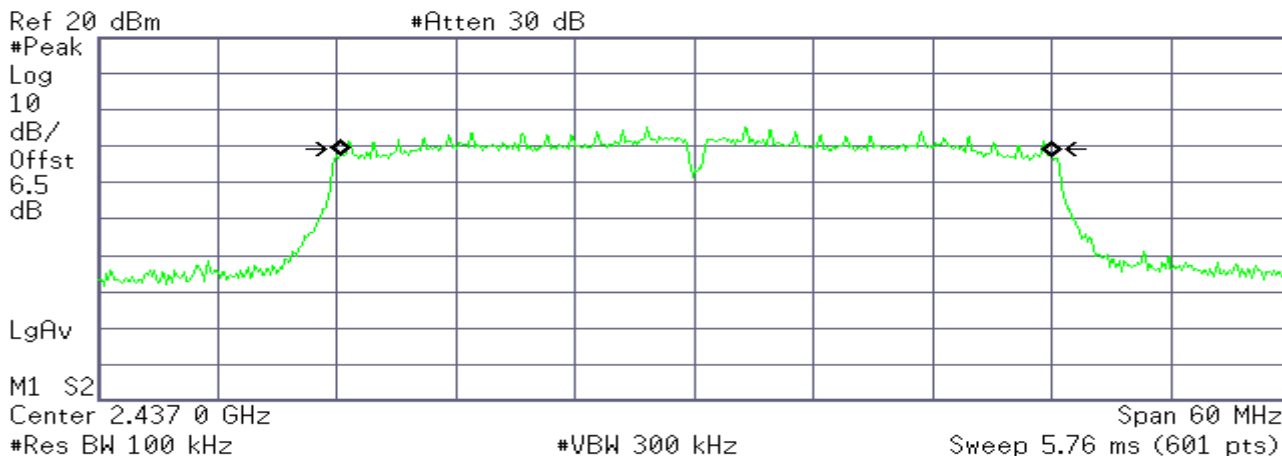

**Occupied Bandwidth**  
 35.8366 MHz

**Occ BW % Pwr** 99.00 %  
**x dB** -6.00 dB

**Transmit Freq Error** 88.071 kHz  
**x dB Bandwidth** 35.217 MHz

**6dB Bandwidth (CH High)**

Agilent

R T

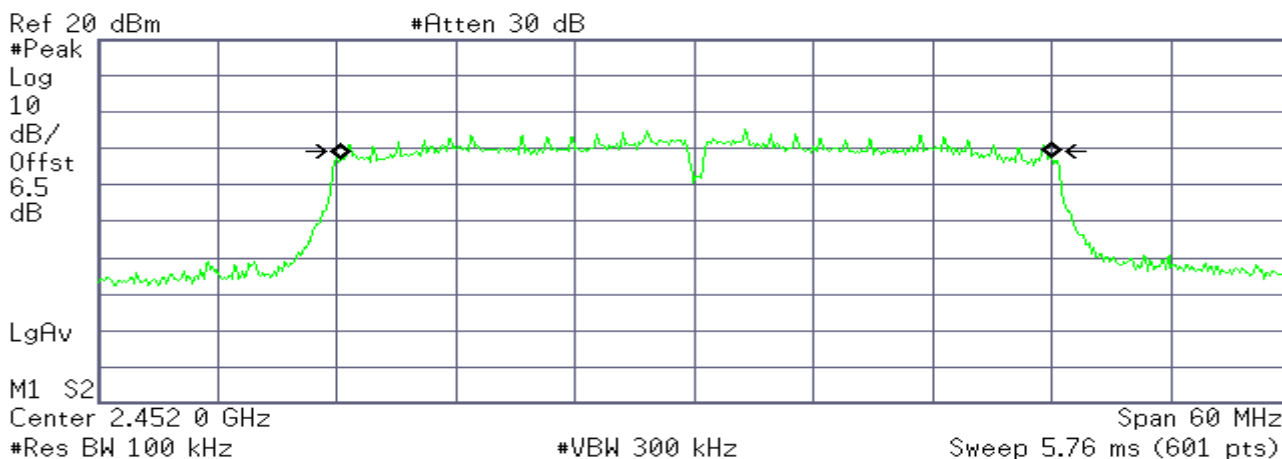

**Occupied Bandwidth**  
 35.8382 MHz

**Occ BW % Pwr** 99.00 %  
**x dB** -6.00 dB

**Transmit Freq Error** 93.368 kHz  
**x dB Bandwidth** 35.213 MHz

## 7.2. PEAK POWER

### LIMIT

The maximum peak output power of the intentional radiator shall not exceed the following:

1. According to §15.247(b)(3), for systems using digital modulation in the bands of 902-928 MHz, and 2400-2483.5 MHz: 1 Watt.
2. According to §15.247(b)(4), the conducted output power limit specified in paragraph (b) of this section is based on the use of antennas with directional gains that do not exceed 6 dBi. Except as shown in paragraph (c) of this section, if transmitting antennas of directional gain greater than 6 dBi are used, the conducted output power from the intentional radiator shall be reduced below the stated values in paragraphs (b)(1), (b)(2), and (b)(3) of this section, as appropriate, by the amount in dB that the directional gain of the antenna exceeds 6 dBi.

### Test Configuration

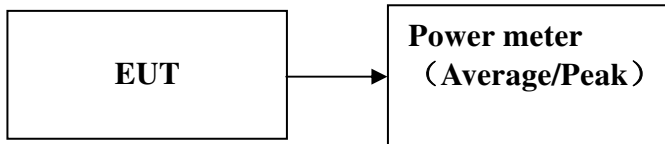

### TEST PROCEDURE

1. The EUT transmitter output is connected to the Power meter.  
The Power meter is set to the peak power detection.
2. The testing follows the Measurement Procedure FCC KDB No. 558074 D01 DTS Meas.
3. Guidance v03r05. 9.1.2 PKPM1 Peak power meter method.

### TEST RESULTS

*No non-compliance noted*

**Test Data****Test mode: IEEE 802.11b mode**

Channel	Frequency (MHz)	Output Power (dBm)	Limit (dBm)
Low	2412	20.35	30.00
Mid	2437	20.41	30.00
High	2462	20.24	30.00

**Test mode: IEEE 802.11g mode**

Channel	Frequency (MHz)	Output Power (dBm)	Limit (dBm)
Low	2412	17.24	30.00
Mid	2437	17.22	30.00
High	2462	17.13	30.00

**Test mode: IEEE 802.11n HT20 mode**

Channel	Frequency (MHz)	Output Power (dBm)	Limit (dBm)
Low	2412	16.97	30.00
Mid	2437	16.96	30.00
High	2462	16.73	30.00

**Test mode: IEEE 802.11n HT40 mode**

Channel	Frequency (MHz)	Output Power (dBm)	Limit (dBm)
Low	2422	16.51	30.00
Mid	2437	16.47	30.00
High	2452	16.38	30.00

### **7.3. PEAK POWER SPECTRAL DENSITY**

#### **LIMIT**

1. According to §15.247(e), for digitally modulated systems, the power spectral density conducted from the intentional radiator to the antenna shall not be greater than 8 dBm in any 3 kHz band during any time interval of continuous transmission.
2. According to §15.247(f), the digital modulation operation of the hybrid system, with the frequency hopping turned off, shall comply with the power density requirements of paragraph (d) of this section.

#### **Test Configuration**

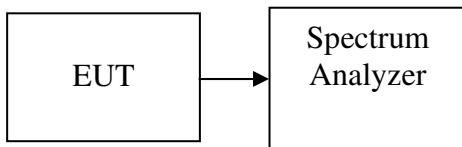

#### **TEST PROCEDURE**

1. Place the EUT on the table and set it in transmitting mode. Remove the antenna from the EUT and then connect a low loss RF cable from the antenna port to the spectrum analyzer.
2. Set the spectrum analyzer as RBW = 3 kHz, VBW = 10 kHz, Span = 1.5 times the DTS bandwidth, Sweep = auto
3. Record the max reading.
4. Repeat the above procedure until the measurements for all frequencies are completed.

#### **TEST RESULTS**

*No non-compliance noted*

**Test Data****Test mode: IEEE 802.11b mode**

Channel	Frequency (MHz)	PPSD (dBm)	Limit (dBm)	Result
Low	2412	-5.40	8.00	PASS
Mid	2437	-3.46	8.00	PASS
High	2462	-5.22	8.00	PASS

**Test mode: IEEE 802.11g mode**

Channel	Frequency (MHz)	PPSD (dBm)	Limit (dBm)	Result
Low	2412	-15.90	8.00	PASS
Mid	2437	-15.33	8.00	PASS
High	2462	-16.04	8.00	PASS

**Test mode: IEEE 802.11n HT20 mode**

Channel	Frequency (MHz)	PPSD (dBm)	Limit (dBm)	Result
Low	2412	-16.64	8.00	PASS
Mid	2437	-16.39	8.00	PASS
High	2462	-17.73	8.00	PASS

**Test mode: IEEE 802.11n HT40 mode**

Channel	Frequency (MHz)	PPSD (dBm)	Limit (dBm)	Result
Low	2422	-17.90	8.00	PASS
Mid	2437	-19.38	8.00	PASS
High	2452	-19.38	8.00	PASS



**Test Plot**

**IEEE 802.11b mode**

**PPSD (CH Low)**

Agilent

R T

Mkr1 2.411 146 GHz  
 -5.40 dBm

Ref 10 dBm #Atten 20 dB

#Peak  
 Log  
 10  
 dB/  
 Offst  
 6.5  
 dB

LgAv

M1 S2  
 S3 FC  
 RA

£(f):  
 FTun  
 Swp

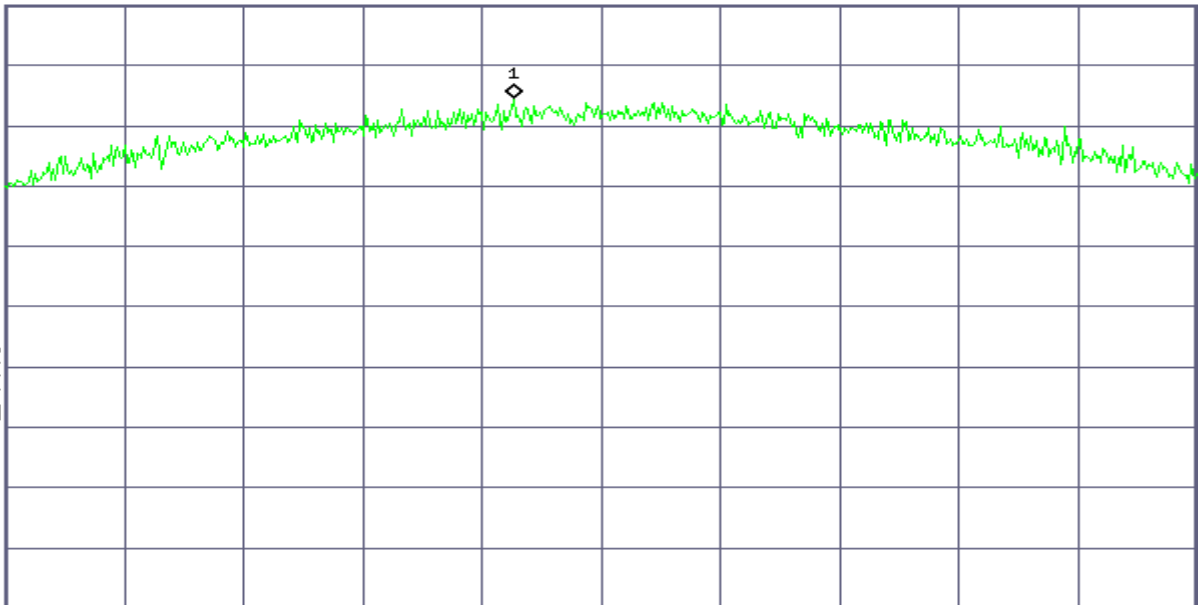

Center 2.412 000 GHz  
 #Res BW 3 kHz

#VBW 10 kHz

Span 11.64 MHz  
 Sweep 1.228 s (601 pts)

**PPSD(CH Mid)**

Agilent

R T

Mkr1 2.436 903 GHz  
 -3.46 dBm

Ref 10 dBm #Atten 20 dB

#Peak  
 Log  
 10  
 dB/  
 Offst  
 6.5  
 dB

LgAv

M1 S2  
 S3 FC  
 RA

£(f):  
 FTun  
 Swp

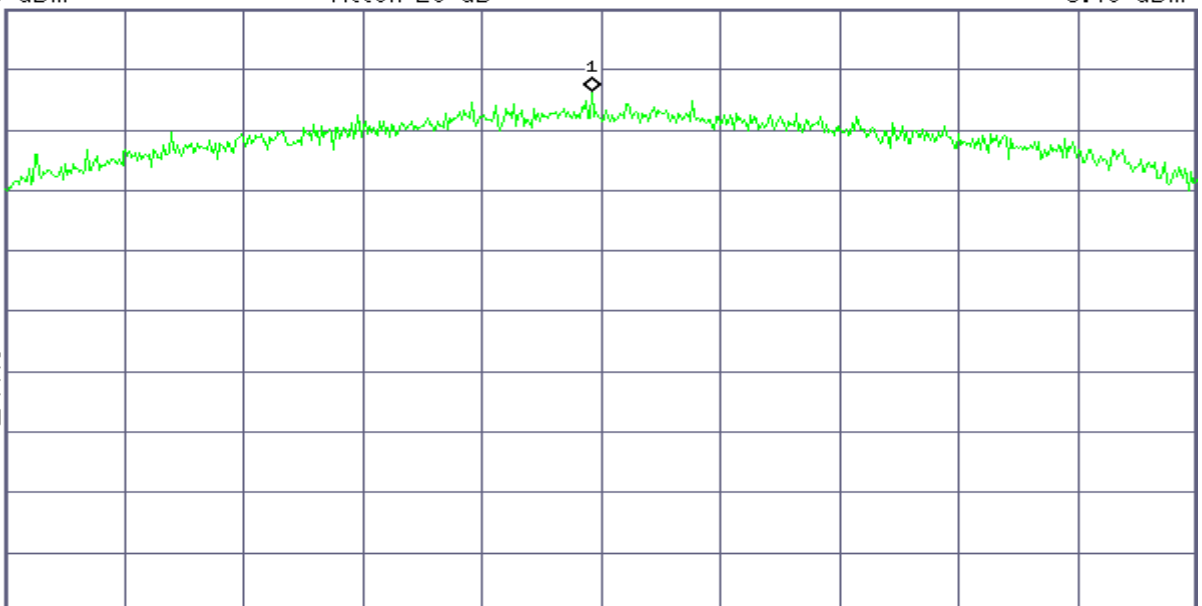

Center 2.437 000 GHz  
 #Res BW 3 kHz

#VBW 10 kHz

Span 11.64 MHz  
 Sweep 1.228 s (601 pts)

**PPSD (CH High)**

Agilent

R T

Mkr1 2.461 418 GHz  
 -5.22 dBm

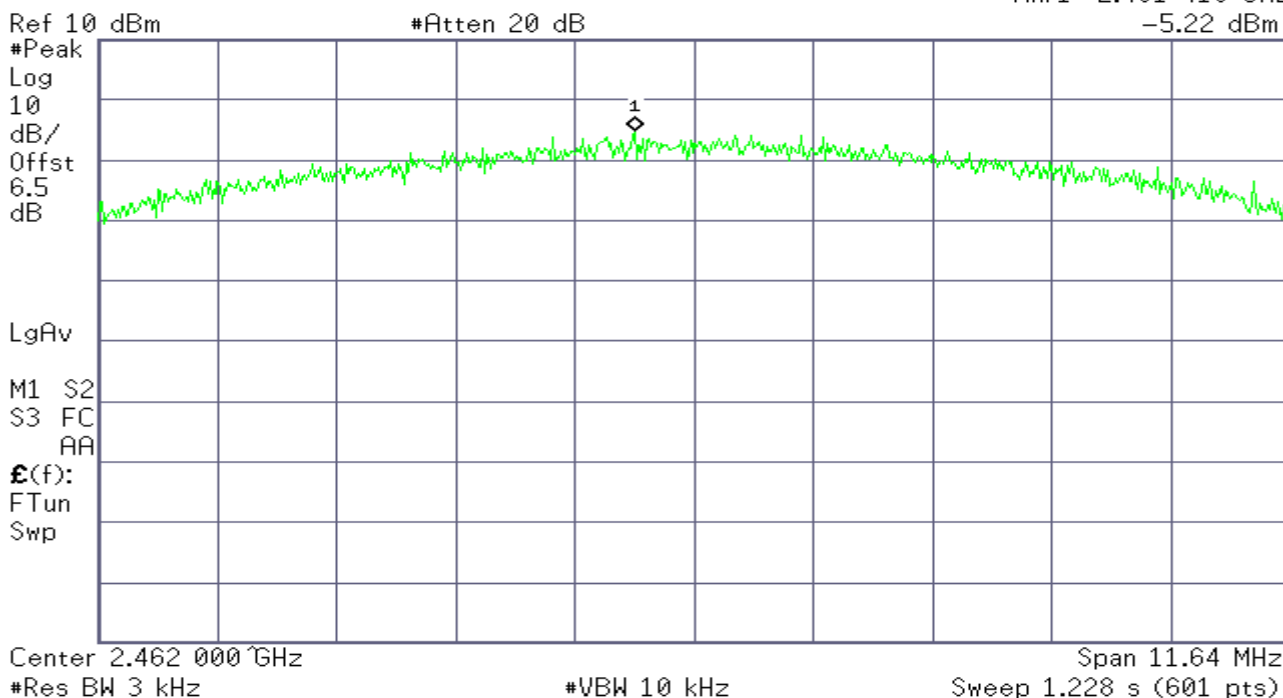

**IEEE 802.11g mode**

**PPSD (CH Low)**

Agilent

R T

Mkr1 2.412 80 GHz  
 -15.90 dBm

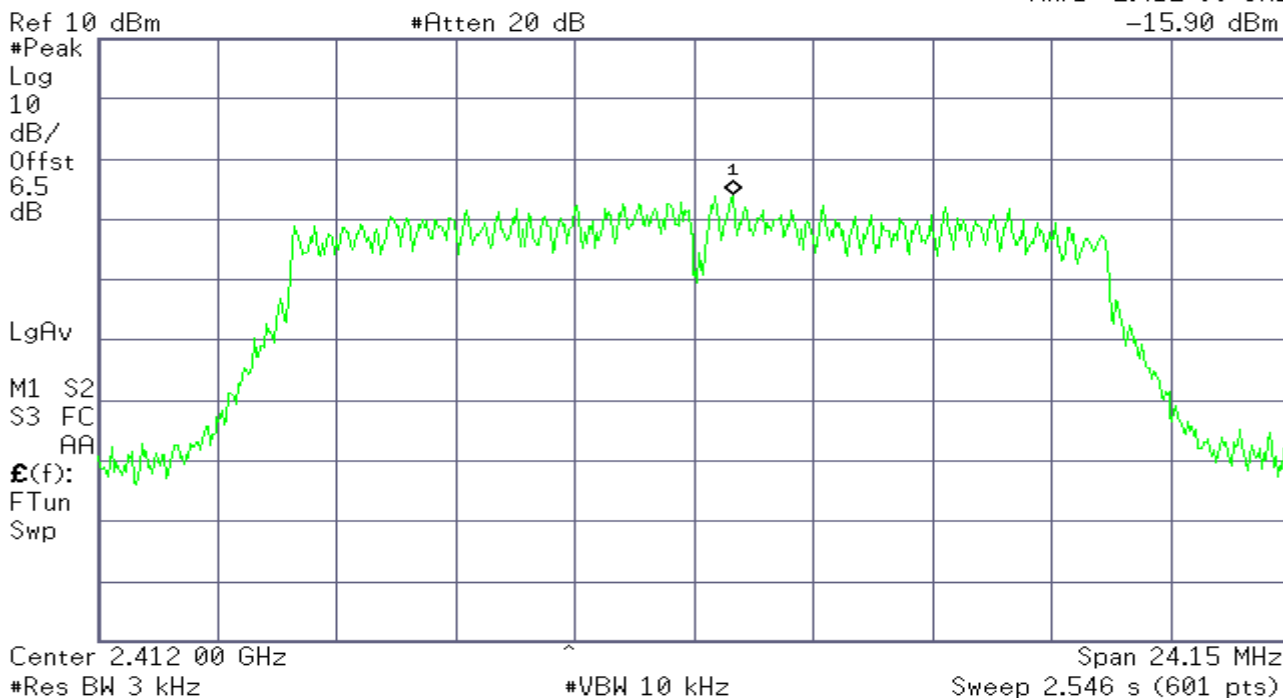

**PPSD (CH Mid)**

Agilent

R T

Mkr1 2.436 48 GHz  
 -15.33 dBm

Ref 10 dBm

#Atten 20 dB

#Peak  
 Log  
 10  
 dB/  
 Offst  
 6.5  
 dB

LgAv

M1 S2  
 S3 FC  
 AA

f(f):  
 FTun  
 Swp

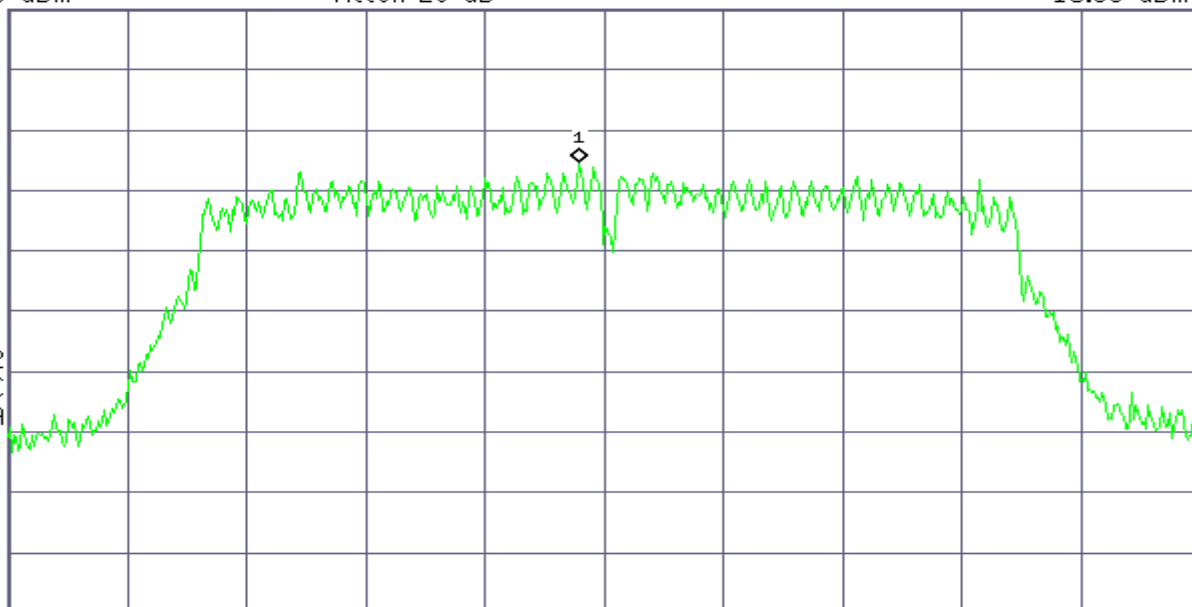

Center 2.437 00 GHz ^

#Res BW 3 kHz

#VBW 10 kHz

Span 24.15 MHz

Sweep 2.546 s (601 pts)

**PPSD (CH High)**

Agilent

R T

Mkr1 2.467 43 GHz  
 -16.04 dBm

Ref 10 dBm

#Atten 20 dB

#Peak  
 Log  
 10  
 dB/  
 Offst  
 6.5  
 dB

LgAv

M1 S2  
 S3 FC  
 AA

f(f):  
 FTun  
 Swp

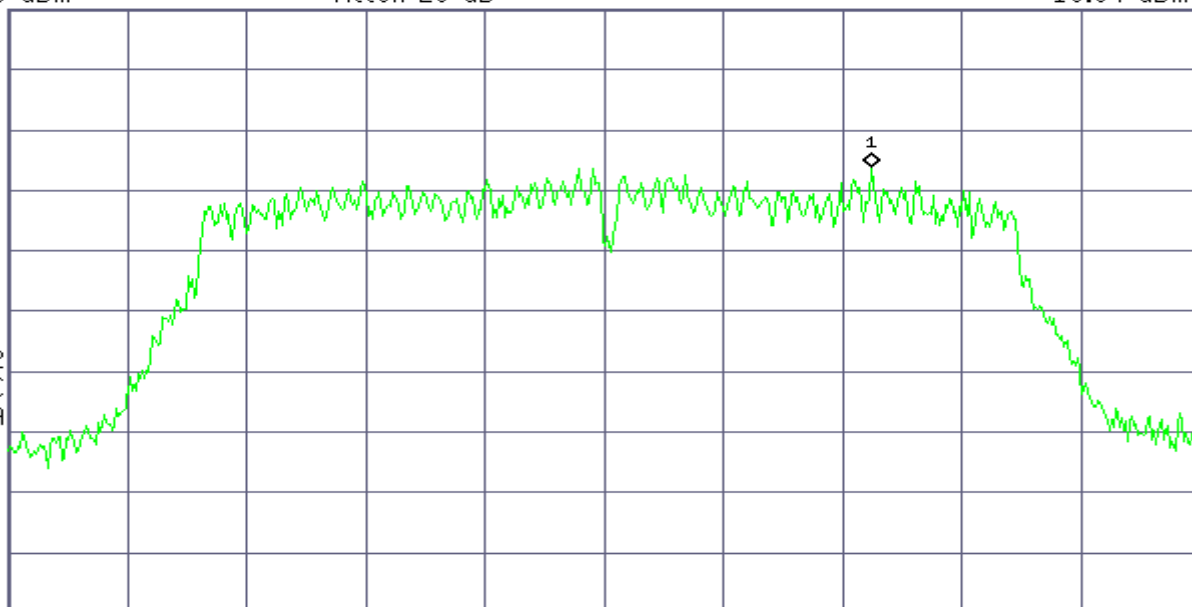

Center 2.462 00 GHz

#Res BW 3 kHz

#VBW 10 kHz

Span 24.15 MHz

Sweep 2.546 s (601 pts)

**IEEE 802.11n HT20 mode**

**PPSD (CH Low)**

**Agilent**

**R T**

Mkr1 2.413 34 GHz  
 -16.64 dBm

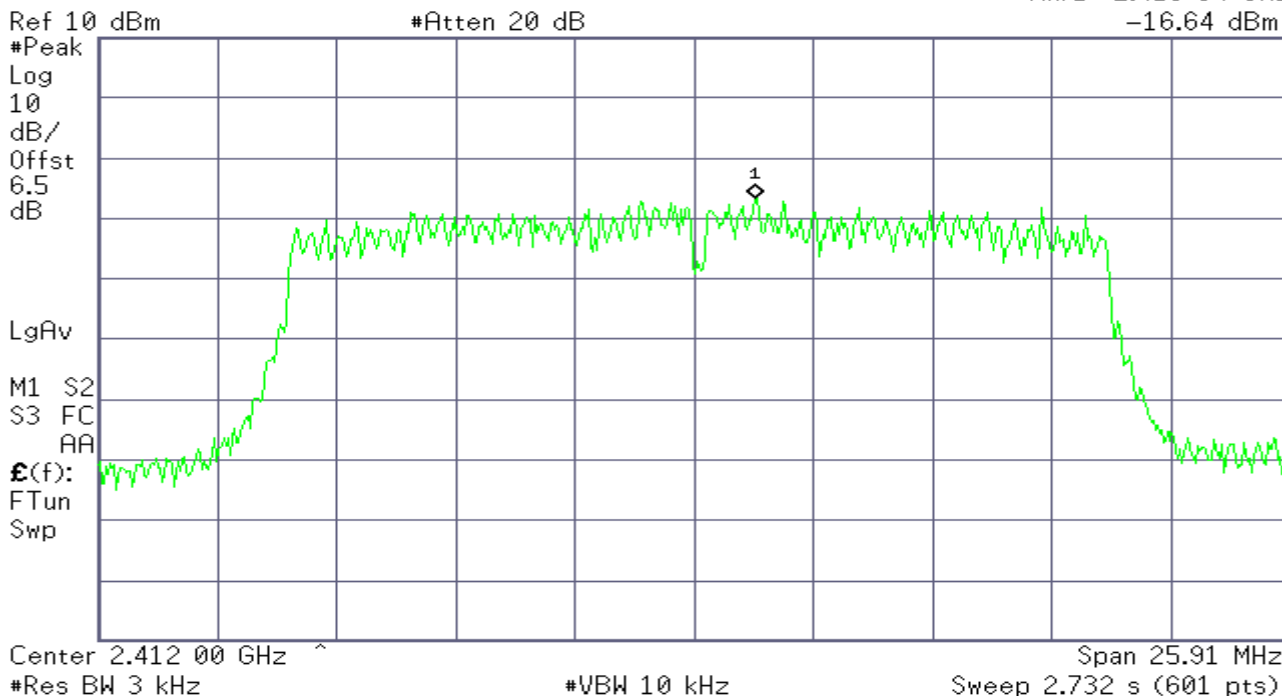

**PPSD (CH Mid)**

**Agilent**

**R T**

Mkr1 2.439 59 GHz  
 -16.39 dBm

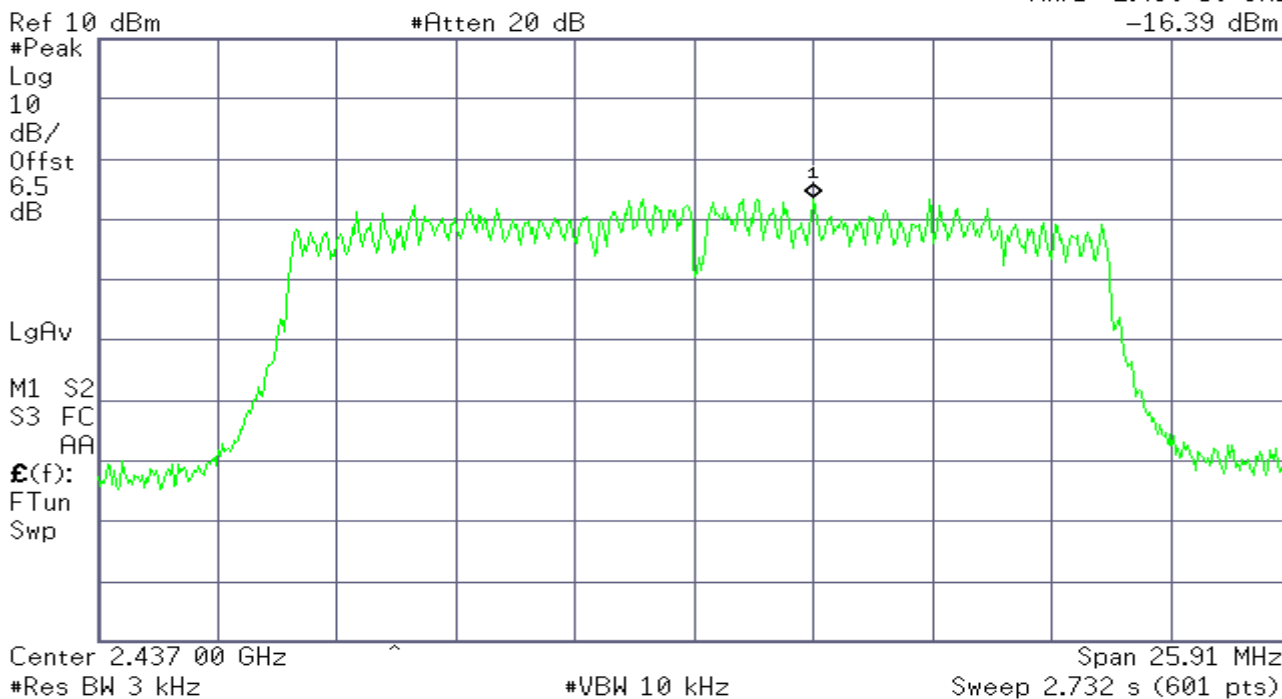

**PPSD (CH High)**

Agilent

R T

Mkr1 2.456 13 GHz  
 -17.73 dBm

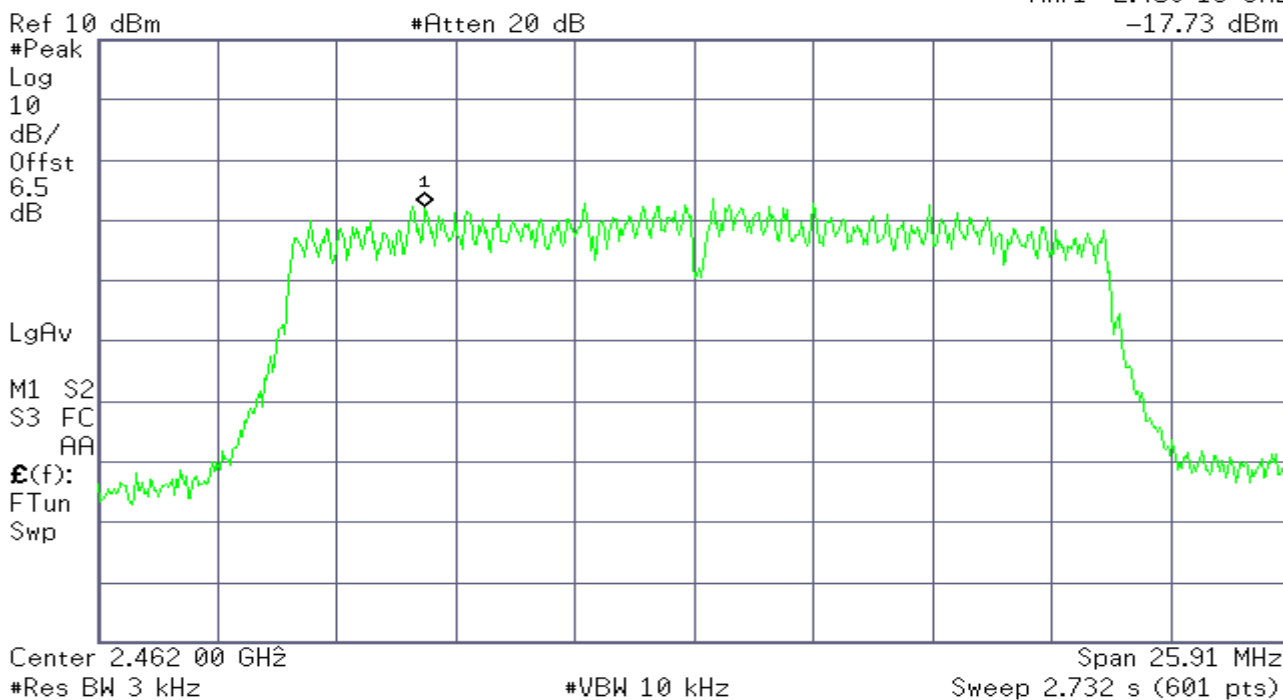

**IEEE 802.11n HT40 mode**

**PPSD (CH Low)**

Agilent

R T

Mkr1 2.421 21 GHz  
 -17.90 dBm

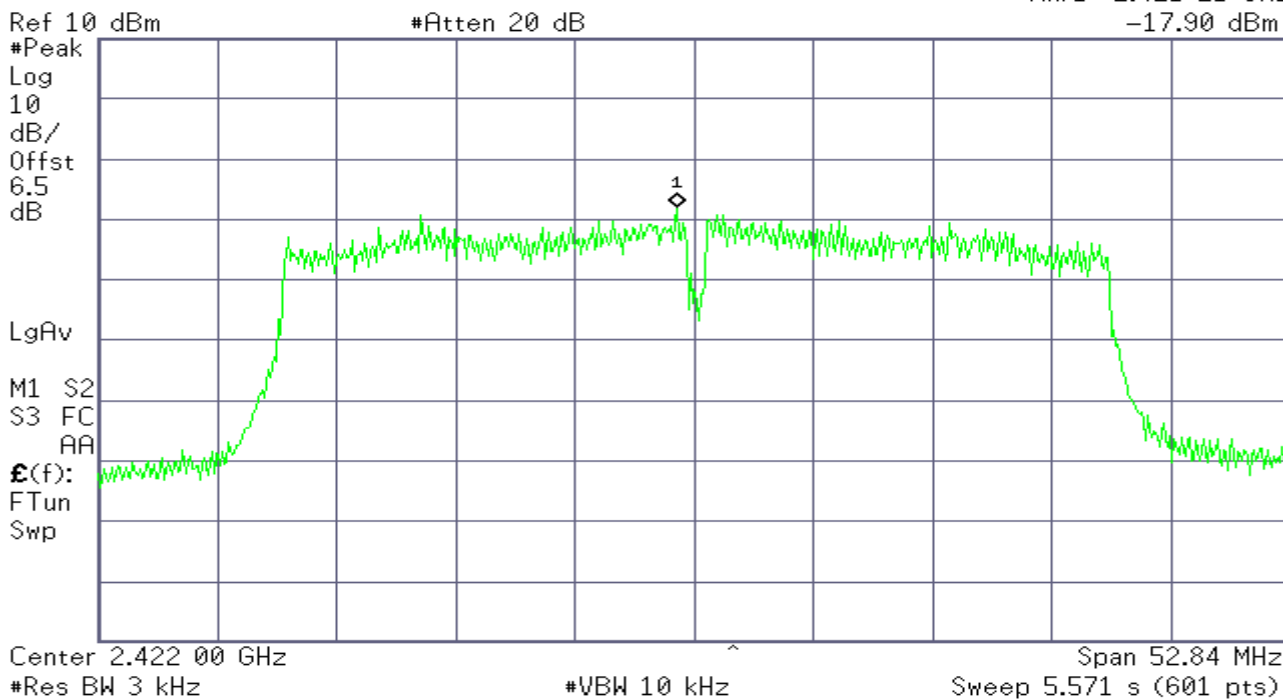

**PPSD (CH Mid)**

**Agilent**

**R T**

Mkr1 2.438 94 GHz  
 -19.38 dBm

Ref 10 dBm

#Atten 20 dB

#Peak  
 Log  
 10  
 dB/  
 Offst  
 6.5  
 dB

LgAv

M1 S2  
 S3 FC  
 AA

£(f):  
 FTun  
 Swp

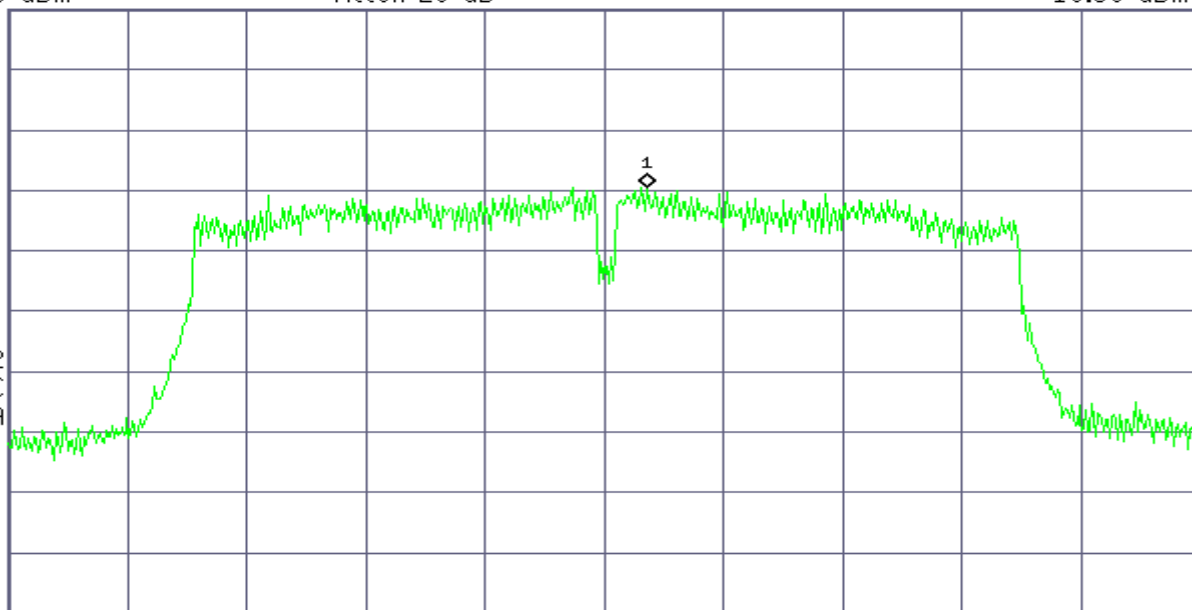

Center 2.437 00 GHz

#Res BW 3 kHz

#VBW 10 kHz

Span 52.84 MHz  
 Sweep 5.571 s (601 pts)

**PPSD (CH High)**

**Agilent**

**R T**

Mkr1 2.451 21 GHz  
 -19.38 dBm

Ref 10 dBm

#Atten 20 dB

#Peak  
 Log  
 10  
 dB/  
 Offst  
 6.5  
 dB

LgAv

M1 S2  
 S3 FC  
 AA

£(f):  
 FTun  
 Swp

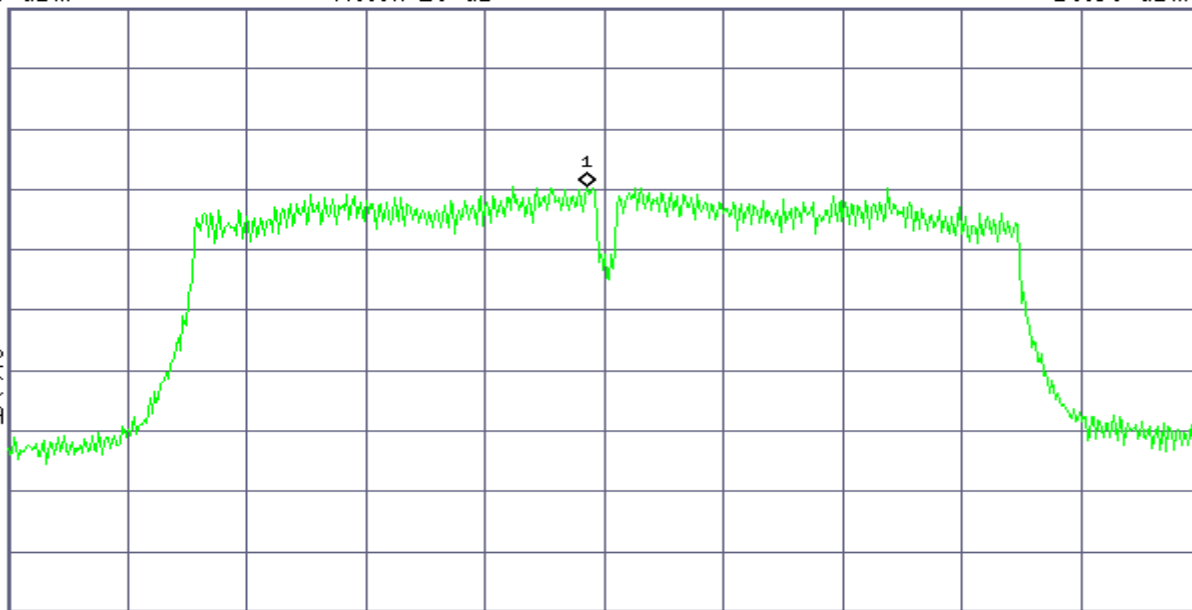

Center 2.452 00 GHz

#Res BW 3 kHz

#VBW 10 kHz

Span 52.84 MHz  
 Sweep 5.571 s (601 pts)

## **7.4.SPURIOUS EMISSIONS**

### **Conducted Measurement**

#### **LIMIT**

According to §15.247(d), in any 100 kHz bandwidth outside the frequency bands in which the spread spectrum intentional radiator is operating, the radio frequency power that is produced by the intentional radiator shall be at least 20 dB below that in the 100 kHz bandwidth within the band that contains the highest level of the desired power, based on either an RF conducted or a radiated measurement, provided the transmitter demonstrates compliance with the peak conducted power limits. In addition, radiated emissions which fall in the restricted bands, as defined in §15.205(a), must also comply with the radiated emission limits specified in 15.209(a) (see Section 15.205(c)).

#### **Test Configuration**

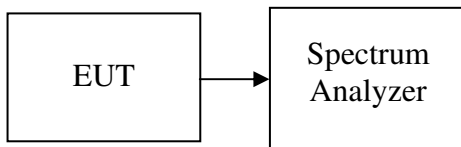

#### **TEST PROCEDURE**

Conducted RF measurements of the transmitter output were made to confirm that the EUT antenna port conducted emissions meet the specified limit and to identify any spurious signals that require further investigation or measurements on the radiated emissions site.

The transmitter output is connected to the spectrum analyzer. The resolution bandwidth is set to 100 kHz. The video bandwidth is set to 300 kHz.

Measurements are made over the 30MHz to 40GHz range with the transmitter set to the lowest, middle, and highest channels.

#### **TEST RESULTS**

*No non-compliance noted*

#### **Test Plot**

**OUT-OF-BAND SPURIOUS EMISSIONS-CONDUCTED MEASUREMENT**

**IEEE 802.11b mode**

**CH Low**

Agilent

R T

Mkr1 2.411 573 GHz  
 10.57 dBm

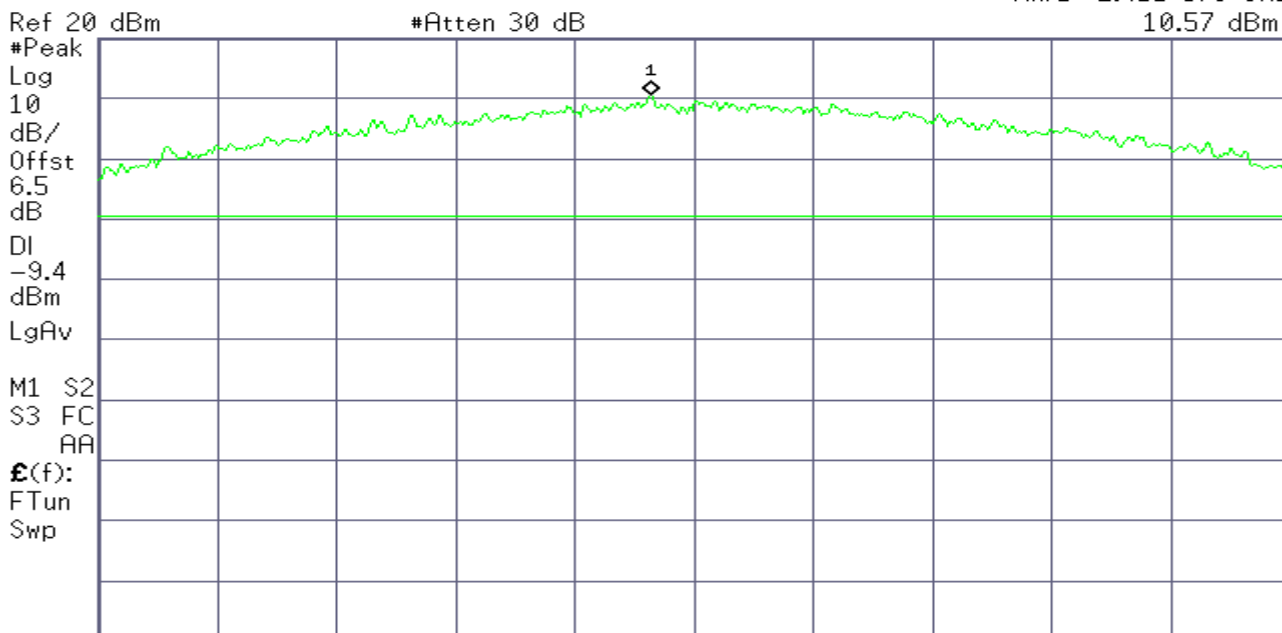

Center 2.412 000 GHz Span 11.64 MHz  
 #Res BW 100 kHz #VBW 300 kHz Sweep 1.12 ms (601 pts)

Agilent

R T

Mkr2 2.398 588 GHz  
 -31.70 dBm

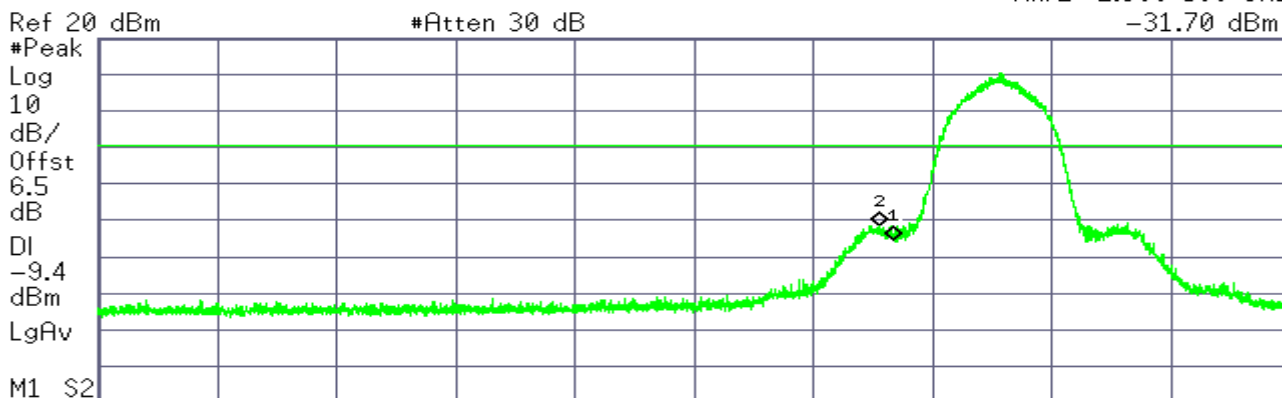

Start 2.310 000 GHz Stop 2.445 000 GHz  
 #Res BW 100 kHz #VBW 300 kHz Sweep 13.11 ms (8192 pts)

Marker	Trace	Type	X Axis	Amplitude
1	(1)	Freq	2.400 000 GHz	-35.37 dBm
2	(1)	Freq	2.398 588 GHz	-31.70 dBm



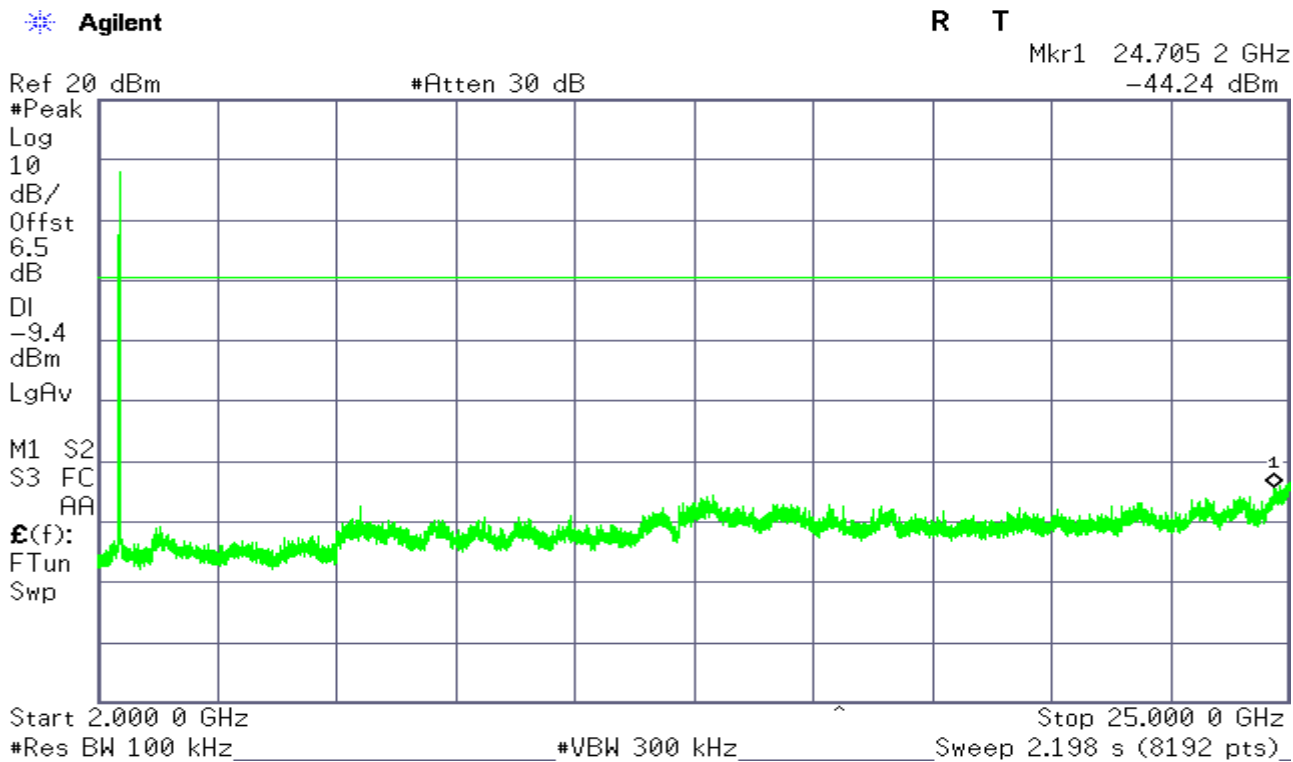
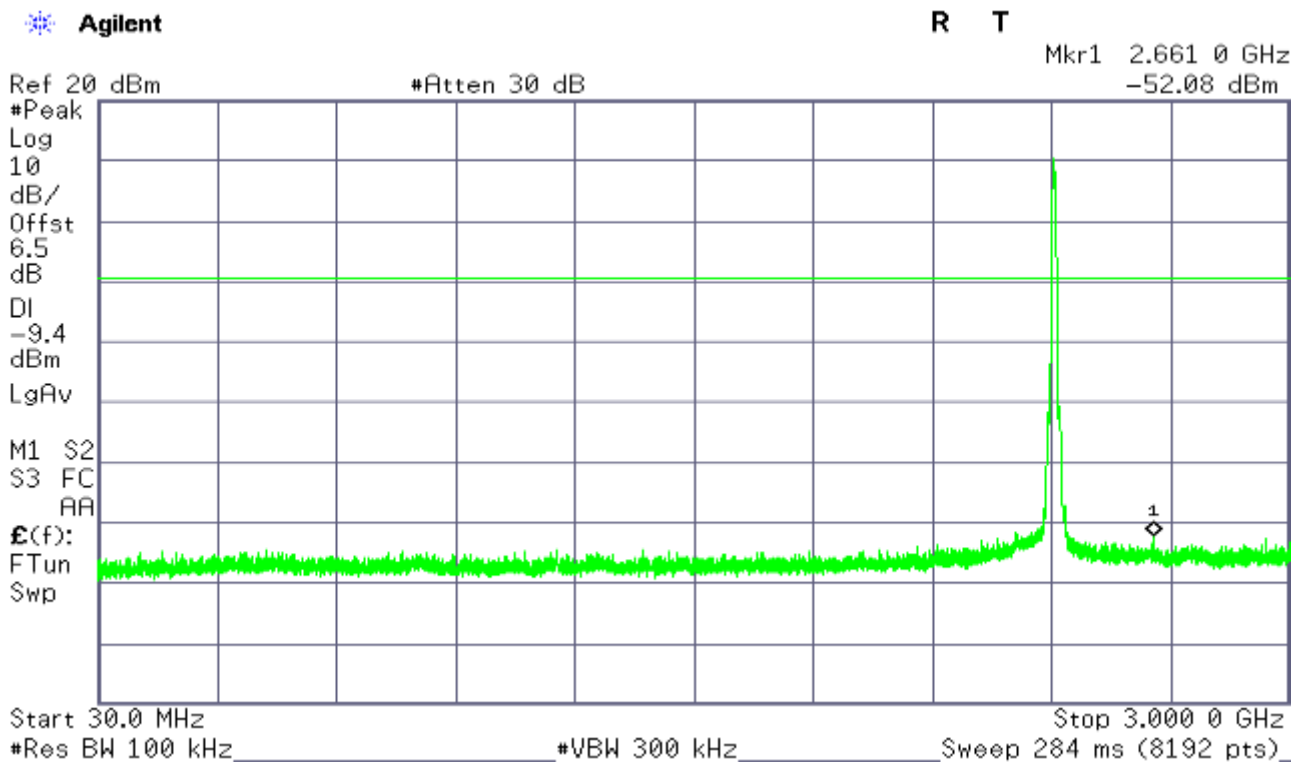

**CH Mid**

Agilent

**R T**  
 Mkr1 2.437 698 4 GHz  
 9.78 dBm

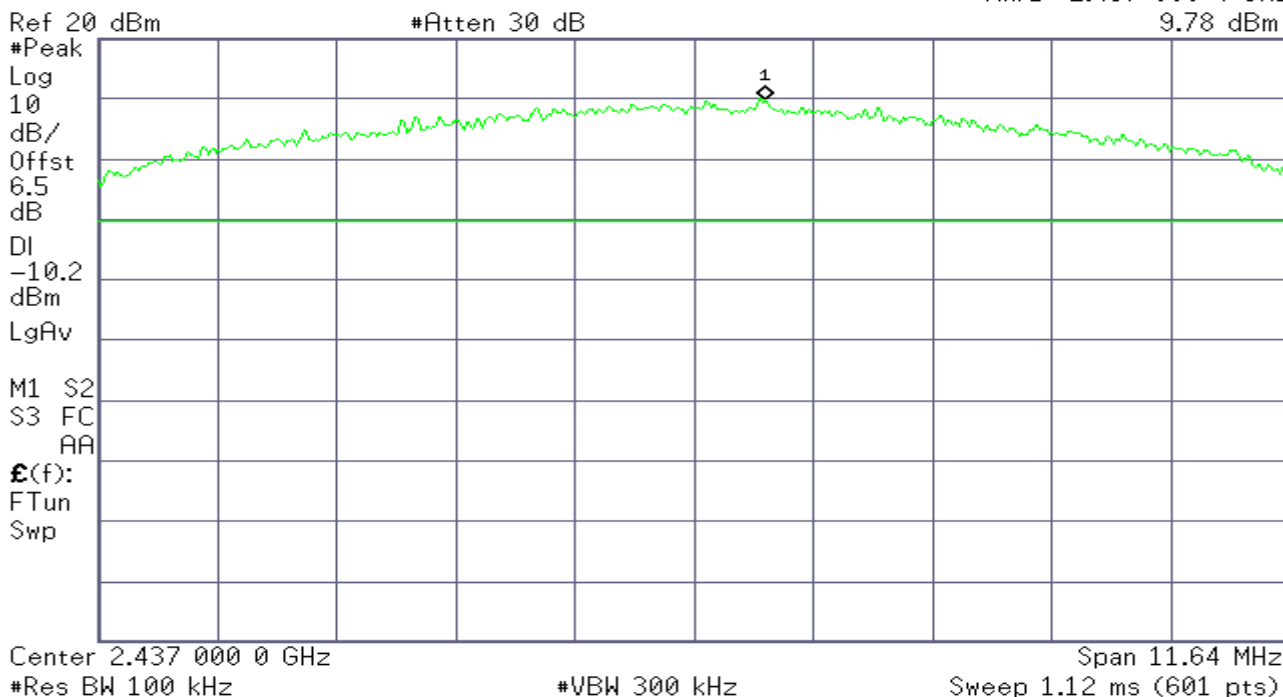

Agilent

**R T**  
 Mkr1 2.279 2 GHz  
 -53.12 dBm

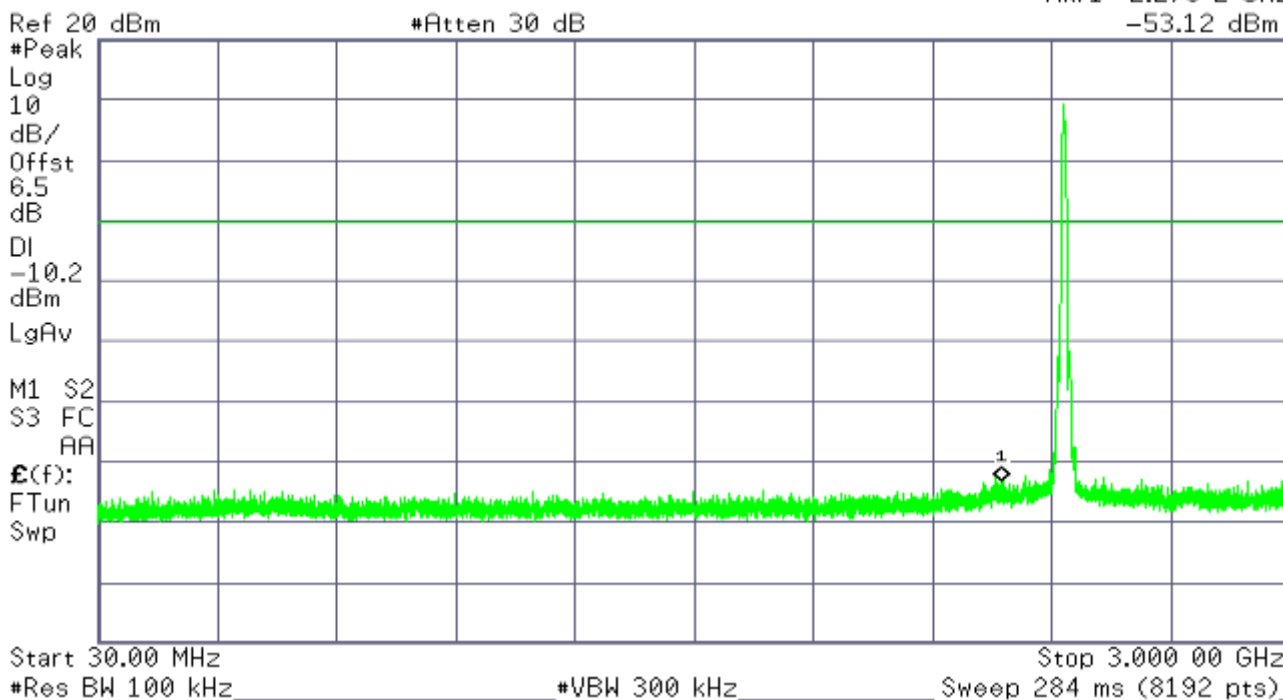

**Agilent**

**R T**

Mkr1 24.750 1 GHz  
 -44.62 dBm

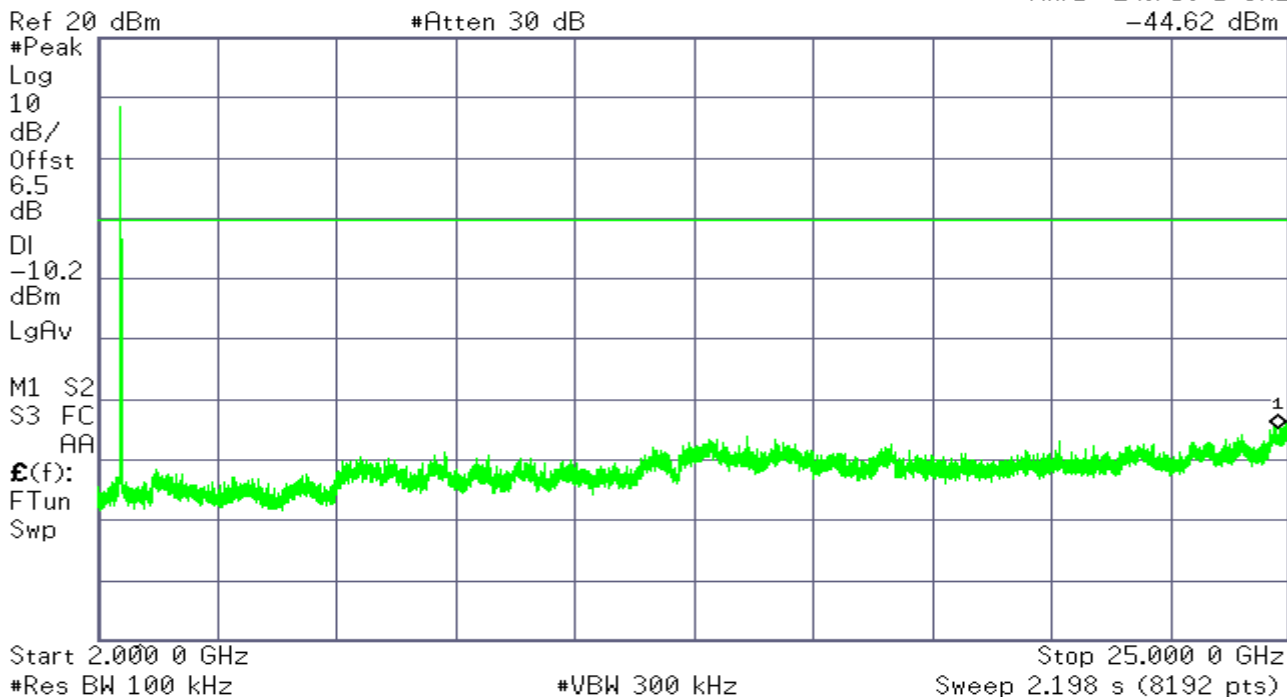

**CH High**

**Agilent**

**R T**

Mkr1 2.462 737 2 GHz  
 9.89 dBm

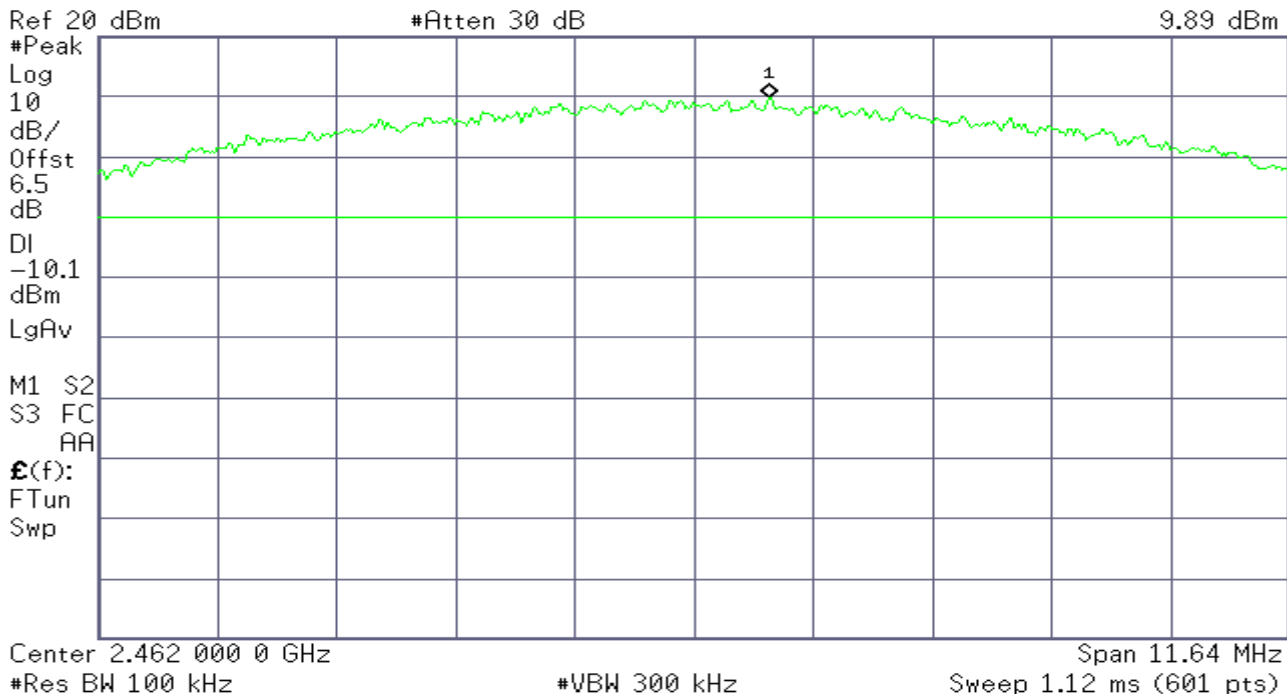

**Agilent**

**R T**

Mkr2 2.487 801 GHz  
 -48.56 dBm

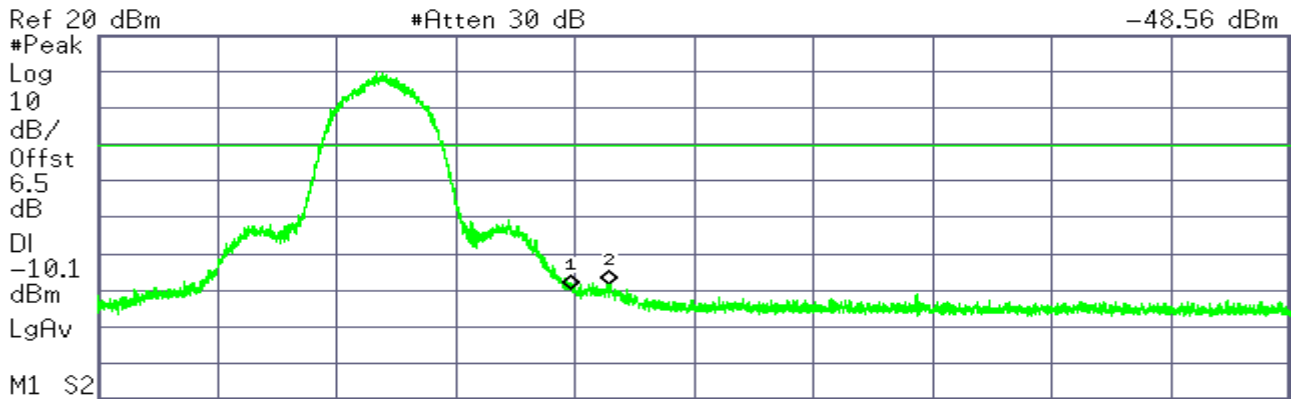

Start 2.430 000 GHz Stop 2.565 000 GHz  
 #Res BW 100 kHz #VBW 300 kHz Sweep 13.11 ms (8192 pts)

Marker	Trace	Type	X Axis	Amplitude
1	(1)	Freq	2.483 500 GHz	-49.50 dBm
2	(1)	Freq	2.487 801 GHz	-48.56 dBm

**Agilent**

**R T**

Mkr1 385.0 MHz  
 -54.55 dBm

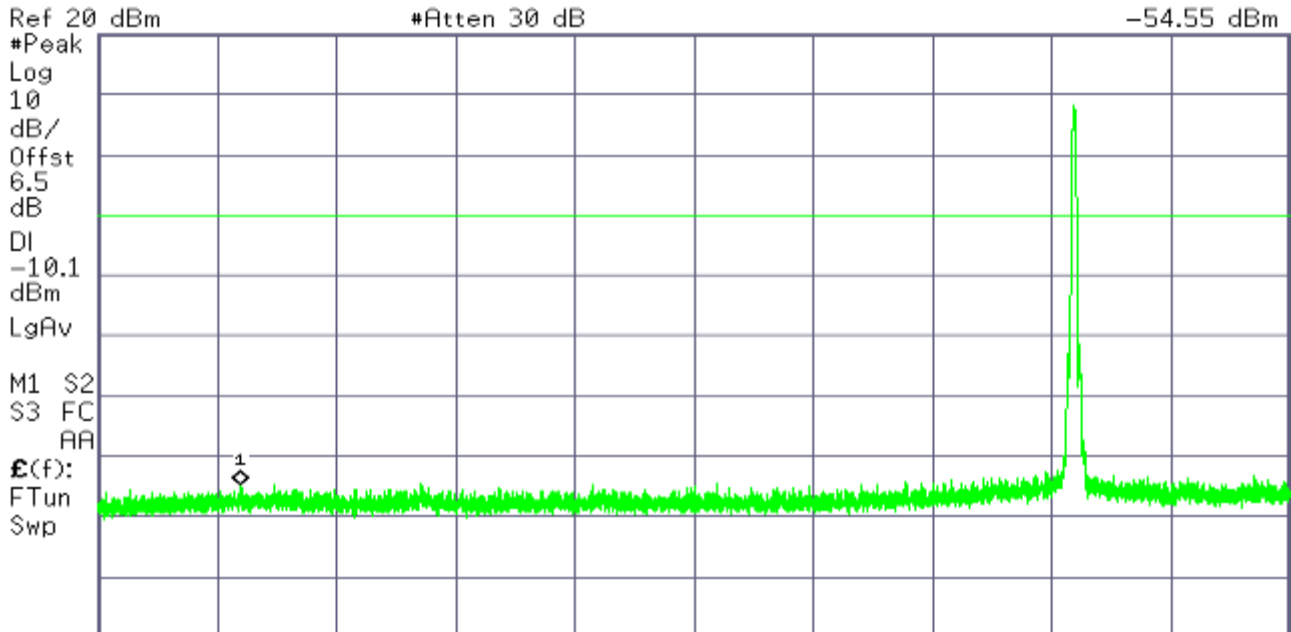

Start 30.0 MHz Stop 3.000 0 GHz  
 #Res BW 100 kHz #VBW 300 kHz Sweep 284 ms (8192 pts)

**Agilent**

**R T**

Mkr1 24.738 9 GHz  
 -43.51 dBm

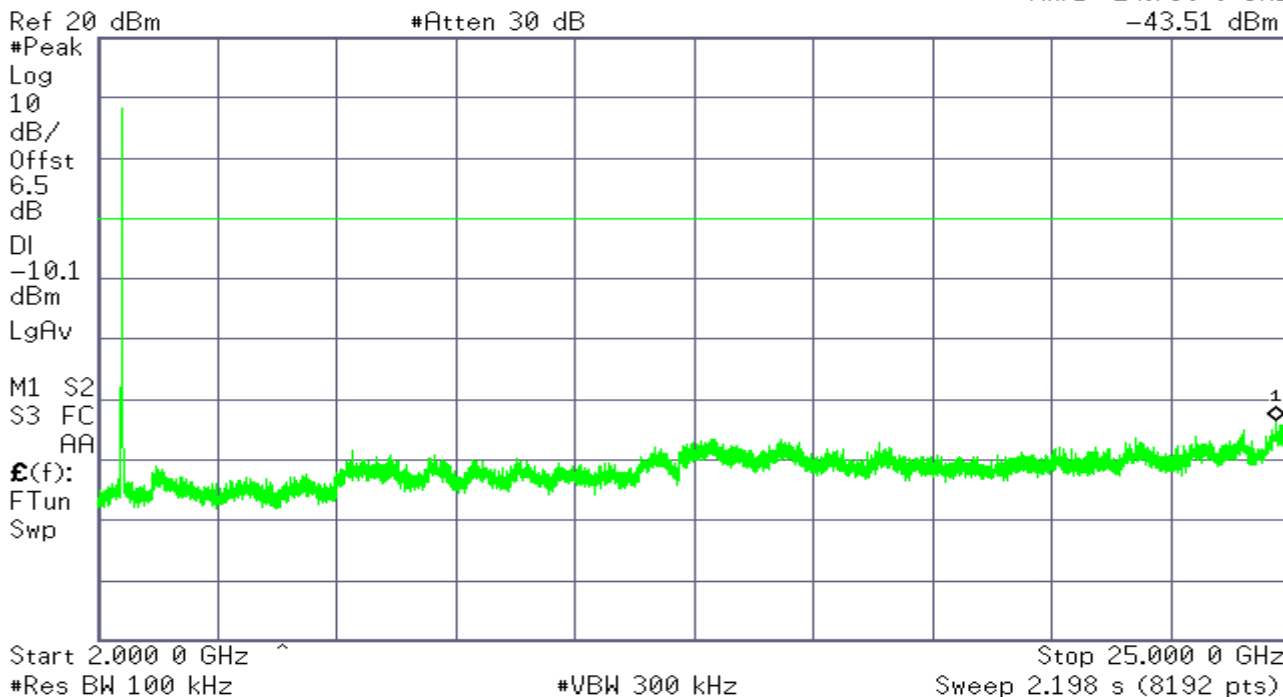

**IEEE 802.11g mode**

**CH Low**

**Agilent**

**R T**

Mkr1 2.413 37 GHz  
 -0.73 dBm



**Agilent**

**R T**

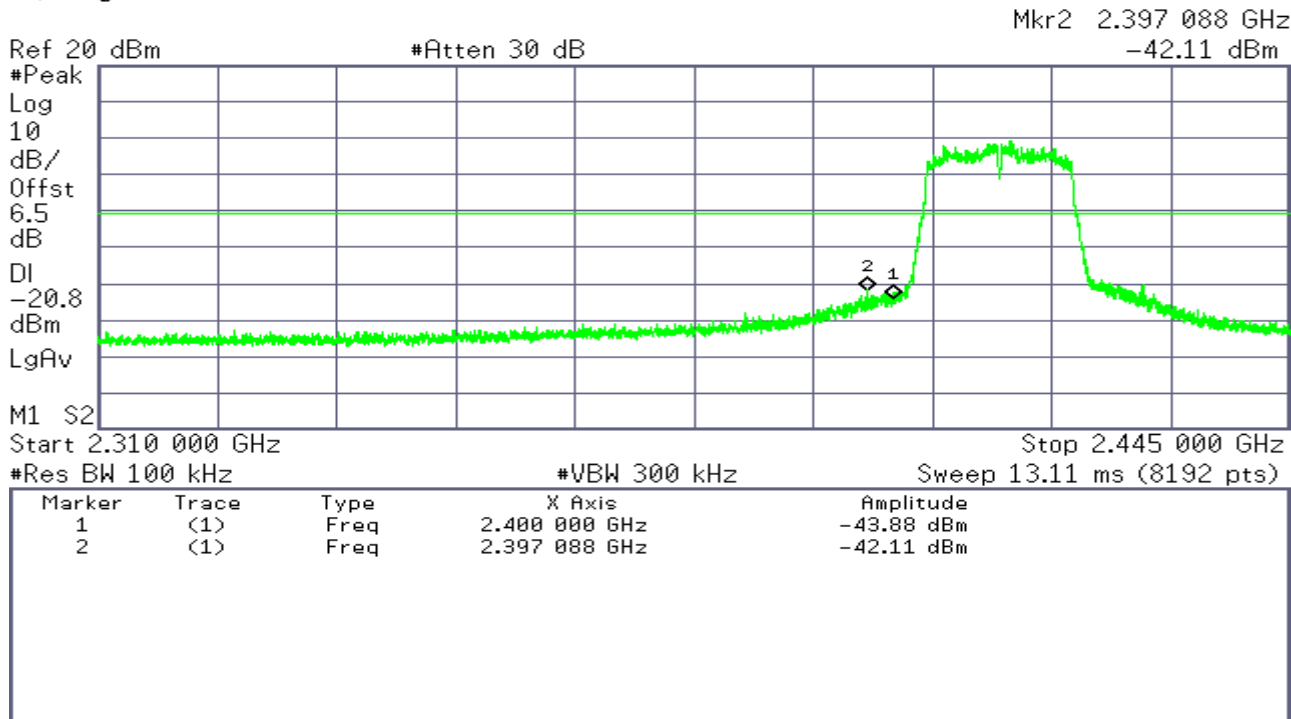

**Agilent**

**R T**

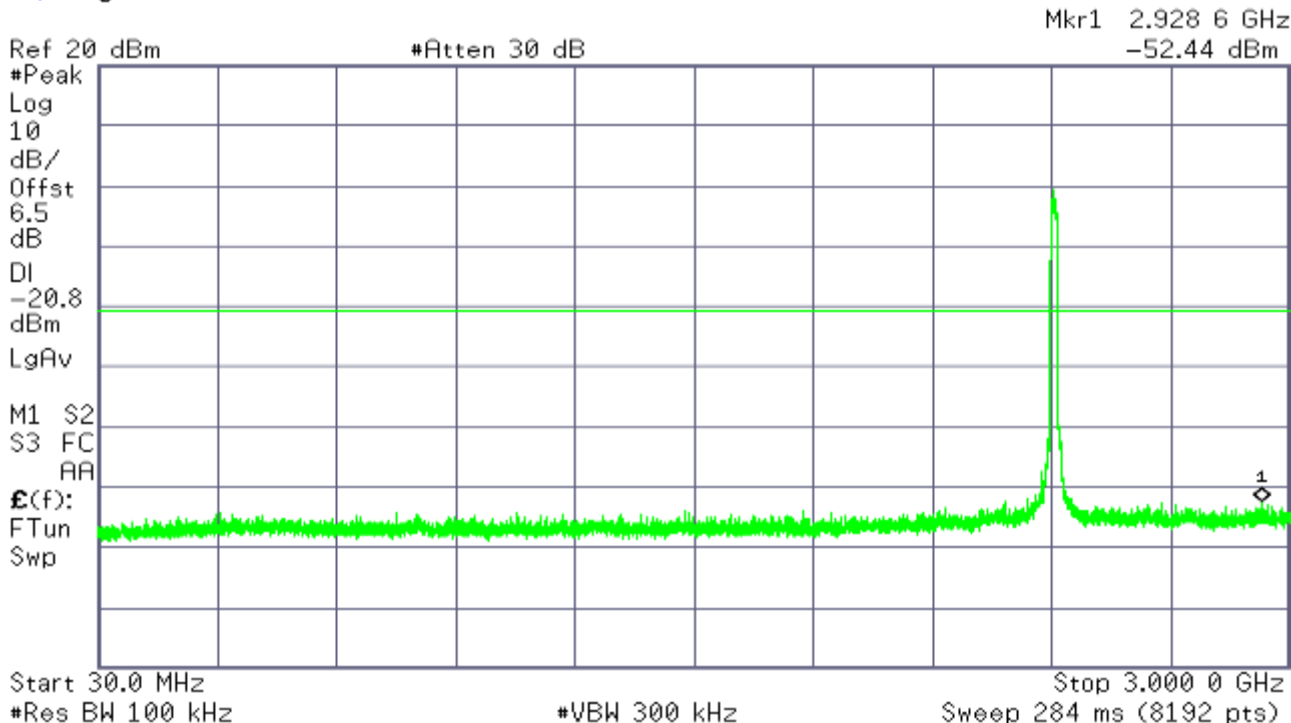

**Agilent**

**R T**

Mkr1 24.870 8 GHz  
 -44.90 dBm

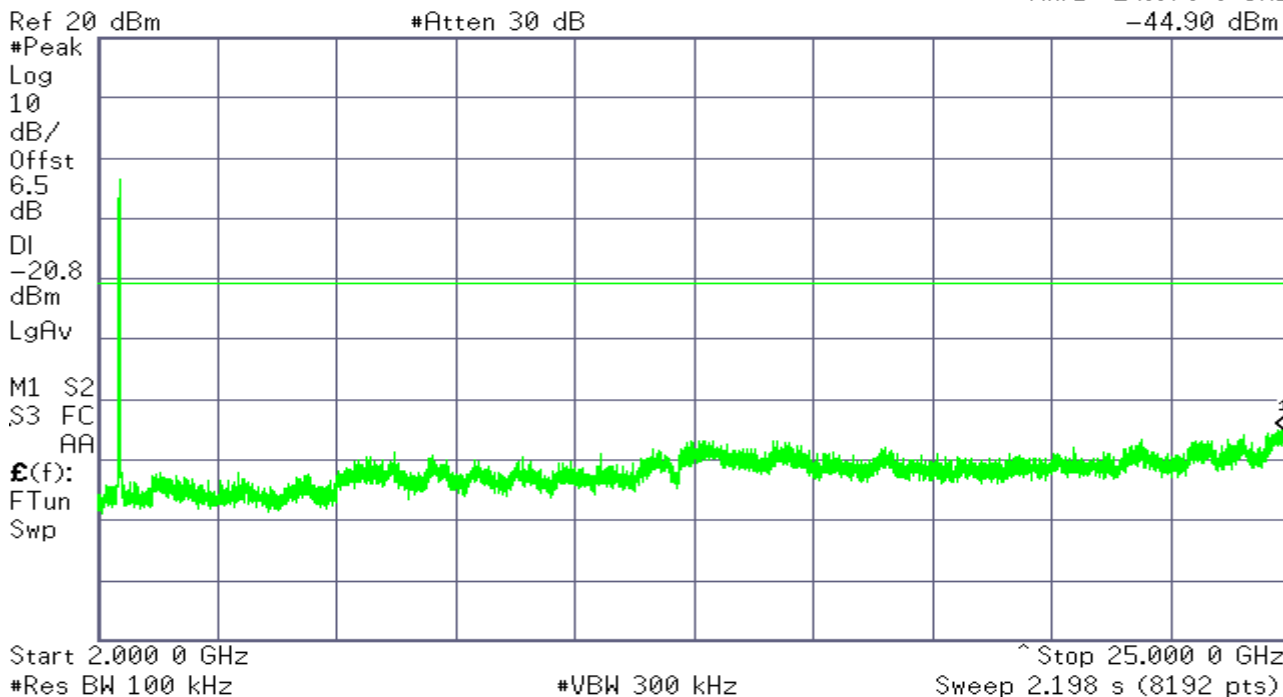

**CH Mid**

**Agilent**

**R T**

Mkr1 2.438 37 GHz  
 -0.60 dBm



**Agilent**

**R T**

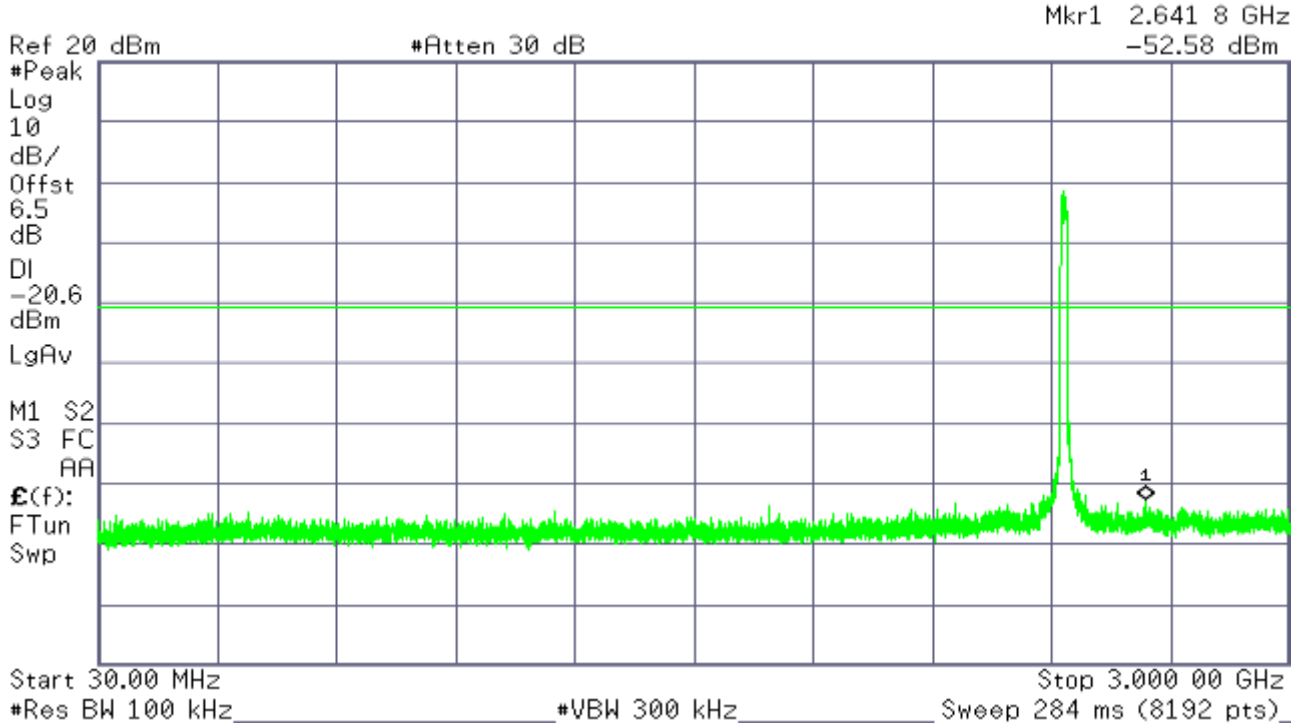

**Agilent**

**R T**

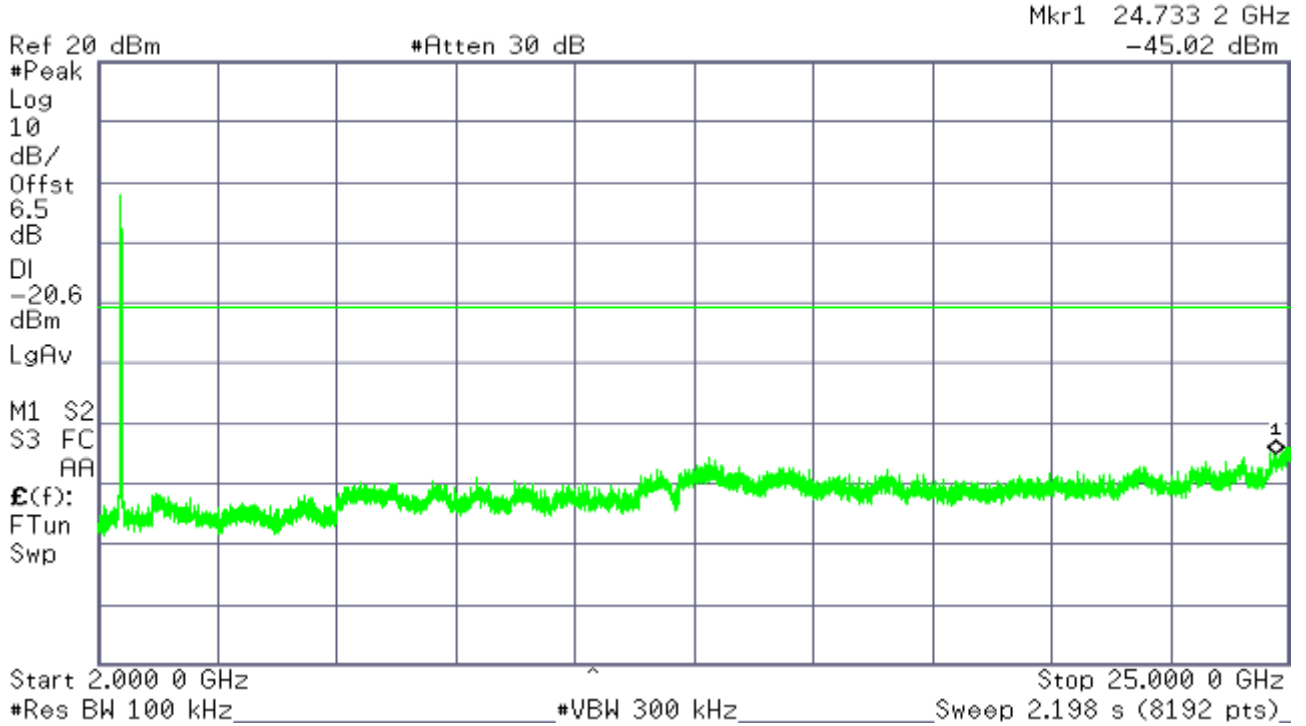



**CH High**

Agilent

R T

Mkr1 2.463 41 GHz  
-0.90 dBm

Ref 20 dBm

#Atten 30 dB

#Peak

Log

10

dB/

Offst

6.5

dB

DI

-20.9

dBm

LgAv

M1 S2

S3 FC

RA

£(f):

FTun

Swp

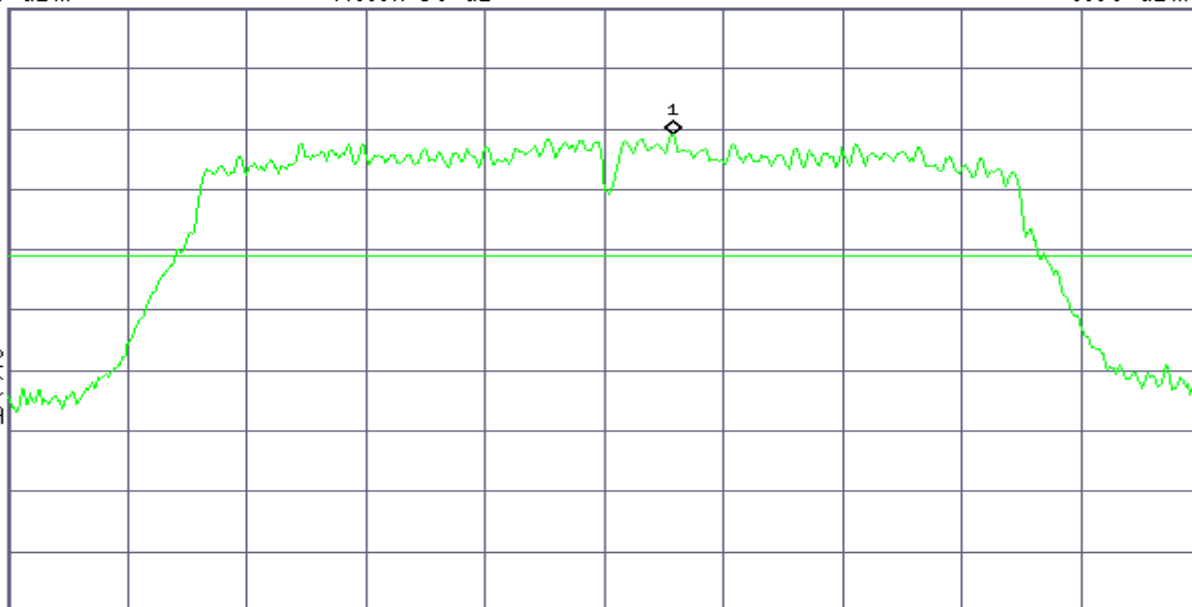

Start 2.449 95 GHz

Stop 2.474 05 GHz

#Res BW 100 kHz

#VBW 300 kHz

Sweep 2.32 ms (601 pts)

Agilent

R T

Mkr2 2.486 680 GHz  
-47.85 dBm

Ref 20 dBm

#Atten 30 dB

#Peak

Log

10

dB/

Offst

6.5

dB

DI

-20.9

dBm

LgAv

M1 S2

S3 FC

RA

£(f):

FTun

Swp

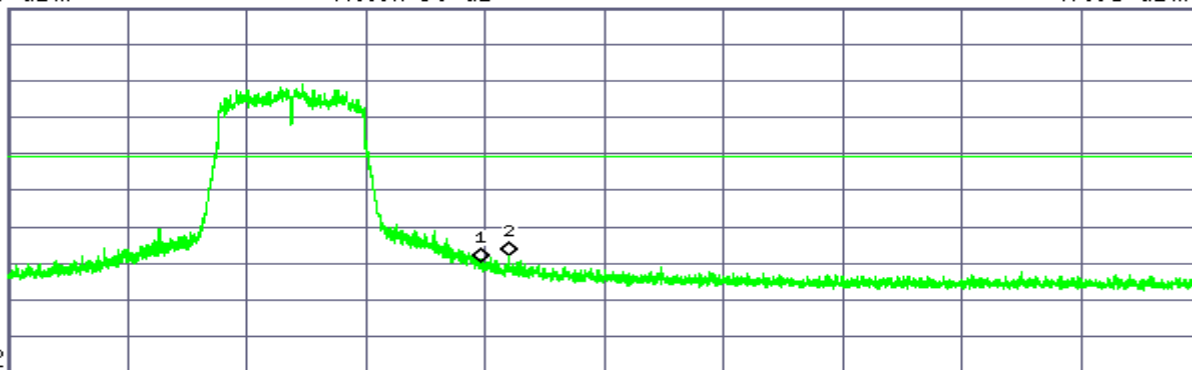

Start 2.430 000 GHz

Stop 2.565 000 GHz

#Res BW 100 kHz

#VBW 300 kHz

Sweep 13.11 ms (8192 pts)

Marker	Trace	Type	X Axis	Amplitude
1	(1)	Freq	2.483 500 GHz	-49.65 dBm
2	(1)	Freq	2.486 680 GHz	-47.85 dBm

Agilent

R T

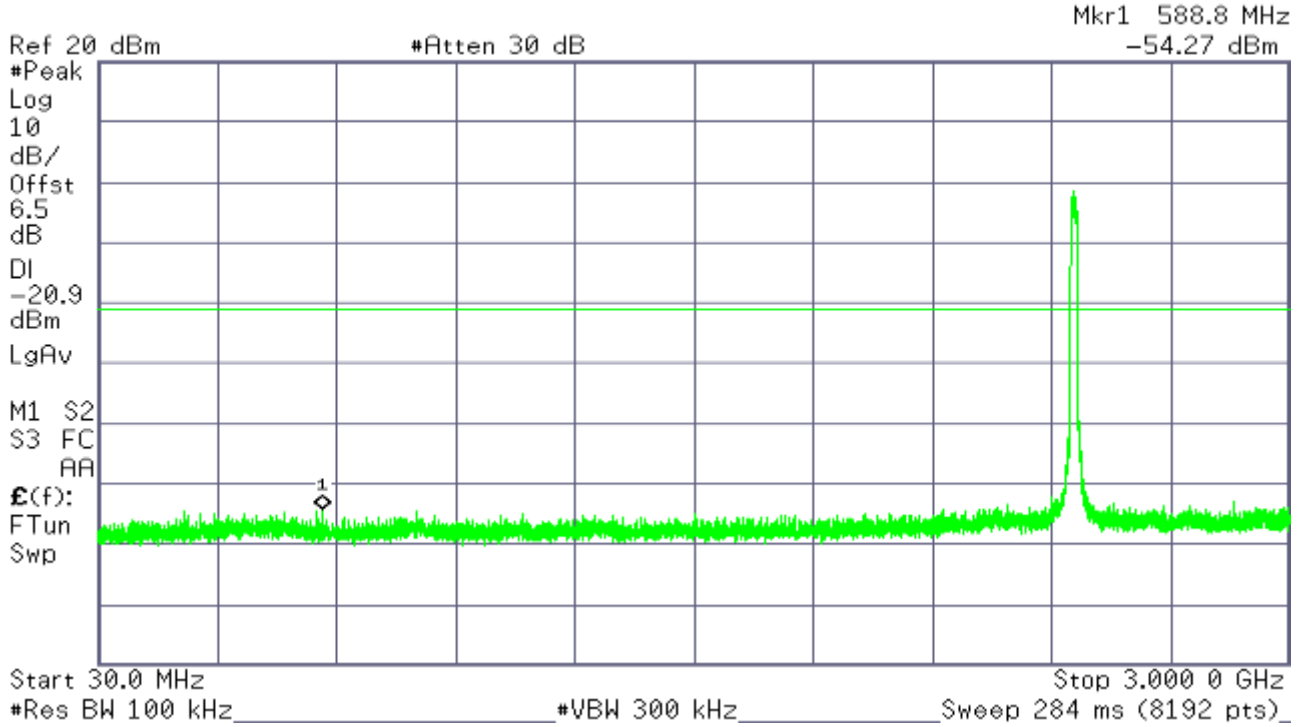

Agilent

R T

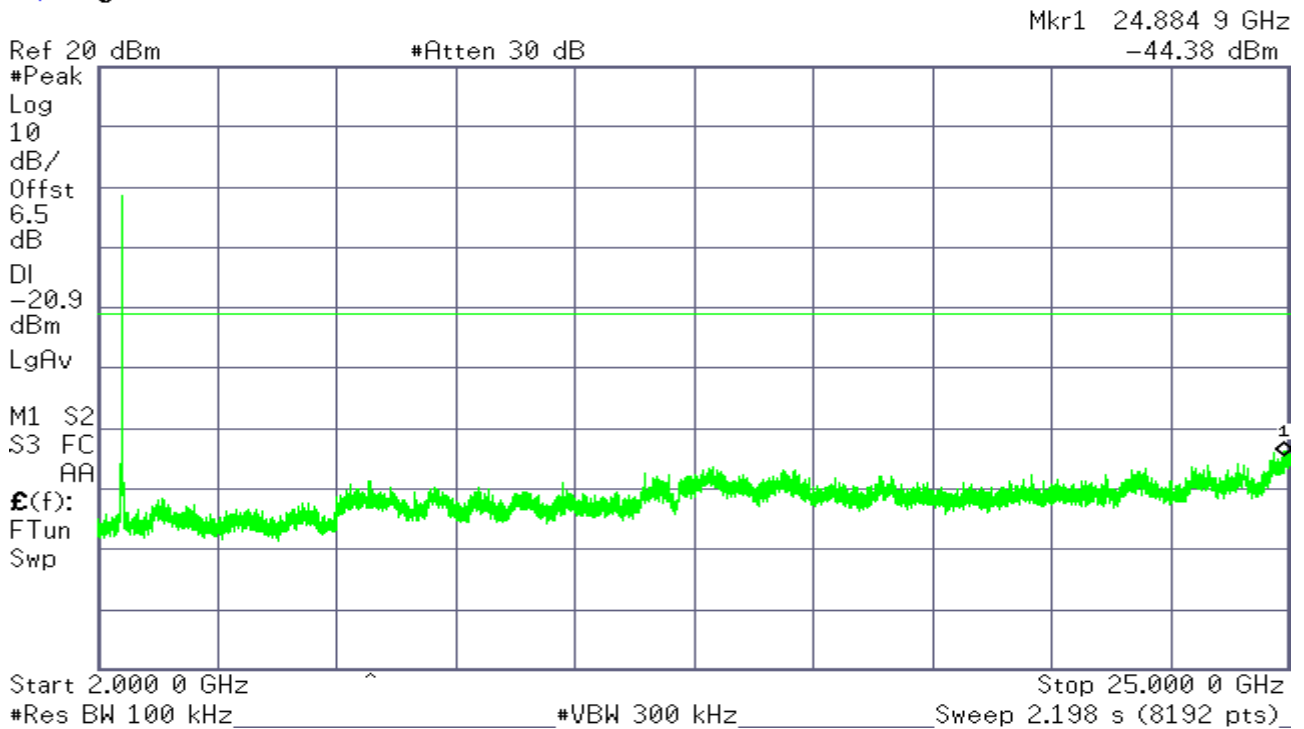

**IEEE 802.11n HT20 mode**

**CH Low**

**Agilent**

**R T**

Mkr1 2.413 38 GHz  
-0.69 dBm

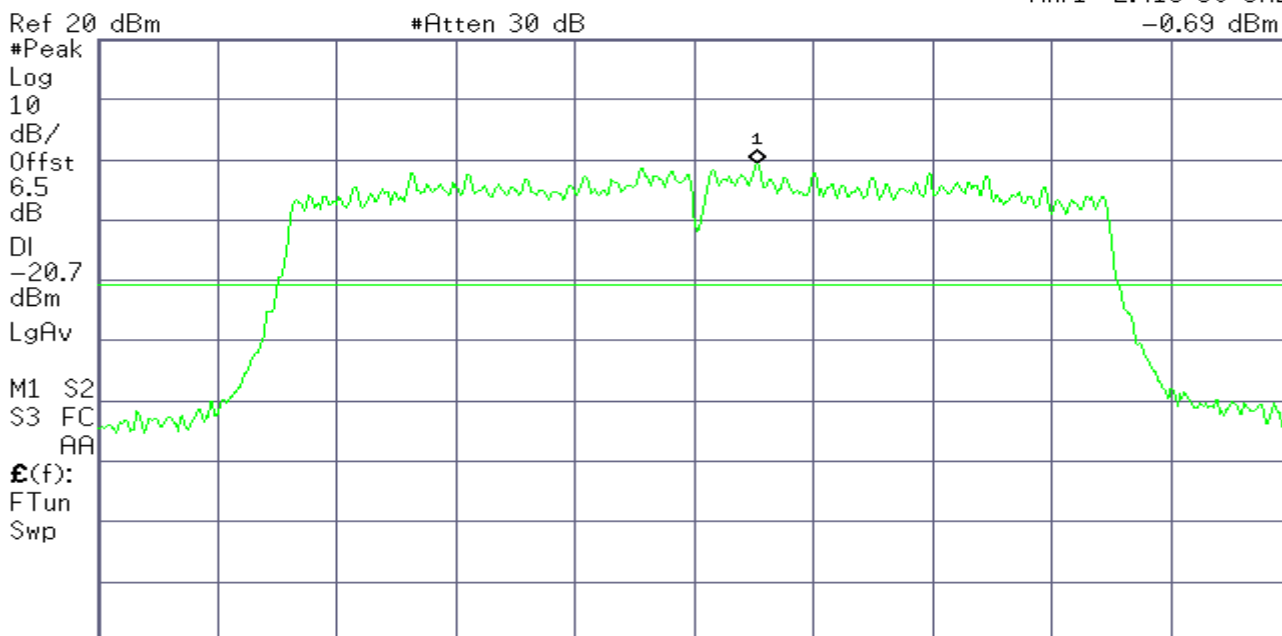

Center 2.412 00 GHz Span 25.91 MHz  
#Res BW 100 kHz #VBW 300 kHz Sweep 2.48 ms (601 pts)

**Agilent**

**R T**

Mkr2 2.397 072 GHz  
-43.11 dBm

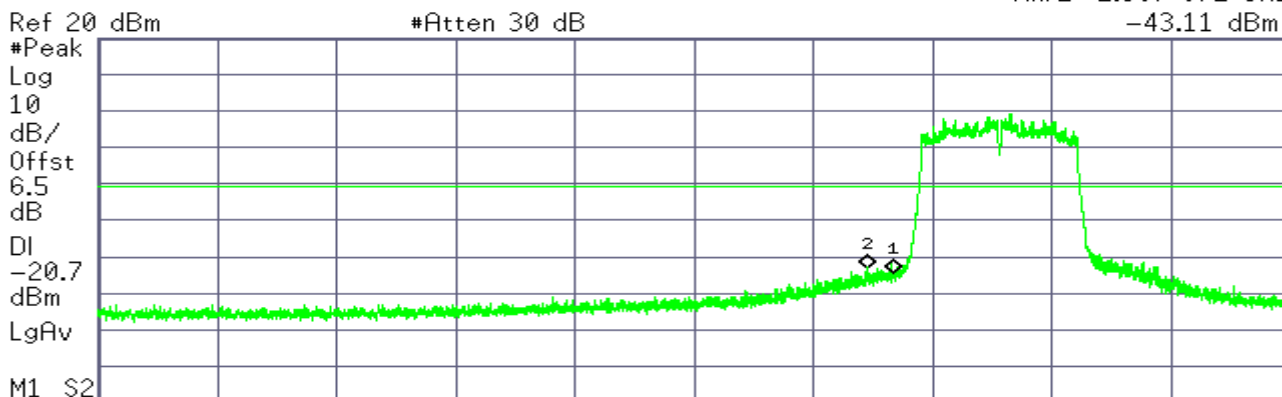

Start 2.310 000 GHz Stop 2.445 000 GHz  
#Res BW 100 kHz #VBW 300 kHz Sweep 13.11 ms (8192 pts)

Marker	Trace	Type	X Axis	Amplitude
1	(1)	Freq	2.400 000 GHz	-44.68 dBm
2	(1)	Freq	2.397 072 GHz	-43.11 dBm

**Agilent**

**R T**

Ref 20 dBm

#Atten 30 dB

Mkr1 2.241 1 GHz  
 -52.43 dBm

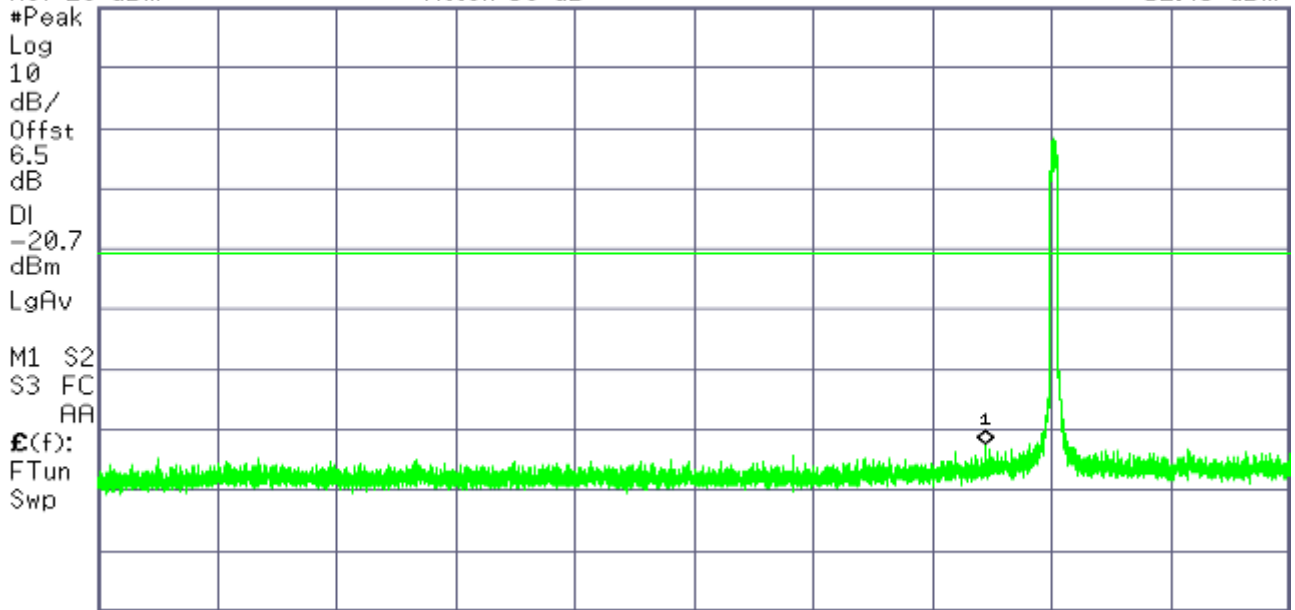

Start 30.0 MHz

Stop 3.000 0 GHz

#Res BW 100 kHz

#VBW 300 kHz

Sweep 284 ms (8192 pts)

**Agilent**

**R T**

Ref 20 dBm

#Atten 30 dB

Mkr1 24.820 3 GHz  
 -44.27 dBm

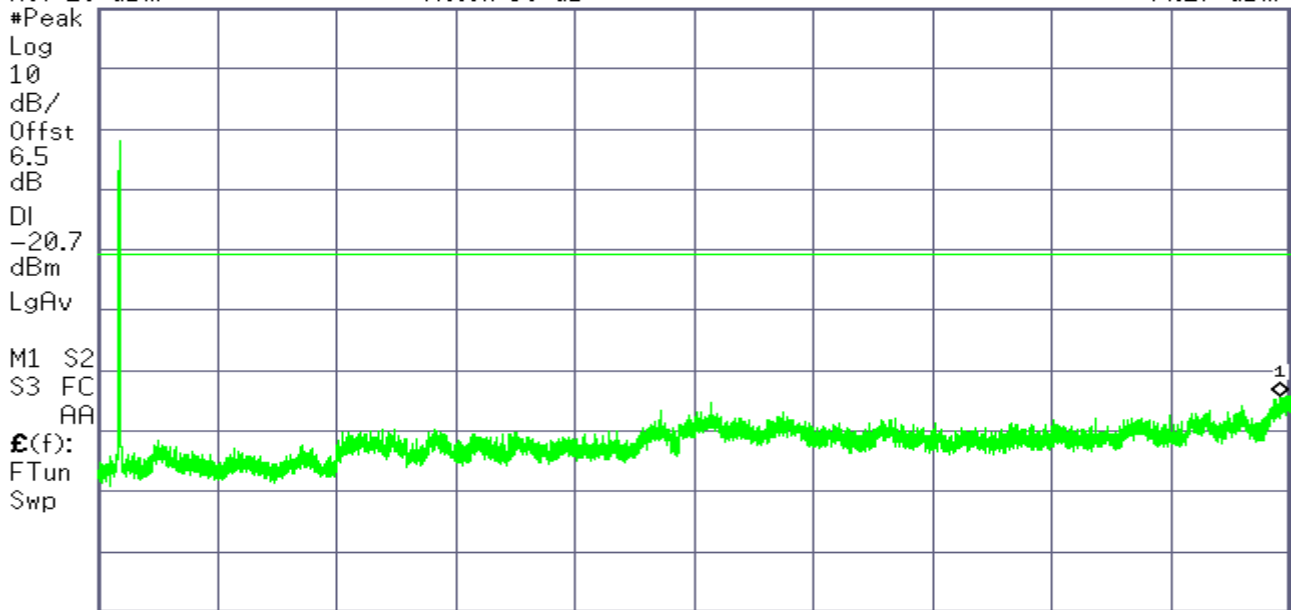

Start 2.000 0 GHz

Stop 25.000 0 GHz

#Res BW 100 kHz

#VBW 300 kHz

Sweep 2.198 s (8192 pts)

**CH Mid**

Agilent

R T

Mkr1 2.438 38 GHz  
 -0.79 dBm

Ref 20 dBm

#Atten 30 dB

#Peak

Log

10

dB/

Offst

6.5

dB

DI

-20.8

dBm

LgAv

M1 S2

S3 FC

RA

$\mathcal{E}(f)$ :

FTun

Swp

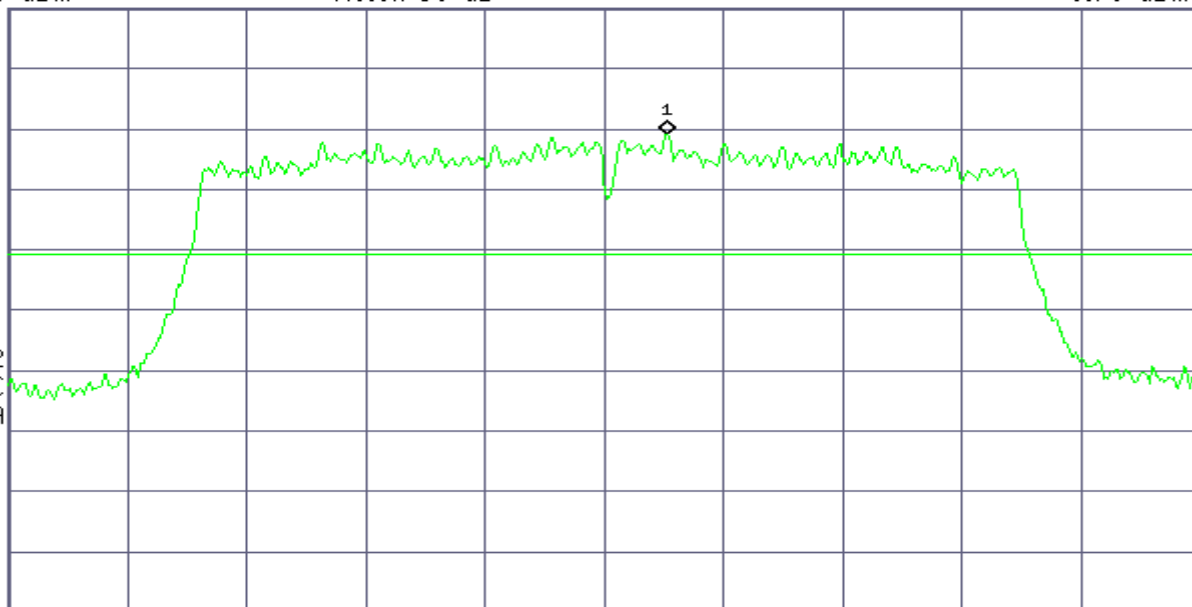

Center 2.437 00 GHz

Span 25.91 MHz

#Res BW 100 kHz

#VBW 300 kHz

Sweep 2.48 ms (601 pts)

Agilent

R T

Mkr1 2.753 1 GHz  
 -52.23 dBm

Ref 20 dBm

#Atten 30 dB

#Peak

Log

10

dB/

Offst

6.5

dB

DI

-20.8

dBm

LgAv

M1 S2

S3 FC

RA

$\mathcal{E}(f)$ :

FTun

Swp

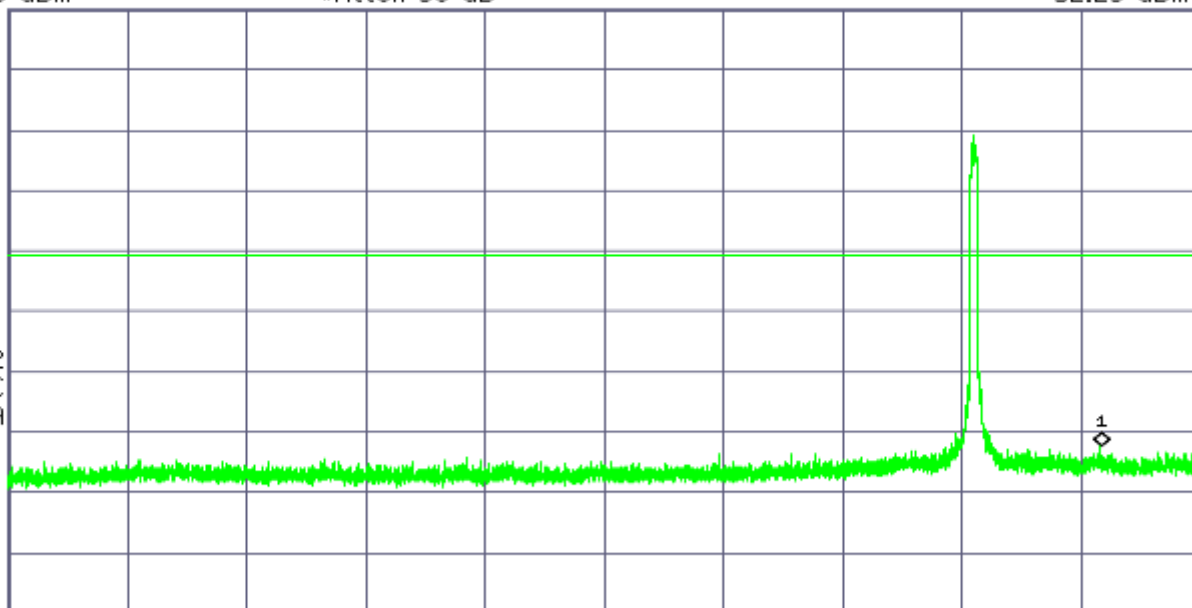

Start 30.0 MHz

Stop 3.000 0 GHz

#Res BW 100 kHz

#VBW 300 kHz

Sweep 284 ms (8192 pts)

**Agilent**

**R T**

Mkr1 24.957 9 GHz  
 -45.10 dBm

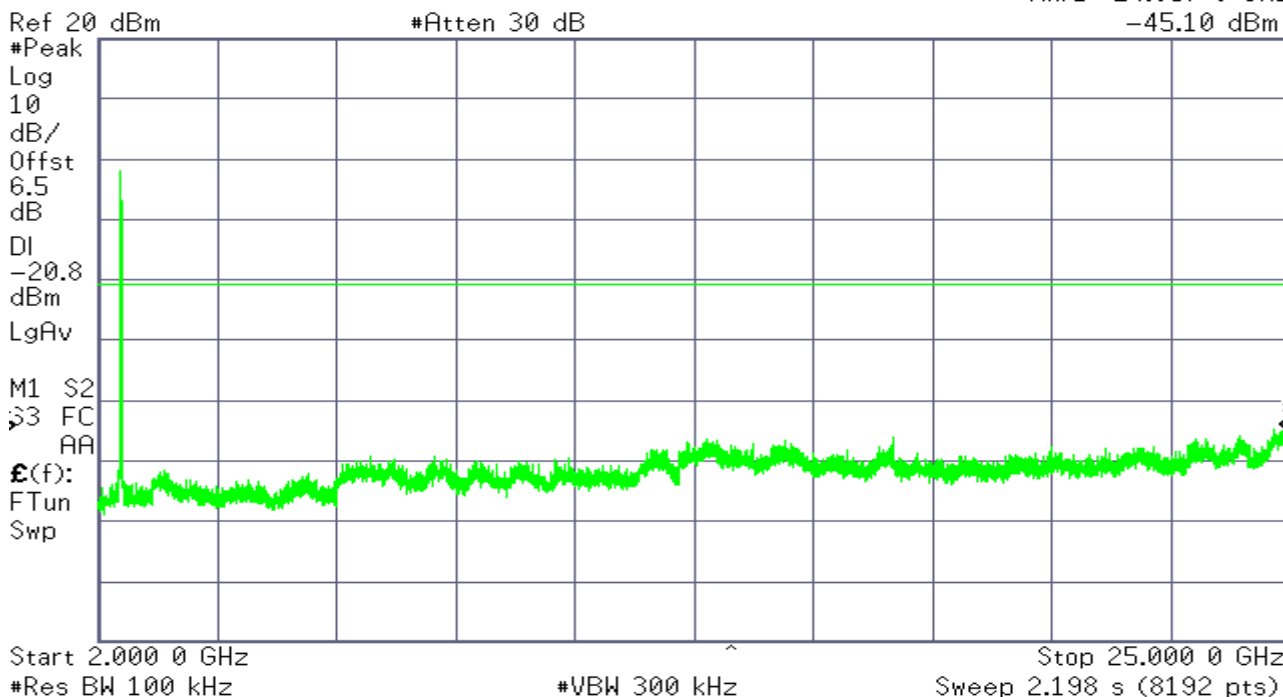

**CH High**

**Agilent**

**R T**

Mkr1 2.463 38 GHz  
 -0.87 dBm

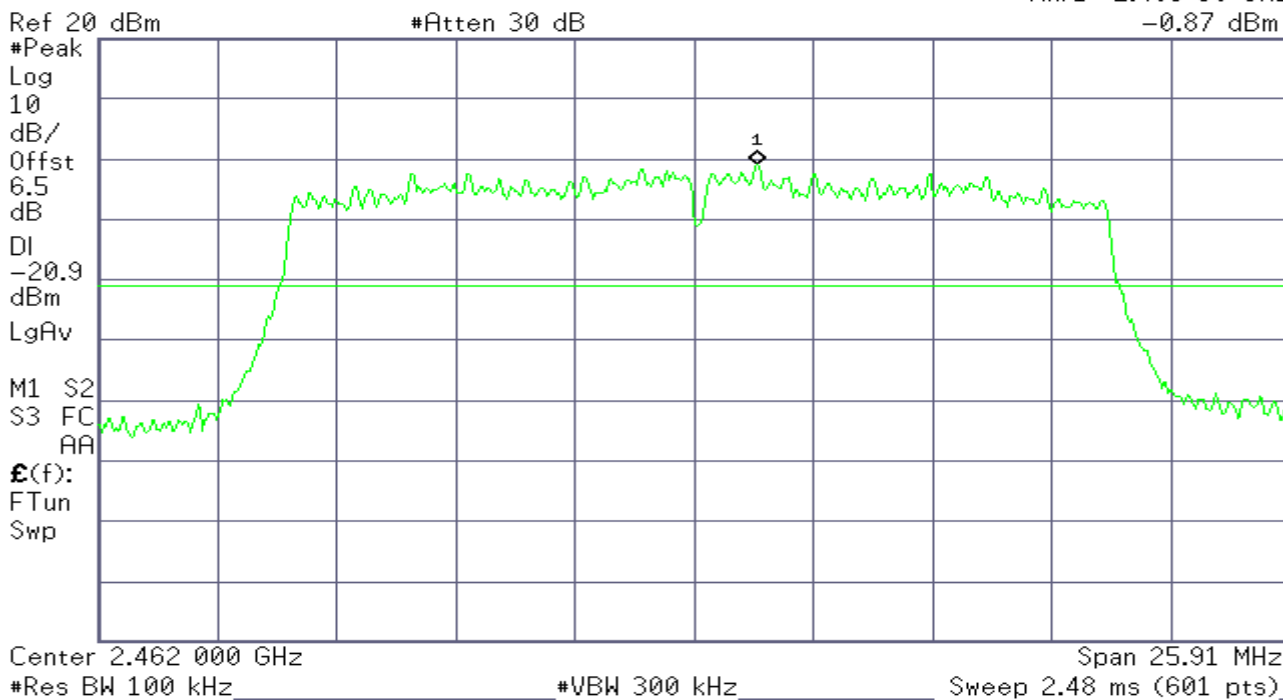

**Agilent**

**R T**

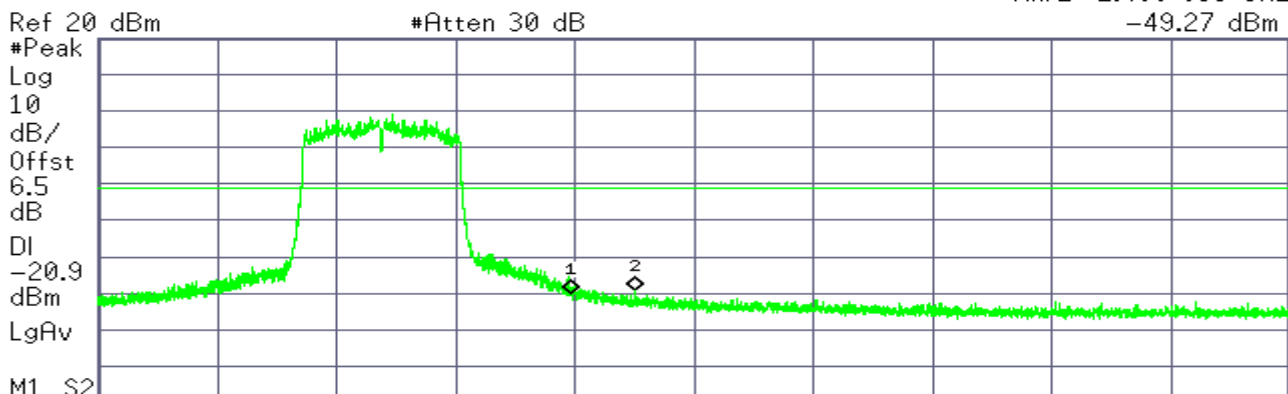

#Res BW 100 kHz #VBW 300 kHz Sweep 13.11 ms (8192 pts)

Marker	Trace	Type	X Axis	Amplitude
1	(1)	Freq	2.483 500 GHz	-50.03 dBm
2	(1)	Freq	2.490 833 GHz	-49.27 dBm

**Agilent**

**R T**

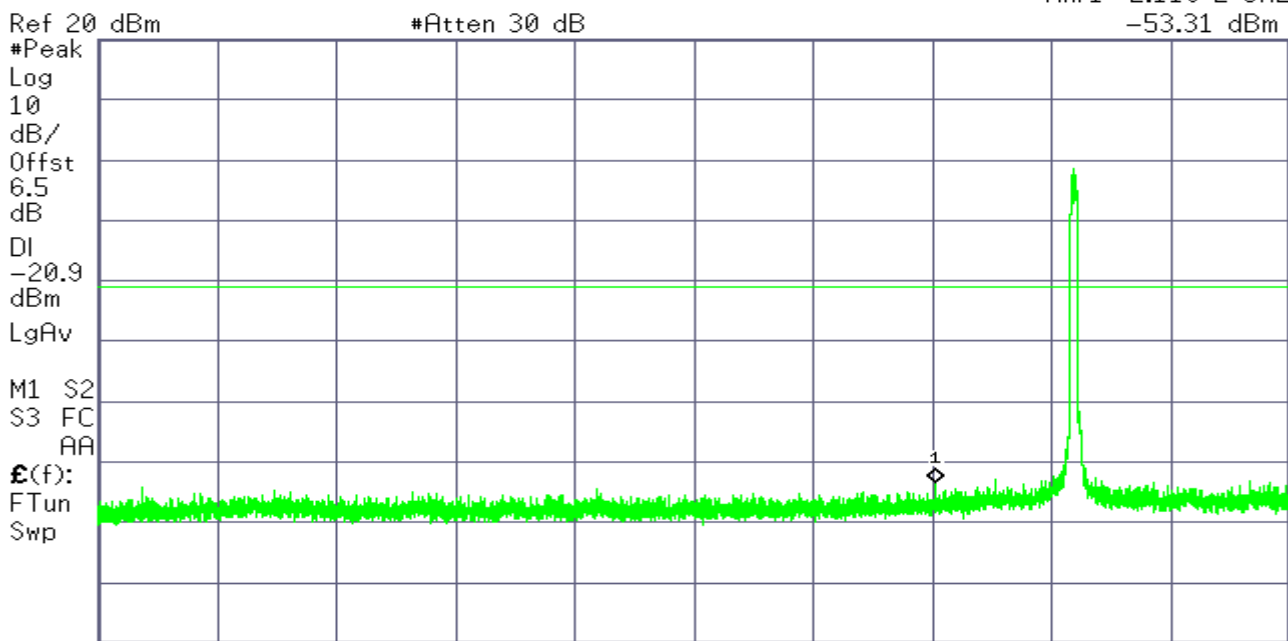

#Res BW 100 kHz #VBW 300 kHz Sweep 284 ms (8192 pts)

Agilent

R T

Mkr1 24.719 2 GHz  
-44.29 dBm

Ref 20 dBm

#Atten 30 dB

#Peak

Log

10

dB/

Offst

6.5

dB

DI

-20.9

dBm

LgAv

M1 S2

S3 FC

AA

$\mathcal{E}(f)$ :

FTun

Swp

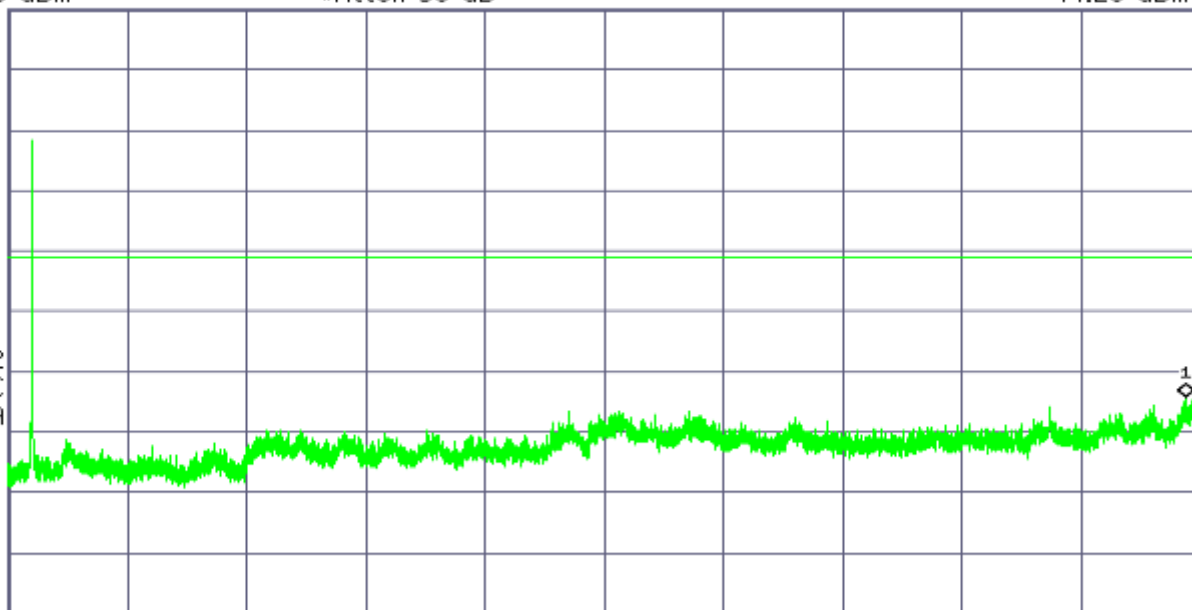

Start 2.000 0 GHz

Stop 25.000 0 GHz

#Res BW 100 kHz

#VBW 300 kHz

Sweep 2.198 s (8192 pts)

**IEEE 802.11n HT40 mode**

**CH Low**

Agilent

R T

Mkr1 2.419 62 GHz  
-4.51 dBm

Ref 20 dBm

#Atten 30 dB

#Peak

Log

10

dB/

Offst

6.5

dB

DI

-24.5

dBm

LgAv

M1 S2

S3 FC

AA

$\mathcal{E}(f)$ :

FTun

Swp

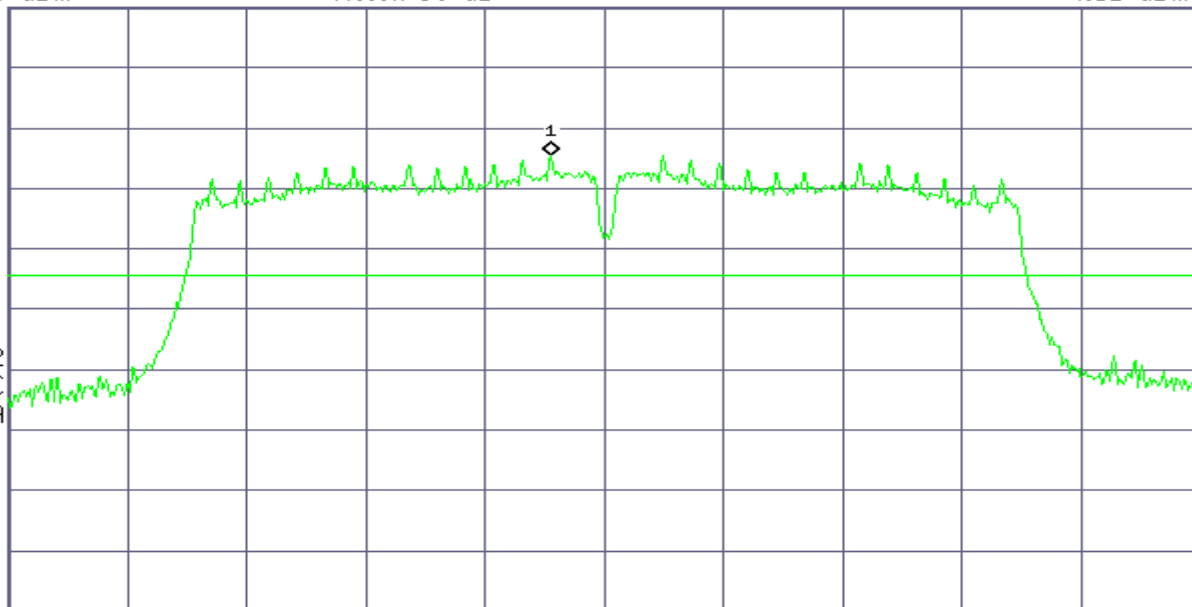

Center 2.422 00 GHz

Span 52.84 MHz

#Res BW 100 kHz

#VBW 300 kHz

Sweep 5.08 ms (601 pts)



**Agilent**

**R T**

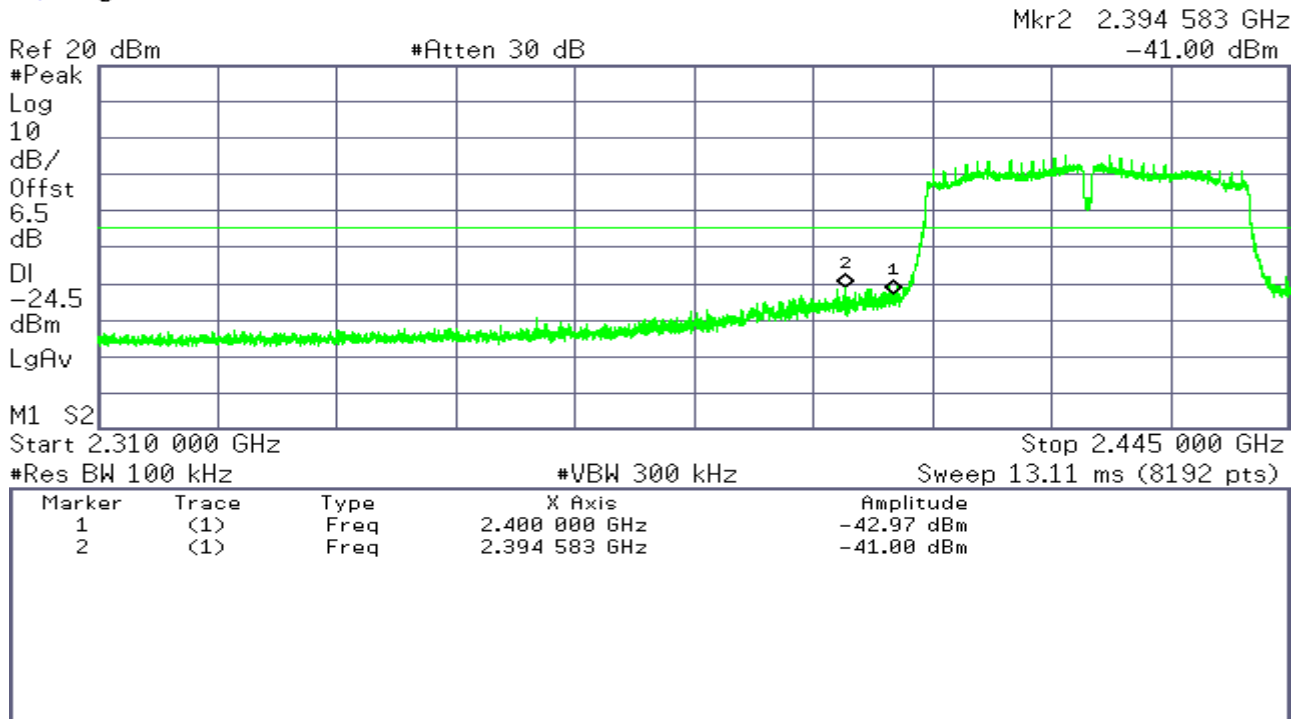

**Agilent**

**R T**

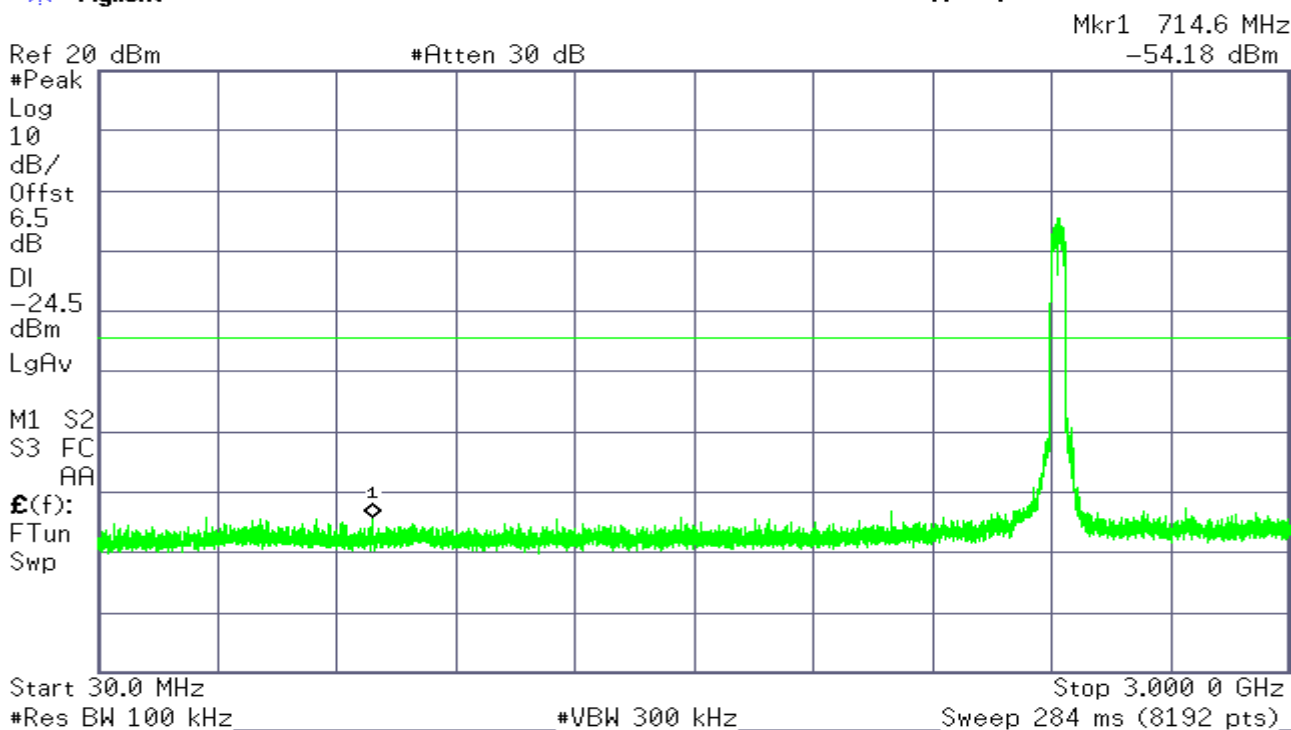

**Agilent**

**R T**

Mkr1 24.679 9 GHz  
 -45.01 dBm

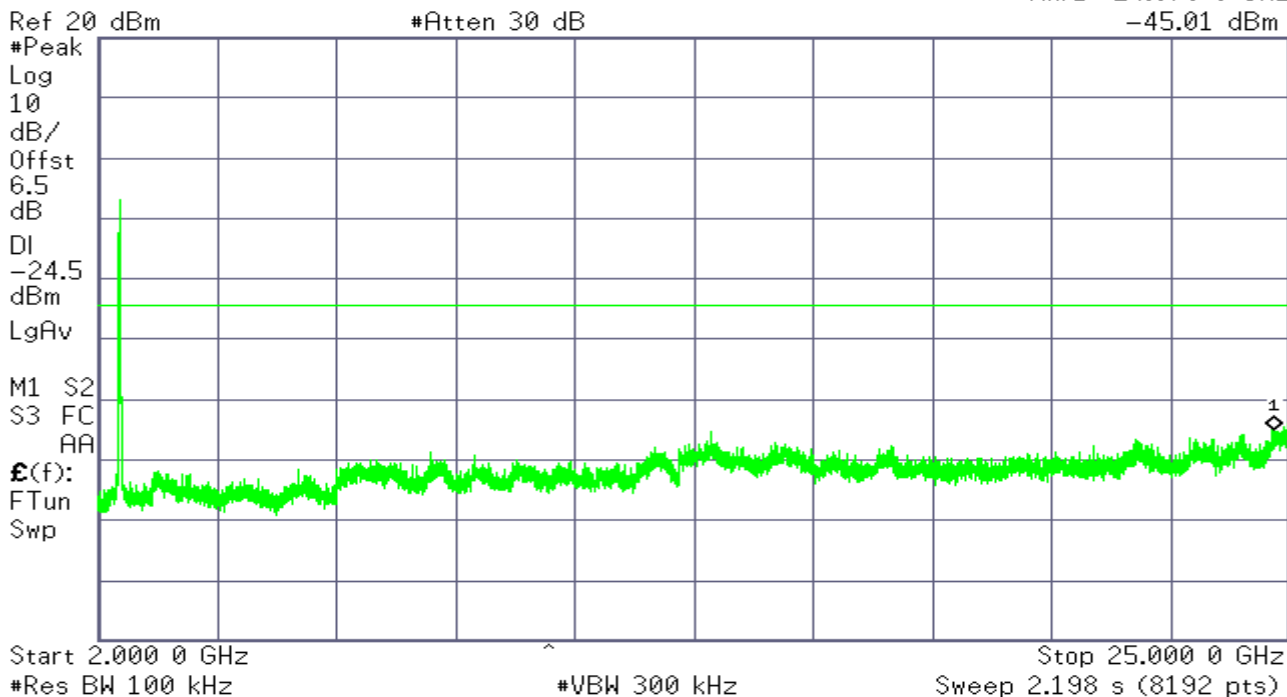

**CH Mid**

**Agilent**

**R T**

Mkr1 2.434 62 GHz  
 -4.52 dBm

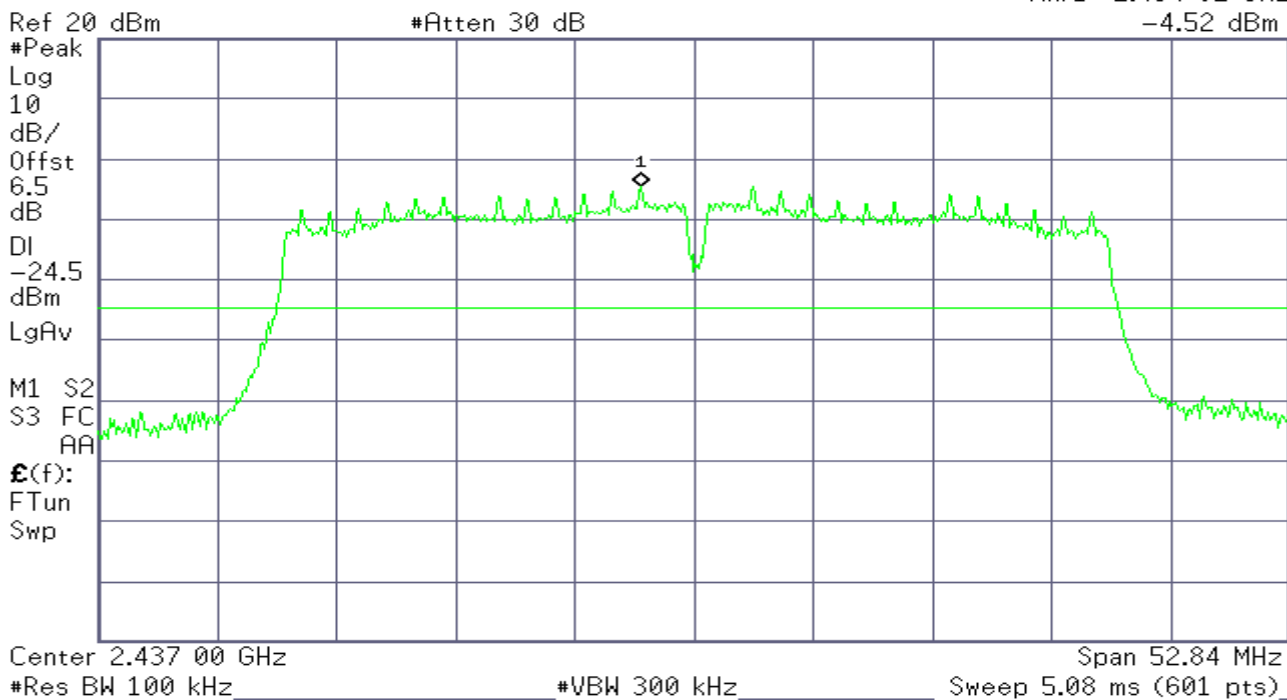

**Agilent**

**R T**

Mkr1 2.737 8 GHz  
 -53.27 dBm

Ref 20 dBm

#Atten 30 dB

#Peak  
 Log  
 10  
 dB/  
 Offst  
 6.5  
 dB  
 DI  
 -24.5  
 dBm  
 LgAv

M1 S2  
 S3 FC  
 AA

£(f):  
 FTun  
 Swp

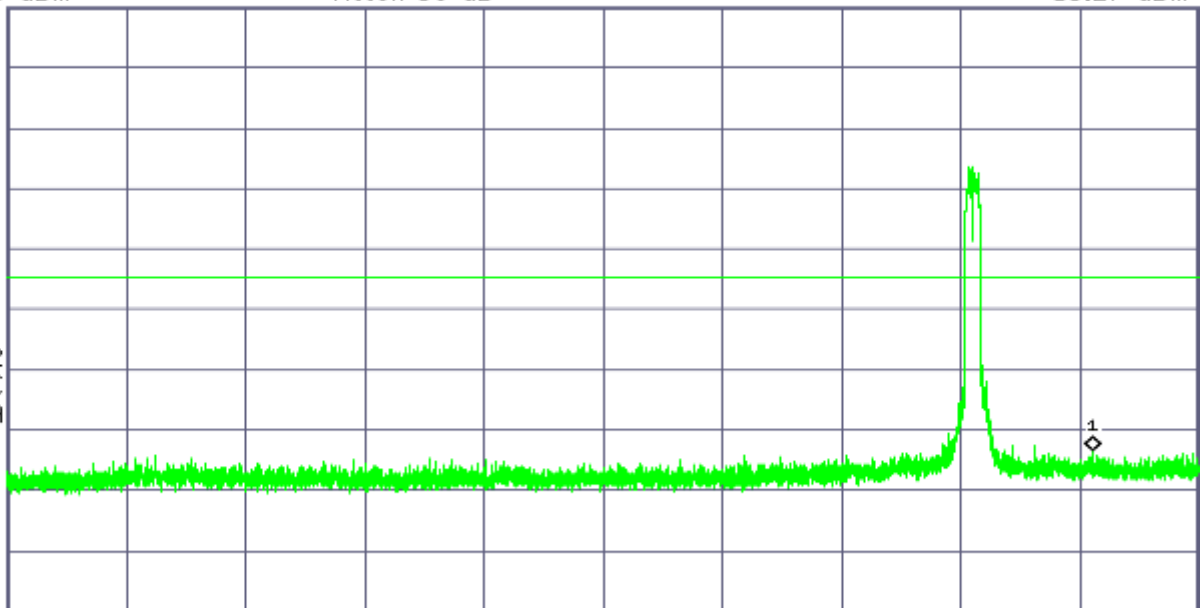

Start 30.00 MHz

Stop 3.000 00 GHz

#Res BW 100 kHz

#VBW 300 kHz

Sweep 284 ms (8192 pts)

**Agilent**

**R T**

Mkr1 24.915 8 GHz  
 -44.33 dBm

Ref 20 dBm

#Atten 30 dB

#Peak  
 Log  
 10  
 dB/  
 Offst  
 6.5  
 dB  
 DI  
 -24.5  
 dBm  
 LgAv

M1 S2  
 S3 FC  
 AA

£(f):  
 FTun  
 Swp

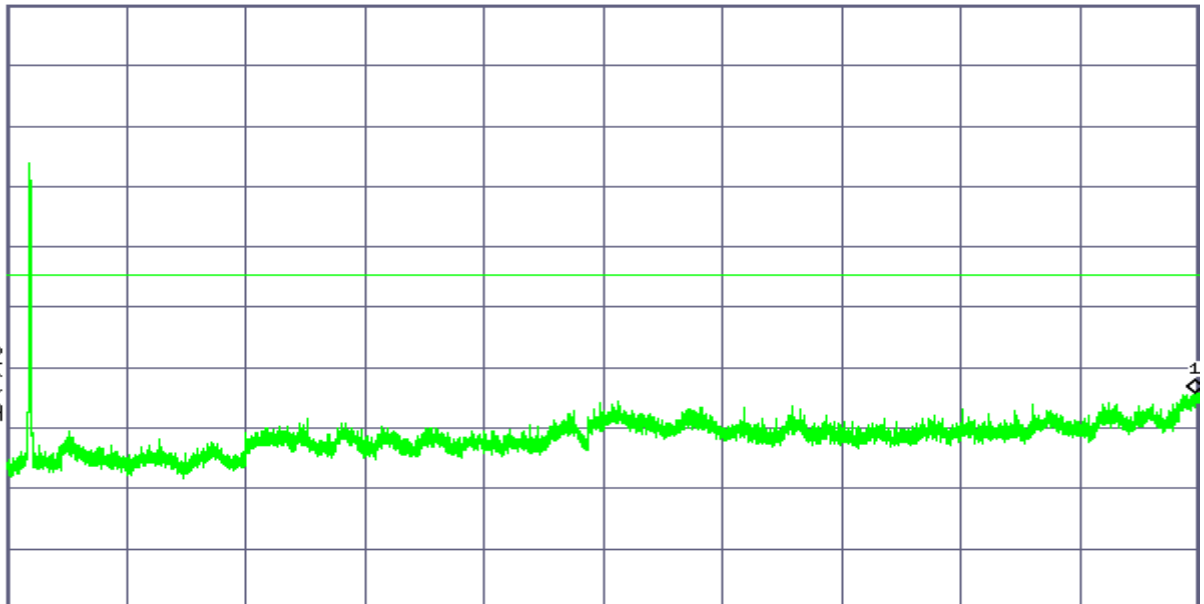

Start 2.000 0 GHz

Stop 25.000 0 GHz

#Res BW 100 kHz

#VBW 300 kHz

Sweep 2.198 s (8192 pts)

**CH High**

**Agilent**

**R T**

Mkr1 2.449 62 GHz  
-4.55 dBm

Ref 20 dBm

#Atten 30 dB

#Peak

Log

10

dB/

Offst

6.5

dB

DI

-24.6

dBm

LgAv

M1 S2

S3 FC

AA

f(f):

FTun

Swp

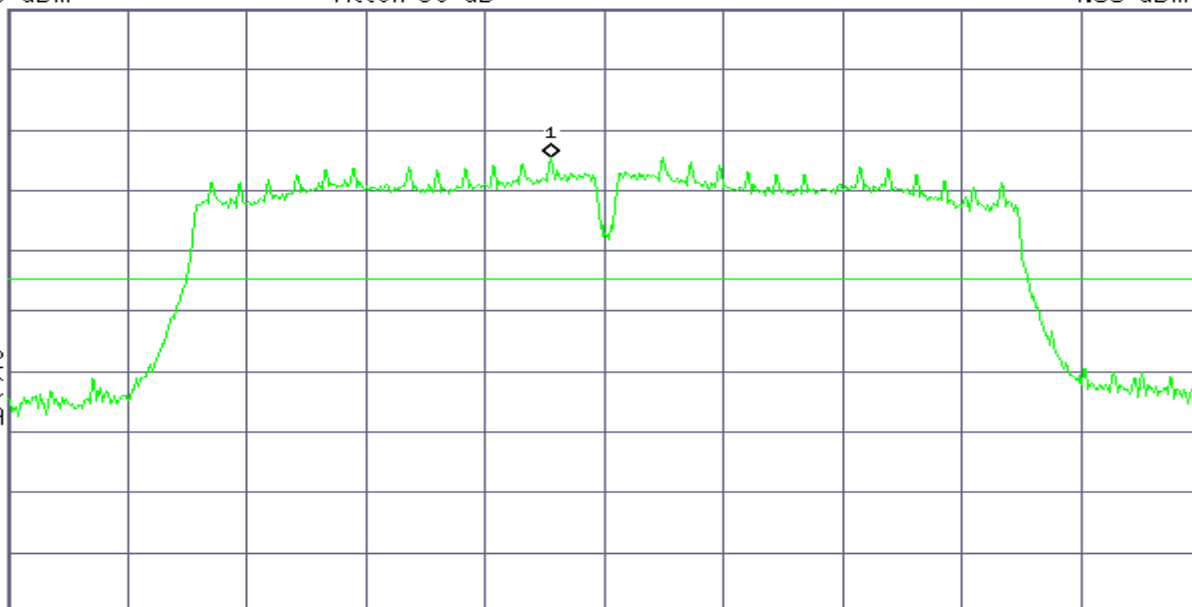

Center 2.452 00 GHz

Span 52.84 MHz

#Res BW 100 kHz

#VBW 300 kHz

Sweep 5.08 ms (601 pts)

**Agilent**

**R T**

Mkr2 2.484 620 GHz  
-41.22 dBm

Ref 20 dBm

#Atten 30 dB

#Peak

Log

10

dB/

Offst

6.5

dB

DI

-24.6

dBm

LgAv

M1 S2

Start 2.430 000 GHz

Stop 2.565 000 GHz

#Res BW 100 kHz

#VBW 300 kHz

Sweep 13.11 ms (8192 pts)

Marker	Trace	Type	X Axis	Amplitude
1	(1)	Freq	2.483 500 GHz	-46.71 dBm
2	(1)	Freq	2.484 620 GHz	-41.22 dBm

**Agilent**

**R T**

Mkr1 2.641 0 GHz  
 -52.40 dBm

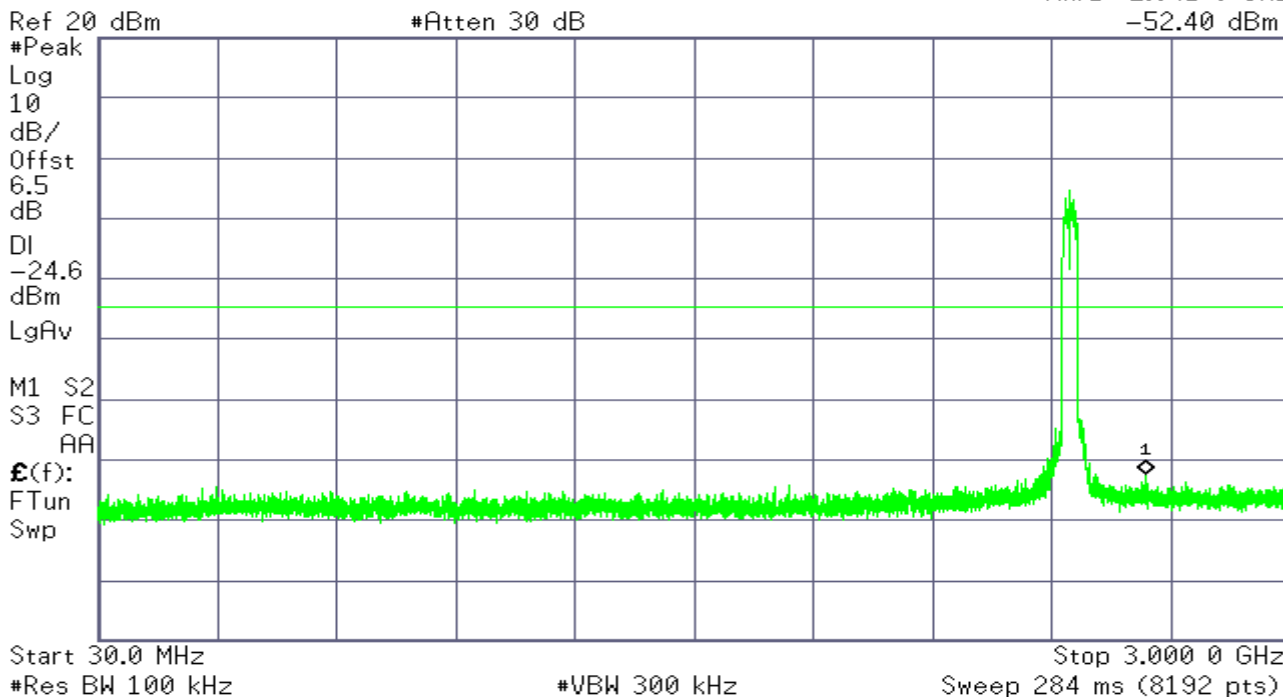

**Agilent**

**R T**

Mkr1 24.893 3 GHz  
 -43.85 dBm

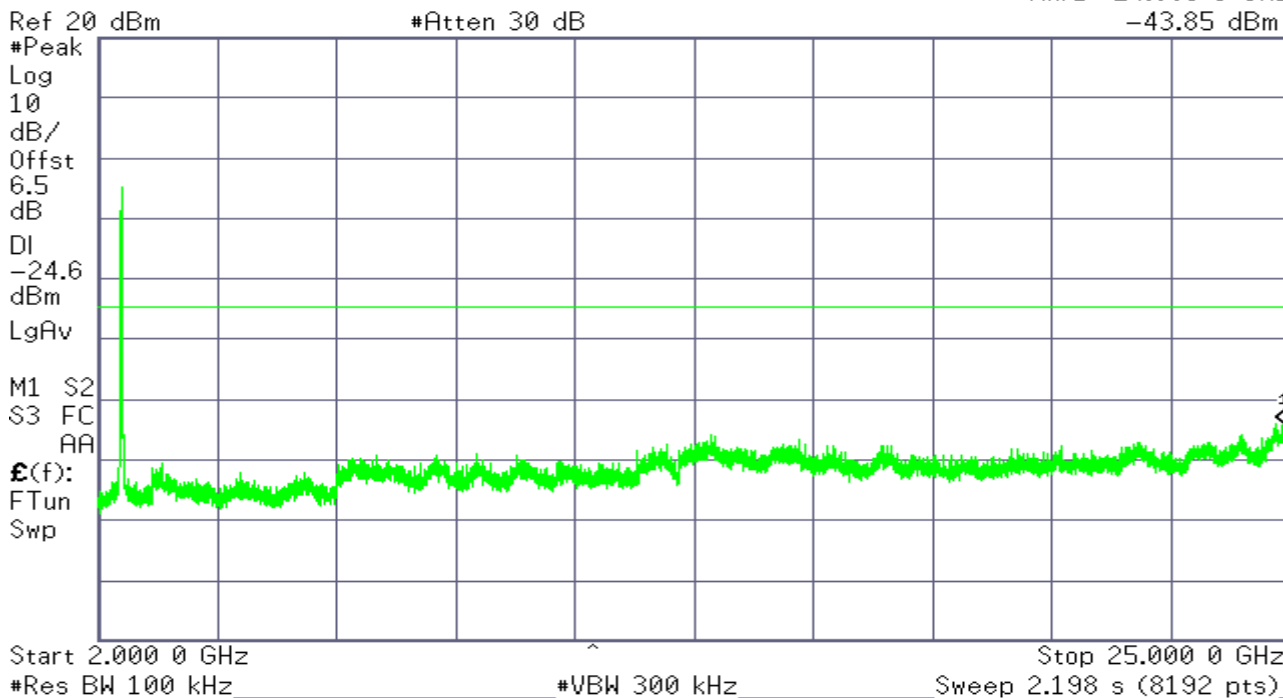

## 7.5.RADIATED EMISSIONS

### LIMIT

Radiated emissions from 9 kHz to 25 GHz were measured according to the methods defines in ANSI C63.10-2013. The EUT was placed above the ground plane, 0.8 meter for frequency below 1GHz and 1.5 meter for frequency above 1GHz. The interface cables and equipment positions were varied within limits of reasonable applications to determine the positions producing maximum radiated emissions

1. According to §15.209(a), except as provided elsewhere in this Subpart, the emissions from an intentional radiator shall not exceed the field strength levels specified in the following table:

FREQUENCIES(MHz)	FIELD STRENGTH (microvolts/meter)	MEASUREMENT DISTANCE(meters)
0.009~0.490	2400/F(kHz)	300
0.490~1.705	24000/F(kHz)	30
1.705~30.0	30	30
30~88	100	3
88~216	150	3
216~960	200	3
Above 960	500	3

**Remark:** Except as provided in paragraph (g), fundamental emissions from intentional radiators operating under this Section shall not be located in the frequency bands 54-72 MHz, 76-88 MHz, 174-216 MHz or 470-806 MHz. However, operation within these frequency bands is permitted under other sections of this Part, e.g., Sections 15.231 and 15.241.

2.In the emission table above, the tighter limit applies at the band edges.

Frequency (MHz)	Field Strength ( $\mu$ V/m at 3-meter)	Field Strength (dB $\mu$ V/m at 3-meter)
30-88	100	40
88-216	150	43.5
216-960	200	46
Above 960	500	54

### Test Configuration

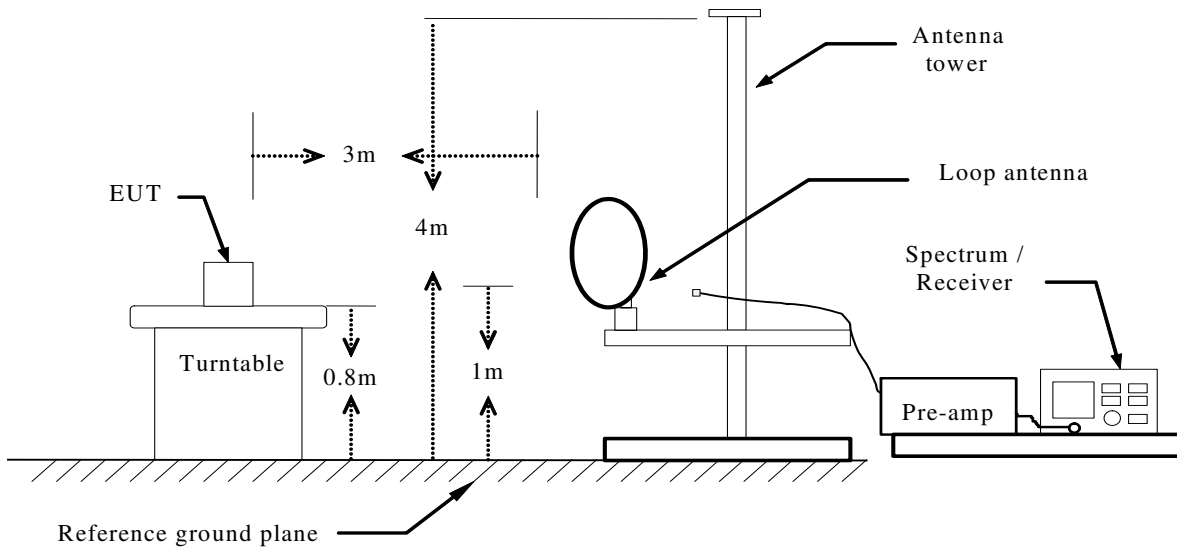
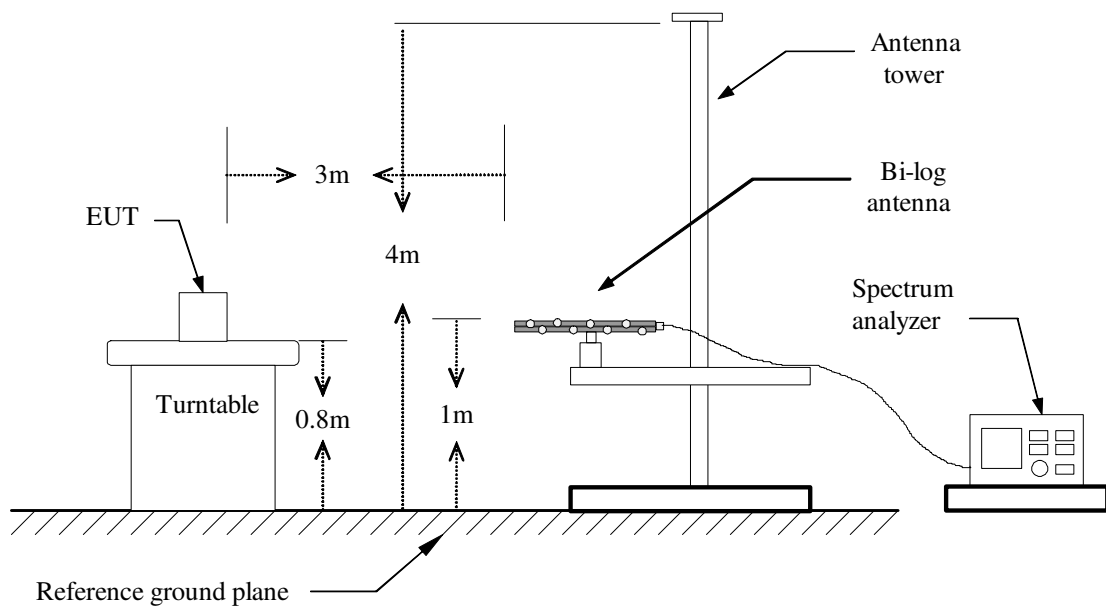
**Below 30MHz****Below 1 GHz**

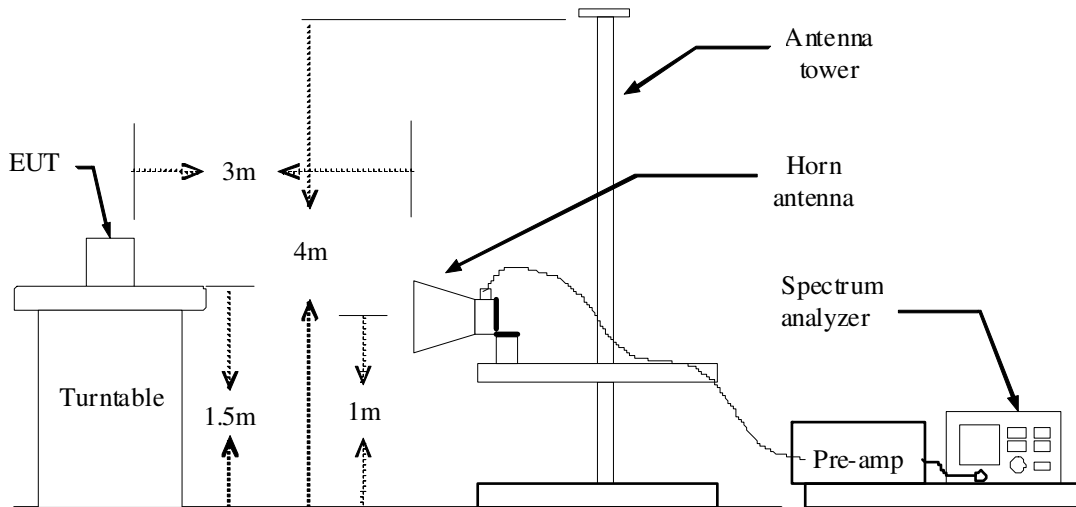
**Above 1 GHz****TEST PROCEDURE**

1. The EUT is placed on a turntable above ground plane, which is 0.8 meter for frequency below 1GHz and 1.5 meter for frequency above 1GHz.
2. The turntable shall be rotated for 360 degrees to determine the position of maximum emission level.
3. EUT is set 3m away from the receiving antenna, which is varied from 1m to 4m to find out the highest emissions.
4. Maximum procedure was performed on the six highest emissions to ensure EUT compliance.
5. And also, each emission was to be maximized by changing the polarization of receiving antenna both horizontal and vertical.
6. Set the spectrum analyzer in the following setting as:

Below 1GHz:

RBW=100kHz / VBW=300kHz / Sweep=AUTO

Above 1GHz:

PEAK: RBW=VBW=1MHz / Sweep=AUTO

AVERAGE: RBW=1MHz / VBW=10Hz / Sweep=AUTO

7. Repeat above procedures until the measurements for all frequencies are complete.

**TEST RESULTS**



**RESTRICTED BANDEDGE (b Mode, Low Channel, Horizontal)**

110.0 dBuV/m

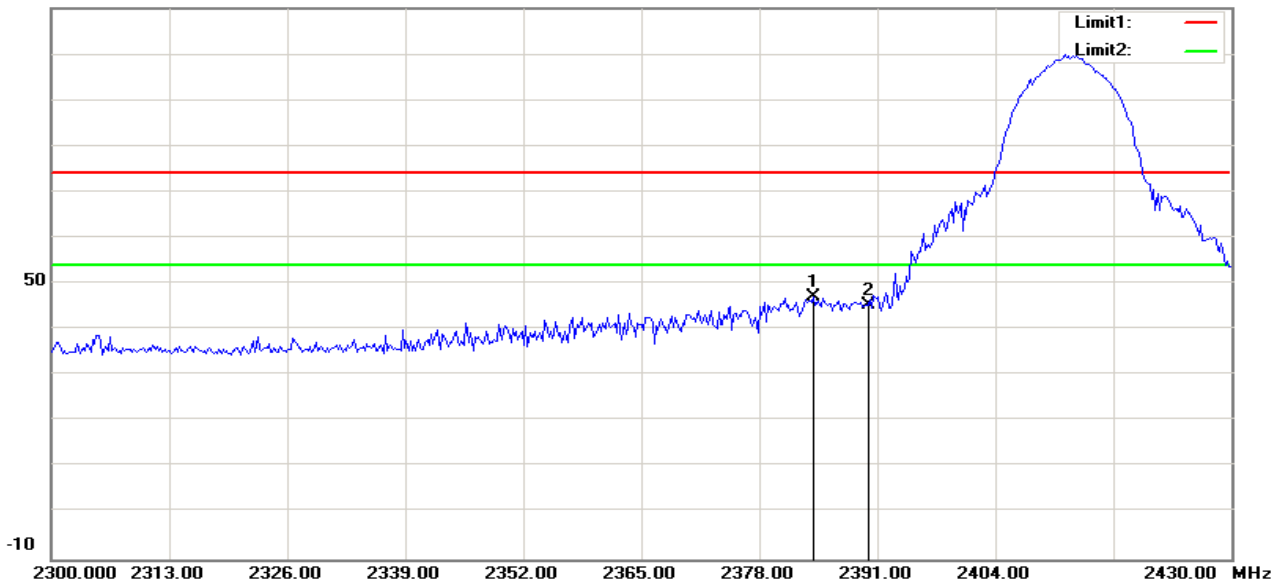

No.	Frequency (MHz)	Reading (dBuV)	Correct Factor(dB/m)	Result (dBuV/m)	Limit (dBuV/m)	Margin (dB)	Height (cm)	Degree (deg.)	Remark
1	2383.958	55.64	-8.48	47.16	74.00	-26.84	100	303	peak
2	2390.000	53.91	-8.47	45.44	74.00	-28.56	100	299	peak

**RESTRICTED BANDEDGE (b Mode, Low Channel, Vertical)**

110.0 dBuV/m

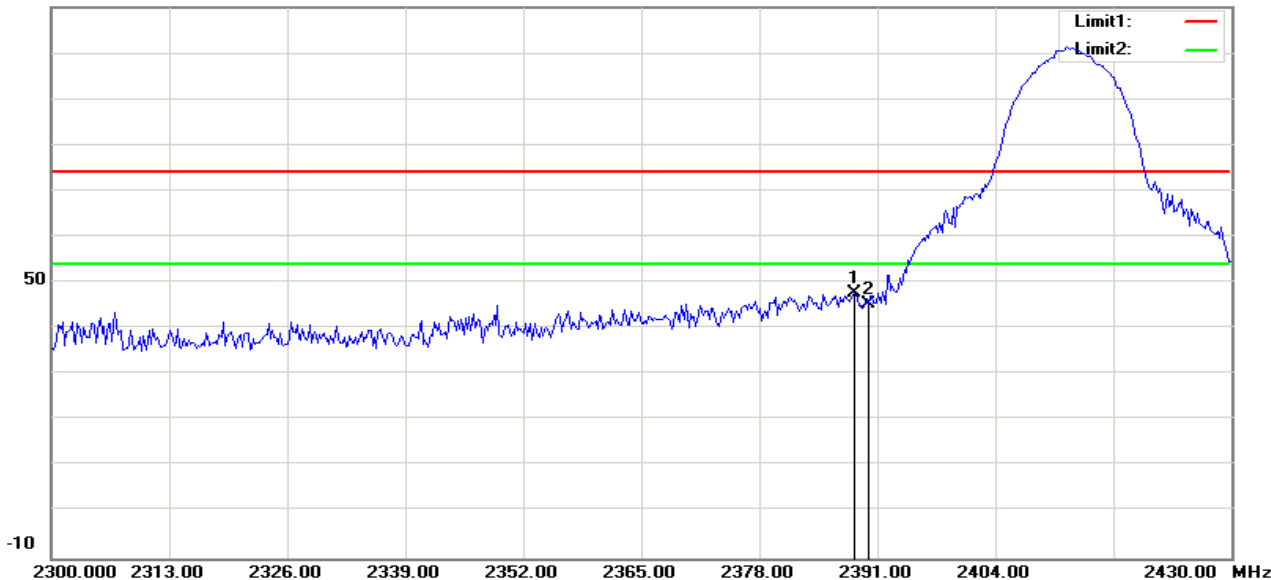

No.	Frequency (MHz)	Reading (dBuV)	Correct Factor(dB/m)	Result (dBuV/m)	Limit (dBuV/m)	Margin (dB)	Height (cm)	Degree (deg.)	Remark
1	2388.542	56.36	-8.47	47.89	74.00	-26.11	100	325	peak
2	2390.000	53.76	-8.47	45.29	74.00	-28.71	100	360	peak

**RESTRICTED BANDEDGE (b Mode, High Channel, Horizontal)**

110.0 dBuV/m

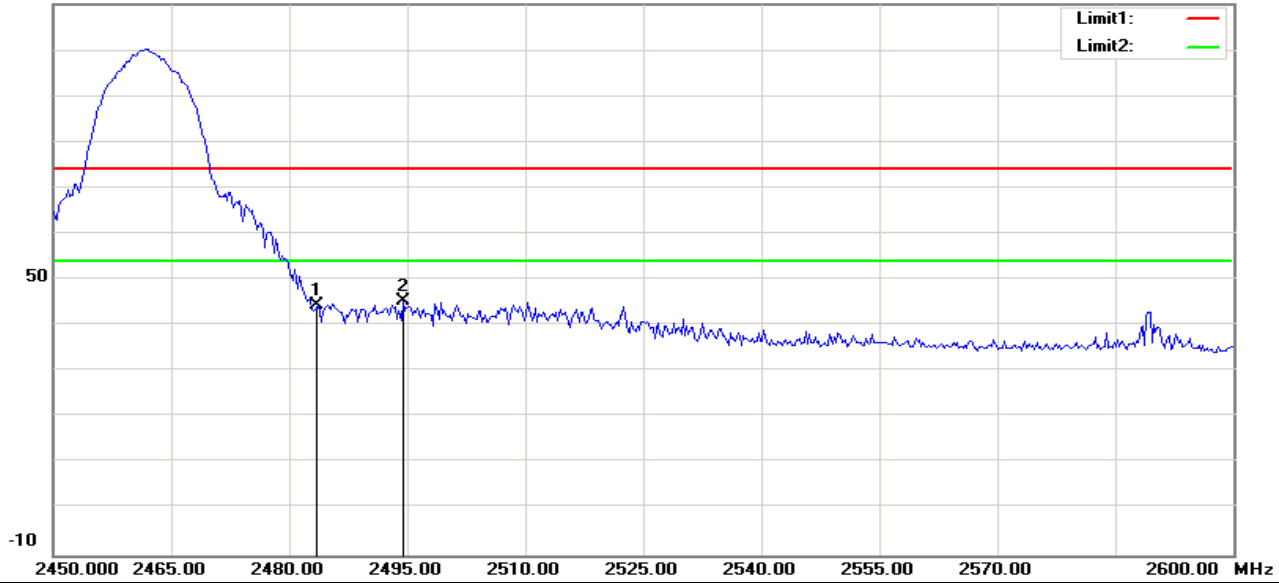

No.	Frequency (MHz)	Reading (dBuV)	Correct Factor(dB/m)	Result (dBuV/m)	Limit (dBuV/m)	Margin (dB)	Height (cm)	Degree (deg.)	Remark
1	2483.500	52.60	-8.26	44.34	74.00	-29.66	100	331	peak
2	2494.471	53.47	-8.23	45.24	74.00	-28.76	100	160	peak

**RESTRICTED BANDEDGE (b Mode, High Channel, Vertical)**

110.0 dBuV/m

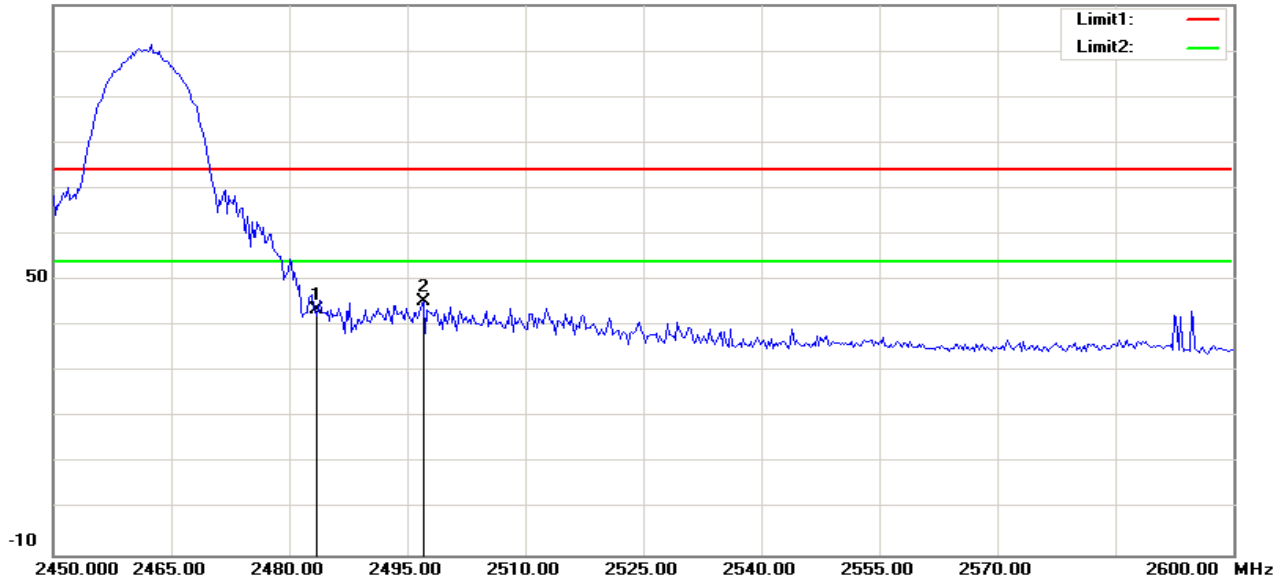

No.	Frequency (MHz)	Reading (dBuV)	Correct Factor(dB/m)	Result (dBuV/m)	Limit (dBuV/m)	Margin (dB)	Height (cm)	Degree (deg.)	Remark
1	2483.500	51.73	-8.26	43.47	74.00	-30.53	100	331	peak
2	2497.115	53.46	-8.23	45.23	74.00	-28.77	100	335	peak

**RESTRICTED BANDEDGE (g Mode, Low Channel, Horizontal)**

110.0 dBuV/m

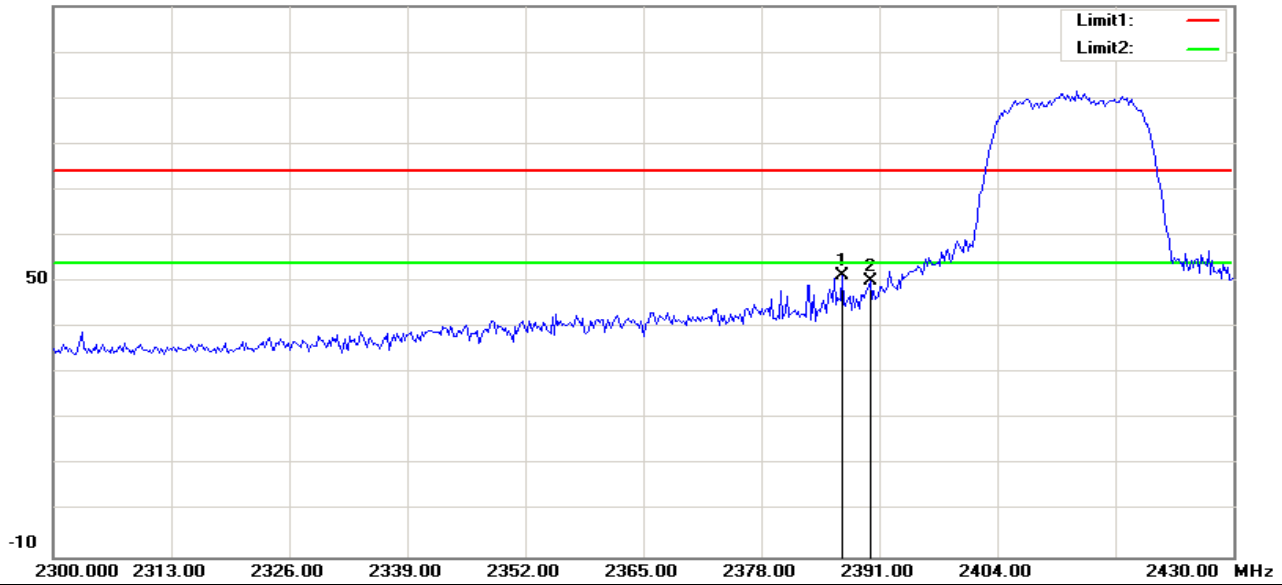

No.	Frequency (MHz)	Reading (dBuV)	Correct Factor(dB/m)	Result (dBuV/m)	Limit (dBuV/m)	Margin (dB)	Height (cm)	Degree (deg.)	Remark
1	2386.875	59.93	-8.48	51.45	74.00	-22.55	100	296	peak
2	2390.000	58.66	-8.47	50.19	74.00	-23.81	100	287	peak

**RESTRICTED BANDEDGE (g Mode, Low Channel, Vertical)**

110.0 dBuV/m

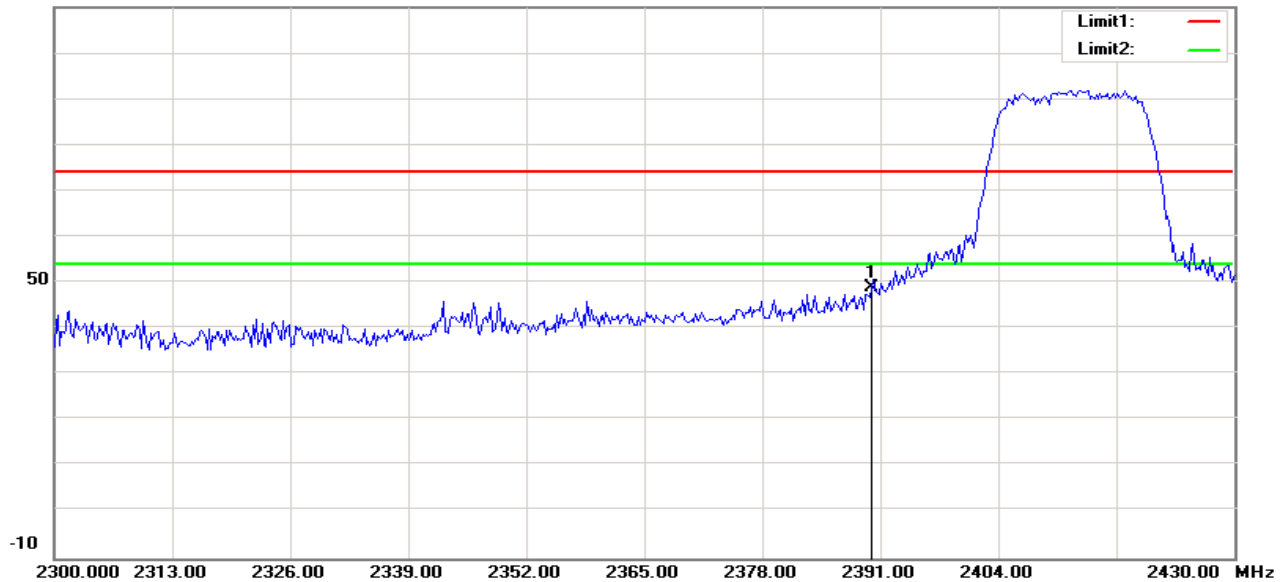

No.	Frequency (MHz)	Reading (dBuV)	Correct Factor(dB/m)	Result (dBuV/m)	Limit (dBuV/m)	Margin (dB)	Height (cm)	Degree (deg.)	Remark
1	2390.000	57.53	-8.47	49.06	74.00	-24.94	100	332	peak

**RESTRICTED BANDEDGE (g Mode, High Channel, Horizontal)**

110.0 dBuV/m

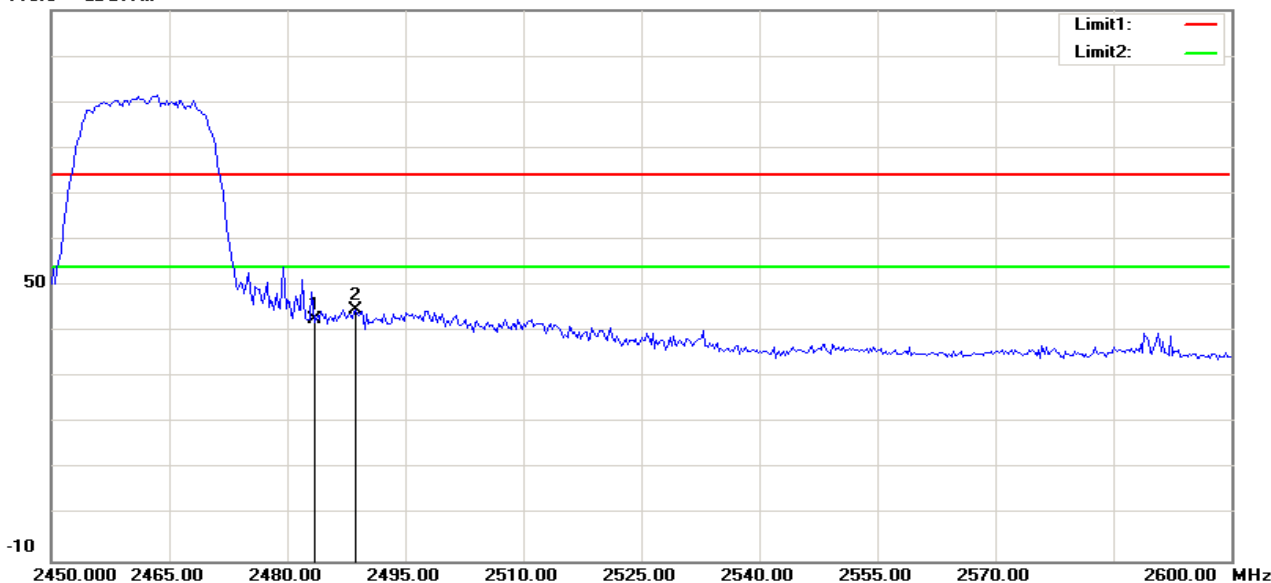

No.	Frequency (MHz)	Reading (dBuV)	Correct Factor(dB/m)	Result (dBuV/m)	Limit (dBuV/m)	Margin (dB)	Height (cm)	Degree (deg.)	Remark
1	2483.500	51.01	-8.26	42.75	74.00	-31.25	100	172	peak
2	2488.702	53.09	-8.25	44.84	74.00	-29.16	100	250	peak

**RESTRICTED BANDEDGE (g Mode, High Channel, Vertical)**

110.0 dBuV/m

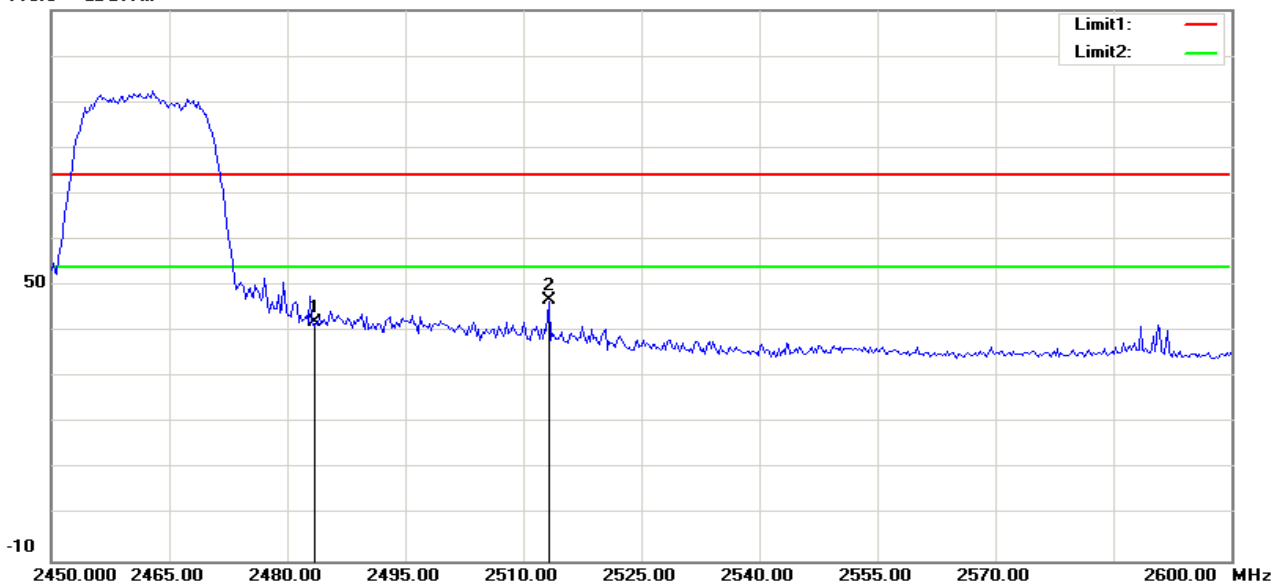

No.	Frequency (MHz)	Reading (dBuV)	Correct Factor(dB/m)	Result (dBuV/m)	Limit (dBuV/m)	Margin (dB)	Height (cm)	Degree (deg.)	Remark
1	2483.500	50.39	-8.26	42.13	74.00	-31.87	100	205	peak
2	2513.221	54.89	-8.19	46.70	74.00	-27.30	100	260	peak

**RESTRICTED BANDEDGE (IEEE 802.11n HT20 mode, Low Channel, Horizontal)**

110.0 dBuV/m

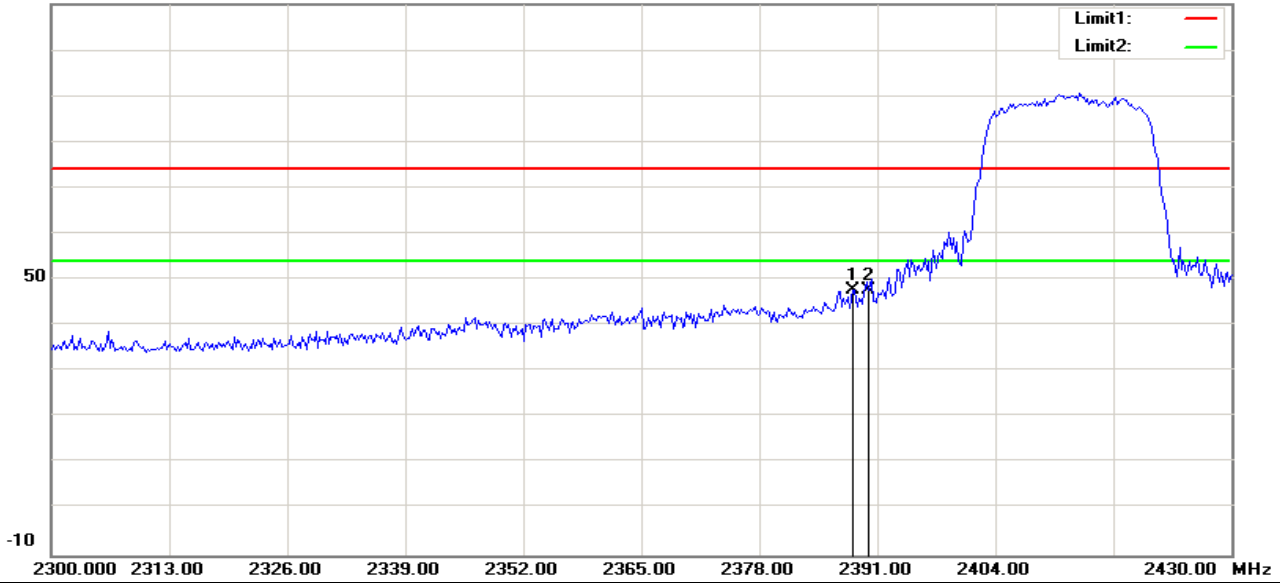

No.	Frequency (MHz)	Reading (dBuV)	Correct Factor(dB/m)	Result (dBuV/m)	Limit (dBuV/m)	Margin (dB)	Height (cm)	Degree (deg.)	Remark
1	2388.333	56.20	-8.47	47.73	74.00	-26.27	100	300	peak
2	2390.000	56.13	-8.47	47.66	74.00	-26.34	100	305	peak

**RESTRICTED BANDEDGE (IEEE 802.11n HT20 mode, Low Channel, Vertical)**

110.0 dBuV/m

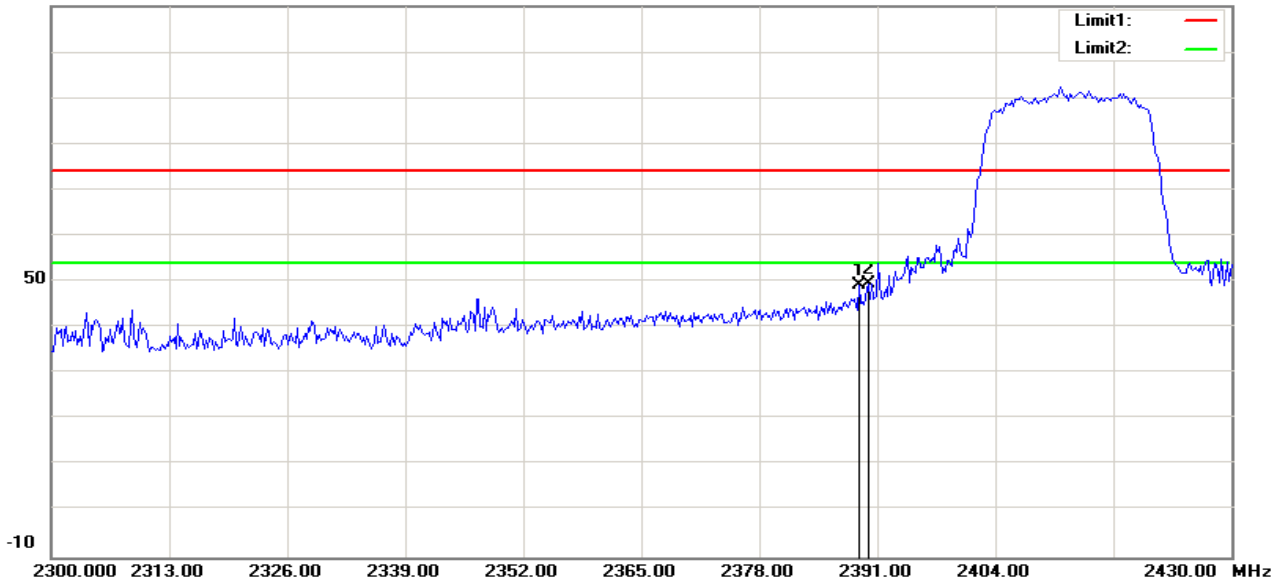

No.	Frequency (MHz)	Reading (dBuV)	Correct Factor(dB/m)	Result (dBuV/m)	Limit (dBuV/m)	Margin (dB)	Height (cm)	Degree (deg.)	Remark
1	2388.958	57.82	-8.47	49.35	74.00	-24.65	100	318	peak
2	2390.000	58.14	-8.47	49.67	74.00	-24.33	100	321	peak

**RESTRICTED BANDEDGE (IEEE 802.11n HT20 mode, High Channel, Horizontal)**

110.0 dBuV/m

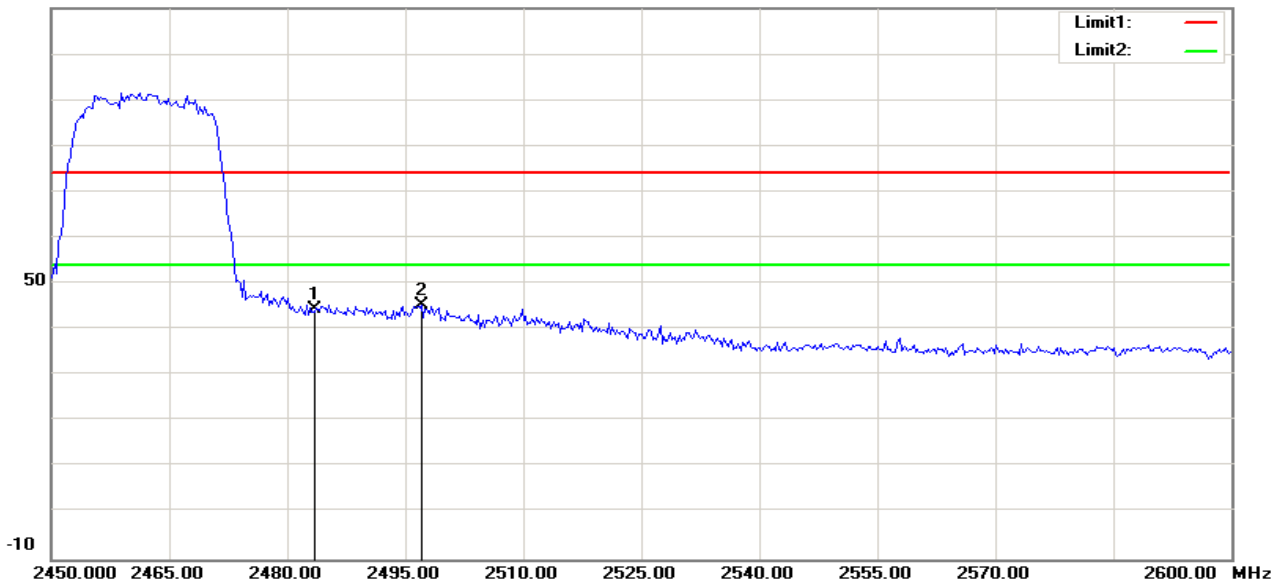

No.	Frequency (MHz)	Reading (dBuV)	Correct Factor(dB/m)	Result (dBuV/m)	Limit (dBuV/m)	Margin (dB)	Height (cm)	Degree (deg.)	Remark
1	2483.500	52.86	-8.26	44.60	74.00	-29.40	100	121	peak
2	2497.115	53.48	-8.23	45.25	74.00	-28.75	100	125	peak

**RESTRICTED BANDEDGE (IEEE 802.11n HT20 mode, High Channel, Vertical)**

110.0 dBuV/m

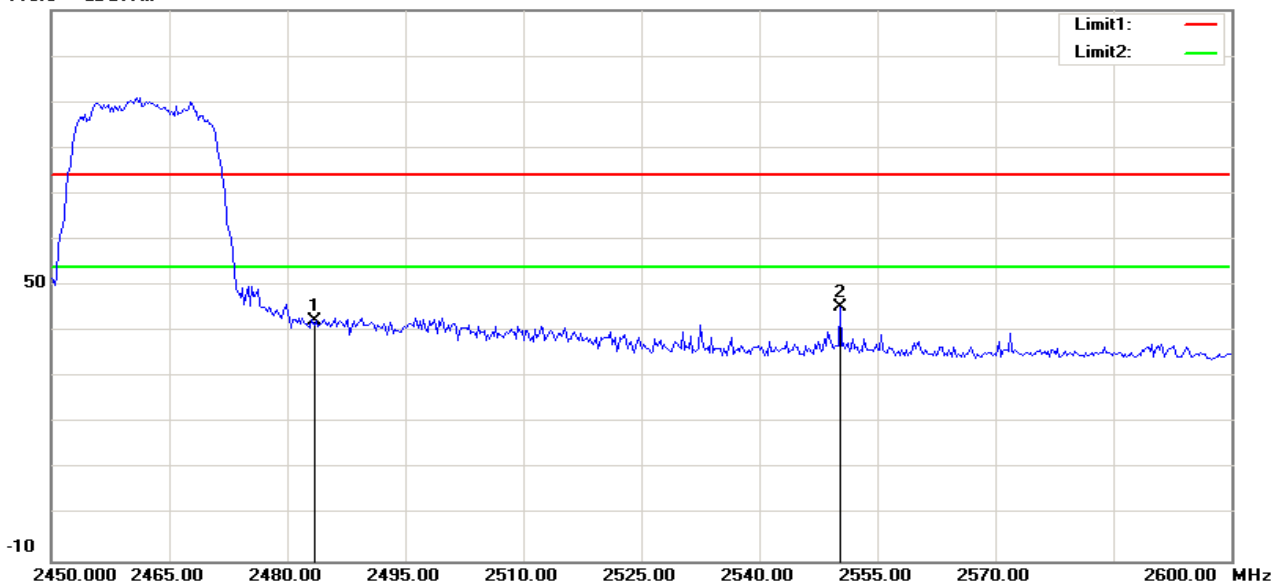

No.	Frequency (MHz)	Reading (dBuV)	Correct Factor(dB/m)	Result (dBuV/m)	Limit (dBuV/m)	Margin (dB)	Height (cm)	Degree (deg.)	Remark
1	2483.500	50.50	-8.26	42.24	74.00	-31.76	100	337	peak
2	2550.240	53.60	-8.11	45.49	74.00	-28.51	100	233	peak

**RESTRICTED BANDEDGE (IEEE 802.11n HT40 mode, Low Channel, Horizontal)**

110.0 dBuV/m

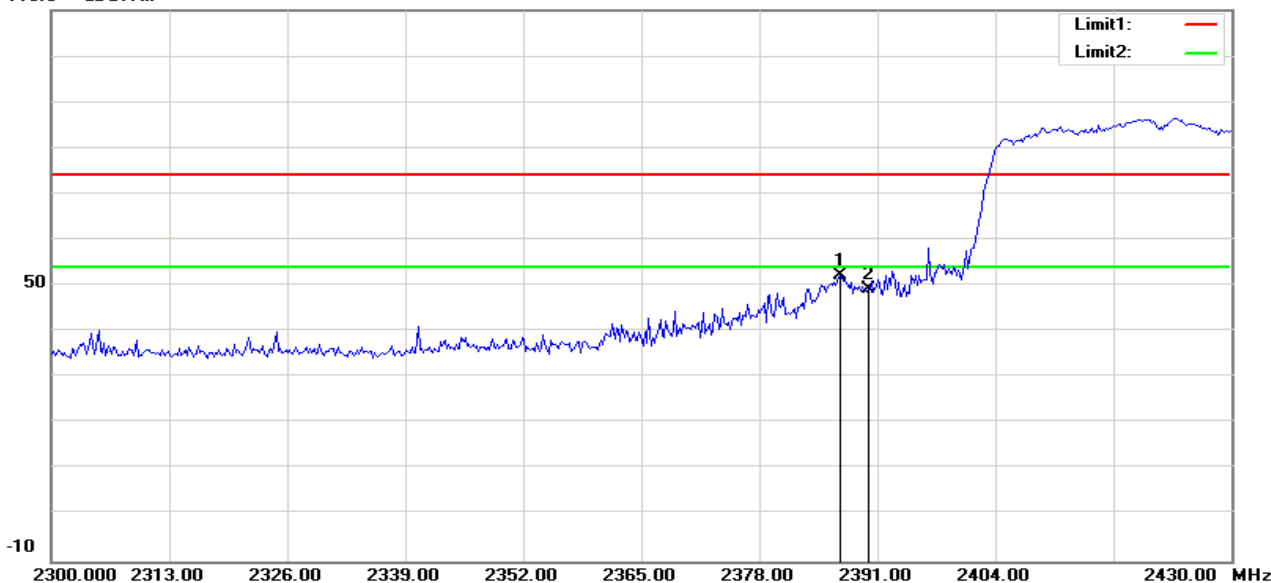

No.	Frequency (MHz)	Reading (dBuV)	Correct Factor(dB/m)	Result (dBuV/m)	Limit (dBuV/m)	Margin (dB)	Height (cm)	Degree (deg.)	Remark
1	2386.875	60.63	-8.48	52.15	74.00	-21.85	100	297	peak
2	2390.000	57.86	-8.47	49.39	74.00	-24.61	100	116	peak

**RESTRICTED BANDEDGE (IEEE 802.11n HT40 mode, Low Channel, Vertical)**

110.0 dBuV/m

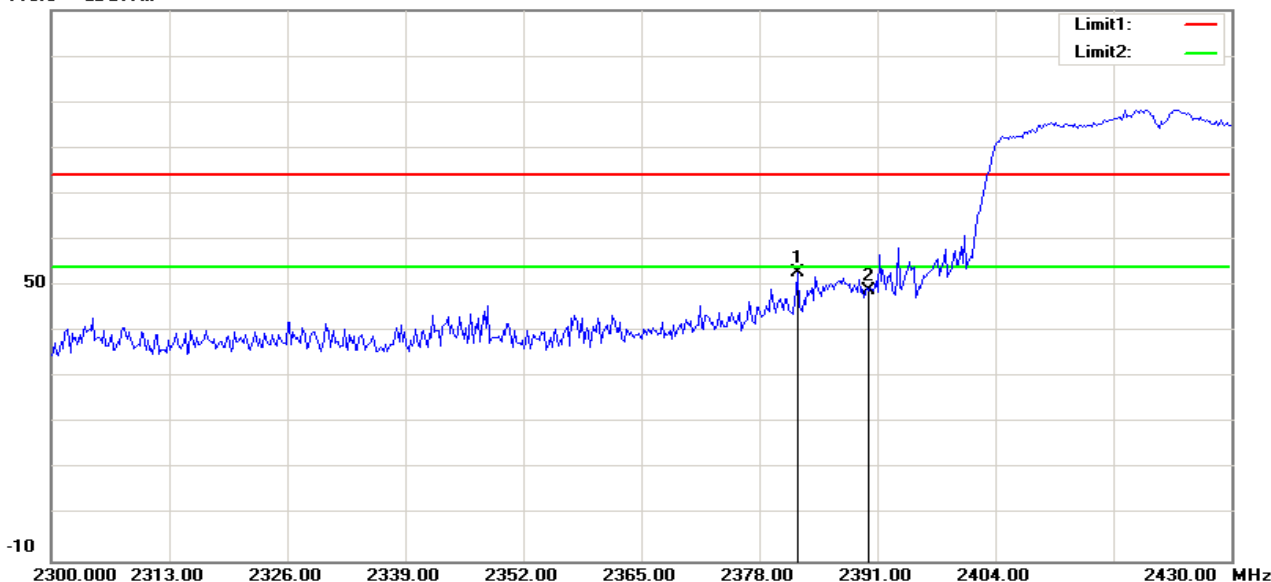

No.	Frequency (MHz)	Reading (dBuV)	Correct Factor(dB/m)	Result (dBuV/m)	Limit (dBuV/m)	Margin (dB)	Height (cm)	Degree (deg.)	Remark
1	2382.292	61.38	-8.49	52.89	74.00	-21.11	100	356	peak
2	2390.000	57.54	-8.47	49.07	74.00	-24.93	100	323	peak

**RESTRICTED BANDEDGE (IEEE 802.11n HT40 mode, High Channel, Horizontal)**

110.0 dBuV/m

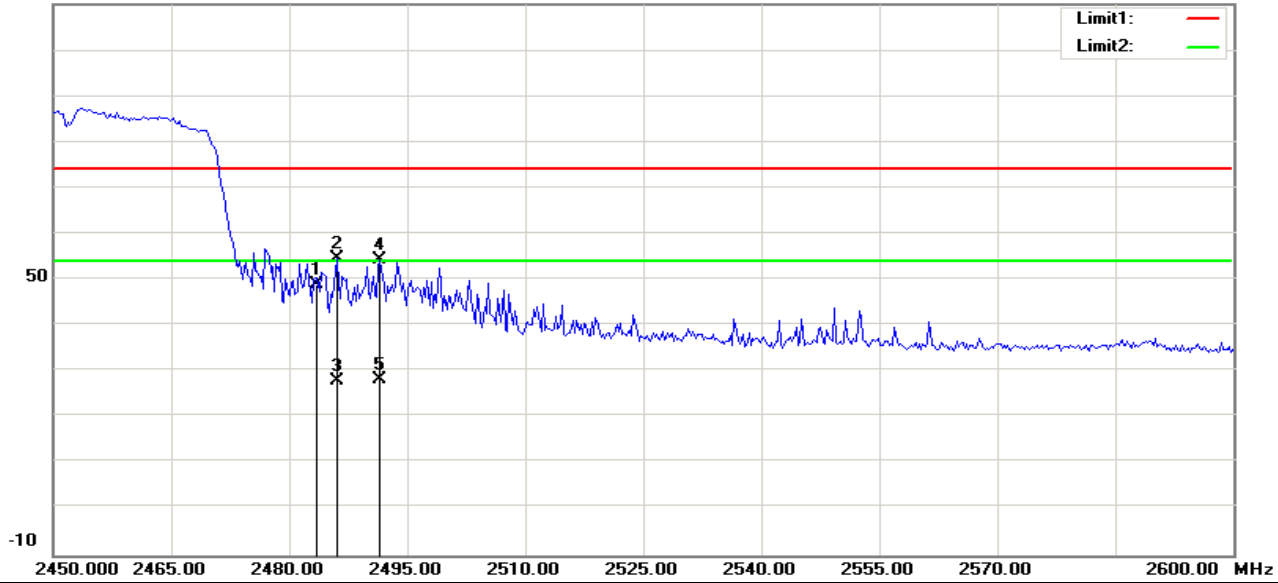

No.	Frequency (MHz)	Reading (dBuV)	Correct Factor(dB/m)	Result (dBuV/m)	Limit (dBuV/m)	Margin (dB)	Height (cm)	Degree (deg.)	Remark
1	2483.500	57.17	-8.26	48.91	74.00	-25.09	100	124	peak
2	2486.058	62.81	-8.25	54.56	74.00	-19.44	100	252	peak
3	2486.058	36.28	-8.25	28.03	54.00	-25.97	130	251	AVG
4	2491.586	62.66	-8.24	54.42	74.00	-19.58	100	121	peak
5	2491.586	36.37	-8.24	28.13	54.00	-25.87	130	117	AVG

**RESTRICTED BANDEDGE (IEEE 802.11n HT40 mode, High Channel, Vertical)**

110.0 dBuV/m

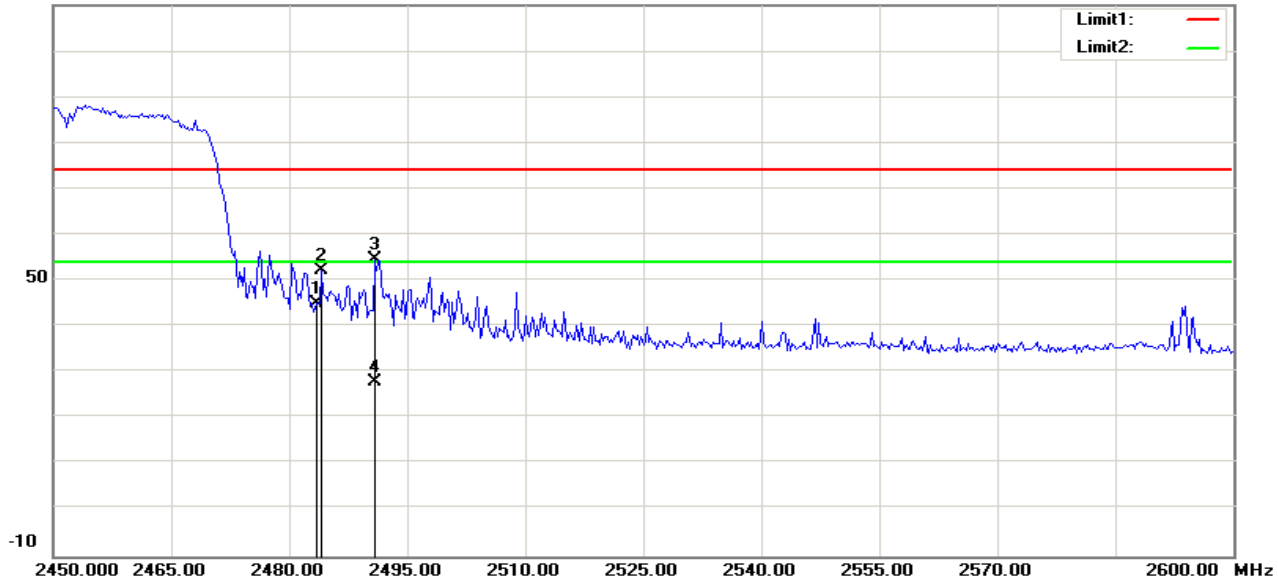

No.	Frequency (MHz)	Reading (dBuV)	Correct Factor(dB/m)	Result (dBuV/m)	Limit (dBuV/m)	Margin (dB)	Height (cm)	Degree (deg.)	Remark
1	2483.500	53.25	-8.26	44.99	74.00	-29.01	100	129	peak
2	2484.135	60.38	-8.26	52.12	74.00	-21.88	100	4	peak
3	2490.865	62.83	-8.24	54.59	74.00	-19.41	100	330	peak
4	2490.865	36.09	-8.24	27.85	54.00	-26.15	130	337	AVG



**Test Result of Radiated Emission****Below 30MHz**

The interference of the frequency value is lower than the limit below 20 db, measured as the background noise values and will not be recorded.

**30MHz-1GHz**

<b>Operation Mode:</b>	Normal Link	<b>Test Date:</b>	2016-7-14
<b>Temperature:</b>	25°C	<b>Tested by:</b>	Lily.Wang
<b>Humidity:</b>	48% RH	<b>Polarity:</b>	Ver. / Hor.

Frequency (MHz)	Ant. Pol. (H/V)	Reading (dBuV)	Correction Factor (dB/m)	Result (dBuV/m)	Limit (dBuV/m)	Margin (dB)	Remark
55.2200	V	20.45	11.08	31.53	40.00	-8.47	QP
95.9600	V	15.88	11.44	27.32	43.50	-16.18	QP
350.1000	V	11.77	18.48	30.25	46.00	-15.75	QP
494.6300	V	11.47	21.15	32.62	46.00	-13.38	QP
563.5000	V	9.91	21.71	31.62	46.00	-14.38	QP
800.1800	V	5.80	25.45	31.25	46.00	-14.75	QP
95.9600	H	16.88	11.44	28.32	43.50	-15.18	QP
224.9700	H	14.95	16.30	31.25	46.00	-14.75	QP
275.4100	H	16.76	16.49	33.25	46.00	-12.75	QP
350.1000	H	11.77	18.48	30.25	46.00	-15.75	QP
395.6900	H	13.03	20.22	33.25	46.00	-12.75	QP
800.1800	H	7.48	25.45	32.93	46.00	-13.07	QP

**Remark:**

*Measuring frequencies from 30 MHz to the 1GHz (No emission found between lowest internal used/generated frequency to 30 MH).*

*Radiated emissions measured in frequency range from 30 MHz to 1000MHz were made with an instrument using peak/quasi-peak detector mode.*

*Measurements above show only up to 6 maximum emissions noted, or would be lesser, with " N/A " remark, if no specific emissions from the EUT are recorded (ie: margin>20dB from the applicable limit) and considered that's already beyond the background noise floor.*

*Margin (dB) = Result (dBuV/m) – Limit (dBuV/m).*

**Above 1 GHz**
**Operation Mode:** TX / IEEE 802.11b / CH Low

**Test Date:** 2016-7-21

**Temperature:** 24°C

**Tested by:** Lily.Wang

**Humidity:** 48 % RH

**Polarity:** Ver. / Hor.

**Horizontal**

No.	Frequency (MHz)	Reading (dBuV)	Correct Factor(dB/m)	Result (dBuV/m)	Limit (dBuV/m)	Margin (dB)	Height (cm)	Degree (deg.)	Remark
1	4814.103	53.66	-3.38	50.28	74.00	-23.72	100	305	peak
2	7402.244	42.27	1.69	43.96	74.00	-30.04	100	14	peak
N/A									

**Vertical**

No.	Frequency (MHz)	Reading (dBuV)	Correct Factor(dB/m)	Result (dBuV/m)	Limit (dBuV/m)	Margin (dB)	Height (cm)	Degree (deg.)	Remark
1	4814.103	54.35	-3.38	50.97	74.00	-23.03	100	255	peak
2	7647.436	42.17	2.84	45.01	74.00	-28.99	100	27	peak
N/A									

**Operation Mode:** TX / IEEE 802.11b / CH Mid

**Test Date:** 2016-7-21

**Temperature:** 24°C

**Tested by:** Lily.Wang

**Humidity:** 48 % RH

**Polarity:** Ver. / Hor.

**Horizontal**

No.	Frequency (MHz)	Reading (dBuV)	Correct Factor(dB/m)	Result (dBuV/m)	Limit (dBuV/m)	Margin (dB)	Height (cm)	Degree (deg.)	Remark
1	4868.590	50.02	-3.26	46.76	74.00	-27.24	100	306	peak
2	7674.680	41.83	2.96	44.79	74.00	-29.21	100	333	peak
N/A									

**Vertical**

No.	Frequency (MHz)	Reading (dBuV)	Correct Factor(dB/m)	Result (dBuV/m)	Limit (dBuV/m)	Margin (dB)	Height (cm)	Degree (deg.)	Remark
1	4868.590	50.11	-3.26	46.85	74.00	-27.15	100	251	peak
2	7647.436	43.20	2.84	46.04	74.00	-27.96	100	0	peak
N/A									

**Operation Mode:** TX / IEEE 802.11b / CH High  
**Temperature:** 24°C  
**Humidity:** 48 % RH

**Test Date:** 2016-7-21  
**Tested by:** Lily.Wang  
**Polarity:** Ver. / Hor.

**Horizontal**

No.	Frequency (MHz)	Reading (dBuV)	Correct Factor(dB/m)	Result (dBuV/m)	Limit (dBuV/m)	Margin (dB)	Height (cm)	Degree (deg.)	Remark
1	4923.077	51.46	-3.13	48.33	74.00	-25.67	100	296	peak
2	7674.680	42.33	2.96	45.29	74.00	-28.71	100	161	peak
N/A									

**Vertical**

No.	Frequency (MHz)	Reading (dBuV)	Correct Factor(dB/m)	Result (dBuV/m)	Limit (dBuV/m)	Margin (dB)	Height (cm)	Degree (deg.)	Remark
1	4923.077	50.39	-3.13	47.26	74.00	-26.74	100	247	peak
2	7756.410	42.49	3.35	45.84	74.00	-28.16	100	33	peak
N/A									

**Operation Mode:** TX / IEEE 802.11g / CH Low  
**Temperature:** 24°C  
**Humidity:** 48 % RH

**Test Date:** 2016-7-21  
**Tested by:** Lily.Wang  
**Polarity:** Ver. / Hor.

**Horizontal**

No.	Frequency (MHz)	Reading (dBuV)	Correct Factor(dB/m)	Result (dBuV/m)	Limit (dBuV/m)	Margin (dB)	Height (cm)	Degree (deg.)	Remark
1	4868.590	43.89	-3.26	40.63	74.00	-33.37	100	241	peak
2	7538.462	41.85	2.33	44.18	74.00	-29.82	100	260	peak
N/A									

**Vertical**

No.	Frequency (MHz)	Reading (dBuV)	Correct Factor(dB/m)	Result (dBuV/m)	Limit (dBuV/m)	Margin (dB)	Height (cm)	Degree (deg.)	Remark
1	4814.103	44.73	-3.38	41.35	74.00	-32.65	100	68	peak
2	7647.436	42.67	2.84	45.51	74.00	-28.49	100	124	peak
N/A									



# Compliance Certification Services (KunShan) Inc.

Date of Issue :July 28, 2016  
FCC ID: 2AFIB-YHS1916

Report No: C160628R01-RPW

Operation Mode: TX / IEEE 802.11g / CH Mid

Test Date: 2016-7-21

Temperature: 24°C

Tested by: Lily.Wang

Humidity: 48 % RH

Polarity: Ver. / Hor.

### Horizontal

No.	Frequency (MHz)	Reading (dBuV)	Correct Factor(dB/m)	Result (dBuV/m)	Limit (dBuV/m)	Margin (dB)	Height (cm)	Degree (deg.)	Remark
1	4977.564	43.45	-3.00	40.45	74.00	-33.55	100	5	peak
2	7620.192	41.29	2.71	44.00	74.00	-30.00	100	20	peak
N/A									

### Vertical

No.	Frequency (MHz)	Reading (dBuV)	Correct Factor(dB/m)	Result (dBuV/m)	Limit (dBuV/m)	Margin (dB)	Height (cm)	Degree (deg.)	Remark
1	4732.372	43.70	-3.58	40.12	74.00	-33.88	100	226	peak
2	7565.705	41.47	2.45	43.92	74.00	-30.08	100	330	peak
N/A									

Operation Mode: TX / IEEE 802.11g / CH High

Test Date: 2016-7-21

Temperature: 24°C

Tested by: Lily.Wang

Humidity: 48 % RH

Polarity: Ver. / Hor.

### Horizontal

No.	Frequency (MHz)	Reading (dBuV)	Correct Factor(dB/m)	Result (dBuV/m)	Limit (dBuV/m)	Margin (dB)	Height (cm)	Degree (deg.)	Remark
1	4977.564	43.69	-3.00	40.69	74.00	-33.31	100	241	peak
2	7620.192	41.31	2.71	44.02	74.00	-29.98	100	91	peak
N/A									

### Vertical

No.	Frequency (MHz)	Reading (dBuV)	Correct Factor(dB/m)	Result (dBuV/m)	Limit (dBuV/m)	Margin (dB)	Height (cm)	Degree (deg.)	Remark
1	4868.590	43.31	-3.26	40.05	74.00	-33.95	100	60	peak
2	7674.680	43.51	2.96	46.47	74.00	-27.53	100	189	peak
N/A									

**Operation Mode:** TX / IEEE 802.11n HT20 mode / CH Low

**Test Date:** 2016-7-21

**Temperature:** 24°C

**Tested by:** Lily.Wang

**Humidity:** 48 % RH

**Polarity:** Ver. / Hor.

**Horizontal**

No.	Frequency (MHz)	Reading (dBuV)	Correct Factor(dB/m)	Result (dBuV/m)	Limit (dBuV/m)	Margin (dB)	Height (cm)	Degree (deg.)	Remark
1	4814.103	43.49	-3.38	40.11	74.00	-33.89	100	298	peak
2	7674.680	41.37	2.96	44.33	74.00	-29.67	100	267	peak
N/A									

**Vertical**

No.	Frequency (MHz)	Reading (dBuV)	Correct Factor(dB/m)	Result (dBuV/m)	Limit (dBuV/m)	Margin (dB)	Height (cm)	Degree (deg.)	Remark
1	4814.103	43.60	-3.38	40.22	74.00	-33.78	100	263	peak
2	7592.949	41.04	2.58	43.62	74.00	-30.38	100	299	peak
N/A									

**Operation Mode:** TX / IEEE 802.11n HT20 mode / CH Mid

**Test Date:** 2016-7-21

**Temperature:** 24°C

**Tested by:** Lily.Wang

**Humidity:** 48 % RH

**Polarity:** Ver. / Hor.

**Horizontal**

No.	Frequency (MHz)	Reading (dBuV)	Correct Factor(dB/m)	Result (dBuV/m)	Limit (dBuV/m)	Margin (dB)	Height (cm)	Degree (deg.)	Remark
1	4841.346	43.47	-3.32	40.15	74.00	-33.85	100	29	peak
2	7674.680	41.55	2.96	44.51	74.00	-29.49	100	316	peak
N/A									

**Vertical**

No.	Frequency (MHz)	Reading (dBuV)	Correct Factor(dB/m)	Result (dBuV/m)	Limit (dBuV/m)	Margin (dB)	Height (cm)	Degree (deg.)	Remark
1	4841.346	43.25	-3.32	39.93	74.00	-34.07	100	218	peak
2	7347.756	43.44	1.43	44.87	74.00	-29.13	100	190	peak
N/A									

**Operation Mode:** TX / IEEE 802.11n HT20 mode / CH High **Test Date:** 2016-7-21

**Temperature:** 24°C

**Tested by:** Lily.Wang

**Humidity:** 48 % RH

**Polarity:** Ver. / Hor.

**Horizontal**

No.	Frequency (MHz)	Reading (dBuV)	Correct Factor(dB/m)	Result (dBuV/m)	Limit (dBuV/m)	Margin (dB)	Height (cm)	Degree (deg.)	Remark
1	4705.128	43.84	-3.64	40.20	74.00	-33.80	100	4	peak
2	7674.680	43.14	2.96	46.10	74.00	-27.90	100	4	peak
N/A									

**Vertical**

No.	Frequency (MHz)	Reading (dBuV)	Correct Factor(dB/m)	Result (dBuV/m)	Limit (dBuV/m)	Margin (dB)	Height (cm)	Degree (deg.)	Remark
1	4923.077	43.55	-3.13	40.42	74.00	-33.58	100	255	peak
2	7647.436	42.23	2.84	45.07	74.00	-28.93	100	326	peak
N/A									

**Operation Mode:** TX / IEEE 802.11n HT40 mode / CH Low

**Test Date:** 2016-7-21

**Temperature:** 24°C

**Tested by:** Lily.Wang

**Humidity:** 48 % RH

**Polarity:** Ver. / Hor.

**Horizontal**

No.	Frequency (MHz)	Reading (dBuV)	Correct Factor(dB/m)	Result (dBuV/m)	Limit (dBuV/m)	Margin (dB)	Height (cm)	Degree (deg.)	Remark
1	4841.346	43.48	-3.32	40.16	74.00	-33.84	100	148	peak
2	7729.167	41.49	3.22	44.71	74.00	-29.29	100	284	peak
N/A									

**Vertical**

No.	Frequency (MHz)	Reading (dBuV)	Correct Factor(dB/m)	Result (dBuV/m)	Limit (dBuV/m)	Margin (dB)	Height (cm)	Degree (deg.)	Remark
1	4923.077	43.50	-3.13	40.37	74.00	-33.63	100	2	peak
2	7647.436	41.76	2.84	44.60	74.00	-29.40	100	31	peak
N/A									

**Operation Mode:** TX / IEEE 802.11n HT40 mode / CH Mid

**Test Date:** 2016-7-21

**Temperature:** 24°C

**Tested by:** Lily.Wang

**Humidity:** 48 % RH

**Polarity:** Ver. / Hor.

**Horizontal**

No.	Frequency (MHz)	Reading (dBuV)	Correct Factor(dB/m)	Result (dBuV/m)	Limit (dBuV/m)	Margin (dB)	Height (cm)	Degree (deg.)	Remark
1	4923.077	42.76	-3.13	39.63	74.00	-34.37	100	40	peak
2	7701.923	42.38	3.09	45.47	74.00	-28.53	100	266	peak
N/A									

**Vertical**

No.	Frequency (MHz)	Reading (dBuV)	Correct Factor(dB/m)	Result (dBuV/m)	Limit (dBuV/m)	Margin (dB)	Height (cm)	Degree (deg.)	Remark
1	4868.590	43.04	-3.26	39.78	74.00	-34.22	100	246	peak
2	7266.026	42.75	1.05	43.80	74.00	-30.20	100	41	peak
N/A									

**Operation Mode:** TX / IEEE 802.11n HT40 mode / CH High **Test Date:** 2016-7-21

**Temperature:** 24°C

**Tested by:** Lily.Wang

**Humidity:** 48 % RH

**Polarity:** Ver. / Hor.

**Horizontal**

No.	Frequency (MHz)	Reading (dBuV)	Correct Factor(dB/m)	Result (dBuV/m)	Limit (dBuV/m)	Margin (dB)	Height (cm)	Degree (deg.)	Remark
1	4923.077	43.82	-3.13	40.69	74.00	-33.31	100	309	peak
2	7647.436	41.96	2.84	44.80	74.00	-29.20	100	93	peak
N/A									

**Vertical**

No.	Frequency (MHz)	Reading (dBuV)	Correct Factor(dB/m)	Result (dBuV/m)	Limit (dBuV/m)	Margin (dB)	Height (cm)	Degree (deg.)	Remark
1	4895.833	44.31	-3.19	41.12	74.00	-32.88	100	244	peak
2	7647.436	42.77	2.84	45.61	74.00	-28.39	100	172	peak
N/A									

## 7.6.POWERLINE CONDUCTED EMISSIONS

### LIMIT

According to §15.207(a), except as shown in paragraphs (b) and (c) of this section, for an intentional radiator that is designed to be connected to the public utility (AC) power line, the radio frequency voltage that is conducted back onto the AC power line on any frequency or frequencies within the band 150 kHz to 30 MHz shall not exceed the limits in the following table, as measured using a 50  $\mu$ H/50 ohms line impedance stabilization network (LISN). Compliance with the provisions of this paragraph shall be based on the measurement of the radio frequency voltage between each power line and ground at the power terminal. The lower limit applies at the boundary between the frequency ranges.

Frequency Range (MHz)	Limits (dB $\mu$ V)	
	Quasi-peak	Average
0.15 to 0.50	66 to 56*	56 to 46*
0.50 to 5	56	46
5 to 30	60	50

\* Decreases with the logarithm of the frequency.

### Test Configuration

See test photographs attached in Appendix 1 for the actual connections between EUT and support equipment.

### TEST PROCEDURE

- 1.The EUT was placed on a table, which is 0.8m above ground plane.
- 2.Maximum procedure was performed on the six highest emissions to ensure EUT compliance.
- 3.Repeat above procedures until all frequency measured were complete.

### TEST RESULTS

The initial step in collecting conducted data is a spectrum analyzer peak scan of the measurement range. Significant peaks are then marked as shown on the following data page, and these signals are then quasi-peaked.

### TEST DATA



Job No.:	C160628R01	Date:	2016-7-22
Model No.:	YHS.1916	Time:	PM 02:23:02
Standard:	FCC Class B	Temp.(C)/Hum.(%):	22(C)/48%
Test item:	Conduction test	Test By:	Lily.Wang
Line:	L1	Test Voltage:	AC 120V/60Hz
Model:		Description:	

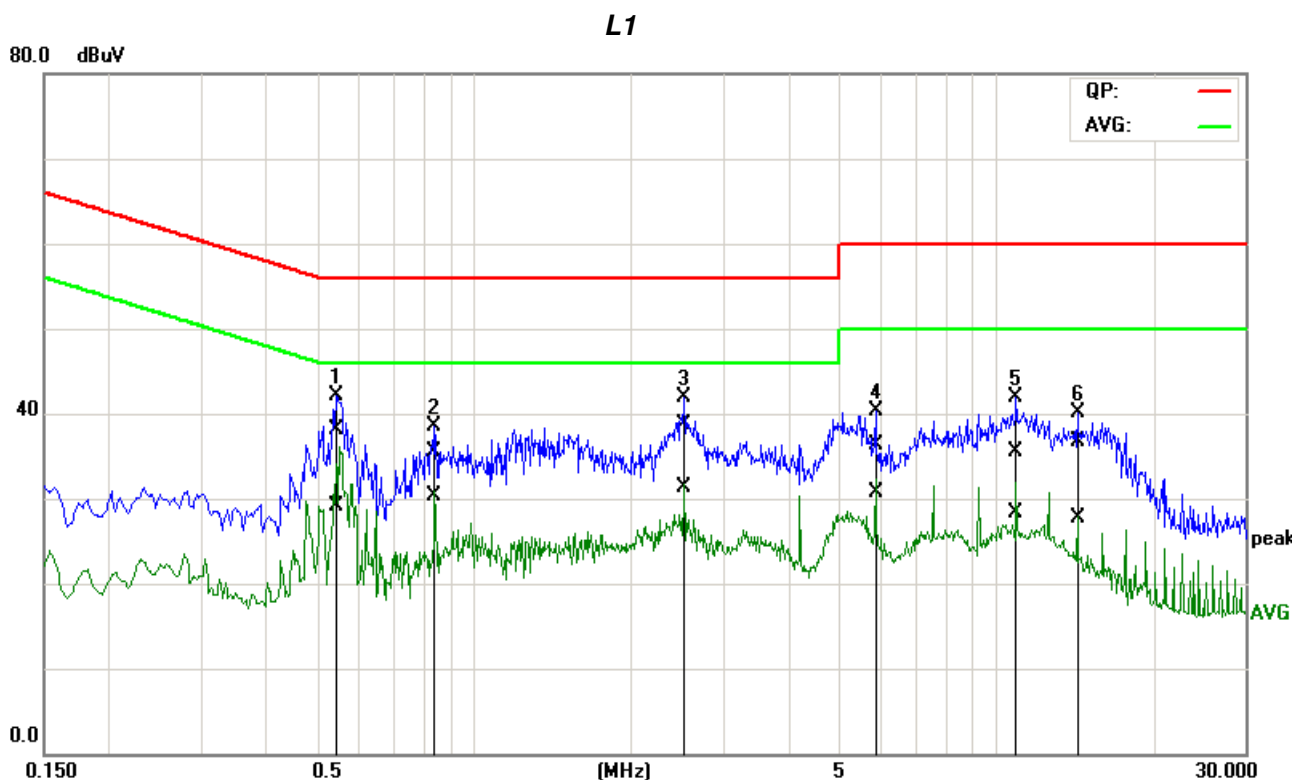

No.	Frequency (MHz)	QuasiPeak reading (dBuV)	Average reading (dBuV)	Correction factor (dB)	QuasiPeak result (dBuV)	Average result (dBuV)	QuasiPeak limit (dBuV)	Average limit (dBuV)	QuasiPeak margin (dB)	Average margin (dB)	Remark
1	0.5428	18.37	9.31	19.81	38.18	29.12	56.00	46.00	-17.82	-16.88	Pass
2	0.8436	15.72	10.58	19.80	35.52	30.38	56.00	46.00	-20.48	-15.62	Pass
3*	2.5272	18.89	11.52	19.87	38.76	31.39	56.00	46.00	-17.24	-14.61	Pass
4	5.8983	16.44	10.87	19.93	36.37	30.80	60.00	50.00	-23.63	-19.20	Pass
5	10.9561	15.61	8.40	19.97	35.58	28.37	60.00	50.00	-24.42	-21.63	Pass
6	14.3234	16.61	7.60	20.02	36.63	27.62	60.00	50.00	-23.37	-22.38	Pass

**Note:** 1. L1 = Line One (Live Line) / L2 = Line Two (Neutral Line).

Job No.:	C160628R01	Date:	2016-7-22
Model No.:	YHS.1916	Time:	PM 02:27:50
Standard:	FCC Class B	Temp.(C)/Hum.(%):	22(C)/48%
Test item:	Conduction test	Test By:	Lily.Wang
Line:	L2	Test Voltage:	AC 120V/60Hz
Model:		Description:	

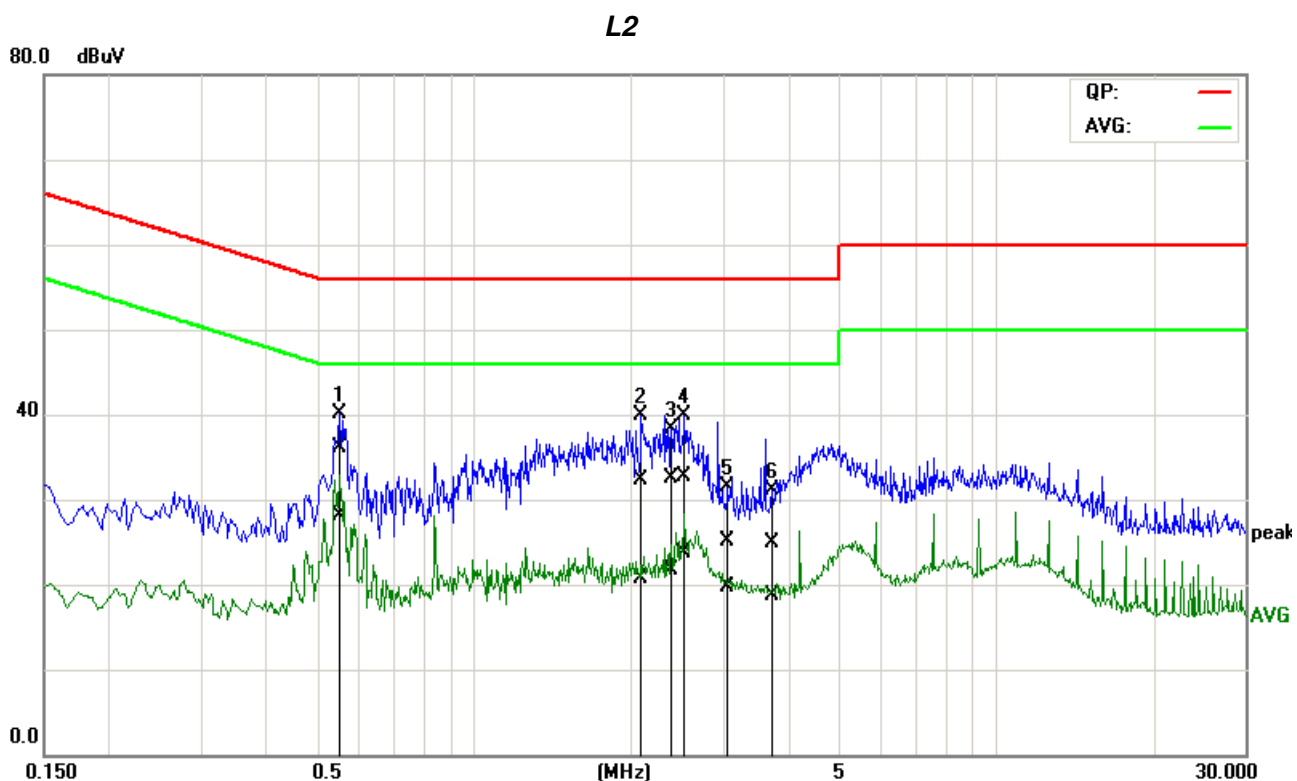

No.	Frequency (MHz)	QuasiPeak reading (dBuV)	Average reading (dBuV)	Correction factor (dB)	QuasiPeak result (dBuV)	Average result (dBuV)	QuasiPeak limit (dBuV)	Average limit (dBuV)	QuasiPeak margin (dB)	Average margin (dB)	Remark
1*	0.5524	16.45	8.37	19.75	36.20	28.12	56.00	46.00	-19.80	-17.88	Pass
2	2.0846	12.48	0.84	19.77	32.25	20.61	56.00	46.00	-23.75	-25.39	Pass
3	2.3734	12.72	1.88	19.77	32.49	21.65	56.00	46.00	-23.51	-24.35	Pass
4	2.5206	12.99	3.99	19.78	32.77	23.77	56.00	46.00	-23.23	-22.23	Pass
5	3.0183	5.23	-0.06	19.79	25.02	19.73	56.00	46.00	-30.98	-26.27	Pass
6	3.6653	5.17	-1.14	19.80	24.97	18.66	56.00	46.00	-31.03	-27.34	Pass

**Note:** 1. L1 = Line One (Live Line) / L2 = Line Two (Neutral Line).

Job No.:	C160628R01	Date:	2016-7-22
Model No.:	YHS.1916	Time:	PM 02:11:24
Standard:	FCC Class B	Temp.(C)/Hum.(%):	22(C)/48%
Test item:	Conduction test	Test By:	Lily.Wang
Line:	L1	Test Voltage:	AC 240V/60Hz
Model:		Description:	

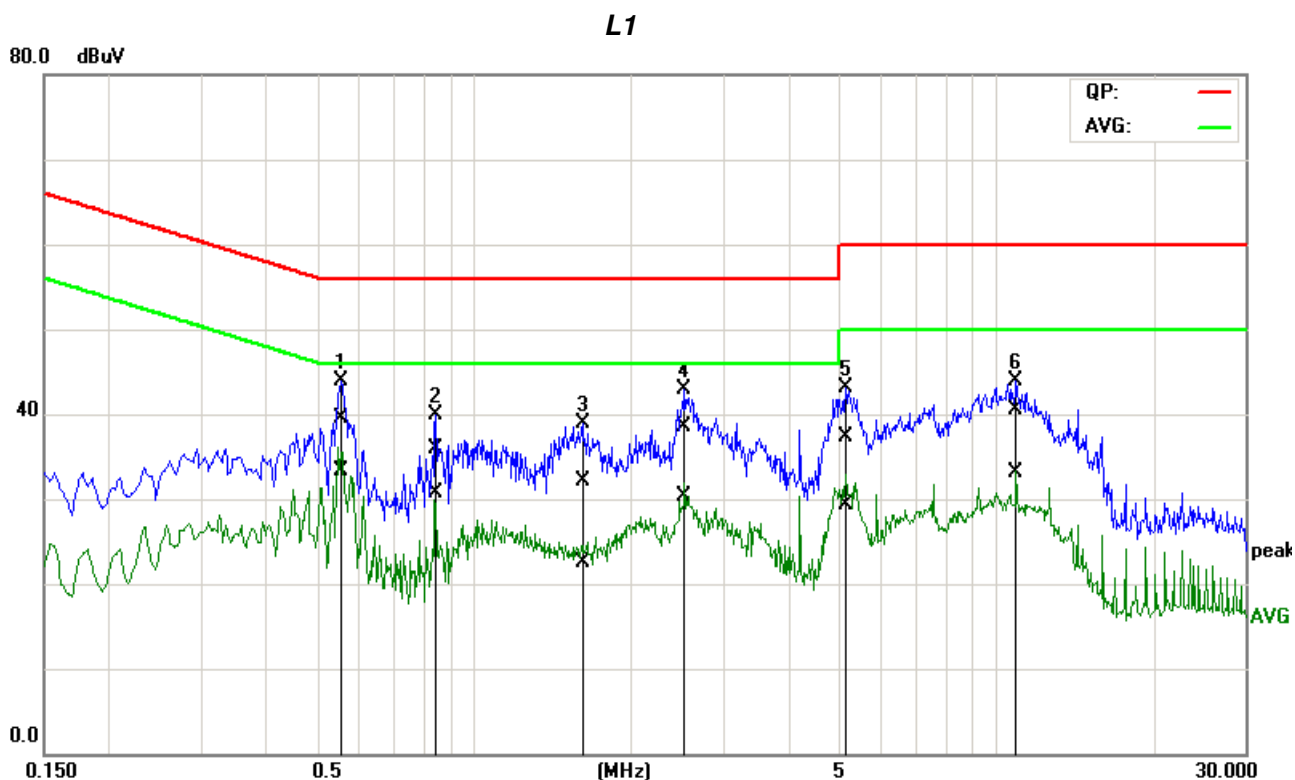

No.	Frequency (MHz)	QuasiPeak reading (dBuV)	Average reading (dBuV)	Correction factor (dB)	QuasiPeak result (dBuV)	Average result (dBuV)	QuasiPeak limit (dBuV)	Average limit (dBuV)	QuasiPeak margin (dB)	Average margin (dB)	Remark
1*	0.5594	19.79	13.57	19.81	39.60	33.38	56.00	46.00	-16.40	-12.62	Pass
2	0.8429	16.13	11.00	19.80	35.93	30.80	56.00	46.00	-20.07	-15.20	Pass
3	1.5988	12.33	2.71	19.82	32.15	22.53	56.00	46.00	-23.85	-23.47	Pass
4	2.5254	18.54	10.46	19.87	38.41	30.33	56.00	46.00	-17.59	-15.67	Pass
5	5.1616	17.44	9.41	19.93	37.37	29.34	60.00	50.00	-22.63	-20.66	Pass
6	10.9574	20.59	13.18	19.97	40.56	33.15	60.00	50.00	-19.44	-16.85	Pass

**Note:** 1. L1 = Line One (Live Line) / L2 = Line Two (Neutral Line).

Job No.:	C160628R01	Date:	2016-7-22
Model No.:	YHS.1916	Time:	PM 02:17:01
Standard:	FCC Class B	Temp.(C)/Hum.(%):	22(C)/48%
Test item:	Conduction test	Test By:	Lily.Wang
Line:	L2	Test Voltage:	AC 240V/60Hz
Model:		Description:	

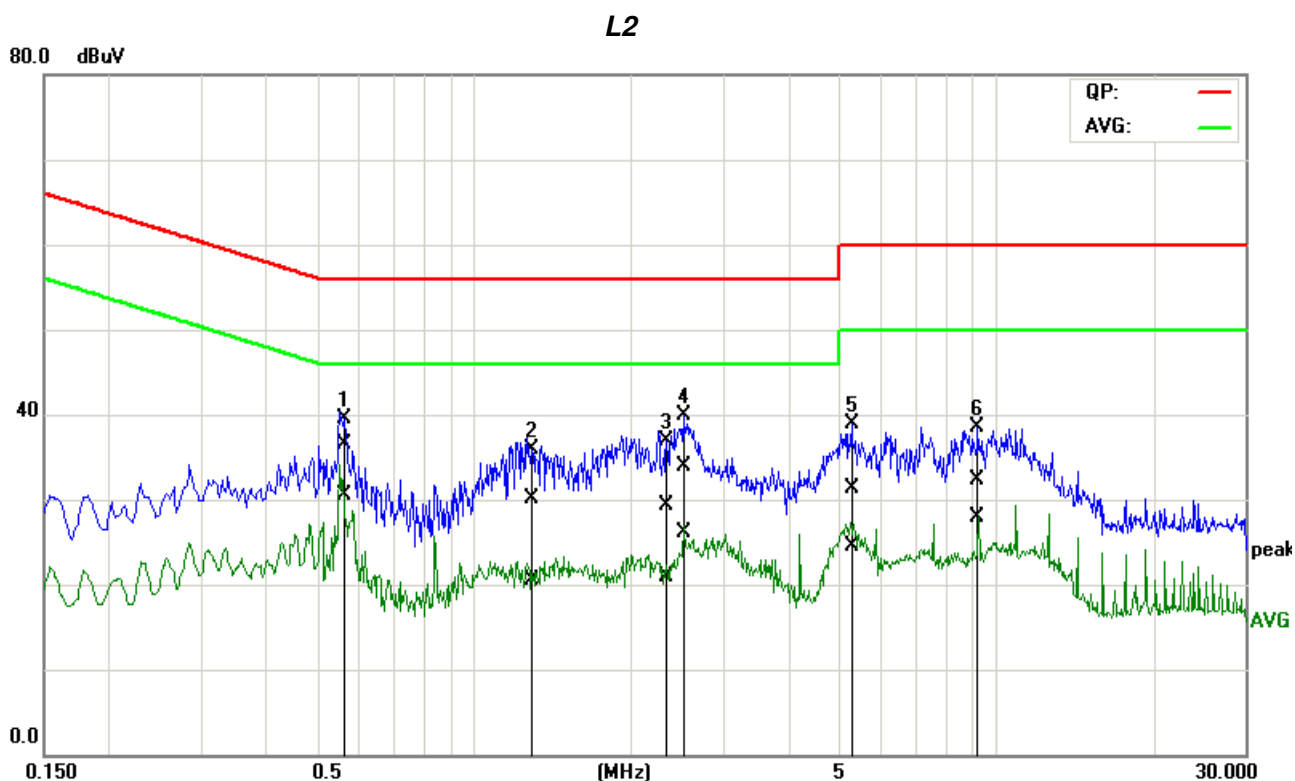

No.	Frequency (MHz)	QuasiPeak reading (dBuV)	Average reading (dBuV)	Correction factor (dB)	QuasiPeak result (dBuV)	Average result (dBuV)	QuasiPeak limit (dBuV)	Average limit (dBuV)	QuasiPeak margin (dB)	Average margin (dB)	Remark
1*	0.5593	16.67	10.80	19.75	36.42	30.55	56.00	46.00	-19.58	-15.45	Pass
2	1.2998	10.34	0.80	19.75	30.09	20.55	56.00	46.00	-25.91	-25.45	Pass
3	2.3101	9.53	1.15	19.77	29.30	20.92	56.00	46.00	-26.70	-25.08	Pass
4	2.5245	14.22	6.25	19.78	34.00	26.03	56.00	46.00	-22.00	-19.97	Pass
5	5.3318	11.42	4.63	19.84	31.26	24.47	60.00	50.00	-28.74	-25.53	Pass
6	9.2669	12.23	7.83	20.08	32.31	27.91	60.00	50.00	-27.69	-22.09	Pass

**Note:** 1. L1 = Line One (Live Line) / L2 = Line Two (Neutral Line).

**Remark:**

1. The measuring frequencies range between 0.15 MHz and 30 MHz.
2. The emissions measured in the frequency range between 0.15 MHz and 30MHz were made with an instrument using Quasi-peak detector and Average detector.
3. "----" denotes the emission level was or more than 2dB below the Average limit, and no re-check was made.
4. The IF bandwidth of SPA between 0.15MHz and 30MHz was 10KHz. The IF bandwidth of Test Receiver between 0.15MHz and 30MHz was 9kHz.

**END OF REPORT**