

FCC 47 CFR PART 15 SUBPART C

TEST REPORT

For

Product Name: Yi Lite Action Camera

Brand Name: YI

Model No.: YAS.1117

Series Model.: N/A

FCC ID: 2AFIB-YAS1117

Test Report Number:

C170510R02-RPW

Issued for

Shanghai Xiaoyi Technology Co., Ltd.

6F,Building E,No.2889,Jinke Road,Shanghai,China

Issued by

Compliance Certification Services Inc.

Kun shan Laboratory

No.10 Weiye Rd., Innovation park, Eco&Tec,
Development Zone, Kunshan City, Jiangsu, China

TEL: 86-512-57355888

FAX: 86-512-57370818



Note: This report shall not be reproduced except in full, without the written approval of Compliance Certification Services Inc. This document may be altered or revised by Compliance Certification Services Inc. personnel only, and shall be noted in the revision section of the document. The client should not use it to claim product endorsement by A2LA or any government agencies. The test results in the report only apply to the tested sample.

TABLE OF CONTENTS

1.	TEST RESULT CERTIFICATION.....	4
2.	EUT DESCRIPTION.....	5
3.	TEST METHODOLOGY	6
3.1.	EUT CONFIGURATION	6
3.2.	EUT EXERCISE	6
3.3.	GENERAL TEST PROCEDURES.....	6
3.4.	FCC PART 15.205 RESTRICTED BANDS OF OPERATIONS.....	7
3.5.	DESCRIPTION OF TEST MODES.....	8
3.6.	ANTENNA DESCRIPTION	8
4.	INSTRUMENT CALIBRATION.....	9
4.1.	MEASURING INSTRUMENT CALIBRATION	9
5.	FACILITIES AND ACCREDITATIONS	11
5.1.	FACILITIES	11
5.2.	EQUIPMENT.....	11
5.3.	LABORATORY ACCREDITATIONS AND LISTING	11
5.4.	TABLE OF ACCREDITATIONS AND LISTINGS	12
6.	SETUP OF EQUIPMENT UNDER TEST.....	13
6.1.	SETUP CONFIGURATION OF EUT.....	13
6.2.	SUPPORT EQUIPMENT.....	13
7.	FCC PART 15.247 REQUIREMENTS.....	14
7.1.	6DB BANDWIDTH	14
7.2.	PEAK POWER	20
7.3.	PEAK POWER SPECTRAL DENSITY	22
7.4.	SPURIOUS EMISSIONS	29
7.5.	RADIATED EMISSIONS.....	47
7.6.	POWERLINE CONDUCTED EMISSIONS	62

Revision History

Rev.	Issue Date	Report NO.	Effect Page	Contents
00	June 19, 2017	C170510R02-RPW	ALL	N/A

1. TEST RESULT CERTIFICATION

Product Name:	Yi Lite Action Camera
Trade Name:	YI
Model Name.:	YAS.1117
Series Model:	N/A
Applicant Discrepancy:	Initial
Device Category:	Portable unit
Date of Test:	June 13, 2017 ~ June 18, 2017
Applicant:	Shanghai Xiaoyi Technology Co., Ltd. 6F,Building E,No.2889,Jinke Road,Shanghai,China
Manufacturer:	Shanghai Xiaoyi Technology Co., Ltd. 6F,Building E,No.2889,Jinke Road,Shanghai,China
Application Type:	Certification

APPLICABLE STANDARDS	
STANDARD	TEST RESULT
FCC 47 CFR Part 15 Subpart C	No non-compliance noted

We hereby certify that:

The above equipment was tested by Compliance Certification Services Inc. The test data, data evaluation, test procedures, and equipment configurations shown in this report were made in accordance with the procedures given in ANSI C63.10: 2013 and the energy emitted by the sample EUT tested as described in this report is in compliance with the requirements of FCC Rules Part 15.207, 15.209, 15.247.

The test results of this report relate only to the tested sample EUT identified in this report.

Approved by:

Jeff.Fang
RF Manager
Compliance Certification Service Inc.

Tested by:

Lily.Wang
Test Engineer
Compliance Certification Service Inc.

2. EUT DESCRIPTION

Product Name:	Yi Lite Action Camera
Brand Name:	YI
Model Name:	YAS.1117
Series Model:	N/A
Model Discrepancy:	N/A
Power Adapter:	From PC
Frequency Range:	IEEE 802.11b/g: 2412MHz to 2462 MHz IEEE 802.11n HT20: 2412MHz to 2462 MHz
Average Transmit Power:	IEEE 802.11b mode: 14.55dBm IEEE 802.11g mode: 13.28 dBm IEEE 802.11n HT20 mode: 13.40 dBm
Modulation Technique:	IEEE802.11b mode: DSSS (1,2,5.5 and 11 Mbps) IEEE802.11g mode: DSSS /OFDM (6,9,12,18,24,36,48 and 54 Mbps) IEEE802.11n HT20 mode: OFDM (MCS0~MCS7)
Number of Channels:	IEEE 802.11b/g mode: 11 Channels IEEE 802.11n HT20 : 11 Channels
Antenna Specification:	FPC Antenna Gain: -3.41 dBi

Remark:

- 1.The sample selected for test was engineering sample that approximated to production product and was provided by manufacturer.
- 2.This submittal(s) (test report) is intended for **FCC ID: 2AFIB-YAS1117** filing to comply with Section 15.207, 15.209 and 15.247 of the FCC Part 15, Subpart C Rules.

3. TEST METHODOLOGY

The tests documented in this report were performed in accordance with ANSI C63.10 2013 and FCC CFR 47 15.207, 15.209 and 15.247.

3.1.EUT CONFIGURATION

The EUT configuration for testing is installed on RF field strength measurement to meet the Commissions requirement and operating in a manner that intends to maximize its emission characteristics in a continuous normal application.

3.2.EUT EXERCISE

The EUT was operated in the engineering mode to fix the TX frequency that was for the purpose of the measurements.

According to its specifications, the EUT must comply with the requirements of the Section 15.207, 15.209 and 15.247 under the FCC Rules Part 15 Subpart C.

3.3.GENERAL TEST PROCEDURES

Conducted Emissions

The EUT is placed on the turntable, which is 0.8 m above ground plane. According to the requirements in Section 13.1.4.1 of ANSI C63.10 2013 Conducted emissions from the EUT measured in the frequency range between 0.15 MHz and 30MHz using CISPR Quasi-peak and average detector modes.

Radiated Emissions

Under 1GHz

The EUT is placed on a turn table, which is 0.8 m above ground plane. The turntable shall rotate 360 degrees to determine the position of maximum emission level. EUT is set 3m away from the receiving antenna, which varied from 1m to 4m to find out the highest emission. And also, each emission was to be maximized by changing the polarization of receiving antenna both horizontal and vertical. In order to find out the maximum emissions, exploratory radiated emission measurements were made according to the requirements in Section 13.1.4.1 of ANSI C63.10:2013.

Above 1GHz

The EUT is placed on a turn table, which is 1.5 m above ground plane. The turntable shall rotate 360 degrees to determine the position of maximum emission level. EUT is set 3m away from the receiving antenna, which varied from 1m to 4m to find out the highest emission. And also, each emission was to be maximized by changing the polarization of receiving antenna both horizontal and vertical. In order to find out the maximum emissions, exploratory radiated emission measurements were made according to the requirements in Section 13.1.4.1 of ANSI C63.10:2013.

3.4.FCC PART 15.205 RESTRICTED BANDS OF OPERATIONS

Except as shown in paragraph (d) of this section, only spurious emissions are permitted in any of the frequency bands listed below:

MHz	MHz	MHz	GHz
0.090 - 0.110	16.42 - 16.423	399.9 - 410	4.5 - 5.15
¹ 0.495 - 0.505	16.69475 - 16.69525	608 - 614	5.35 - 5.46
2.1735 - 2.1905	16.80425 - 16.80475	960 - 1240	7.25 - 7.75
4.125 - 4.128	25.5 - 25.67	1300 - 1427	8.025 - 8.5
4.17725 - 4.17775	37.5 - 38.25	1435 - 1626.5	9.0 - 9.2
4.20725 - 4.20775	73 - 74.6	1645.5 - 1646.5	9.3 - 9.5
6.215 - 6.218	74.8 - 75.2	1660 - 1710	10.6 - 12.7
6.26775 - 6.26825	108 - 121.94	1718.8 - 1722.2	13.25 - 13.4
6.31175 - 6.31225	123 - 138	2200 - 2300	14.47 - 14.5
8.291 - 8.294	149.9 - 150.05	2310 - 2390	15.35 - 16.2
8.362 - 8.366	156.52475 - 156.52525	2483.5 - 2500	17.7 - 21.4
8.37625 - 8.38675	156.7 - 156.9	2655 - 2900	22.01 - 23.12
8.41425 - 8.41475	162.0125 - 167.17	3260 - 3267	23.6 - 24.0
12.29 - 12.293	167.72 - 173.2	3332 - 3339	31.2 - 31.8
12.51975 - 12.52025	240 - 285	3345.8 - 3358	36.43 - 36.5
12.57675 - 12.57725	322 - 335.4	3600 - 4400	(²)
13.36 - 13.41			

¹ Until February 1, 1999, this restricted band shall be 0.490-0.510 MHz.

² Above 38.6

Except as provided in paragraphs (d) and (e), the field strength of emissions appearing within these frequency bands shall not exceed the limits shown in Section 15.209. At frequencies equal to or less than 1000 MHz, compliance with the limits in Section 15.209 shall be demonstrated using measurement instrumentation employing a CISPR quasi-peak detector. Above 1000 MHz, compliance with the emission limits in Section 15.209 shall be demonstrated based on the average value of the measured emissions. The provisions in Section 15.35 apply to these measurements.

3.5. DESCRIPTION OF TEST MODES

The worst-case data rates:

IEEE802.11b mode:

Channel Low (2412MHz)

Channel Mid (2437MHz)

Channel High (2462MHz) with 1Mbps data rate was chosen for full testing.

IEEE802.11g mode:

Channel Low (2412MHz)

Channel Mid (2437MHz)

Channel High (2462MHz) with 6Mbps data rate was chosen for full testing.

IEEE 802.11n HT20 MHz Channel mode:

Channel Low (2412MHz)

Channel Mid (2437MHz)

Channel High (2462MHz) with MCS0 data rate was chosen for full testing.

3.6. ANTENNA DESCRIPTION

an intentional radiator antenna shall be designed to ensure that no antenna other than that furnished by the responsible party can be used with the device. The use of a permanently attached or an antenna that uses a unique coupling to the intentional radiator shall be considered sufficient to comply with the provisions of this section”

* the antenna of this EUT is a unique(FPC Antenna for WiFi).

* the EUT complies with the requirement of 15.203.

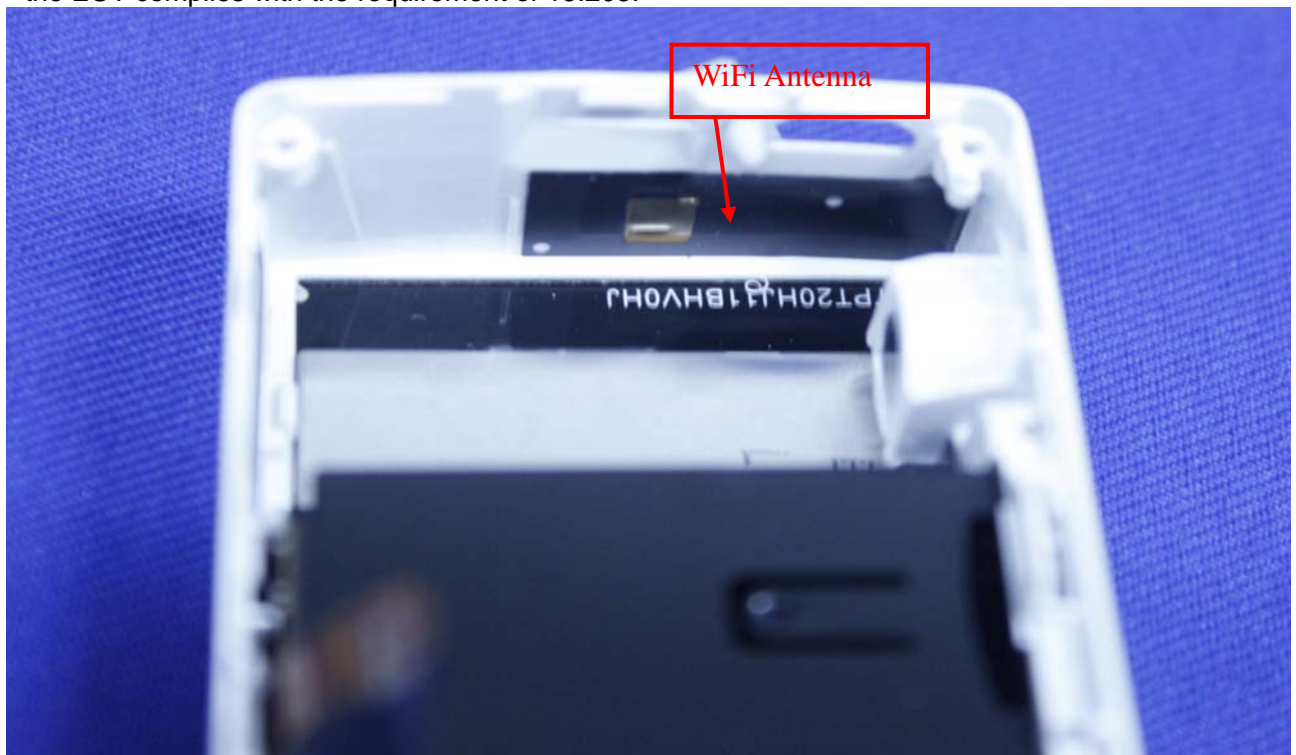

4. INSTRUMENT CALIBRATION

4.1.MEASURING INSTRUMENT CALIBRATION

The measuring equipment, which was utilized in performing the tests documented herein, has been calibrated in accordance with the manufacturer's recommendations for utilizing calibration equipment, which is traceable to recognized national standards.

Equipment Used for Emissions Measurement

Conducted Emissions Test Site					
Name of Equipment	Manufacturer	Model	Serial Number	Calibration Date	Calibration Due
Spectrum Analyzer	Agilent	E4446A	MY44020154	2016-9-10	2017-9-9
Spectrum Analyzer	RS	FSU26	200789	2016-7-21	2017-7-20
Power meter	Anritsu	ML2495A	1445010	2017-4-26	2018-4-25
Power sensor	Anritsu	MA2411B	1339220	2017-4-26	2018-4-25
Power SPLITTER	Mini-Circuits	ZN2PD-9G	SF078500430	N.C.R	N.C.R
DC Power Supply	AGILENT	E3632A	MY50340053	N.C.R	N.C.R
Temp. / Humidity Gauge	Anymetre	TH603	CCS007	2016-11-1	2017-10-31
Test Software			EZ-EMC		

977 Chamber					
Name of Equipment	Manufacturer	Model	Serial Number	Calibration Date	Calibration Due
Spectrum Analyzer	Agilent	E4446A	MY44020154	2016-9-10	2017-9-9
Spectrum Analyzer	RS	FSU26	200789	2016-7-21	2017-7-20
EMI Test Receiver	R&S	ESCI	101378	2017-1-5	2018-1-4
Pre-Amplifier	MINI	ZFL-1000VH2	070306	2017-1-5	2018-1-4
Pre-Amplifier	Miteq	JS41-00101800-32-10P	1675713	2016-7-21	2017-7-20
Bilog Antenna	Sunol	JB1	A062604	2017-5-27	2018-5-26
Bilog Antenna	Sunol	JB1	A110204-1	2017-5-27	2018-5-26
Loop Antenna	SCHWARZBECK	HXYZ9170	9170-108	2017-3-4	2018-3-3
Horn-antenna	SCHWARZBECK	9120D	D:266	2017-3-5	2018-3-4
Horn-antenna	SCHWARZBECK	9120D	D:267	2016-11-10	2017-11-9
Turn Table	CT	CT123	4165	N.C.R	N.C.R
Antenna Tower	CT	CTERG23	3256	N.C.R	N.C.R
Controller	CT	CT100	95637	N.C.R	N.C.R
Test Software			EZ-EMC		

Conducted Emission					
Name of Equipment	Manufacturer	Model	Serial Number	Calibration Date	Calibration Due
EMI TEST RECEIVER	R&S	ESCI	100781	2017-2-28	2018-2-27
V (V-LISN)	SCHWARZBECK	NNLK 8129	8129-143	2016-11-1	2017-10-31
TWO-LINE V-NETWORK	R&S	ENV216	101604	2016-11-1	2017-10-31
Pulse LIMITER	R&S	ESH3-Z2	100524	2017-1-5	2018-1-4
Test Software			EZ-EMC		

Remark: The measurement uncertainty is less than +/- 2.81dB, which is evaluated as per the NAMAS NIS 81 and CISPR/A/291/CDV.

Expanded Uncertainty (95% CONFIDENCE INTERVAL): K=2

5. FACILITIES AND ACCREDITATIONS

5.1.FACILITIES

All measurement facilities used to collect the measurement data are located at CCS China Kunshan Lab at 10#Weiye Rd, Innovation Park Eco. & Tec. Development Zone Kunshan city JiangSu, (215300), CHINA.

The sites are constructed in conformance with the requirements of ANSI C63.7, ANSI C63.10 2013 and CISPR Publication 22.

5.2.EQUIPMENT

Radiated emissions are measured with one or more of the following types of linearly polarized antennas: tuned dipole, biconical, log periodic, bi-log, and/or ridged waveguide, horn. Spectrum analyzers with pre-selectors and quasi-peak detectors are used to perform radiated measurements.

Conducted emissions are measured with Line Impedance Stabilization Networks and EMI Test Receivers.

Calibrated wideband preamplifiers, coaxial cables, and coaxial attenuators are also used for making measurements.

All receiving equipment conforms to CISPR Publication 16-1, "Radio Interference Measuring Apparatus and Measurement Methods."

5.3.LABORATORY ACCREDITATIONS AND LISTING

The test facilities used to perform radiated and conducted emissions tests are accredited by American Association for Laboratory Accreditation Program for the specific scope accreditation under Lab Code: 200581-0 to perform Electromagnetic Interference tests according to FCC Part 15 and CISPR 22 requirements. In addition, the test facilities are listed with USA, Certification and Engineering Bureau, 424105 for 10m chamber, 238958 for 3m chamber.

5.4. TABLE OF ACCREDITATIONS AND LISTINGS

Country	Agency	Scope of Accreditation	Logo
USA	A2LA	47 CFR FCC Part 15/18 (using ANSI C63.10 :2013); VCCI V3; CNS 13438; CNS 13439; CNS 13803; CISPR 11; EN 55011; CISPR 13; EN 55013; CISPR 22:2005; CISPR 22:1997 +A1 :2000+A2 :2002; EN 55022:2006; EN55022 :1998 +A1 :2001+A2 :2003; EN 61000-6-3 (excluding discontinuous interference); EN 61000-6-4; AS/NZS CISPR 22; CAN/CSA-CEI/IEC CISPR 22; EN 61000-3-2; EN 61000-3-3; EN550024; EN 61000-4-2; EN 61000-4-3; EN61000-4-4; EN 61000-4-5; EN 61000-4-6; IEC 61000-4-8; EN 61000-4-11; IEC61000-3-2; IEC61000-3-3; IEC 61000-4-2; IEC 61000-4-3; IEC 61000-4-4; IEC 61000-4-5; IEC 61000-4-6; IEC 61000-4-8; IEC 61000-4-11; EN 300 220-3; EN 300 328; EN 300 330-2; EN 300 440-1; EN 300-440-2; EN 300 893; EN 301 489-01; EN 301 489-3; EN 301 489-07; EN 301 489-17; 47 CFR FCC Part 15, 22, 24	
USA	FCC	3/10 meter Sites to perform FCC Part 15/18 measurements	 93105, 90471
Japan	VCCI	3/10 meter Sites and conducted test sites to perform radiated/conducted measurements	VCCI R-1600 C-1707 G-216

* No part of this report may be used to claim or imply product endorsement by A2LA or any agency of the US Government.

6. SETUP OF EQUIPMENT UNDER TEST

6.1.SETUP CONFIGURATION OF EUT

See test photographs attached in Appendix 1 for the actual connections between EUT and support equipment.

6.2.SUPPORT EQUIPMENT

No.	Device Type	Brand	Model	Series No.	FCC ID
1.	N/A				

Remark:

1. All the equipment/cables were placed in the worst-case configuration to maximize the emission during the test.
2. Grounding was established in accordance with the manufacturer's requirements and conditions for the intended use.

7. FCC PART 15.247 REQUIREMENTS

7.1.6DB BANDWIDTH

LIMIT

According to §15.247(a)(2), systems using digital modulation techniques may operate in the 902 - 928 MHz, and 2400 - 2483.5 MHz bands, and 5725 - 5850 MHz bands. The minimum 6dB bandwidth shall be at least 500kHz.

Test Configuration

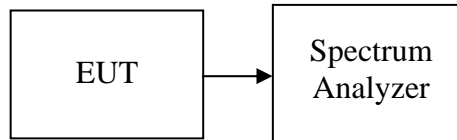

TEST PROCEDURE

The transmitter output is connected to the spectrum analyzer. The RBW is set to 1% to 3% of the selected span. The VBW is set to 3 times the RBW. The sweep time is occupied.

TEST RESULTS

No non-compliance noted

Test Data

IEEE 802.11b mode

Channel	Frequency (MHz)	Bandwidth (MHz)	Limit (kHz)	Result
Low	2412	8.158	>500	PASS
Mid	2437	8.154		PASS
High	2462	8.153		PASS

IEEE 802.11g mode

Channel	Frequency (MHz)	Bandwidth (MHz)	Limit (kHz)	Result
Low	2412	16.383	>500	PASS
Mid	2437	16.388		PASS
High	2462	16.423		PASS

IEEE 802.11n HT20 mode

Channel	Frequency (MHz)	Bandwidth (MHz)	Limit (kHz)	Result
Low	2412	17.633	>500	PASS
Mid	2437	17.665		PASS
High	2462	17.623		PASS

Test Plot

IEEE 802.11b MODE

6dB Bandwidth (CH Low)

Agilent

R T

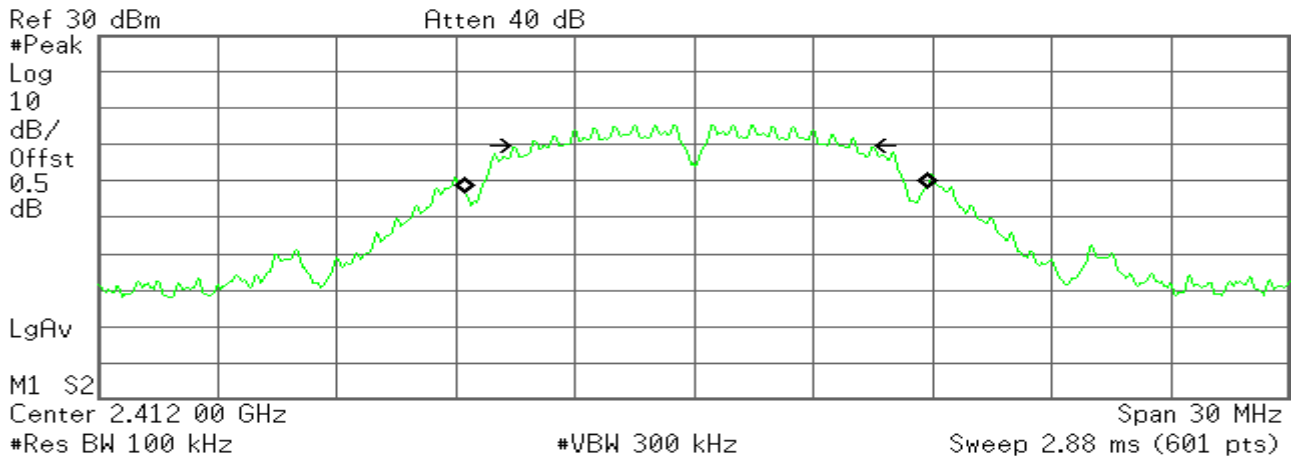

Occupied Bandwidth
11.5805 MHz

Occ BW % Pwr 99.00 %
x dB -6.00 dB

Transmit Freq Error 54.506 kHz
x dB Bandwidth 8.158 MHz

6dB Bandwidth (CH Mid)

Agilent

R T

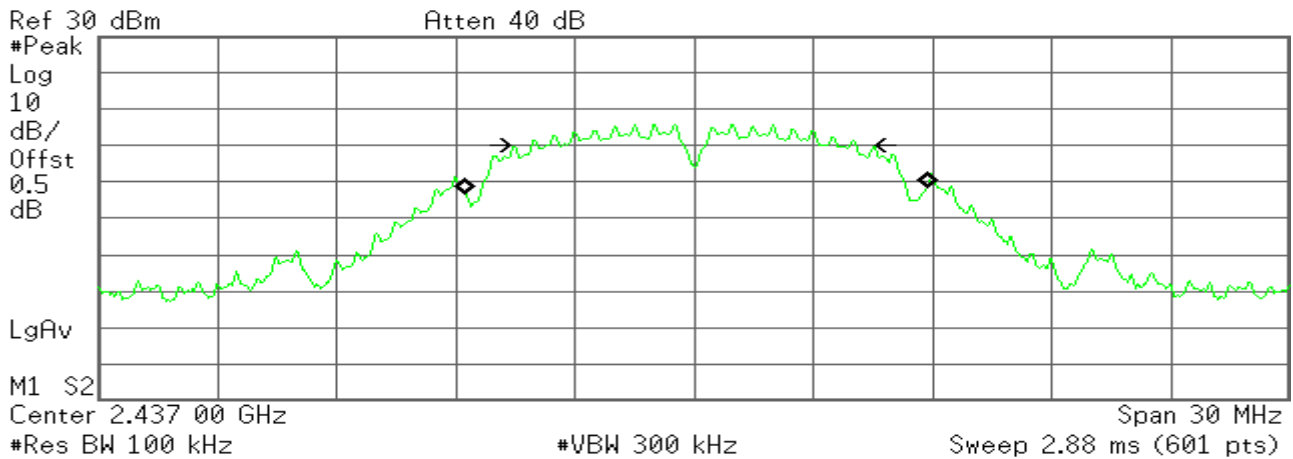

Occupied Bandwidth
11.5896 MHz

Occ BW % Pwr 99.00 %
x dB -6.00 dB

Transmit Freq Error 54.779 kHz
x dB Bandwidth 8.154 MHz

6dB Bandwidth (CH High)

Agilent

R T

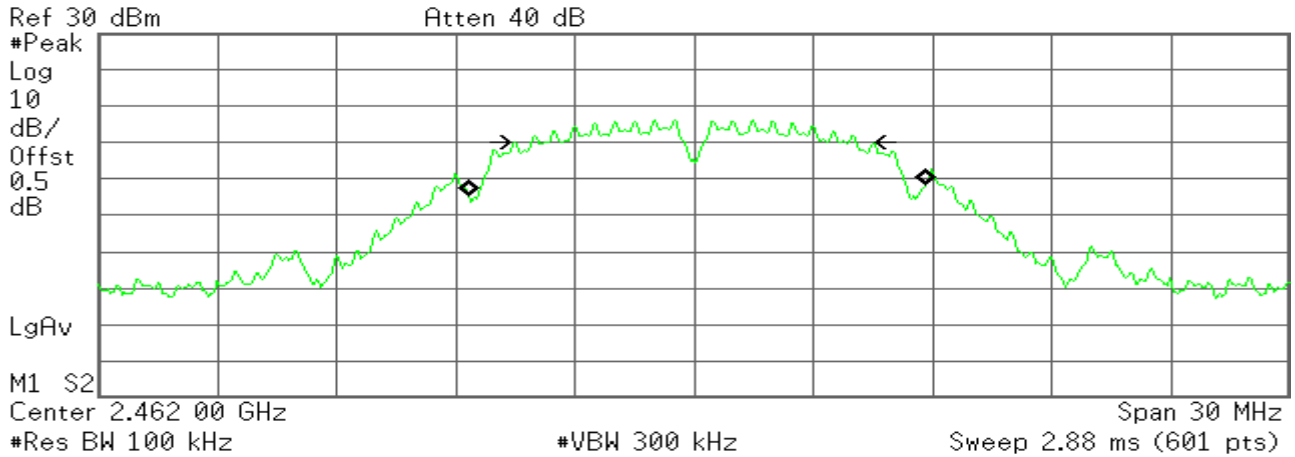

Occupied Bandwidth
11.4521 MHz

Occ BW % Pwr 99.00 %
x dB -6.00 dB

Transmit Freq Error 73.350 kHz
x dB Bandwidth 8.153 MHz

IEEE 802.11g MODE

6dB Bandwidth (CH Low)

Agilent

R T

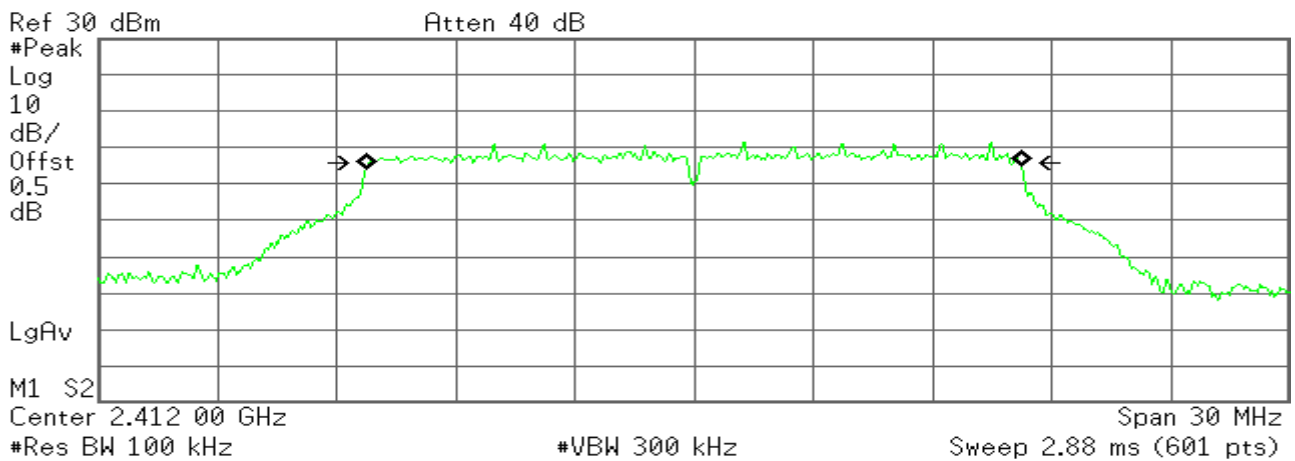

Occupied Bandwidth
16.5128 MHz

Occ BW % Pwr 99.00 %
x dB -6.00 dB

Transmit Freq Error -6.604 kHz
x dB Bandwidth 16.383 MHz

6dB Bandwidth (CH Mid)

Agilent

R T

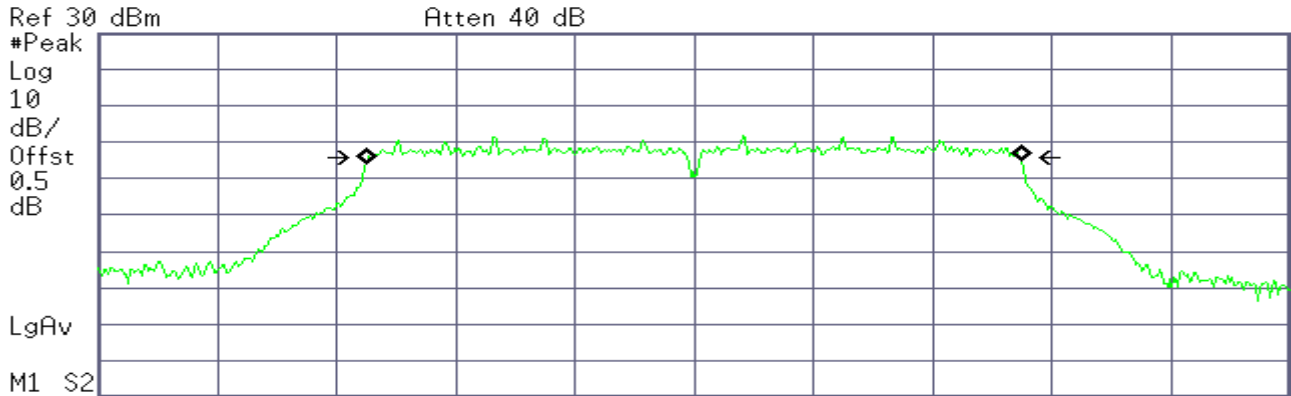

Occupied Bandwidth
16.5063 MHz

Occ BW % Pwr 99.00 %
x dB -6.00 dB

Transmit Freq Error -9.420 kHz
x dB Bandwidth 16.388 MHz

6dB Bandwidth (CH High)

Agilent

R T

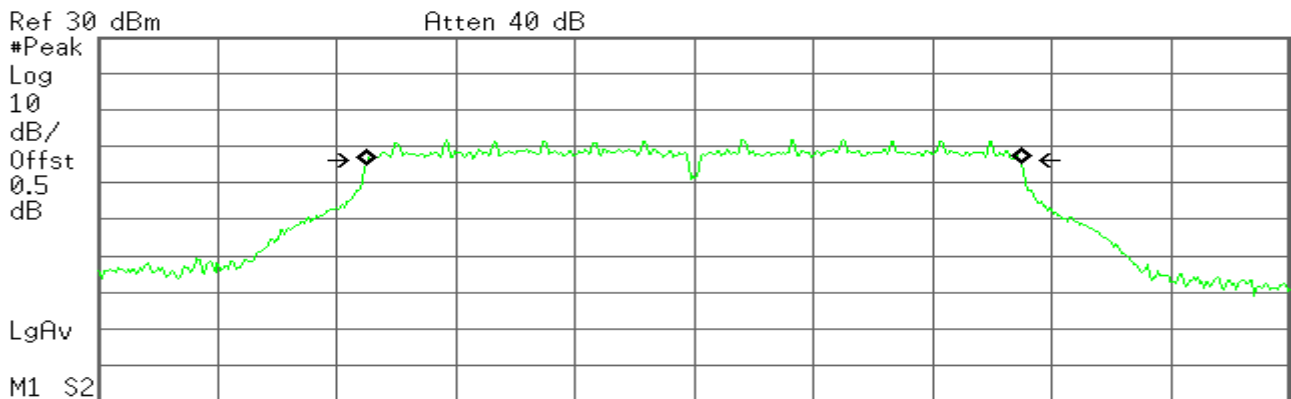

Occupied Bandwidth
16.5042 MHz

Occ BW % Pwr 99.00 %
x dB -6.00 dB

Transmit Freq Error -16.375 kHz
x dB Bandwidth 16.423 MHz

IEEE 802.11n HT20 mode

6dB Bandwidth (CH Low)

Agilent

R T

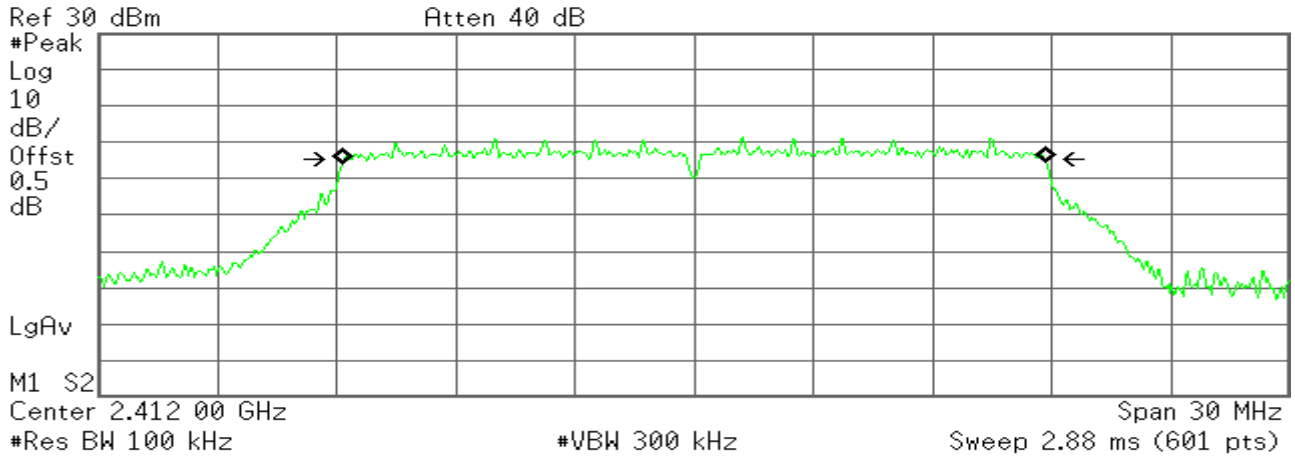

Occupied Bandwidth
17.7077 MHz

Occ BW % Pwr 99.00 %
x dB -6.00 dB

Transmit Freq Error 444.911 Hz
x dB Bandwidth 17.633 MHz

6dB Bandwidth (CH Mid)

Agilent

R T

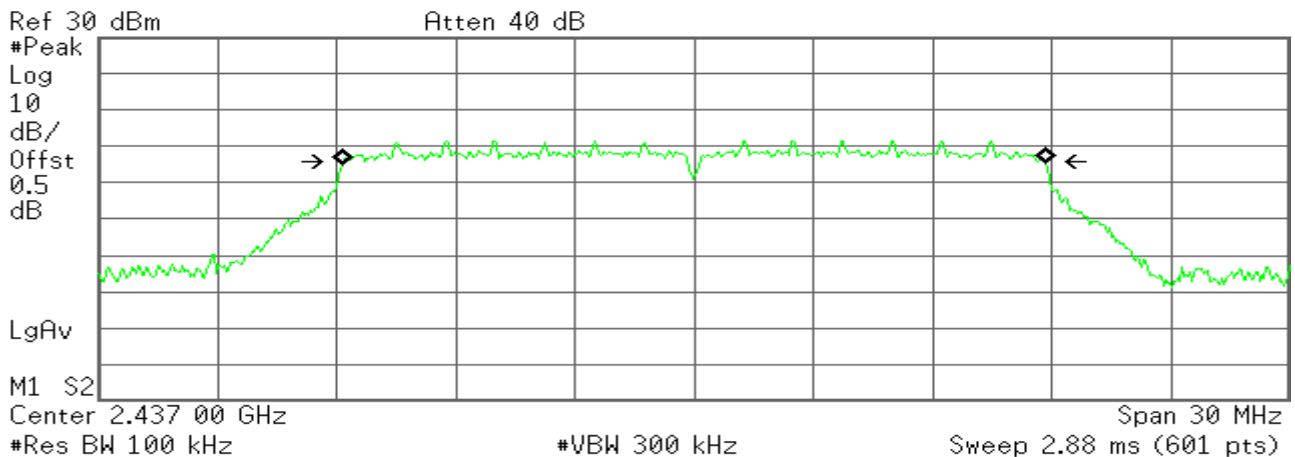

Occupied Bandwidth
17.6977 MHz

Occ BW % Pwr 99.00 %
x dB -6.00 dB

Transmit Freq Error -3.788 kHz
x dB Bandwidth 17.665 MHz

6dB Bandwidth (CH High)

Agilent

R T

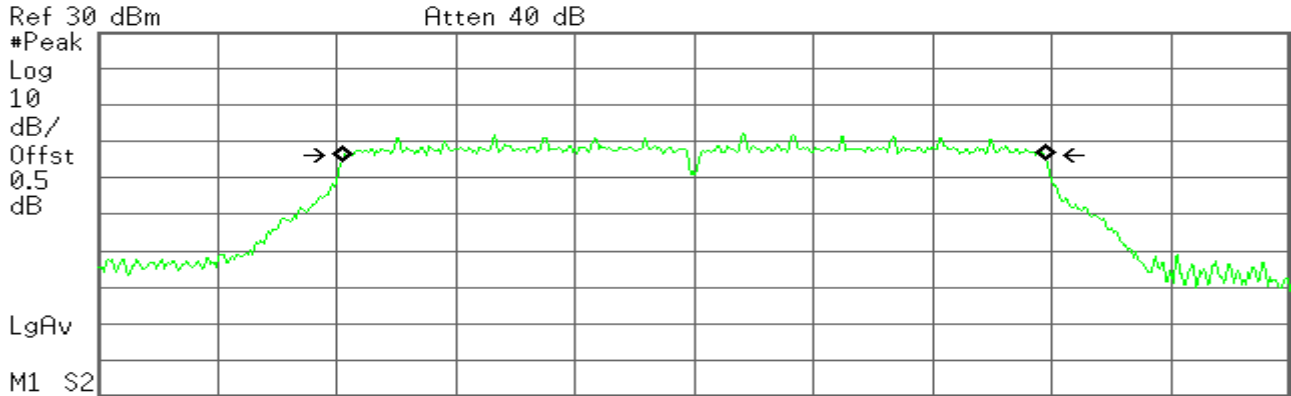

Occupied Bandwidth
17.7010 MHz

Occ BW % Pwr 99.00 %
x dB -6.00 dB

Transmit Freq Error -11.222 kHz
x dB Bandwidth 17.623 MHz

7.2. PEAK POWER

LIMIT

The maximum peak output power of the intentional radiator shall not exceed the following:

1. According to §15.247(b)(3), for systems using digital modulation in the bands of 902-928 MHz, and 2400-2483.5 MHz: 1 Watt.
2. According to §15.247(b)(4), the conducted output power limit specified in paragraph (b) of this section is based on the use of antennas with directional gains that do not exceed 6 dBi. Except as shown in paragraph (c) of this section, if transmitting antennas of directional gain greater than 6 dBi are used, the conducted output power from the intentional radiator shall be reduced below the stated values in paragraphs (b)(1), (b)(2), and (b)(3) of this section, as appropriate, by the amount in dB that the directional gain of the antenna exceeds 6 dBi.

Test Configuration

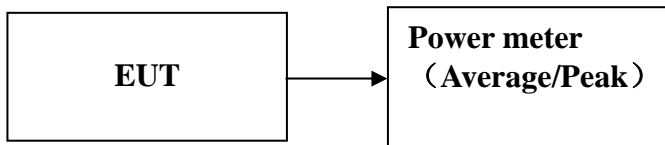

TEST PROCEDURE

1. The EUT transmitter output is connected to the Power meter. The Power meter is set to the peak power detection.
2. The testing follows the Measurement Procedure FCC KDB No. 558074 D01 DTS Meas. Guidance v04 9.1.2 PKPM1 Peak power meter method.

TEST RESULTS

No non-compliance noted

Test Data

Test mode: IEEE 802.11b mode

Channel	Frequency (MHz)	Peak Output Power (dBm)	Limit (dBm)
Low	2412	17.33	30.00
Mid	2437	16.43	30.00
High	2462	16.55	30.00

Channel	Frequency (MHz)	Average Output Power (dBm)	Limit (dBm)
Low	2412	14.38	30.00
Mid	2437	13.49	30.00
High	2462	13.61	30.00

Test mode: IEEE 802.11g mode

Channel	Frequency (MHz)	Peak Output Power (dBm)	Limit (dBm)
Low	2412	22.14	30.00
Mid	2437	22.22	30.00
High	2462	22.40	30.00

Channel	Frequency (MHz)	Average Output Power (dBm)	Limit (dBm)
Low	2412	13.11	30.00
Mid	2437	13.20	30.00
High	2462	13.28	30.00

Test mode: IEEE 802.11n HT20 mode

Channel	Frequency (MHz)	Peak Output Power (dBm)	Limit (dBm)
Low	2412	21.90	30.00
Mid	2437	22.19	30.00
High	2462	22.27	30.00

Channel	Frequency (MHz)	Average Output Power (dBm)	Limit (dBm)
Low	2412	13.19	30.00
Mid	2437	13.22	30.00
High	2462	13.40	30.00

7.3. PEAK POWER SPECTRAL DENSITY

LIMIT

1. According to §15.247(e), for digitally modulated systems, the power spectral density conducted from the intentional radiator to the antenna shall not be greater than 8 dBm in any 3 kHz band during any time interval of continuous transmission.
2. According to §15.247(f), the digital modulation operation of the hybrid system, with the frequency hopping turned off, shall comply with the power density requirements of paragraph (d) of this section.

Test Configuration

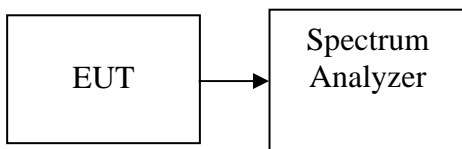

TEST PROCEDURE

1. Place the EUT on the table and set it in transmitting mode. Remove the antenna from the EUT and then connect a low loss RF cable from the antenna port to the spectrum analyzer.
2. Set the spectrum analyzer as RBW = 3 kHz, VBW = 10 kHz, Span = 1.5 times the DTS bandwidth, Sweep = auto
3. Record the max reading.
4. Repeat the above procedure until the measurements for all frequencies are completed.

TEST RESULTS

No non-compliance noted

Test Data**Test mode: IEEE 802.11b mode**

Channel	Frequency (MHz)	PPSD (dBm)	Limit (dBm)	Result
Low	2412	-9.06	8.00	PASS
Mid	2437	-8.66	8.00	PASS
High	2462	-8.20	8.00	PASS

Test mode: IEEE 802.11g mode

Channel	Frequency (MHz)	PPSD (dBm)	Limit (dBm)	Result
Low	2412	-12.01	8.00	PASS
Mid	2437	-11.96	8.00	PASS
High	2462	-11.16	8.00	PASS

Test mode: IEEE 802.11n HT20 mode

Channel	Frequency (MHz)	PPSD (dBm)	Limit (dBm)	Result
Low	2412	-12.49	8.00	PASS
Mid	2437	-12.12	8.00	PASS
High	2462	-11.59	8.00	PASS

Test Plot

IEEE 802.11b mode

PPSD (CH Low)

Agilent

R T

Mkr1 2.411 367 6 GHz
-9.06 dBm

Ref 10 dBm

#Atten 20 dB

Peak
Log
10
dB/
Offst
0.5
dB

LgAv

M1 S2
S3 FC

$\mathcal{E}(f)$:
FTun
Swp

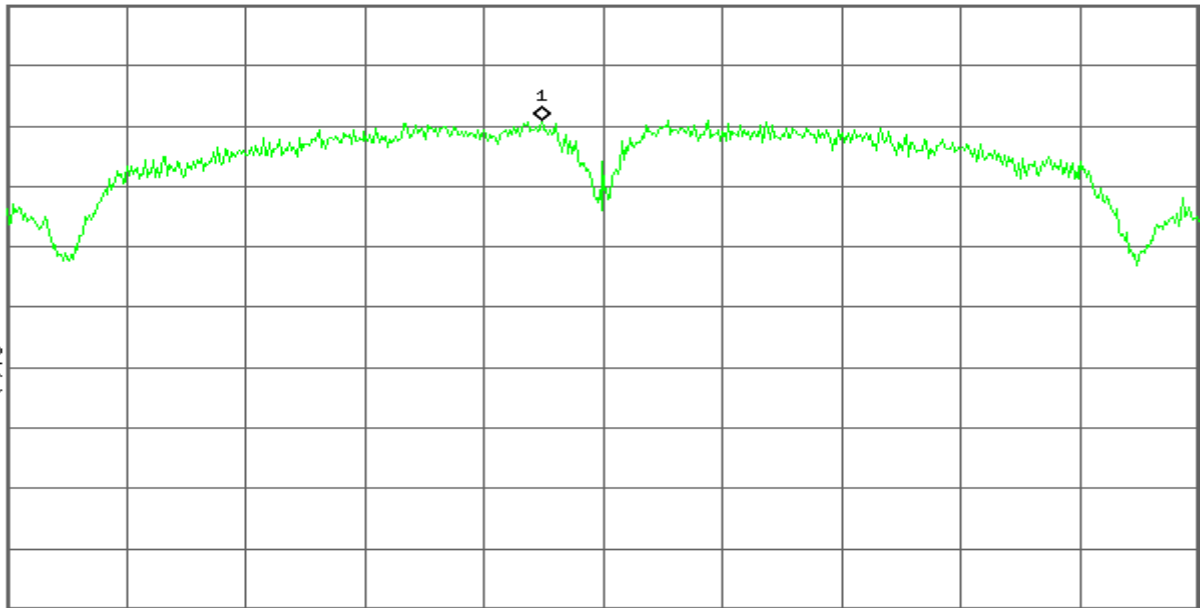

Center 2.412 000 0 GHz

#Res BW 3 kHz

#VBW 10 kHz

Span 12.24 MHz

Sweep 1.291 s (601 pts)

PPSD(CH Mid)

Agilent

R T

Mkr1 2.439 733 6 GHz
-8.66 dBm

Ref 10 dBm

#Atten 20 dB

Peak
Log
10
dB/
Offst
0.5
dB

LgAv

M1 S2
S3 FC

$\mathcal{E}(f)$:
FTun
Swp

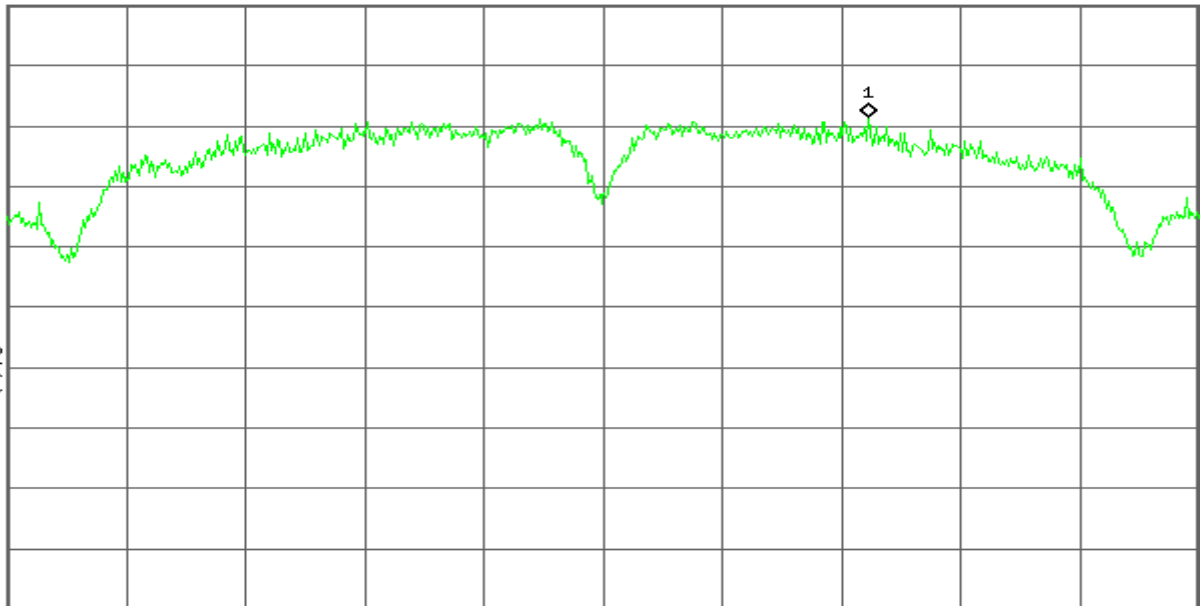

Center 2.437 000 0 GHz

#Res BW 3 kHz

#VBW 10 kHz

Span 12.24 MHz

Sweep 1.291 s (601 pts)

PPSD (CH High)

Agilent

R T

Mkr1 2.460 572 0 GHz
-8.20 dBm

Ref 10 dBm

#Atten 20 dB

Peak
Log
10
dB/
Offst
0.5
dB

LgAv

M1 S2
S3 FC

f(f):
FTun
Swp

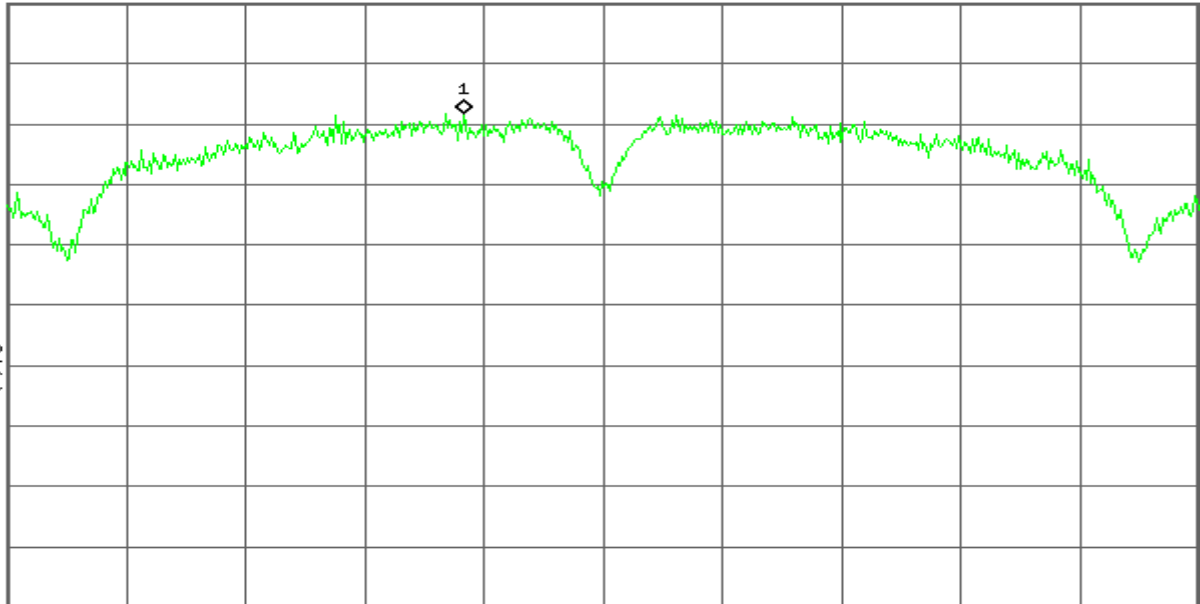

Center 2.462 000 0 GHz

#Res BW 3 kHz

#VBW 10 kHz

Span 12.24 MHz

Sweep 1.291 s (601 pts)

IEEE 802.11g mode

PPSD (CH Low)

Agilent

R T

Mkr1 2.413 85 GHz
-12.01 dBm

Ref 10 dBm

#Atten 20 dB

Peak
Log
10
dB/
Offst
0.5
dB

LgAv

M1 S2
S3 FC

f(f):
FTun
Swp

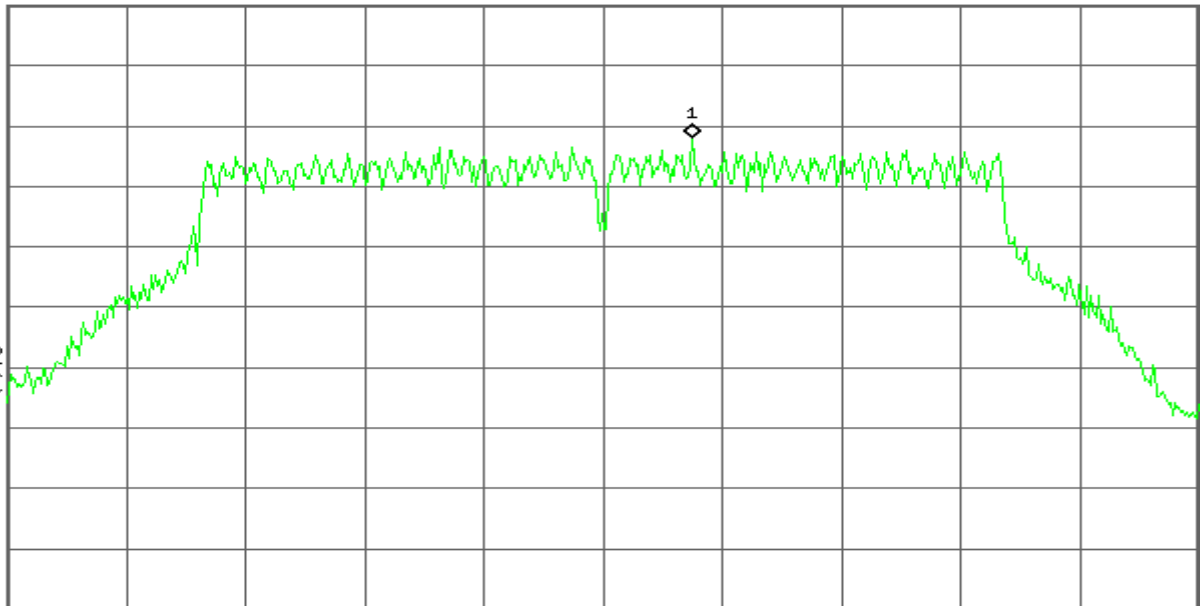

Center 2.412 00 GHz

#Res BW 3 kHz

#VBW 10 kHz

Span 24.63 MHz

Sweep 2.597 s (601 pts)

PPSD (CH Mid)

Agilent

R T

Mkr1 2.438 85 GHz
-11.96 dBm

Ref 10 dBm

#Atten 20 dB

Peak
Log
10
dB/
Offst
0.5
dB

LgAv

M1 S2
S3 FC

$\mathcal{E}(f)$:
FTun
Swp

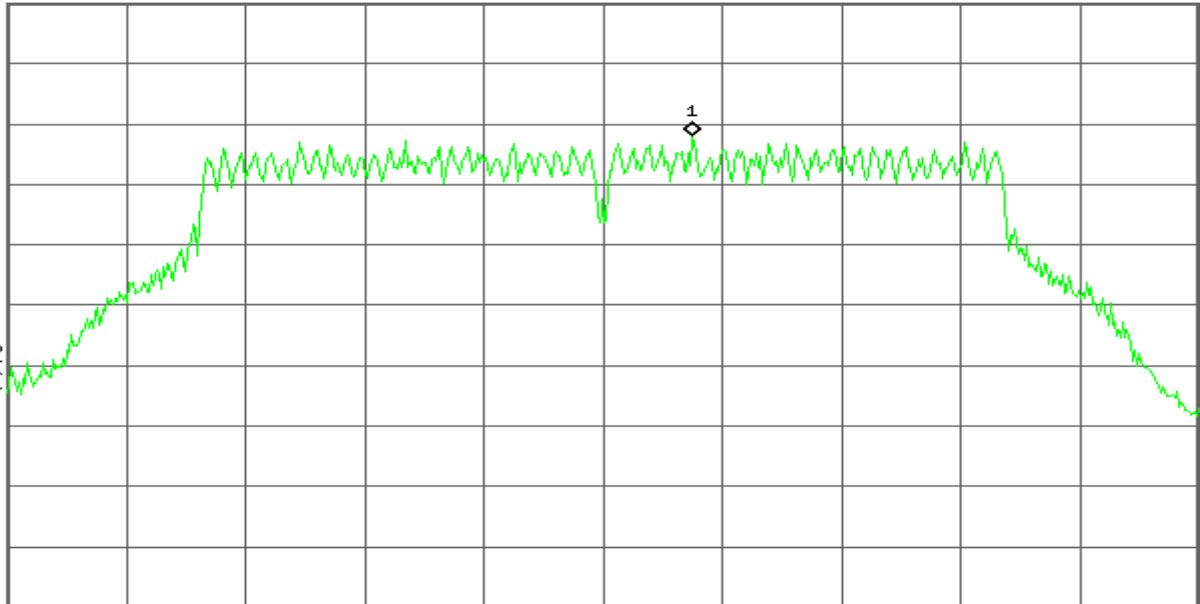

Center 2.437 00 GHz

#VBW 10 kHz

Span 24.63 MHz
Sweep 2.597 s (601 pts)

PPSD (CH High)

Agilent

R T

Mkr1 2.456 34 GHz
-11.16 dBm

Ref 10 dBm

#Atten 20 dB

Peak
Log
10
dB/
Offst
0.5
dB

LgAv

M1 S2
S3 FC

$\mathcal{E}(f)$:
FTun
Swp

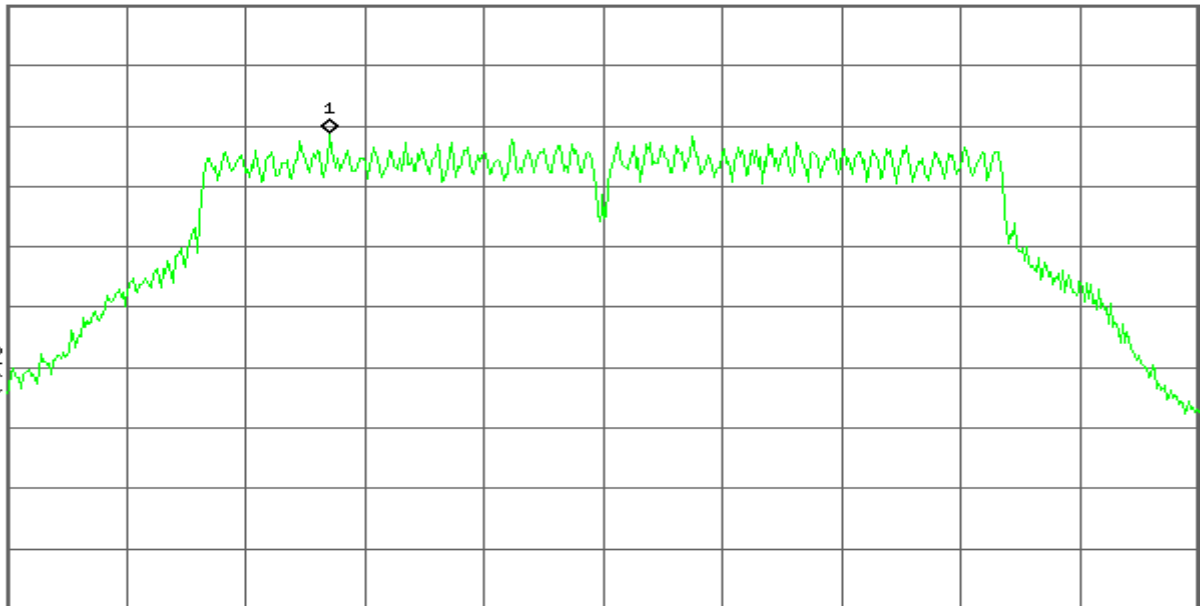

Center 2.462 00 GHz

#VBW 10 kHz

Span 24.63 MHz
Sweep 2.597 s (601 pts)

IEEE 802.11n HT20 mode

PPSD (CH Low)

Agilent

R T

Mkr1 2.407 01 GHz
-12.49 dBm

Ref 10 dBm

#Atten 20 dB

Peak
Log
10
dB/
Offst
0.5
dB

LgAv

M1 S2
S3 FC

$\mathcal{E}(f)$:
FTun
Swp

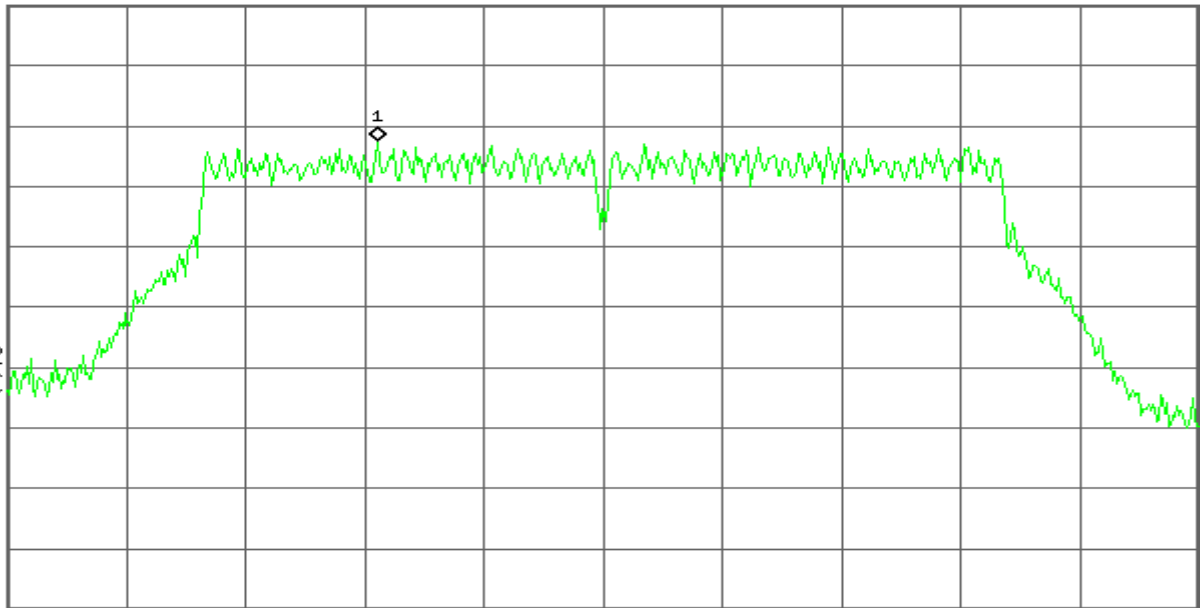

Center 2.412 00 GHz

#Res BW 3 kHz

#VBW 10 kHz

Span 26.5 MHz

Sweep 2.794 s (601 pts)

PPSD (CH Mid)

Agilent

R T

Mkr1 2.443 01 GHz
-12.12 dBm

Ref 10 dBm

#Atten 20 dB

Peak
Log
10
dB/
Offst
0.5
dB

LgAv

M1 S2
S3 FC

$\mathcal{E}(f)$:
FTun
Swp

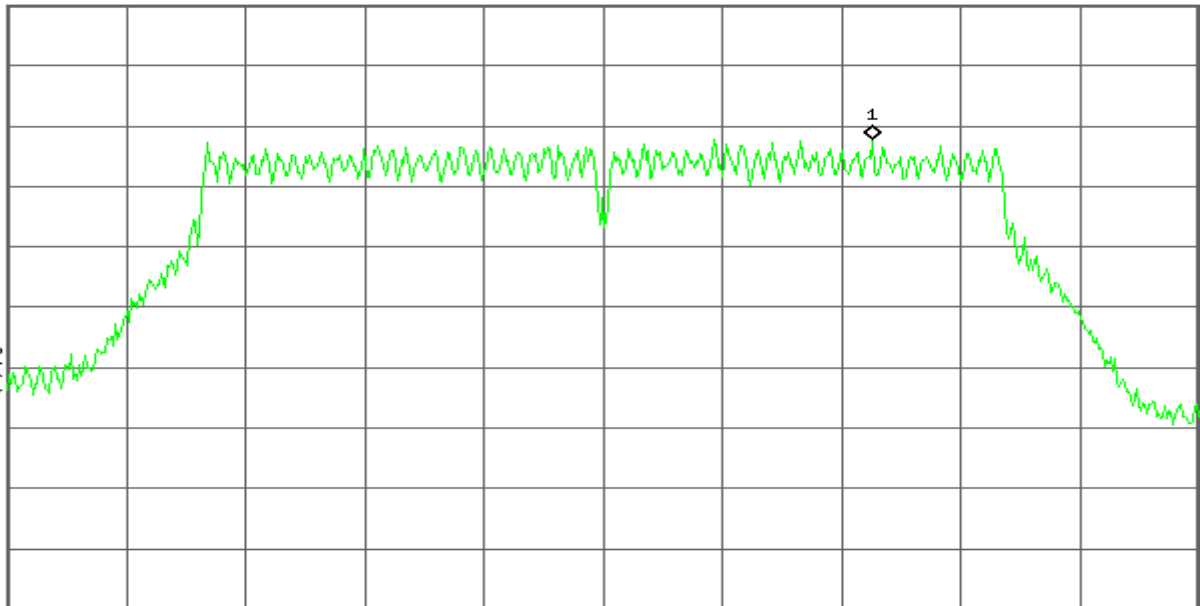

Center 2.437 00 GHz

#Res BW 3 kHz

#VBW 10 kHz

Span 26.5 MHz

Sweep 2.794 s (601 pts)

PPSD (CH High)

Agilent

R T

Mkr1 2.459 17 GHz
-11.59 dBm

Ref 10 dBm

#Atten 20 dB

Peak

Log

10

dB/

Offst

0.5

dB

LgAv

M1 S2

S3 FC

$\mathcal{E}(f)$:

FTun

Swp

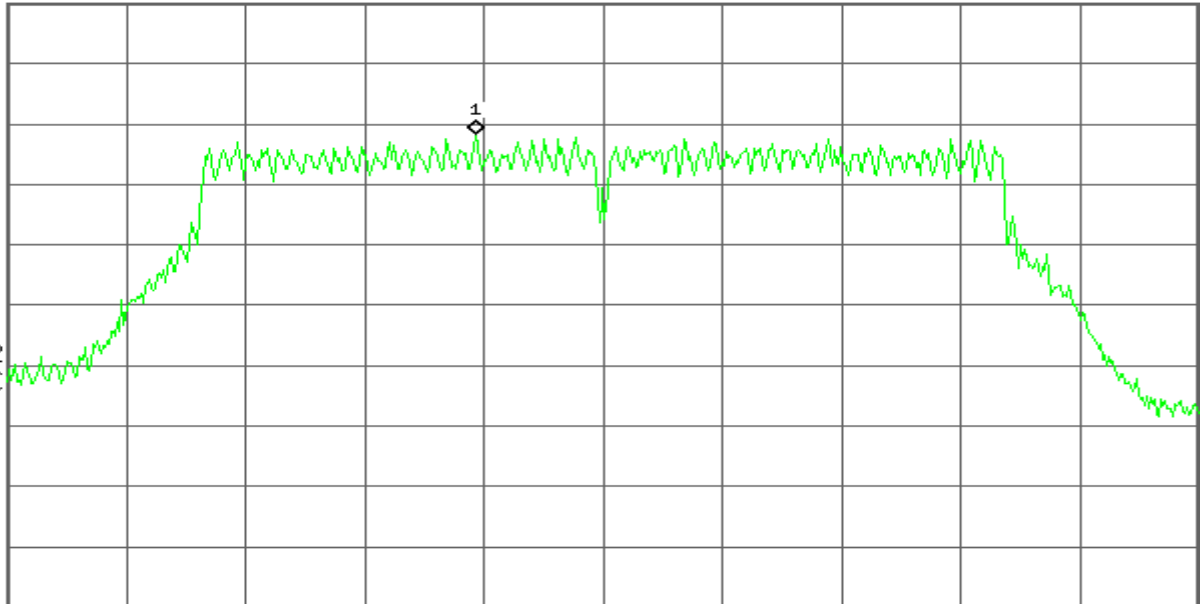

Center 2.462 00 GHz

#Res BW 3 kHz

#VBW 10 kHz

Span 26.5 MHz

Sweep 2.794 s (601 pts)

7.4.SPURIOUS EMISSIONS

Conducted Measurement

LIMIT

According to §15.247(d), in any 100 kHz bandwidth outside the frequency bands in which the spread spectrum intentional radiator is operating, the radio frequency power that is produced by the intentional radiator shall be at least 20 dB below that in the 100 kHz bandwidth within the band that contains the highest level of the desired power, based on either an RF conducted or a radiated measurement, provided the transmitter demonstrates compliance with the peak conducted power limits. In addition, radiated emissions which fall in the restricted bands, as defined in §15.205(a), must also comply with the radiated emission limits specified in 15.209(a) (see Section 15.205(c)).

Test Configuration

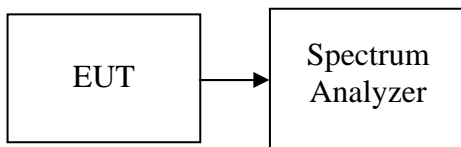

TEST PROCEDURE

Conducted RF measurements of the transmitter output were made to confirm that the EUT antenna port conducted emissions meet the specified limit and to identify any spurious signals that require further investigation or measurements on the radiated emissions site.

The transmitter output is connected to the spectrum analyzer. The resolution bandwidth is set to 100 kHz. The video bandwidth is set to 300 kHz.

Measurements are made over the 30MHz to 40GHz range with the transmitter set to the lowest, middle, and highest channels.

TEST RESULTS

No non-compliance noted

Test Plot

OUT-OF-BAND SPURIOUS EMISSIONS-CONDUCTED MEASUREMENT

IEEE 802.11b mode

CH Low

Agilent

R T

Mkr1 2.413 489 2 GHz
5.80 dBm

Ref 20 dBm

#Atten 30 dB

Peak
Log
10
dB/
Offst
0.5
dB
DI
-14.2
dBm
LgAv

M1 S2
S3 FC

f(f):
FTun
Swp

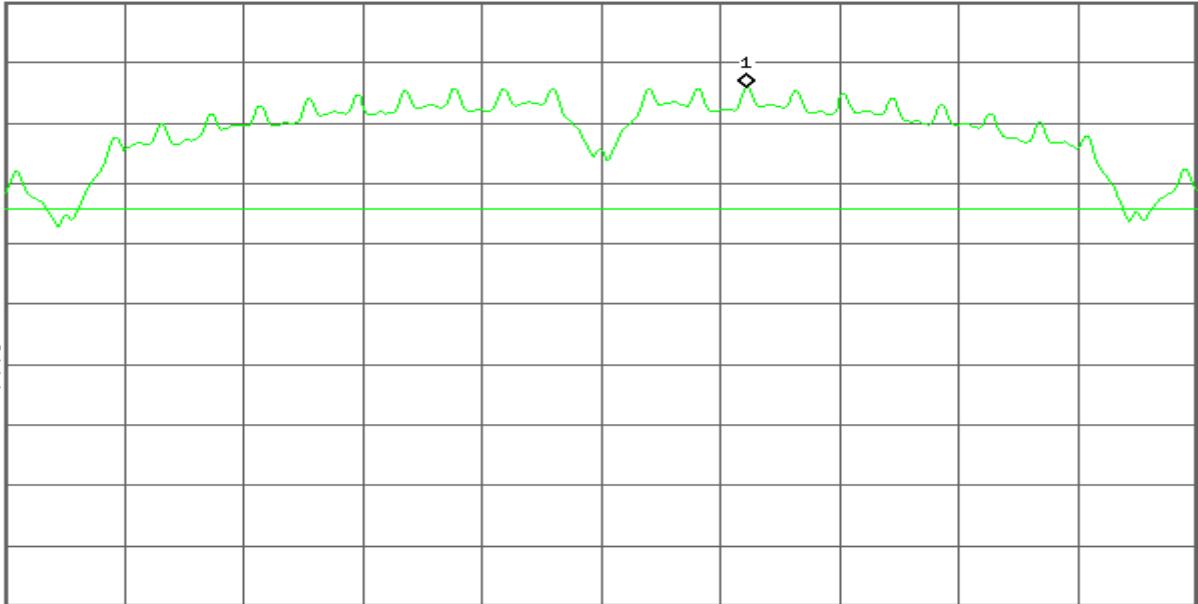

Center 2.412 000 0 GHz

#Res BW 100 kHz

#VBW 300 kHz

Span 12.24 MHz

Sweep 1.2 ms (601 pts)

Agilent

R T

Mkr1 2.400 000 GHz
-38.22 dBm

Ref 20 dBm

#Atten 30 dB

Peak
Log
10
dB/
Offst
0.5
dB
DI
-14.2
dBm
LgAv

M1 S2
S3 FC

f(f):
FTun
Swp

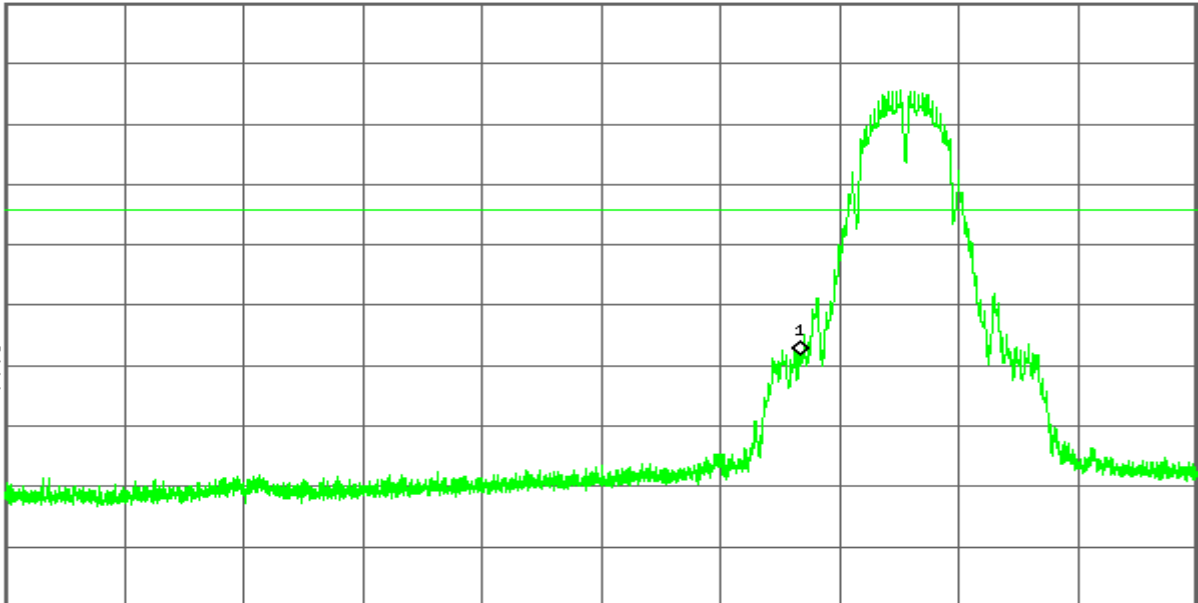

Start 2.310 000 GHz

#Res BW 100 kHz

#VBW 300 kHz

Stop 2.445 000 GHz

Sweep 13.11 ms (8192 pts)

Agilent

R T

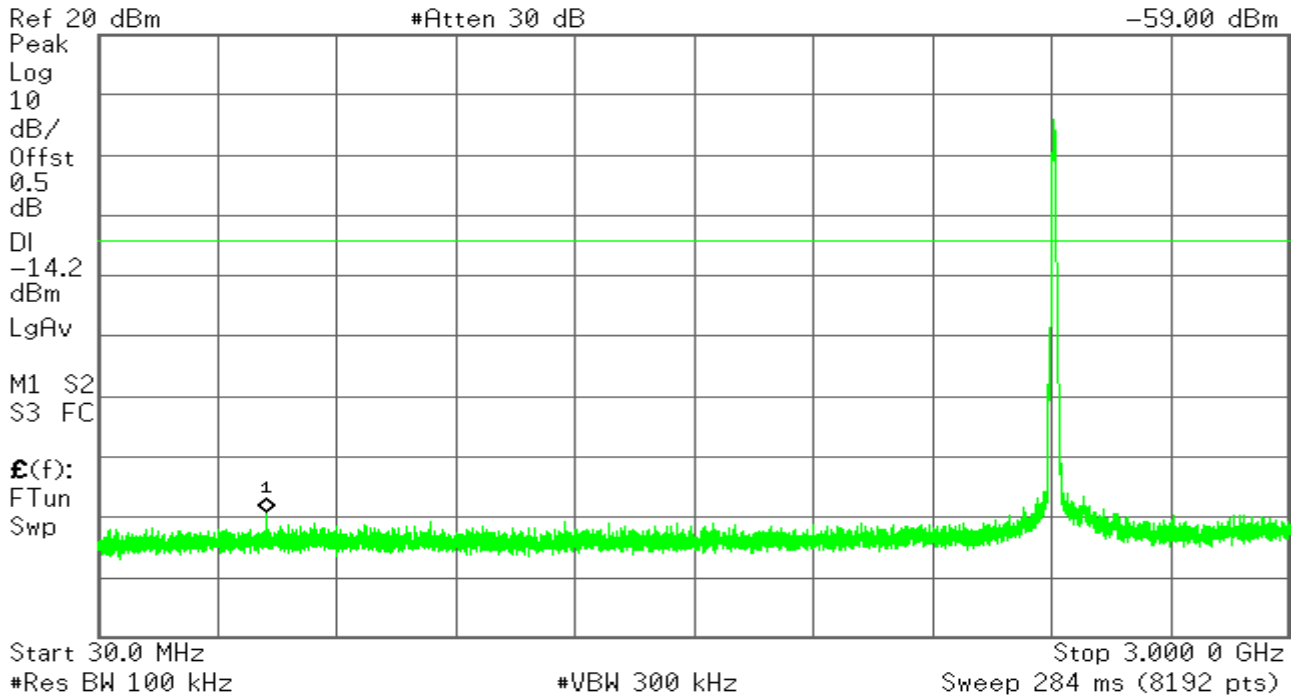

Agilent

R T

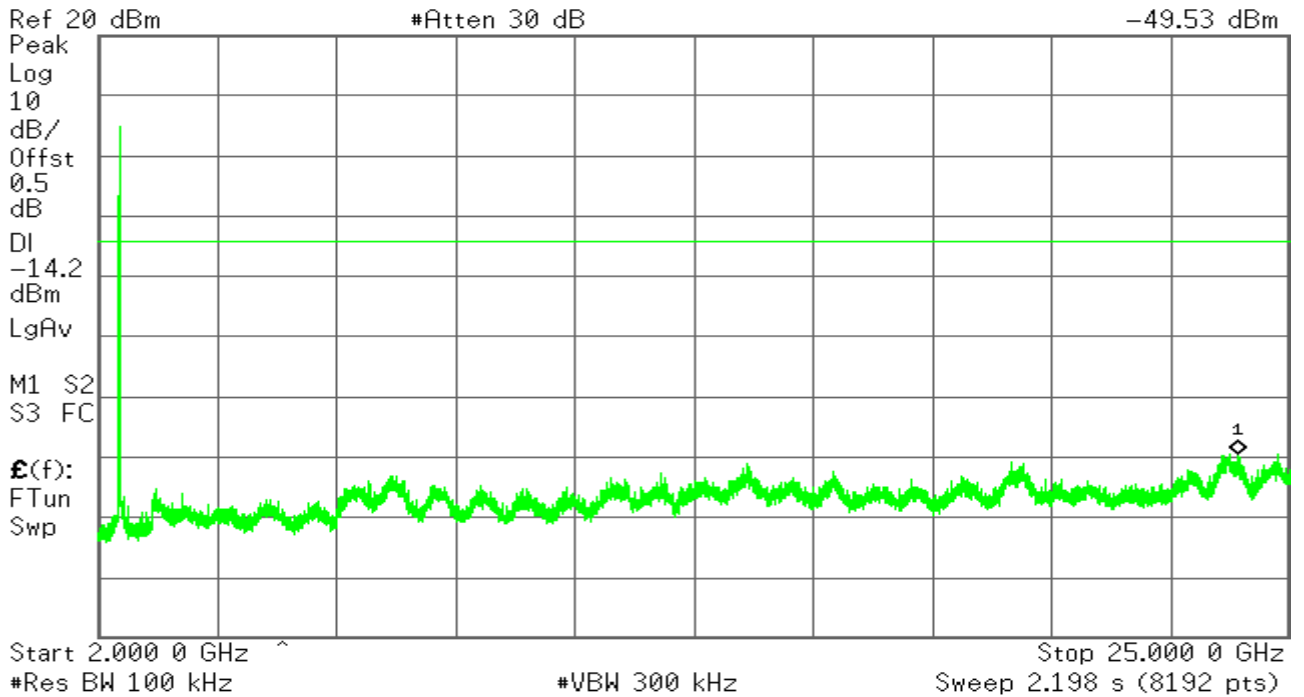

CH Mid

Agilent

R T

Mkr1 2.437 999 6 GHz
5.97 dBm

Ref 20 dBm

#Atten 30 dB

Peak

Log

10

dB/

Offst

0.5

dB

DI

-14.0

dBm

LgAv

M1 S2

S3 FC

$\mathcal{E}(f)$:

FTun

Swp

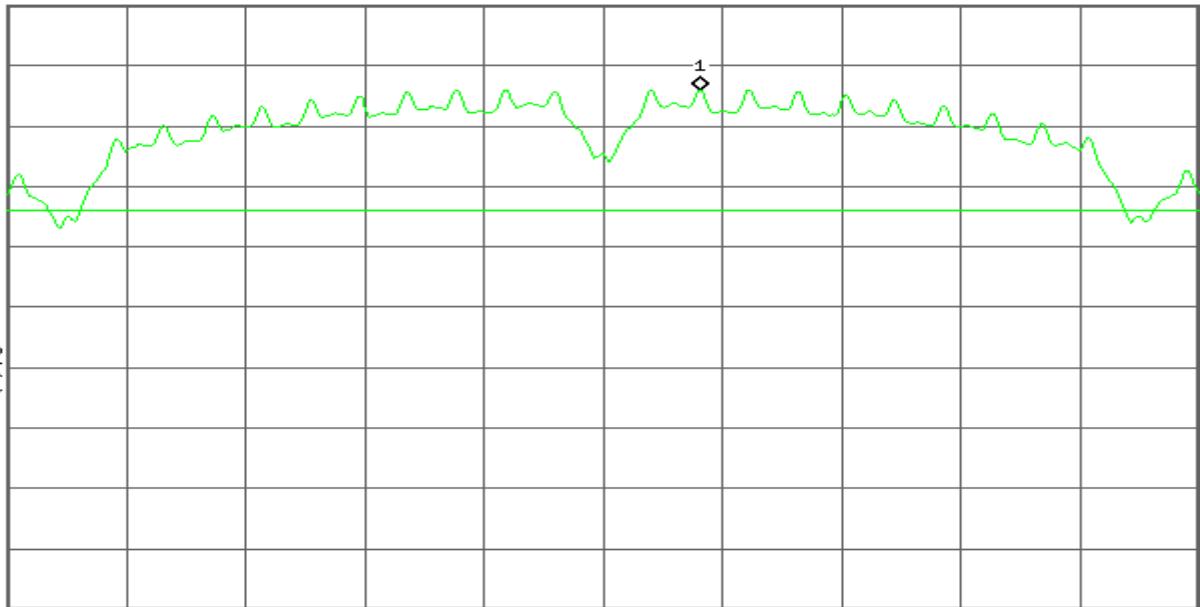

Center 2.437 000 0 GHz

Span 12.24 MHz

#Res BW 100 kHz

#VBW 300 kHz

Sweep 1.2 ms (601 pts)

Agilent

R T

Mkr1 476.4 MHz
-59.64 dBm

Ref 20 dBm

#Atten 30 dB

Peak

Log

10

dB/

Offst

0.5

dB

DI

-14.0

dBm

LgAv

M1 S2

S3 FC

$\mathcal{E}(f)$:

FTun

Swp

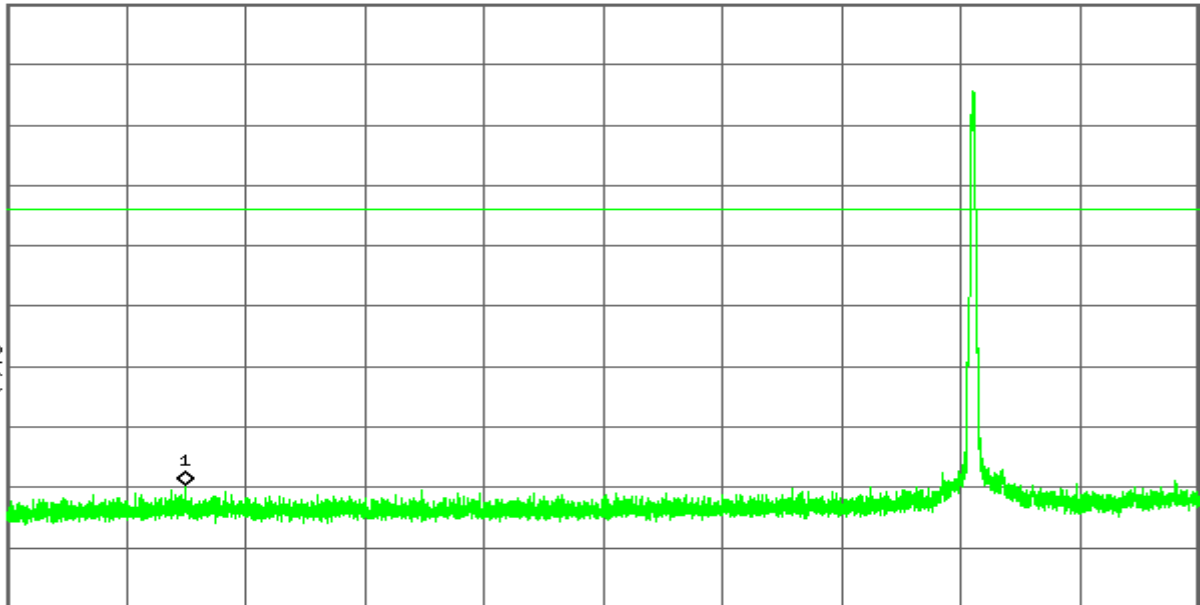

Start 30.00 MHz

Stop 3.000 00 GHz

#Res BW 100 kHz

#VBW 300 kHz

Sweep 284 ms (8192 pts)

Agilent

R T

Mkr1 23.747 6 GHz
-49.06 dBm

Ref 20 dBm

#Atten 30 dB

Peak

Log

10

dB/

Offst

0.5

dB

DI

-14.0

dBm

LgAv

M1 S2

S3 FC

$\mathcal{E}(f)$:

FTun

Swp

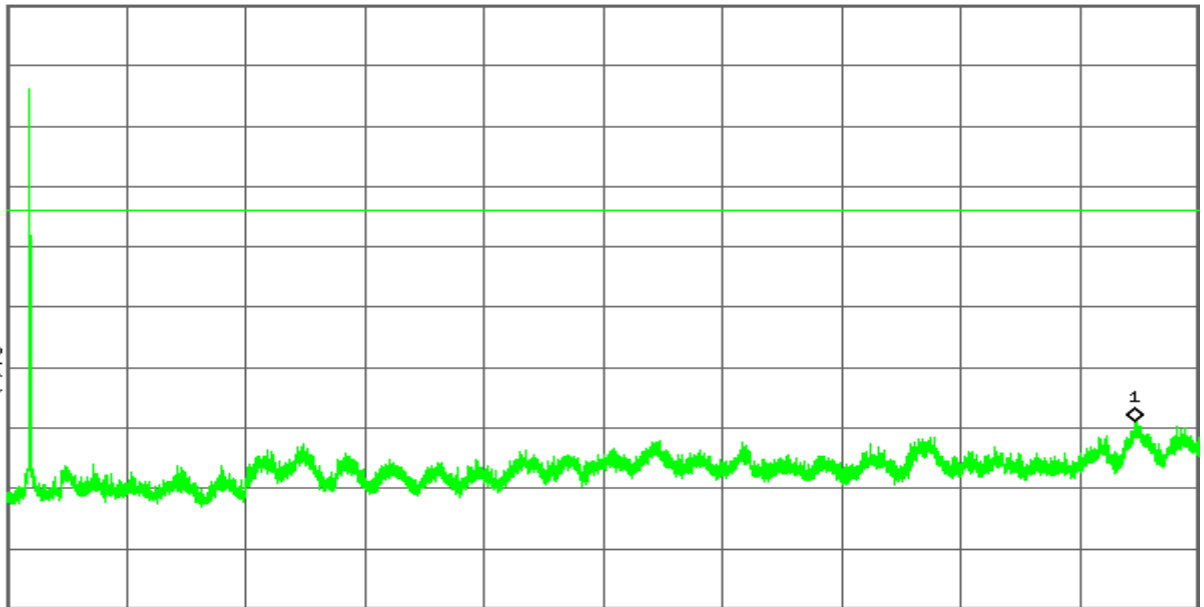

Start 2.000 0 GHz

#Res BW 100 kHz

#VBW 300 kHz

Stop 25.000 0 GHz

Sweep 2.198 s (8192 pts)

CH High

Agilent

R T

Mkr1 2.460 510 8 GHz
6.11 dBm

Ref 20 dBm

#Atten 30 dB

Peak

Log

10

dB/

Offst

0.5

dB

DI

-13.9

dBm

LgAv

M1 S2

S3 FC

$\mathcal{E}(f)$:

FTun

Swp

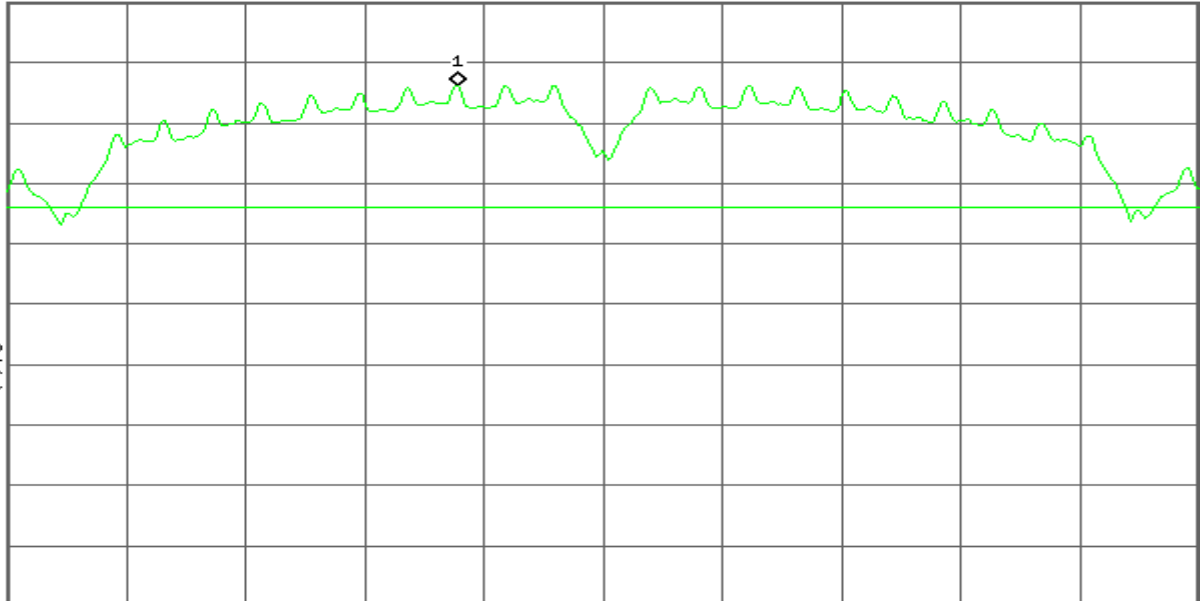

Center 2.462 000 0 GHz

#Res BW 100 kHz

#VBW 300 kHz

Span 12.24 MHz

Sweep 1.2 ms (601 pts)

Agilent

R T

Mkr1 2.483 500 GHz
-53.26 dBm

Ref 20 dBm

#Atten 30 dB

Peak

Log

10

dB/

Offst

0.5

dB

DI

-13.9

dBm

LgAv

M1 S2

S3 FC

$\mathcal{E}(f)$:

FTun

Swp

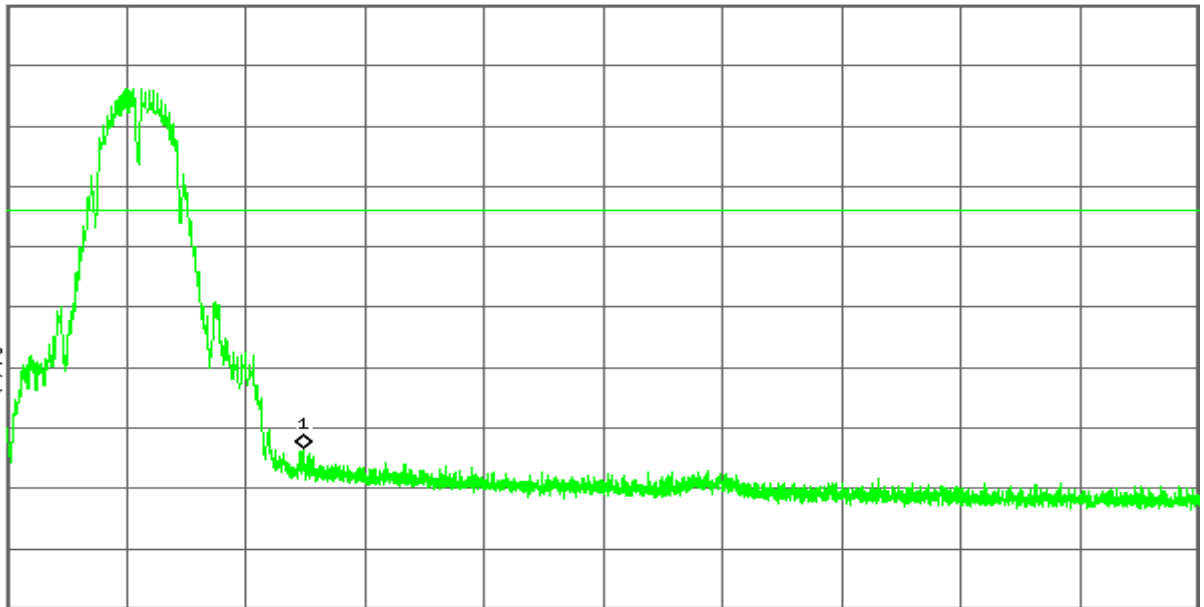

Start 2.445 00 GHz

Stop 2.600 00 GHz

#Res BW 100 kHz

#VBW 300 kHz

Sweep 15.29 ms (8192 pts)

Agilent

R T

Mkr1 1.635 9 GHz
-60.17 dBm

Ref 20 dBm

#Atten 30 dB

Peak

Log

10

dB/

Offst

0.5

dB

DI

-13.9

dBm

LgAv

M1 S2

S3 FC

$\mathcal{E}(f)$:

FTun

Swp

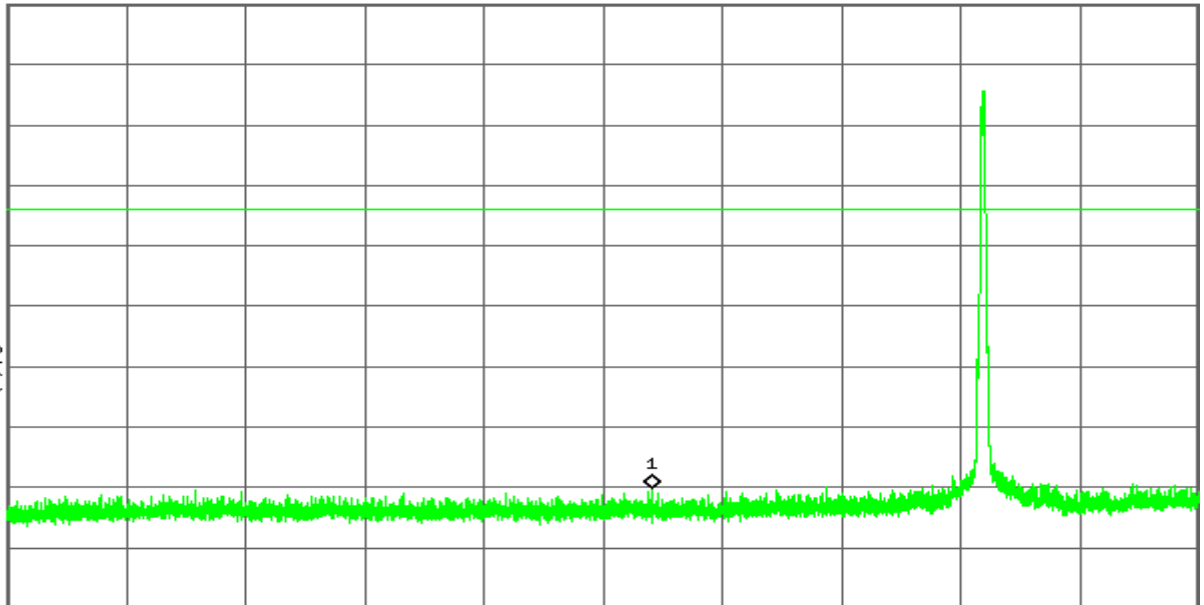

Center 1.515 0 GHz

Span 2.97 GHz

#Res BW 100 kHz

#VBW 300 kHz

Sweep 284 ms (8192 pts)

Agilent

R T

Mkr1 23.815 0 GHz
-49.19 dBm

Ref 20 dBm

#Atten 30 dB

Peak
Log
10
dB/
Offst
0.5
dB
DI
-13.9
dBm
LgAv

M1 S2
S3 FC

$\mathcal{E}(f)$:
FTun
Swp

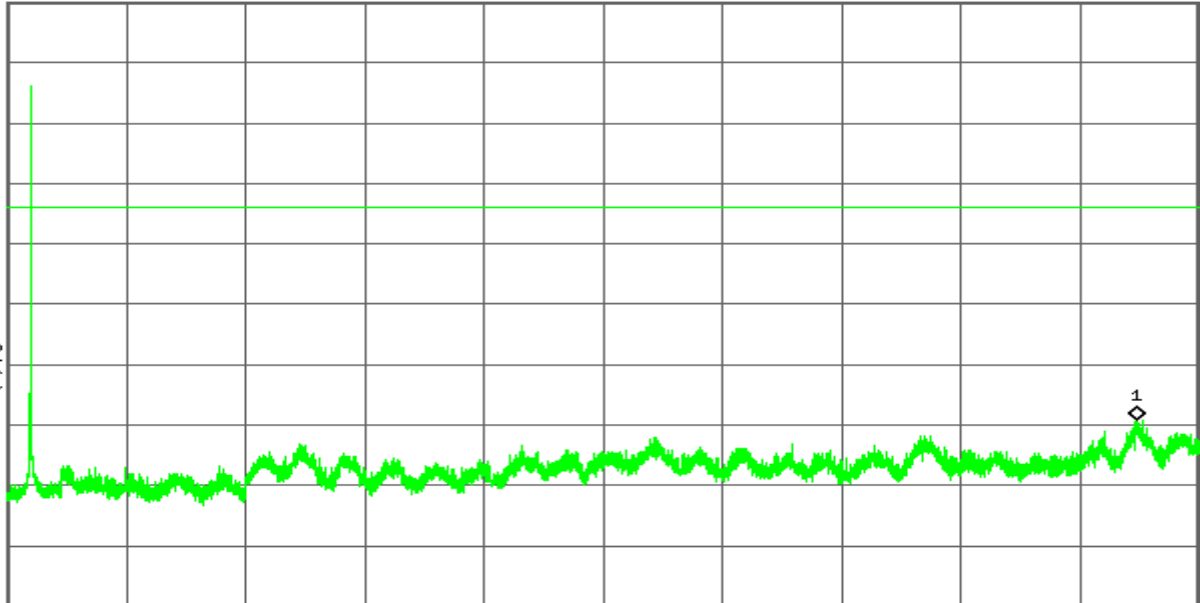

Start 2.000 0 GHz
#Res BW 100 kHz

#VBW 300 kHz

Stop 25.000 0 GHz
Sweep 2.198 s (8192 pts)

IEEE 802.11g mode

CH Low

Agilent

R T

Mkr1 2.413 27 GHz
1.89 dBm

Ref 20 dBm

#Atten 30 dB

Peak
Log
10
dB/
Offst
0.5
dB
DI
-18.1
dBm
LgAv

M1 S2
S3 FC

$\mathcal{E}(f)$:
FTun
Swp

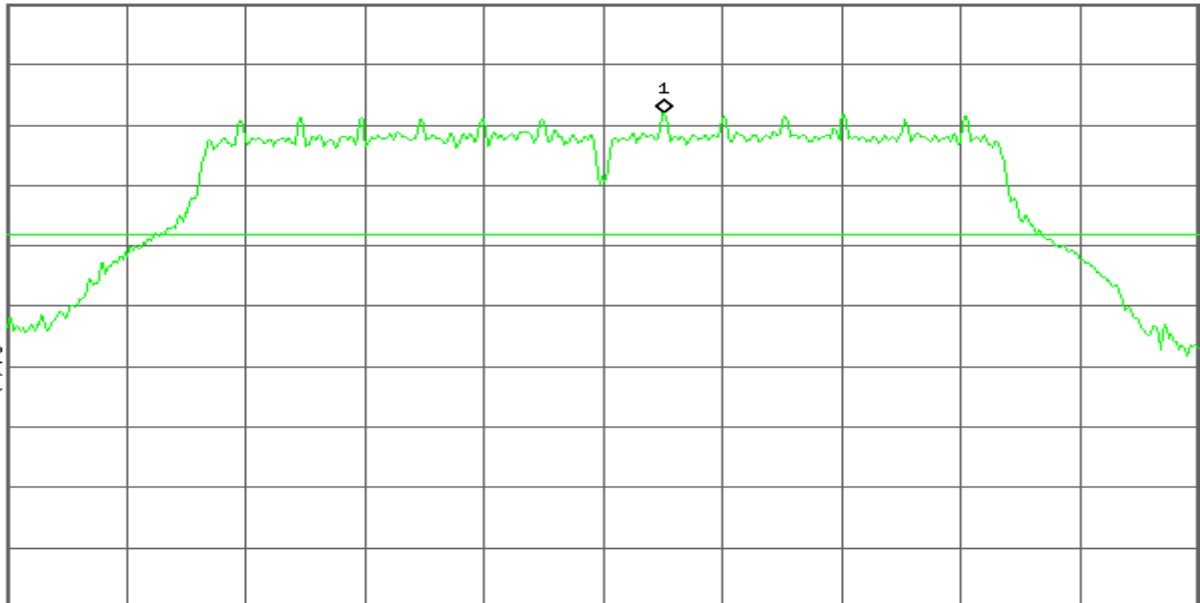

Center 2.412 000 GHz
#Res BW 100 kHz

#VBW 300 kHz

Span 24.63 MHz
Sweep 2.36 ms (601 pts)

Agilent

R T

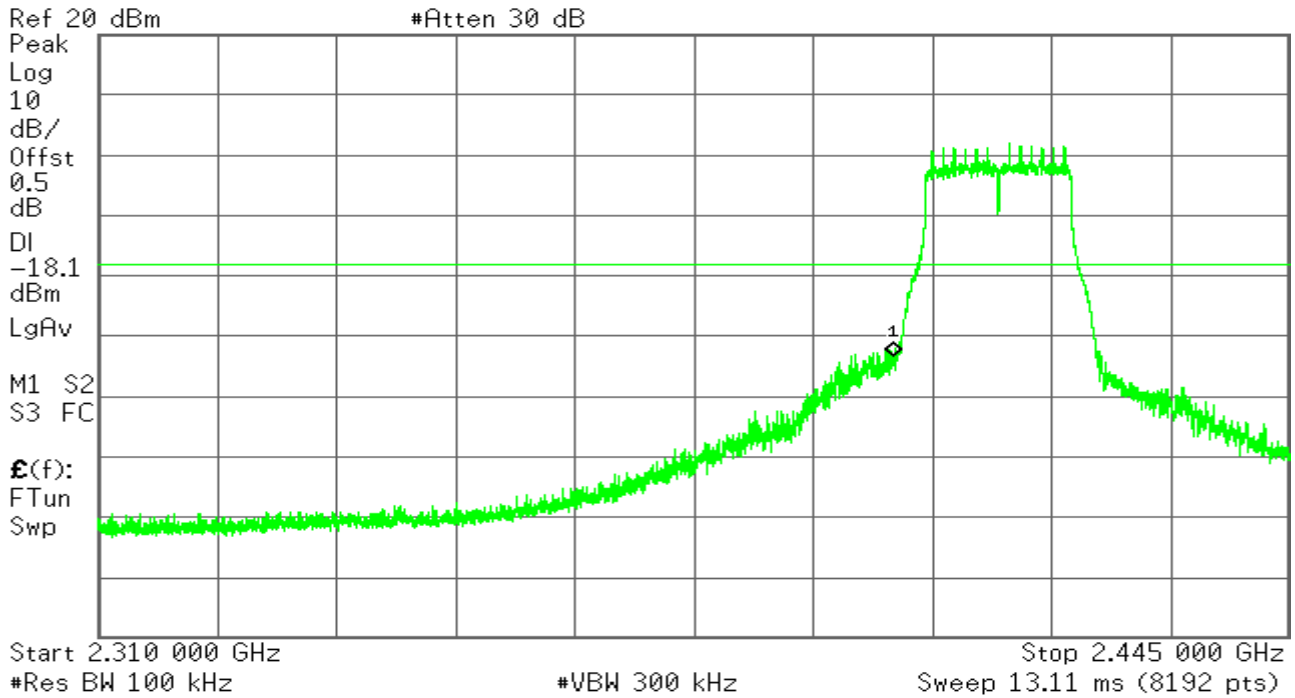

Agilent

R T

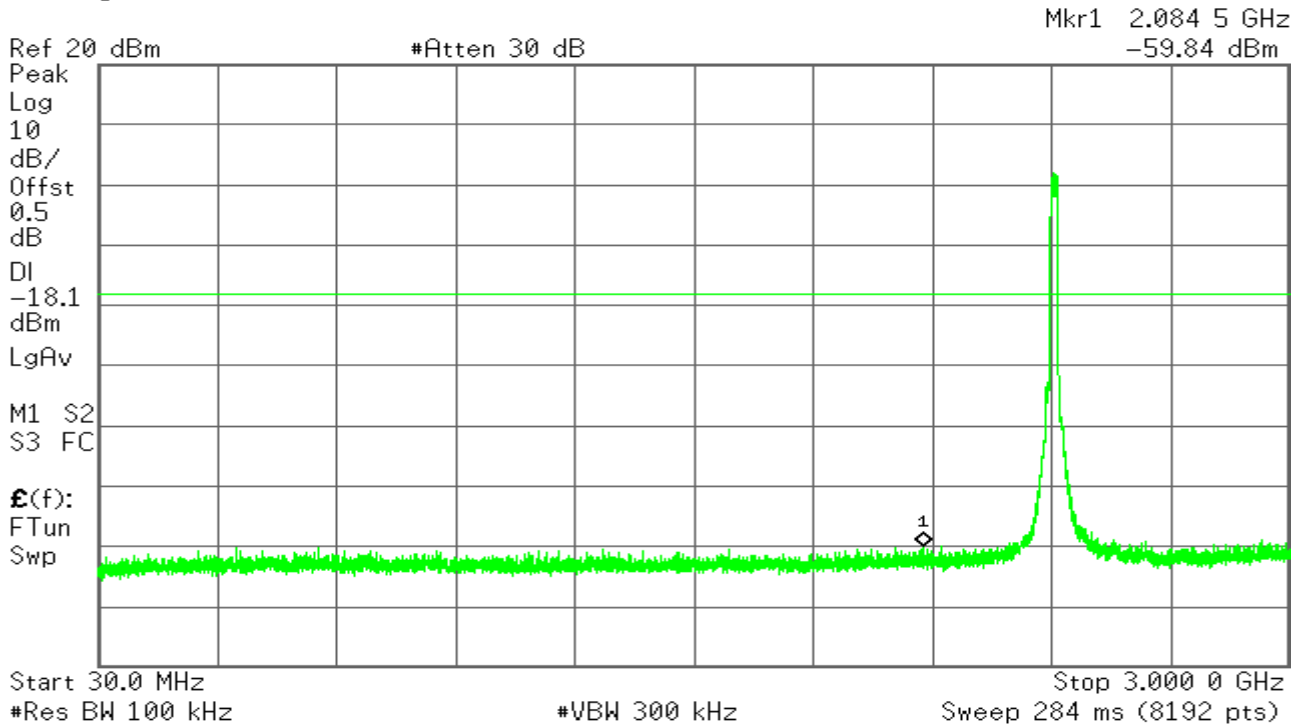

Agilent

R T

Mkr1 23.798 2 GHz
-49.51 dBm

Ref 20 dBm

#Atten 30 dB

Peak
Log
10
dB/
Offst
0.5
dB
DI
-18.1
dBm
LgAv

M1 S2
S3 FC

$\mathcal{E}(f)$:
FTun
Swp

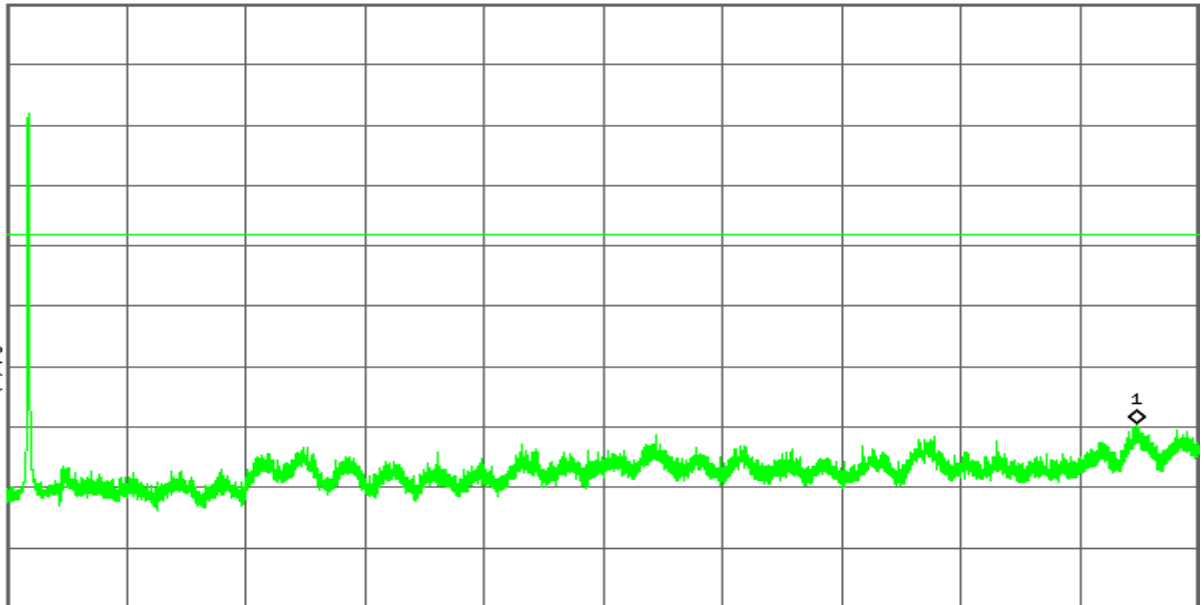

Start 2.000 0 GHz
#Res BW 100 kHz

#VBW 300 kHz

Stop 25.000 0 GHz
Sweep 2.198 s (8192 pts)

CH Mid

Agilent

R T

Mkr1 2.438 27 GHz
1.92 dBm

Ref 20 dBm

#Atten 30 dB

Peak
Log
10
dB/
Offst
0.5
dB
DI
-18.1
dBm
LgAv

M1 S2
S3 FC

$\mathcal{E}(f)$:
FTun
Swp

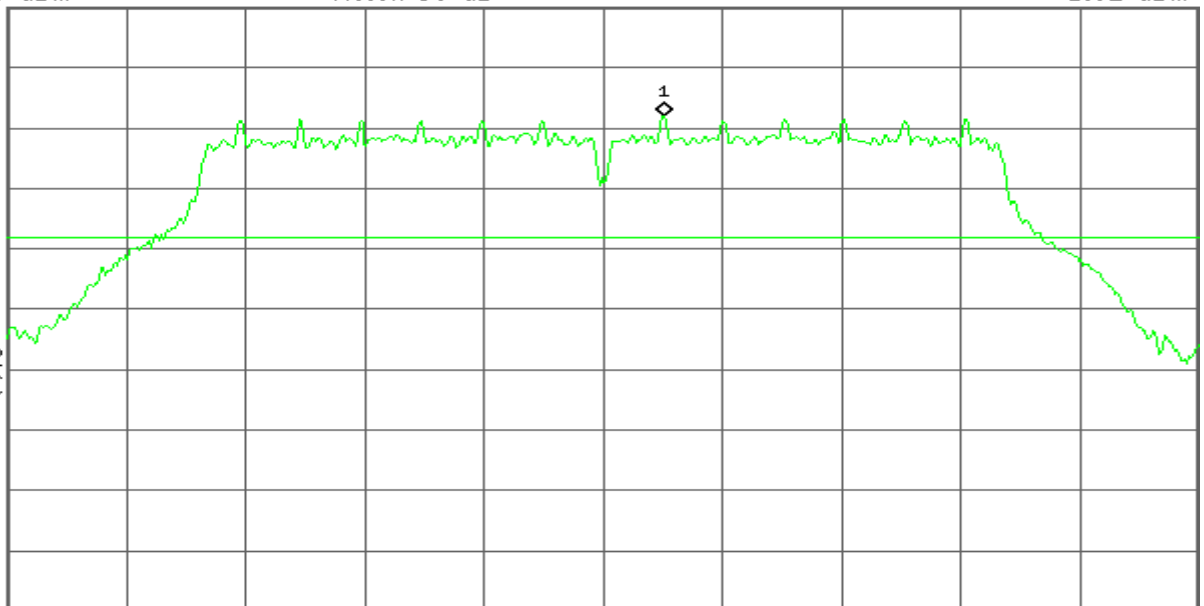

Center 2.437 000 GHz
#Res BW 100 kHz

#VBW 300 kHz

Span 24.63 MHz
Sweep 2.36 ms (601 pts)

Agilent

R T

Mkr1 1.755 2 GHz
-59.22 dBm

Ref 20 dBm

#Atten 30 dB

Peak
Log
10
dB/
Offst
0.5
dB
DI
-18.1
dBm
LgAv

M1 S2
S3 FC

$\mathcal{E}(f)$:
FTun
Swp

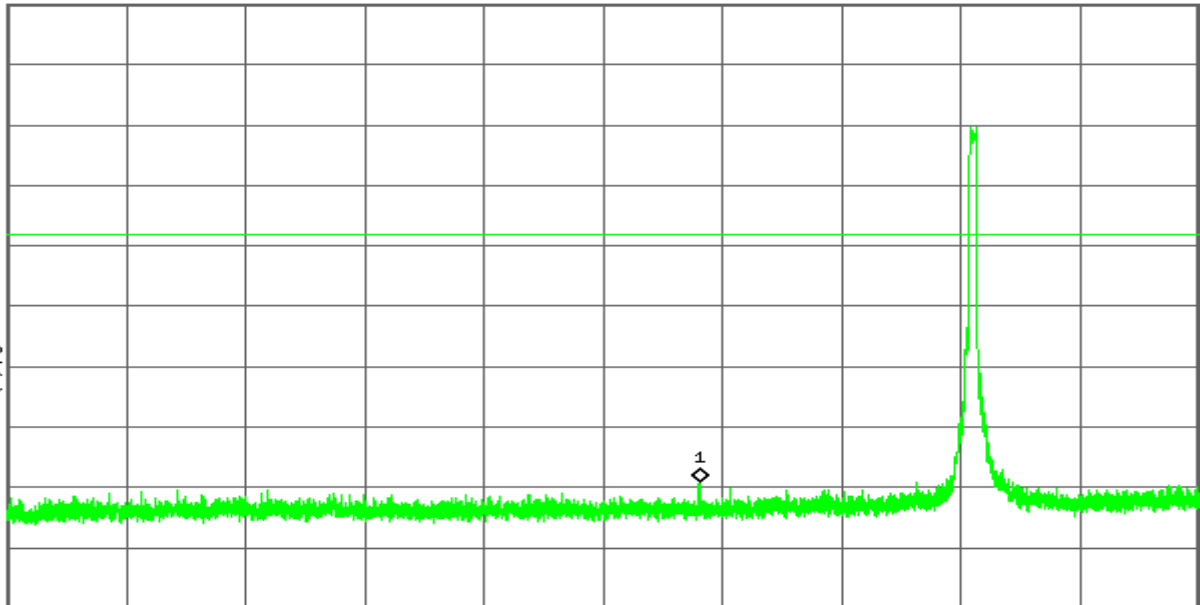

Start 30.00 MHz
#Res BW 100 kHz

#VBW 300 kHz

Stop 3.000 00 GHz
Sweep 284 ms (8192 pts)

Agilent

R T

Mkr1 23.803 8 GHz
-48.45 dBm

Ref 20 dBm

#Atten 30 dB

Peak
Log
10
dB/
Offst
0.5
dB
DI
-18.1
dBm
LgAv

M1 S2
S3 FC

$\mathcal{E}(f)$:
FTun
Swp

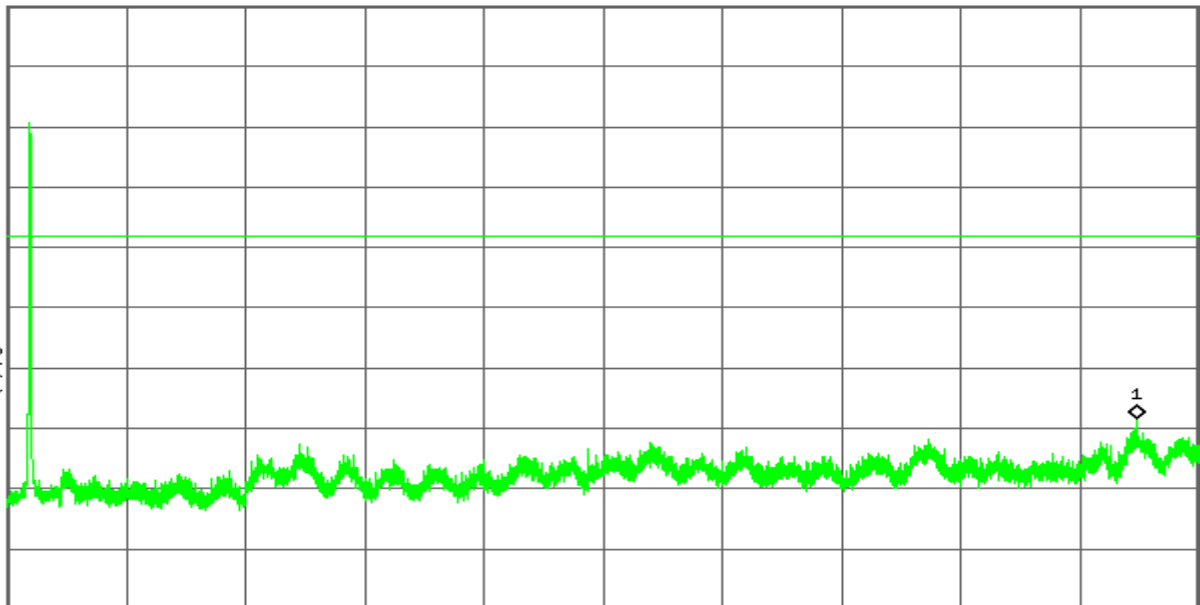

Start 2.000 0 GHz
#Res BW 100 kHz

#VBW 300 kHz

Stop 25.000 0 GHz
Sweep 2.198 s (8192 pts)

CH High

Agilent

R T

Mkr1 2.463 23 GHz
2.30 dBm

Ref 20 dBm

#Atten 30 dB

Peak

Log

10

dB/

Offst

0.5

dB

DI

-17.7

dBm

LgAv

M1 S2

S3 FC

£(f):

FTun

Swp

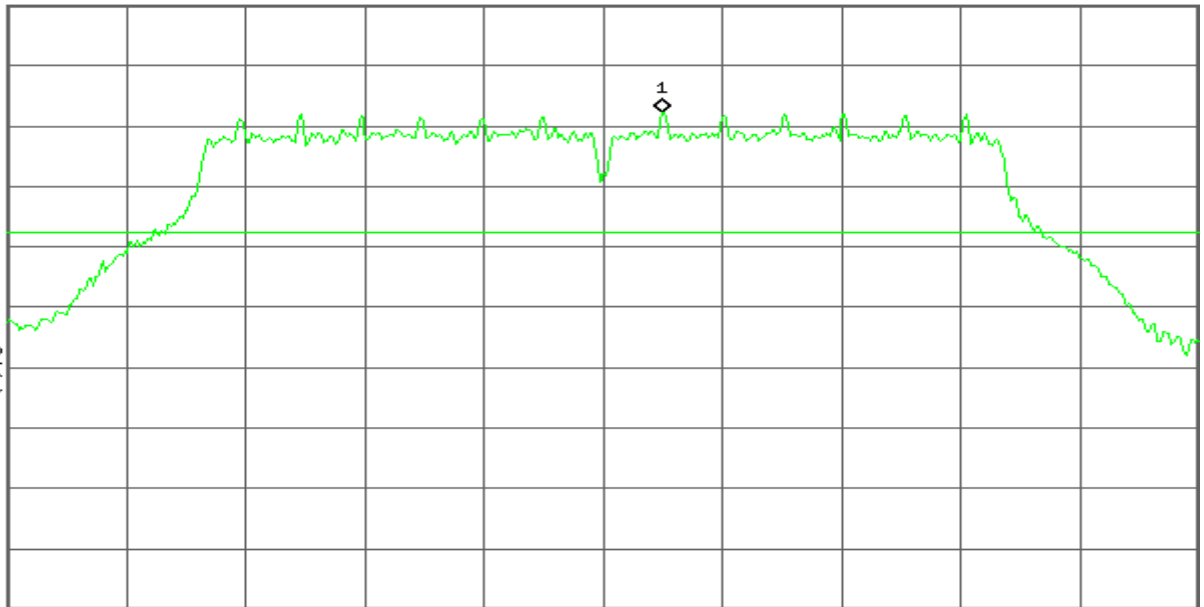

Center 2.462 000 GHz

#Res BW 100 kHz

#VBW 300 kHz

Span 24.63 MHz

Sweep 2.36 ms (601 pts)

Agilent

R T

Mkr1 2.483 500 GHz
-43.02 dBm

Ref 20 dBm

#Atten 30 dB

Peak

Log

10

dB/

Offst

0.5

dB

DI

-17.7

dBm

LgAv

M1 S2

S3 FC

£(f):

FTun

Swp

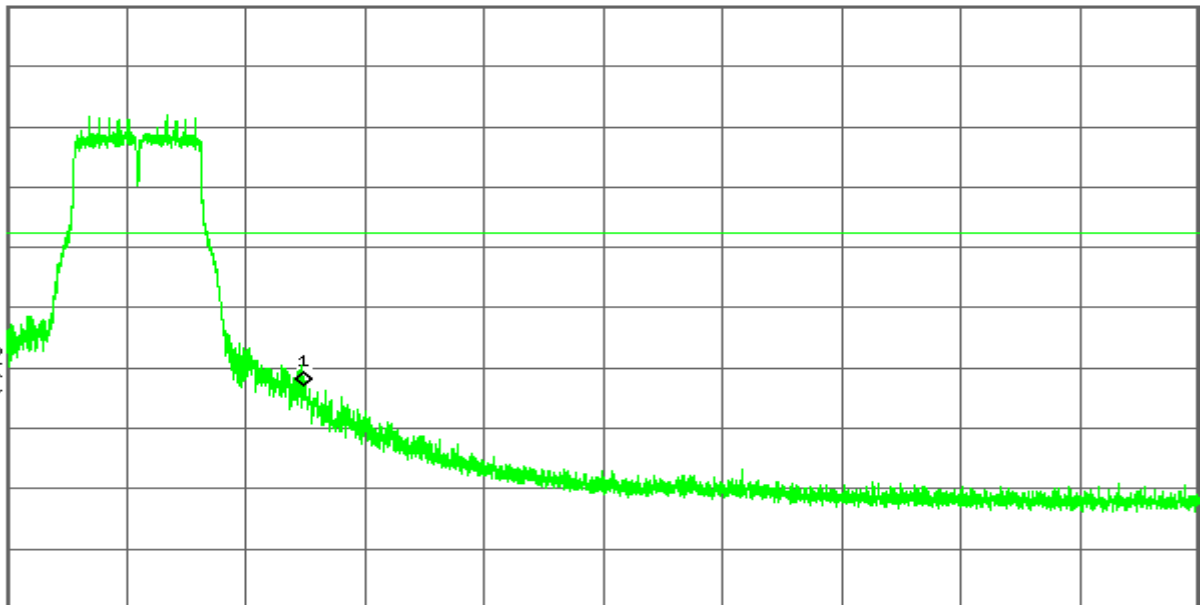

Start 2.445 00 GHz

#Res BW 100 kHz

#VBW 300 kHz

Stop 2.600 00 GHz

Sweep 15.29 ms (8192 pts)

Agilent

R T

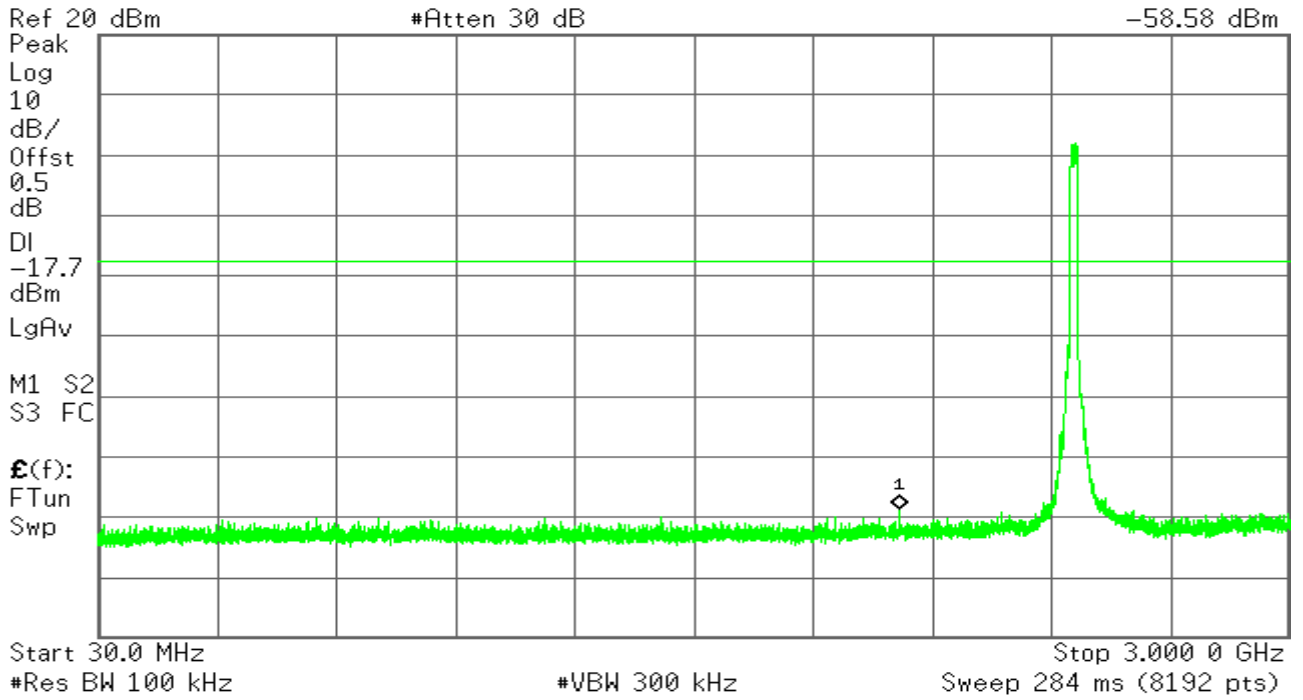

Agilent

R T

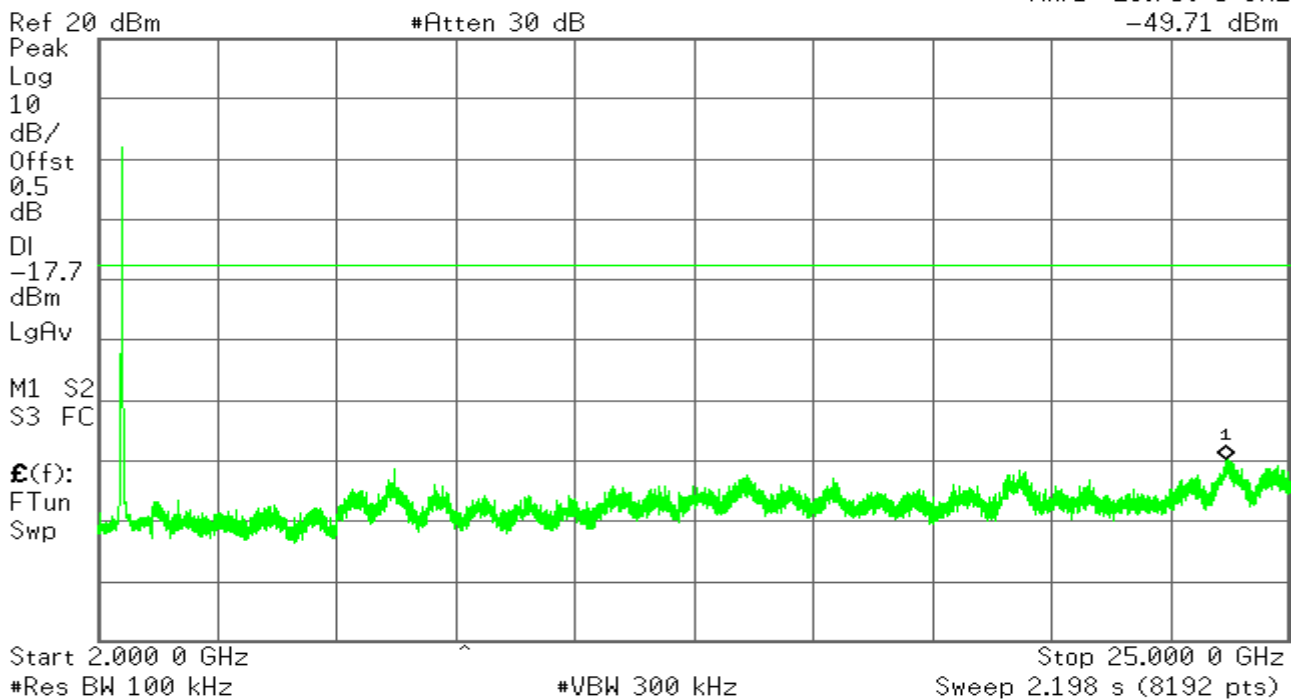

IEEE 802.11n HT20 mode

CH Low

Agilent

R T

Mkr1 2.413 28 GHz
1.83 dBm

Ref 20 dBm

#Atten 30 dB

Peak

Log

10

dB/

Offst

0.5

dB

DI

-18.2

dBm

LgAv

M1 S2

S3 FC

f(f):

FTun

Swp

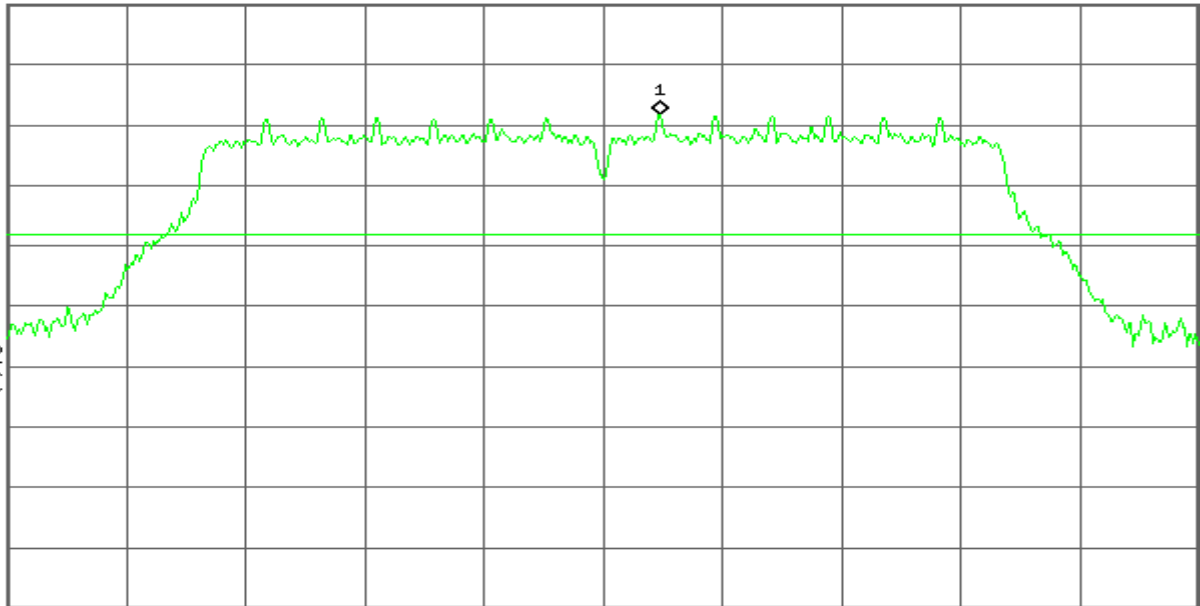

Center 2.412 000 GHz

#Res BW 100 kHz

#VBW 300 kHz

Span 26.5 MHz

Sweep 2.56 ms (601 pts)

Agilent

R T

Mkr1 2.400 000 GHz
-33.83 dBm

Ref 20 dBm

#Atten 30 dB

Peak

Log

10

dB/

Offst

0.5

dB

DI

-18.2

dBm

LgAv

M1 S2

S3 FC

f(f):

FTun

Swp

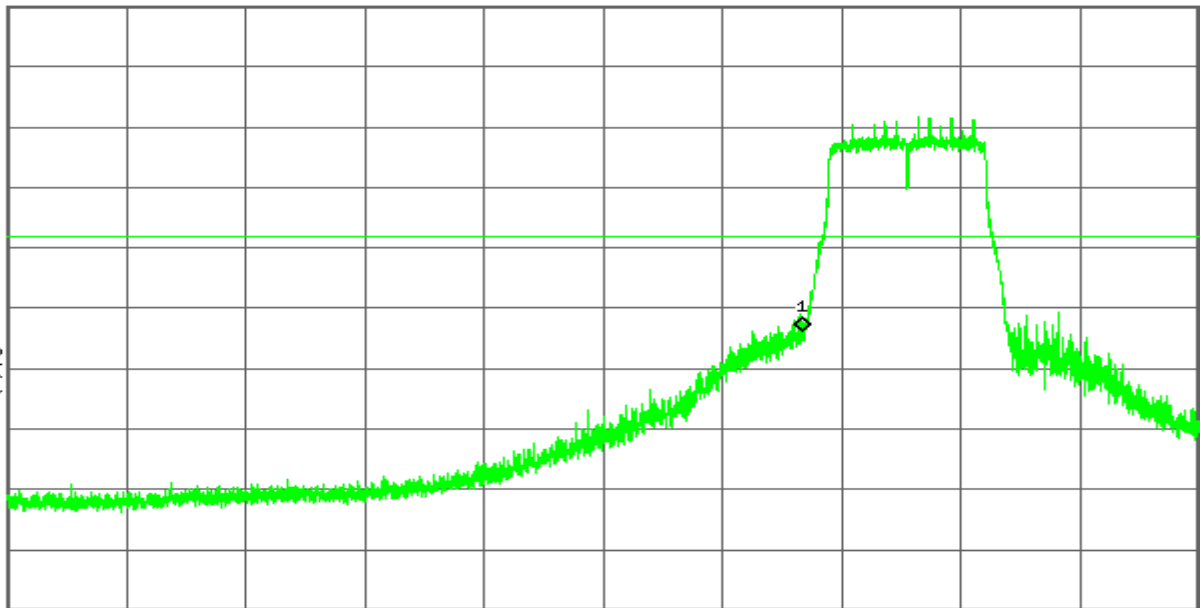

Start 2.310 000 GHz

#Res BW 100 kHz

#VBW 300 kHz

Stop 2.445 000 GHz

Sweep 13.11 ms (8192 pts)

Agilent

R T

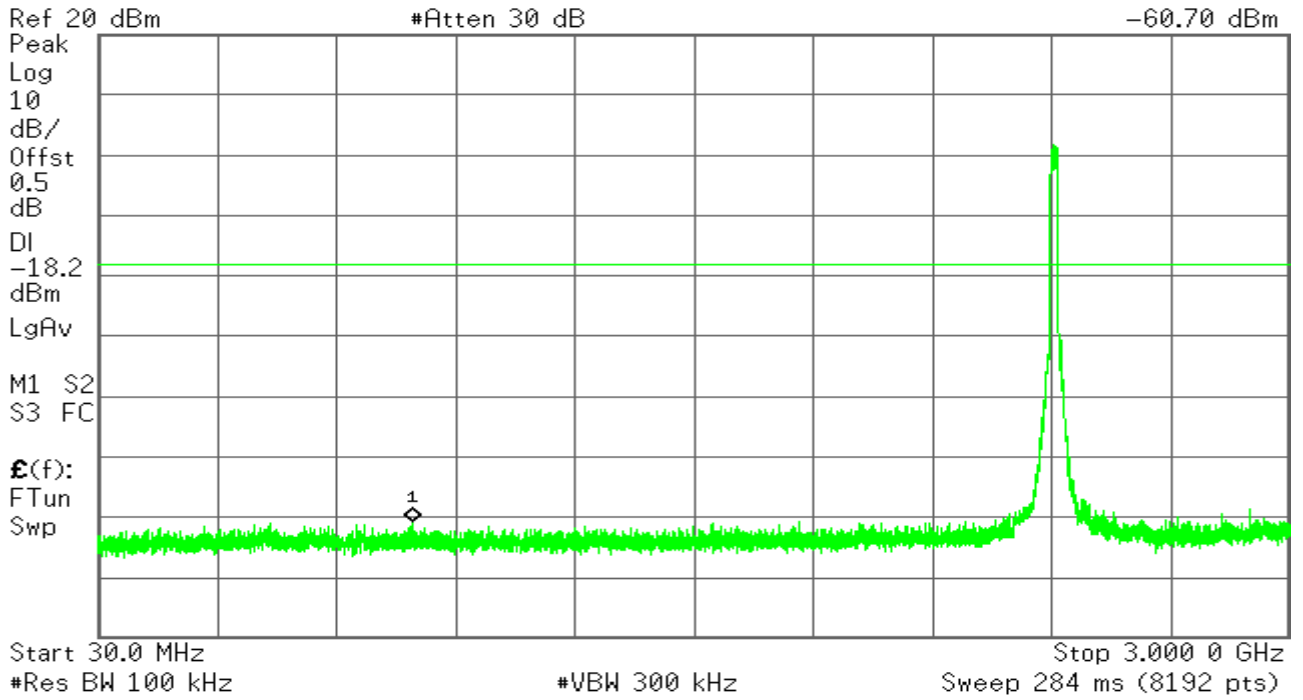

Agilent

R T

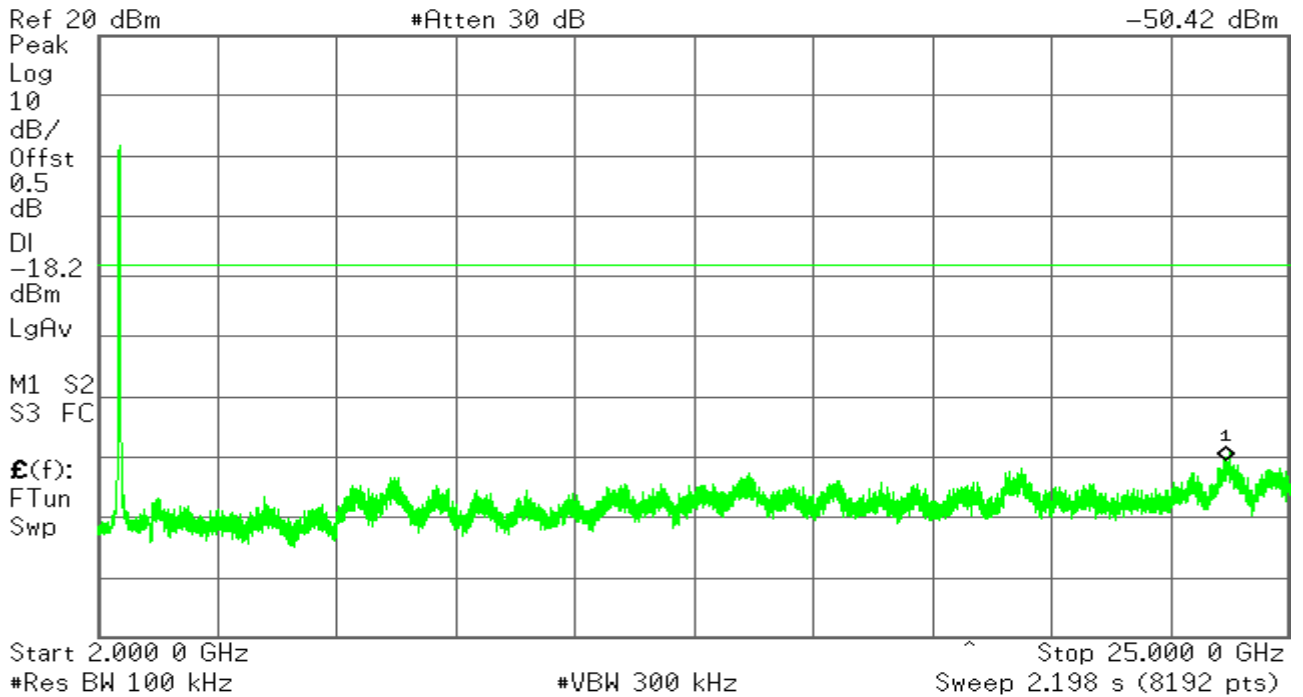

CH Mid

Agilent

R T

Mkr1 2.438 24 GHz
2.02 dBm

Ref 20 dBm

#Atten 30 dB

Peak

Log

10

dB/

Offst

0.5

dB

DI

-18.0

dBm

LgAv

M1 S2

S3 FC

£(f):

FTun

Swp

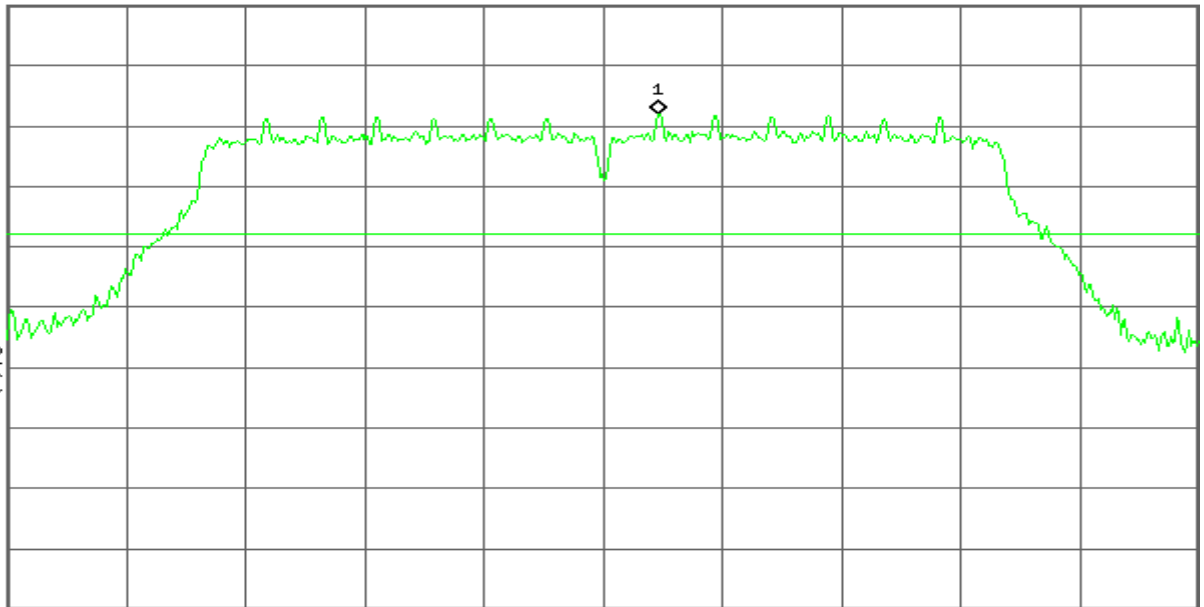

Center 2.437 000 GHz

Span 26.5 MHz

#Res BW 100 kHz

#VBW 300 kHz

Sweep 2.56 ms (601 pts)

Agilent

R T

Mkr1 2.018 8 GHz
-59.25 dBm

Ref 20 dBm

#Atten 30 dB

Peak

Log

10

dB/

Offst

0.5

dB

DI

-18.0

dBm

LgAv

M1 S2

S3 FC

£(f):

FTun

Swp

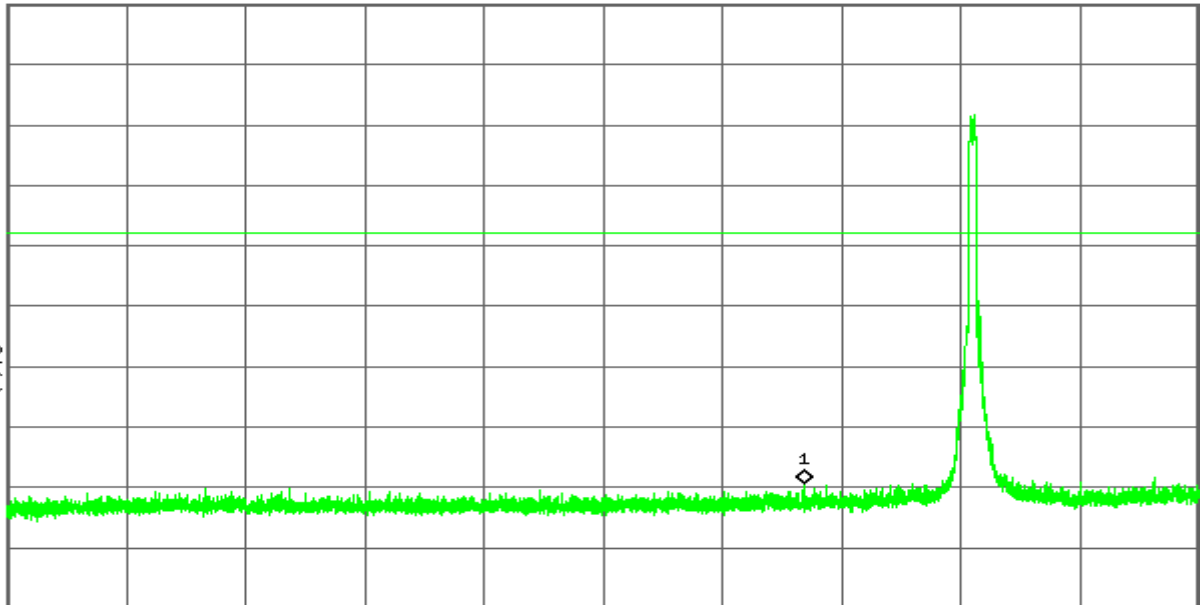

Start 30.00 MHz

Stop 3.000 00 GHz

#Res BW 100 kHz

#VBW 300 kHz

Sweep 284 ms (8192 pts)

Agilent

R T

Mkr1 23.860 0 GHz
-49.53 dBm

Ref 20 dBm

#Atten 30 dB

Peak

Log

10

dB/

Offst

0.5

dB

DI

-18.0

dBm

LgAv

M1 S2

S3 FC

$\mathcal{E}(f)$:

FTun

Swp

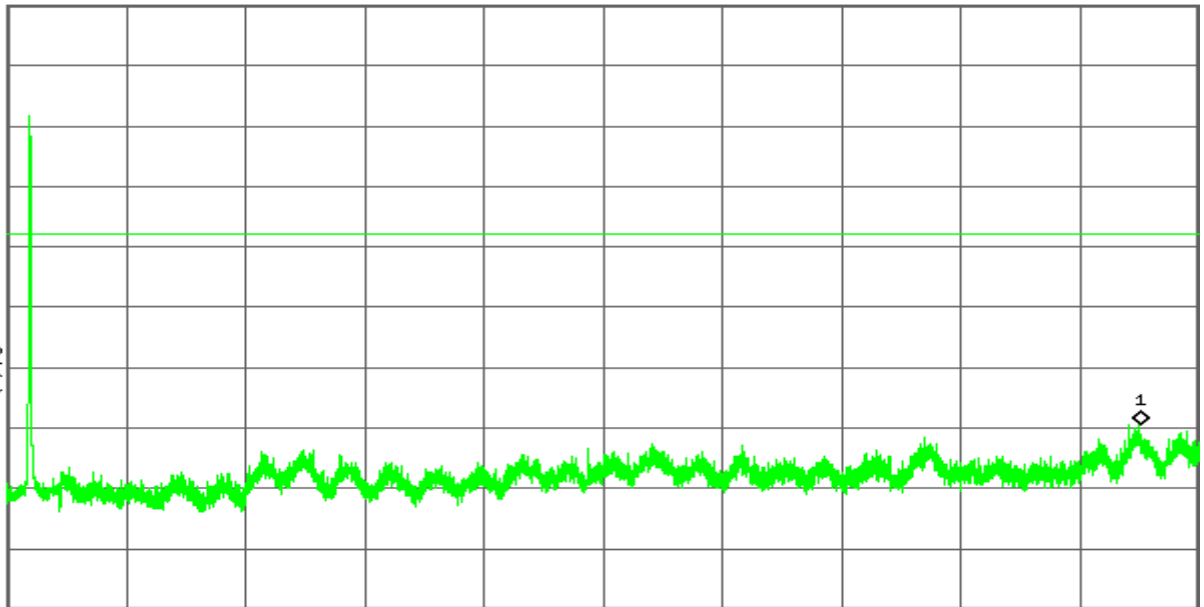

Start 2.000 0 GHz

Stop 25.000 0 GHz

#Res BW 100 kHz

#VBW 300 kHz

Sweep 2.198 s (8192 pts)

CH High

Agilent

R T

Mkr1 2.463 24 GHz
2.28 dBm

Ref 20 dBm

#Atten 30 dB

Peak

Log

10

dB/

Offst

0.5

dB

DI

-17.7

dBm

LgAv

M1 S2

S3 FC

$\mathcal{E}(f)$:

FTun

Swp

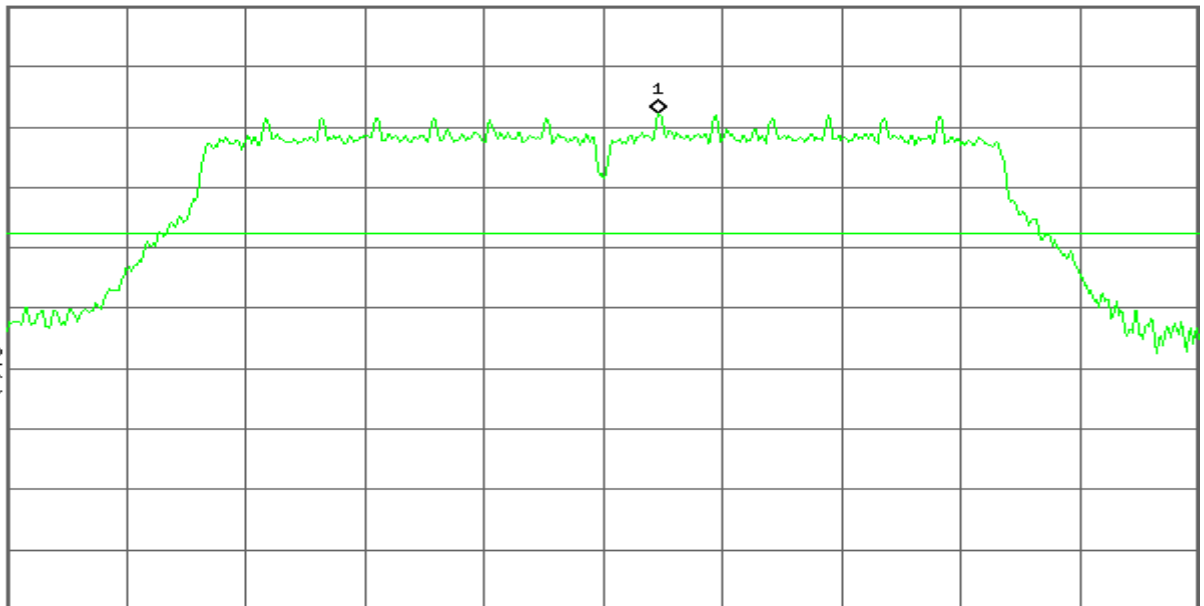

Center 2.462 000 GHz

Span 26.5 MHz

#Res BW 100 kHz

#VBW 300 kHz

Sweep 2.56 ms (601 pts)

Agilent

R T

Mkr1 2.483 500 GHz
-37.54 dBm

Ref 20 dBm

#Atten 30 dB

Peak
Log
10
dB/
Offst
0.5
dB
DI
-17.7
dBm
LgAv
M1 S2
S3 FC
£(f):
FTun
Swp

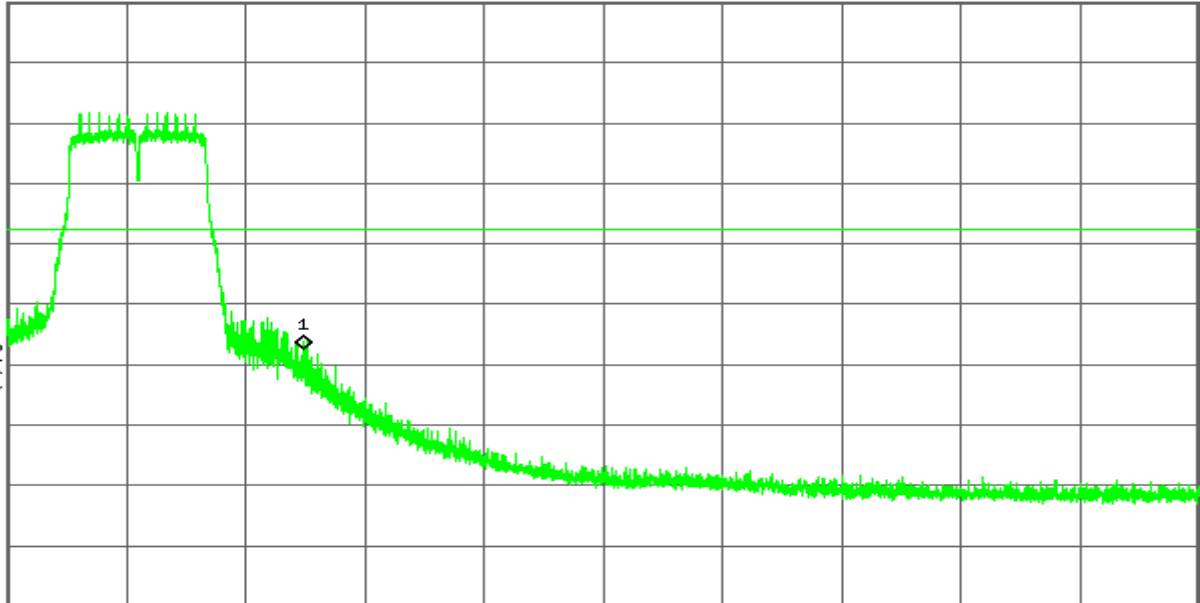

Start 2.445 00 GHz
#Res BW 100 kHz

#VBW 300 kHz

Stop 2.600 00 GHz
Sweep 15.29 ms (8192 pts)

Agilent

R T

Mkr1 2.331 7 GHz
-59.75 dBm

Ref 20 dBm

#Atten 30 dB

Peak
Log
10
dB/
Offst
0.5
dB
DI
-17.7
dBm
LgAv
M1 S2
S3 FC
£(f):
FTun
Swp

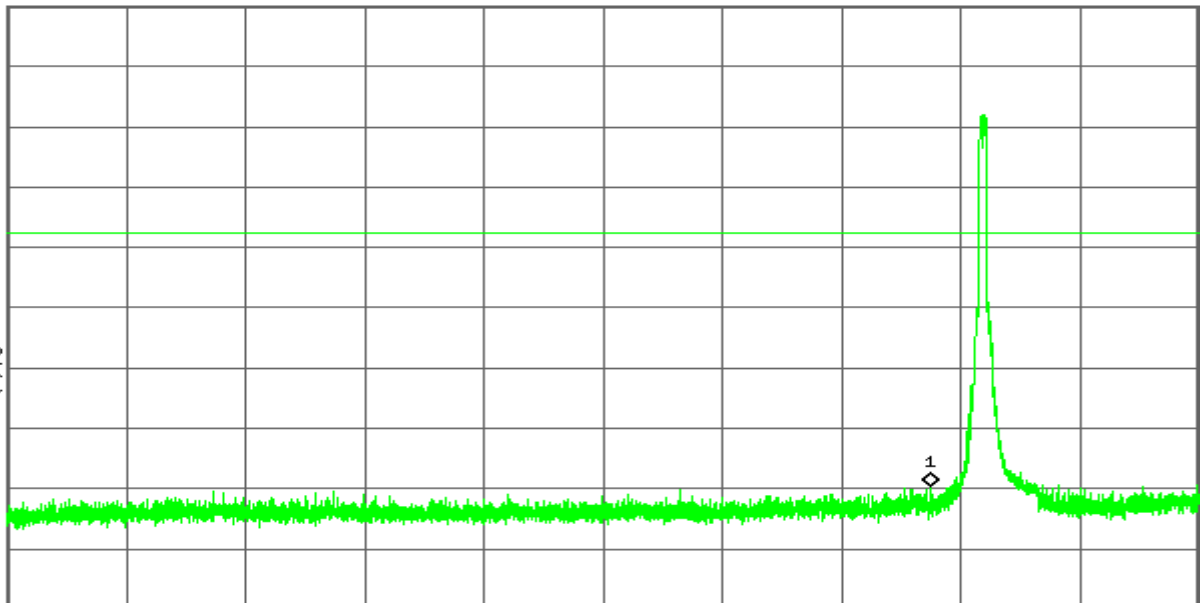

Start 30.0 MHz
#Res BW 100 kHz

#VBW 300 kHz

Stop 3.000 0 GHz
Sweep 284 ms (8192 pts)

Agilent

R T

Mkr1 23.733 6 GHz
-49.33 dBm

Ref 20 dBm

#Atten 30 dB

Peak

Log

10

dB/

Offst

0.5

dB

DI

-17.7

dBm

LgAv

M1 S2

S3 FC

$\mathcal{E}(f)$:

FTun

Swp

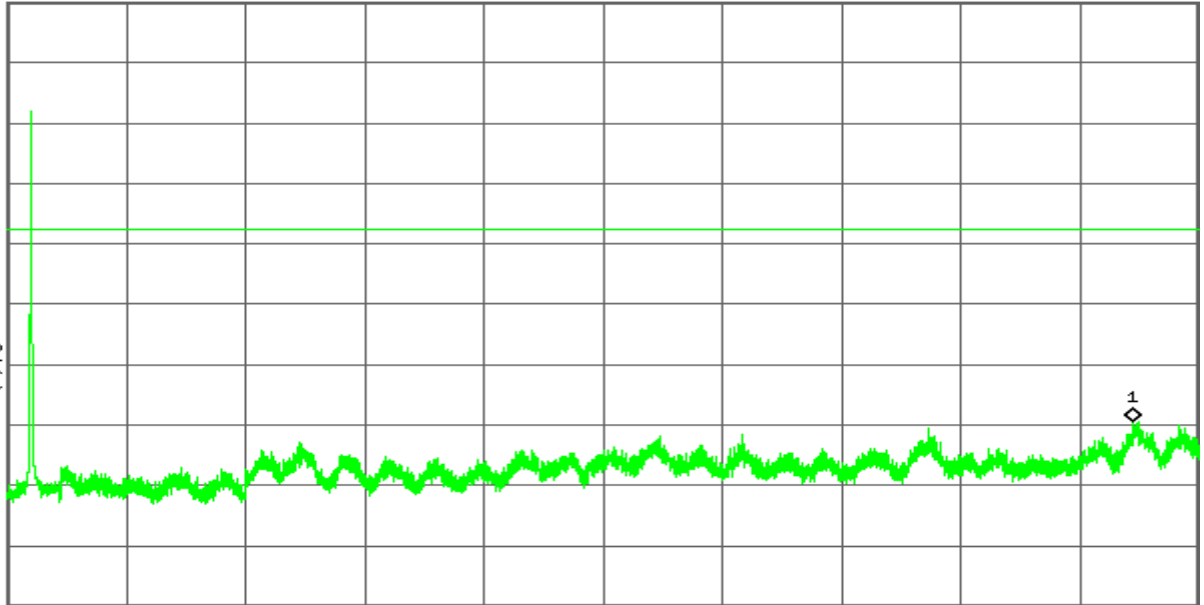

Start 2.000 0 GHz

#Res BW 100 kHz

#VBW 300 kHz

Stop 25.000 0 GHz

Sweep 2.198 s (8192 pts)

7.5.RADIATED EMISSIONS

LIMIT

Radiated emissions from 9 kHz to 25 GHz were measured according to the methods defines in ANSI C63.10-2013. The EUT was placed above the ground plane, 0.8 meter for frequency below 1GHz and 1.5 meter for frequency above 1GHz. The interface cables and equipment positions were varied within limits of reasonable applications to determine the positions producing maximum radiated emissions

1. According to §15.209(a), except as provided elsewhere in this Subpart, the emissions from an intentional radiator shall not exceed the field strength levels specified in the following table:

FREQUENCIES(MHz)	FIELD STRENGTH (microvolts/meter)	MEASUREMENT DISTANCE(meters)
0.009~0.490	2400/F(kHz)	300
0.490~1.705	24000/F(kHz)	30
1.705~30.0	30	30
30~88	100	3
88~216	150	3
216~960	200	3
Above 960	500	3

Remark: Except as provided in paragraph (g), fundamental emissions from intentional radiators operating under this Section shall not be located in the frequency bands 54-72 MHz, 76-88 MHz, 174-216 MHz or 470-806 MHz. However, operation within these frequency bands is permitted under other sections of this Part, e.g., Sections 15.231 and 15.241.

2.In the emission table above, the tighter limit applies at the band edges.

Frequency (MHz)	Field Strength (μ V/m at 3-meter)	Field Strength (dB μ V/m at 3-meter)
30-88	100	40
88-216	150	43.5
216-960	200	46
Above 960	500	54

Test Configuration

Below 30MHz

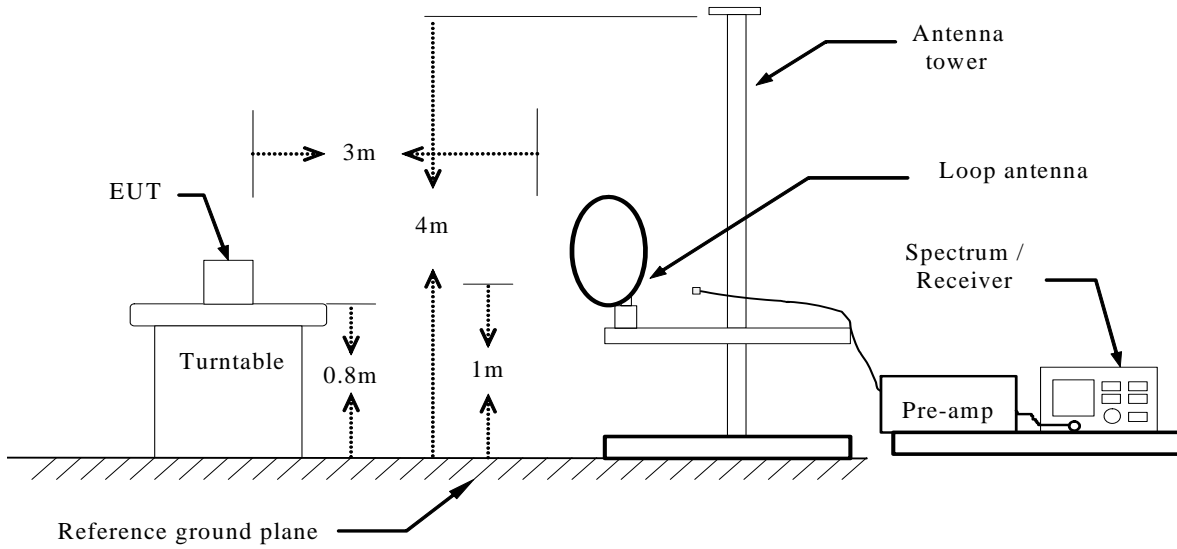

Below 1 GHz

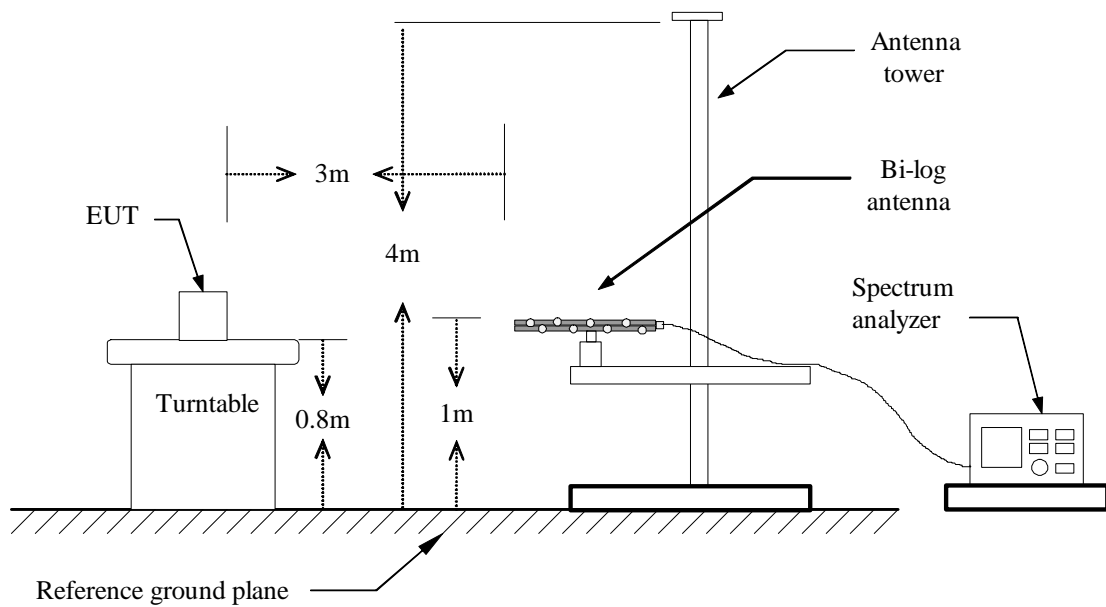

Above 1 GHz

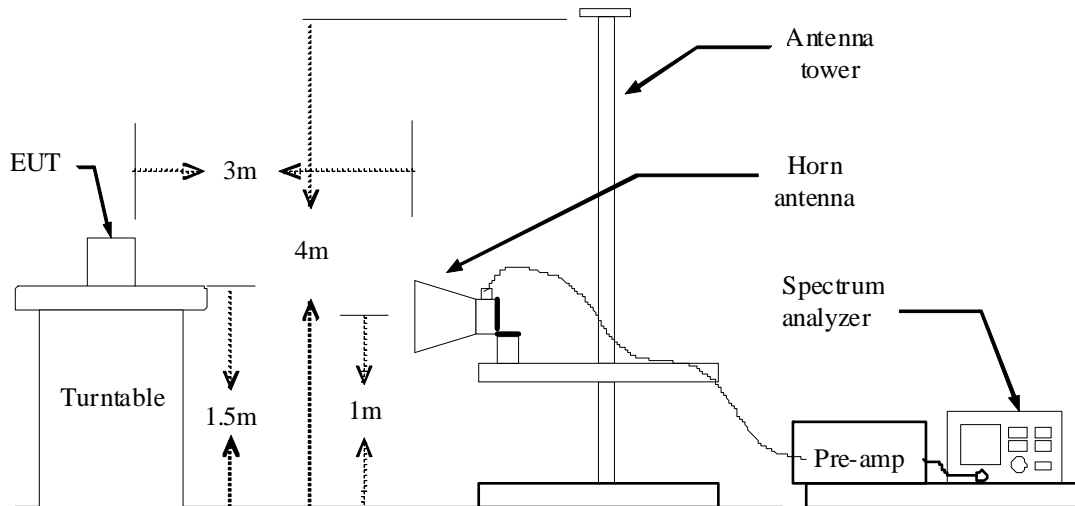

TEST PROCEDURE

1. The EUT is placed on a turntable above ground plane, which is 0.8 meter for frequency below 1GHz and 1.5 meter for frequency above 1GHz.
2. The turntable shall be rotated for 360 degrees to determine the position of maximum emission level.
3. EUT is set 3m away from the receiving antenna, which is varied from 1m to 4m to find out the highest emissions.
4. Maximum procedure was performed on the six highest emissions to ensure EUT compliance.
5. And also, each emission was to be maximized by changing the polarization of receiving antenna both horizontal and vertical.
6. Set the spectrum analyzer in the following setting as:

Below 1GHz:

RBW=100kHz / VBW=300kHz / Sweep=AUTO

Above 1GHz:

PEAK: RBW=VBW=1MHz / Sweep=AUTO

AVERAGE: RBW=1MHz / Sweep=AUTO

VBW=10Hz, when duty cycle is no less than 98 percent.

VBW $\geq 1/T$, when duty cycle is less than 98 percent, where T is the minimum transmission duration over which the transmitter is on and is transmitting at its maximum power control level for the tested mode of operation.

Band	Duty Cycle(%)	T(ms)	1/T(kHz)	VBW Setting
IEEE 802.11 b	100	--	--	10Hz
IEEE 802.11 g	98	--	--	10Hz
IEEE 802.11n HT20	98	--	--	10Hz

7. Repeat above procedures until the measurements for all frequencies are complete.

TEST RESULTS

RESTRICTED BANDEDGE (b Mode, Low Channel, Horizontal)

120.0 dBuV/m

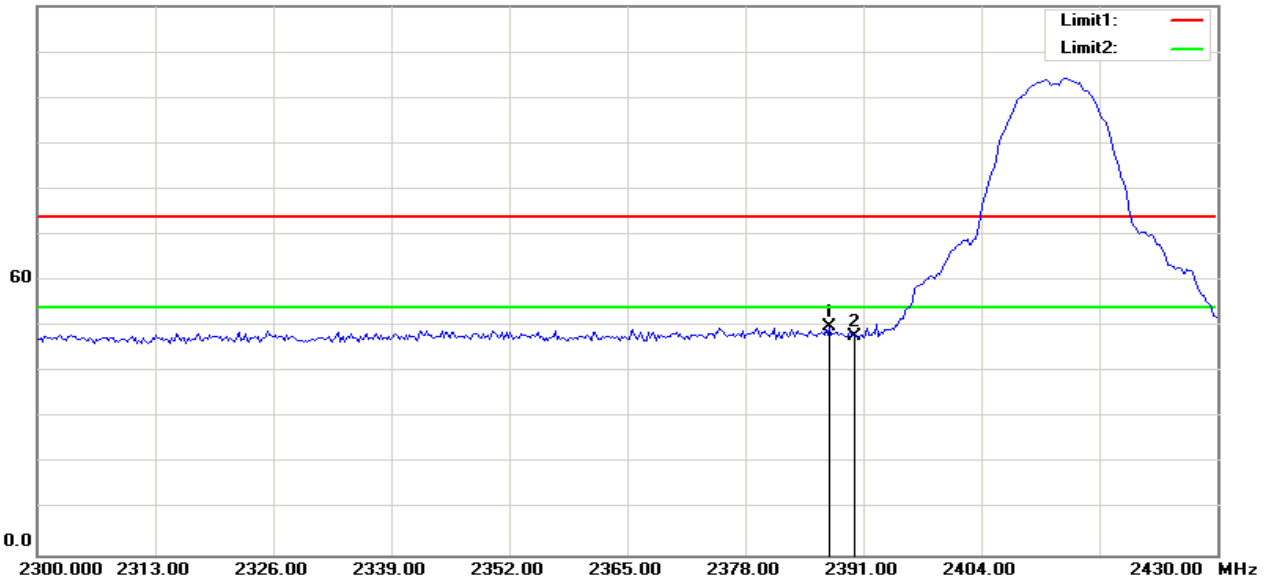

No.	Frequency (MHz)	Reading (dBuV)	Correct Factor(dB/m)	Result (dBuV/m)	Limit (dBuV/m)	Margin (dB)	Height (cm)	Degree (deg.)	Remark
1	2387.292	57.39	-7.34	50.05	74.00	-23.95	100	106	peak
2	2390.000	55.28	-7.31	47.97	74.00	-26.03	100	142	peak

RESTRICTED BANDEDGE (b Mode, Low Channel, Vertical)

120.0 dBuV/m

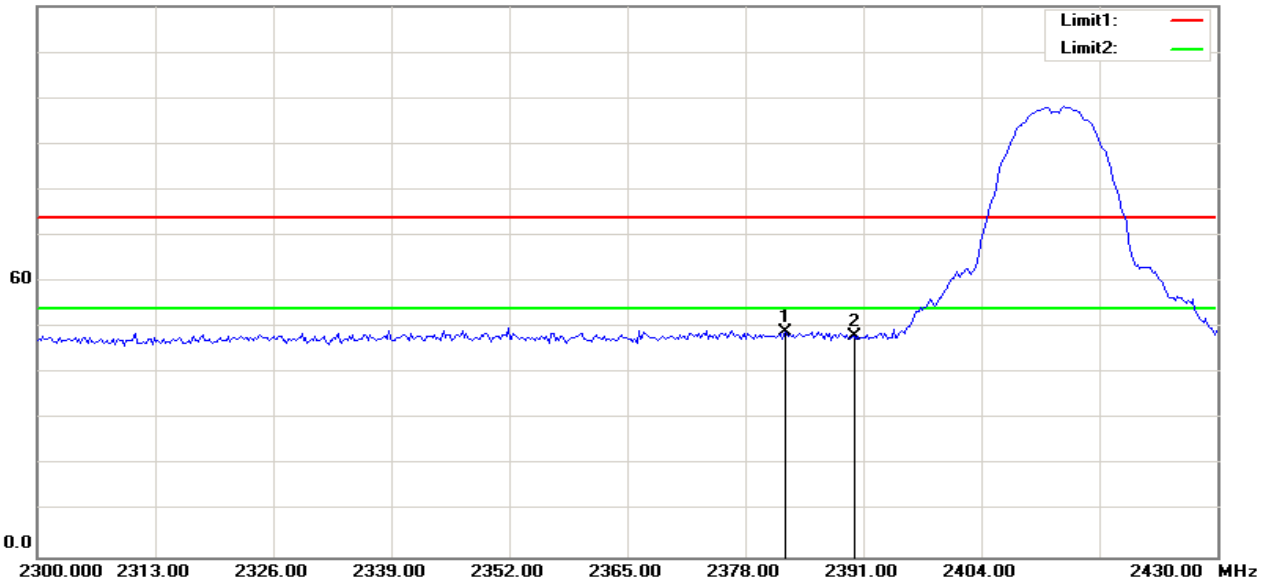

No.	Frequency (MHz)	Reading (dBuV)	Correct Factor(dB/m)	Result (dBuV/m)	Limit (dBuV/m)	Margin (dB)	Height (cm)	Degree (deg.)	Remark
1	2382.500	56.55	-7.38	49.17	74.00	-24.83	100	237	peak
2	2390.000	55.51	-7.31	48.20	74.00	-25.80	100	153	peak

RESTRICTED BANDEDGE (b Mode, High Channel, Horizontal)

120.0 dBuV/m

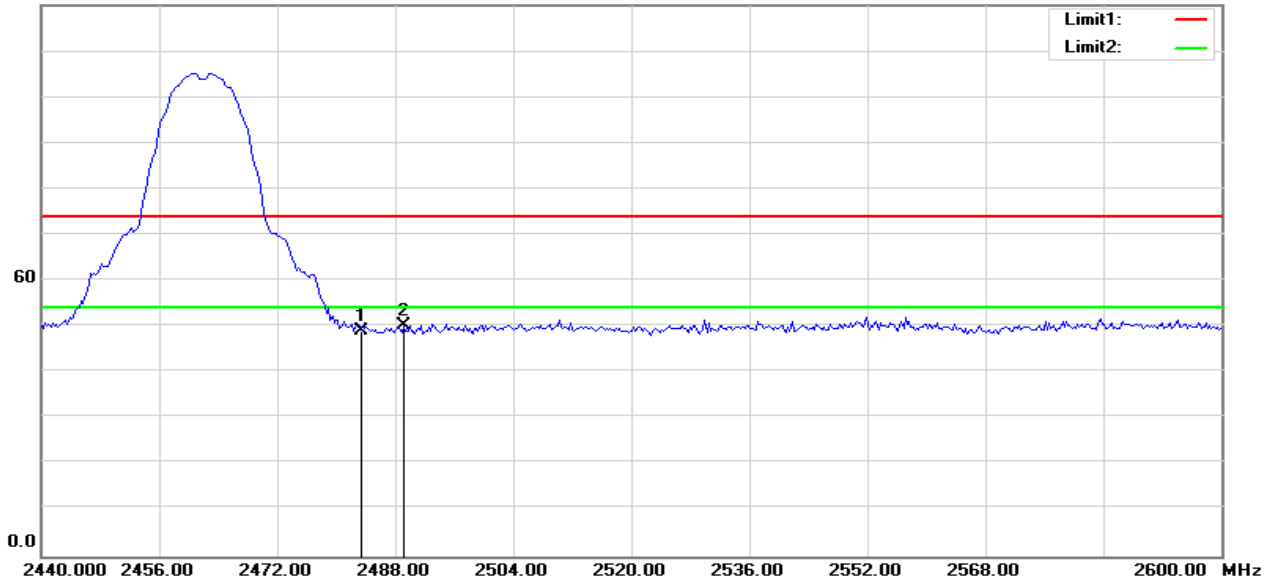

No.	Frequency (MHz)	Reading (dBuV)	Correct Factor(dB/m)	Result (dBuV/m)	Limit (dBuV/m)	Margin (dB)	Height (cm)	Degree (deg.)	Remark
1	2483.500	55.48	-6.44	49.04	74.00	-24.96	100	127	peak
2	2489.231	56.62	-6.39	50.23	74.00	-23.77	100	127	peak

RESTRICTED BANDEDGE (b Mode, High Channel, Vertical)

120.0 dBuV/m

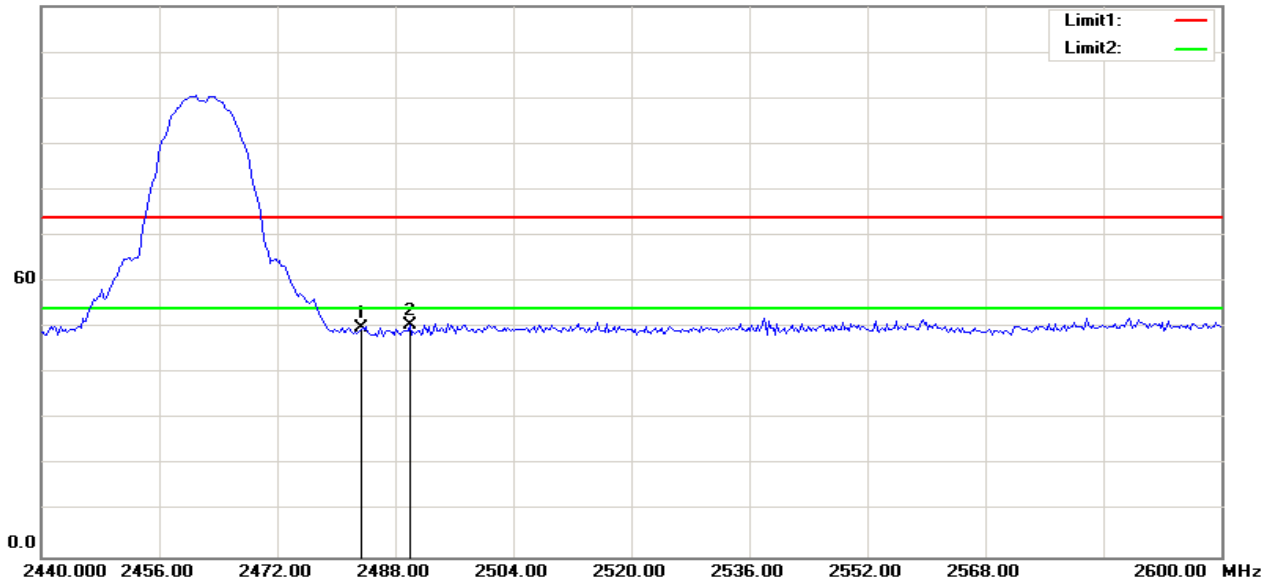

No.	Frequency (MHz)	Reading (dBuV)	Correct Factor(dB/m)	Result (dBuV/m)	Limit (dBuV/m)	Margin (dB)	Height (cm)	Degree (deg.)	Remark
1	2483.500	56.26	-6.44	49.82	74.00	-24.18	100	177	peak
2	2490.000	56.82	-6.38	50.44	74.00	-23.56	100	99	peak

RESTRICTED BANDEDGE (g Mode, Low Channel, Horizontal)

120.0 dBuV/m

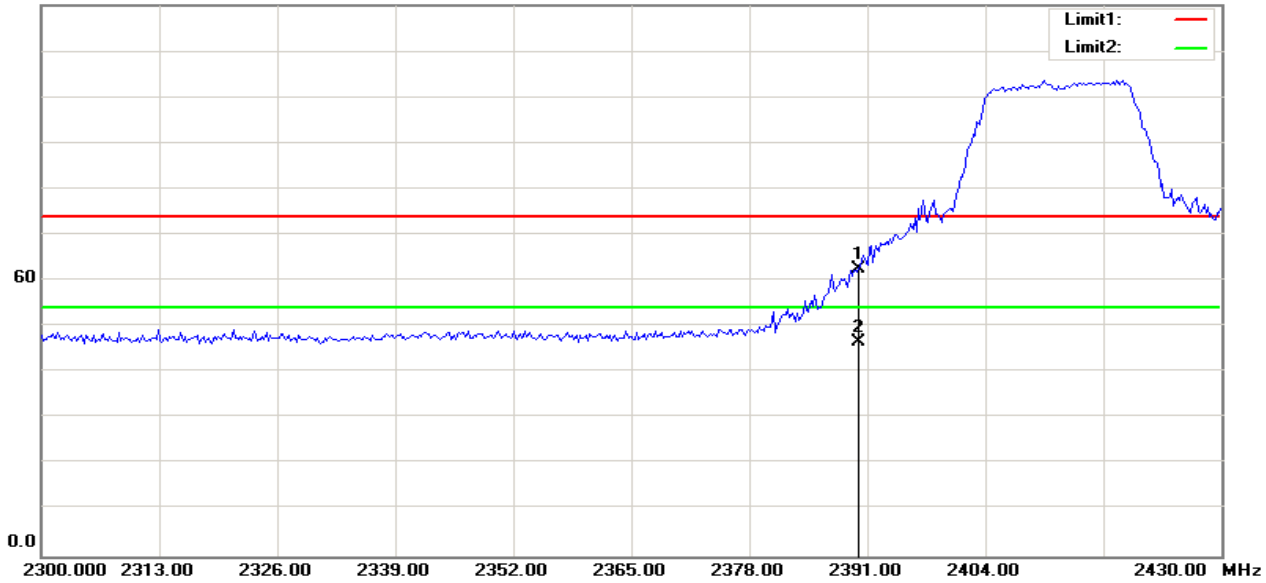

No.	Frequency (MHz)	Reading (dBuV)	Correct Factor(dB/m)	Result (dBuV/m)	Limit (dBuV/m)	Margin (dB)	Height (cm)	Degree (deg.)	Remark
1	2390.000	69.86	-7.31	62.55	74.00	-11.45	100	125	peak
2	2390.000	53.83	-7.31	46.52	54.00	-7.48	100	126	AVG

RESTRICTED BANDEDGE (g Mode, Low Channel, Vertical)

120.0 dBuV/m

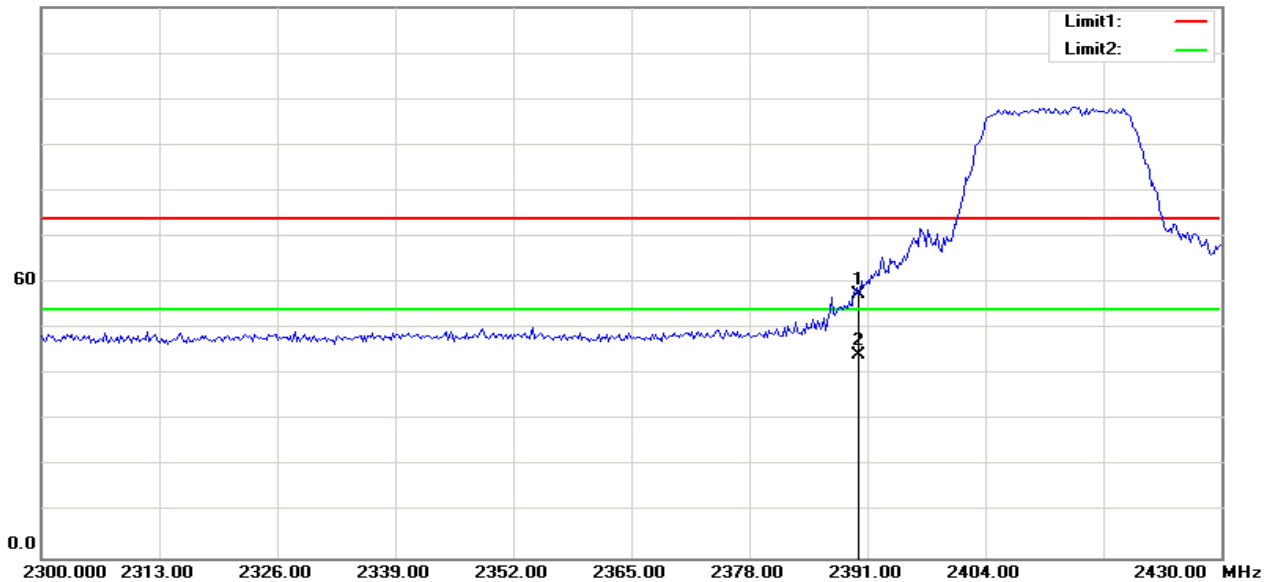

No.	Frequency (MHz)	Reading (dBuV)	Correct Factor(dB/m)	Result (dBuV/m)	Limit (dBuV/m)	Margin (dB)	Height (cm)	Degree (deg.)	Remark
1	2390.000	64.87	-7.31	57.56	74.00	-16.44	100	121	peak
2	2390.000	51.52	-7.31	44.21	54.00	-9.79	100	121	AVG

RESTRICTED BANDEDGE (g Mode, High Channel, Horizontal)

120.0 dBuV/m

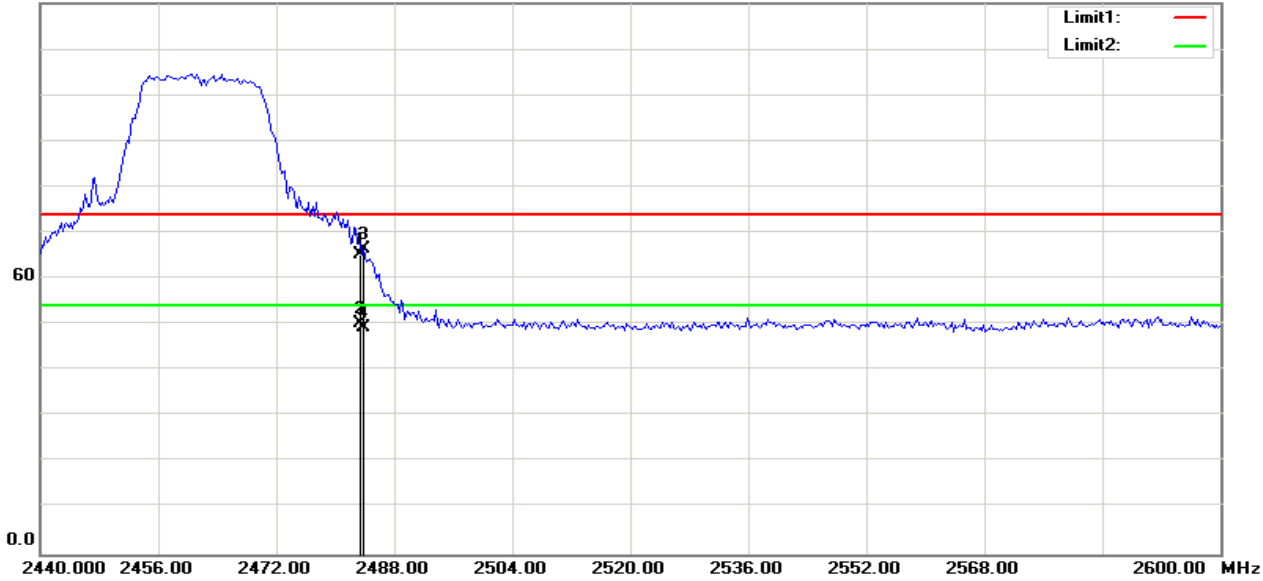

No.	Frequency (MHz)	Reading (dBuV)	Correct Factor(dB/m)	Result (dBuV/m)	Limit (dBuV/m)	Margin (dB)	Height (cm)	Degree (deg.)	Remark
1	2483.500	71.78	-6.44	65.34	74.00	-8.66	100	150	peak
2	2483.500	56.84	-6.44	50.40	54.00	-3.60	100	151	AVG
3	2483.846	72.91	-6.44	66.47	74.00	-7.53	100	139	peak
4	2483.846	55.82	-6.44	49.38	54.00	-4.62	100	139	AVG

RESTRICTED BANDEDGE (g Mode, High Channel, Vertical)

120.0 dBuV/m

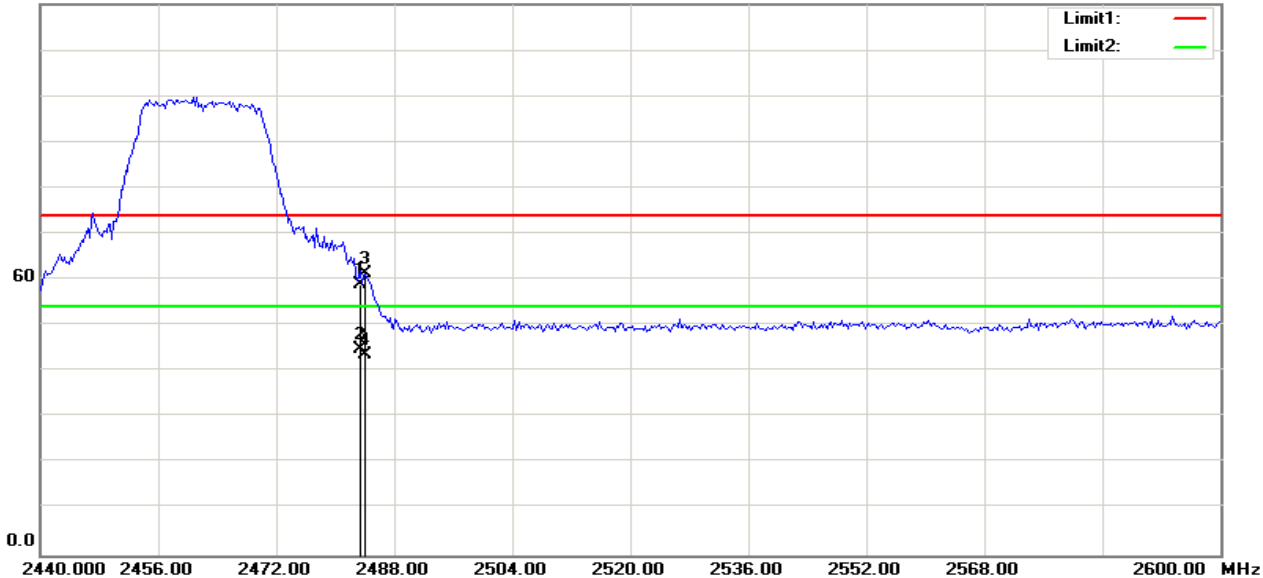

No.	Frequency (MHz)	Reading (dBuV)	Correct Factor(dB/m)	Result (dBuV/m)	Limit (dBuV/m)	Margin (dB)	Height (cm)	Degree (deg.)	Remark
1	2483.500	65.39	-6.44	58.95	74.00	-15.05	100	165	peak
2	2483.500	51.21	-6.44	44.77	54.00	-9.23	100	166	AVG
3	2484.103	67.75	-6.44	61.31	74.00	-12.69	100	91	peak
4	2484.103	49.96	-6.44	43.52	54.00	-10.48	100	90	AVG

RESTRICTED BANDEDGE (IEEE 802.11n HT20 mode, Low Channel, Horizontal)

120.0 dBuV/m

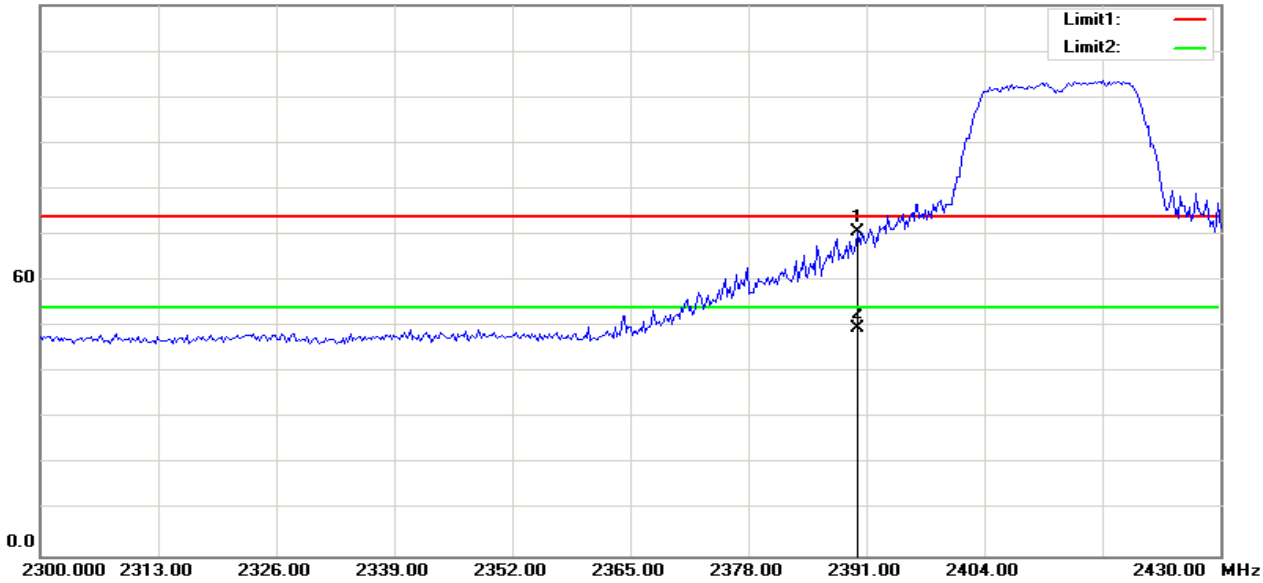

No.	Frequency (MHz)	Reading (dBuV)	Correct Factor(dB/m)	Result (dBuV/m)	Limit (dBuV/m)	Margin (dB)	Height (cm)	Degree (deg.)	Remark
1	2390.000	77.98	-7.31	70.67	74.00	-3.33	100	140	peak
2	2390.000	56.90	-7.31	49.59	54.00	-4.41	100	141	AVG

RESTRICTED BANDEDGE (IEEE 802.11n HT20 mode, Low Channel, Vertical)

120.0 dBuV/m

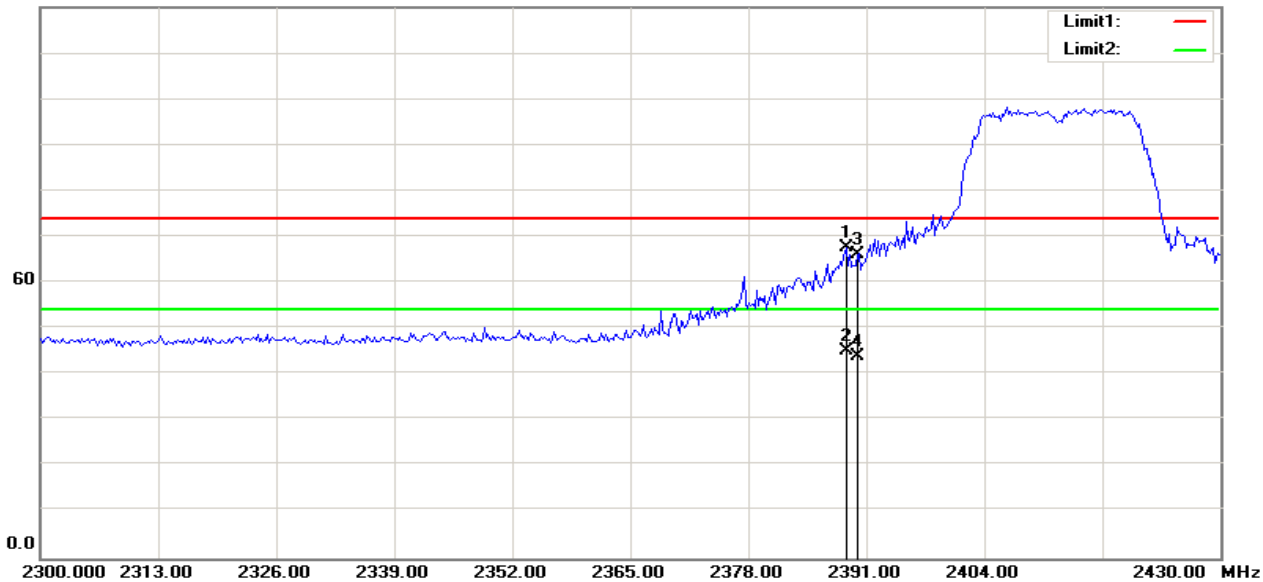

No.	Frequency (MHz)	Reading (dBuV)	Correct Factor(dB/m)	Result (dBuV/m)	Limit (dBuV/m)	Margin (dB)	Height (cm)	Degree (deg.)	Remark
1	2388.750	74.93	-7.32	67.61	74.00	-6.39	100	135	peak
2	2388.750	52.54	-7.32	45.22	54.00	-8.78	100	132	AVG
3	2390.000	73.38	-7.31	66.07	74.00	-7.93	100	226	peak
4	2390.000	51.21	-7.31	43.90	54.00	-10.10	100	227	AVG

RESTRICTED BANDEDGE (IEEE 802.11n HT20 mode, High Channel, Horizontal)



No.	Frequency (MHz)	Reading (dBuV)	Correct Factor(dB/m)	Result (dBuV/m)	Limit (dBuV/m)	Margin (dB)	Height (cm)	Degree (deg.)	Remark
1	2483.500	70.81	-6.44	64.37	74.00	-9.63	100	141	peak
2	2483.500	52.86	-6.44	46.42	54.00	-7.58	100	140	AVG
3	2484.359	74.68	-6.44	68.24	74.00	-5.76	100	154	peak
4	2484.359	51.59	-6.44	45.15	54.00	-8.85	100	152	AVG

RESTRICTED BANDEDGE (IEEE 802.11n HT20 mode, High Channel, Vertical)



No.	Frequency (MHz)	Reading (dBuV)	Correct Factor(dB/m)	Result (dBuV/m)	Limit (dBuV/m)	Margin (dB)	Height (cm)	Degree (deg.)	Remark
1	2483.500	68.57	-6.44	62.13	74.00	-11.87	100	111	peak
2	2483.500	46.70	-6.44	40.26	54.00	-13.74	100	110	AVG
3	2483.846	71.56	-6.44	65.12	74.00	-8.88	100	117	peak
4	2483.846	46.61	-6.44	40.17	54.00	-13.83	100	115	AVG

Test Result of Radiated Emission**Below 30MHz**

The interference of the frequency value is lower than the limit below 20 db, measured as the background noise values and will not be recorded.

30MHz-1GHz

Operation Mode:	Normal Link	Test Date:	2017-6-15
Temperature:	25°C	Tested by:	Lily.Wang
Humidity:	48% RH	Polarity:	Ver. / Hor.

Frequency (MHz)	Ant. Pol. (H/V)	Reading (dBuV)	Correction Factor (dB/m)	Result (dBuV/m)	Limit (dBuV/m)	Margin (dB)	Remark
38.7300	V	20.02	17.06	37.08	40.00	-2.92	peak
257.9500	V	21.62	15.18	36.80	46.00	-9.20	peak
521.7900	V	17.46	21.64	39.10	46.00	-6.90	peak
750.7100	V	16.47	26.43	42.90	46.00	-3.10	peak
768.1700	V	16.16	25.77	41.93	46.00	-4.07	peak
856.4400	V	16.35	26.12	42.47	46.00	-3.53	peak
35.8200	H	13.87	18.49	32.36	40.00	-7.64	peak
222.0600	H	24.17	15.46	39.63	46.00	-6.37	QP
246.3100	H	25.36	15.11	40.47	46.00	-5.53	QP
257.9500	H	26.03	15.18	41.21	46.00	-4.79	QP
736.1600	H	15.98	26.01	41.99	46.00	-4.01	peak
900.0900	H	12.58	25.93	38.51	46.00	-7.49	QP

Remark:

1. Measuring frequencies from 30 MHz to the 1GHz (No emission found between lowest internal used/generated frequency to 30 MHz).
2. Radiated emissions measured in frequency range from 30 MHz to 1000MHz were made with an instrument using peak/quasi-peak detector mode.
3. Measurements above show only up to 6 maximum emissions noted, or would be lesser, with "N/A" remark, if no specific emissions from the EUT are recorded (ie: margin>20dB from the applicable limit) and considered that's already beyond the background noise floor.
4. Margin (dB) = Result (dBuV/m) – Limit (dBuV/m).

Above 1 GHz

Operation Mode: TX / IEEE 802.11b / CH Low

Test Date: 2017-6-15

Temperature: 24°C

Tested by: Lily.Wang

Humidity: 48 % RH

Polarity: Ver. / Hor.

Horizontal

No.	Frequency (MHz)	Reading (dBuV)	Correct Factor(dB/m)	Result (dBuV/m)	Limit (dBuV/m)	Margin (dB)	Height (cm)	Degree (deg.)	Remark
1	4187.500	43.86	-5.77	38.09	74.00	-35.91	100	1	peak
2	7375.000	42.87	6.45	49.32	74.00	-24.68	100	36	peak
N/A									

Vertical

No.	Frequency (MHz)	Reading (dBuV)	Correct Factor(dB/m)	Result (dBuV/m)	Limit (dBuV/m)	Margin (dB)	Height (cm)	Degree (deg.)	Remark
1	4269.231	43.00	-5.70	37.30	74.00	-36.70	100	132	peak
2	7266.026	43.34	6.35	49.69	74.00	-24.31	100	145	peak
N/A									

Operation Mode: TX / IEEE 802.11b / CH Mid

Test Date: 2017-6-15

Temperature: 24°C

Tested by: Lily.Wang

Humidity: 48 % RH

Polarity: Ver. / Hor.

Horizontal

No.	Frequency (MHz)	Reading (dBuV)	Correct Factor(dB/m)	Result (dBuV/m)	Limit (dBuV/m)	Margin (dB)	Height (cm)	Degree (deg.)	Remark
1	4214.744	43.29	-5.75	37.54	74.00	-36.46	100	157	peak
2	7266.026	42.68	6.35	49.03	74.00	-24.97	100	359	peak
N/A									

Vertical

No.	Frequency (MHz)	Reading (dBuV)	Correct Factor(dB/m)	Result (dBuV/m)	Limit (dBuV/m)	Margin (dB)	Height (cm)	Degree (deg.)	Remark
1	4187.500	42.96	-5.77	37.19	74.00	-36.81	100	301	peak
2	7456.731	43.27	6.52	49.79	74.00	-24.21	100	109	peak
N/A									

Operation Mode: TX / IEEE 802.11b / CH High

Test Date: 2017-6-15

Temperature: 24°C

Tested by: Lily.Wang

Humidity: 48 % RH

Polarity: Ver. / Hor.

Horizontal

No.	Frequency (MHz)	Reading (dBuV)	Correct Factor(dB/m)	Result (dBuV/m)	Limit (dBuV/m)	Margin (dB)	Height (cm)	Degree (deg.)	Remark
1	4269.231	43.18	-5.70	37.48	74.00	-36.52	100	6	peak
2	7402.244	42.84	6.47	49.31	74.00	-24.69	100	147	peak
N/A									

Vertical

No.	Frequency (MHz)	Reading (dBuV)	Correct Factor(dB/m)	Result (dBuV/m)	Limit (dBuV/m)	Margin (dB)	Height (cm)	Degree (deg.)	Remark
1	4269.231	42.88	-5.70	37.18	74.00	-36.82	100	313	peak
2	7592.949	42.86	6.64	49.50	74.00	-24.50	100	49	peak
N/A									

Operation Mode: TX / IEEE 802.11g / CH Low

Test Date: 2017-6-15

Temperature: 24°C

Tested by: Lily.Wang

Humidity: 48 % RH

Polarity: Ver. / Hor.

Horizontal

No.	Frequency (MHz)	Reading (dBuV)	Correct Factor(dB/m)	Result (dBuV/m)	Limit (dBuV/m)	Margin (dB)	Height (cm)	Degree (deg.)	Remark
1	4269.231	42.76	-5.70	37.06	74.00	-36.94	100	256	peak
2	7184.295	42.79	6.28	49.07	74.00	-24.93	100	262	peak
N/A									

Vertical

No.	Frequency (MHz)	Reading (dBuV)	Correct Factor(dB/m)	Result (dBuV/m)	Limit (dBuV/m)	Margin (dB)	Height (cm)	Degree (deg.)	Remark
1	4269.231	42.61	-5.70	36.91	74.00	-37.09	100	311	peak
2	7102.564	43.63	6.20	49.83	74.00	-24.17	100	74	peak
N/A									

Operation Mode: TX / IEEE 802.11g / CH Mid

Test Date: 2017-6-15

Temperature: 24°C

Tested by: Lily.Wang

Humidity: 48 % RH

Polarity: Ver. / Hor.

Horizontal

No.	Frequency (MHz)	Reading (dBuV)	Correct Factor(dB/m)	Result (dBuV/m)	Limit (dBuV/m)	Margin (dB)	Height (cm)	Degree (deg.)	Remark
1	4241.987	43.37	-5.72	37.65	74.00	-36.35	100	223	peak
2	7266.026	43.82	6.35	50.17	74.00	-23.83	100	130	peak
N/A									

Vertical

No.	Frequency (MHz)	Reading (dBuV)	Correct Factor(dB/m)	Result (dBuV/m)	Limit (dBuV/m)	Margin (dB)	Height (cm)	Degree (deg.)	Remark
1	4187.500	43.41	-5.77	37.64	74.00	-36.36	100	1	peak
2	7320.513	42.57	6.40	48.97	74.00	-25.03	100	292	peak
N/A									

Operation Mode: TX / IEEE 802.11g / CH High

Test Date: 2017-6-15

Temperature: 24°C

Tested by: Lily.Wang

Humidity: 48 % RH

Polarity: Ver. / Hor.

Horizontal

No.	Frequency (MHz)	Reading (dBuV)	Correct Factor(dB/m)	Result (dBuV/m)	Limit (dBuV/m)	Margin (dB)	Height (cm)	Degree (deg.)	Remark
1	4296.474	43.60	-5.68	37.92	74.00	-36.08	100	109	peak
2	7592.949	42.96	6.64	49.60	74.00	-24.40	100	260	peak
N/A									

Vertical

No.	Frequency (MHz)	Reading (dBuV)	Correct Factor(dB/m)	Result (dBuV/m)	Limit (dBuV/m)	Margin (dB)	Height (cm)	Degree (deg.)	Remark
1	4269.231	43.11	-5.70	37.41	74.00	-36.59	100	65	peak
2	7375.000	42.76	6.45	49.21	74.00	-24.79	100	5	peak
N/A									

Operation Mode: TX / IEEE 802.11n HT20 mode / CH Low

Test Date: 2017-6-15

Temperature: 24°C

Tested by: Lily.Wang

Humidity: 48 % RH

Polarity: Ver. / Hor.

Horizontal

No.	Frequency (MHz)	Reading (dBuV)	Correct Factor(dB/m)	Result (dBuV/m)	Limit (dBuV/m)	Margin (dB)	Height (cm)	Degree (deg.)	Remark
1	4296.474	43.84	-5.68	38.16	74.00	-35.84	100	59	peak
2	7020.833	43.38	6.13	49.51	74.00	-24.49	100	349	peak
N/A									

Vertical

No.	Frequency (MHz)	Reading (dBuV)	Correct Factor(dB/m)	Result (dBuV/m)	Limit (dBuV/m)	Margin (dB)	Height (cm)	Degree (deg.)	Remark
1	4269.231	43.19	-5.70	37.49	74.00	-36.51	100	165	peak
2	7266.026	44.21	6.35	50.56	74.00	-23.44	100	29	peak
N/A									

Operation Mode: TX / IEEE 802.11n HT20 mode / CH Mid

Test Date: 2017-6-15

Temperature: 24°C

Tested by: Lily.Wang

Humidity: 48 % RH

Polarity: Ver. / Hor.

Horizontal

No.	Frequency (MHz)	Reading (dBuV)	Correct Factor(dB/m)	Result (dBuV/m)	Limit (dBuV/m)	Margin (dB)	Height (cm)	Degree (deg.)	Remark
1	4269.231	43.49	-5.70	37.79	74.00	-36.21	100	155	peak
2	7129.808	43.38	6.23	49.61	74.00	-24.39	100	2	peak
N/A									

Vertical

No.	Frequency (MHz)	Reading (dBuV)	Correct Factor(dB/m)	Result (dBuV/m)	Limit (dBuV/m)	Margin (dB)	Height (cm)	Degree (deg.)	Remark
1	4269.231	43.90	-5.70	38.20	74.00	-35.80	100	249	peak
2	7293.269	42.79	6.37	49.16	74.00	-24.84	100	359	peak
N/A									

Operation Mode: TX / IEEE 802.11n HT20 mode / CH High **Test Date:** 2017-6-15

Temperature: 24°C

Tested by: Lily.Wang

Humidity: 48 % RH

Polarity: Ver. / Hor.

Horizontal

No.	Frequency (MHz)	Reading (dBuV)	Correct Factor(dB/m)	Result (dBuV/m)	Limit (dBuV/m)	Margin (dB)	Height (cm)	Degree (deg.)	Remark
1	4269.231	43.54	-5.70	37.84	74.00	-36.16	100	72	peak
2	7592.949	43.84	6.64	50.48	74.00	-23.52	100	232	peak
N/A									

Vertical

No.	Frequency (MHz)	Reading (dBuV)	Correct Factor(dB/m)	Result (dBuV/m)	Limit (dBuV/m)	Margin (dB)	Height (cm)	Degree (deg.)	Remark
1	4269.231	42.86	-5.70	37.16	74.00	-36.84	100	336	peak
2	7565.705	42.37	6.62	48.99	74.00	-25.01	100	134	peak
N/A									

7.6.POWERLINE CONDUCTED EMISSIONS

LIMIT

According to §15.207(a), except as shown in paragraphs (b) and (c) of this section, for an intentional radiator that is designed to be connected to the public utility (AC) power line, the radio frequency voltage that is conducted back onto the AC power line on any frequency or frequencies within the band 150 kHz to 30 MHz shall not exceed the limits in the following table, as measured using a 50 μ H/50 ohms line impedance stabilization network (LISN). Compliance with the provisions of this paragraph shall be based on the measurement of the radio frequency voltage between each power line and ground at the power terminal. The lower limit applies at the boundary between the frequency ranges.

Frequency Range (MHz)	Limits (dB μ V)	
	Quasi-peak	Average
0.15 to 0.50	66 to 56*	56 to 46*
0.50 to 5	56	46
5 to 30	60	50

* Decreases with the logarithm of the frequency.

Test Configuration

See test photographs attached in Appendix 1 for the actual connections between EUT and support equipment.

TEST PROCEDURE

- 1.The EUT was placed on a table, which is 0.8m above ground plane.
- 2.Maximum procedure was performed on the six highest emissions to ensure EUT compliance.
- 3.Repeat above procedures until all frequency measured were complete.

TEST RESULTS

The initial step in collecting conducted data is a spectrum analyzer peak scan of the measurement range. Significant peaks are then marked as shown on the following data page, and these signals are then quasi-peaked.

TEST DATA

Job No.:	C170512R02	Date:	2017-6-16
Model No.:	YAS.1117	Time:	10:13:23
Standard:	FCC Class B	Temp.(C)/Hum.(%):	22(C)/48%
Test item:	Conduction test	Test By:	Lily.Wang
Line:	L1	Test Voltage:	AC 120V/60Hz
Model:		Description:	

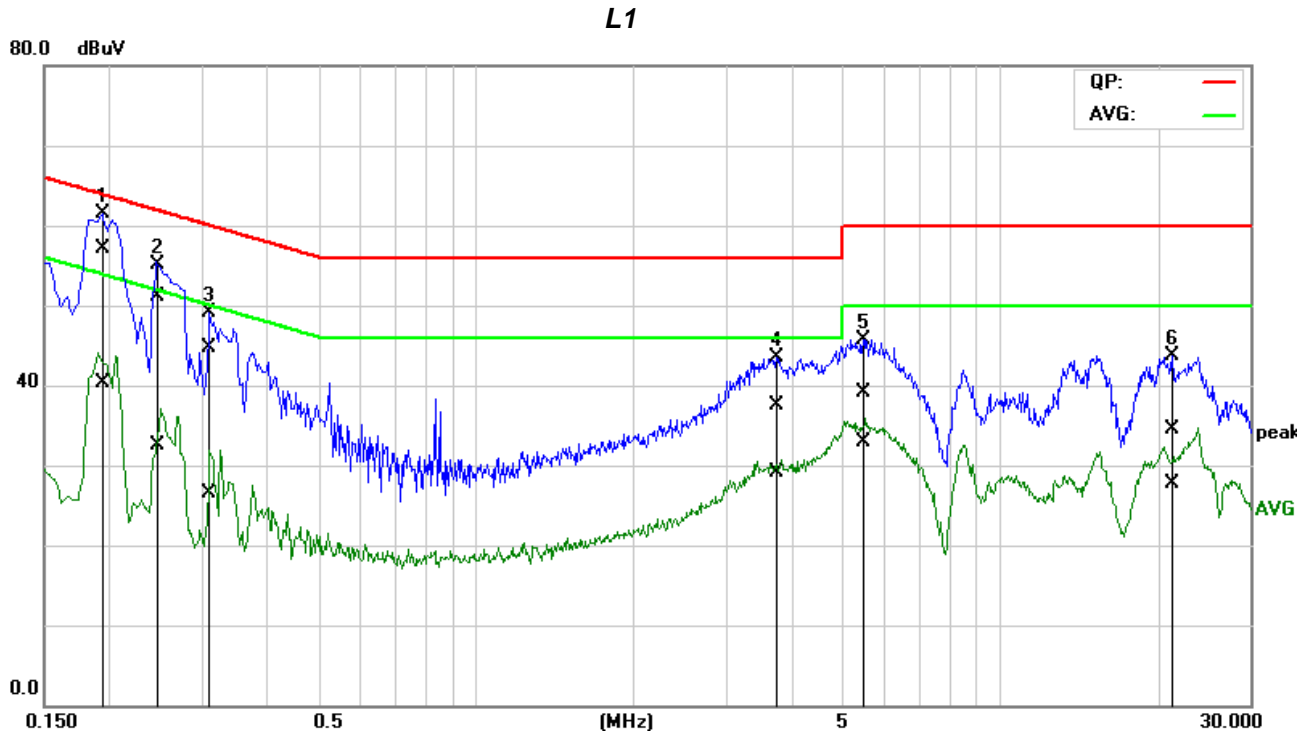

No.	Frequency (MHz)	QuasiPeak reading (dBuV)	Average reading (dBuV)	Correction factor (dB)	QuasiPeak result (dBuV)	Average result (dBuV)	QuasiPeak limit (dBuV)	Average limit (dBuV)	QuasiPeak margin (dB)	Average margin (dB)	Remark
1*	0.1959	36.64	19.76	20.52	57.16	40.28	63.78	53.78	-6.62	-13.50	Pass
2	0.2481	30.58	12.02	20.44	51.02	32.46	61.82	51.82	-10.80	-19.36	Pass
3	0.3113	24.22	5.88	20.54	44.76	26.42	59.94	49.94	-15.18	-23.52	Pass
4	3.7281	16.97	8.46	20.55	37.52	29.01	56.00	46.00	-18.48	-16.99	Pass
5	5.4182	18.45	12.27	20.64	39.09	32.91	60.00	50.00	-20.91	-17.09	Pass
6	21.2386	13.68	6.83	20.87	34.55	27.70	60.00	50.00	-25.45	-22.30	Pass

Note: 1. L1 = Line One (Live Line) / L2 = Line Two (Neutral Line).

Job No.:	C170512R02	Date:	2017-6-16
Model No.:	YAS.1117	Time:	10:19:46
Standard:	FCC Class B	Temp.(C)/Hum.(%):	22(C)/48%
Test item:	Conduction test	Test By:	Lily.Wang
Line:	L2	Test Voltage:	AC 120V/60Hz
Model:		Description:	

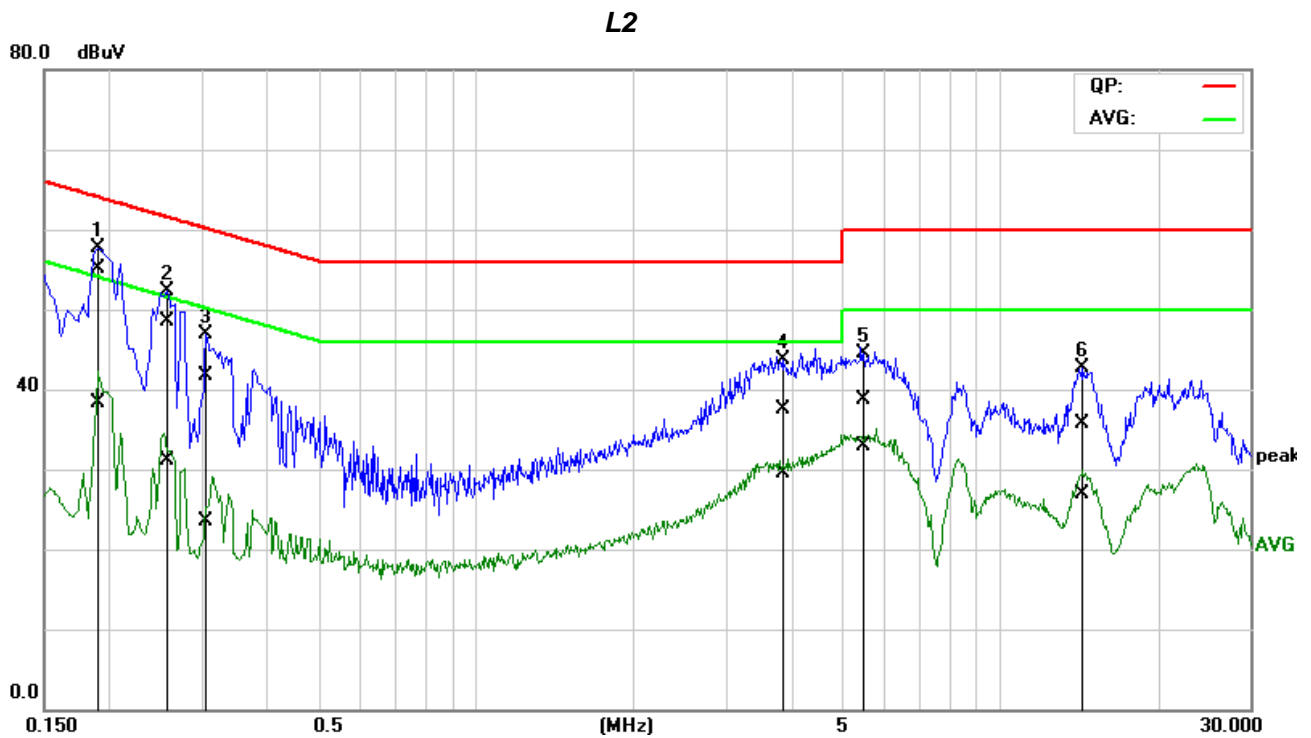

No.	Frequency (MHz)	QuasiPeak reading (dBuV)	Average reading (dBuV)	Correction factor (dB)	QuasiPeak result (dBuV)	Average result (dBuV)	QuasiPeak limit (dBuV)	Average limit (dBuV)	QuasiPeak margin (dB)	Average margin (dB)	Remark
1*	0.1902	34.71	17.93	20.39	55.10	38.32	64.03	54.03	-8.93	-15.71	Pass
2	0.2554	28.15	10.60	20.44	48.59	31.04	61.58	51.58	-12.99	-20.54	Pass
3	0.3047	21.34	3.05	20.46	41.80	23.51	60.11	50.11	-18.31	-26.60	Pass
4	3.7905	16.86	8.79	20.66	37.52	29.45	56.00	46.00	-18.48	-16.55	Pass
5	5.5194	17.95	12.19	20.76	38.71	32.95	60.00	50.00	-21.29	-17.05	Pass
6	14.4270	14.93	6.12	20.82	35.75	26.94	60.00	50.00	-24.25	-23.06	Pass

Note: 1. L1 = Line One (Live Line) / L2 = Line Two (Neutral Line).

Remark:

- 1.The measuring frequencies range between 0.15 MHz and 30 MHz.
- 2.The emissions measured in the frequency range between 0.15 MHz and 30MHz were made with an instrument using Quasi-peak detector and Average detector.
- 3.“---” denotes the emission level was or more than 2dB below the Average limit, and no re-check was made.
- 4.The IF bandwidth of SPA between 0.15MHz and 30MHz was 10KHz. The IF bandwidth of Test Receiver between 0.15MHz and 30MHz was 9kHz.

END OF REPORT