



FCC RADIO TEST REPORT

FCC ID: 2AFIAAM3

Product : android tv box

Trade Name : ugoos

Model Name : AM3

Serial Model : am4,ut5,ut6

Report No. : POCE- 2017020201R

Prepared for

ugoos industrial co,.ltd

Room2502 Wen'an Center, Wenjin Square, Wenjin North Road, Luohu
District, Shenzhen,China

Prepared by

Shenzhen POCE Technology Co.,Ltd.

Room 502, Bldg. 1, Xinghua Garden, Baoan Road Xixiang,
Baoan District,Shenzhen, China

TEST RESULT CERTIFICATION

Applicant's name : ugoos industrial co,.ltd
Address : Room2502 Wen'an Center, Wenjin Square, Wenjin North Road,
Luohu District, Shenzhen,China

Manufacture's Name..... : ugoos industrial co,.ltd
Address : Room2502 Wen'an Center, Wenjin Square, Wenjin North Road,
Luohu District, Shenzhen,China

Product description

Product name : android tv box

Model and/or type reference : AM3

Standards : FCC Part15.247

Test procedure..... ANSI C63.10: 2013

This device described above has been tested by POCE, and the test results show that the equipment under test (EUT) is in compliance with the FCC requirements. And it is applicable only to the tested sample identified in the report.

This report shall not be reproduced except in full, without the written approval of POCE, this document may be altered or revised by POCE, personal only, and shall be noted in the revision of the document.

Date of Test..... :

Date (s) of performance of tests : 10 Feb. 2017 ~26 Feb. 2017

Date of Issue..... : 26 Feb. 2016

Test Result..... : **Pass**

Testing Engineer :



(Ken Li)

Technical Manager :



(Jimmy Yao)

Authorized Signatory :



(Terry Yang)

Table of Contents

	Page
1 . SUMMARY OF TEST RESULTS	5
1.1 TEST FACILITY	6
1.2 MEASUREMENT UNCERTAINTY	6
2 . GENERAL INFORMATION	7
2.1 GENERAL DESCRIPTION OF EUT	7
2.2 DESCRIPTION OF TEST MODES	9
2.3 BLOCK DIGRAM SHOWING THE CONFIGURATION OF SYSTEM TESTED	10
2.4 DESCRIPTION OF SUPPORT UNITS(CONDUCTED MODE)	11
2.5 EQUIPMENTS LIST FOR ALL TEST ITEMS	12
3 . EMC EMISSION TEST	13
3.1 CONDUCTED EMISSION MEASUREMENT	13
3.1.1 POWER LINE CONDUCTED EMISSION LIMITS	13
3.1.2 TEST PROCEDURE	14
3.1.3 DEVIATION FROM TEST STANDARD	14
3.1.4 TEST SETUP	14
3.1.5 EUT OPERATING CONDITIONS	14
3.1.6 TEST RESULTS	15
3.2 RADIATED EMISSION MEASUREMENT	17
3.2.1 RADIATED EMISSION LIMITS	17
3.2.2 TEST PROCEDURE	18
3.2.3 DEVIATION FROM TEST STANDARD	18
3.2.4 TEST SETUP	19
3.2.5 EUT OPERATING CONDITIONS	20
3.2.6 TEST RESULTS (BETWEEN 9KHZ – 30 MHZ)	21
3.2.7 TEST RESULTS (BETWEEN 30MHZ – 1GHZ)	22
3.2.8 TEST RESULTS (ABOVE 1000 MHZ)	24
4 . POWER SPECTRAL DENSITY TEST	25
4.1 APPLIED PROCEDURES / LIMIT	25
4.1.1 TEST PROCEDURE	25
4.1.2 DEVIATION FROM STANDARD	25
4.1.3 TEST SETUP	25
4.1.4 EUT OPERATION CONDITIONS	25
4.1.5 TEST RESULTS	26
5 . BANDWIDTH TEST	34
5.1 APPLIED PROCEDURES / LIMIT	34
5.1.1 TEST PROCEDURE	34

Table of Contents

	Page
5.1.2 DEVIATION FROM STANDARD	34
5.1.3 TEST SETUP	34
5.1.4 EUT OPERATION CONDITIONS	34
5.1.5 TEST RESULTS	35
6 . PEAK OUTPUT POWER TEST	43
6.1 APPLIED PROCEDURES / LIMIT	43
6.1.1 TEST PROCEDURE	43
6.1.2 DEVIATION FROM STANDARD	43
6.1.3 TEST SETUP	43
6.1.4 EUT OPERATION CONDITIONS	43
6.1.5 TEST RESULTS	44
7 . 100 KHZ BANDWIDTH OF FREQUENCY BAND EDGE	45
7.1 DEVIATION FROM STANDARD	45
7.2 TEST SETUP	45
7.3 EUT OPERATION CONDITIONS	45
7.4 TEST RESULTS	46
8 . ANTENNA REQUIREMENT	52
8.1 STANDARD REQUIREMENT	52
8.2 EUT ANTENNA	52

1. SUMMARY OF TEST RESULTS

Test procedures according to the technical standards:

FCC Part15 (15.247) , Subpart C			
Standard Section	Test Item	Judgment	Remark
15.207	Conducted Emission	PASS	
15.247 (a)(2)	6dB Bandwidth	PASS	
15.247 (b)	Peak Output Power	PASS	
15.247 (c)	Radiated Spurious Emission	PASS	
15.247 (d)	Power Spectral Density	PASS	
15.205	Band Edge Emission	PASS	
15.203	Antenna Requirement	PASS	

NOTE:

(1) "N/A" denotes test is not applicable in this Test Report

1.1 TEST FACILITY

Shenzhen POCE Technology Co.,Ltd.

Add.: Room 502, Bldg. 1, Xinghua Garden, Baoan Road Xixiang, Baoan District, Shenzhen, China

FCC-Registration No.: 222278

1.2 MEASUREMENT UNCERTAINTY

The reported uncertainty of measurement $y \pm U$, where expanded uncertainty U is based on a standard uncertainty multiplied by a coverage factor of $k=2$, providing a level of confidence of approximately **95 %**.

No.	Item	Uncertainty
1	Conducted Emission Test	$\pm 1.38\text{dB}$
2	RF power,conducted	$\pm 0.16\text{dB}$
3	Spurious emissions,conducted	$\pm 0.21\text{dB}$
4	All emissions,radiated(<1G)	$\pm 4.68\text{dB}$
5	All emissions,radiated(>1G)	$\pm 4.89\text{dB}$
6	Temperature	$\pm 0.5^{\circ}\text{C}$
7	Humidity	$\pm 2\%$

2. GENERAL INFORMATION

2.1 GENERAL DESCRIPTION OF EUT

Equipment	android tv box	
Trade Name	ugoos	
Model Name	AM3	
Serial Model	am4,ut5,ut6	
Model Difference	N/A	
Product Description	The EUT is a android tv box	
	Operation Frequency:	802.11b/g/n(20MHz):2412~2462 MHz 802.11n(40MHz):2422~2452
	Modulation Type:	CCK/OFDM/DBPSK/DAPSK
	Bit Rate of Transmitter	802.11b:11/5.5/2/1 Mbps 802.11g:54/48/36/24/18/12/9/6Mbps 802.11n(20MHz/40MHz):150/144.44/130/117/115.56/104/86.67/78/52/6.5Mbps
	Number Of Channel	802.11b/g/n20MHz:11CH 802.11n40MHz:7CH
	Antenna Designation:	Please see Note 3.
	Output Power(Conducted):	802.11b: 16.95 dBm (Max.) 802.11g: 13.87 dBm (Max.) 802.11n(20M) : 13.05 dBm (Max.) 802.11n(40M) : 12.94 dBm (Max.)
	Channel List	Please refer to the Note 2.
Adapter	\Input: AC 100-240V, 50/60Hz, 0.5A Output:DC 12V, 0.55A	

Note:

1. For a more detailed features description, please refer to the manufacturer's specifications or the User's Manual.

2.

Channel List for 802.11b/g/n(20)							
Channel	Frequency (MHz)	Channel	Frequency (MHz)	Channel	Frequency (MHz)	Channel	Frequency (MHz)
01	2412	04	2427	07	2442	10	2457
02	2417	05	2432	08	2447	11	2462
03	2422	06	2437	09	2452		

Channel List for 802.11n(40MHz)							
Channel	Frequency (MHz)	Channel	Frequency (MHz)	Channel	Frequency (MHz)	Channel	Frequency (MHz)
03	2422	06	2437	09	2452		
04	2427	07	2442				
05	2432	08	2447				

3.

Table for Filed Antenna

Ant	Brand	Model Name	Antenna Type	Connector	Gain (dBi)	NOTE
A	N/A	N/A	Internal Antenna	N/A	2.11	Wifi Antenna

2.2 DESCRIPTION OF TEST MODES

To investigate the maximum EMI emission characteristics generates from EUT, the test system was pre-scanning tested base on the consideration of following EUT operation mode or test configuration mode which possible have effect on EMI emission level. Each of these EUT operation mode(s) or test configuration mode(s) mentioned above was evaluated respectively.

Pretest Mode	Description
Mode 1	802.11b CH1/ CH6/ CH11
Mode 2	802.11g CH1/ CH6/ CH11
Mode 3	802.11n20 CH1/ CH6/ CH11
Mode 4	802.11n40 CH3/ CH6/ CH9
Mode 5	Link Mode

For Conducted Emission	
Final Test Mode	Description
Mode 5	Link Mode

For Radiated Emission	
Final Test Mode	Description
Mode 1	802.11b CH1/ CH6/ CH11
Mode 2	802.11g CH1/ CH6/ CH11
Mode 3	802.11n20 CH1/ CH6/ CH11
Mode 4	802.11n40 CH3/ CH6/ CH9
Mode 5	Link Mode

Note:

- (1) The measurements are performed at the highest, middle, lowest available channels.
- (2) The measurements are performed at all Bit Rate of Transmitter, the worst data was reported

2.3 BLOCK DIGRAM SHOWING THE CONFIGURATION OF SYSTEM TESTED

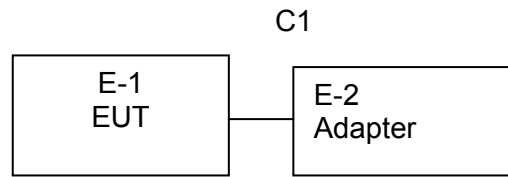

2.4 DESCRIPTION OF SUPPORT UNITS(CONDUCTED MODE)

The EUT has been tested as an independent unit together with other necessary accessories or support units. The following support units or accessories were used to form a representative test configuration during the tests.

Item	Equipment	Brand	Model/Type No.	Series No.	Note
E-1	android tv box	N/A	AM3	N/A	EUT
E-2	adapter	N/A	AM3	N/A	

Item	Shielded Type	Ferrite Core	Length	Note
C1	No	No	0.8	

Note:

- (1) The support equipment was authorized by Declaration of Confirmation.
- (2) For detachable type I/O cable should be specified the length in cm in 『Length』 column.

2.5 EQUIPMENTS LIST FOR ALL TEST ITEMS

Radiation Test equipment

Item	Kind of Equipment	Manufacturer	Type No.	Serial No.	Last calibration	Calibrated until	Calibration period
1	Spectrum Analyzer	Agilent	E4407B	MY45108040	2016.07.06	2017.07.05	1 year
2	Test Receiver	R&S	ESPI	101318	2016.06.07	2017.06.06	1 year
3	Bilog Antenna	TESEQ	CBL6111D	31216	2016.07.06	2017.07.05	1 year
4	50Ω Coaxial Switch	Anritsu	MP59B	6200264416	2016.06.07	2017.06.06	1 year
5	Spectrum Analyzer	ADVANTEST	R3132	150900201	2016.06.07	2017.06.06	1 year
6	Horn Antenna	EM	EM-AH-10180	2011071402	2016.07.06	2017.07.05	1 year
7	Horn Ant	Schwarzbeck	BBHA 9170	9170-181	2016.07.06	2017.07.05	1 year
8	Amplifier	EM	EM-30180	060538	2016.12.22	2017.12.21	1 year
9	Loop Antenna	ARA	PLA-1030/B	1029	2016.06.08	2017.06.07	1 year
10	Power Meter	R&S	NRVS	100696	2016.07.06	2017.07.05	1 year
11	Power Sensor	R&S	URV5-Z4	0395.1619.05	2016.07.06	2017.07.05	1 year
12	Signal Analyzer	Agilent	N9020A	MY49100060	2016.07.06	2017.07.05	1 year

Conduction Test equipment

Item	Kind of Equipment	Manufacturer	Type No.	Serial No.	Last calibration	Calibrated until	Calibration period
1	Test Receiver	R&S	ESCI	101160	2016.06.06	2017.06.05	1 year
2	LISN	R&S	ENV216	101313	2016.08.24	2017.08.23	1 year
3	LISN	EMCO	3816/2	00042990	2016.08.24	2017.08.23	1 year
4	50Ω Coaxial Switch	Anritsu	MP59B	6200264417	2016.06.07	2017.06.06	1 year
5	Passive Voltage Probe	R&S	ESH2-Z3	100196	2016.06.07	2017.06.06	1 year
6	Absorbing clamp	R&S	MOS-21	100423	2016.06.08	2017.06.07	1 year

3. EMC EMISSION TEST

3.1 CONDUCTED EMISSION MEASUREMENT

3.1.1 POWER LINE CONDUCTED EMISSION Limits (Frequency Range 150KHz-30MHz)

FREQUENCY (MHz)	Class A (dBuV)		Class B (dBuV)		Standard
	Quasi-peak	Average	Quasi-peak	Average	
0.15 -0.5	79.00	66.00	66 - 56 *	56 - 46 *	CISPR
0.50 -5.0	73.00	60.00	56.00	46.00	CISPR
5.0 -30.0	73.00	60.00	60.00	50.00	CISPR

0.15 -0.5	79.00	66.00	66 - 56 *	56 - 46 *	FCC
0.50 -5.0	73.00	60.00	56.00	46.00	FCC
5.0 -30.0	73.00	60.00	60.00	50.00	FCC

Note:

- (1) The tighter limit applies at the band edges.
- (2) The limit of " * " marked band means the limitation decreases linearly with the logarithm of the frequency in the range.

The following table is the setting of the receiver

Receiver Parameters	Setting
Attenuation	10 dB
Start Frequency	0.15 MHz
Stop Frequency	30 MHz
IF Bandwidth	9 kHz

3.1.2 TEST PROCEDURE

- a. The EUT was placed 0.8 meters from the horizontal ground plane with EUT being connected to the power mains through a line impedance stabilization network (LISN). All other support equipments powered from additional LISN(s). The LISN provide 50 Ohm/ 50uH of coupling impedance for the measuring instrument.
- b. Interconnecting cables that hang closer than 40 cm to the ground plane shall be folded back and forth in the center forming a bundle 30 to 40 cm long.
- c. I/O cables that are not connected to a peripheral shall be bundled in the center. The end of the cable may be terminated, if required, using the correct terminating impedance. The overall length shall not exceed 1 m.
- d. LISN at least 80 cm from nearest part of EUT chassis.
- e. For the actual test configuration, please refer to the related Item –EUT Test Photos.

3.1.3 DEVIATION FROM TEST STANDARD

No deviation

3.1.4 TEST SETUP

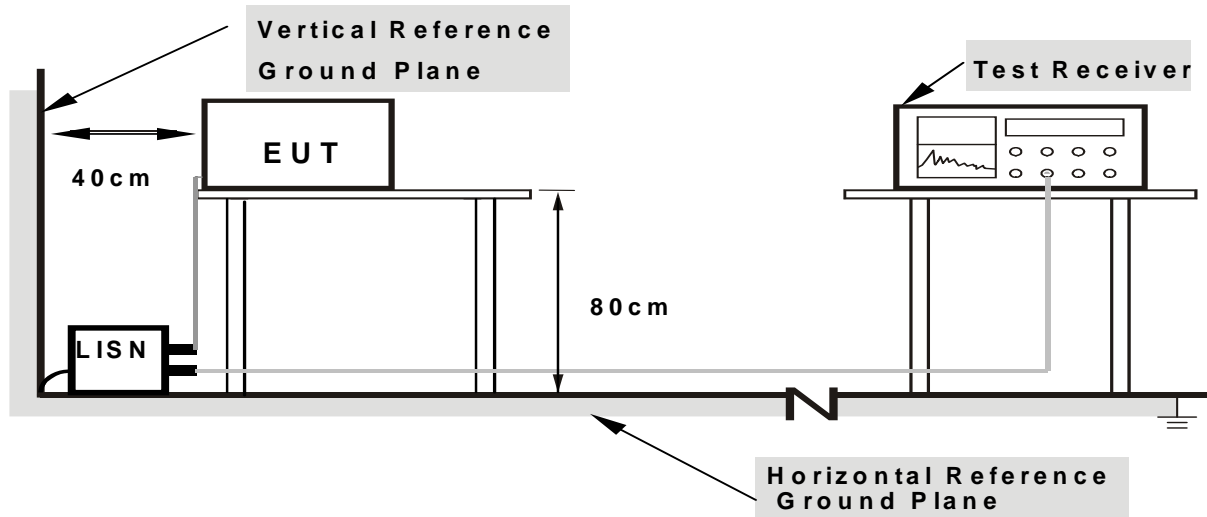

Note: 1.Support units were connected to second LISN.

2.Both of LISNs (AMN) are 80 cm from EUT and at least 80 from other units and other metal planes

3.1.5 EUT OPERATING CONDITIONS

The EUT was configured for testing in a typical fashion (as a customer would normally use it). The EUT has been programmed to continuously transmit during test. This operating condition was tested and used to collect the included data.

3.1.6 TEST RESULTS

EUT :	android tv box	Model Name. :	AM3
Temperature :	26 °C	Relative Humidity :	54%
Pressure :	1010hPa	Phase :	L
Test Voltage :	AC 120V/60Hz	Test Mode :	Mode 5

Frequency (MHz)	Meter Reading (dBμV)	Factor (dB)	Emission Level (dBμV)	Limits (dBμV)	Margin (dB)	Detector Type
0.1539	35.59	11.43	47.02	65.78	-18.76	QP
0.1539	17.53	11.43	28.96	55.78	-26.82	AVG
0.2059	29.22	10.69	39.91	63.37	-23.46	QP
0.2059	7.91	10.69	18.60	53.37	-34.77	AVG
0.4500	27.65	10.64	38.29	56.87	-18.58	QP
0.4500	14.62	10.64	25.26	46.87	-21.61	AVG
1.2019	26.16	10.52	36.68	56.00	-19.32	QP
1.2019	15.04	10.52	25.56	46.00	-20.44	AVG
2.1179	25.79	10.52	36.31	56.00	-19.69	QP
2.1179	12.29	10.52	22.81	46.00	-23.19	AVG
13.1418	27.15	10.89	38.04	60.00	-21.96	QP
13.1418	16.31	10.89	27.20	50.00	-22.80	AVG

Remark:

1. All readings are Quasi-Peak and Average values.
2. Factor = Insertion Loss + Cable Loss.

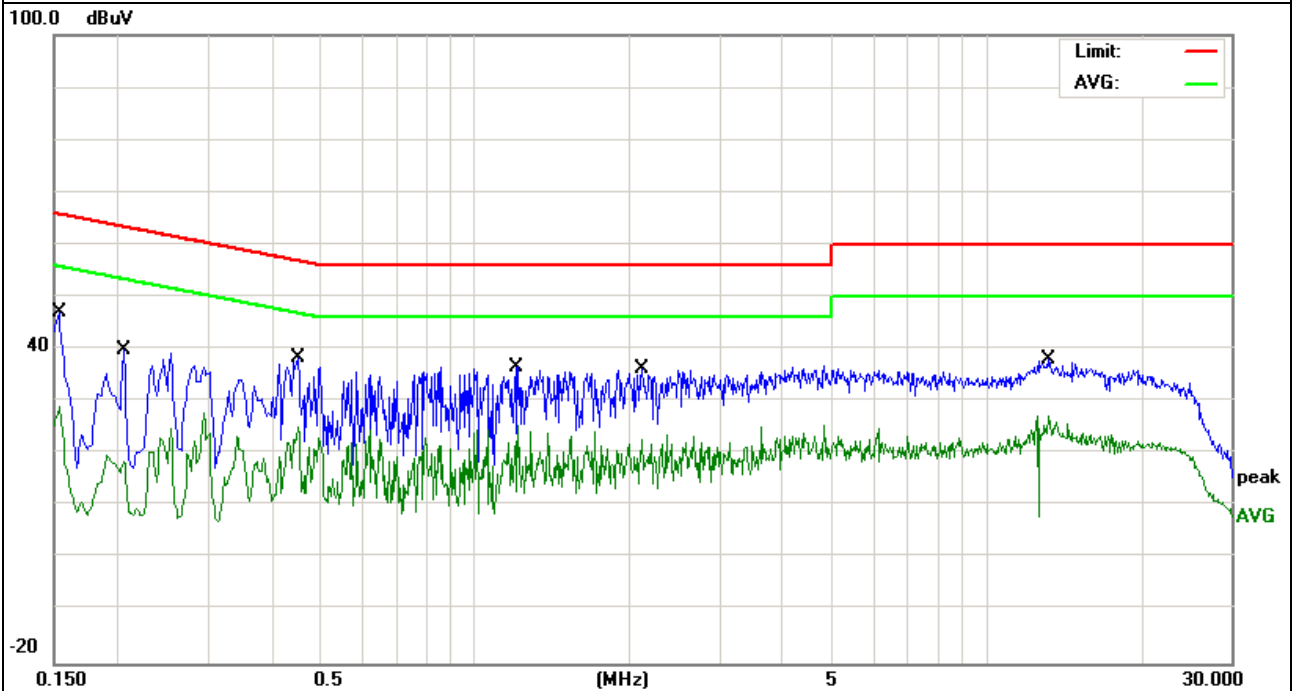

EUT :	android tv box	Model Name. :	AM3
Temperature :	26 °C	Relative Humidity :	54%
Pressure :	1010hPa	Phase :	L
Test Voltage :	AC 120V/60Hz	Test Mode :	Mode 4

Frequency (MHz)	Meter Reading (dBμV)	Factor (dB)	Emission Level (dBμV)	Limits (dBμV)	Margin (dB)	Detector Type
0.1539	35.59	11.43	47.02	65.78	-18.76	QP
0.1539	17.53	11.43	28.96	55.78	-26.82	AVG
0.2058	29.22	10.69	39.91	63.37	-23.46	QP
0.2058	7.91	10.69	18.60	53.37	-34.77	AVG
0.4500	27.65	10.64	38.29	56.87	-18.58	QP
0.4500	14.62	10.64	25.26	46.87	-21.61	AVG
1.2018	26.16	10.52	36.68	56.00	-19.32	QP
1.2018	15.04	10.52	25.56	46.00	-20.44	AVG
2.6299	25.40	10.54	35.94	56.00	-20.06	QP
2.6699	12.95	10.54	23.49	46.00	-22.51	AVG
13.1417	27.15	10.89	38.04	60.00	-21.96	QP
13.1417	16.31	10.89	27.20	50.00	-22.80	AVG

Remark:

1. All readings are Quasi-Peak and Average values.
2. Factor = Insertion Loss + Cable Loss.

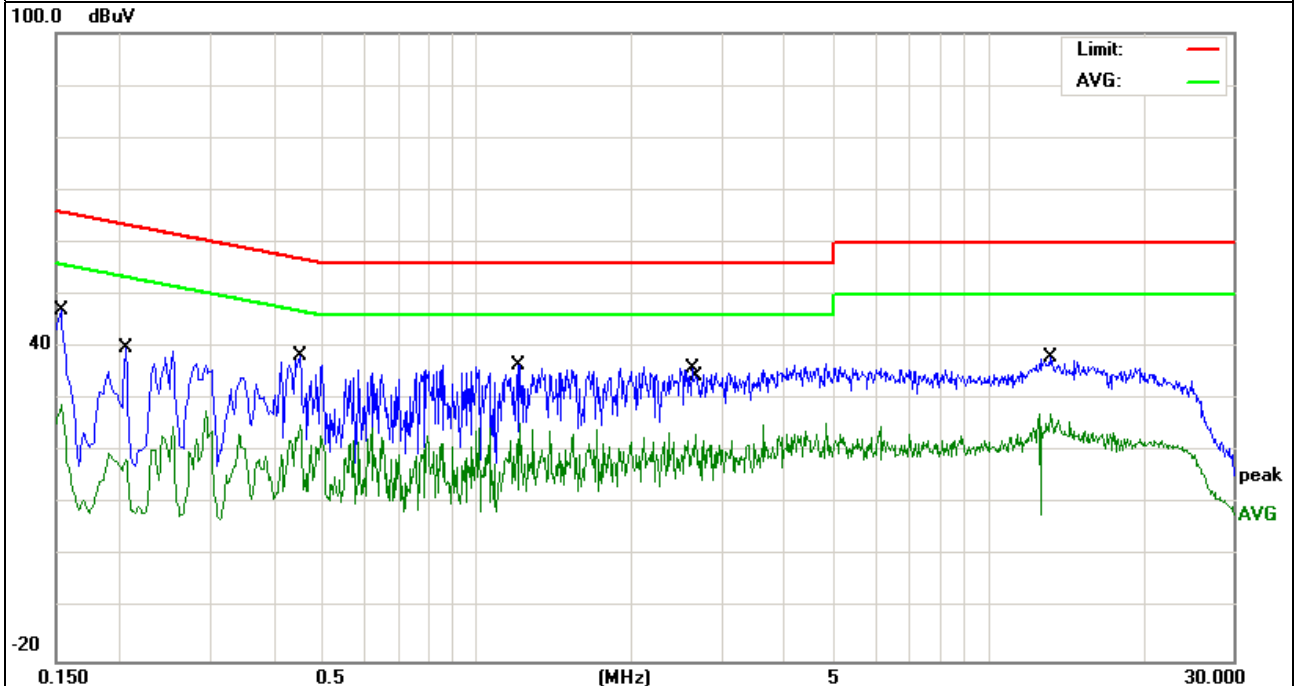

3.2 RADIATED EMISSION MEASUREMENT

3.2.1 RADIATED EMISSION LIMITS (Frequency Range 9kHz-1000MHz)

20dBc in any 100 kHz bandwidth outside the operating frequency band. In case the emission fall within the restricted band specified on 15.205(a), then the 15.209(a) limit in the table below has to be followed.

Frequencies (MHz)	Field Strength (microrvolts/meter)	Measurement Distance (meters)
0.009~0.490	2400/F(KHz)	300
0.490~1.705	24000/F(KHz)	30
1.705~30.0	30	30
30~88	100	3
88~216	150	3
216~960	200	3
Above 960	500	3

Spectrum Parameter	Setting
Attenuation	Auto
Start Frequency	1000 MHz
Stop Frequency	10th carrier harmonic
RB / VB (emission in restricted band)	1 MHz / 1 MHz for Peak, 1 MHz / 10Hz for Average

Receiver Parameter	Setting
Attenuation	Auto
Start ~ Stop Frequency	9kHz~150kHz / RB 200Hz for QP
Start ~ Stop Frequency	150kHz~30MHz / RB 9kHz for QP
Start ~ Stop Frequency	30MHz~1000MHz / RB 120kHz for QP

3.2.2 TEST PROCEDURE

- a. The measuring distance of at 3 m shall be used for measurements at frequency up to 1GHz. For frequencies above 1GHz, any suitable measuring distance may be used.
- b. The EUT was placed on the top of a rotating table 0.8 meters above the ground at a 3 meter open area test site. The table was rotated 360 degrees to determine the position of the highest radiation.
- c. The height of the equipment or of the substitution antenna shall be 0.8 m; the height of the test antenna shall vary between 1 m to 4 m. Both horizontal and vertical polarizations of the antenna are set to make the measurement.
- d. The initial step in collecting conducted emission data is a spectrum analyzer peak detector mode pre-scanning the measurement frequency range. Significant peaks are then marked and then Quasi Peak detector mode re-measured.
- e. If the Peak Mode measured value compliance with and lower than Quasi Peak Mode Limit, the EUT shall be deemed to meet QP Limits and then no additional QP Mode measurement performed.
- f. For the actual test configuration, please refer to the related Item –EUT Test Photos.

Note:

Both horizontal and vertical antenna polarities were tested and performed pretest to three orthogonal axis. The worst case emissions were reported

3.2.3 DEVIATION FROM TEST STANDARD

No deviation

3.2.4 TEST SETUP

(A) Radiated Emission Test-Up Frequency Below 30MHz

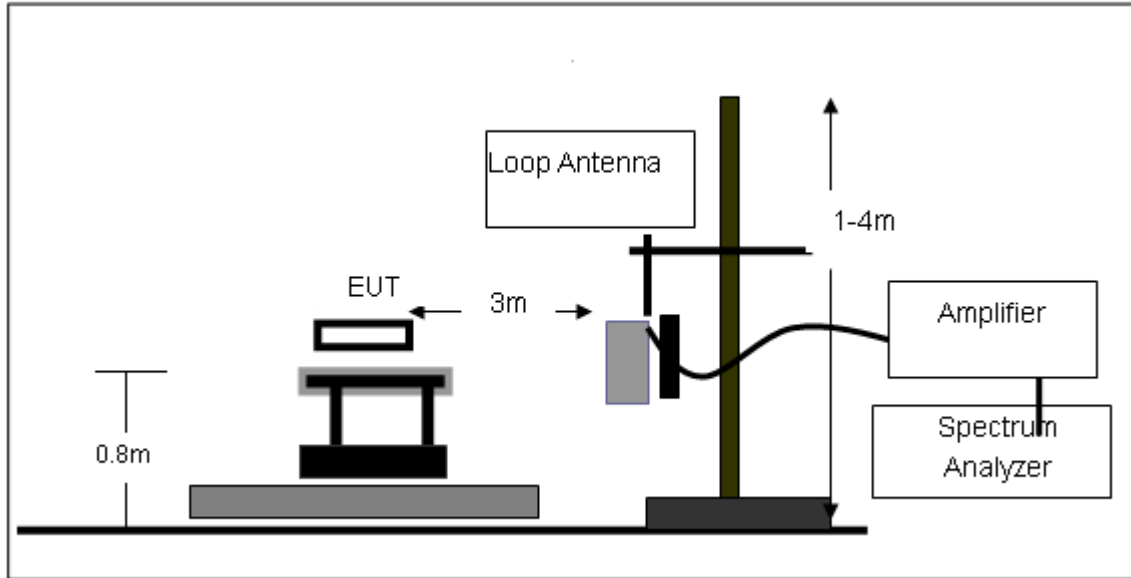

(B) Radiated Emission Test-Up Frequency 30MHz~1GHz

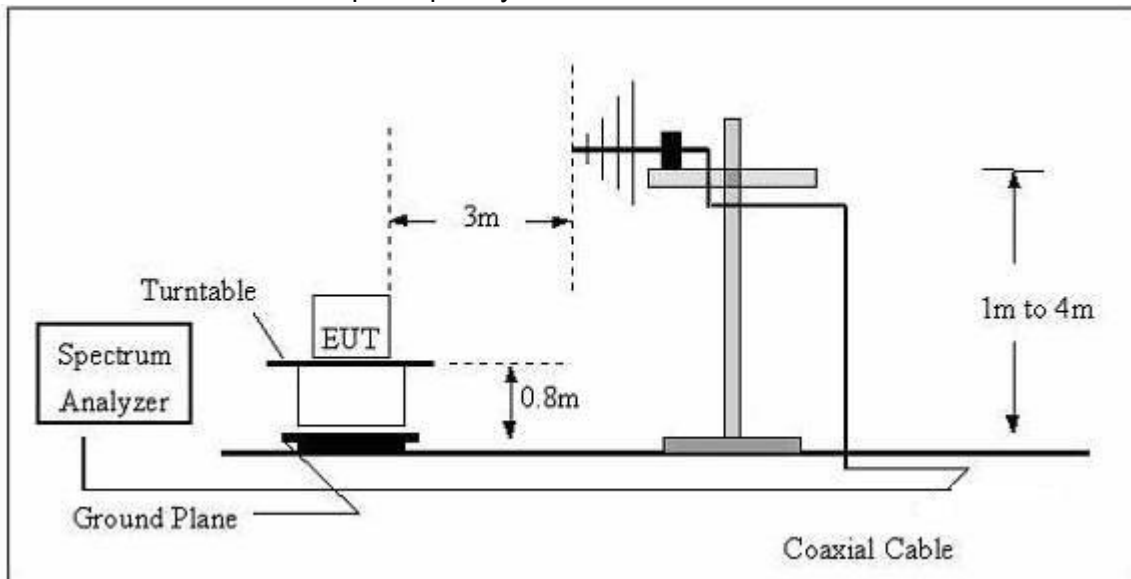

(C) Radiated Emission Test- Up Frequency Above 1GHz

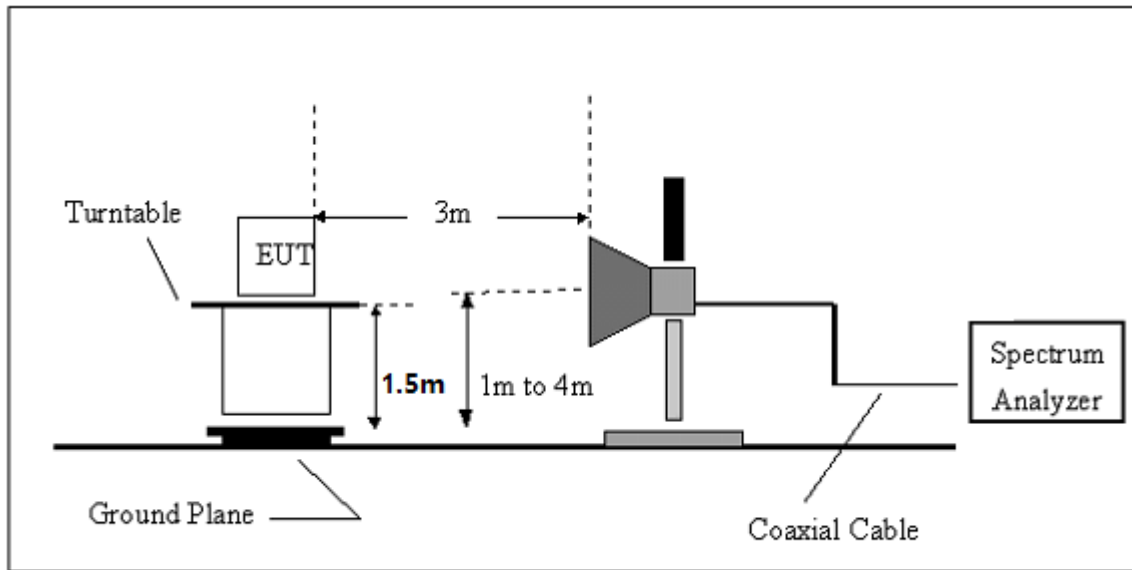

3.2.5 EUT OPERATING CONDITIONS

The EUT tested system was configured as the statements of 2.4 Unless otherwise a special operating condition is specified in the follows during the testing.

3.2.6 TEST RESULTS (BETWEEN 9KHZ – 30 MHZ)

EUT:	android tv box	Model Name. :	AM3
Temperature:	20 °C	Relative Humidity:	48%
Pressure:	1010 hPa	Test Voltage :	AC 120V
Test Mode :	TX	Polarization :	--

Freq. (MHz)	Reading (dBuV/m)	Limit (dBuV/m)	Margin (dB)	State P/F
--	--	--	--	PASS
--	--	--	--	PASS

NOTE:

The amplitude of spurious emissions which are attenuated by more than 20dB below the permissible value has no need to be reported.

Distance extrapolation factor = $40 \log (\text{specific distance}/\text{test distance})$ (dB);

Limit line = specific limits(dBuv) + distance extrapolation factor.

3.2.7 TEST RESULTS (BETWEEN 30MHZ – 1GHZ)

EUT :	android tv box	Model Name :	AM3
Temperature :	20 °C	Relative Humidity :	48%
Pressure :	1010 hPa	Polarization :	Horizontal
Test Voltage :	AC 120V/60Hz		
Test Mode :	TX		

Frequency (MHz)	Meter Reading (dBμV)	Factor (dB)	Emission Level (dBμV/m)	Limits (dBμV/m)	Margin (dB)	Detector Type
37.5479	27.55	-8.73	18.82	40.00	-21.18	QP
53.8818	29.57	-10.93	18.64	40.00	-21.36	QP
183.2005	38.44	-14.73	23.71	43.50	-19.79	QP
215.2678	39.09	-15.77	23.32	43.50	-20.18	QP
253.8367	37.06	-14.09	22.97	46.00	-23.03	QP
339.5888	33.35	-11.57	21.78	46.00	-24.22	QP

Remark:

Factor = Antenna Factor + Cable Loss – Pre-amplifier.

All interfaces was connected, and WIFI TX mode was link.

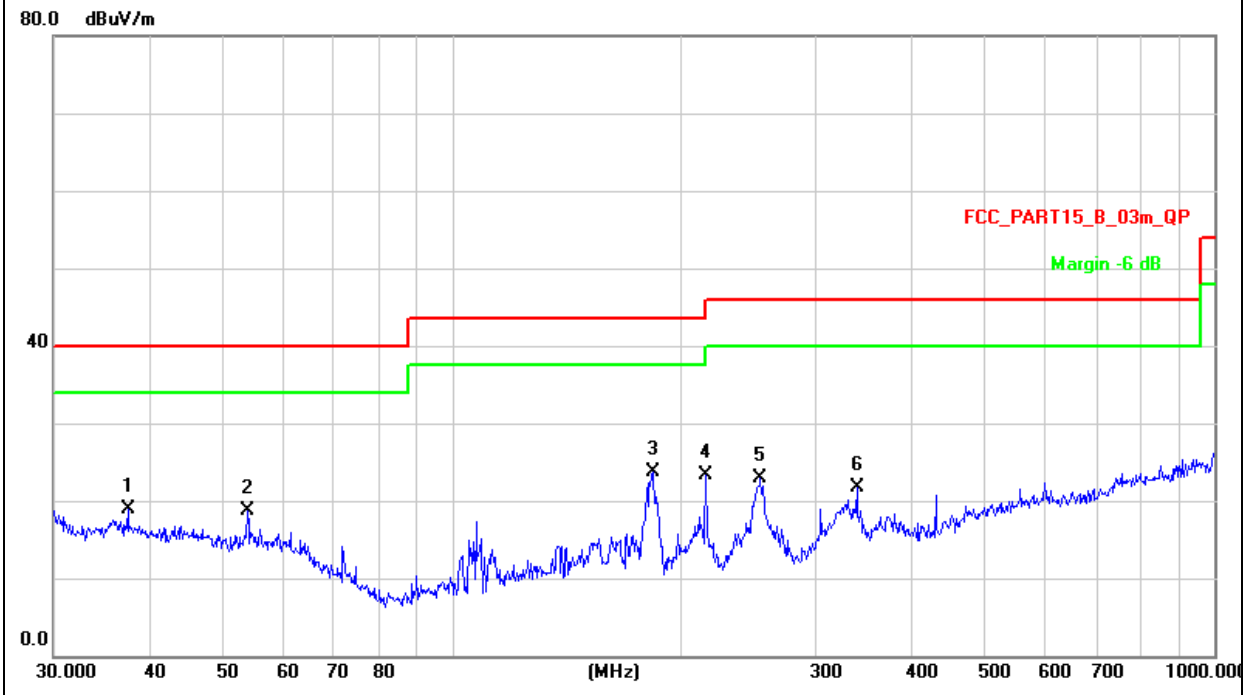

EUT :	android tv box	Model Name :	AM3
Temperature :	20 °C	Relative Humidity :	48%
Pressure :	1010 hPa	Polarization :	Vertical
Test Voltage :	AC 120V/60Hz		
Test Mode :	TX		

Frequency (MHz)	Meter Reading (dBμV)	Factor (dB)	Emission Level (dBμV/m)	Limits (dBμV/m)	Margin (dB)	Detector Type
39.8542	32.98	-8.84	24.14	40.00	-15.86	QP
56.5929	29.25	-11.25	18.00	40.00	-22.00	QP
103.4421	35.13	-16.19	18.94	43.50	-24.56	QP
153.7385	33.34	-12.86	20.48	43.50	-23.02	QP
176.8878	34.26	-14.07	20.19	43.50	-23.31	QP
504.7062	32.25	-8.12	24.13	46.00	-21.87	QP

Remark:
 Factor = Antenna Factor + Cable Loss – Pre-amplifier.
 All interfaces was connected, and WIFI TX mode was link.

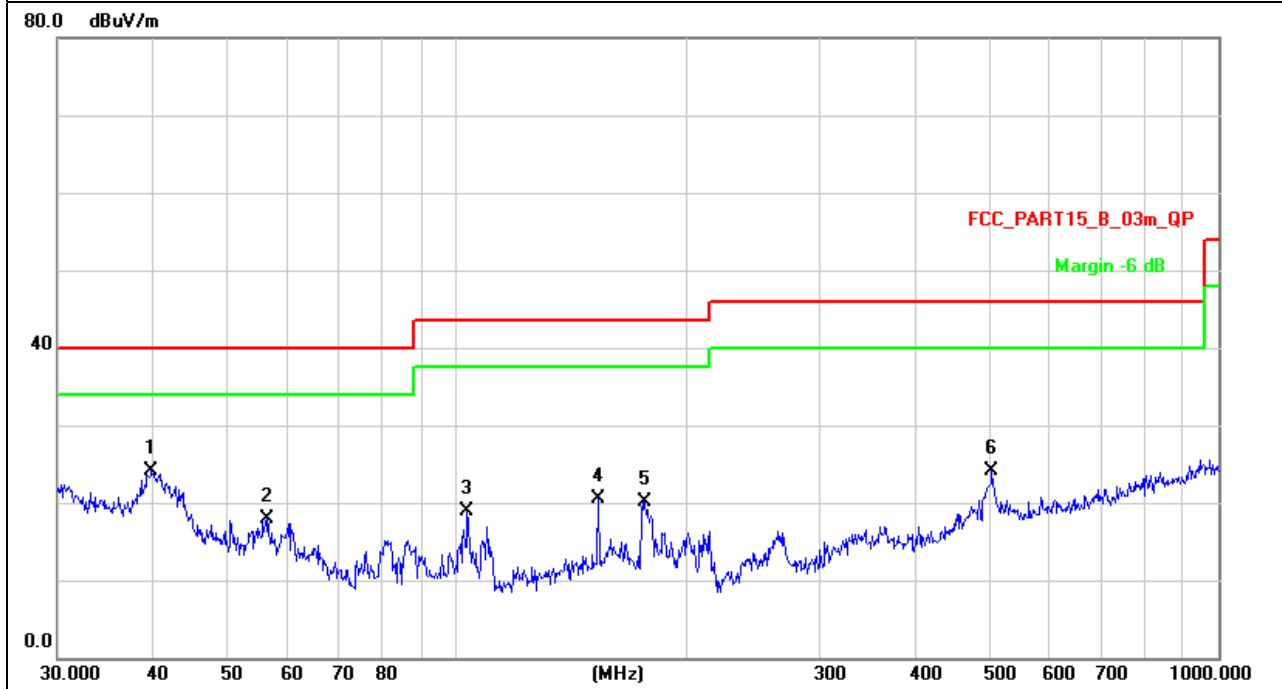

3.2.8 TEST RESULTS (ABOVE 1000 MHZ)

802.11b

Normal Voltage

Polar (H/V)	Frequency	Meter Reading	Factor	Emission Level	Limits	Margin	Detector Type
	(MHz)	(dBuV)	(dB)	(dBuV/m)	(dBuV/m)	(dB)	
Mid Channel (2412 MHz)							
Vertical	2491.777	59.40	-11.65	47.75	74	-26.25	Pk
Horizontal	2498.247	56.30	-12.73	43.57	74	-30.43	Pk
Vertical	4821.884	56.40	-3.60	52.8	74	-21.2	Pk
Horizontal	4821.749	56.40	-9.23	44.54	74	-29.46	Pk
Vertical	1485.838	60.10	-17.10	43.00	74	-31.00	Pk
Vertical	1636.784	59.79	-16.06	43.73	74	-30.27	Pk
Vertical	2095.928	58.60	-11.88	46.72	74	-27.28	Pk
Horizontal	1074.301	60.33	-19.69	40.64	74	-33.36	Pk
Horizontal	1483.178	59.32	-17.09	42.23	74	-31.77	Pk
Horizontal	1895.832	56.34	-14.25	42.09	74	-31.91	Pk
Mid Channel (2437 MHz)							
Vertical	2474.777	56.14	-11.65	44.49	74	-29.51	Pk
Horizontal	2474.144	56.83	-9.37	47.46	74	-26.54	Pk
Vertical	4818.425	56.21	-6.15	47.47	74	-26.53	Pk
Horizontal	4818.979	56.21	-6.83	49.38	74	-24.62	Pk
Vertical	1433.535	63.20	-17.12	46.08	74	-27.92	Pk
Vertical	1636.784	60.53	-16.06	44.47	74	-29.53	Pk
Vertical	2284.166	54.27	-12.83	41.44	74	-32.56	Pk
Horizontal	1280.515	59.93	-17.82	42.11	74	-31.89	Pk
Horizontal	1636.784	58.76	-16.06	42.7	74	-31.3	Pk
Horizontal	1892.438	58.88	-14.28	44.6	74	-29.4	Pk
High Channel (2462 MHz)							
Vertical	2453.883	56.89	-12.91	43.98	74	-30.02	Pk
Horizontal	2453.839	56.89	-11.59	44.65	74	-29.35	Pk
Vertical	4926.325	53.40	-9.22	44.18	74	-29.82	Pk
Horizontal	4926.683	53.40	-3.64	49.62	74	-24.38	Pk
Vertical	1187.688	57.92	-18.27	39.65	74	-34.35	Pk
Vertical	1636.784	56.73	-16.06	40.67	74	-33.33	Pk
Vertical	2084.693	54.32	-11.99	42.33	74	-31.67	Pk
Horizontal	1534.540	56.98	-16.94	40.04	74	-33.96	Pk
Horizontal	1786.985	56.69	-15.04	41.65	74	-32.35	Pk
Horizontal	1892.438	56.57	-14.28	42.29	74	-31.71	Pk

Note: "802.11b" mode is the worst mode.

4. POWER SPECTRAL DENSITY TEST

4.1 APPLIED PROCEDURES / LIMIT

FCC Part15 (15.247) , Subpart C				
Section	Test Item	Limit	Frequency Range (MHz)	Result
15.247	Power Spectral Density	8 dBm (in any 3KHz)	2400-2483.5	PASS

4.1.1 TEST PROCEDURE

1. Set analyzer center frequency to DTS channel center frequency.
2. Set the span to 1.5 times the DTS channel bandwidth.
3. Set the RBW \geq 3 kHz.
4. Set the VBW \geq 3 x RBW.
5. Detector = peak.
6. Sweep time = auto couple.
7. Trace mode = max hold.
8. Allow trace to fully stabilize.
9. Use the peak marker function to determine the maximum amplitude level.
10. If measured value exceeds limit, reduce RBW (no less than 3 kHz) and repeat.

4.1.2 DEVIATION FROM STANDARD

No deviation.

4.1.3 TEST SETUP



4.1.4 EUT OPERATION CONDITIONS

The EUT tested system was configured as the statements of 2.1 Unless otherwise a special operating condition is specified in the follows during the testing.

4.1.5 TEST RESULTS

EUT :	android tv box	Model Name :	AM3
Temperature :	25 °C	Relative Humidity :	60%
Pressure :	1015 hPa	Test Voltage :	AC 120V
Test Mode :	TX b Mode /CH01, CH06, CH11		

Frequency	Power Density (dBm)	Limit (dBm)	Result
2412 MHz	-17.42	8	PASS
2437 MHz	-17.98	8	PASS
2462 MHz	-17.72	8	PASS

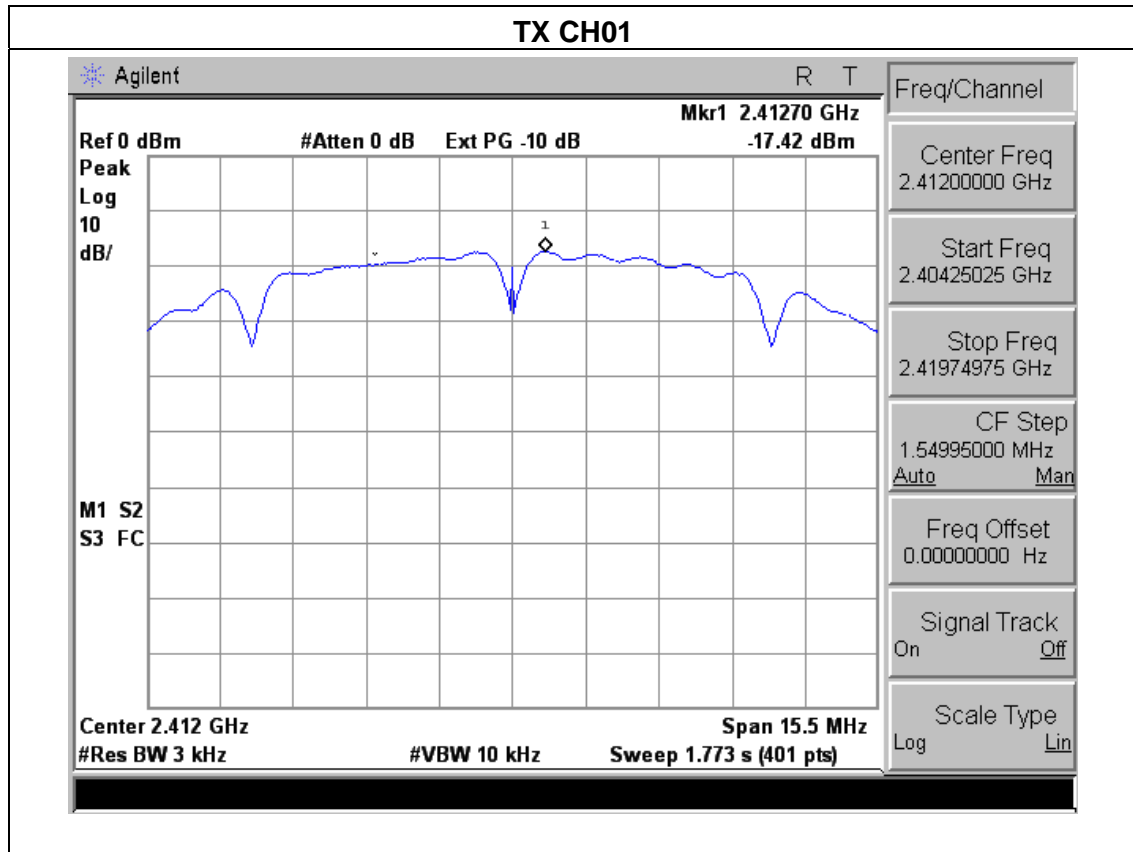

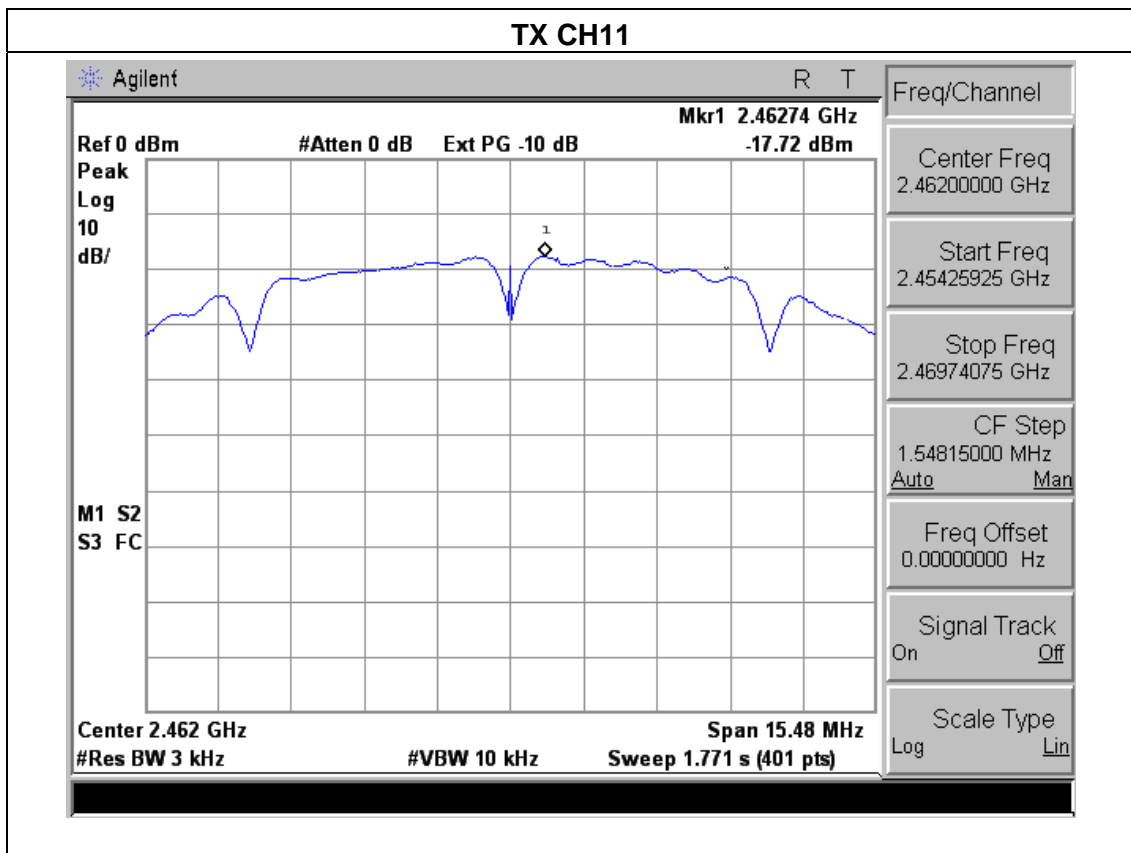
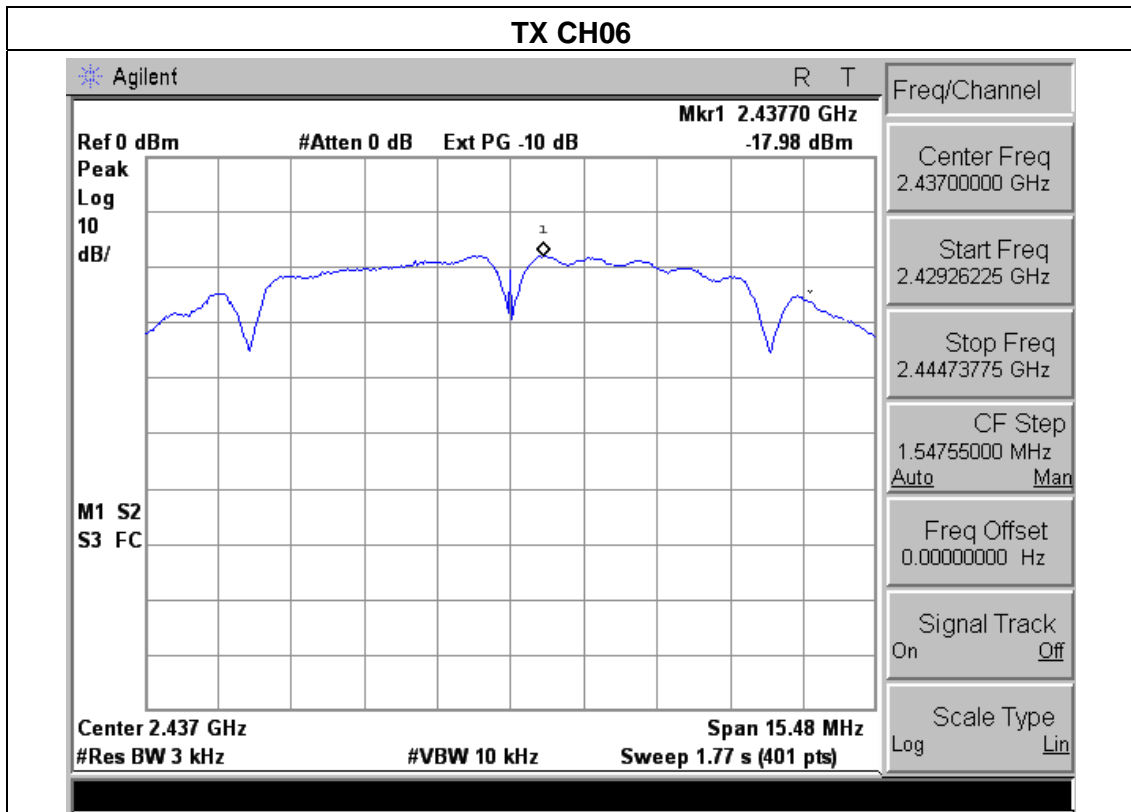

EUT :	android tv box	Model Name :	AM3
Temperature :	25 °C	Relative Humidity :	60%
Pressure :	1015 hPa	Test Voltage :	AC 120V
Test Mode :	TX g Mode /CH01, CH06, CH11		

Frequency	Power Density (dBm)	Limit (dBm)	Result
2412 MHz	-18.64	8	PASS
2437 MHz	-19.17	8	PASS
2462 MHz	-18.43	8	PASS

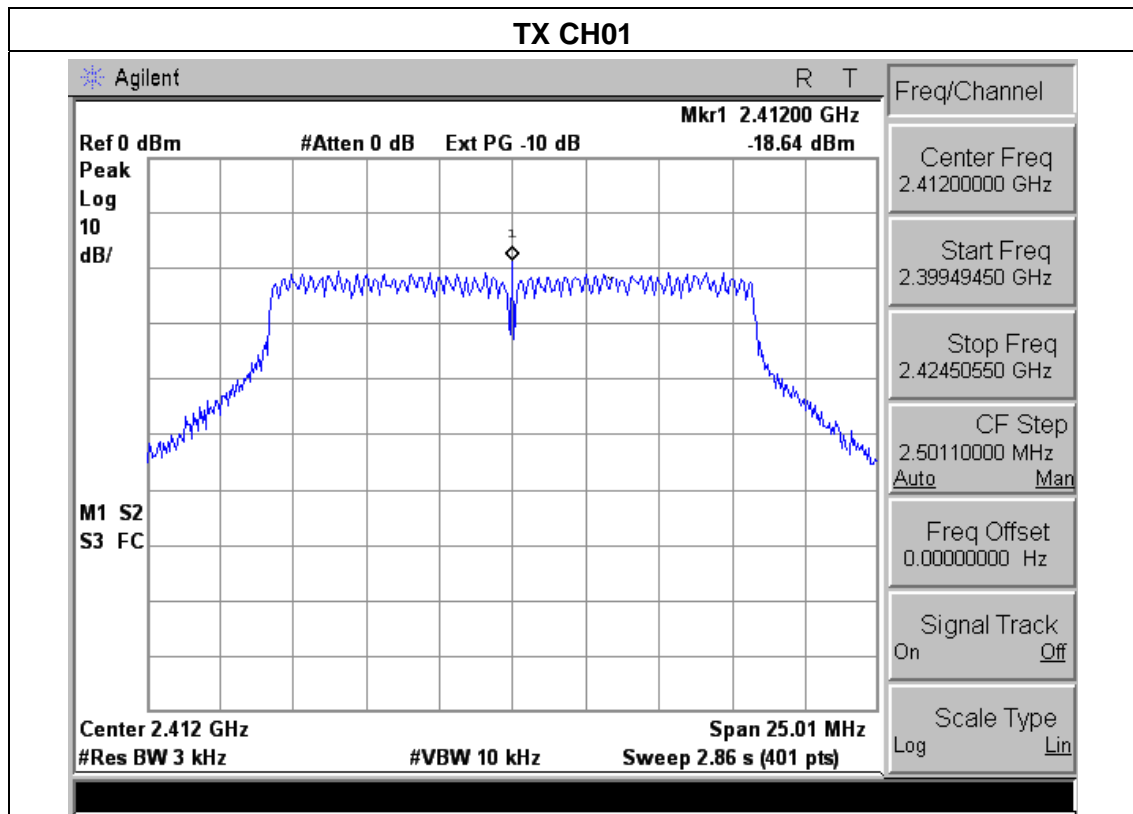

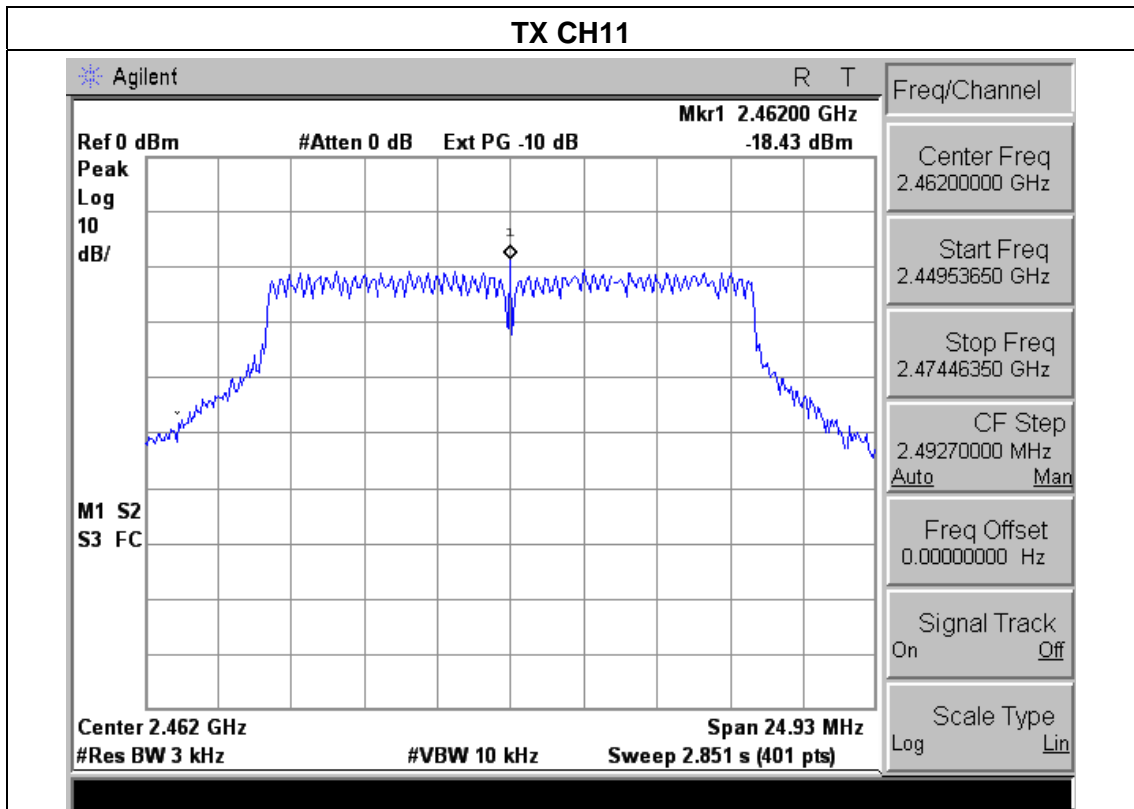
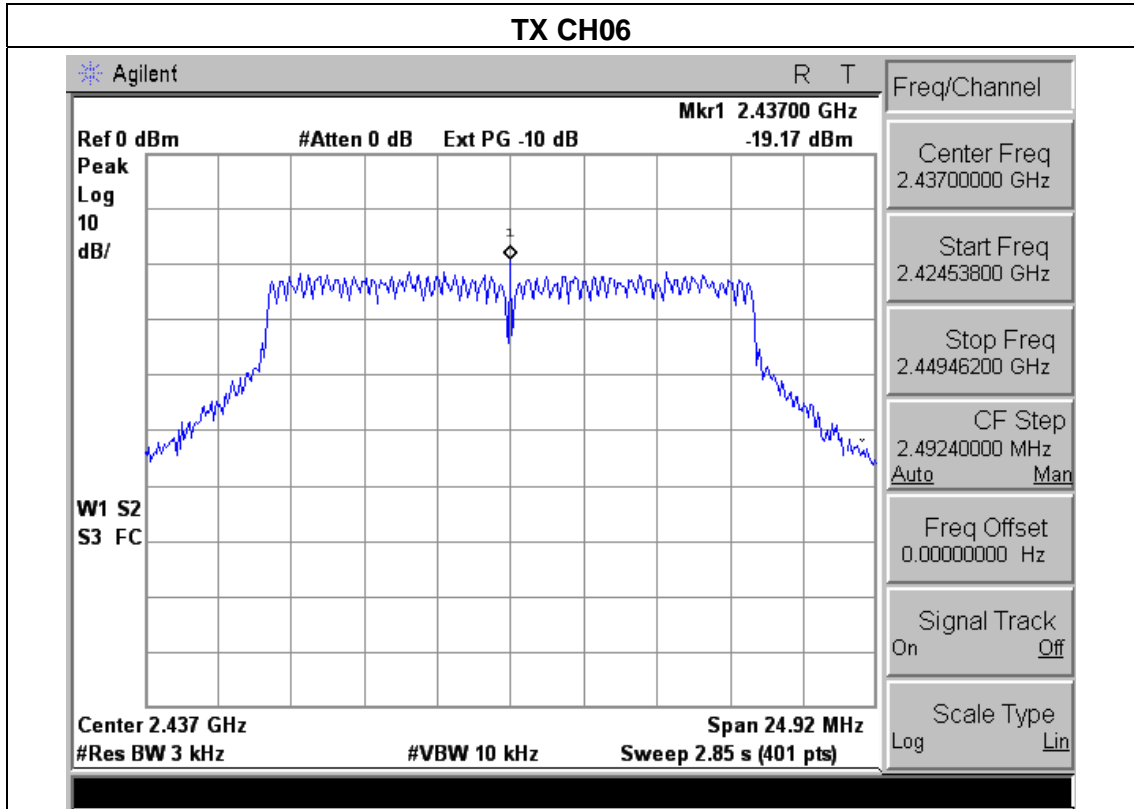

EUT :	android tv box	Model Name :	AM3
Temperature :	25 °C	Relative Humidity :	60%
Pressure :	1015 hPa	Test Voltage :	AC 120V
Test Mode :	TX n Mode(20M) /CH01, CH06, CH11		

Frequency	Power Density A (dBm)	Limit (dBm)	Result
2412 MHz	-18.64	8	PASS
2437 MHz	-19.17	8	PASS
2462 MHz	-18.43	8	PASS

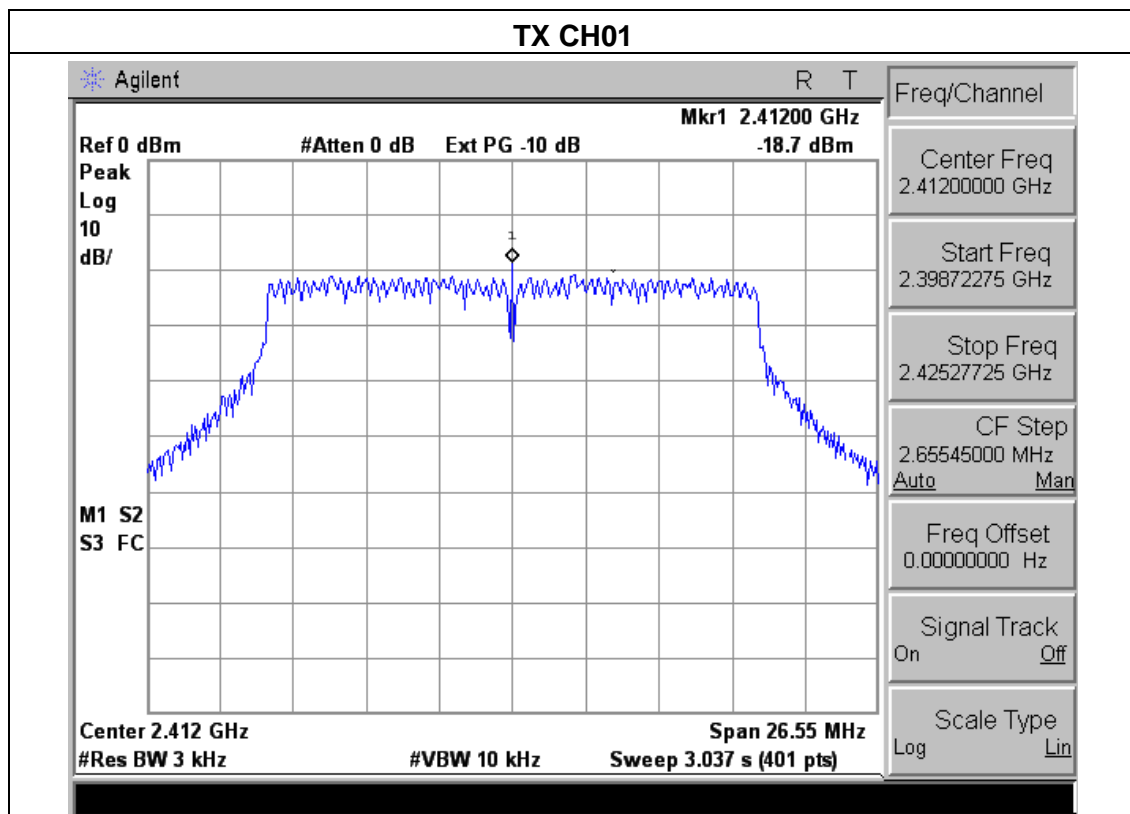

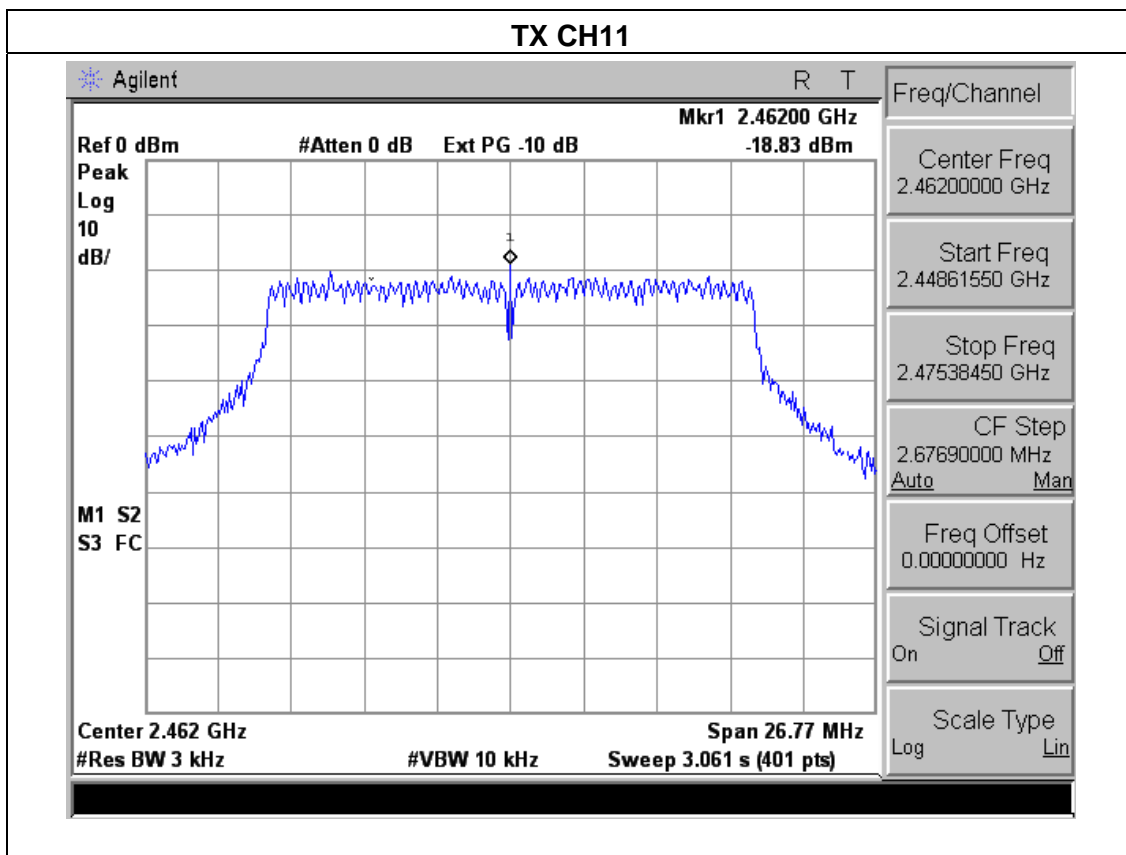
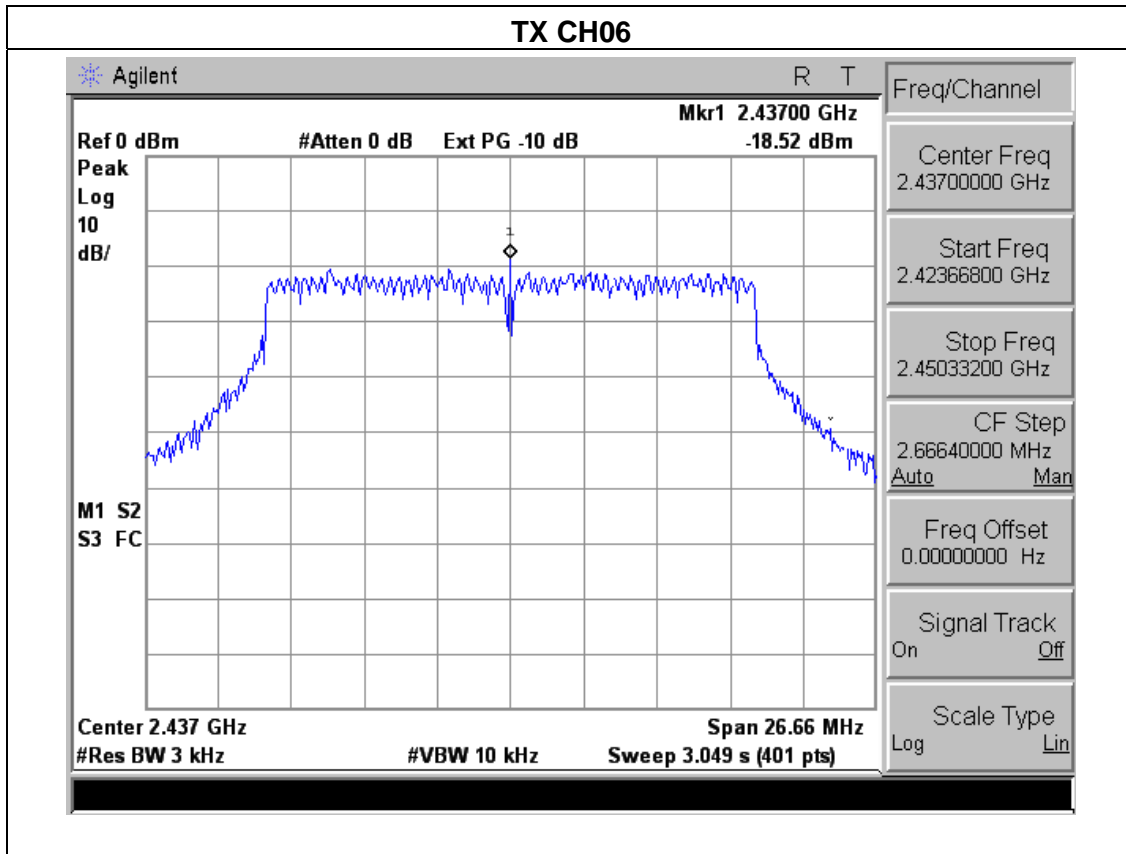

EUT :	android tv box	Model Name :	AM3
Temperature :	25 °C	Relative Humidity :	60%
Pressure :	1015 hPa	Test Voltage :	AC 120V
Test Mode :	TX n Mode(40M) /CH03, CH06, CH09		

Frequency	Power Density (dBm)	Limit (dBm)	Result
2422 MHz	-18.34	8	PASS
2437 MHz	-18.36	8	PASS
2452 MHz	-18.94	8	PASS

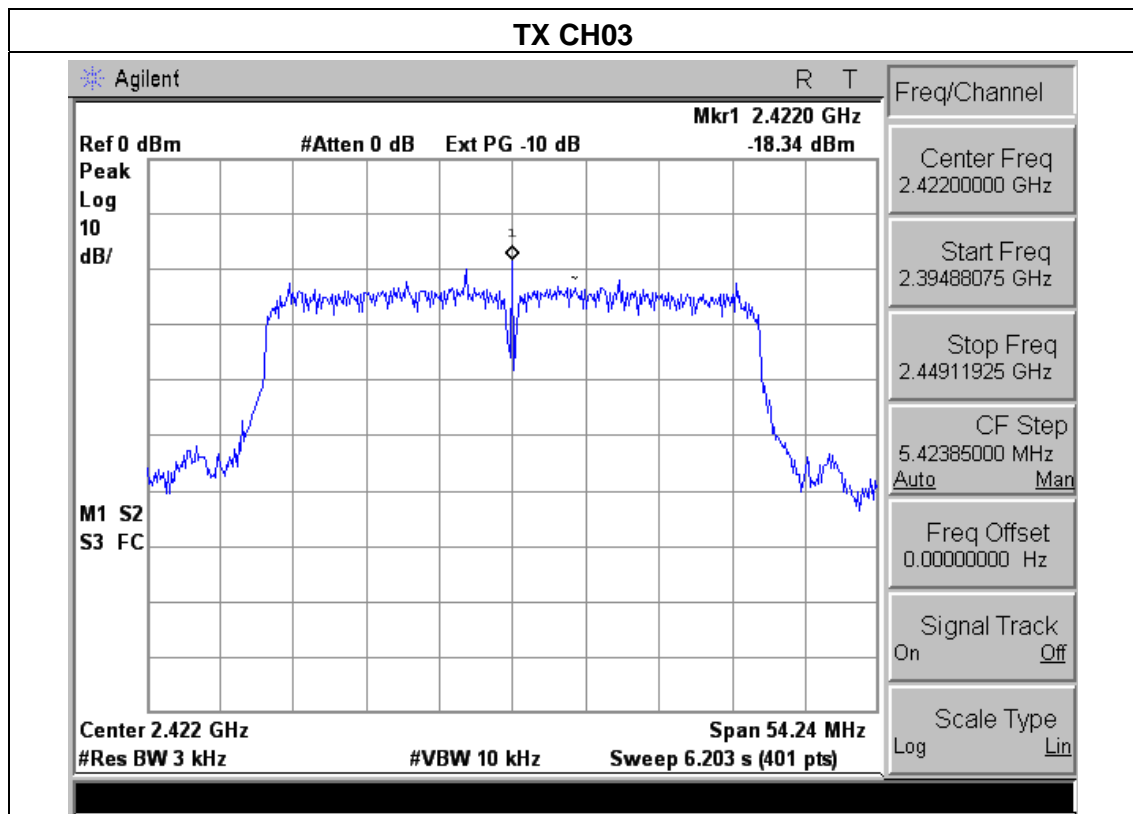

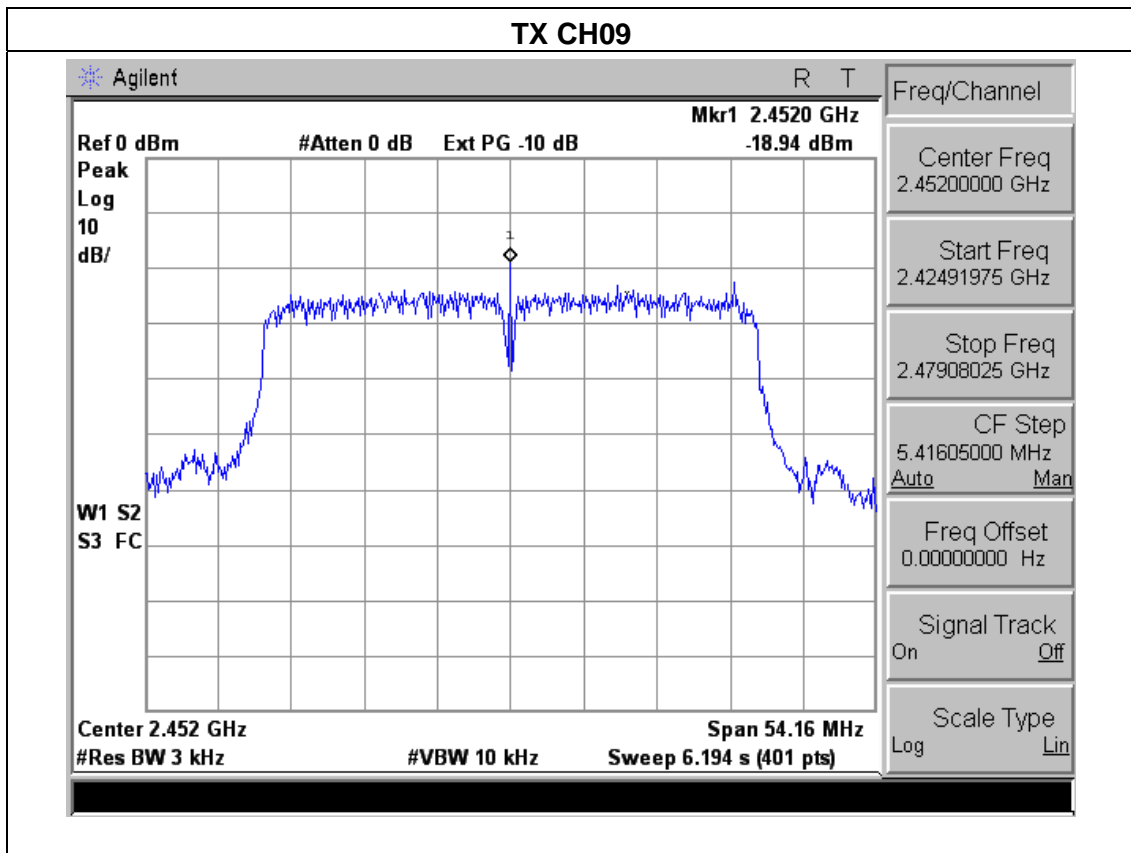
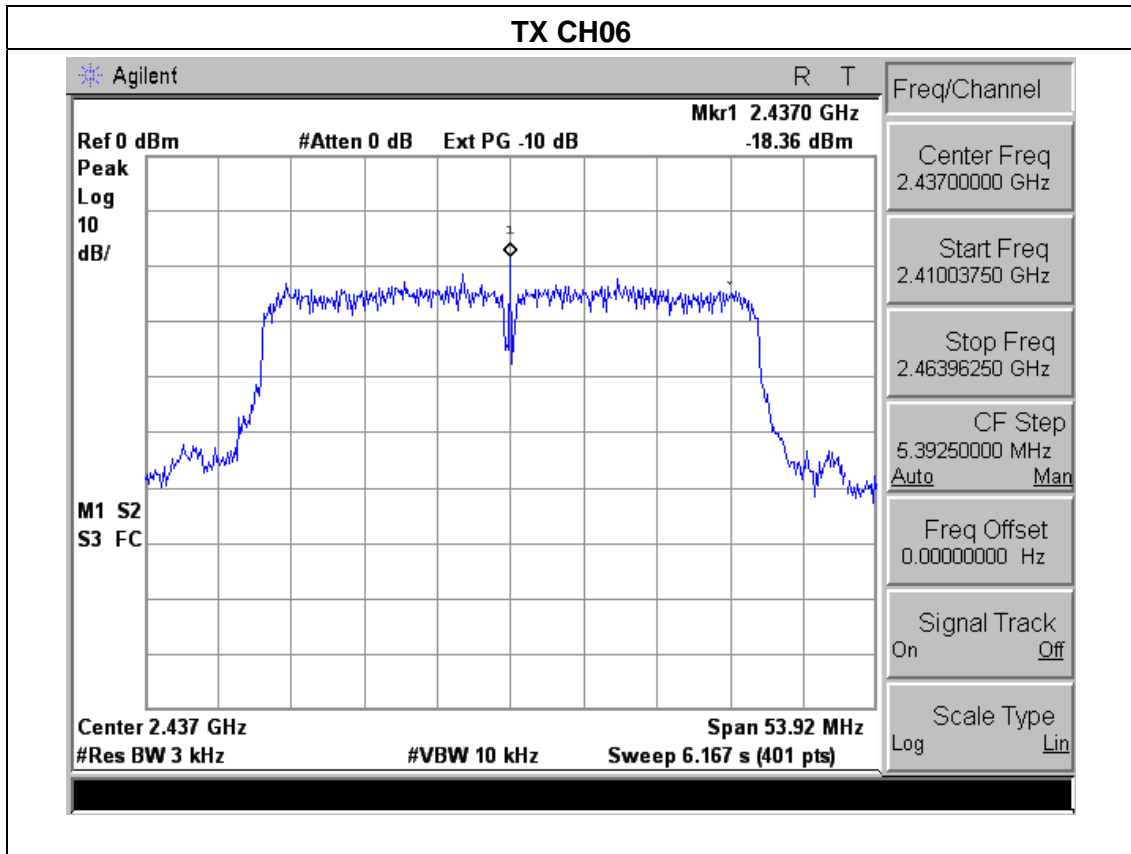

5. BANDWIDTH TEST

5.1 APPLIED PROCEDURES / LIMIT

FCC Part15 (15.247) , Subpart C				
Section	Test Item	Limit	Frequency Range (MHz)	Result
15.247(a)(2)	Bandwidth	$\geq 500\text{KHz}$ (6dB bandwidth)	2400-2483.5	PASS

5.1.1 TEST PROCEDURE

1. Set resolution bandwidth (RBW) = 1-5% or DTS BW, not to exceed 100 kHz.
2. Set the video bandwidth (VBW) $\geq 3 \times$ RBW.
3. Detector = Peak.
4. Trace mode = max hold.
5. Sweep = auto couple.
6. Allow the trace to stabilize.
7. Measure the maximum width of the emission that is constrained by the frequencies associated with the two outermost amplitude points (upper and lower) that are attenuated by 6 dB relative to the maximum level measured in the fundamental emission.

5.1.2 DEVIATION FROM STANDARD

No deviation.

5.1.3 TEST SETUP



5.1.4 EUT OPERATION CONDITIONS

The EUT tested system was configured as the statements of 2.4 Unless otherwise a special operating condition is specified in the follows during the testing.

5.1.5 TEST RESULTS

EUT :	android tv box	Model Name :	AM3
Temperature :	25 °C	Relative Humidity :	60%
Pressure :	1012 hPa	Test Voltage :	AC 120V
Test Mode :	TX b Mode /CH01, CH06, CH11		

Channel	Frequency (MHz)	6dB bandwidth (MHz)	Limit (kHz)	Result
Low	2412	10.33	500	Pass
Middle	2437	10.32	500	Pass
High	2462	10.32	500	Pass

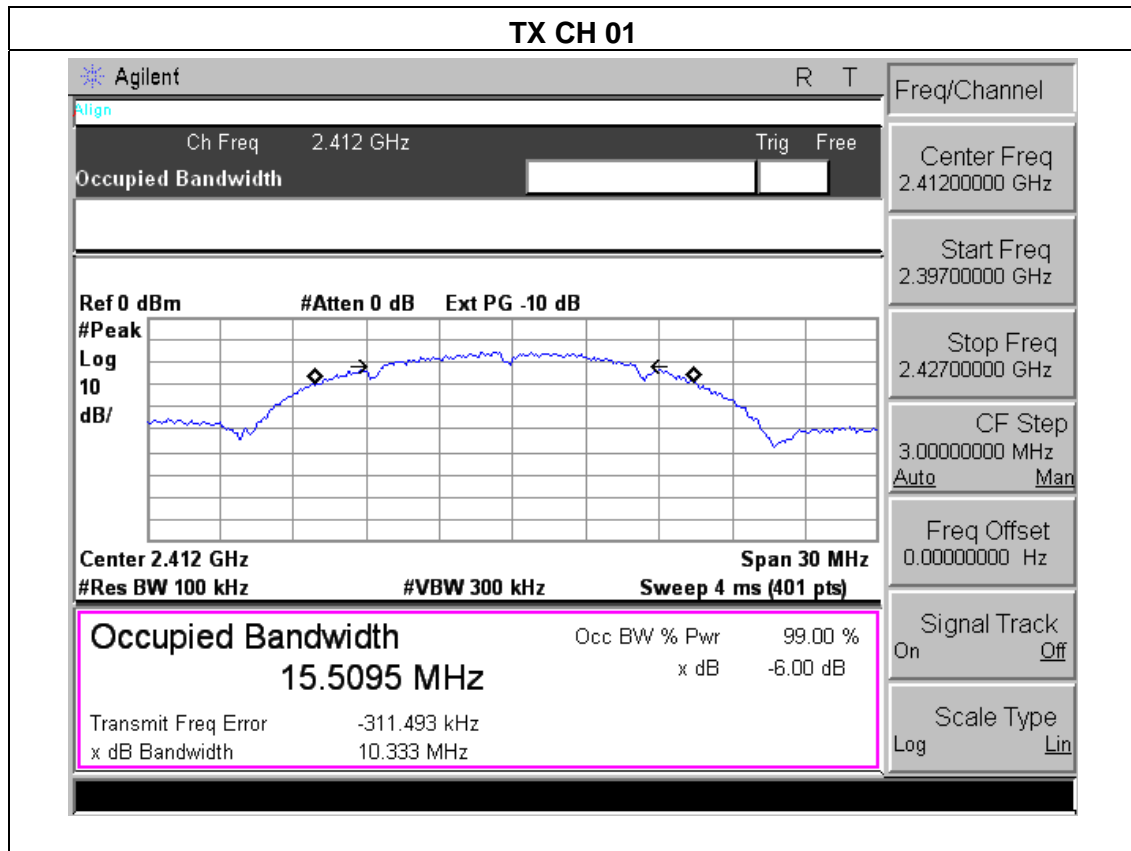

TX CH 06

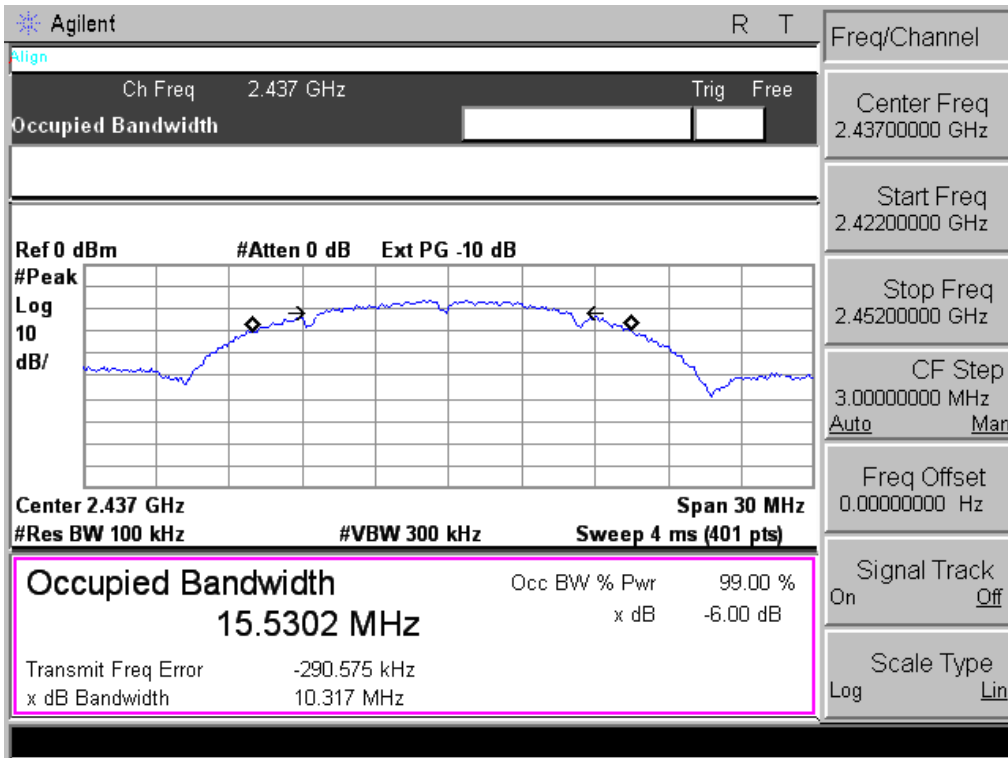

TX CH 11

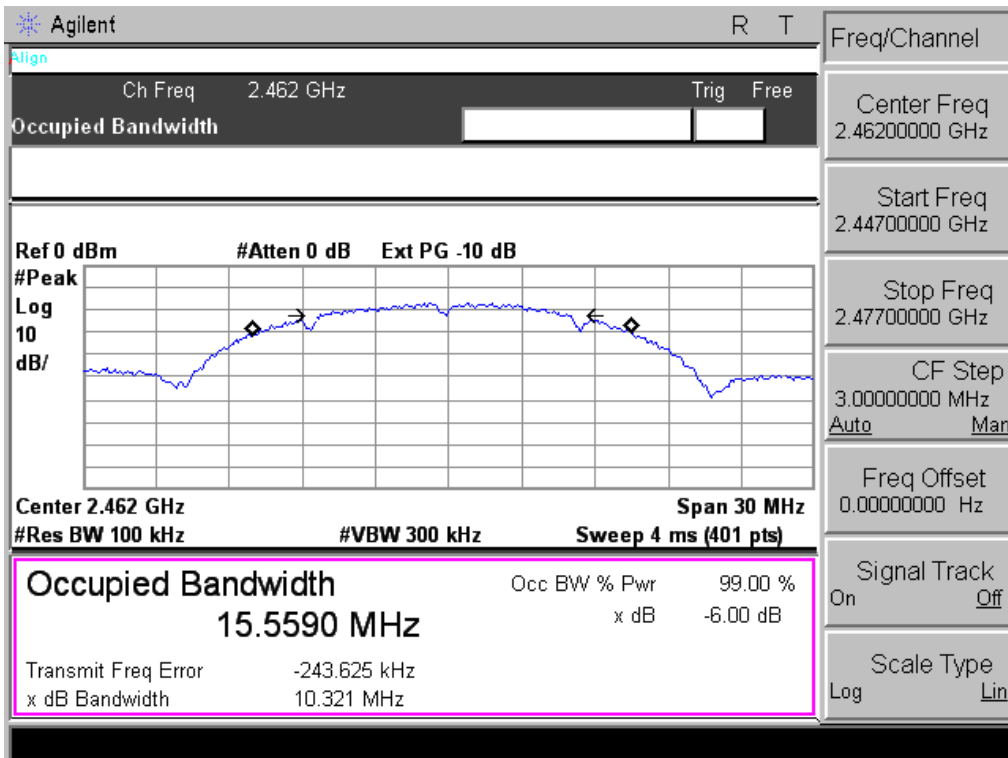

EUT :	android tv box	Model Name :	AM3
Temperature :	25 °C	Relative Humidity :	60%
Pressure :	1012 hPa	Test Voltage :	AC 120V
Test Mode :	TX g Mode /CH01, CH06, CH11		

Channel	Frequency (MHz)	6dB bandwidth (MHz)	Limit (kHz)	Result
Low	2412	16.67	500	Pass
Middle	2437	16.62	500	Pass
High	2462	16.62	500	Pass

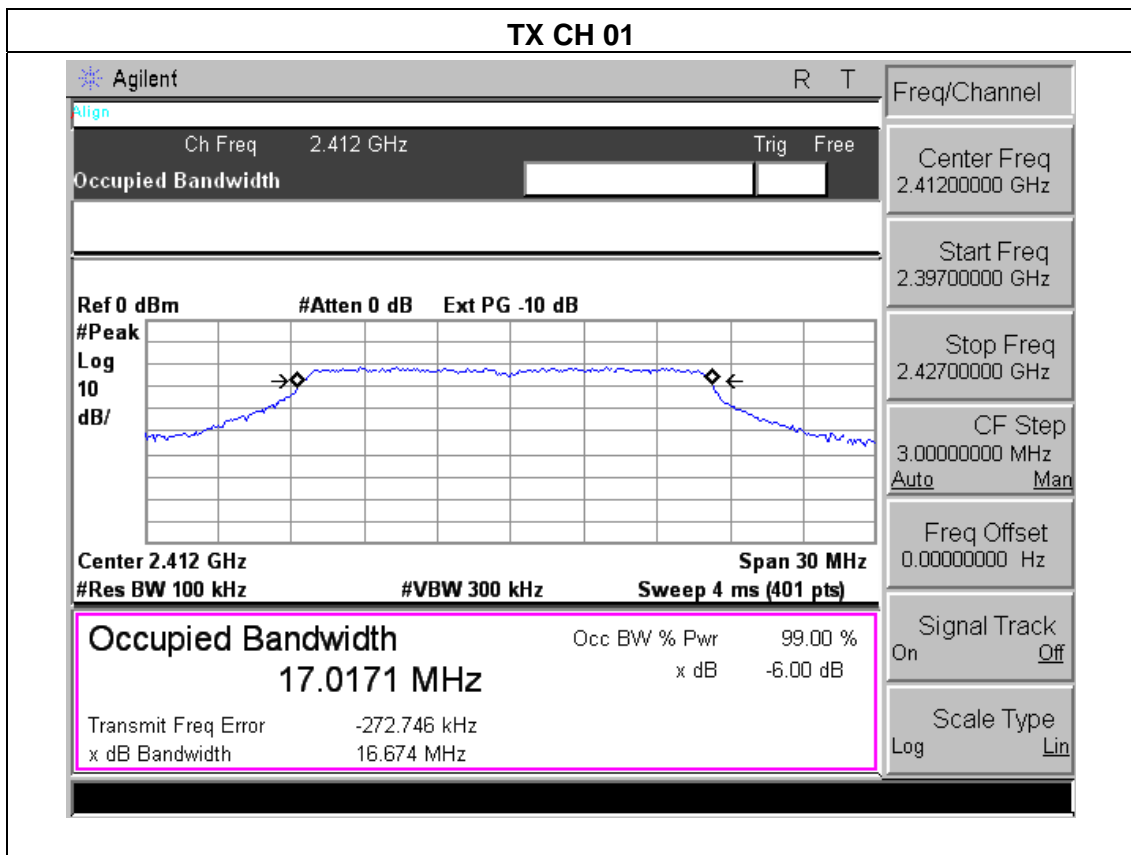

TX CH 06

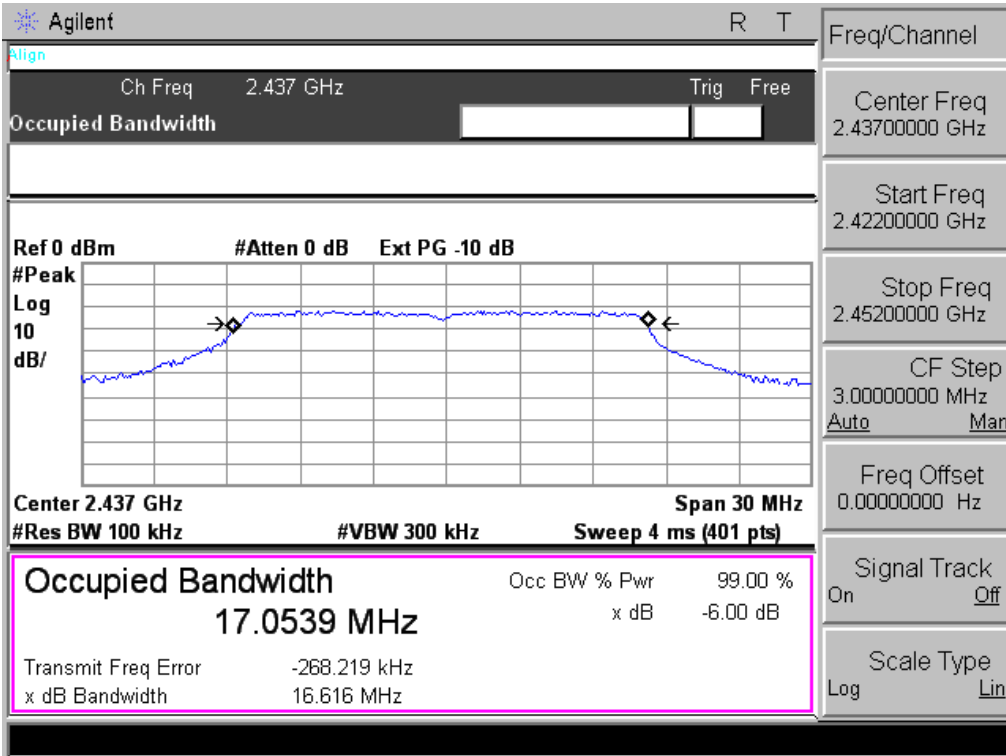

TX CH 11

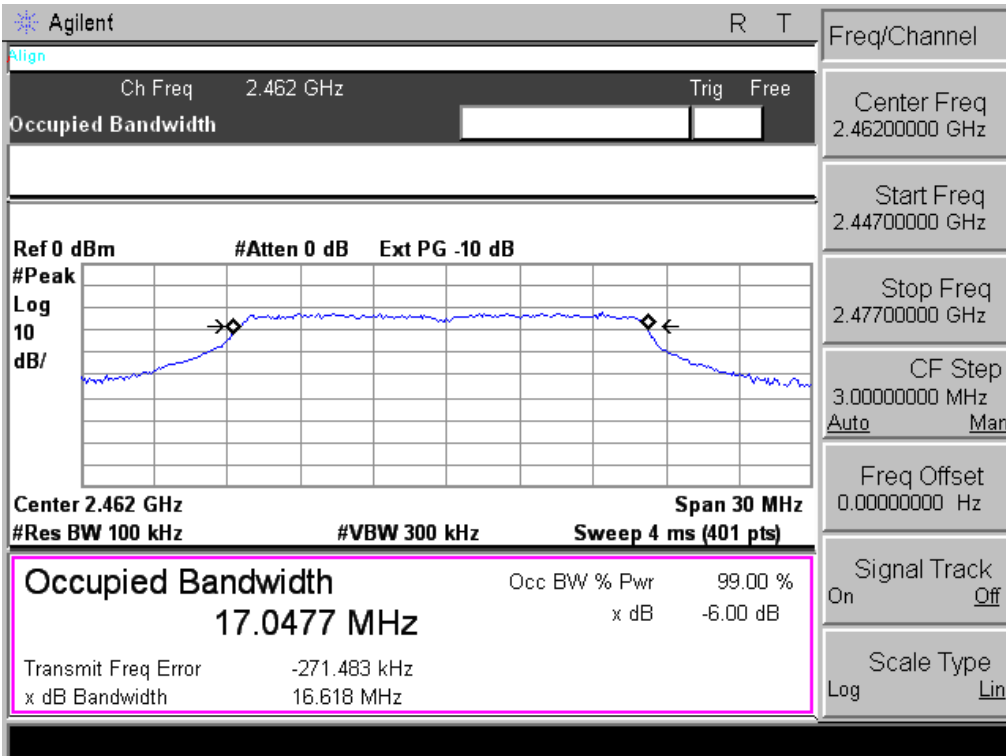

EUT :	android tv box	Model Name :	AM3
Temperature :	25 °C	Relative Humidity :	60%
Pressure :	1012 hPa	Test Voltage :	AC 120V
Test Mode :	TX n Mode(20M) /CH01, CH06, CH11		

Channel	Frequency (MHz)	6dB bandwidth (MHz)	Limit (kHz)	Result
Low	2412	17.70	500	Pass
Middle	2437	17.78	500	Pass
High	2462	17.85	500	Pass

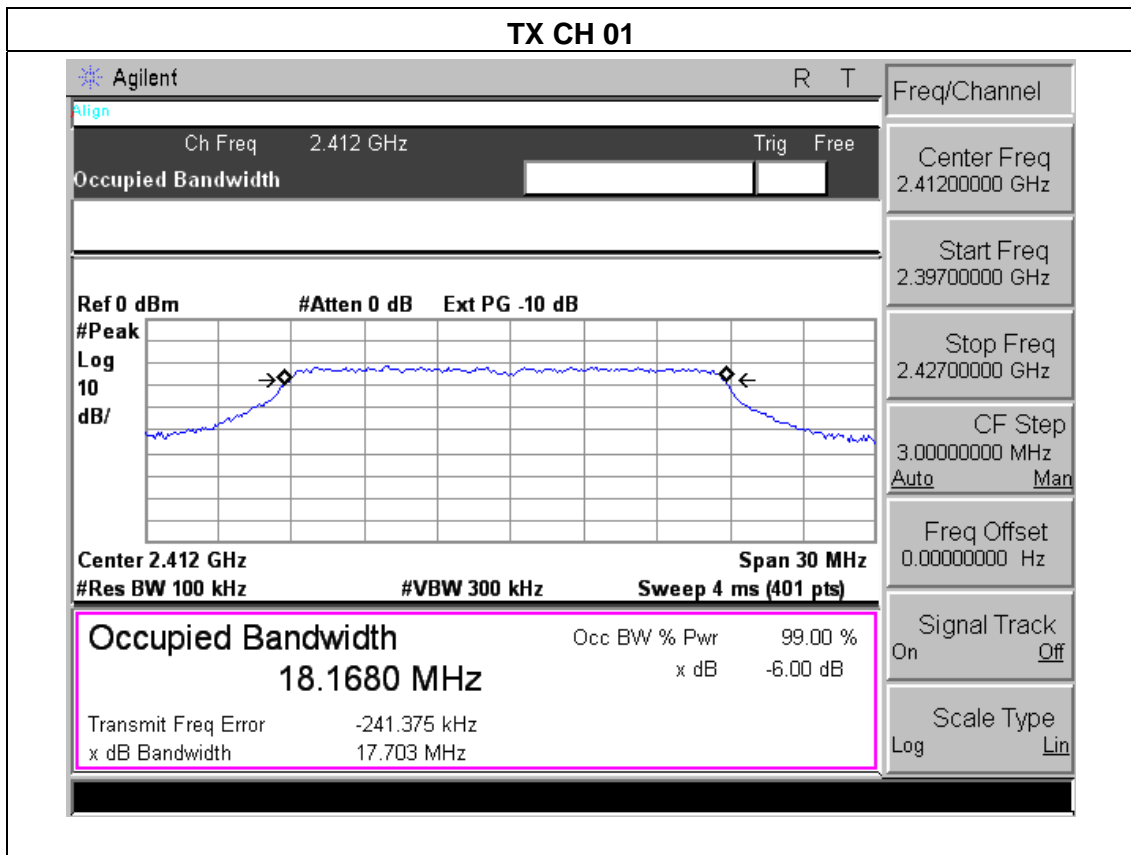

TX CH 06

Agilent
R T

Ch Freq 2.437 GHz
Trig Free

Occupied Bandwidth

Ref 0 dBm
#Atten 0 dB
Ext PG -10 dB

#Peak
Log
10
dB/

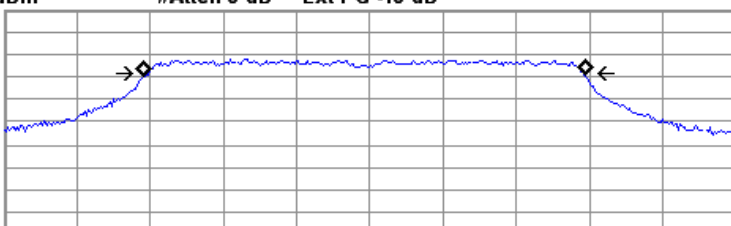

Freq/Channel

Center Freq
2.43700000 GHz

Start Freq
2.42200000 GHz

Stop Freq
2.45200000 GHz

CF Step
3.00000000 MHz
Auto Man

Freq Offset
0.00000000 Hz

Signal Track
On Off

Scale Type
Log Lin

Center 2.437 GHz
Span 30 MHz

#Res BW 100 kHz
#VBW 300 kHz
Sweep 4 ms (401 pts)

Occupied Bandwidth	Occ BW % Pwr	99.00 %
18.1586 MHz	x dB	-6.00 dB
Transmit Freq Error	-230.222 kHz	
x dB Bandwidth	17.776 MHz	

TX CH 11

Agilent
R T

Ch Freq 2.462 GHz
Trig Free

Occupied Bandwidth

Ref 0 dBm
#Atten 0 dB
Ext PG -10 dB

#Peak
Log
10
dB/

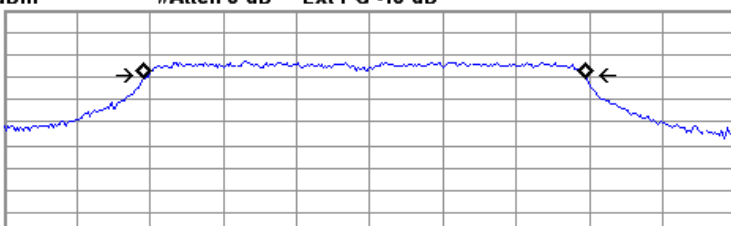

Freq/Channel

Center Freq
2.46200000 GHz

Start Freq
2.44700000 GHz

Stop Freq
2.47700000 GHz

CF Step
3.00000000 MHz
Auto Man

Freq Offset
0.00000000 Hz

Signal Track
On Off

Scale Type
Log Lin

Center 2.462 GHz
Span 30 MHz

#Res BW 100 kHz
#VBW 300 kHz
Sweep 4 ms (401 pts)

Occupied Bandwidth	Occ BW % Pwr	99.00 %
18.1510 MHz	x dB	-6.00 dB
Transmit Freq Error	-213.424 kHz	
x dB Bandwidth	17.846 MHz	

EUT :	android tv box	Model Name :	AM3
Temperature :	25 °C	Relative Humidity :	60%
Pressure :	1012 hPa	Test Voltage :	AC 120V
Test Mode :	TX n Mode(40M) /CH03, CH06, CH09		

Channel	Frequency (MHz)	6dB bandwidth (MHz)	Limit (kHz)	Result
Low	2422	36.16	500	Pass
Middle	2437	35.95	500	Pass
High	2452	36.11	500	Pass

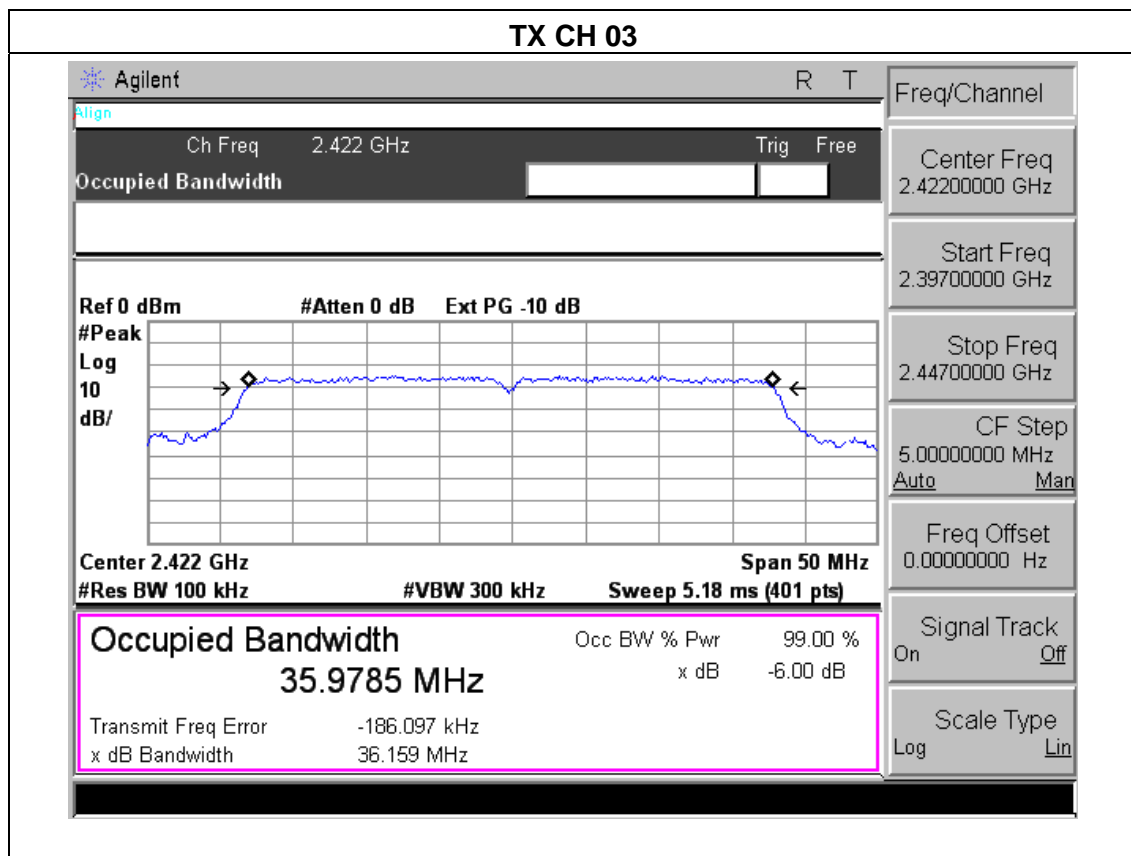

TX CH 06

Agilent
R T

Align

Ch Freq 2.437 GHz
Trig Free

Occupied Bandwidth

Ref 0 dBm #Atten 0 dB Ext PG -10 dB

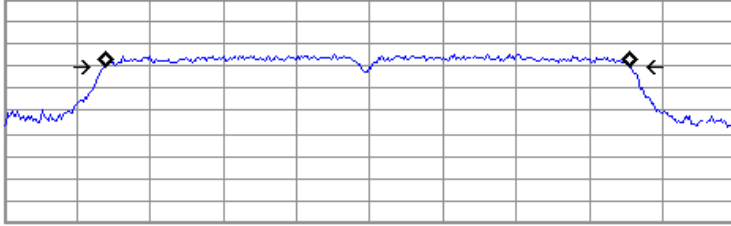
#Peak Log 10 dB/

Center 2.437 GHz
Span 50 MHz

#Res BW 100 kHz
#VBW 300 kHz
Sweep 5.18 ms (401 pts)

Occupied Bandwidth	Occ BW % Pwr	99.00 %
35.9555 MHz	x dB	-6.00 dB
Transmit Freq Error	-180.659 kHz	
x dB Bandwidth	35.950 MHz	

Freq/Channel

Center Freq 2.43700000 GHz

Start Freq 2.41200000 GHz

Stop Freq 2.46200000 GHz

CF Step 5.00000000 MHz
Auto Man

Freq Offset 0.00000000 Hz

Signal Track On Off

Scale Type Log Lin

TX CH 09

Agilent
R T

Align

Ch Freq 2.452 GHz
Trig Free

Occupied Bandwidth

Ref 0 dBm #Atten 0 dB Ext PG -10 dB

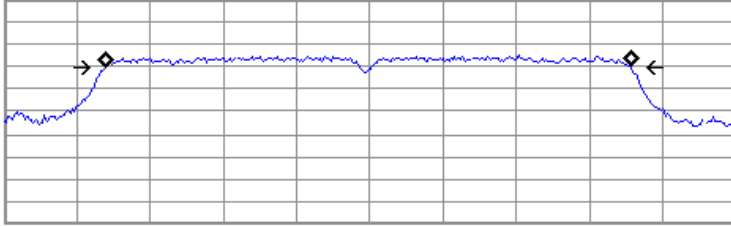
#Peak Log 10 dB/

Center 2.452 GHz
Span 50 MHz

#Res BW 100 kHz
#VBW 300 kHz
Sweep 5.18 ms (401 pts)

Occupied Bandwidth	Occ BW % Pwr	99.00 %
35.9938 MHz	x dB	-6.00 dB
Transmit Freq Error	-170.823 kHz	
x dB Bandwidth	36.107 MHz	

Freq/Channel

Center Freq 2.45200000 GHz

Start Freq 2.42700000 GHz

Stop Freq 2.47700000 GHz

CF Step 5.00000000 MHz
Auto Man

Freq Offset 0.00000000 Hz

Signal Track On Off

Scale Type Log Lin

6. PEAK OUTPUT POWER TEST

6.1 APPLIED PROCEDURES / LIMIT

FCC Part15 (15.247) , Subpart C				
Section	Test Item	Limit	Frequency Range (MHz)	Result
15.247(b)(3)	Peak Output Power	1 watt or 30dBm	2400-2483.5	PASS

6.1.1 TEST PROCEDURE

- a. The EUT was directly connected to the Power meter

6.1.2 DEVIATION FROM STANDARD

No deviation.

6.1.3 TEST SETUP



6.1.4 EUT OPERATION CONDITIONS

The EUT tested system was configured as the statements of 2.4 Unless otherwise a special operating condition is specified in the follows during the testing.

6.1.5 TEST RESULTS

EUT :	android tv box	Model Name :	AM3
Temperature :	25 °C	Relative Humidity :	60%
Pressure :	1012 hPa	Test Voltage :	AC 120V
Test Mode :	TX b/g/n(20M, 40M) Mode /CH01, CH06, CH11		

TX 802.11b Mode			
Test Channe	Frequency	Maximum Conducted Output Power A (PK)	LIMIT
	(MHz)	(dBm)	dBm
CH01	2412	16.95	30
CH06	2437	16.78	30
CH11	2462	16.70	30
TX 802.11g Mode			
CH01	2412	13.87	30
CH06	2437	13.68	30
CH11	2462	13.59	30
TX 802.11n-HT20 Mode			
CH01	2412	13.77	30
CH06	2437	13.73	30
CH11	2462	13.59	30
TX 802.11n-HT40 Mode			
CH03	2422	12.48	30
CH06	2437	12.75	30
CH09	2452	12.35	30

7. 100 KHZ BANDWIDTH OF FREQUENCY BAND EDGE

APPLICABLE STANDARD

In any 100 kHz bandwidth outside the frequency band in which the spread spectrum or digitally modulated intentional radiator is operating, the radio frequency power that is produced by the intentional radiator shall be at least 20 dB below that in the 100 kHz bandwidth within the band that contains the highest level of the desired power, based on either an RF conducted or a radiated measurement, provided the transmitter demonstrates compliance with the peak conducted power limits. If the transmitter complies with the conducted power limits based on the use of RMS averaging over a time interval, as permitted under paragraph (b)(3) of this section, the attenuation required under this paragraph shall be 30 dB instead of 20 dB. Attenuation below the general limits specified in §15.209(a) is not required. In addition, radiated emissions which fall in the restricted bands, as defined in §15.205(a), must also comply with the radiated emission limits specified in §15.209(a) (see §15.205(c)).

TEST PROCEDURE

- a) Check the calibration of the measuring instrument using either an internal calibrator or a known signal from an external generator.
- b) Position the EUT without connection to measurement instrument. Turn on the EUT and connect its antenna terminal to measurement instrument via a low loss cable. Then set it to any one measured frequency within its operating range, and make sure the instrument is operated in its linear range.
- c) Set RBW to 100 kHz and VBW of spectrum analyzer to 300 kHz with a convenient frequency span including 100 kHz bandwidth from band edge.
- d) Measure the highest amplitude appearing on spectral display and set it as a reference level. Plot the graph with marking the highest point and edge frequency.
- e) Repeat above procedures until all measured frequencies were complete.

7.1 DEVIATION FROM STANDARD

No deviation.

7.2 TEST SETUP



7.3 EUT OPERATION CONDITIONS

The EUT tested system was configured as the statements of 2.4 Unless otherwise a special operating condition is specified in the follows during the testing.

7.4 TEST RESULTS

EUT :	android tv box	Model Name :	AM3
Temperature :	25 °C	Relative Humidity :	60%
Pressure :	1012 hPa	Test Voltage :	AC 120V

Frequency Band	Delta Peak to band emission (dBc)	> Limit (dBc)	Result
802.11b mode			
Left-band	29.53	20	Pass
Right-band	47.87	20	Pass
802.11g mode			
Left-band	23.22	20	Pass
Right-band	37.20	20	Pass
802.11n-HT20 mode			
Left-band	24.89	20	Pass
Right-band	34.46	20	Pass
802.11n-HT40 mode			
Left-band	24.64	20	Pass
Right-band	32.11	20	Pass

Frequency (MHz)	Meter Reading (dBμV)	Factor (dB)	Emission Level (dBμV/m)	Limits (dBμV/m)	Margin (dB)	Detector Type	Comment
802.11b							
2390	58.36	-13.06	45.30	74	-28.70	peak	Vertical
2390	59.20	-13.06	46.14	74	-27.86	peak	Horizontal
2483.5	59.20	-12.78	46.42	74	-27.58	peak	Vertical
2483.5	52.74	-12.78	39.96	74	-34.04	peak	Horizontal
802.11g							
2390	58.41	-13.06	45.35	74	-28.65	peak	Vertical
2390	55.29	-13.06	42.23	74	-31.77	peak	Horizontal
2483.5	60.51	-12.78	47.73	74	-26.27	peak	Vertical
2483.5	61.19	-12.78	48.41	74	-25.59	peak	Horizontal
802.11n							
2390	61.94	-13.06	48.88	74	-25.12	peak	Vertical
2390	61.97	-13.06	48.91	74	-25.09	peak	Horizontal
2483.5	58.21	-12.78	45.46	74	-28.54	peak	Vertical
2483.5	55.51	-12.78	42.73	74	-31.27	peak	Horizontal

802.11b: Band Edge, Left Side

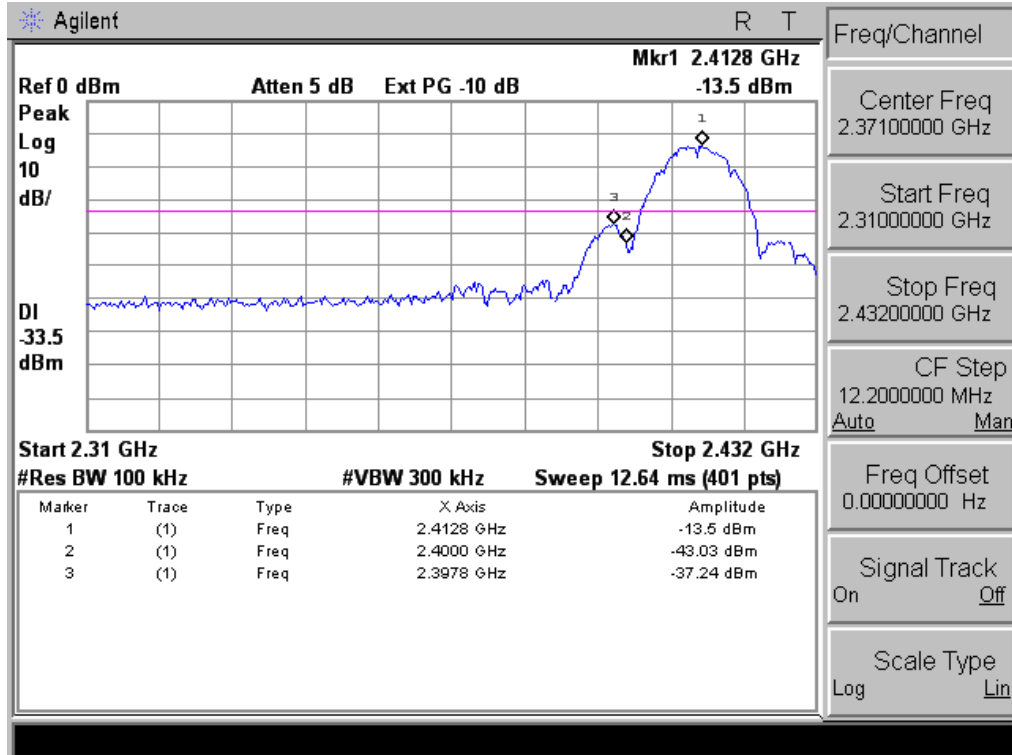

802.11b: Band Edge, Right Side

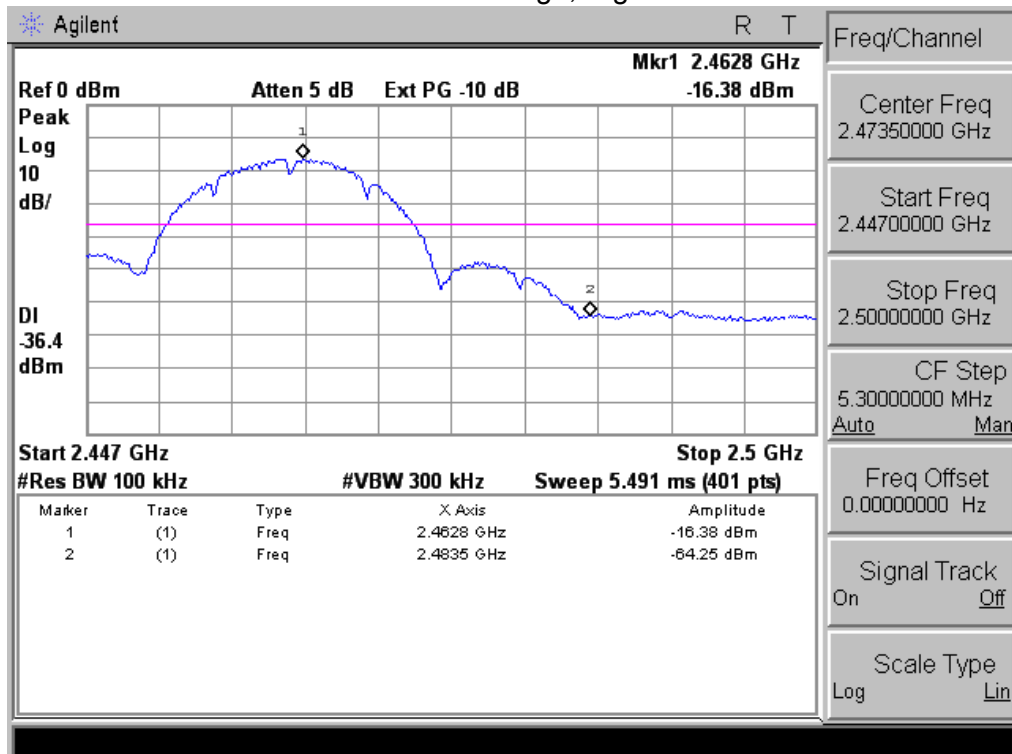

802.11g: Band Edge, Left Side

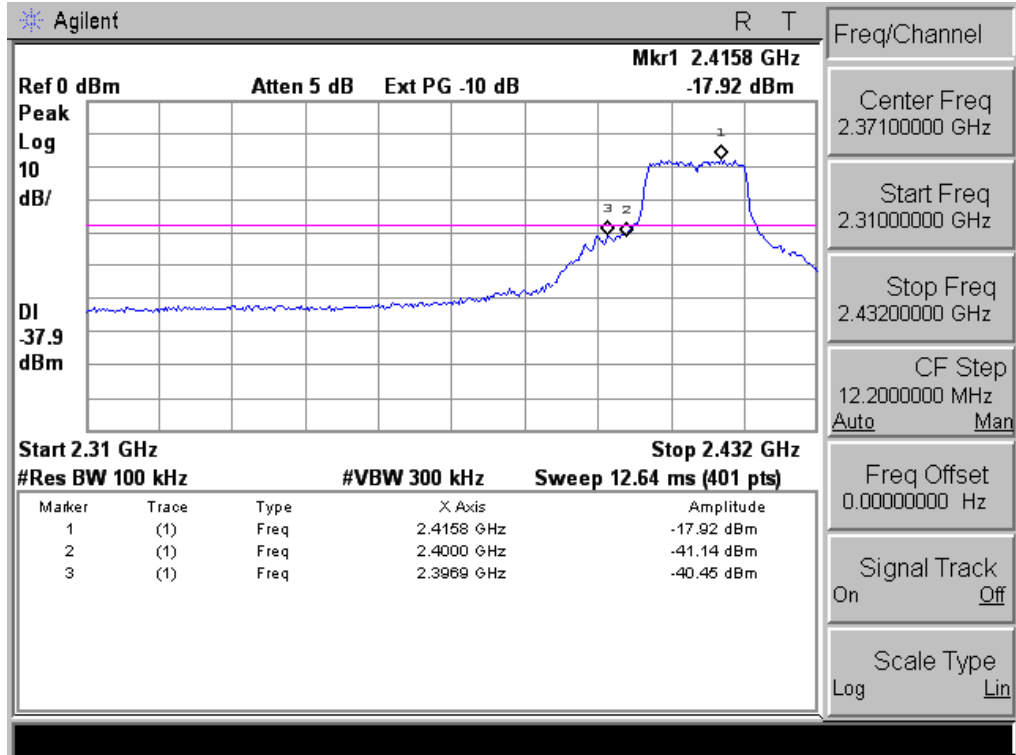

802.11g: Band Edge, Right Side

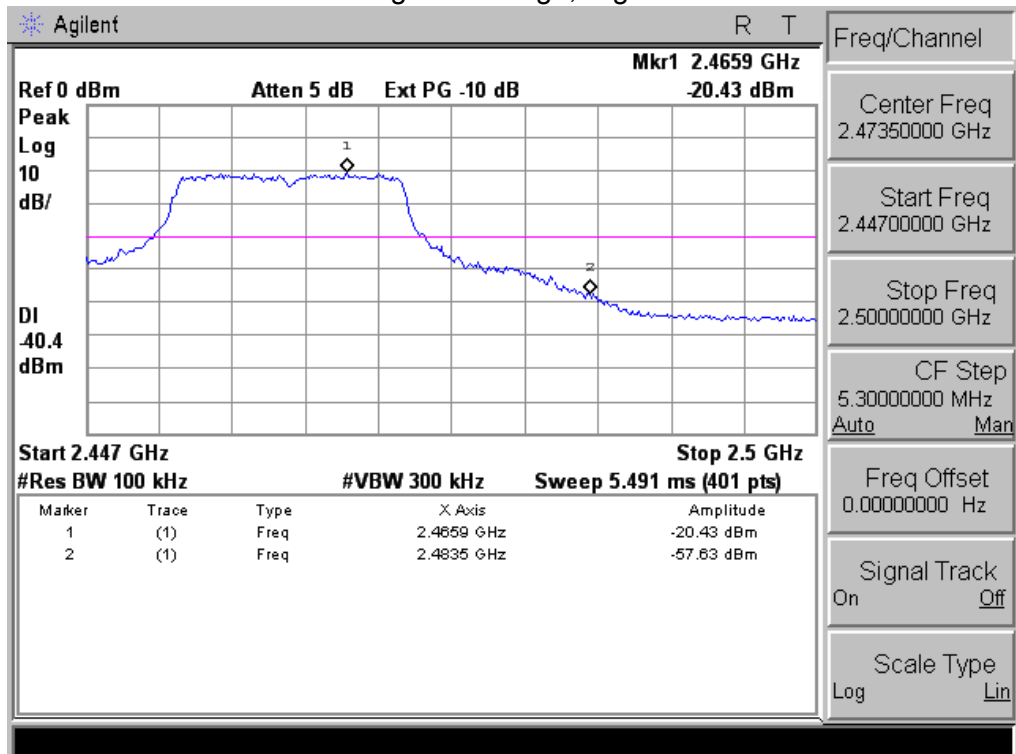

802.11n-HT20: Band Edge, Left Side

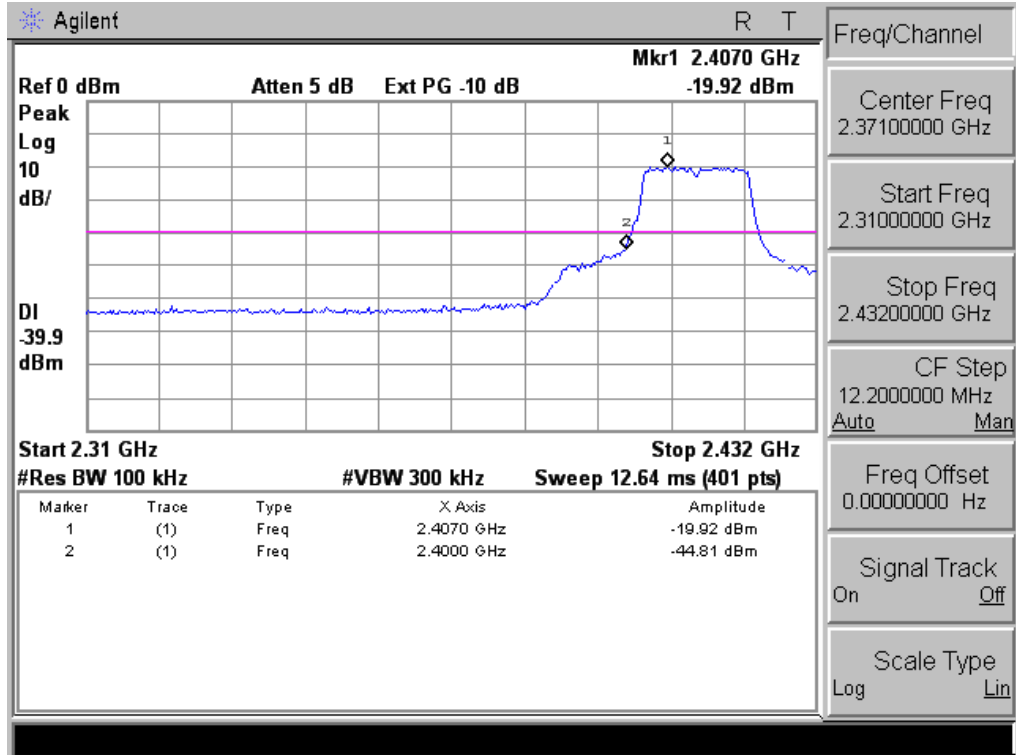

802.11n-HT20: Band Edge, Right Side

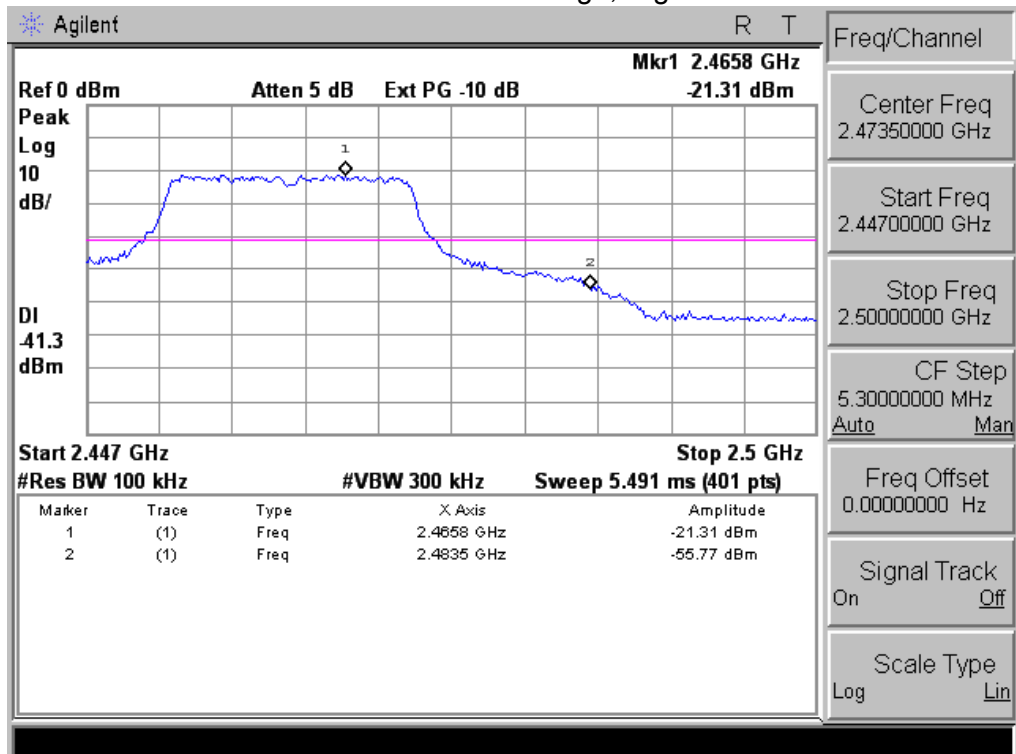

802.11n-HT40: Band Edge, Left Side

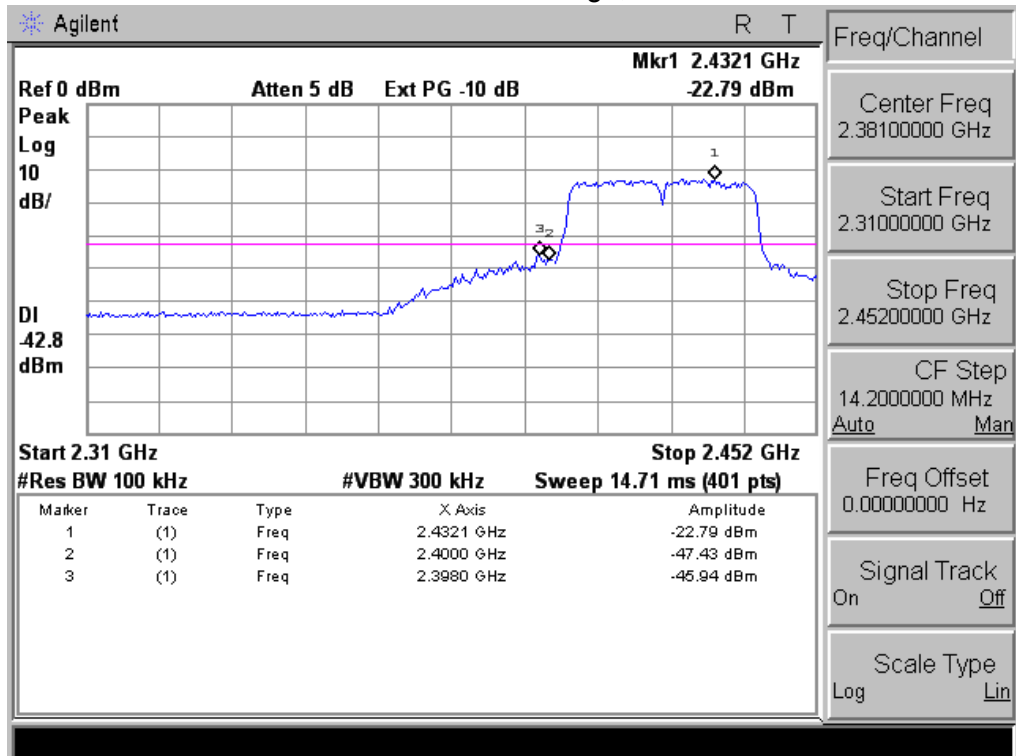

802.11n-HT40: Band Edge, Right Side

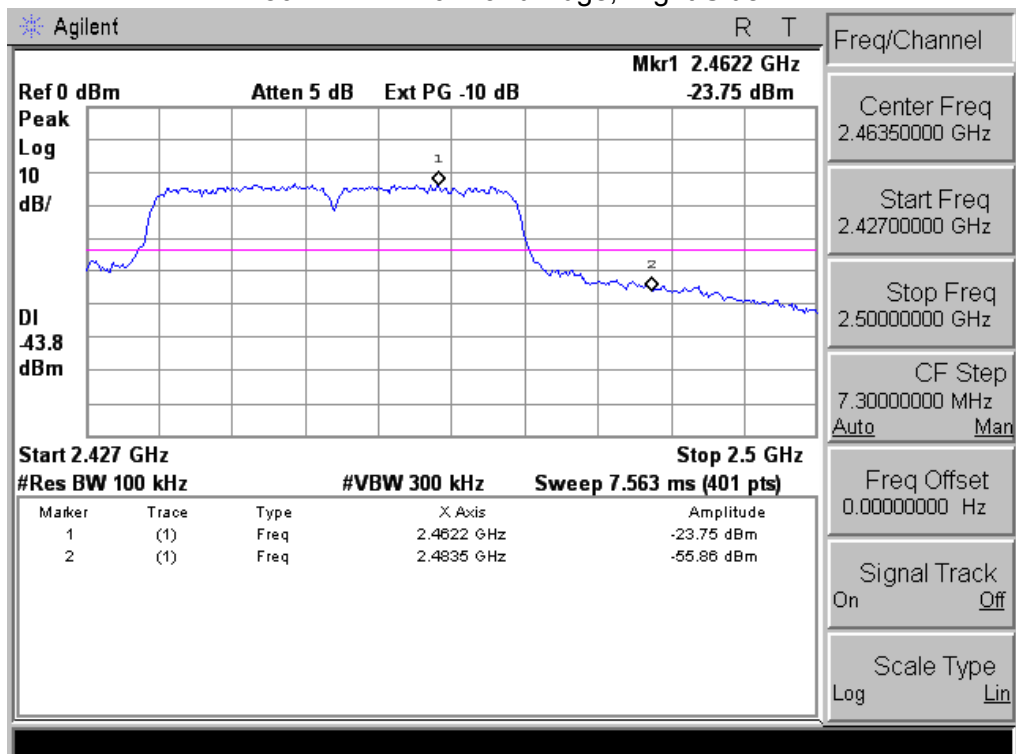

8. ANTENNA REQUIREMENT

8.1 STANDARD REQUIREMENT

15.203 requirement: For intentional device, according to 15.203: an intentional radiator shall be designed to ensure that no antenna other than that furnished by the responsible party shall be used with the device.

8.2 EUT ANTENNA

The EUT antenna is Internal Antenna. It comply with the standard requirement.