

INSTRUCTION MANUAL

MODEL: VTA-600B(PC)

Music Center with Bluetooth



The lightning flash with arrowhead within an equilateral triangle is intended to alert the user to the presence of uninsulated "dangerous voltage" within the product's enclosure that may be of sufficient magnitude to constitute a risk of electric shock to persons.

CAUTION

RISK OF ELECTRIC SHOCK
DO NOT OPEN

CAUTION: TO PREVENT RISK OF ELECTRIC SHOCK, DO NOT REMOVE COVER (OR BACK). NO USER-SERVICEABLE PARTS INSIDE. REFER SERVICING TO QUALIFIED SERVICE PERSONNEL.



The exclamation point within an equilateral triangle is intended to alert the user to the presence of important operating and maintenance (servicing) instructions in the literature accompanying the appliance.

CAUTION: To reduce the risk of fire or electric shock, do not expose this appliance to rain or moisture.

WARNING: To prevent electric shock, do not use this (polarized) plug with an extension cord, receptacle or other outlet unless the blades can be fully inserted to prevent blade exposure.



WARNING: Invisible laser radiation when open and interlock failed or defeated. Avoid direct exposure to laser beam.

Important Safety Instructions

1. Read these instructions – All the safety and operating instructions should be read before this product is operated.
2. Keep these instructions–The safety and operating instructions should be retained for future reference.
3. Heed all warnings–All warnings on the appliance and in the operating instructions should be adhered to.
4. Follow all instructions – All operating and use instructions should be followed.
5. Do not use this apparatus near water – The appliance should not be used near water or moisture – for example, in a wet basement or near a swimming pool, and the like.
6. Clean only with dry cloth.
7. Do not block any ventilation openings. Install in accordance with the manufacturer's instructions.
8. Do not install near any heat sources such as radiations, heat registers, stoves, or other apparatus (including amplifiers) that produce heat.
9. Do not defeat the safety purpose of the polarized or grounding plug. A polarized plug has two blades with one wider than the other. A grounding plug has two blades and a third grounding prong. The wide blade or the third prong is provided for your safety. If the provided plug does not fit into your outlet, consult an electrician for replacement of the obsolete outlet.
10. Protect the power cord from being walked on or pinched particularly at the plugs, convenience receptacles, and at the point where they exit from the apparatus.
11. Only use attachments/accessories specified by the manufacturer.
12. Use only with the cart, stand, tripod, bracket, or table specified by the manufacturer, or sold with the apparatus. When a cart or rack is used, use caution when moving the cart/apparatus combination to avoid injury from tip-over.
13. Unplug the apparatus during lightning storms or when unused for long periods of time.
14. Refer all servicing to qualified personnel. Servicing is required when the apparatus has been damaged in any way, such as power supply cord or plug is damaged, liquid has been spilled or objects have fallen into the apparatus has been exposed to rain or moisture, does not operate normally, or has been dropped.



15.



-This lightning flash with arrowhead symbol within an equilateral triangle is intended to alert the user to the presence of non-insulated "dangerous voltage" within the product's enclosure that may be of sufficient magnitude to constitute a risk of electric shock.

-Warning: To reduce the risk of electric shock, do not remove cover (or back) as there are no user-serviceable parts inside. Refer servicing to qualified personnel.

-The exclamation point within an equilateral triangle is intended to alert the user to the presence of important operating and maintenance instructions in the literature accompanying the appliance.

16. The mains plug is used as disconnect device, the disconnect device shall remain readily operable.
17. **WARNING**
To reduce the risk of fire or electric shock, do not expose this apparatus to rain or moisture. The apparatus shall not be exposed to dripping or splashing and that no objects filled with liquids, such as vases, shall not be placed on apparatus.
18. The use of the equipment in moderate climate.
19. The ventilation should not be impeded by covering the ventilation openings with items such as, newspapers, tablecloths, curtains, etc.
20. No naked flame sources, such as lighted candles, should be placed on the apparatus.
21. The symbol with \sim Indication AC voltage.
22. **CAUTION:** These servicing instructions are for use by qualified service personnel only. To reduce the risk of electric shock, do not perform any servicing other than that contained in the operating instructions unless you are qualified to do so.
23.  This equipment is a Class II or double insulated electrical appliance. It has been designed in such a way that it does not require a safety connection to electrical earth.

ACCESSORIES INCLUDED

- REMOTE CONTROL
- RCA TO 3.5MM AUX CABLE
- INSTRUCTION MANUAL
- WARRANTY (BACK OF MANUAL)
- 45 RPM ADAPTER
- USB CABLE
- CD SOFTWARE

Product Overview

Front View

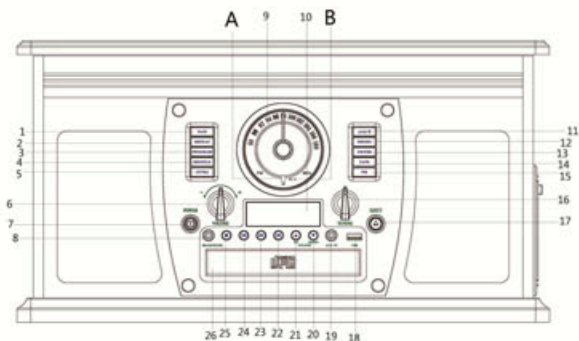

1. **"PAIR"** Press shortly to disconnect the current connection. Press 2 seconds to reconnect the device that has been connected before.
2. **"REPEAT"** In CD/CD-MP3 or USB mode, press to select a repeat mode.
3. **"PROGRAM"** In CD/CD-MP3 or USB mode, while the CD/CD-MP3 or USB is stopped, press to program tracks.
4. **"SHUFFLE"** In CD/CD-MP3 or USB mode, press for shuffle playback.
5. **"INTRO"** In CD/CD-MP3 or USB mode, press to play every track about 10 seconds. "INTRO" will be shown on the display if it skips to the next track.
6. **"VOLUME" KNOB** Turn to adjust volume. (Note: volume ranges from 00 to 30.)
7. **"POWER"** Press to turn the unit on or off.
8. **"3.5mm HEADPHONE JACK"** Accepts headphone/earphone plugs.
9. **"FM Scale"**
10. **"DISPLAY"**
11. **"AUX/BLUETOOTH"** Press to switch to AUX mode or Bluetooth mode.
12. **"PHONO"** Press to enter to the PHONO mode.
13. **"CD/USB"** Press to switch to CD mode or USB mode.
14. **"TAPE"** Press to enter to the cassette mode.
15. **"FM"** Press to enter to the FM mode.
16. **RADIO TUNER KNOB** In FM mode, turn to tune in a station.
17. **"EJECT"** In CD mode, use to open and close the disc tray.
18. **"USB JACK"**
19. **"AUX-IN JACK"** Connect an external source to the AUX IN socket.
- 20&21. **"Folder up & Folder down"** In USB/CD-MP3 mode, press to choose your desired folder.
22. **PLAY/PAUSE** Press to start playback, press again to pause.
- 23&24. **PREVIOUS / NEXT TRACK & REWIND / FF** ()
In CD/CD-MP3 or USB Mode, press once to skip to the previous / next track. Press and hold to fast rewind / forward.
25. **STOP** Press to stop playback.
26. **"DISC TRAY"**
- A: **REMOTE SENSOR**
- B: **TUNED/ST INDICATOR:** In FM Mode, the "TUNED/ST" indicator lights up red when tuning in the stereo reception station.

Right Side View

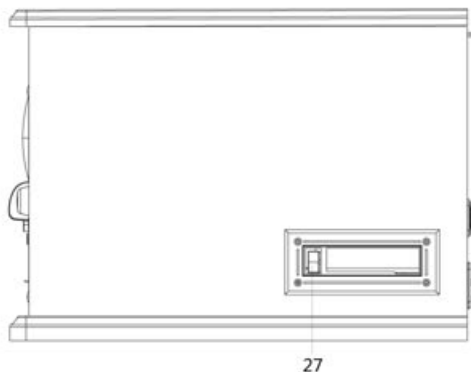

27. **CASSETTE FF & EJECT** Press halfway to fast forward, press all the way to end and eject the tape.

Rear View

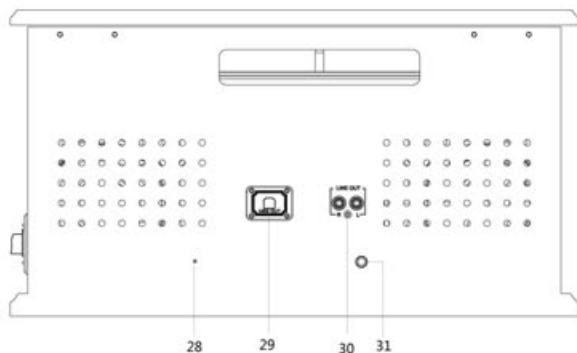

28. **FM wire antenna**
While tuned to a station in FM mode, extend the wire and reposition to adjust for best reception.
29. **USB JACK (Recording Only)**
30. **LINE OUT jacks**
For amplifier device with RCA auxiliary input sockets, insert the white and red plugs on the RCA cable into the unit. Insert the opposite end into the amplifier device. Be sure to connect the white plug to the white jack and the red plug to the red jack.
31. **AC Power Cord**
Plugs into a wall outlet.

Parts of the Turntable

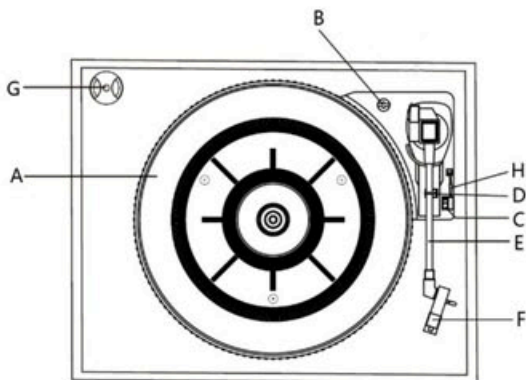

- A. Turntable.
- B. **Safety Screw (for transport)** Before using the unit, turn the screw clockwise using a coin or screwdriver. 
Important: When you transport the unit, turn the screw counterclockwise to secure the turntable.
- C. Speed Selector.
- D. Tone Arm holder.
- E. Tone Arm. Before use, completely loosen the twist tie on the tone arm and uplift tone arm.
- F. Stylus
- G. 45 RPM adaptor.
- H. Cue-lever. Use this lever to lift the tone arm.

Setup / Basic Operation

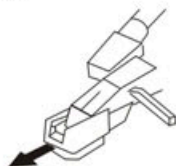

Setup

1. Remove white protective needle cover by gently pulling towards front of unit.
2. Remove any packaging materials from the unit.
3. Connect the AC power cord to a wall outlet.



Note: To prevent interference, avoid bundling audio signal cables together with the AC power cord.

Basic Operation

1. Press the POWER button to turn the unit on. 
2. Select the source by pressing the corresponding mode button (AUX/  (Bluetooth)/PHONO/CD/USB/TAPE/FM) 
3. Rotate the VOLUME knob to adjust to the desired sound level. The volume reading is "00-30" the volume will change along with the number.

Listening through RCA LINE OUT

For amplifier device listening, first reduce the volume level to minimum. Insert the white and red plugs on the RCA cable into the back of the unit, then insert the opposite end into your amplifier device. Be sure to connect the white plug into the white jack and the red plug into the red jack.

Listening through Earphones/Headphones (*not included*)

For private listening, first reduce the volume level to minimum. Insert your headphones' plug into the HEADPHONE jack, then adjust the volume up by turning the VOLUME knob.

Note: The speakers will automatically be deactivated while headphones are plugged in.

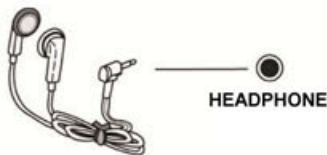

CONDENSATION WARNING:

When the unit is moved from a cold or warm place, or is used following a sudden temperature change, there is the danger that water vapor in the air may condense on the unit, preventing proper operation. In such cases, leave the unit for 1-2 hours after plugging it into an AC outlet to allow it to stabilize at the temperature of its surroundings.

Remote Control

When using the remote control, point it towards the remote sensor on the front panel of the unit.

Notes:

- Even if the remote control is operated within the effective range, remote control operation may be impossible if there are any obstacles between the unit and the remote control.
- If the remote control unit is operated near other devices, which generate infrared rays, it may not function properly. Conversely, the other devices may not function incorrectly.

Battery Installation

1. Remove the battery compartment cover.
2. Insert 2x "AAA" batteries. (batteries not included)
Note: Make sure that they are oriented so their polarity markings, "+" and "-" match the remote's markings.
3. Replace the battery compartment cover.

battery compartment cover

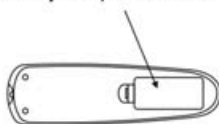

Battery Replacement

When the distance required between the remote control unit and main unit decreases, it is necessary to replace the battery with new ones.

Battery Precautions

Be sure to insert the batteries with correct positive "+" and negative "-" orientation.

ALWAYS use batteries of the same type. Never mix different types of batteries together.

When using rechargeable batteries, refer to the precautions on their labels.

When the remote control unit is not to be used for a long time (more than a month), remove the batteries to prevent them from leaking.

Do not heat or disassemble batteries, and NEVER dispose of old batteries by throwing them in a fire.

Do not dispose device into standard garbage disposal sites. Dispose of device at available Battery Recycling Sites after fully discharging battery. Not doing so may violate disposal laws and regulations.

Please refer to local regulations for proper battery disposal.

Remote Control Button Functions

1. **MUTE**: Press to enter mute mode, "V00" will show on the display, press it again to cancel mute mode. "V00" will disappear from the display.

Or you can press VOL+ to cancel mute mode.

2. **"REPEAT"**: In CD/CD-MP3 or USB mode, press to select a repeat mode.
3. **"PROGRAM"**: In CD/CD-MP3 or USB mode, while the CD/CD-MP3 or USB is stopped, press to program tracks.
4. **"PHONO"**: Press to enter to PHONO mode.
5. **"RADIO"**: Press to enter to FM mode.
6. **"Bluetooth"**: Press to enter Bluetooth mode.
7. **"TAPE"**: Press to enter cassette mode.

8&17. "Folder down & Folder up" :

In CD-MP3/USB mode, press to choose your desired folder.

9&19. "VOL+" / "VOL-": Press to adjust the volume

10. **"PLAY/PAUSE" ►||** Press to start playback, press again to pause.

11&18. "PREVIOUS / NEXT TRACK & REWIND / FF (◀◀ / ▶▶)":

In CD/CD-MP3 or USB Mode, press once to skip to the previous / next track.

Press and hold to fast rewind / forward.

12. **"OPEN/CLOSE"** Press to open/close the disc tray.
13. **"STOP"** Press to stop playback.
14. **"SHUFFLE"** In CD or USB mode, press for shuffle playback.
15. **"CD/USB"** Press to switch to CD or USB mode.
16. **"AUX"** Press "AUX" to enter to AUX mode.

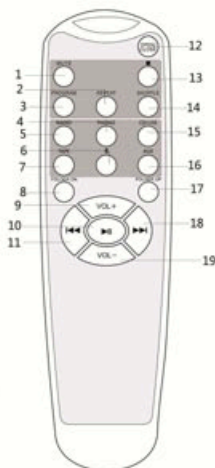

Listening to a Vinyl Record

1. Press the "PHONO" selector button.
2. Gently open the top cover.
Note: Be carefully not to pinch your finger when opening/closing the top cover.
3. Place a vinyl record on the turntable. When playing a 45 RPM record, use the included adaptor.
4. Select the appropriate speed (4).

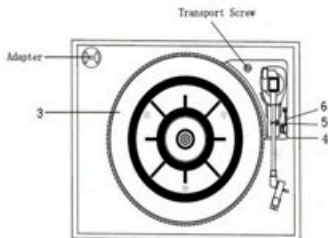

5. Gently push tone arm clip (5) to the right to release the tone arm.
6. Raise the cue lever (6) to lift the tone arm off the tone arm support.



7. Move the tone arm gently to the edge of the record (or the starting point of a track). The turntable will begin to turn.
8. Gently lower the tone arm by slowly releasing the cue lever.
9. When the record reaches its end, tone arm and rotation stop. Lift the tone arm and place it to tone arm rest manually.

Important:

- Closing the top cover will help prevent dust from settling on the turntable.
- Always relock the tone arm before transporting the unit.
- Do not place anything on top of the turntable cover, especially while playing a record.

Listening to a CD/CD-MP3

1. Press the "CD/USB" button once to select CD mode. The unit will display the "CD".
Note: When no disc is set, "no disc" will appear on the display.
2. Press the EJECT button (▲) to open the tray.
Note: This button will only work in CD mode.
3. Place a disc on the tray with the printed label face up.



4. Press the EJECT button (▲) close the tray.
5. "READ" will appear for a few seconds and then the number of tracks will show on the display.
6. After that it will begin playback from the first track automatically.
7. To temporarily pause playback, press the PLAY/PAUSE button (▶||). Press again to resume.
8. To skip tracks backward or forward, press the corresponding skip button (◀◀ or ▶▶).
9. To fast rewind / forward within a track, press and hold down the corresponding skip button (◀◀ or ▶▶) until the desired position is reached.
10. To stop playback, press the STOP (■) button

NOTE: While listening to an CD-MP3, press the Folder down or Folder up button to choose your desired folder.

Important:

- Never place more than one disc on the tray.
- The disc must be placed in the center of the disc tray. An incorrectly loaded disc can permanently damage the tray door mechanism.
- Do not push the CD tray – always use the OPEN/CLOSE button.
- It takes a moment for the unit to load a disc, during which all buttons will be temporarily deactivated.

Repeat Playback

Each time the REPEAT button is pressed, the repeat mode will cycle through the following options:

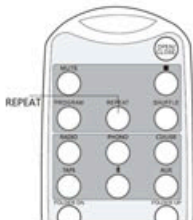

REPEAT 1 (Repeat one track)

The current track will be played repeatedly. If you press the (I◀◀ or ▶▶I) button to select another track, the track you select will be played repeatedly.

REPEAT FOLDER (Repeat the folder)

In CD-MP3 mode, you can select the folder to play repeatedly.

REPEAT ALL (Repeat the entire CD/CD-MP3)

The entire CD/CD-MP3 will be played repeatedly.

Notes:

- If one of the following buttons is pressed, the repeat mode will be cancelled.
OPEN/CLOSE, POWER, FM, PHONO, AUX/Bluetooth, TAPE, CD/USB
- Repeat playback works with finalized discs only.

Shuffle Playback

To play the tracks on a CD/CD-MP3 in a random sequence, press the SHUFFLE button during playback.

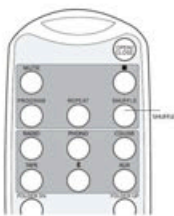

Notes:

- Pressing (▶▶I) during shuffle playback will randomly select the next track.
- If one of the following buttons is pressed, shuffle mode will be cancelled.
OPEN/CLOSE, POWER, FM, PHONO, AUX/Bluetooth, TAPE, CD/USB
- When the SHUFFLE playback of all the tracks has been finished, the unit stops and the shuffle mode is cancelled.
- A track cannot be repeated during shuffle playback.
- Shuffle playback doesn't work during programmed playback.
- Shuffle playback works with finalized discs only.

Programmed Playback

Program play must be set when the CD/CD-MP3 is stopped. You can program up to 20 tracks for CD disc and program up to 99 tracks for MP3 disc

Notes:

- Shuffle playback does not work during programmed playback.
- Programmed playback works with finalized disc only.

1. Press "CD/USB" button once to select CD mode, then load a CD.
2. While the CD is stopped, press the PROGRAM button.
3. "PROGRAM" indicator blinks, and "P-01" appears on the display.

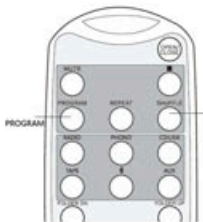

4. Press (◀◀ or ▶▶) to select a track number.
5. Press the PROGRAM button again to set the current track.
6. "P-02" is displayed. Repeat steps 4 thru 5 to program the additional tracks.



7. When the selection of track numbers has been finished, press the PLAY button (▶||) to start program playback.
8. To cancel the program mode, press the STOP (■) button twice and then the "PROGRAM" will disappear from the display.

To check the programmed order

In the stop mode, press (◀◀ or ▶▶) repeatedly to show the track numbers that have been programmed.

Listening to the Radio

1. Press the "FM" button.
2. Tune to the desired station using the Radio Tuner Knob.
Note: In FM Mode, The "TUNED/ST" indicator lights up red when tuning in the stereo reception station.

Adjusting for Best Reception

FM broadcast: Extend and reposition the FM antenna.

Listening to an External Audio Device (AUX Mode)

In AUX (auxiliary) mode, this unit can play audio from an external audio source (iPod, MP3 Player, Portable CD Player, etc.)

There is an AUX IN jack on the front of the unit. When connecting a device that has a headphone jack, use a 3.5mm cable on both ends to connect the external device with the apparatus.

1. Plug one end of the AUX IN cable (not included) into the AUX IN jack.
2. Plug the other end of the cable into the headphone jack of the external audio source.
3. Press "AUX/Bluetooth" button to select AUX-IN function, "AUX" will appear on the top right corner.
4. And then turn your external device on to playback.
5. Rotate the VOLUME knob to adjust the sound level.
6. Adjust the volume level on your audio appliance if necessary.
7. You can control the playing process by operating your external device.

NOTE: All operations are only available on your external device.

Listening to an External Audio Device (BT Mode)

In BT (Bluetooth) mode, this unit can enjoy music from external devices which have a built - in Bluetooth feature.

GETTING CONNECTED USING BLUETOOTH

1. Press "AUX/Bluetooth" button twice to select Bluetooth mode and then the display will show "BT".
2. Set the Bluetooth function of your external device when the apparatus is on.
3. Set to search Bluetooth device on your external device.
NOTE: The effective distance between your external device and this apparatus is 10 meters.
4. Wait for a while then find the "Wooden Music Center" on the paired devices list on your external device and press "Wooden Music Center". Sometimes a window will ask you for a password. Fill in "0000" then press "OK" on your external device.
5. A few seconds later your Bluetooth connection is success and you will hear a chime.

NOTE:

- The PAIR Button will allow you to disconnect from your external while remaining in BT mode. Simply press the PAIR button to disconnect. Press 2 seconds to reconnect the device that has been connected before.

ENJOY MUSIC FROM AN EXTERNAL DEVICE

1. Get your external device paired. (See "Getting connected")
2. Turn on the music player program on your external device and set it play.

Normally, you can control music playback with the PLAY/PAUSE, ◀◀ and ▶▶ button on the apparatus. However, some buttons may not work due to the variable music player program.

Now enjoy the fun.

Listening to a Cassette Tape

1. Load an audio cassette tape into the unit (located on the right side of the unit). Playback will automatically begin.
2. Press button halfway to Fast Forward the tape.
Press button lightly and playback will resume.
3. Press button completely down to end playback and eject Tape.

USB Memory Stick Playback

1. Press CD/USB button repeatedly to switch to USB mode. "USB" will appear on the right corner.
Note: When no USB is set, "NO USB" will appear on the display.
2. Connect a USB memory stick (not included) into the USB slot and then the number of tracks will show on the display.
3. After that it will begin to playback from the first track automatically.
4. To temporarily pause playback, press the PLAY/PAUSE button (▶||). Press again to resume.
5. Press the Folder down or Folder up button to choose your desired folder.
6. To skip tracks backward or forward, press the corresponding skip button (◀◀ or ▶▶).
7. To fast rewind / forward within a track, press and hold down the corresponding skip button until the desired position is reached.
8. To stop playback, press the STOP (■) button

NOTE:

- Do not push both buttons together as this may damage the unit.
- As the unit is tracking quickly, forward or backward you will hear your selection playing at a distorted speed. Simply release the depressed button to continue playing at normal speed at the desired position in the selected track

REPEAT PLAYBACK

Each time the REPEAT button is pressed, the repeat mode will cycle through the following options:

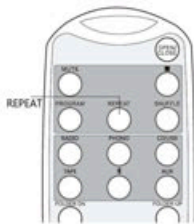

REPEAT 1(Repeat one track)

The current track will be played repeatedly. If you press the (◀◀ or ▶▶) button to select another track, the track you select will be played repeatedly.

REPEAT FOLDER (Repeat the Folder)

The Folder will be played repeatedly.

REPEAT ALL (Repeat the entire USB)

The entire USB will be played repeatedly.

Notes:

- If one of the following buttons is pressed, the repeat mode will be cancelled.
OPEN/CLOSE, POWER, FM, PHONO, AUX/BLUETOOTH, TAPE, CD/USB.

Shuffle Playback

To play the tracks on a USB in a random sequence, press the SHUFFLE button during playback.

Notes:

- Pressing (▶▶) during shuffle playback will randomly select the next track.
- If one of the following buttons is pressed, shuffle mode will be cancelled.
OPEN/CLOSE, POWER, AM/FM, PHONO, AUX/BLUETOOTH, TAPE, CD/USB
- When the SHUFFLE playback of all the tracks has been finished, the unit stops and the shuffle mode is cancelled.
- A track cannot be repeated during shuffle playback.
Shuffle playback doesn't work during programmed playback.

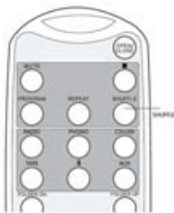

Programmed Playback

Up to 99 tracks can be programmed to play in the desired order.

Notes:

- Shuffle playback does not work during programmed playback.

1. Press "CD/USB" to enter USB mode, then insert a USB memory stick into USB slot.
2. While the USB is stopped, press the PROGRAM button.
3. "PROGRAM" indicator blinks, and "P-01" appears on the display.



4. Press (I◀◀ or ▶▶I) to select a track number.
5. Press the PROGRAM button again to set the current track.
6. "P-02" is displayed. Repeat steps 4 thru 5 to program the additional tracks.



7. When the selection of track numbers has been finished, press the PLAY button (▶▶) to start program playback.
8. To cancel the program mode, press the STOP (■) button twice and then "PROGRAM" icon disappear from the display.

To check the programmed order

In the stop mode, press (I◀◀ or ▶▶I) repeatedly to show the track numbers that have been programmed.

USB Recording Operation

To properly record your vinyl to MP3 via computer, use the included USB Output Cable and Instructional CD Software. Connect one end of the USB cable to the turntable (USB jack on the back of the unit) and the other end into your computer. Then connect the AC power cord to the turntable. To install and use the software on your computer, select the proper Mac or PC install files, then follow the prompts provided on the Instructional CD. For the most up to date manuals, software, instructional details, troubleshooting or other downloadable content, please go to <http://audacityteam.org>

Maintenance / Proper Handling

Compact Disc Handling

- Always place the disc on the disc tray with the label side facing upward (compact discs can be played/recorded only on one side)
- To remove a disc from its storage case, press down on the center of the case and lift the disc upward, holding it carefully by its edges.
- To clean a disc, wipe the surface from the center hole outward towards the outer edge with a soft, dry cloth.
- Never use such chemicals as record spray, antistatic sprays or fluid, benzene or thinner to clean discs; they will irreparably damage the disc's plastic surface.
- Discs should be returned to their cases after use to protect from dust and scratches.
- Do not expose discs to direct sunlight, high humidity, or high temperature for extended periods of time.
- Printable CD-R and CD-RW discs are not recommended, as the label side may become sticky and damage the unit.
- Use a soft oil-based felt-tipped pen to write the information on the label side. Never use a ball-point or hard-tipped pen, as doing so may damage the recorded side.
- Do not use irregularly-shaped CDs (octagonal, heart shaped, business card size, etc), as they will damage the unit.
- Read all precautions supplied with any CD-R or CD-RW disc
- Never handle a disc with dirty fingers.
- Never insert a disc that has a crack on the surface.

Handling Vinyl Records

- Do not touch the record's grooves. Only handle records by the edges or the label with clean hands. Touching the record surface will cause your record's quality to deteriorate.
- To clean a record, use a soft anti-static cloth to gently wipe the record surface.
- Keep records in their protective sleeves when not in use.
- Always store records upright on their edges
- Avoid placing records in direct sunlight, close to a heat source (radiators, stoves, etc.), or in a location subject to vibration, excessive dust, heat, cold or moisture.

General Care

- When removing the power plug from the wall outlet, always pull directly on the plug. Never pull the cord.
- To keep the laser pickup clean, do not touch it, and do not forget to close the disc tray.
- Do not attempt to clean the unit with chemical solvents as this might damage the finish.
- For cleaning, only use a clean, dry cloth.
- In order to shut off the power to this product completely, unplug the power cord from the wall outlet. Be sure to unplug the unit if you will not intend to use it for an extended period of time.

How to Replace the Turntable Stylus (Replacement Needle #: ITNP-LC1)

The stylus should last about 50 hours under normal use. However, it is recommended that the stylus be replaced as soon as you notice a change in sound quality. Prolonged use of a worn-out stylus may damage the record. The highest speed of 78 RPM records would wear out the stylus more quickly.

Removing the old stylus:

1. Set a screwdriver at the tip of the stylus and push downward (A).
2. Remove the stylus by pulling it simultaneously downward and forward.



Installing a new stylus:

1. Hold the front tip of the stylus and insert its rear edge (B) first.
2. Push the stylus upwards (C) until the tip locks into place.



Guide Pins (inside)

Caution:

- Do not remove or bend the stylus.
- Do not touch the needle to avoid injury to your hand.
- Turn off the unit's power before you replace the stylus.
- Keep out of reach of children

Specifications

GENERAL

Power Requirements	AC 100-240V~50/60 Hz
Power Consumption	20W
Dimensions (W x H x D)	460mm x 243mm x 335mm (approx.)
	18" x 9.6" x 13.2" (approx.)
Weight	12 kg. (approx.)
	26.5 lbs. (approx)

AMPLIFIER

Output Power	5 W + 5 W
Frequency Response	60 to 20,000 Hz

SPEAKER SYSTEM

Type	1-way
Impedance	8 ohms
Input Power	Max. 10W

FM Radio

Range	88 to 108 MHz
-------------	---------------

CD PLAYER

Frequency Response	60 to 20,000 Hz +/-4 dB
Signal-to-Noise Ratio	55 dB (IEC-A)

CASSETTE PLAYER

Track System	4 Track, 2 channel stereo
Tape Speed	4.8 cm/sec
Wow and Flutter	0.4% (WRMS)
Frequency Response	125 to 6300 Hz +/-6 dB

RECORD PLAYER

Motor	DC servo motor
Drive System	Belt Drive
Speeds	33-1/3 rpm, 45 rpm and 78 rpm
S/N Ratio	More than 50 dB
Cartridge Type	Ceramic Stereo Cartridge
Stylus	ITNP-LC1

BLUETOOTH

Bluetooth Version	Bluetooth V4.2
Bluetooth Profiles	A2DP, AVRCP
Bluetooth Frequency range	2.402GHz-2.480GHz
Operating Distance	10 meters (33 ft.)

USB

Type	USB series B connector
Full-Speed	USB 2.0 full speed

Troubleshooting Guide

	Symptom	Possible Cause	Solution
GENERAL	• Unit will not power on.	• Unit is unplugged.	• Connect the unit to the AC power supply.
	• No sound output from speakers.	• The volume level is set too low. • The input selector does not match the playback source.	• Adjust the volume. • Select the correct input source.
	• Noise/Distortion in sound output.	• The unit is too close to a TV set or another interfering device.	• Turn off the TV or other appliance, and relocate the unit.
	• Unit fails to respond.	• It might result from external factors such as ESD (Electro-static discharge).	• Disconnect the power cord and external audio device. Re-plug the power cord after one minute.
TAPE	• The tape does not play.	• The cassette tape is not inserted properly. • The tape has reached the end.	• Insert the cassette tape correctly. • Flip the cassette.
FM RADIO	• Cannot listen to any station, or signal appears weak.	• The station is not tuned-in properly. • A TV set is being used nearby and is interfering with the radio reception.	• Properly tune-in the desired station. • Turn-off the interfering TV set.
	• The sound is distorted.	• The antenna is not oriented properly.	• Re-orient the antenna until reception improves.
CD PLAYER	• CD stops immediately after starting, or unit pauses or stops during play.	• The CD is inserted upside down. • The CD is dusty or dirty or there is condensation on the CD.	• Insert the CD with the printed side right-side up. • Carefully clean and dry the CD.
	• No sound.	• The CD player is paused.	• Press the PLAY/PAUSE button.
	• CD playback is noisy, or playback stops or skips.	• The CD is scratched, damaged or warped. • The disc is very dirty.	• Replace CD with an undamaged one. • Carefully clean the CD.
	• CD tray will not open.	• AUX/PHONO/BLUETOOTH/USB/TAPE/FM mode is selected.	• Select CD mode.
	• Buttons are not functioning correctly.	• The unit is processing information ("--- Busy" is displayed) • The unit needs to be restarted	• Wait until the unit finishes processing. • Turn the unit off, then on again.
PHONO	• Decline in turntable audio performance	• The turntable stylus is worn out	• Replace the stylus.

AUX	<ul style="list-style-type: none"> No sound output with external audio device plugged into rear AUX in jack. 	<ul style="list-style-type: none"> Both AUX in jacks (front and rear) are plugged. 	<ul style="list-style-type: none"> Unplug the front AUX in Jack.
Bluetooth	<ul style="list-style-type: none"> No sound 	<ul style="list-style-type: none"> The unit is not switched to Bluetooth mode Your device's and/or the unit's volume is not turn up. Your device is too far from the unit or there're some obstacle between your device and the unit 	<ul style="list-style-type: none"> Ensure the unit is switched to BT mode. Move your Bluetooth device closer to unit Turn up the volume on your portable device and/or the unit. Turn OFF your Bluetooth device and unit. Then power them both back ON
	<ul style="list-style-type: none"> Sound has a lot of static 	<ul style="list-style-type: none"> Your device is too far away 	<ul style="list-style-type: none"> Bring your device closer to the turntable
	<ul style="list-style-type: none"> Unable to pair with a Bluetooth device 	<ul style="list-style-type: none"> Your device doesn't have Bluetooth connectivity. The Bluetooth pairing is not successful 	<ul style="list-style-type: none"> Confirm that your device is Bluetooth compatible. Re-pair the unit and device again.
USB	<ul style="list-style-type: none"> The USB drive does not play 	<ul style="list-style-type: none"> The USB drive is not inserted properly. The USB drive has no MP3 file 	<ul style="list-style-type: none"> Insert the USB drive correctly.

FCC Statement

This device complies with Part 15 of the FCC Rules. Operation is subject to the following two conditions: (1) This device may not cause harmful interference, and (2) this device must accept any interference received, including interference that may cause undesired operation.

NOTE: This equipment has been tested and found to comply with the limits for a Class B digital device, pursuant to Part 15 of the FCC Rules. These limits are designed to provide reasonable protection against harmful interference in a residential installation. This equipment generates uses and can radiate radio frequency energy and, if not installed and used in accordance with the instructions, may cause harmful interference to radio communications. However, there is no guarantee that interference will not occur in a particular installation. If this equipment does cause harmful interference to radio or television reception, which can be determined by turning the equipment off and on, the user is encouraged to try to correct the interference by one of the following measures:

- Reorient or relocate the receiving antenna.
- Increase the separation between the equipment and receiver.
- Connect the equipment into an outlet on a circuit different from that to which the receiver is connected.
- Consult the dealer or an experienced radio/TV technician for help.

WARNING: Any changes or modifications not expressly approved by the party responsible for compliance could void the user's authority to operate this equipment.

The device must not be co-located or operating in conjunction with any other antenna or transmitter.

To maintain compliance with the FCC's RF exposure guidelines, place the product at least 20cm from nearby persons.

IC Statement

This device complies with RSS247 of Industry Canada. Cet appareil se conforme à RSS247 de Canada d'Industrie. This device complies with Industry Canada license-exempt RSS standard(s). Operation is subject to the following two conditions: (1) this device may not cause interference, and (2) this device must accept any interference, including interference that may cause undesired operation of the device. Le présent appareil est conforme aux CNR d'Industrie Canada applicables aux appareils radio exempts de licence. Son fonctionnement est sujet aux deux conditions suivantes: (1) le dispositif ne doit pas produire de brouillage préjudiciable, et (2) ce dispositif doit accepter tout brouillage reçu, y compris un brouillage susceptible de provoquer un fonctionnement indésirable.

The device must not be co-located or operating in conjunction with any other antenna or transmitter. L'appareil ne doit pas être localisé ou fonctionner en conjonction avec d'autres antennes ou transmetteurs. This device complies with IC radiation exposure limits set forth for an uncontrolled environment. Cet appareil est conforme aux limites d'exposition aux rayonnements de la IC établies pour un incontrôlé environnement.

The device should be installed and operated with a minimum distance of 20cm between the radiator and your body. L'appareil doit être installé et utilisé avec une distance minimale de 20cm entre le radiateur et votre corps.

California PROP 65 Warning



WARNING: This product can expose you to chemicals including lead, which is known to the State of California to cause cancer and birth defects or other reproductive harm.

For more information go to www.P65Warnings.ca.gov.