

INSTRUCTION MANUAL

MODEL: VTA-320B

Music Center with Bluetooth

 <p>The lightning flash with arrowhead within an equilateral triangle is intended to alert the user to the presence of uninsulated "dangerous voltage" within the product's enclosure that may be of sufficient magnitude to constitute a risk of electric shock to persons.</p>	<p style="text-align: center;">CAUTION</p> <p style="text-align: center;">RISK OF ELECTRIC SHOCK DO NOT OPEN</p> <p>CAUTION: TO PREVENT RISK OF ELECTRIC SHOCK, DO NOT REMOVE COVER (OR BACK). NO USER-SERVICEABLE PARTS INSIDE. REFER SERVICING TO QUALIFIED SERVICE PERSONNEL.</p>	 <p>The exclamation point within an equilateral triangle is intended to alert the user to the presence of important operating and maintenance (servicing) instructions in the literature accompanying the appliance.</p>
---	---	---

CAUTION: To reduce the risk of fire or electric shock, do not expose this appliance to rain or moisture.

WARNING: To prevent electric shock, do not use this (polarized) plug with an extension cord, receptacle or other outlet unless the blades can be fully inserted to prevent blade exposure.

Important Safety Instructions

1. Read these instructions – All the safety and operating instructions should be read before this product is operated.
2. Keep these instructions – The safety and operating instructions should be retained for future reference.
3. Heed all warnings – All warnings on the appliance and in the operating instructions should be adhered to.
4. Follow all instructions – All operating and use instructions should be followed.
5. Do not use this apparatus near water – The appliance should not be used near water or moisture – for example, in a wet basement or near a swimming pool, and the like.
6. Clean only with dry cloth.
7. Do not block any ventilation openings. Install in accordance with the manufacturer's instructions.
8. Do not install near any heat sources such as radiations, heat registers, stoves, or other apparatus (including amplifiers) that produce heat.
9. Do not defeat the safety purpose of the polarized or grounding plug. A polarized plug has two blades with one wider than the other. A grounding plug has two blades and a third grounding prong. The wide blade or the third prong is provided for your safety. If the provided plug does not fit into your outlet, consult an electrician for replacement of the obsolete outlet.
10. Protect the power cord from being walked on or pinched particularly at the plugs, convenience receptacles, and at the point where they exit from the apparatus.
11. Only use attachments/accessories specified by the manufacturer.
12. Use only with the cart, stand, tripod, bracket, or table specified by the manufacturer, or sold with the apparatus. When a cart or rack is used, use caution when moving the cart/apparatus combination to avoid injury from tip-over.
13. Unplug the apparatus during lightning storms or when unused for long periods of time.
14. Refer all servicing to qualified personnel. Servicing is required when the apparatus has been damaged in any way, such as power supply cord or plug is damaged, liquid has been spilled or objects have fallen into the apparatus has been exposed to rain or moisture, does not operate normally, or has been dropped.



15.



-This lightning flash with arrowhead symbol within an equilateral triangle is intended to alert the user to the presence of non-insulated "dangerous voltage" within the product's enclosure that may be of sufficient magnitude to constitute a risk of electric shock.

-Warning: To reduce the risk of electric shock, do not remove cover (or back) as there are no user-serviceable parts inside. Refer servicing to qualified personnel.

-The exclamation point within an equilateral triangle is intended to alert the user to the presence of important operating and maintenance instructions in the literature accompanying the appliance.

16.



This equipment is a Class II or double insulated electrical appliance. It has been designed in such a way that it does not require a safety connection to electrical earth.

17. The mains plug is used as disconnect device, the disconnect device shall remain readily operable.

18. WARNING

To reduce the risk of fire or electric shock, do not expose this apparatus to rain or moisture. The apparatus shall not be exposed to dripping or splashing and that no objects filled with liquids, such as vases, shall not be placed on apparatus.

19. The use of the equipment in moderate climate.

20. The ventilation should not be impeded by covering the ventilation openings with items such as, newspapers, tablecloths, curtains, etc.

21. No naked flame sources, such as lighted candles, should be placed on the apparatus.

22. The symbol with  Indication AC voltage.

23. CAUTION: These servicing instructions are for use by qualified service personnel only. To reduce the risk of electric shock, do not perform any servicing other than that contained in the operating instructions unless you are qualified to do so.

24. WARNING: Please refer to the information on the exterior bottom enclosure for electrical and safety information before installing or operating the apparatus.

ACCESSORIES INCLUDED:

- RCA LINE OUT CABLE
- INSTRUCTION MANUAL
- WARRANTY (BACK OF MANUAL)
- 45 RPM ADAPTER
- TURNTABLE OPERATION SHEET
- 3 REPLACEMENT NEEDLES
- 1 VINYL CLEANING CLOTH

Product Overview

Front View

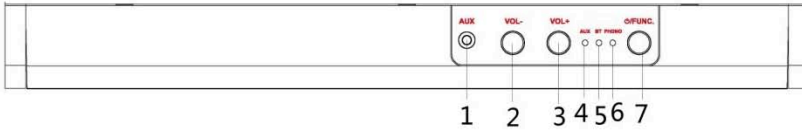

1. **3.5mm AUX-IN JACK:** Connect your external source to the AUX-IN jack.
2. **VOL-:** When unit is ON, press or press and hold to decrease the volume.
3. **VOL+:** When unit is ON, press or press and hold to increase the volume.
4. **AUX INDICATOR:** In AUX IN mode, it will light up.
Once you set the volume to maximum, AUX indicator will start flashing.
5. **BLUETOOTH INDICATOR:** Indicator will illuminate in BT mode.
6. **PHONO INDICATOR:** Indicator will light up in PHONO mode.
7. **POWER \odot /FUNC.:** Press about 3-5 seconds to turn the unit on or off.
When unit is ON, press to select function(AUX IN/BT/PHONO).

Rear View

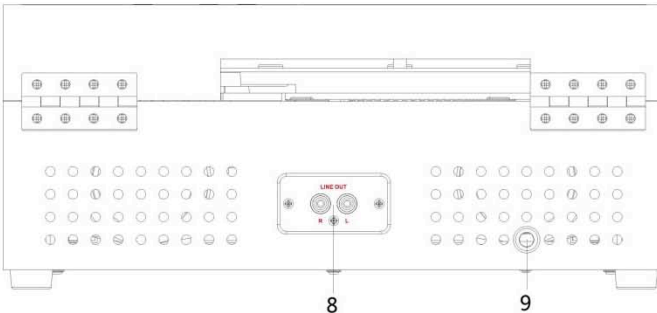

8. **LINE OUT jacks**
For amplifier device with RCA auxiliary input sockets, insert the white and red plugs on the RCA cable into the unit. Insert the opposite end into the amplifier device. *Be sure to connect the white plug to the white jack and the red plug to the red jack.*
9. **AC Power Cord**
Connect the AC plug into a wall outlet.
It is strongly recommended that this product be operated only from the type of power source indicated on the marking label.

Parts of the Turntable

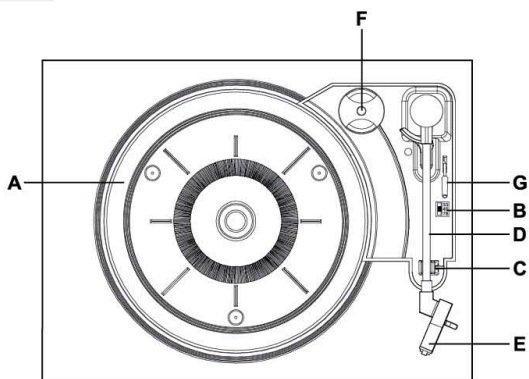

- A. Turntable
- B. Speed Selector
- C. Tone Arm holder
- D. Tone Arm - Before use, completely loosen the twist tie on the tone arm to lift tone arm.
- E. Stylus
- F. 45 RPM adaptor
- G. Cue-lever - Use this lever to lift the tone arm.

Setup / Basic Operation

Setup

1. Remove white protective needle cover by gently pulling towards front of unit.
2. Remove any packaging materials from the unit.
3. Connect the AC power cord to a wall outlet.

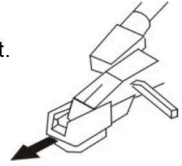
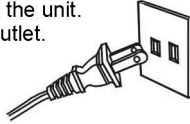

Note:

- It is strongly recommended that this product should be operated only from the type of power source indicated on the marking label.
- To prevent interference, avoid bundling audio signal cables together with the AC power cord.

Basic Operation

1. Press the POWER/FUNC. button about 3-5 seconds to turn the unit on. The indicator will light up following by the previously used operating mode.
2. Select the source by pressing the POWER/FUNC. button quickly. (AUX / BT / PHONO).
3. Press the button VOL+ or VOL- to adjust to the desired sound level. Or press and hold the button VOL+ or VOL- to quickly adjust to the desired sound level.

Note:

- Do not close the turntable cover while a record is in the unit.

Listening through RCA LINE OUT

For amplifier device listening, first reduce the volume level to minimum. Insert the white and red plugs of the RCA cable into the corresponding colors on the unit. Then insert the opposite end into the amplifier device.

Be sure to connect the white plug to the white jack and the red plug to the red jack.

CONDENSATION WARNING:

When the unit is moved from a cold or warm place, or is used following a sudden temperature change, there is the danger that water vapor in the air may condense on the unit, preventing proper operation. In such cases, leave the unit for 1-2 hours after plugging it into an AC outlet to allow it to stabilize at the temperature of its surroundings.

Listening to an External Audio Device (BT Mode)

In BT (Bluetooth) mode, this unit can play music from an external device with the Bluetooth feature.

GETTING CONNECTED USING BLUETOOTH

1. Press the button POWER/FUNC. to select Bluetooth function.
2. The Bluetooth indicator will flash.
3. Set the Bluetooth function of your external device when the apparatus is on.
4. Set to search Bluetooth device on your external device.
NOTE: The effective distance between your external device and this apparatus is 33ft (10 meters).
5. When "VTA-320B" appears on the paired devices list on your external device, press "VTA-320B" to connect.
If a password is required, use "0000" then press "OK" on your external device.
6. When your Bluetooth connection is successful, Bluetooth LED indicator will remain lit.
7. Control playback from your external device.

NOTE: All operations are only available on your external device.

Listening to an External Audio Device (AUX Mode)

Press the button POWER/FUNC. to select AUX IN function. AUX IN indicator will light up.
In AUX (auxiliary) mode, this unit can play audio from an external audio source (iPod, MP3 Player, Portable CD Player, etc.)

There is a AUX-IN jack on the front side of the unit. When connecting a device that has a headphone jack, use the cable with 3.5mm plugs on either end with the front AUX-IN jack.

1. Plug one end of the AUX-IN cable (not included) into the AUX-IN jack.
2. Plug the other end of the cable into the headphone jack of the external audio source.

NOTE: All operations are only available on your external device.

Listening to a Vinyl Record

1. Press the button POWER/FUNC. to select PHONO function. PHONO indicator will light up.
2. Gently open the top cover.
Note: *Be careful not to pinch your finger when opening/closing the top cover.*
3. Place a vinyl record on the turntable. When playing a 45 RPM record, use the included adaptor.

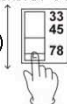
4. Select the appropriate speed (4)

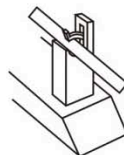

5. Remove the tone arm-rest holder to release the tone arm.
6. Move the tone arm gently to the edge of the record (or the starting point of a track). The turntable will begin to turn.
7. When the record reaches the end, the tone arm will stop at the center of the record. Lift and return the tone arm to the tone arm rest manually. Lock the tone arm-rest holder to protect the tone arm.

Important:

- Closing the top cover will help prevent dust from settling on the turntable.
- Always relock the tone arm clip before transporting the unit.
- Do not place anything on top of the turntable cover, especially while playing a record.
- Do not close the turntable cover while a record is in the unit.

Maintenance / Proper Handling

Handling Vinyl Records

- Do not touch the record's grooves. Only handle records by the edges or the label with clean hands. Touching the record surface will cause your record's quality to deteriorate.
- To clean a record, use a soft anti-static cloth to gently wipe the record surface.
- Keep records in their protective sleeves when not in use.
- Always store records upright on their edges
- Avoid placing records in direct sunlight, close to a heat source (radiators, stoves, etc.), or in a location subject to vibration, excessive dust, heat, cold or moisture.

General Care

- When removing the power plug from the wall outlet, always pull directly on the plug. Never pull the cord.
- To keep the laser pickup clean, do not touch it, and do not forget to close the disc tray.
- Do not attempt to clean the unit with chemical solvents as this might damage the finish.
- For cleaning, only use a clean, dry cloth.
- In order to shut off the power to this product completely, unplug the power cord from the wall outlet. Be sure to unplug the unit if you do not intend to use it for an extended period of time.

How to Replace the Turntable Stylus (*Replacement Needle # ITNP-LC1*)

The stylus should last about 50 hours under normal use. However, it is recommended that the stylus be replaced as soon as you notice a change in sound quality. Prolonged use of a worn-out stylus may damage the record. The highest speed of 78 RPM records would wear out the stylus more quickly.

Removing the old stylus:

1. Set a screwdriver at the tip of the stylus and push downward (A).
2. Remove the stylus by pulling it simultaneously downward and forward.

Installing a new stylus:

1. Hold the front tip of the stylus and insert its rear edge (B) first.
2. Push the stylus upwards (C) until the tip locks into place.

Caution:

- Do not bend the stylus.
- Do not touch the needle to avoid injury your hand.
- Turn off the unit's power before you replace the stylus.
- Keep out of reach of children.



Guide Pins (inside)

Specifications

GENERAL

Power Requirements	AC 100-240 V~50/60 Hz
Power Consumption	10 W
Dimensions (W x D x H)	13.8 in x 13 in x 5.9 in (approx.) 351 x 330 x 150mm (approx.)
Weight	8.8 lbs (approx.) 4 kg. (approx.)

AMPLIFIER

Output Power	3 W + 3 W
Frequency Response	60 to 20,000 Hz

SPEAKER SYSTEM

Type	2-way
Impedance	4 ohms
Input Power	Max. 5W

RECORD PLAYER

Motor	DC servo motor
Drive System	Belt Drive
Speeds	33-1/3 RPM, 45 RPM and 78 RPM
S/N Ratio	More than 50 dB
Cartridge Type	Ceramic Stereo Cartridge
Stylus	ITNP-LC1

BLUETOOTH

Bluetooth Version	Bluetooth V4.2
Bluetooth Profiles	A2DP, AVRCP
Bluetooth Frequency range	2.402GHz-2.480GHz
Operating Distance	33 feet / 10 meters

Troubleshooting Guide

	Symptom	Possible Cause	Solution
GENERAL	• Unit will not power on.	• Unit is unplugged.	• Connect the unit to the AC power supply.
	• No sound output from speakers.	• The volume level is set too low. • The input selector does not match the playback source.	• Adjust the volume. • Select the correct input source.
	• Noise/Distortion in sound output.	• The unit is too close to a TV set or another interfering device.	• Turn off the TV or other appliance, and relocate the unit.
	• Unit fails to respond.	• It might result from external factors such as ESD (Electro-static discharge).	• Disconnect the power cord and external audio device. Re-plug the power cord after one minute.
PHONO	• Decline in turntable audio performance.	• The turntable stylus is worn out.	• Replace the stylus.
AUX	• No sound output with external audio device plugged into AUX in jack.	• The unit is not in AUX mode.	• Ensure the unit is switched to AUX mode.
BLUETOOTH	• No sound.	• The unit is not switched to Bluetooth mode. • Your device's and/or the unit's volume is not turned up. • Your device is too far from the unit or there is some obstacle between your device and the unit.	• Ensure the unit is switched to BT mode. • Move your Bluetooth device closer to unit. • Turn up the volume on your portable device and/or the unit. • Turn off your Bluetooth device and unit then power them both back on.
	• Sound is garbled.	• Your device's and/or the unit's volume is not adjusted properly.	• Turn down the volume on your device/phone and the unit.
	• Unable to pair with a Bluetooth device.	• Your device doesn't have Bluetooth connectivity. • The Bluetooth pairing is not successful.	• Confirm that your device is Bluetooth compatible. • Pair the unit and device again.

FCC Statement

This device complies with Part 15 of the FCC Rules. Operation is subject to the following two conditions: (1) This device may not cause harmful interference, and (2) this device must accept any interference received, including interference that may cause undesired operation.

NOTE: This equipment has been tested and found to comply with the limits for a Class B digital device, pursuant to Part 15 of the FCC Rules. These limits are designed to provide reasonable protection against harmful interference in a residential installation. This equipment generates uses and can radiate radio frequency energy and, if not installed and used in accordance with the instructions, may cause harmful interference to radio communications. However, there is no guarantee that interference will not occur in a particular installation. If this equipment does cause harmful interference to radio or television reception, which can be determined by turning the equipment off and on, the user is encouraged to try to correct the interference by one of the following measures:

- Reorient or relocate the receiving antenna.
- Increase the separation between the equipment and receiver.
- Connect the equipment into an outlet on a circuit different from that to which the receiver is connected.
- Consult the dealer or an experienced radio/TV technician for help.

WARNING: Any changes or modifications not expressly approved by the party responsible for compliance could void the user's authority to operate this equipment.

The device must not be co-located or operating in conjunction with any other antenna or transmitter.

To maintain compliance with the FCC's RF exposure guidelines, place the product at least 20cm from nearby persons.

IC Statement

This device complies with RSS247 of Industry Canada. Cet appareil se conforme à RSS247 de Canada d'Industrie. This device complies with Industry Canada license-exempt RSS standard(s). Operation is subject to the following two conditions: (1) this device may not cause interference, and (2) this device must accept any interference, including interference that may cause undesired operation of the device. appareils radio exempts de licence. Son fonctionnement est sujet a ux deux conditions suivantes: (1) le dispositif ne doit pas produire de brouillage prejudiciable, et (2) ce dispositif doit accepter tout brouillage recu, y compris un brouillage susceptible de provoquer un fonctionnement indesirable.

The device must not be co-located or operating in conjunction with any other antenna or transmitter. L'appareil ne doit pas être localise ou fonctionner avec d'autres antennes ou transmetteurs.

This device complies with IC radiation exposure limits set forth for an uncontrolled environment. Cet appareil est conforme aux limites d'exposition aux rayonnements de la IC établies pour un incontrôlé environnement.

The device should be installed and operated with a minimum distance of 20cm between the radiator and your body. L'appareil doit être installé et utilisé avec une distance minimale de 20 cm entre le radiate et votre corps.

California PROP 65 Warning



WARNING: This product can expose you to chemicals including lead, which is known to the State of California to cause cancer and birth defects or other reproductive harm. For more information go to www.P65Warnings.ca.gov.