

FCC TEST REPORT
for
SHENZHEN AUKEY E-BUSINESS CO., LTD.

Speaker

Model Number : SK-A6

FCC ID: 2AFHPSK-A6

Prepared for : SHENZHEN AUKEY E-BUSINESS CO., LTD.
Address : Room 102, Bld P09, Huanan International Zone, No.1
Huanan Rd., PinghuTown Longgang District, Shenzhen,China.

Prepared by : Keyway Testing Technology Co., Ltd.
Address : Building 1, Baishun Industrial Zone, Zhangmutou Town,
Dongguan, Guangdong, China

Tel: 86-769-8718 2258

Fax: 86-769-8718 1058

Report No. : 17KWE055432F
Date of Test : Apr.22 ~29, 2017
Date of Report : May . 4, 2017

TABLE OF CONTENTS

Test Report Declaration	Page
1. TEST SUMMARY.....	4
2. GENERAL PRODUCT INFORMATION.....	5
2.1 Product Function.....	5
2.2 Description of Device (EUT).....	5
2.3 Channel List.....	5
2.4 Independent Operation Modes.....	6
2.5 Test Supporting System.....	6
2.6 TEST SITES.....	6
2.8 List of Test and Measurement Instruments.....	7
3. TEST SET-UP AND OPERATION MODES.....	8
3.1 Principle of Configuration Selection.....	8
3.2 Block Diagram of Test Set-up.....	8
3.3 Special Accessories and Auxiliary Equipment.....	8
3.4 Countermeasures to Achieve EMC Compliance.....	8
4. EMISSION TEST RESULTS.....	9
4.1 Conducted Emission at the Mains Terminals Test.....	9
4.2 Radiated Emission Test.....	14
5. BAND EDGE COMPLIANCE TEST.....	21
5.1 Limits.....	21
5.2 Test setup.....	21
5.3 Test Data.....	21
6. 6DB BANDWIDTH TEST.....	23
6.1 Applicable Standard.....	23
7. OUTPUT POWER TEST.....	26
7.1 Limits.....	26
7.2 Test setup.....	26
7.3 Test result.....	27
8. DUTY CYCLE.....	28
8.1 Test Procedure.....	28
8.2 TEST SETUP.....	28
9. PEAK POWER SPECTRAL DENSITY TEST.....	30
9.1 Limits.....	30
9.2 Test setup.....	30
9.3 Test data.....	30
10. FREQUENCY STABILITY TEST.....	32
10.1. Limit.....	32
10.2. Test Configuration.....	32
10.3. Test procedure.....	32
11. ANTENNA REQUIREMENTS.....	34
11.1 Limits.....	34
11.2 Result.....	34
12. PHOTOGRAPHS OF TEST SET-UP.....	35
13. PHOTOGRAPHS OF THE EUT.....	37

Keyway Testing Technology Co., Ltd.

Applicant: Address:	SHENZHEN AUKEY E-BUSINESS CO., LTD. Room 102, Bld P09, Huanan International Zone, No.1 Huanan Rd., PinghuTown Longgang District, Shenzhen,China.		
Manufacturer: Address:	Musilab Electronic Co., Ltd No.5 Huanwei Street,Fugang,Qingxi Town, Dongguan,Guandong,China		
E.U.T:	Speaker		
Model Number:	SK-A6		
Trade Name:	AUKEY	Serial No.:	-----
Date of Receipt:	Apr.21, 2017	Date of Test:	Apr.22 ~29, 2017
Test Specification:	FCC Part 15, Subpart 15.407: 2016 ANSI C63.10:2013 KDB789033 D02 v01r03		
Test Result:	The equipment under test was found to be compliance with the requirements of the standards applied.		
		Issue Date: May. 3, 2017	
Tested by:	Reviewed by:	Approved by:	
_____	_____	_____	
Keven Wu / Engineer	Mark Li / Supervisor	Andy Gao / Supervisor	
Other Aspects:	None.		
<i>Abbreviations: OK/P=passed fail/F=failed n.a/N=not applicable E.U.T=equipment under tested</i>			
<i>This test report is based on a single evaluation of one sample of above mentioned products. It is not permitted to be duplicated in extracts without written approval of Keyway Testing Technology Co., Ltd.</i>			

1. TEST SUMMARY

Test Items	Test Requirement	Result
Conducted Emissions	15.207	PASS
Radiated Emissions	15.407(b), 15.209	PASS
-6dB bandwidth and 99%dB Bandwidth	15.407 (a)	PASS
6dB bandwidth	15.407(e)	PASS
Power density	15.407 (a)	PASS
Maximum Peak Output Power	15.407 (a)	PASS
Emissions from out of band	15.407 (b)	PASS
Frequency Stability	15.407 (g)	PASS
Antenna Requirement	15.203	PASS

2. GENERAL PRODUCT INFORMATION

2.1 Product Function

Refer to Technical Construction Form and User Manual.

2.2 Description of Device (EUT)

Product Name:	Speaker
Model No.:	SK-A6
Operation Frequency:	5.736GHz~5.814GHz
Channel numbers:	3 Channel
Modulation technology:	QPSK (DSSS)
Antenna Type:	PCB ANT
Antenna gain:	ANT A:2.408dBi ANT B:2.408dBi
Power supply:	DC 3.7V2600mA (Inside Battery); DC 5V from adapter or PC

2.3 Channel List

Channel	Frequency (MHz)
01	5736
02	5762
03	5814

2.4 Independent Operation Modes

The basic operation modes are:

2.4.1 EUT work TX mode, and frequency as below:

Channel	Frequency
Low	5736
Middle	5762
High	5814

Antenna A/ B are transmitting, two antennas simultaneously transmit. And the worst data is recorded for radiated emission and band edge.

For MIMO mode , Directional gain=GANT +10log(N)dbi =5.42dbi

The EUT has MIMO mode.

2.5 Test Supporting System

None.

2.6 TEST SITES

Test Facilities

Lab Qualifications : Certified by Industry Canada
 Registration No.: 9868A
 Date of registration: December 8, 2011

Certificated by FCC, USA
 Registration No.: 370994
 Date of registration: February 21, 2012

Certificated by CNAS China
 Registration No.: CNAS L5783
 Date of registration: August 8, 2012

2.8 List of Test and Measurement Instruments

2.8.1 For conducted emission at the mains terminals test

Equipment	Manufacturer	Model No.	Serial No.	Last Cal.	Next Cal.
EMI Test Receiver	Rohde&Schwarz	ESCI	101156	Apr. 08,17	Apr. 08,18
Artificial Mains Network	Rohde&Schwarz	ENV216	101315	Apr. 08,17	Apr. 08,18
Artificial Mains Network (AUX)	Rohde&Schwarz	ENV216	101314	Apr. 08,17	Apr. 08,18
RF Cable	FUJIKURA	3D-2W	944 Cable	Apr. 08,17	Apr. 08,18

2.8.2 For radiated emission test

Equipment	Manufacturer	Model No.	Serial No.	Last Cal.	Next Cal.
EMI Test Receiver	Rohde&Schwarz	ESCI	101156	Apr. 08,17	Apr. 08,18
System Simulator	Agilent	E5515C	GB43130245	Apr. 08,17	Apr. 08,18
Power Splitter	Weinschel	1506A	NW425	Apr. 08,17	Apr. 08,18
Bilog Antenna	ETS-LINDGREN	3142D	135452	Apr. 08,17	Apr. 08,18
Remark: Testable Frequency Range: 26MHz-6GHz					
Spectrum Analyzer	Agilent	E4407B	MY4511304	Apr. 08,17	Apr. 08,18
Remark: Testable Frequency Range: 100Hz-26.5GHz					
Spectrum Analyzer	R&S	FSV40	132.1.3008K39-100967	Apr. 08,17	Apr. 08,18
Remark: Testable Frequency Range: 10Hz-40GHz					
3m Semi-anechoic Chamber	ETS-LINDGREN	966	KW01	Apr. 09,17	Apr. 09,18
Signal Amplifier	SONOMA	310	187016	Apr. 08,17	Apr. 08,18
Signal Amplifier	Agilent	8449B	3008A00251	Apr. 08,17	Apr. 08,18
RF Cable	IMRO	IMRO-400	966 Cable 1#	N/A	N/A
MULTI-DEVICE Controller	ETS-LINDGREN	2090	126913	N/A	N/A
Horn Antenna	DAZE	ZN30701	11003	Apr. 09,17	Apr. 09,18
Remark: Testable Frequency Range: 1GHz-18GHz					
Horn Antenna	SCHWARZBECK	BBHA9170	9170-068	Apr. 09,17	Apr. 09,18
Remark: Testable Frequency Range: 18GHz-40GHz					
Spectrum Analyzer	Agilent	8593E	3911A04271	Apr. 08,17	Apr. 08,18
Remark: Testable Frequency Range: 9kHz-22GHz					
Spectrum Analyzer	Agilent	E4408B	MY44211125	Apr. 08,17	Apr. 08,18
Remark: Testable Frequency Range: 9kHz-26.5GHz					
Signal Amplifier	DAZE	ZN3380C	11001	Apr. 08,17	Apr. 08,18
HighPass filter	Micro	HPM50111	324216	Apr. 08,17	Apr. 08,18
Filter	COM-MW	ZBSF-C836.5-25-X	KW032	Apr. 08,17	Apr. 08,18
Filter	COM-MW	ZBSF-C1747.5-75-X2	KW035	Apr. 08,17	Apr. 08,18
Filter	COM-MW	ZBSF-C1880-60-X2	KW037	Apr. 08,17	Apr. 08,18
Constant temperature and humidity box	GF	GTH-800-40-1P	MAA9906-005	Apr. 08,17	Apr. 08,18
Splitter	Agilent	11636B	0025164	Apr. 08,17	Apr. 08,18
Power Meter	Anritsu	ML2495A	1204003	Apr. 08,17	Apr. 08,18
Power Sensor	Anritsu	MA2411B	1126150	Apr. 08,17	Apr. 08,18
Spectrum Analyzer	Agilent	N9020A	MY56070279	Apr. 08,17	Apr. 08,18
Remark: Testable Frequency Range: 10Hz-26.5GHz					

3. TEST SET-UP AND OPERATION MODES

3.1 Principle of Configuration Selection

Emission: The equipment under test (EUT) was configured to measure its highest possible radiation level. The test modes were adapted accordingly in reference to the Operating Instructions.

3.2 Block Diagram of Test Set-up

System Diagram of Connections between EUT and Simulators

Conducted Emission:

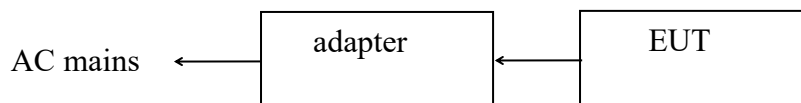

Radiated Emission:



(EUT: Speaker)

3.3 Special Accessories and Auxiliary Equipment

Adapter:	Manufacturer: Cenique Infotainment Group Limited I/P:AC 100~240V 50/60Hz 0.15A O/P:DC 5V/2.1A
----------	---

3.4 Countermeasures to Achieve EMC Compliance

None.

4. EMISSION TEST RESULTS

4.1 Conducted Emission at the Mains Terminals Test

4.1.1 Limit 15.207 limits

Frequency MHz	Limit (dBuV)	
	Quasi-peak	Average
0.15-0.5	66 to 56	56 to 46
0.5-5	56	46
5-30	60	50

NOTE: 1.The lower limit shall apply at the transition frequencies.
2.The limit decreases linearly with the logarithm of the frequency in the range 0,15 MHz to 0,50 MHz.

4.1.2 Test Setup

- 1.The EUT was put on a wooden table which was 0.8 m high above the ground and connected to the AC mains through the Artificial Mains Network (AMN). Where the mains cable supplied by the manufacture was longer than 0.8 m, the excess was folded back and forth parallel to the cable at the center so as to form a bundle no longer than 0.4 m.
- 2.The EUT was kept 0.4 m from any other earthed conducting surface. Both sides of AC line were checked to find out the maximum conducted emission levels according to the test procedure during the conducted emission test.
- 3.The frequency range from 150 kHz to 30 MHz was investigated.
- 4.The bandwidth of the test receiver was set at 9 kHz.
- 5.Pretest for all mode, The test data of the worst case condition(s) was reported on the following page.

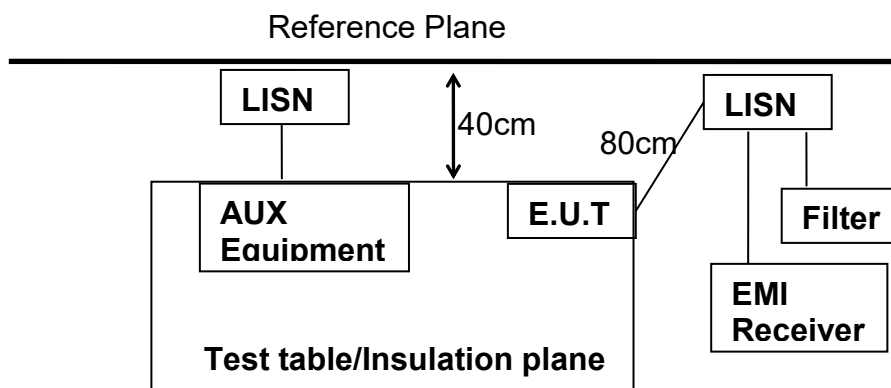

Remark: E.U.T. :Equipment Under Test
LISN: Line Impedance Stabilization Network
Test table height: 0.8m.

Test block

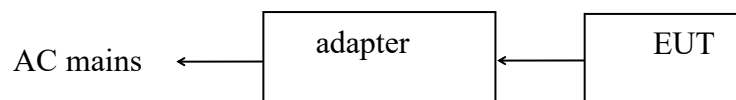

EUT :	Speaker	Model Name :	SK-A6
Temperature :	26 °C	Relative Humidity :	54%
Pressure :	1010hPa	Phase :	Live
Test Voltage :	DC 5.0V from Adapter AC 120V/60Hz	Test Mode :	Link Mode

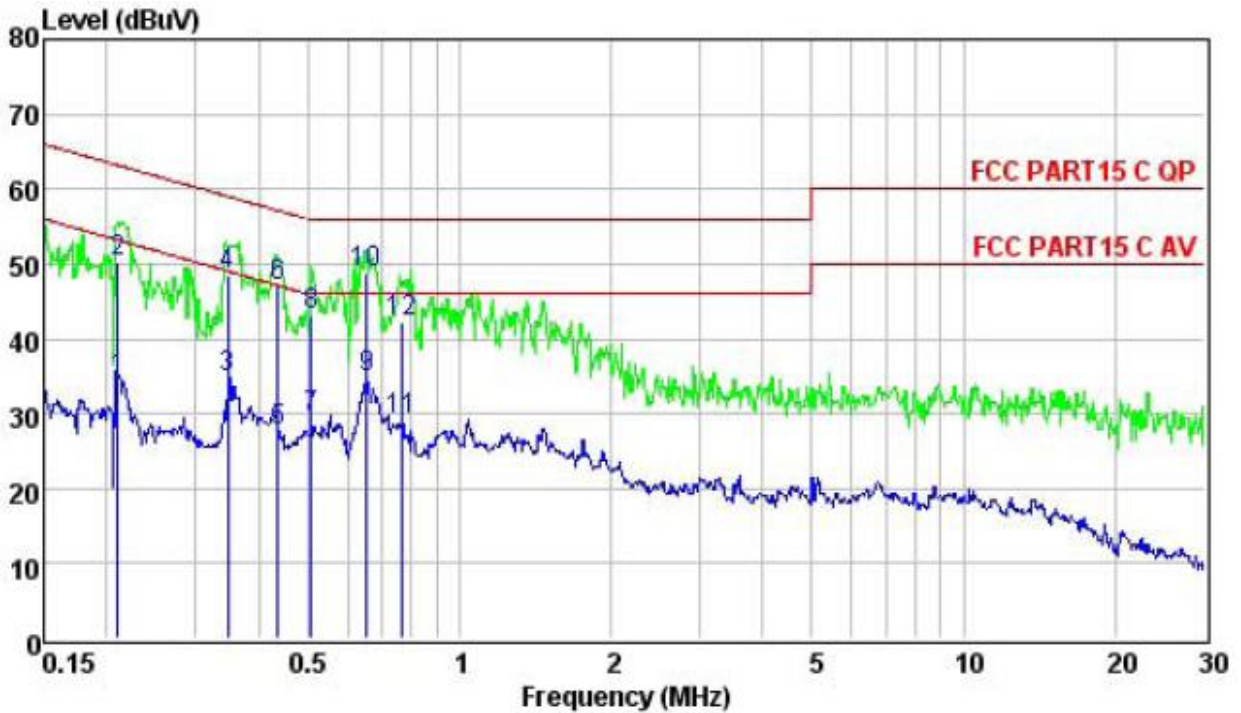

	Freq	Level	Limit	Over	Remark
	MHz	dBuV	dBuV	dB	
1	0.211	34.55	53.18	-18.63	Average
2	0.211	50.20	63.18	-12.98	QP
3	0.348	34.80	49.00	-14.20	Average
4	0.348	48.50	59.00	-10.50	QP
5	0.437	27.62	47.11	-19.49	Average
6	0.437	46.90	57.11	-10.21	QP
7	0.507	29.43	46.00	-16.57	Average
8	0.507	43.20	56.00	-12.80	QP
9	0.654	34.71	46.00	-11.29	Average
10	0.654	48.74	56.00	-7.26	QP
11	0.767	29.29	46.00	-16.71	Average
12	0.767	42.30	56.00	-13.70	QP

EUT :	Speaker	Model Name :	SK-A6
Temperature :	26 °C	Relative Humidity :	54%
Pressure :	1010hPa	Phase :	Neutral
Test Voltage :	DC 5.0V from Adapter AC 120V/60Hz	Test Mode :	Link Mode

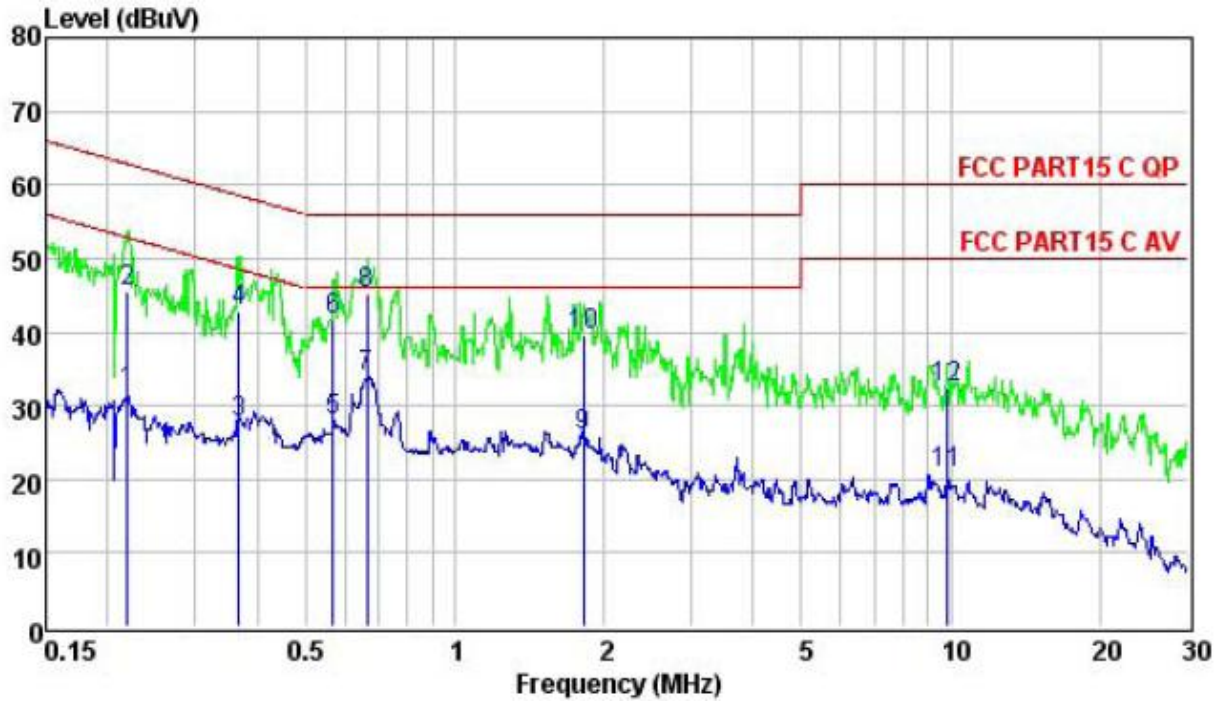

	Freq	Level	Limit	Over	Remark
	MHz	dBuV	dBuV	dB	
1	0.219	31.77	52.88	-21.11	Average
2	0.219	45.60	62.88	-17.28	QP
3	0.367	27.56	48.56	-21.00	Average
4	0.367	42.80	58.56	-15.76	QP
5	0.567	27.88	46.00	-18.12	Average
6	0.567	41.70	56.00	-14.30	QP
7	0.665	34.00	46.00	-12.00	Average
8	0.665	45.26	56.00	-10.74	QP
9	1.819	25.93	46.00	-20.07	Average
10	1.819	39.60	56.00	-16.40	QP
11	9.809	20.67	50.00	-29.33	Average
12	9.809	32.30	60.00	-27.70	QP

EUT :	Speaker	Model Name :	SK-A6
Temperature :	26 °C	Relative Humidity :	54%
Pressure :	1010hPa	Phase :	Live
Test Voltage :	DC 5.0V from Adapter AC 240V/60Hz	Test Mode :	Link Mode

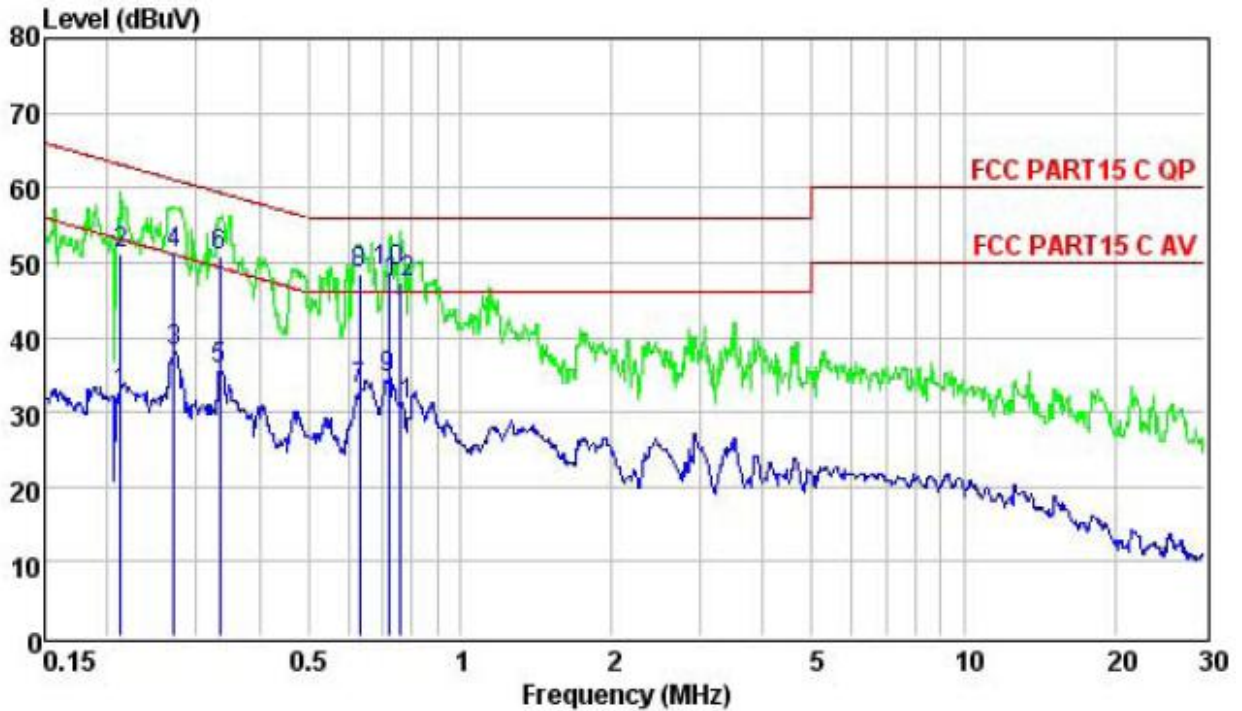

	Freq	Level	Limit	Over	Remark
	MHz	dBuV	Line	Limit	
			dBuV	dB	
1	0.213	32.30	53.10	-20.80	Average
2	0.213	51.30	63.10	-11.80	QP
3	0.272	38.17	51.07	-12.90	Average
4	0.272	51.20	61.07	-9.87	QP
5	0.334	35.57	49.35	-13.78	Average
6	0.334	50.80	59.35	-8.55	QP
7	0.634	32.87	46.00	-13.13	Average
8	0.634	48.40	56.00	-7.60	QP
9	0.720	34.54	46.00	-11.46	Average
10	0.720	48.63	56.00	-7.37	QP
11	0.763	30.96	46.00	-15.04	Average
12	0.763	47.20	56.00	-8.80	QP

EUT :	Speaker	Model Name :	SK-A6
Temperature :	26 °C	Relative Humidity :	54%
Pressure :	1010hPa	Phase :	Neutral
Test Voltage :	DC 5.0V from Adapter AC 240V/60Hz	Test Mode :	Link Mode

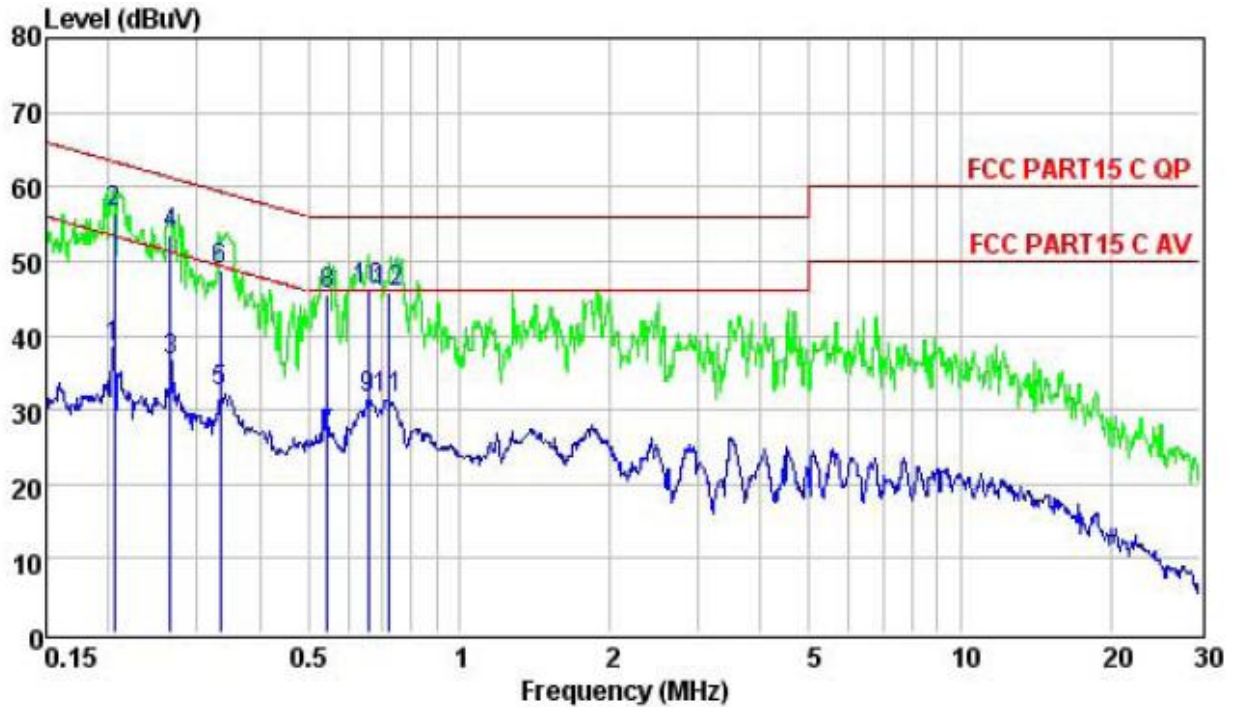

	Freq	Level	Limit	Over	Remark
	MHz	dBuV	dBuV	dB	
1	0.205	38.45	53.40	-14.95	Average
2	0.205	56.63	63.40	-6.77	QP
3	0.266	36.62	51.25	-14.63	Average
4	0.266	53.63	61.25	-7.62	QP
5	0.334	32.45	49.35	-16.90	Average
6	0.334	48.70	59.35	-10.65	QP
7	0.546	26.55	46.00	-19.45	Average
8	0.546	45.50	56.00	-10.50	QP
9	0.658	31.45	46.00	-14.55	Average
10	0.658	46.10	56.00	-9.90	QP
11	0.724	31.66	46.00	-14.34	Average
12	0.724	45.70	56.00	-10.30	QP

4.2 Radiated Emission Test

4.2.1 Limit 15.209 limits

Frequency MHZ	Distance Meters	Filed Strengths Limit	
		$\mu\text{V}/\text{m}$	$\text{dB}(\mu\text{V})/\text{m}$
30~88	3	100	40.0
88~216	3	150	43.5
216~960	3	200	46.0
960~1000	3	500	54.0
Above 1000	3	74.0dB(μV)/m(Peak) 54.0dB(μV)/m(Average)	

4.2.2 Restricted bands of operation

MHz	MHz	MHz	GHz
0.009-0.110	16.42-16.423	399.9-410	4.5-5.15
0.495-0.505	16.69475-16.69525	608-614	5.35-5.46
2.1735-2.1905	16.80425-16.80475	960-1240	7.25-7.75
4.125-4.128	25.5-25.67	1300-1427	8.025-8.5
4.17725-4.17775	37.5-38.25	1435-1626.5	9.0-9.2
4.20725-4.20775	73-74.6	1645.5-1646.5	9.3-9.5
6.215-6.218	74.8-75.2	1660-1710	10.6-12.7
6.26775-6.26825	108-121.94	1718.8-1722.2	13.25-13.4
6.31175-6.31225	123-138	2200-2300	14.47-14.5
8.291-8.294	149.9-150.05	2310-2390	15.35-16.2
8.362-8.366	156.52475-156.52525	2483.5-2500	17.7-21.4
8.37625-8.38675	156.7-156.9	2690-2900	22.01-23.12
8.41425-8.41475	162.0125-167.17	3260-3267	23.6-24.0
12.29-12.293	167.72-173.2	3332-3339	31.2-31.8
12.51975-12.52025	240-285	3345.8-3358	36.43-36.5
12.57675-12.57725	322-335.4	3600-4400	

All the emissions appearing within 15.205 restricted frequency bands shall not exceed the limits shown in 15.209, all the other emissions shall be at least 20dB below the fundamental emissions, or comply with 15.209 limits.

4.2.3 Test setup

The EUT was placed on a turn table which was 0.8 m (above 1GHz, the high was 1.5m) above the ground. The turn table can rotate 360 degrees to determine the position of the maximum emission level. The EUT was set 3 m away from the receiving antenna which was mounted on an antenna tower. The measuring antenna moved up and down to find out the maximum emission level. It moved from 1 m to 4 m for both horizontal and vertical polarizations.

The EUT was tested in the Chamber Site. It was pre-scanned with a Peak detector from the spectrum, and all the final readings from the test receiver were measured with the Quasi-Peak detector.

The bandwidth of the EMI test receiver is set at 120kHz for frequency range from 30MHz to 1000 MHz.

The bandwidth of the Spectrum's VBW is set at 3MHz and RBW is set at 1MHz for peak emissions measurement above 1GHz and 1MHz RBW, 10Hz VBW for average emissions measure above 1GHz, Both PK and AV measure, PK detector is used.

The frequency range from 30MHz to 10th harmonic are checked. and no any emissions were found from 18GHz to 40 GHz, So the radiated emissions from 18GHz to 40GHz were not record.

Notes: 1. Emission Level = Antenna Factor + Cable Loss + Meter Reading - Preamp Factor.

2. Measurement Uncertainty: ± 3.2 dB at a level of confidence of 95%.

3. For emissions above 1GHz, if peak level comply with average limit, then the average level is deemed to comply with average limit.

4. For emissions below 1GHz, pretest for all mode, The test data of the worst case condition(s) was reported on the following pages.

5. For Both PK and AV value above 1GHz, PK detector is used.

Radiated Emission Test-Up Frequency Below 30MHz

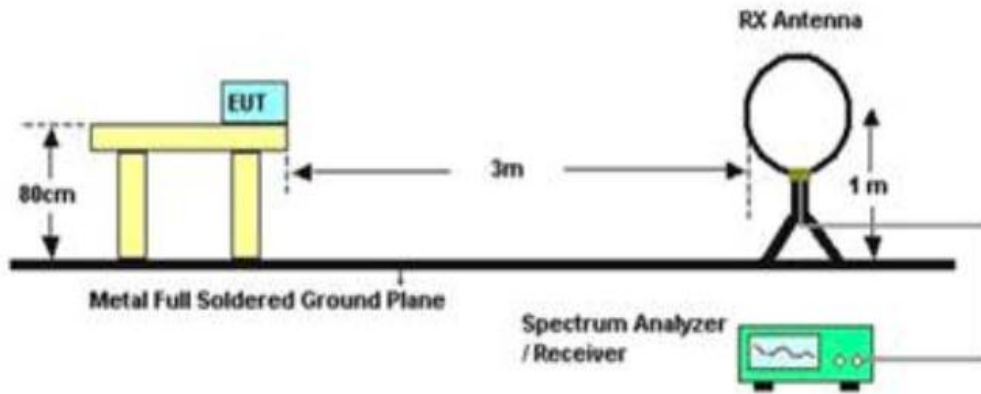

Radiated Emission Test-Up Frequency 30MHz- 1GHz

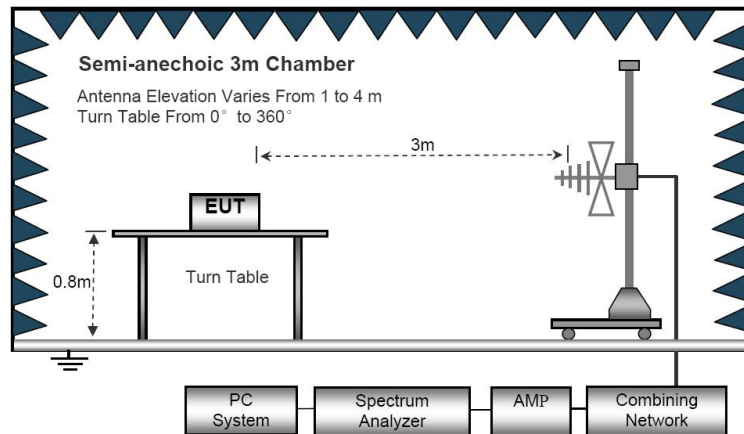

Above 1GHz

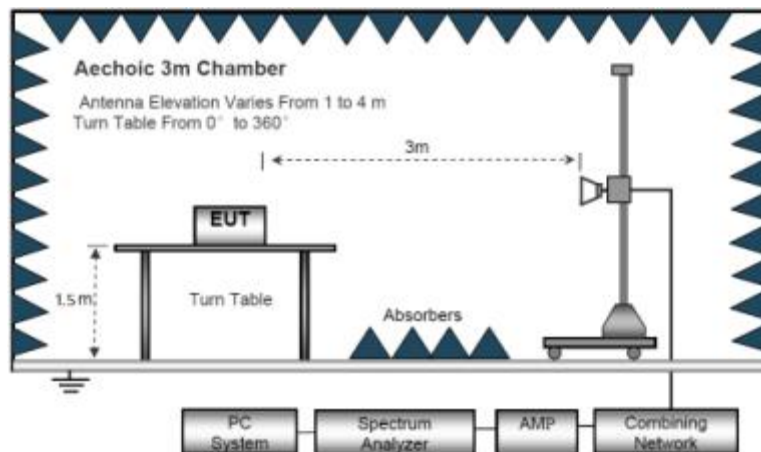

EUT :	Speaker	Model Name :	SK-A6
Temperature :	20 °C	Relative Humidity :	48%
Pressure :	1010hPa	Test Mode :	TX
Test Voltage :	DC 3.7V		

Below 30MHz

Freq.	Reading	Limit	Margin	State
(MHz)	(dBuV/m)	(dBuV/m)	(dB)	P/F
--	--	--	--	P
--	--	--	--	P

Note:

The amplitude of spurious emissions which are attenuated by more than 20dB below the permissible value has no need to be reported.

Distance extrapolation factor = $40 \log (\text{specific distance}/\text{test distance})(\text{dB})$;

Limit line = specific limits(dBuv) + distance extrapolation factor.

Below 1GHz			
EUT :	Speaker	Model Name :	SK-A6
Temperature :	20 °C	Relative Humidity :	48%
Pressure :	1010hPa	Test Mode :	TX - 5736
Test Voltage :	DC 3.7V		

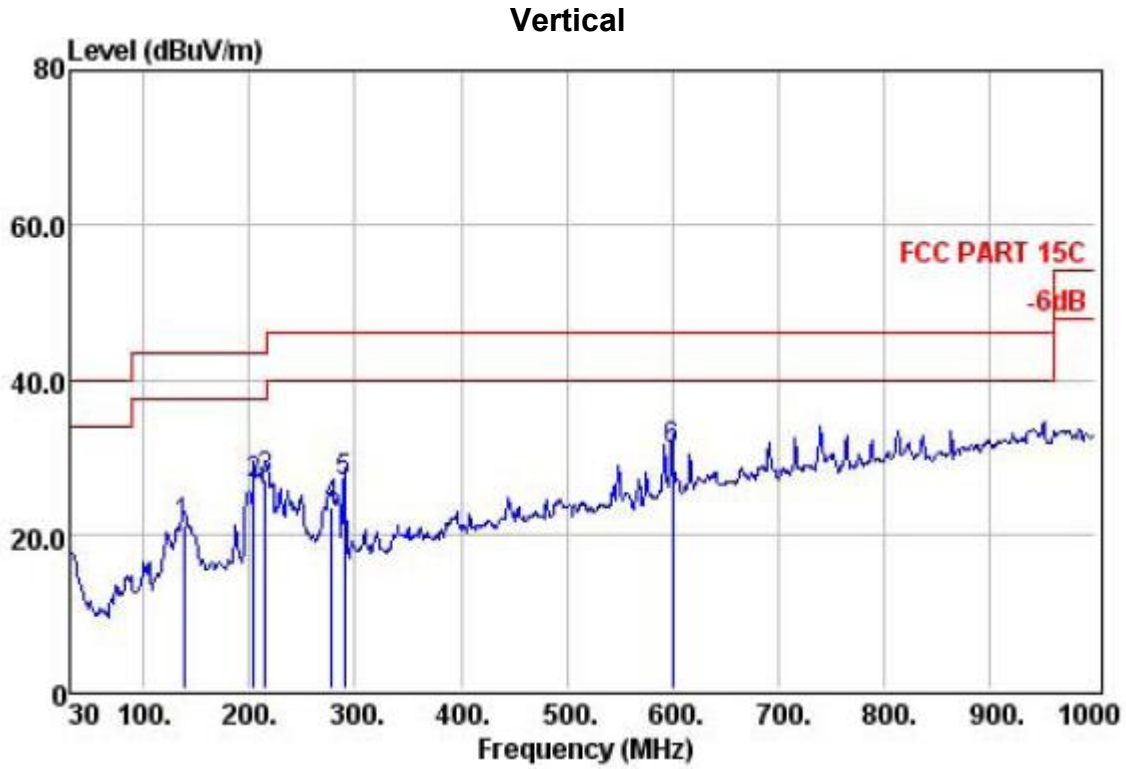

	Preamp Freq	Preamp Factor	Read Level	Cable Loss	Antenna Factor	Level	Limit Line	Over Limit	Remark
	MHz	dB	dBuV	dB	dB/m	dBuV/m	dBuV/m	dB	
1	137.54	31.20	42.57	1.22	8.38	20.97	43.50	-22.53	QP
2	204.30	31.09	44.91	1.46	11.21	26.49	43.50	-17.01	QP
3	214.50	31.04	44.87	1.53	11.70	27.06	43.50	-16.44	QP
4	277.60	30.94	39.52	1.78	13.08	23.44	46.00	-22.56	QP
5	289.80	30.93	42.24	1.87	13.47	26.65	46.00	-19.35	QP
6	600.54	30.62	37.60	3.29	20.62	30.89	46.00	-15.11	QP

Horizontal

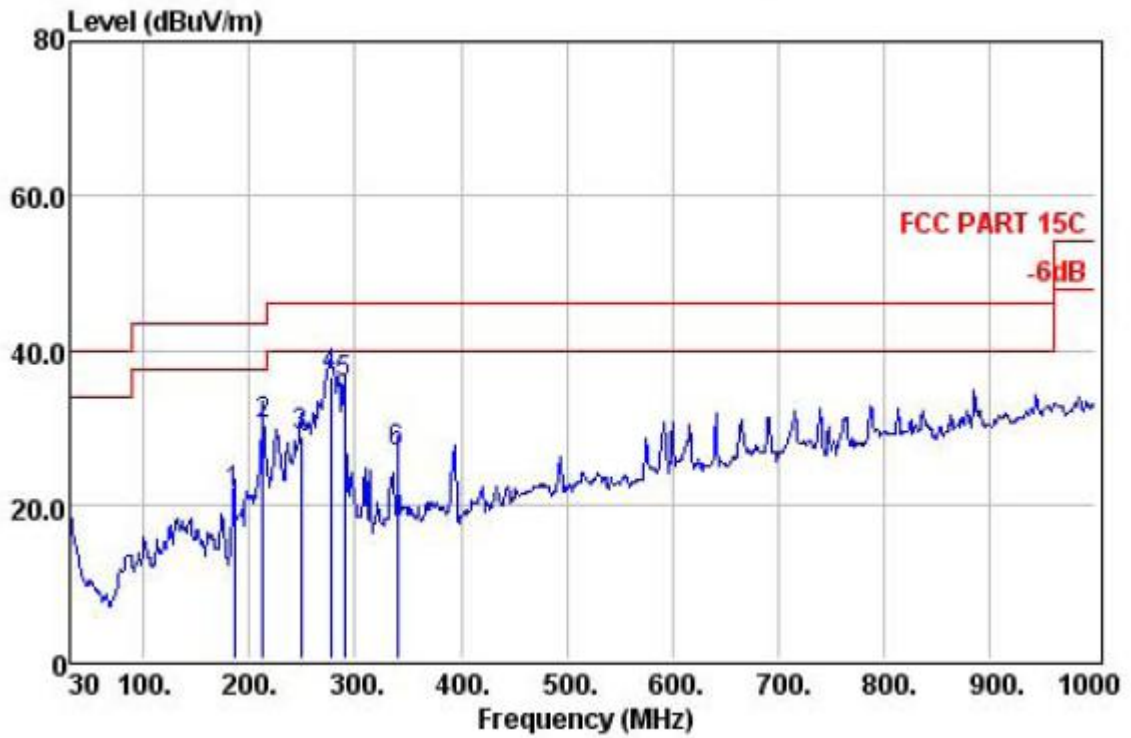

	Preamp Freq	Preamp Factor	Read Level	CableAntenna Loss	Antenna Factor	Level	Limit Line	Over Limit	Remark
	MHz	dB	dBuV	dB	dB/m	dBuV/m	dBuV/m	dB	
1	185.20	31.14	40.79	1.39	10.24	21.28	43.50	-22.22	QP
2	212.36	31.06	48.26	1.53	11.59	30.32	43.50	-13.18	QP
3	248.25	30.96	45.24	1.70	12.85	28.83	46.00	-17.17	QP
4	277.35	30.94	52.61	1.78	13.08	36.53	46.00	-9.47	QP
5	289.87	30.93	51.25	1.87	13.48	35.67	46.00	-10.33	QP
6	340.24	30.71	40.40	2.10	15.11	26.90	46.00	-19.10	QP

NOTE: 1. Absolute Level= Reading Level+antenna Factor+cable loss - Preamp factor,
 2. Over Limit= Absolute Level – Limit;
 3. Mode 1 is the worst mode. Only worst case is presented in the report .

Above 1GHz			
EUT :	Speaker	Model Name :	SK-A6
Temperature :	20 °C	Relative Humidity :	48%
Pressure :	1010hPa	Test Voltage :	DC 3.7V

Frequency	Meter Reading	Antenna Factor	Cable loss	Preamp factor	Emission Level	Limits	Margin	Detector Type	Comment
(MHz)	(dB μ V)	(dB)	(dB)	(dB)	(dB μ V/m)	(dB μ V/m)	(dB)		
TX-5736									
11472	30.46	23.87	21.62	28.95	47.00	54	-7.00	Average	Vertical
11472	42.72	23.87	21.62	28.95	59.26	74	-14.74	peak	Vertical
17208	24.52	24.92	24.48	30.18	43.74	54	-10.26	Average	Vertical
17208	35.57	24.92	24.48	30.18	54.79	74	-19.21	peak	Vertical
11472	30.18	23.87	21.62	28.95	46.72	54	-7.28	Average	Horizontal
11472	42.93	23.87	21.62	28.95	59.47	74	-14.53	peak	Horizontal
17208	24.46	24.92	24.48	30.18	43.68	54	-10.32	Average	Horizontal
17208	35.94	24.92	24.48	30.18	55.16	74	-18.84	peak	Horizontal
TX-5762									
11524	28.63	23.88	21.64	28.95	45.20	54	-8.80	Average	Vertical
11524	41.72	23.88	21.64	28.95	58.29	74	-15.71	peak	Vertical
17286	25.41	25.05	24.52	30.22	44.76	54	-9.24	Average	Vertical
17286	34.45	25.05	24.52	30.22	53.80	74	-20.20	peak	Vertical
11524	28.62	23.88	21.64	28.95	45.19	54	-8.81	Average	Horizontal
11524	41.89	23.88	21.64	28.95	58.46	74	-15.54	peak	Horizontal
17286	25.35	25.05	24.52	30.22	44.70	54	-9.30	Average	Horizontal
17286	34.18	25.05	24.52	30.22	53.53	74	-20.47	peak	Horizontal
TX-5814									
11628	27.84	25.78	21.71	30.18	45.15	54	-8.85	Average	Vertical
11628	39.76	25.78	21.71	30.18	57.07	74	-16.93	peak	Vertical
17442	22.48	27.29	24.59	30.28	44.08	54	-9.92	Average	Vertical
17442	32.52	27.29	24.59	30.28	54.12	74	-19.88	peak	Vertical
11628	27.81	25.78	21.71	30.18	45.12	54	-8.88	Average	Horizontal
11628	39.94	25.78	21.71	30.18	57.25	74	-16.75	peak	Horizontal
17442	22.53	27.29	24.59	30.28	44.13	54	-9.87	Average	Horizontal
17442	32.64	27.29	24.59	30.28	54.24	74	-19.76	peak	Horizontal

NOTE:1.Absolute Level= ReadingLevel+antenna Factor+cable loss-preamp factor.

2.Over Limit= Absolute Level – Limit.

3.The amplitude of spurious emissions which are attenuated by more than 20dB below the permissible value has not to be reported.

4.EUT Pre-scan XYZ orientation, only worst case is presented in the report (Z orientation)

5. BAND EDGE COMPLIANCE TEST

5.1 Limits

For the band 5725-5825 MHz , All emissions shall be limited to a level of -27 dBm/MHz at 75 MHz or more above or below the band edge increasing linearly to 10 dBm/MHz at 25 MHz above or below the band edge, and from 25 MHz above or below the band edge increasing linearly to a level of 15.6 dBm/MHz at 5 MHz above or below the band edge, and from 5 MHz above or below the band edge increasing linearly to a level of 27 dBm/MHz at the band edge.

5.2 Test setup

Test method: FCC KDB 789033 G)& Parts 15.407(b)(4) & 15.209(a)

Same as Clause 4.2.

5.3 Test Data

Please see data as below:

Band Edge, Left Side

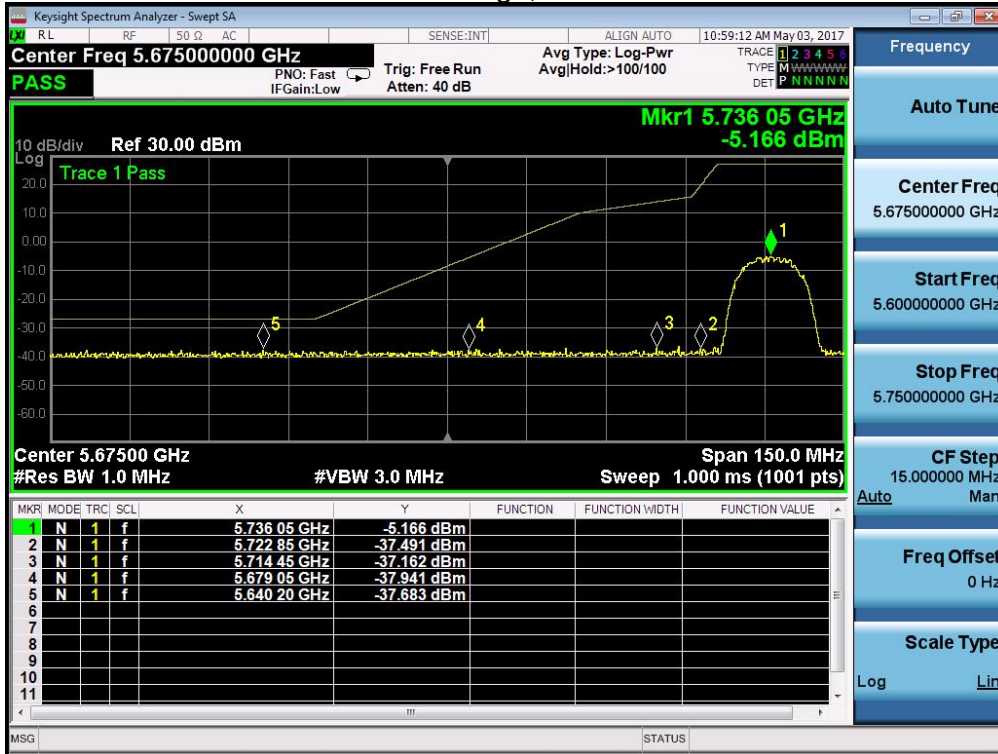

Band Edge, Right Side

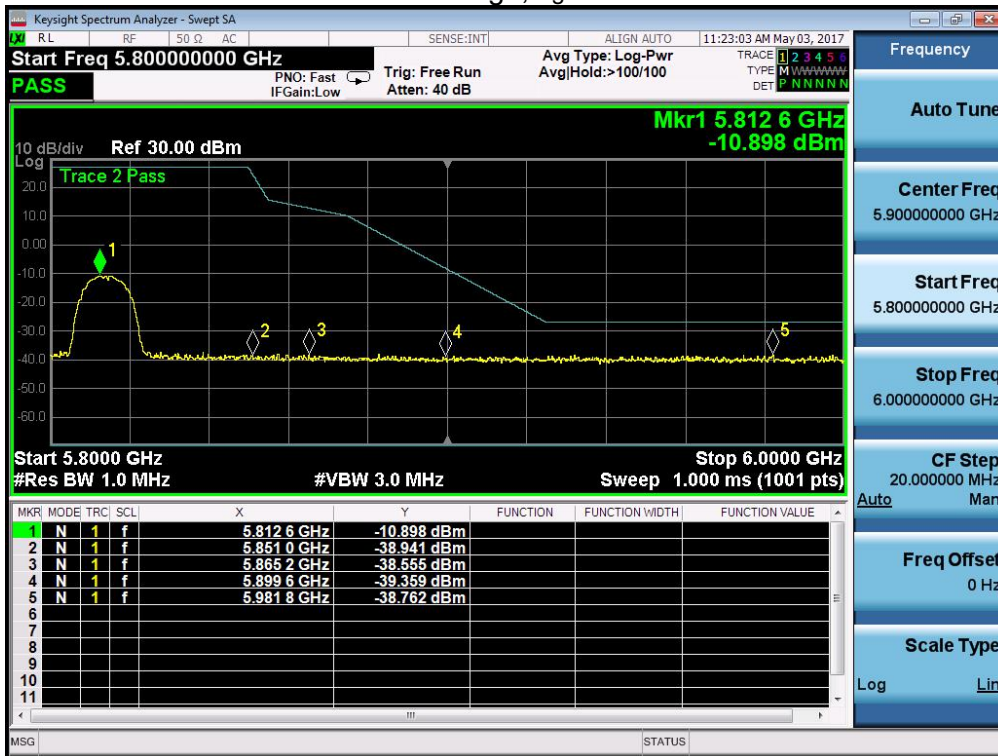

Note: EIRP BAND EDGE=Reading Level+antenna gain

6. 6DB BANDWIDTH TEST

6.1 Applicable Standard

The bandwidth at 6 dB down from the highest in-band spectral density is measured with a spectrum analyzer connected to the antenna terminal while the EUT is operating at its maximum power control level, as defined in KDB 789033, at the appropriate frequencies. The spectrum analyzer’s bandwidth measurement function is configured to measure the 26 dB bandwidth. The 26 dB bandwidth is used to determine the conducted power limits. The minimum of 6dB Bandwidth measurement is 0.5 MHz for U-NII-3

6.2 Test Procedure

1. Emission Bandwidth (EBW)

- a) Set RBW = approximately 1% of the emission bandwidth.
- b) Set the VBW > RBW.
- c) Detector = Peak.
- d) Trace mode = max hold.
- e) Measure the maximum width of the emission that is 26 dB down from the maximum of the emission. Compare this with the RBW setting of the analyzer. Readjust RBW and repeat measurement as needed until the RBW/EBW ratio is approximately 1%.

2. Minimum Emission Bandwidth for the band 5.725-5.85 GHz

Section 15.407(e) specifies the minimum 6 dB emission bandwidth of at least 500 KHz for the band 5.715-5.85 GHz. The following procedure shall be used for measuring this bandwidth:

- a) Set RBW = 100 kHz.
- b) Set the video bandwidth (VBW) $\geq 3 \times$ RBW.
- c) Detector = Peak.
- d) Trace mode = max hold.
- e) Sweep = auto couple.
- f) Allow the trace to stabilize.
- g) Measure the maximum width of the emission that is constrained by the frequencies associated with the two outermost amplitude points (upper and lower frequencies) that are attenuated by 6 dB relative to the maximum level measured in the fundamental emission.

6.3 Test setup

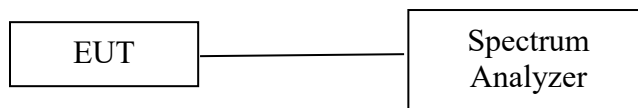

6.4 Test result

Frequency (MHz)	6dB Bandwidth (MHz) ANT A	6dB Bandwidth (MHz) ANT B	Limit (MHz)	99% Bandwidth (MHz) ANT A	99% Bandwidth (MHz) ANT B
5736	9.846	9.850	0.5	10.16	10.18
5762	9.843	9.844	0.5	10.21	10.20
5814	9.844	9.840	0.5	10.23	10.19

5725-5850MHz:-6dB Bandwidth

5736MHz-ANTA

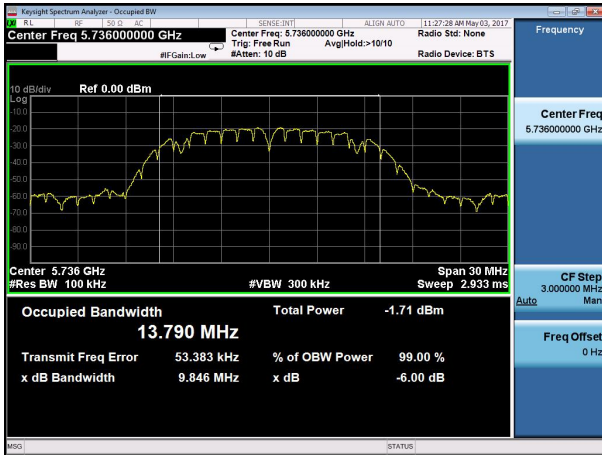

5736MHz-ANTB

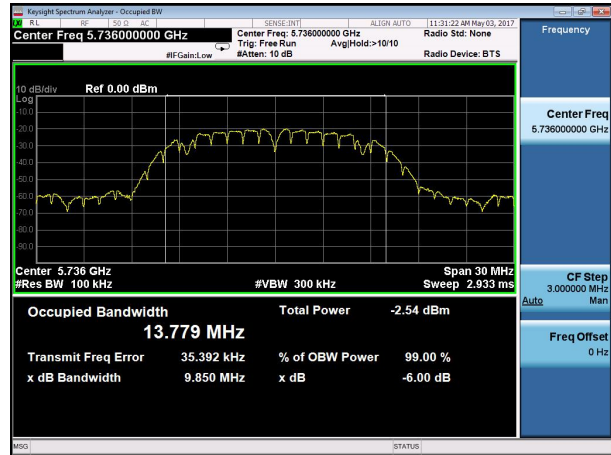

5762MHz-ANTA

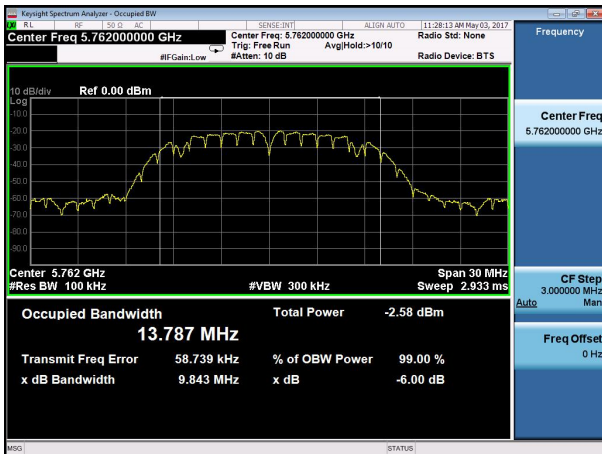

5762MHz-ANT B



5814MHz-ANTA

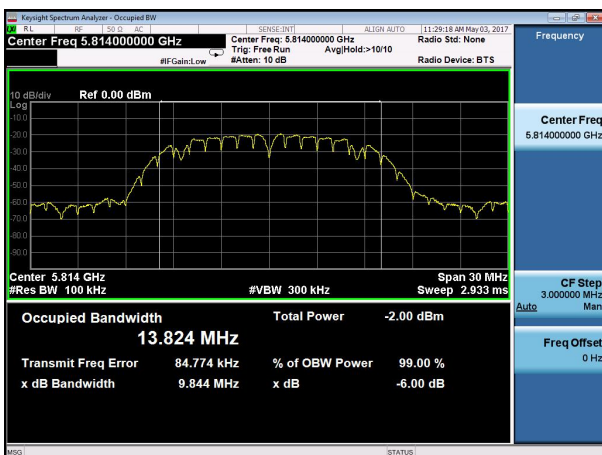

5814MHz-ANT B

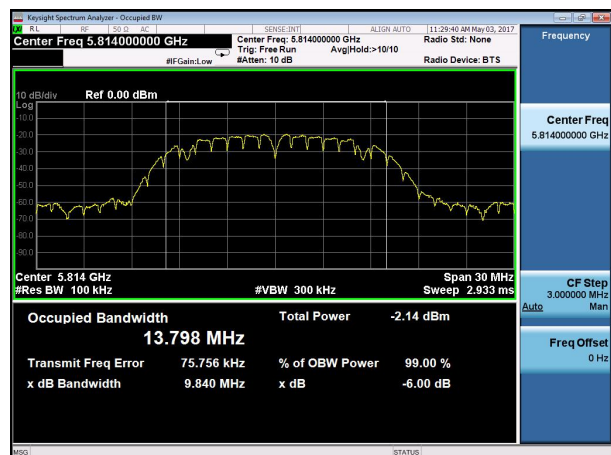

5725-5850MHz:99% Bandwidth

5736MHz-ANTA

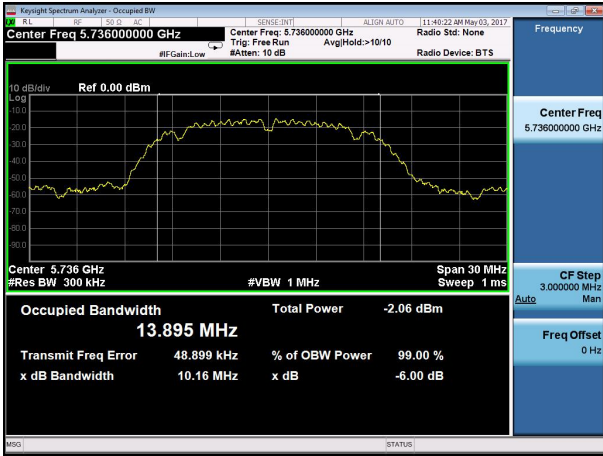

5736MHz-ANT B



5762MHz-ANTA

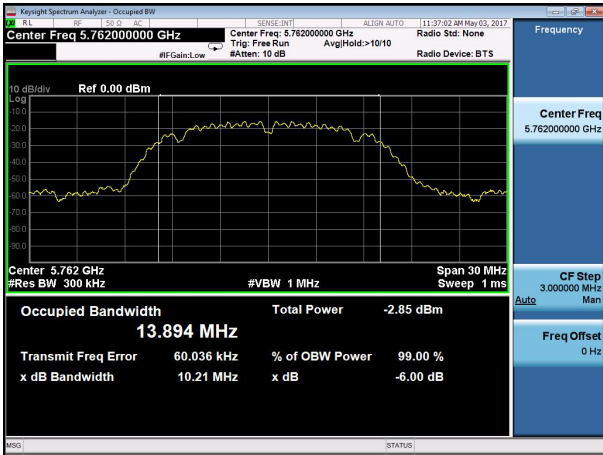

5762MHz-ANT B

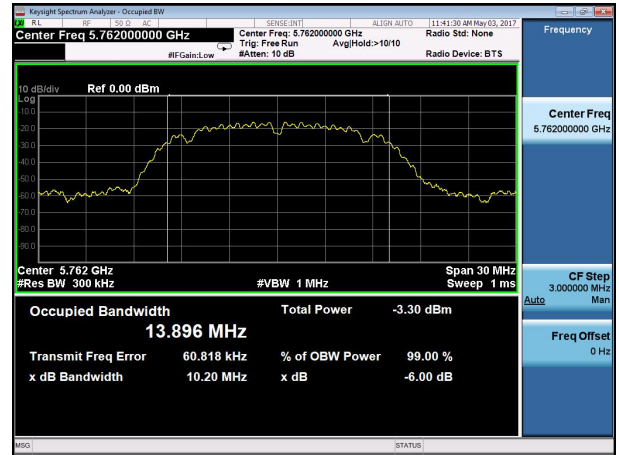

5814MHz-ANTA

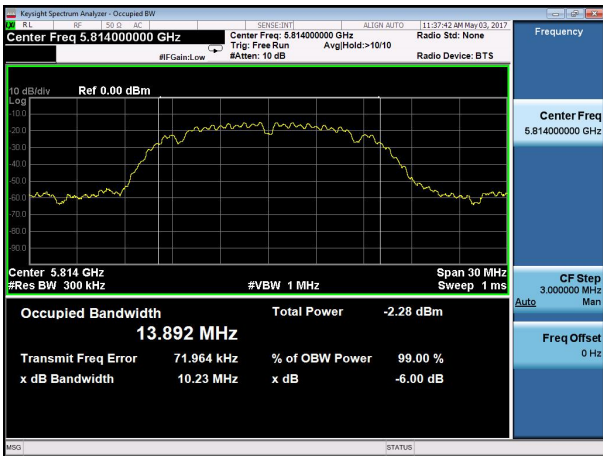

5814MHz-ANT B



7. OUTPUT POWER TEST

7.1 Limits

Band 5.725-5.825GHz:

FCC: For the band 5.725-5.85 GHz, the maximum conducted output power over the frequency band of operation shall not exceed 1 W.

7.2 Test setup

1. The maximum average conducted output power can be measured using Method PM-G (Measurement using a gated RF average power meter):
2. Measurements may be performed using a wideband gated RF power meter provided that the gate parameters are adjusted such that the power is measured only when the EUT is transmitting at its maximum power control level. Since the measurement is made only during the ON time of the transmitter, no duty cycle correction factor is required.
 - a. The Transmitter output (antenna port) was connected to the power meter.
 - b. Turn on the EUT and power meter and then record the power value.
 - c. Repeat above procedures on all channels needed to be tested.

Output Power:

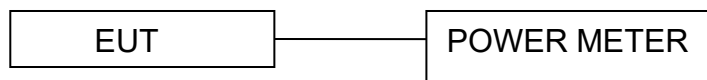

7.3 Test result

Frequency (MHz)	Average Output Power (dBm) ANT A	Average Output Power (dBm) ANT B	Total power (dBm)	FCC Limit (dBm)	Result
5736	-5.453	-5.561	-2.50	30	Pass
5762	-5.671	-5.785	-2.72	30	Pass
5814	-5.767	-5.926	-2.84	30	Pass

For 5.725-5.825GHz, the limit=1 W

NOTE: During the test the EUT is in 100% duty cycle transmitting.

8. DUTY CYCLE

8.1 Test Procedure

The zero-span mode on a spectrum analyzer or EMI receiver if the response time and spacing between bins on the sweep are sufficient to permit accurate measurements of the on and off times of the transmitted signal. Set the center frequency of the instrument to the center frequency of the transmission. Set $RBW \geq OBW$ if possible; otherwise, set RBW to the largest available value. Set $VBW \geq RBW$. Set detector = peak or average. The zero-span measurement method shall not be used unless both RBW and VBW are $> 50/T$ and the number of sweep points across duration T exceeds 100. (For example, if VBW and/or RBW are limited to 3 MHz, then the zero-span method of measuring duty cycle shall not be used if $T \leq 16.7$ microseconds.)

The RF output of EUT was connected to the spectrum analyzer by RF cable and attenuator.

The path loss was compensated to the results for each measurement.

Set to the maximum power setting and enable the EUT transmit continuously.

The EUT was operating in controlled its channel.

Use the following spectrum analyzer settings:

Span = Zero Span

RBW = 8MHz

VBW =50MHz

Number of points in Sweep >100

Detector function = peak

Trace = Clear write Measure Ttotal and Ton

Calculate Duty Cycle = $Ton / Ttotal$ and Duty Cycle Factor= $10*\log(1/Duty Cycle)$

8.2 TEST SETUP

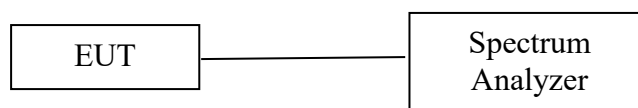

8.3 Test plot of Duty Cycle

5736MHz

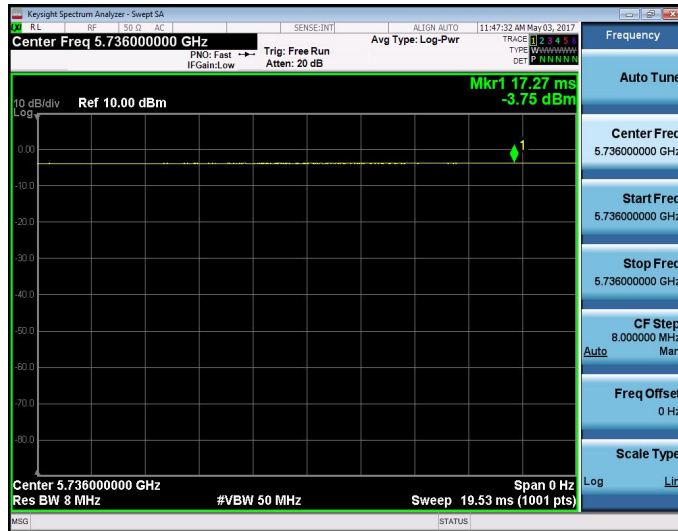

5762MHz

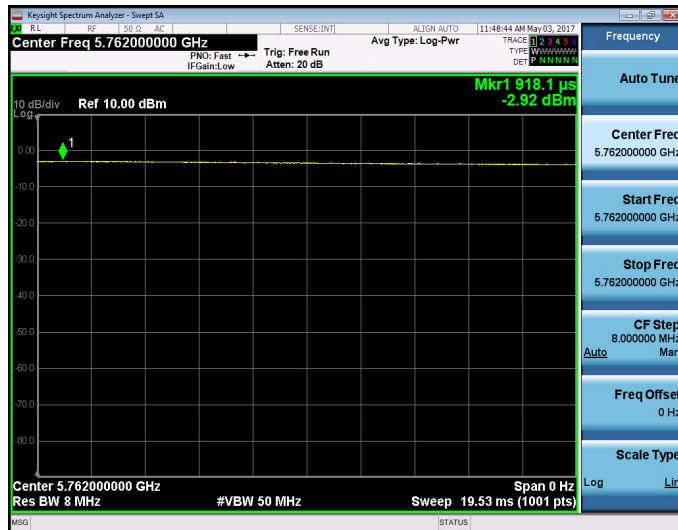

5814MHz

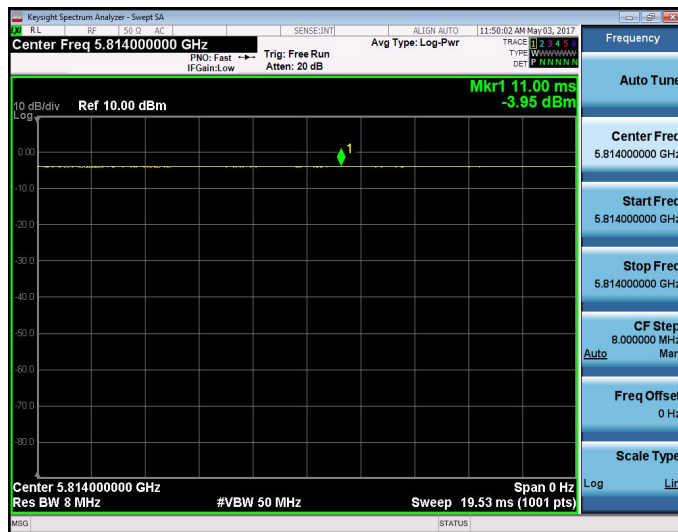

9. PEAK POWER SPECTRAL DENSITY TEST

9.1 Limits

Band 5.725-5.825GHz:

FCC: In addition, the maximum power spectral density shall not exceed 30 dBm in any 500-kHz band.

9.2 Test setup

Methods refer to FCC KDB 789033

- 1) Create an average power spectrum for the EUT operating mode being tested by following the instructions in section E)2) for measuring maximum conducted output power using a spectrum analyzer or EMI receiver: select the appropriate test method (SA-3, or alternatives to each) and apply it up to, but not including, the step labeled, "Compute power...".
- 2) Use the peak search function on the instrument to find the peak of the spectrum.
- 3) The result is the PPSD.
- 4) The above procedures make use of 1 MHz resolution bandwidth to satisfy the 1 MHz measurement bandwidth specified in the 15.407(a)(5). That rule section also permits use of resolution bandwidths less than 1 MHz "provided that the measured power is integrated to show the total power over the measurement bandwidth" (i.e., 1 MHz). If measurements are performed using a reduced resolution bandwidth and integrated over 1 MHz bandwidth

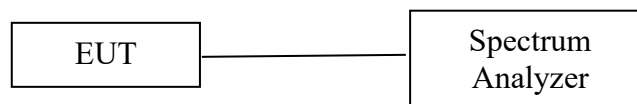

9.3 Test data

Test data as below

Frequency (MHz)	Power Density. Antenna A	Power Density. Antenna B	Total power Density	FCC Limit (dBm/500KHz)
	(dBm/500KHz)	(dBm/500KHz)	(dBm/500KHz)	
5736	-11.006	-12.058	-8.49	30
5762	-12.965	-12.604	-9.77	30
5814	-12.629	-12.291	-9.45	30

5736MHz-ANTA



5736MHz-ANTB



5762MHz-ANTA

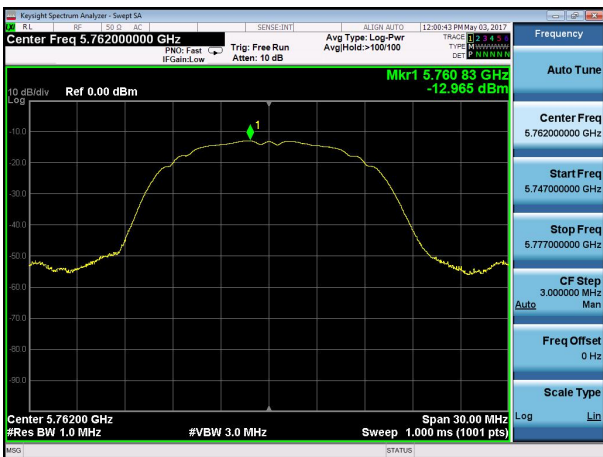

5762MHz-ANT B



5814MHz-ANTA

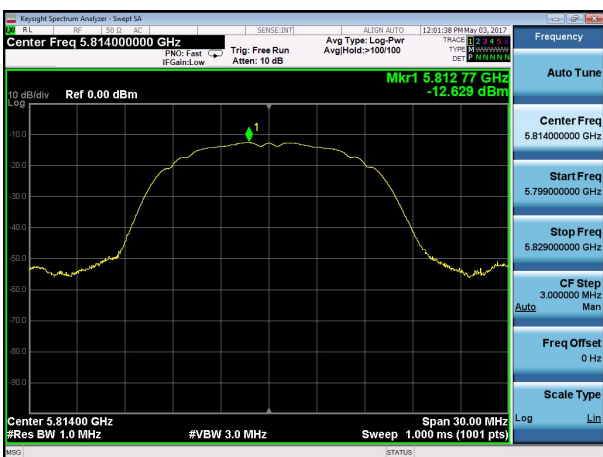

5814MHz-ANT B

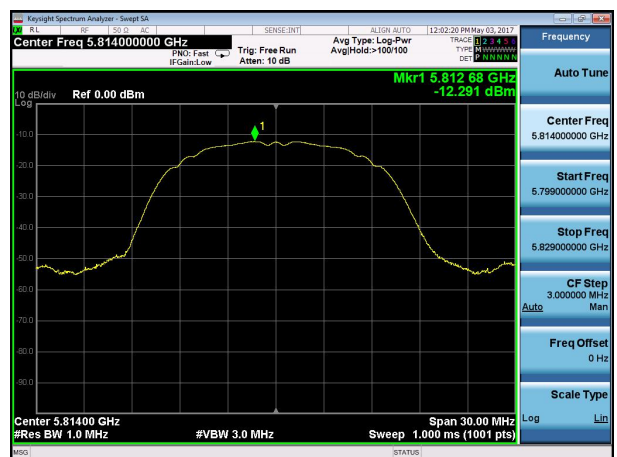

10. FREQUENCY STABILITY TEST

10.1. Limit

According to §15.407(g), manufacturers of U-NII devices are responsible for ensuring frequency stability such that an emission is maintained within the band of operation under all conditions of normal operation as specified in the user's manual.

10.2. Test Configuration

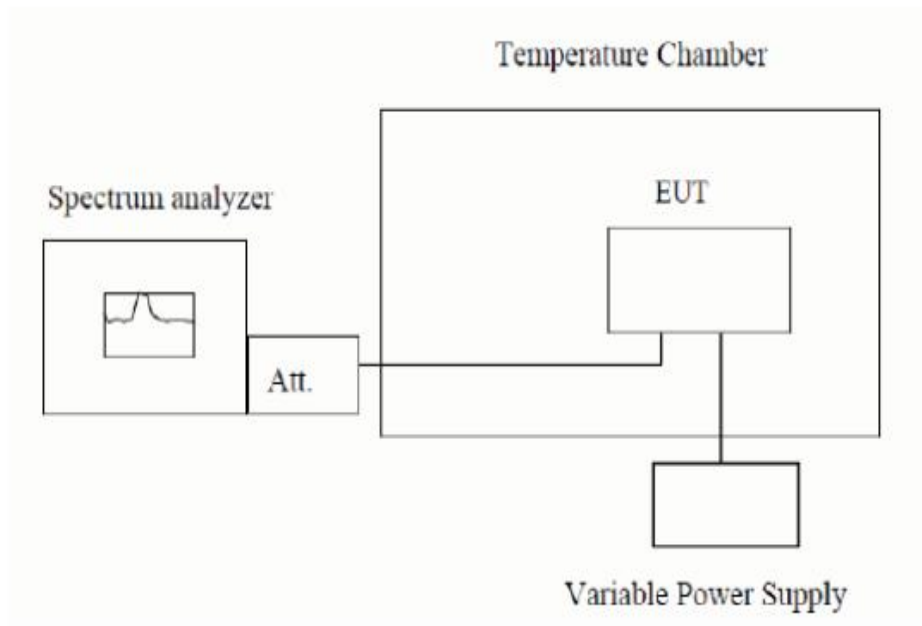

10.3. Test procedure

1. The transmitter output (antenna port) was connected to the spectrum analyzer.
2. EUT have transmitted absence of modulation signal and fixed channelize.
3. Set the spectrum analyzer span to view the entire absence of modulation emissions bandwidth.
4. Set RBW = 10 kHz, VBW = 10 kHz with peak detector and maxhold settings.
5. f_c is declaring of channel frequency. Then the frequency error formula is $(f_c - f) / f_c \times 10^6$ ppm and the limit is less than ± 20 ppm (IEEE 802.11 specification).
6. The test extreme voltage is to change the primary supply voltage from 85 to 115 percent of the nominal value
7. Extreme temperature rule is $-30^\circ\text{C} \sim 50^\circ\text{C}$.

Test data

Ant A				
Test Voltage	Test Temp.	Measured Frequency (MHz)	Spectrum Frequency (MHz)	Δ Frequency (MHz)
4.255V	-50°C	5736.000	5736.0359	-0.0359
		5762.000	5762.0379	-0.0379
		5814.000	5814.0359	-0.0359
3.145V		5736.000	5736.0264	-0.0264
		5762.000	5762.0334	-0.0334
		5814.000	5814.0292	-0.0292
3.70V	25°C	5736.000	5736.0533	-0.0533
		5762.000	5762.0265	-0.0265
		5814.000	5814.0377	-0.0377
4.255V	50°C	5736.000	5736.0363	-0.0363
		5762.000	5762.028	-0.028
		5814.000	5814.0334	-0.0334
3.145V		5736.000	5736.0352	-0.0352
		5762.000	5762.0291	-0.0291
		5814.000	5814.0377	-0.0377

Ant B				
Test Voltage	Test Temp.	Measured Frequency (MHz)	Spectrum Frequency (MHz)	Δ Frequency (MHz)
4.255V	-20°C	5736.000	5736.0365	-0.0365
		5762.000	5762.0382	-0.0382
		5814.000	5814.0376	-0.0376
3.145V		5736.000	5736.0268	-0.0268
		5762.000	5762.0342	-0.0342
		5814.000	5814.0231	-0.0231
3.70V	25°C	5736.000	5736.0538	-0.0538
		5762.000	5762.0272	-0.0272
		5814.000	5814.0342	-0.0342
4.255V	50°C	5736.000	5736.0542	-0.0542
		5762.000	5762.0398	-0.0398
		5814.000	5814.0376	-0.0376
3.145V		5736.000	5736.0345	-0.0345
		5762.000	5762.0383	-0.0383
		5814.000	5814.0424	-0.0424

11. ANTENNA REQUIREMENTS

11.1 Limits

For intentional device, according to FCC 47 CFR Section 15.203, an intentional radiator shall be designed to ensure that no antenna other than that furnished by the responsible party shall be used with the device. And according to FCC 47 CFR Section 15.247 (b), if transmitting antennas of directional gain greater than 6dBi are used, the power shall be reduced by the amount in dB that the directional gain of the antenna exceeds 6dBi.

11.2 Result

The antennas used for this product is PCB antenna and that no antenna other than that furnished by the responsible party shall be used with the device, the maximum peak gain of the transmit antenna is only 2.408dBi.

12. PHOTOGRAPHS OF TEST SET-UP

Conducted Emission



Radiated Emission Test



13. PHOTOGRAPHS OF THE EUT

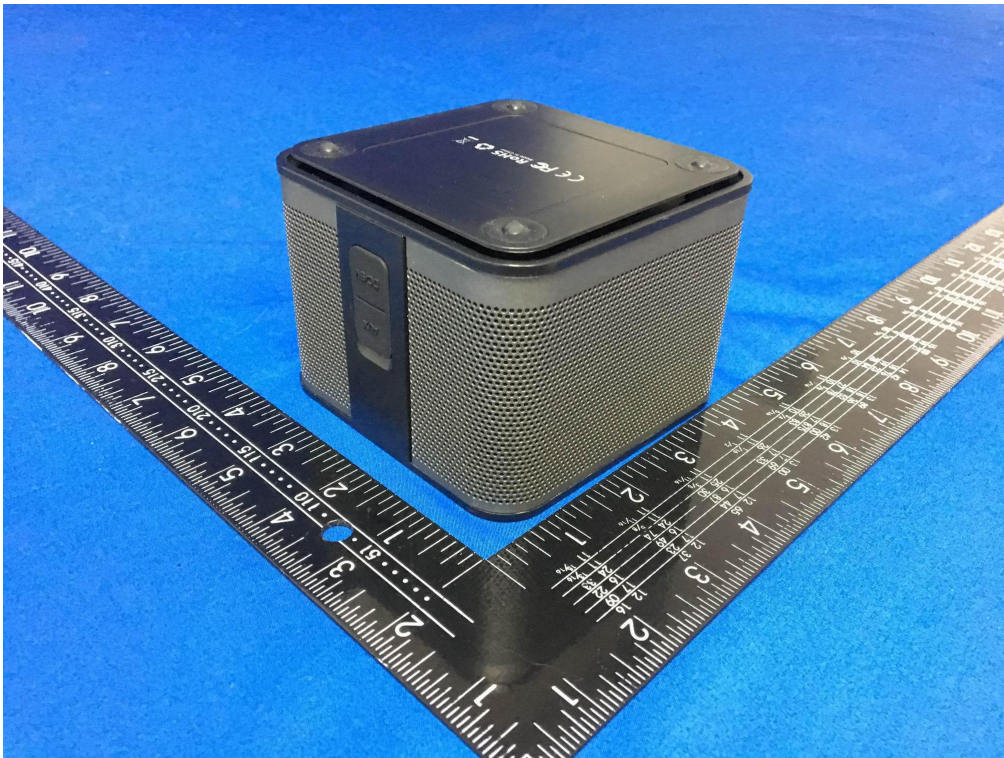
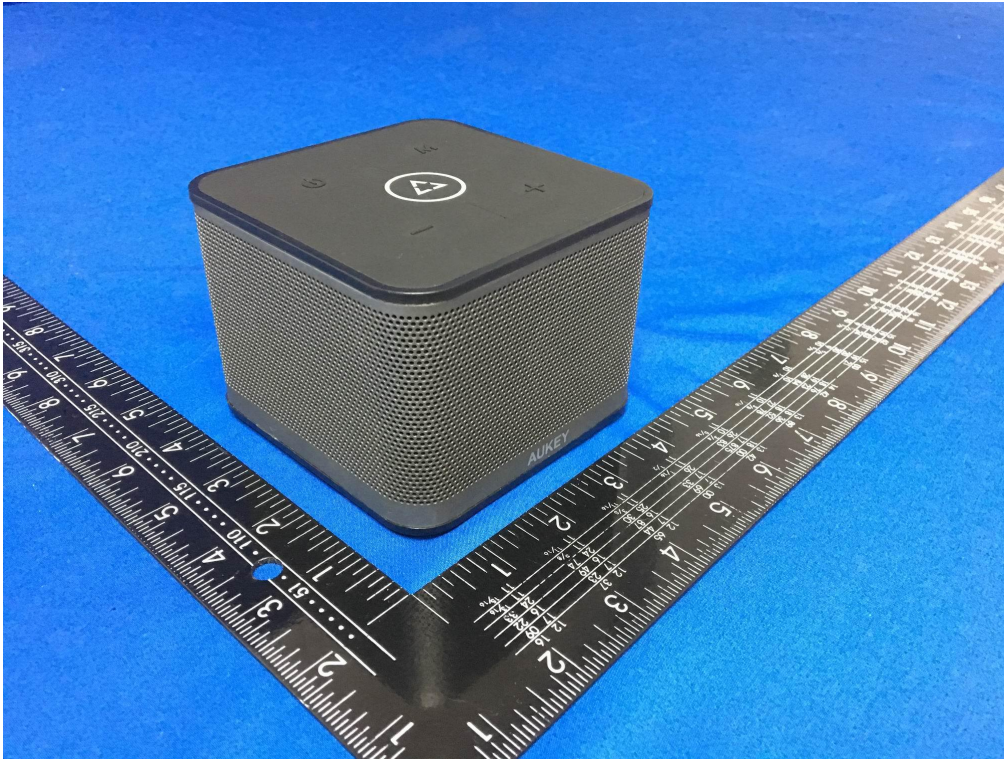

*** the end of report ***