

---

# FCC Test Report

---

Report No.: AGC04844170603FE01

**FCC ID** : 2AFHPKM-W8-1

**APPLICATION PURPOSE** : Original Equipment

**PRODUCT DESIGNATION** : USB Wireless Receiver

**BRAND NAME** : AUKEY

**MODEL NAME** : KM-W8, KM-W9, KM-W10, KM-W11, KM-W12, KM-W13,  
KM-W14, KM-W15, KM-W16, KM-W17, KM-W18,  
KM-W19, KM-W20

**CLIENT** : SHENZHEN AUKEY E BUSINESS CO., LTD.

**DATE OF ISSUE** : July 11, 2017

**STANDARD(S)** : FCC Part 15 Rules

**REPORT VERSION** : V1.0

Attestation of Global Compliance (Shenzhen) Co., Ltd



**CAUTION:**

This report shall not be reproduced except in full without the written permission of the test laboratory and shall not be quoted out of context.



**REPORT REVISE RECORD**

<b>Report Version</b>	<b>Revise Time</b>	<b>Issued Date</b>	<b>Valid Version</b>	<b>Notes</b>
V1.0	/	July 11, 2017	Valid	Original Report

## TABLE OF CONTENTS

<b>1. VERIFICATION OF CONFORMITY</b> .....	<b>4</b>
<b>2. GENERAL INFORMATION</b> .....	<b>5</b>
2.1. PRODUCT DESCRIPTION.....	5
2.2. RELATED SUBMITTAL(S) / GRANT (S) .....	5
2.3. TEST METHODOLOGY.....	5
2.4. SPECIAL ACCESSORIES .....	5
2.5. EQUIPMENT MODIFICATIONS .....	5
<b>3. MEASUREMENT UNCERTAINTY</b> .....	<b>6</b>
<b>4. DESCRIPTION OF TEST MODES</b> .....	<b>6</b>
<b>5. SYSTEM TEST CONFIGURATION</b> .....	<b>6</b>
5.1. EQUIPMENT USED IN EUT SYSTEM.....	6
5.2. SUMMARY OF TEST RESULTS .....	6
<b>6. TEST FACILITY</b> .....	<b>7</b>
<b>7. RADIATED EMISSION</b> .....	<b>8</b>
7.1. MEASUREMENT PROCEDURE .....	8
7.2. TEST SETUP .....	10
7.3. TEST RESULT .....	11
<b>8. FCC LINE CONDUCTED EMISSION TEST</b> .....	<b>13</b>
8.1. LIMITS OF LINE CONDUCTED EMISSION TEST .....	13
8.2. BLOCK DIAGRAM OF LINE CONDUCTED EMISSION TEST.....	13
8.3. PRELIMINARY PROCEDURE OF LINE CONDUCTED EMISSION TEST .....	14
8.4. FINAL PROCEDURE OF LINE CONDUCTED EMISSION TEST .....	14
8.5. TEST RESULT OF LINE CONDUCTED EMISSION TEST .....	15
<b>APPENDIX A: PHOTOGRAPHS OF TEST SETUP</b> .....	<b>17</b>
<b>APPENDIX B: PHOTOGRAPHS OF EUT</b> .....	<b>19</b>

## 1. VERIFICATION OF CONFORMITY

<b>Applicant</b>	SHENZHEN AUKEY E BUSINESS CO., LTD.
<b>Address</b>	Room 102, Bld P09, Huanan International Zone, No.1 Huanan Rd, PinghuTown Longgang District, Shenzhen, China
<b>Manufacturer</b>	Eastemtimes Technology Co., Ltd
<b>Address</b>	Fengrun Industrial Park, Youganpu Village Fenggang Town, Donggang, Guangdong, China
<b>Product Designation</b>	USB Wireless Receiver
<b>Brand Name</b>	AUKEY
<b>Test Model</b>	KM-W8
<b>Series Model</b>	KM-W9, KM-W10, KM-W11, KM-W12, KM-W13, KM-W14, KM-W15, KM-W16, KM-W17, KM-W18, KM-W19, KM-W20
<b>Model Difference</b>	All the same except appearance color.
<b>Date of test</b>	July 10, 2017 to July 11, 2017
<b>Deviation</b>	None
<b>Condition of Test Sample</b>	Normal
<b>Test Result</b>	Pass
<b>Report Template</b>	AGCRT-US-BR/RF (2013-03-01)

We hereby certify that:

The above equipment was tested by Dongguan Precise Testing Service Co., Ltd. The test data, data evaluation, test procedures, and equipment configurations shown in this report were made in accordance with the procedures given in ANSI C63.4 (2014) and the energy emitted by the sample EUT tested as described in this report is in compliance with radiated emission limits of FCC Rules Part 15 subpart B.

Tested by

*Max Zhang*

Max Zhang(Zhang Yi) July 11, 2017

Reviewed by

*Bart Xie*

Bart Xie(Xie Xiaobin) July 11, 2017

Approved by

*Solger Zhang*

Solger Zhang(Zhang Hongyi) July 11, 2017  
Authorized Officer

## 2. GENERAL INFORMATION

### 2.1. PRODUCT DESCRIPTION

A major technical description of EUT is described as following

<b>Hardware Version</b>	V02T3
<b>Software Version</b>	Check Sum:9EEF
<b>EUT Supply</b>	DC 5V by USB port

### 2.2. RELATED SUBMITTAL(S) / GRANT (S)

This submittal(s) (test report) is intended for **FCC ID: 2AFHPKM-W8-1** filing to comply with Section 15.107&109 of the FCC Part 15, Subpart B Rules.

### 2.3. TEST METHODOLOGY

Both conducted and radiated testing was performed according to the procedures in ANSI C63.4 (2014). Radiated testing was performed at an antenna to EUT distance 3 meters.

### 2.4. SPECIAL ACCESSORIES

Refer to section 5.1.

### 2.5. EQUIPMENT MODIFICATIONS

Not available for this EUT intended for grant.

### 3. MEASUREMENT UNCERTAINTY

Conducted measurement:  $\pm 3.18$ dB

Radiated measurement:  $\pm 3.91$ dB

### 4. DESCRIPTION OF TEST MODES

NO.	TEST MODE DESCRIPTION
1	Connected to PC for Receiving

### 5. SYSTEM TEST CONFIGURATION

#### 5.1. EQUIPMENT USED IN EUT SYSTEM

Item	Equipment	Model No.	ID or Specification	Remark
1	USB Wireless Receiver	KM-W8	2AFHPKM-W8-1	EUT
2	PC	SONY	E1412AYCW	Support
3	PC adapter	SONY	A13-040A3A	Support

#### 5.2. SUMMARY OF TEST RESULTS

FCC RULES	DESCRIPTION OF TEST	RESULT
§15.109	Radiated Emission	Compliant
§15.107	Conducted Emission	Compliant

## 6. TEST FACILITY

<b>Site</b>	Dongguan Precise Testing Service Co., Ltd.
<b>Location</b>	Building D, Baoding Technology Park, Guangming Road2, Dongcheng District, Dongguan, Guangdong, China
<b>FCC Registration No.</b>	371540
<b>Description</b>	The test site is constructed and calibrated to meet the FCC requirements in documents ANSI C63.4:2014.

### ALL TEST EQUIPMENT LIST

Radiated Emission Test Site					
Name of Equipment	Manufacturer	Model Number	Serial Number	Last Calibration	Due Calibration
EMI Test Receiver	Rohde & Schwarz	ESCI	101417	July 2, 2017	July 1, 2018
Trilog Broadband Antenna (25M-1GHz)	SCHWARZBECK	VULB9160	9160-3355	July 2, 2017	July 1, 2018
Signal Amplifier	SCHWARZBECK	BBV 9475	9745-0013	July 2, 2017	July 1, 2018
RF Cable	SCHWARZBECK	AK9515E	96221	July 2, 2017	July 1, 2018
3m Anechoic Chamber	CHENGYU	966	PTS-001	July 2, 2017	July 1, 2018
MULTI-DEVICE Positioning Controller	Max-Full	MF-7802	MF780208339	N/A	N/A
Active loop antenna (9K-30MHz)	Schwarzbeck	FMZB1519	1519-038	June 2, 2017	June 1, 2018
Spectrum analyzer	Agilent	E4407B	MY46185649	June 2, 2017	June 1, 2018
Horn Antenna (1G-18GHz)	SCHWARZBECK	BBHA9120D	9120D-1246	June 2, 2017	June 1, 2018
Horn Ant (18G-40GHz)	Schwarzbeck	BBHA 9170	9170-181	June 2, 2017	June 1, 2018

Conducted Emission Test Site					
Name of Equipment	Manufacturer	Model Number	Serial Number	Last Calibration	Due Calibration
EMI Test Receiver	Rohde & Schwarz	ESCI	101417	June 2, 2017	June 1, 2018
Artificial Mains Network	Narda	L2-16B	000WX31025	June 2, 2017	June 1, 2018
Artificial Mains Network (AUX)	Narda	L2-16B	000WX31026	June 2, 2017	June 1, 2018
RF Cable	SCHWARZBECK	AK9515E	96222	June 2, 2017	June 1, 2018
Shielded Room	CHENGYU	843	PTS-002	June 2, 2017	June 1, 2018

## 7. RADIATED EMISSION

### 7.1. MEASUREMENT PROCEDURE

1. Configure the EUT according to ANSI C63.4. The EUT was placed on the top of the turntable 0.8 meter above ground. The phase center of the receiving antenna mounted on the top of a height-variable antenna tower was placed 3 meters far away from the turntable.
2. Power on the EUT and all the supporting units. The turntable was rotated by 360 degrees to determine the position of the highest radiation.
3. The height of the broadband receiving antenna was varied between one meter and four meters above ground to find the maximum emissions field strength of both horizontal and vertical polarization.
4. For each suspected emissions, the antenna tower was scan (from 1 M to 4 M) and then the turntable was rotated (from 0 degree to 360 degrees) to find the maximum reading.
5. Set the test-receiver system to Peak or CISPR quasi-peak Detect Function with specified bandwidth under Maximum Hold Mode.
6. For emissions below 1GHz, use 120KHz RBW and  $VBW \geq 3RBW$  for QP reading.
7. For emissions above 1GHz, use 1MHz RBW and 3MHz VBW for peak reading. Then 1MHz RBW and 10Hz VBW for average reading in spectrum analyzer.
8. When the radiated emissions limits are expressed in terms of the average value of the emissions, and pulsed operation is employed, the measurement field strength shall be determined by averaging over one complete pulse train, including blanking intervals, as long as the pulse train does not exceed 0.1 seconds. As an alternative (provided the transmitter operates for longer than 0.1 seconds) or in cases where the pulse train exceeds 0.1 seconds, the measured field strength shall be determined from the average absolute voltage during a 0.1 second interval during which the field strength is at its maximum values.
9. If the emissions level of the EUT in peak mode was 3 dB lower than the average limit specified, then testing will be stopped and peak values of EUT will be reported, otherwise, the emissions which do not have 3 dB margin will be repeated one by one using the quasi-peak method for below 1GHz.
10. For testing above 1GHz, the emissions level of the EUT in peak mode was lower than average limit (that means the emissions level in peak mode also complies with the limit in average mode), then testing will be stopped and peak values of EUT will be reported, otherwise, the emissions will be measured in average mode again and reported.
11. In case the emission is lower than 30MHz, loop antenna has to be used for measurement and the recorded data should be QP measured by receiver. High - Low scan is not required in this case.
12. Only the worst case is reported.



The following table is the setting of spectrum analyzer and receiver.

<b>Spectrum Parameter</b>	<b>Setting</b>
Start ~Stop Frequency	9KHz~150KHz/RBW 200Hz for QP
Start ~Stop Frequency	150KHz~30MHz/RBW 9KHz for QP
Start ~Stop Frequency	30MHz~1000MHz/RBW 120KHz for QP
Start ~Stop Frequency	1GHz~26.5GHz 1MHz/3MHz for Peak, 1MHz/10Hz for Average

<b>Receiver Parameter</b>	<b>Setting</b>
Start ~Stop Frequency	9KHz~150KHz/RBW 200Hz for QP
Start ~Stop Frequency	150KHz~30MHz/RBW 9KHz for QP
Start ~Stop Frequency	30MHz~1000MHz/RBW 120KHz for QP

## 7.2. TEST SETUP

Radiated Emission Test-Setup Frequency Below 30MHz

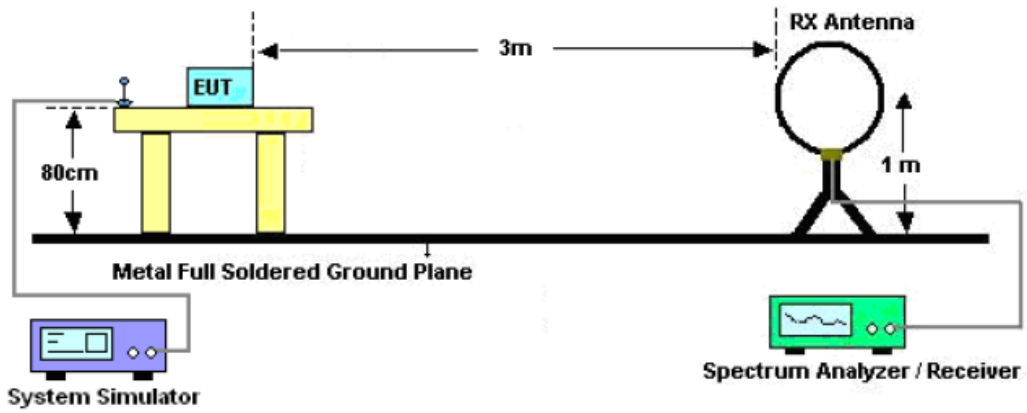

RADIATED EMISSION TEST SETUP 30MHz-1000MHz

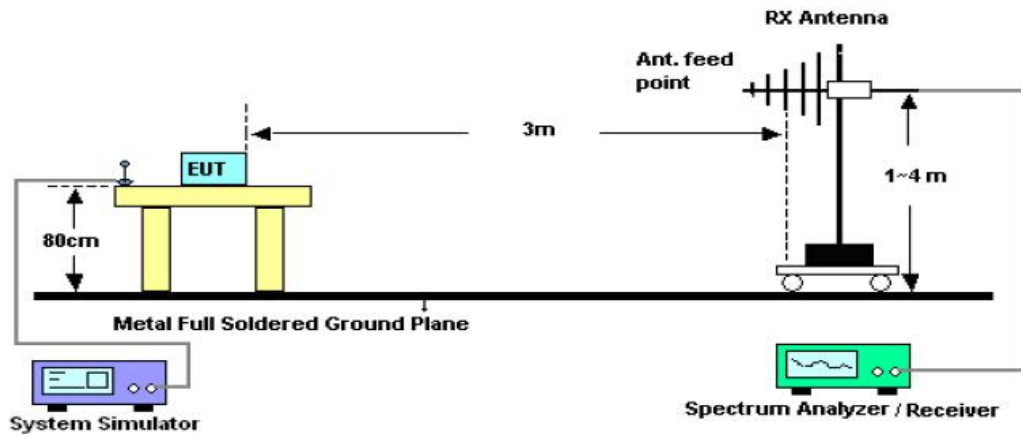

RADIATED EMISSION TEST SETUP ABOVE 1000MHz

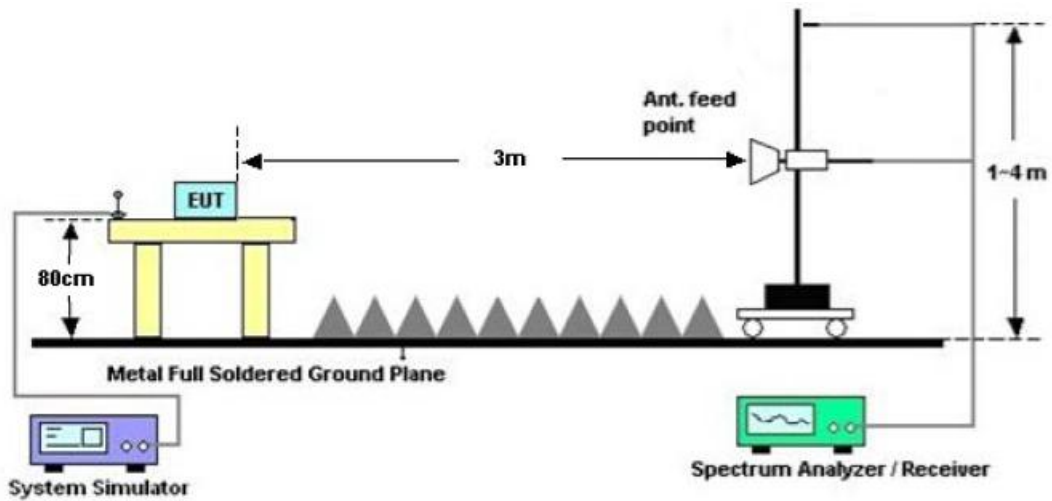

### 7.3. TEST RESULT

#### RADIATED EMISSION BELOW 30MHz

No emission found between lowest internal used/generated frequencies to 30MHz.

#### RADIATED EMISSION BELOW 1GHZ-Horizontal

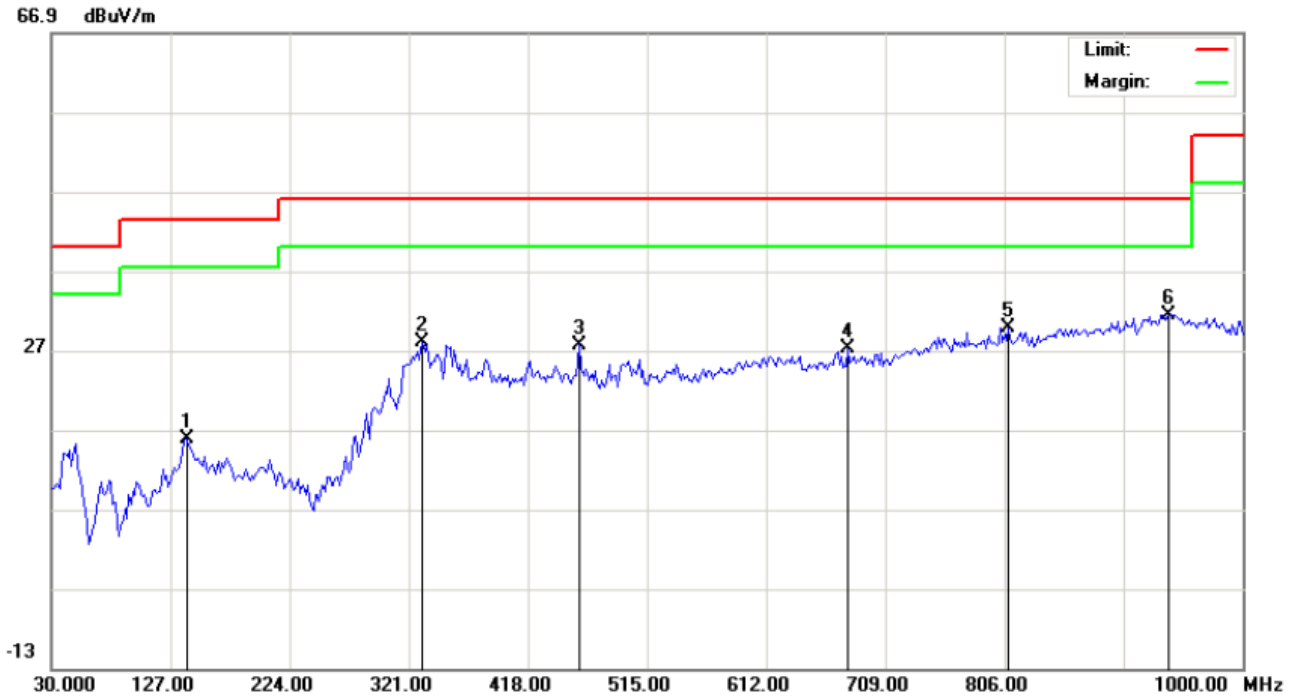

No.	Mk	Freq.	Reading	Factor	Measurement	Limit	Over	Detector	Antenna Height	Table Degree	Comment
		MHz	dBuV	dB/m	dBuV/m	dBuV/m	dB		cm	degree	
1		139.9333	0.59	15.17	15.76	43.50	-27.74	peak			
2		332.3167	10.38	17.56	27.94	46.00	-18.06	peak			
3		460.0332	7.00	20.70	27.70	46.00	-18.30	peak			
4		678.2833	2.53	24.61	27.14	46.00	-18.86	peak			
5		809.2332	2.57	27.32	29.89	46.00	-16.11	peak			
6	*	940.1833	1.73	29.73	31.46	46.00	-14.54	peak			

RADIATED EMISSION BELOW 1GHZ-Vertical

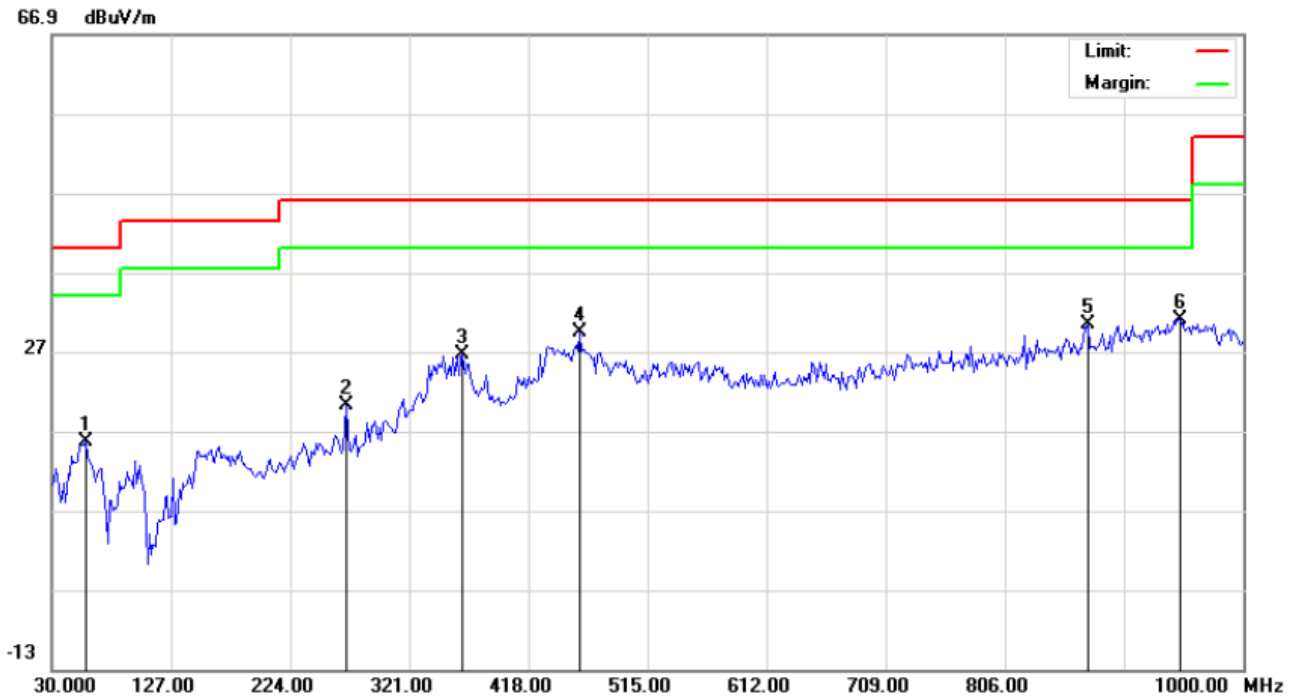

No.	Mk	Freq.	Reading	Factor	Measurement	Limit	Over	Detector	Antenna Height	Table Degree	Comment
		MHz	dBuV	dB/m	dBuV/m	dBuV/m	dB		cm	degree	
1		57.4832	7.36	8.17	15.53	40.00	-24.47	peak			
2		269.2667	5.69	14.48	20.17	46.00	-25.83	peak			
3		364.6499	7.83	18.84	26.67	46.00	-19.33	peak			
4		460.0332	8.67	20.70	29.37	46.00	-16.63	peak			
5		873.8999	2.39	27.93	30.32	46.00	-15.68	peak			
6	*	948.2667	1.09	29.95	31.04	46.00	-14.96	peak			

**RESULT: PASS**

- Note:** 1. Factor=Antenna Factor + Cable loss - Amplifier gain, Margin=Measurement-Limit.  
2. The "Factor" value can be calculated automatically by software of measurement system.  
3. Emissions range from 1GHz to 12.5GHz have 20dB margin. No recording in the test report.  
4. Only the data of the worst case would be record in this test report.

## 8. FCC LINE CONDUCTED EMISSION TEST

### 8.1. LIMITS OF LINE CONDUCTED EMISSION TEST

Frequency	Maximum RF Line Voltage	
	Q.P.( dBuV)	Average( dBuV)
150kHz~500kHz	66-56	56-46
500kHz~5MHz	56	46
5MHz~30MHz	60	50

Note:

1. The lower limit shall apply at the transition frequency.
2. The limit decreases linearly with the logarithm of the frequency in the range 0.15 MHz to 0.50 MHz.

### 8.2. BLOCK DIAGRAM OF LINE CONDUCTED EMISSION TEST

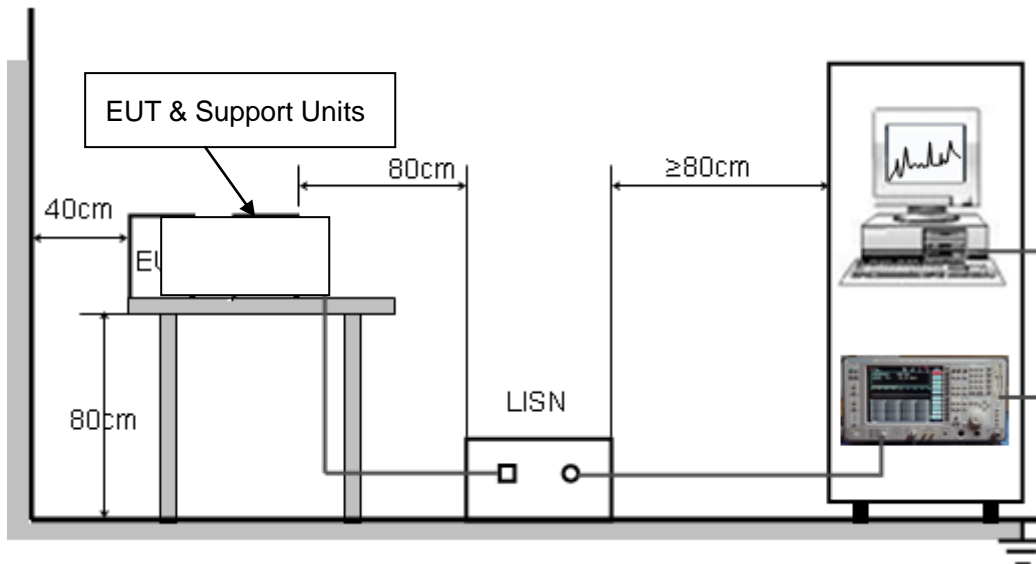

### **8.3. PRELIMINARY PROCEDURE OF LINE CONDUCTED EMISSION TEST**

1. The equipment was set up as per the test configuration to simulate typical actual usage per the user's manual. When the EUT is a tabletop system, a wooden table with a height of 0.8 meters is used and is placed on the ground plane as per ANSI C63.4 (see Test Facility for the dimensions of the ground plane used). When the EUT is a floor-standing equipment, it is placed on the ground plane which has a 3-12 mm non-conductive covering to insulate the EUT from the ground plane.
2. Support equipment, if needed, was placed as per ANSI C63.4.
3. All I/O cables were positioned to simulate typical actual usage as per ANSI C63.4.
4. All support equipments received AC120V/60Hz power from a LISN, if any.
5. The EUT received DC charging voltage by PC which received 120V/60Hz power by a LISN..
6. The test program was started. Emissions were measured on each current carrying line of the EUT using a spectrum Analyzer / Receiver connected to the LISN powering the EUT. The LISN has two monitoring points: Line 1 (Hot Side) and Line 2 (Neutral Side). Two scans were taken: one with Line 1 connected to Analyzer / Receiver and Line 2 connected to a 50 ohm load; the second scan had Line 1 connected to a 50 ohm load and Line 2 connected to the Analyzer / Receiver.
7. Analyzer / Receiver scanned from 150 kHz to 30MHz for emissions in each of the test modes.
8. During the above scans, the emissions were maximized by cable manipulation.
9. The test mode(s) were scanned during the preliminary test.

Then, the EUT configuration and cable configuration of the above highest emission level were recorded for reference of final testing.

### **8.4. FINAL PROCEDURE OF LINE CONDUCTED EMISSION TEST**

1. EUT and support equipment was set up on the test bench as per step 2 of the preliminary test.
2. A scan was taken on both power lines, Line 1 and Line 2, recording at least the six highest emissions. Emission frequency and amplitude were recorded into a computer in which correction factors were used to calculate the emission level and compare reading to the applicable limit. If EUT emission level was less -2dB to the A.V. limit in Peak mode, then the emission signal was re-checked using Q.P and Average detector.
3. The test data of the worst case condition(s) was reported on the Summary Data page.

### 8.5. TEST RESULT OF LINE CONDUCTED EMISSION TEST

Line Conducted Emission Test Line 1-L

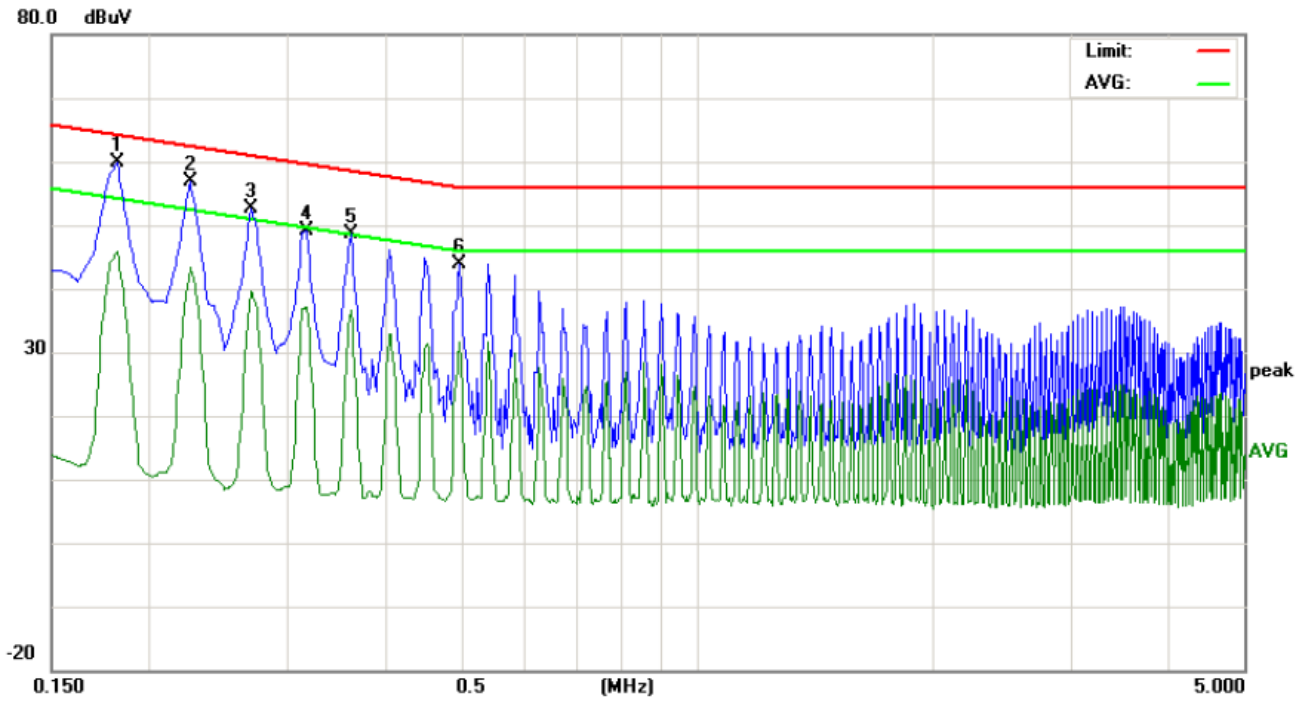

No.	Freq. (MHz)	Reading_Level (dBuV)			Correct Factor (dB)	Measurement (dBuV)			Limit (dBuV)		Margin (dB)		P/F	Comment
		Peak	QP	AVG		Peak	QP	AVG	QP	AVG	QP	AVG		
1	0.1819	49.59		35.64	10.20	59.79		45.84	64.39	54.39	-4.60	-8.55	P	
2	0.2260	46.72		33.25	10.24	56.96		43.49	62.59	52.59	-5.63	-9.10	P	
3	0.2700	42.39		29.27	10.28	52.67		39.55	61.12	51.12	-8.45	-11.57	P	
4	0.3180	38.91		26.87	10.30	49.21		37.17	59.76	49.76	-10.55	-12.59	P	
5	0.3620	38.26		26.43	10.31	48.57		36.74	58.68	48.68	-10.11	-11.94	P	
6	0.4980	33.48		21.19	10.40	43.88		31.59	56.03	46.03	-12.15	-14.44	P	

**RESULT: PASS**

Line Conducted Emission Test Line 2-N

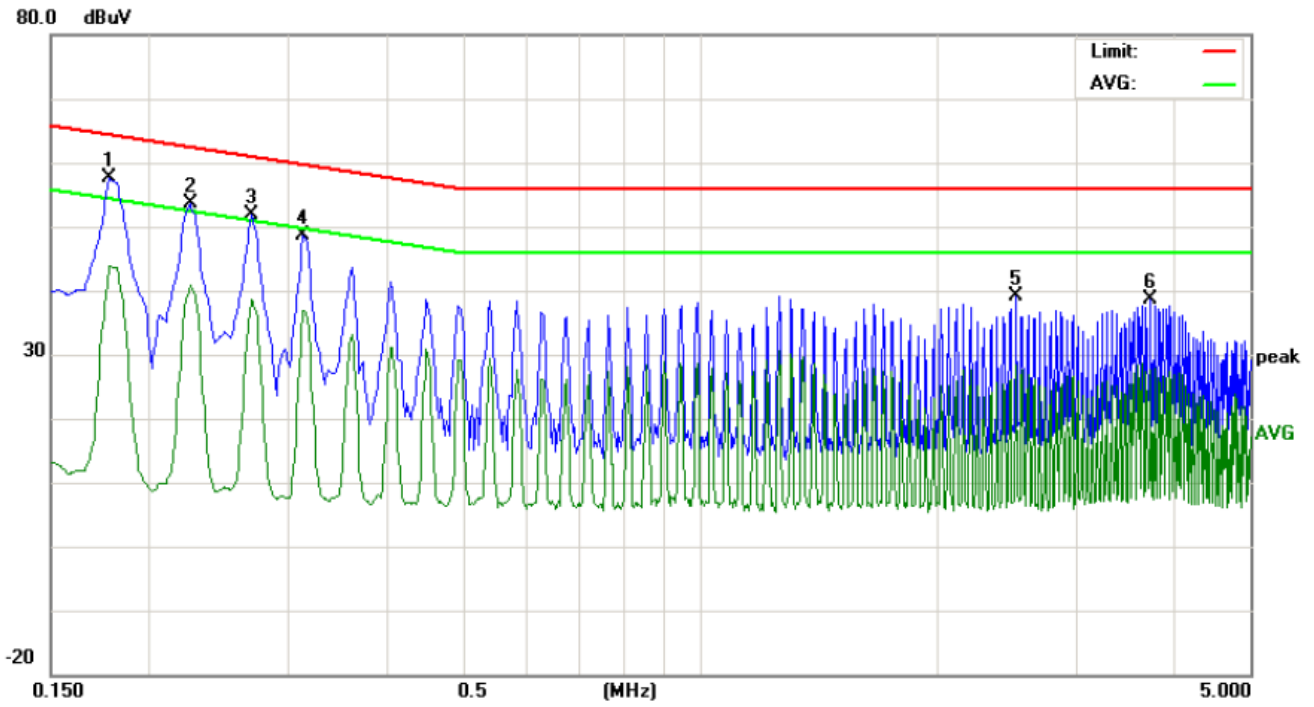

No.	Freq. (MHz)	Reading_Level (dBuV)			Correct Factor (dB)	Measurement (dBuV)			Limit (dBuV)		Margin (dB)		P/F	Comment
		Peak	QP	AVG		Peak	QP	AVG	QP	AVG	QP	AVG		
1	0.1780	47.33		33.61	10.19	57.52		43.80	64.57	54.57	-7.05	-10.77	P	
2	0.2260	43.28		30.68	10.24	53.52		40.92	62.59	52.59	-9.07	-11.67	P	
3	0.2700	41.57		28.25	10.28	51.85		38.53	61.12	51.12	-9.27	-12.59	P	
4	0.3140	38.28		26.63	10.30	48.58		36.93	59.86	49.86	-11.28	-12.93	P	
5	2.5259	28.57		18.04	10.44	39.01		28.48	56.00	46.00	-16.99	-17.52	P	
6	3.7419	28.17		17.26	10.47	38.64		27.73	56.00	46.00	-17.36	-18.27	P	

**RESULT: PASS**



## APPENDIX A: PHOTOGRAPHS OF TEST SETUP

### RADIATED EMISSION TEST SETUP

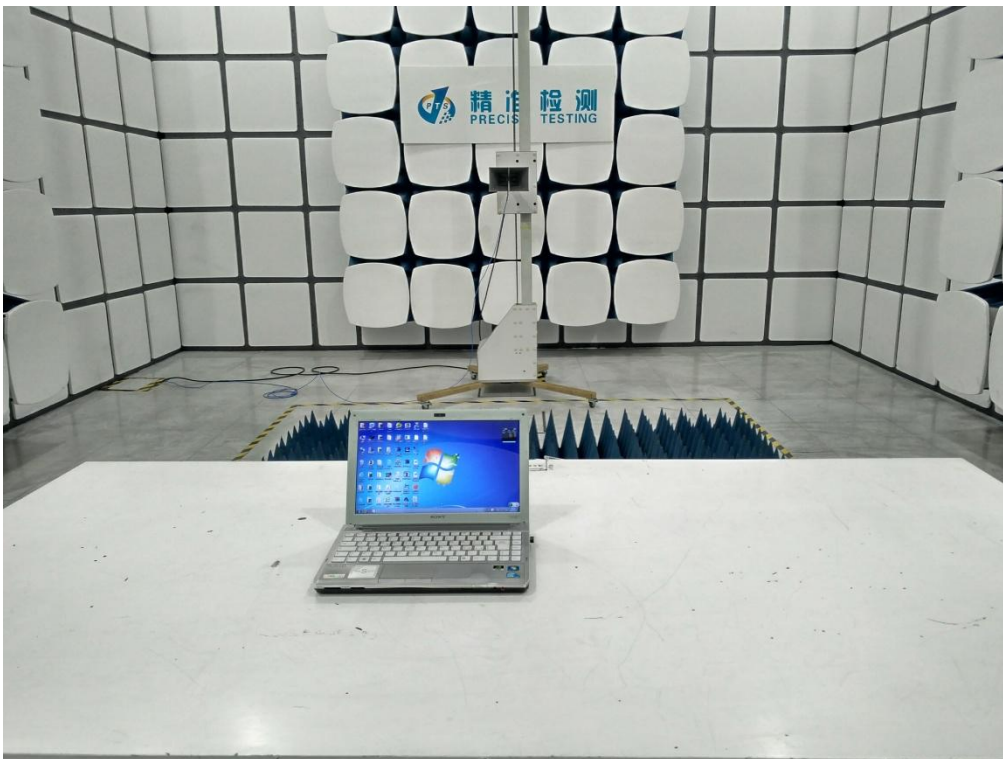
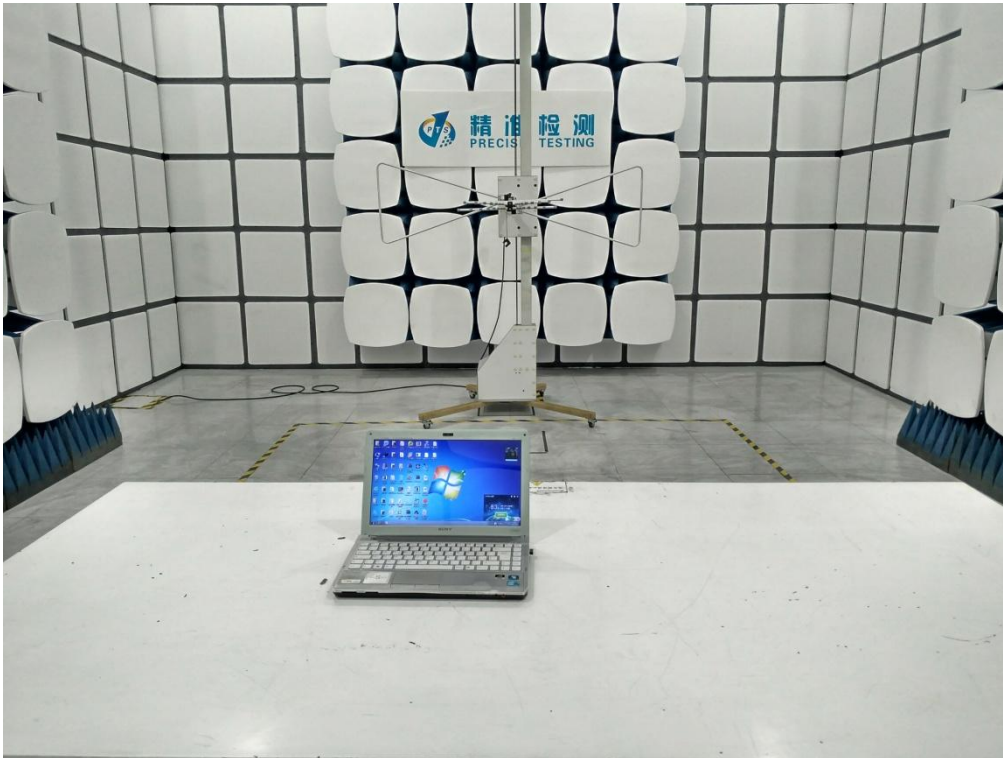

CONDUCTED EMISSION TEST SETUP



### APPENDIX B: PHOTOGRAPHS OF EUT

TOP VIEW OF EUT

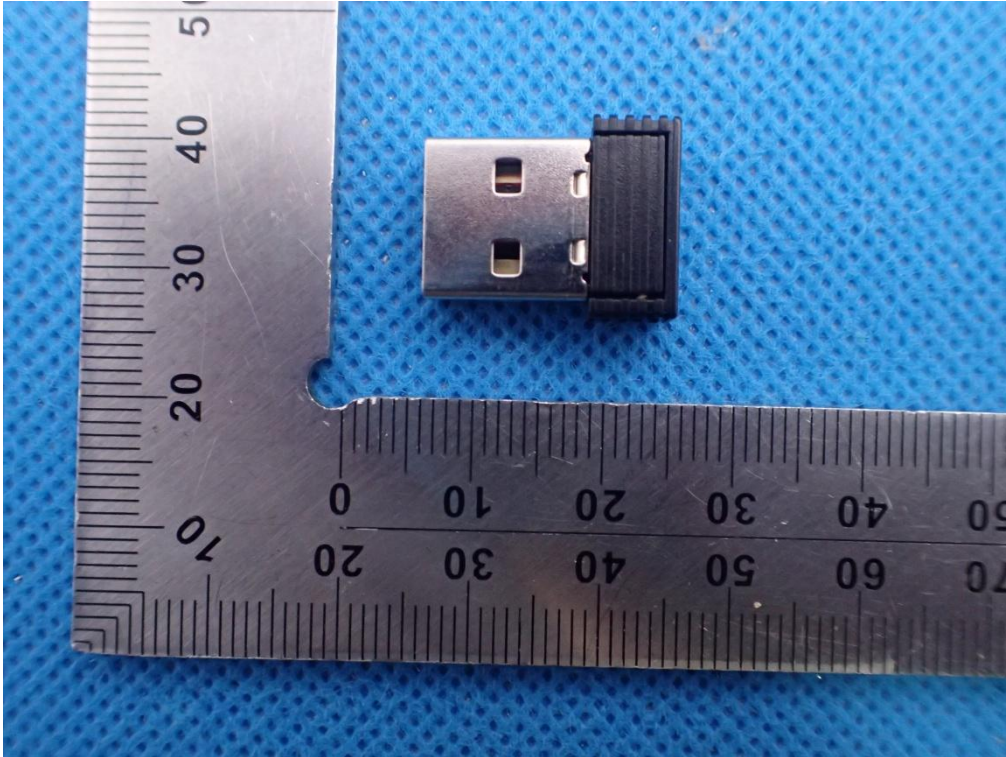

BOTTOM VIEW OF EUT

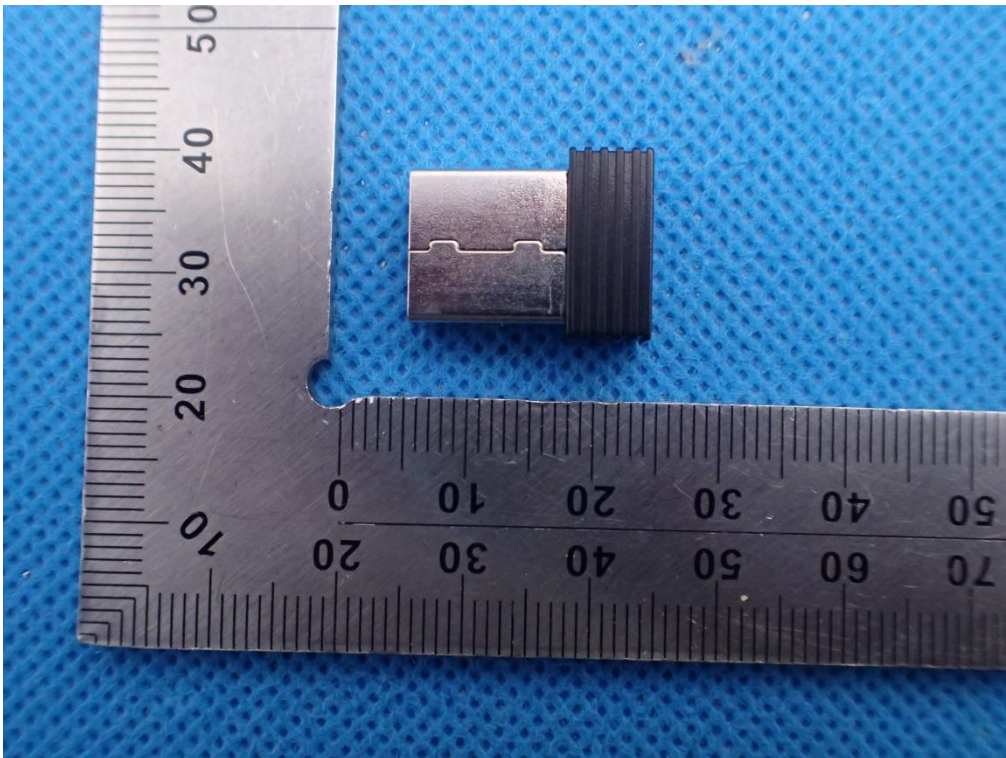



FRONT VIEW OF EUT

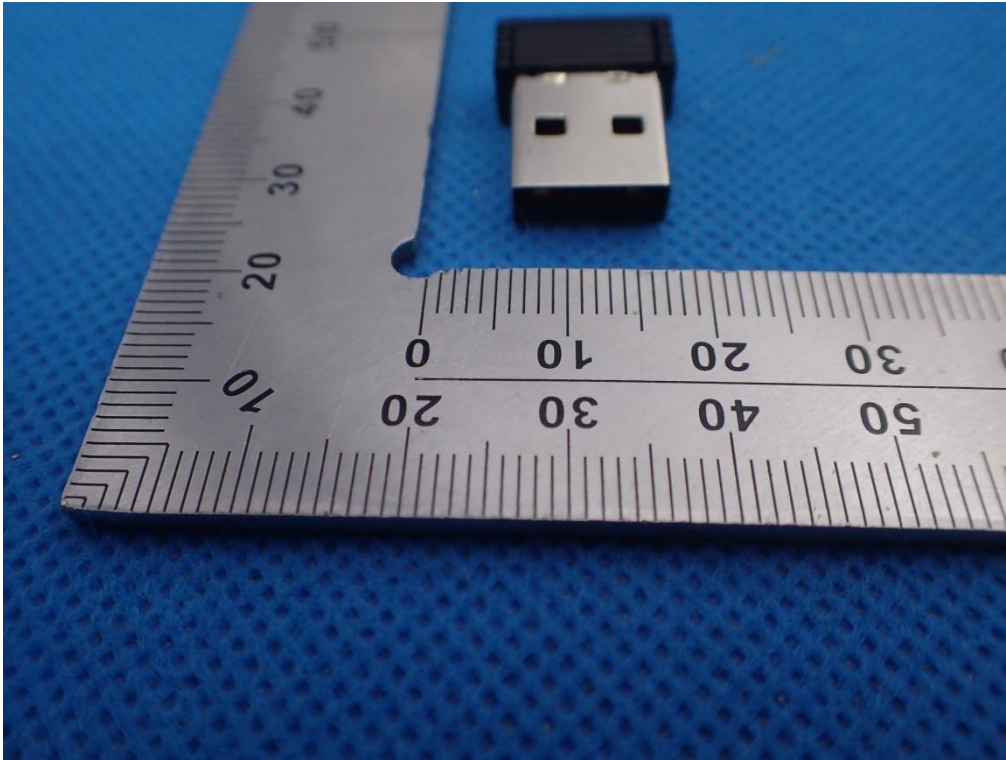

BACK VIEW OF EUT

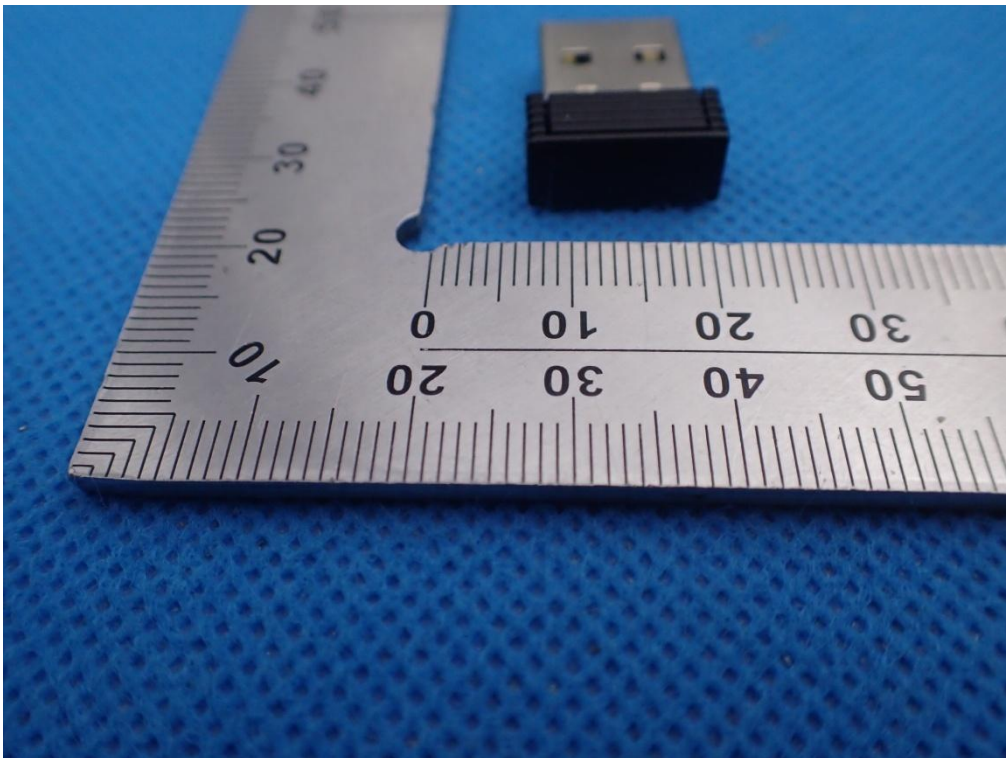

LEFT VIEW OF EUT

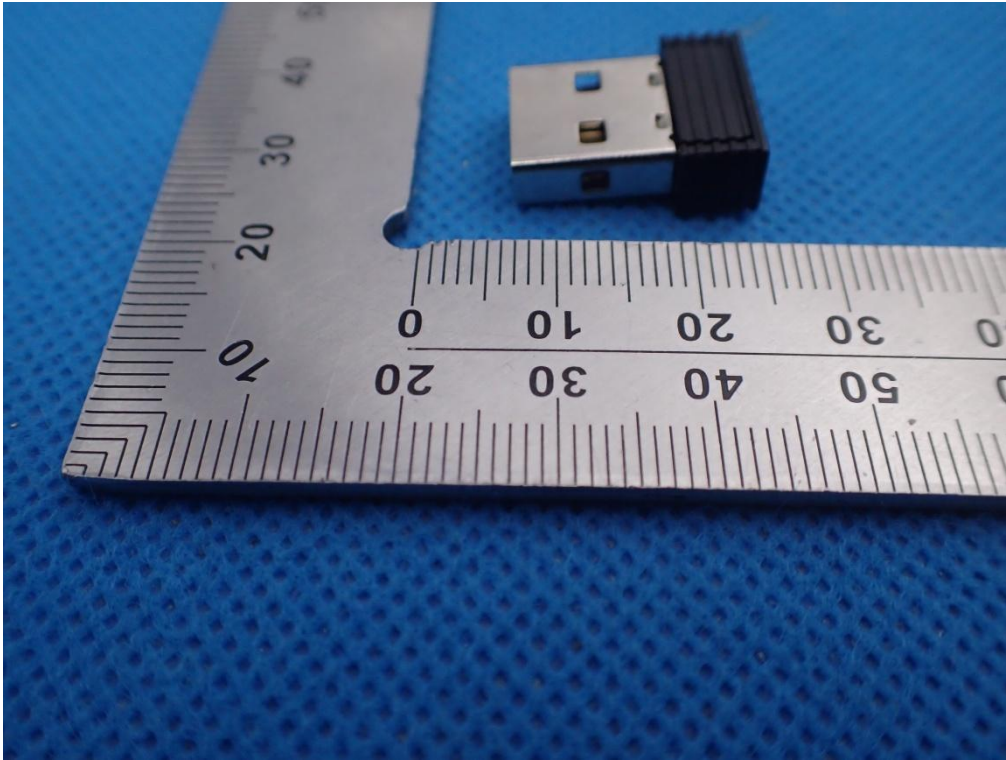

RIGHT VIEW OF EUT

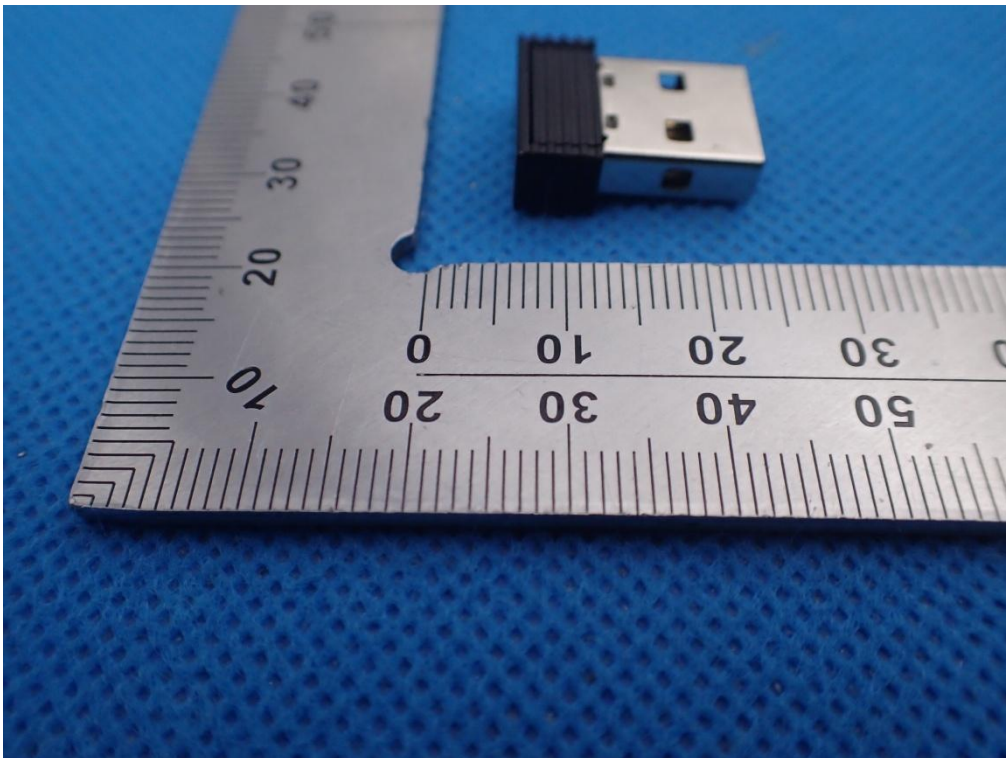



OPEN VIEW OF EUT

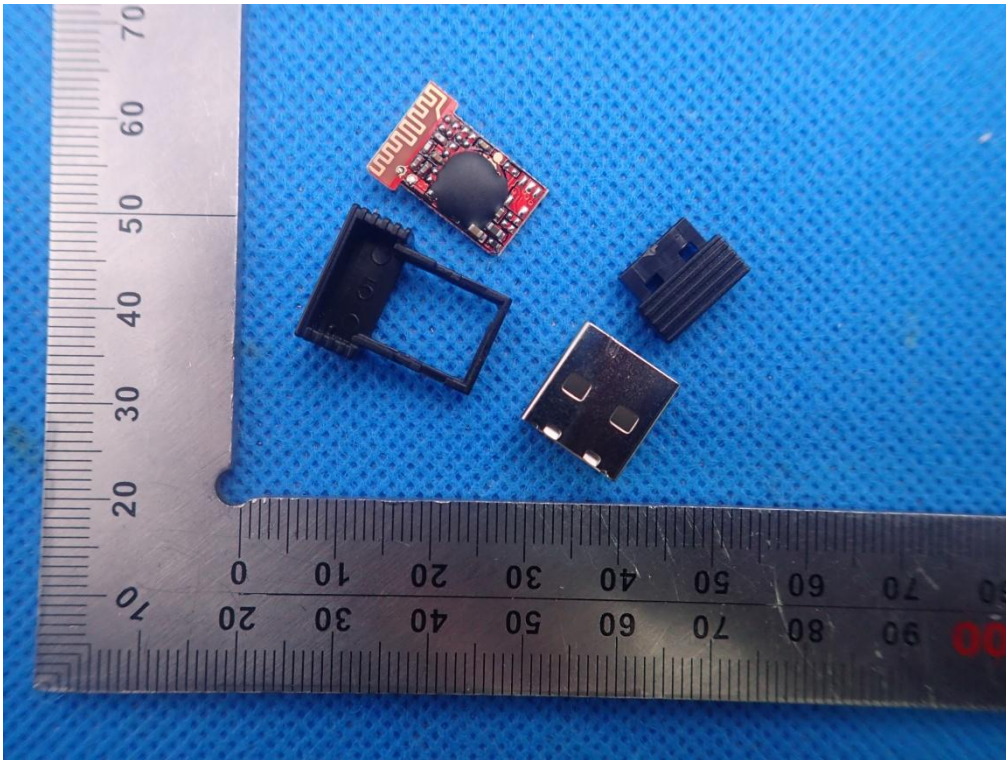

INTERNAL VIEW OF EUT-1

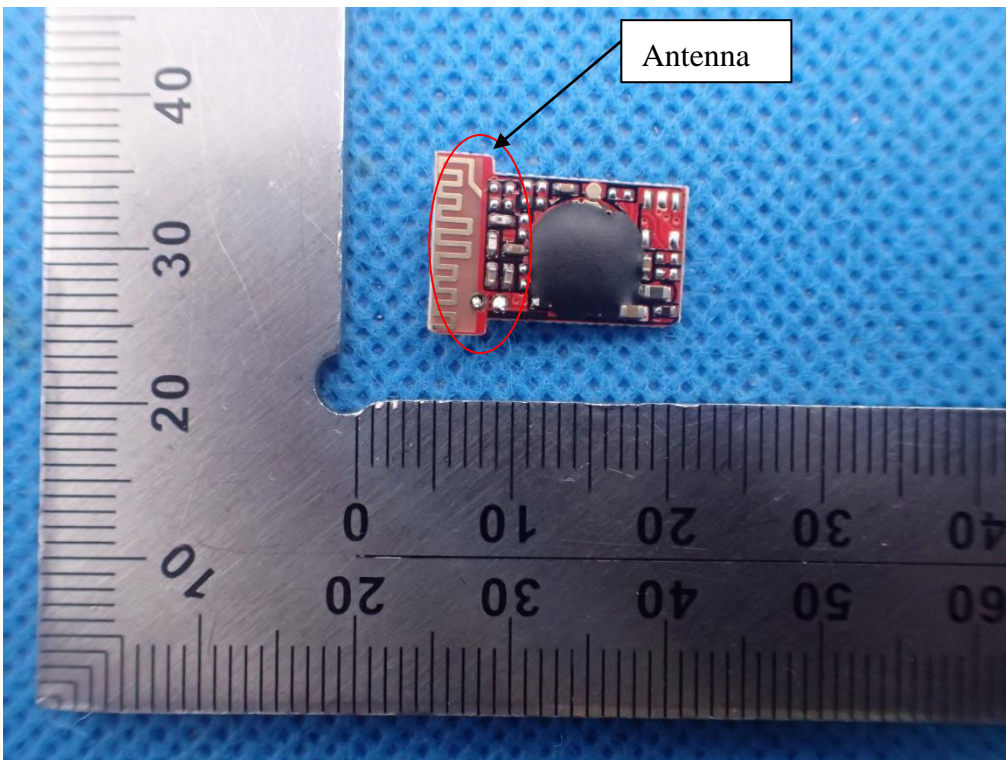

INTERNAL VIEW OF EUT-2

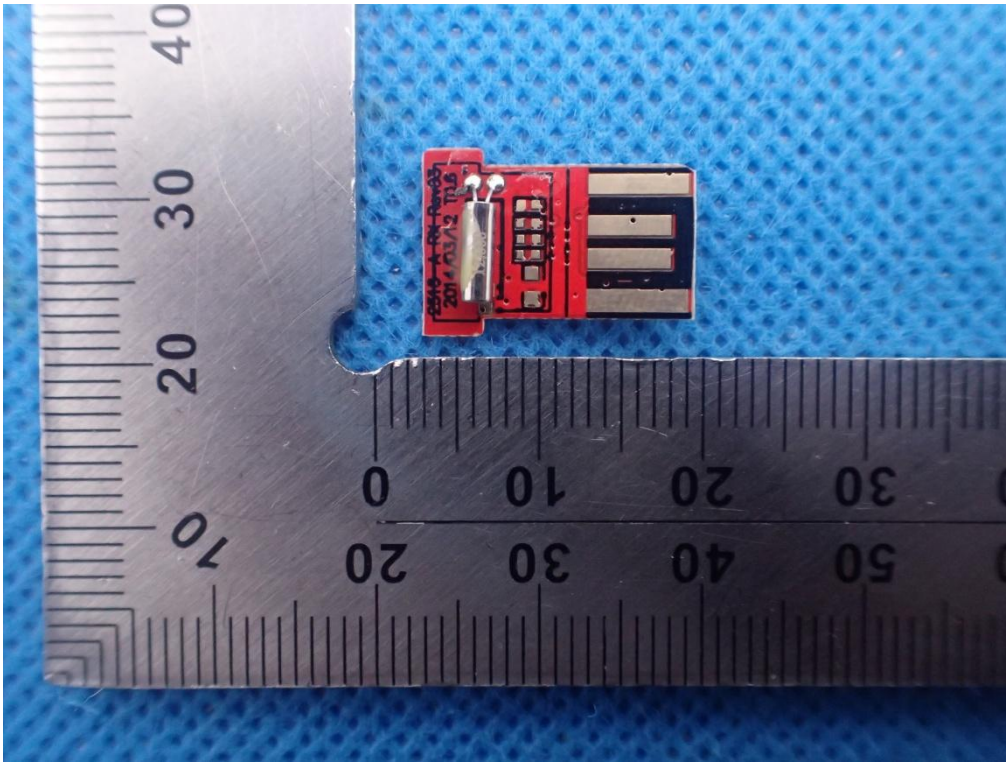

----END OF REPORT----