



FCC Test Report

Report No.: AGC04844150801FE03

FCC ID : 2AFHPBR-C8
APPLICATION PURPOSE : Original Equipment
PRODUCT DESIGNATION : Bluetooth Car Kit
BRAND NAME : Aukey
MODEL NAME : Aukey BR-C8
CLIENT : Shenzhen Aukey E Business Co., Ltd.
DATE OF ISSUE : Aug.20,2015
STANDARD(S) : FCC Part 15 Rules
TEST PROCEDURE(S)
REPORT VERSION : V1.0

Attestation of Global Compliance (Shenzhen) Co., Ltd



CAUTION:

This report shall not be reproduced except in full without the written permission of the test laboratory and shall not be quoted out of context.



Report Revise Record

Report Version	Revise Time	Issued Date	Valid Version	Notes
V1.0	/	Aug.20,2015	Valid	Original Report

TABLE OF CONTENTS

- 1. VERIFICATION OF CONFORMITY 4**
- 2. GENERAL INFORMATION 5**
 - 2.1. PRODUCT DESCRIPTION.....5
 - 2.2. TABLE OF CARRIER FREQUENCYS.....5
- 3. MEASUREMENT UNCERTAINTY..... 7**
- 4. DESCRIPTION OF TEST MODES..... 7**
- 5. SYSTEM TEST CONFIGURATION 8**
 - 5.1. CONFIGURATION OF EUT SYSTEM8
 - 5.2. EQUIPMENT USED IN EUT SYSTEM8
 - 5.3. SUMMARY OF TEST RESULTS8
- 6. TEST FACILITY 9**
- 7 ALL TEST EQUIPMENT LIST 9**
- 8. RADIATED EMISSION 10**
 - 8.1TEST LIMIT.....10
 - 8.2. MEASUREMENT PROCEDURE 11
 - 8.3. TEST SETUP.....13
 - 8.4. TEST RESULT15
- 9. BAND EDGE EMISSION 41**
 - 9.1. MEASUREMENT PROCEDURE41
 - 9.2 TEST SETUP41
 - 9.3 RADIATED TEST RESULT42
- 10. 20DB BANDWIDTH..... 50**
 - 10.1. MEASUREMENT PROCEDURE50
 - 10.2. TEST SET-UP50
 - 10.3. LIMITS AND MEASUREMENT RESULTS.....50
- 11. FCC LINE CONDUCTED EMISSION TEST 59**
 - 11.1. LIMITS OF LINE CONDUCTED EMISSION TEST59
 - 11.2. BLOCK DIAGRAM OF LINE CONDUCTED EMISSION TEST.....59
 - 11.3. PRELIMINARY PROCEDURE OF LINE CONDUCTED EMISSION TEST60
 - 11.4. FINAL PROCEDURE OF LINE CONDUCTED EMISSION TEST.....60
 - 11.5. TEST RESULT OF LINE CONDUCTED EMISSION TEST.....61
- APPENDIX A: PHOTOGRAPHS OF TEST SETUP 65**
- APPENDIX B: PHOTOGRAPHS OF EUT 67**

1. VERIFICATION OF CONFORMITY

Applicant	Shenzhen Aukey E Business Co., Ltd.
Address	Room 102, Bld P09, Huanan International Printing Paper Packing Logistics Zone, No.1 Huanan Rd, Pinghu Town, Longgang District ,Shenzhen City, Guangdong Province, 51800, China
Manufacturer	SHENZHEN SURE THING INDUSTRY AND COMMERCE DEVELOPMENT CO., LTD.
Address	2-3F, Building A, Fuxinlin Industrial Park, Hangcheng Industrial Area, Xixiang Town, Baoan District, Shenzhen
Product Designation	Bluetooth Car Kit
Brand Name	Aukey
Test Model	Aukey BR-C8
Date of test	Aug.17,2015 to Aug.19,2015
Deviation	None
Condition of Test Sample	Normal
Report Template	AGCRT-US-BR/RF

We hereby certify that:

The above equipment was tested by Compliance Certification Service(Shenzhen) Inc. The test data, data evaluation, test procedures, and equipment configurations shown in this report were made in accordance with the procedures given in ANSI C63.4 (2009) and the energy emitted by the sample EUT tested as described in this report is in compliance with radiated emission limits of FCC Rules Part 15.249.

Tested By

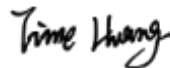

Time Huang(Huang Nanhui) Aug.20,2015

Reviewed By



Forrest Lei(Lei Yonggang) Aug.20,2015

Approved By



Solger Zhang(Zhang Hongyi)
Authorized Officer Aug.20,2015

2. GENERAL INFORMATION

2.1. PRODUCT DESCRIPTION

A major technical description of EUT is described as following

Operation Frequency	2.402 GHz to 2.480GHz
RF Output Power	1.93dBm(Max)
Bluetooth Version	V4.1
Modulation	GFSK, π /4-DQPSK, 8DPSK
Number of channels	79 for traditional BT 40 for BLE
Hardware Version	BTC03-C-8635B-V1.0
Software Version	BTC03-C-Aukey BR-C8-201507111437
Antenna Designation	PCB Antenna (Met 15.203 Antenna requirement)
Antenna Gain	0dBi
Power Supply	DC 5V

2.2. TABLE OF CARRIER FREQUENCIES

Traditional Bluetooth channel List

Frequency Band	Channel Number	Frequency
2400~2483.5MHZ	0	2402MHZ
	1	2403MHZ
	:	:
	38	2440 MHZ
	39	2441 MHZ
	40	2442 MHZ
	:	:
	77	2479 MHZ
	78	2480 MHZ

BLE Channel List

Frequency Band	Channel Number	Frequency
2400~2483.5MHZ	0	2402MHZ
	1	2404MHZ
	:	:
	38	2478 MHZ
	39	2480 MHZ

3. MEASUREMENT UNCERTAINTY

The reported uncertainty of measurement $y \pm U$, where expanded uncertainty U is based on a standard uncertainty multiplied by a coverage factor of $k=2$, providing a level of confidence of approximately 95 %.

No.	Item	Uncertainty
1	Conducted Emission Test	$\pm 3.18\text{dB}$
2	All emissions, radiated	$\pm 3.91\text{dB}$
3	Temperature	$\pm 0.5^\circ\text{C}$
4	Humidity	$\pm 2\%$

4. DESCRIPTION OF TEST MODES

NO.	TEST MODE DESCRIPTION
1	Low channel GFSK
2	Middle channel GFSK
3	High channel GFSK
4	Low channel $\pi/4$ -DQPSK
5	Middle channel $\pi/4$ -DQPSK
6	High channel $\pi/4$ -DQPSK
7	Low channel 8DPSK
8	Middle channel 8DPSK
9	High channel 8DPSK
10	Normal operation (BT)

Note:

1. Only the result of the worst case was recorded in the report, if no other cases.
2. For Radiated Emission, 3axis were chosen for testing for each applicable mode.

5. SYSTEM TEST CONFIGURATION

5.1. CONFIGURATION OF EUT SYSTEM

Configure 1: (Normal hopping)

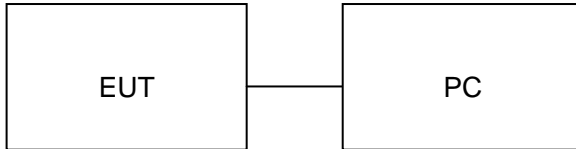

Configure 2: (Control continuous TX)

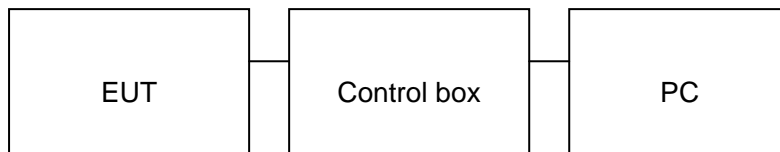

5.2. EQUIPMENT USED IN EUT SYSTEM

Item	Equipment	Model No.	ID or Specification	Remark
1	Bluetooth Car Kit	Aukey	Aukey BR-C8	EUT
2	PC	Dell	A1465	A.E
3	Control box	N/A	N/A	A.E
4	Power Cable + Audio Cable	N/A	1.9m, unshielded	A.E
5	Speaker	N/A	N5	A.E

5.3. SUMMARY OF TEST RESULTS

FCC RULES	DESCRIPTION OF TEST	RESULT
§15.249	Radiated Emission	Compliant
§15.249	Band Edges	Compliant
§15.207	Conduction Emission	Compliant
N/A	BANDWIDTH	Compliant

6. TEST FACILITY

Site	Compliance Certification Service(Shenzhen) Inc.
Location	No.10-1 Mingkeda Logistics Park, No.18 Huanguan South RD. Guan lan Town,Baoan Distr
FCC Registration No.	441872
Description	The test site is constructed and calibrated to meet the FCC requirements in documents ANSI C63.4:2009.

7 ALL TEST EQUIPMENT LIST

Radiated Emission Test Site 966(2)					
Name of Equipment	Manufacturer	Model Number	Serial Number	Last Calibration	Due Calibration
PSA Series Spectrum Analyzer	Agilent	E4446A	US44300399	03/01/2015	03/01/2016
EMI TEST RECEIVER	ROHDE&SCHWARZ	ESCI	100783	03/09/2015	03/08/2016
Amplifier	MITEQ	AM-1604-3000	1123808	03/18/2015	03/17/2016
High Noise Amplifier	Agilent	8449B	3008A01838	03/18/2015	03/17/2016
Board-Band Horn Antenna	Schwarzbeck	BBHA 9170	9170-497	07/10/2015	07/09/2016
Bilog Antenna	SCHAFFNER	CBL6143	5082	03/01/2015	03/01/2016
Horn Antenna	SCHWARZBECK	BBHA9120	D286	03/01/2015	03/01/2016
Loop Antenna	COM-POWER	AL-130	121044	09/27/2014	09/26/2015
Turn Table	N/A	N/A	N/A	N.C.R	N.C.R
Controller	Sunol Sciences	SC104V	022310-1	N.C.R	N.C.R
Controller	CT	N/A	N/A	N.C.R	N.C.R
Temp. / Humidity Meter	Anymetre	JR913	N/A	02/28/2015	02/27/2016
Antenna Tower	SUNOL	TLT2	N/A	N.C.R	N.C.R
Test S/W	FARAD	LZ-RF / CCS-SZ-3A2			

Conducted Emission Test Site					
Name of Equipment	Manufacturer	Model Number	Serial Number	Last Calibration	Due Calibration
EMI TEST RECEIVER	ROHDE&SCHWARZ	ESCI	100783	03/09/2015	03/08/2016
LISN(EUT)	ROHDE&SCHWARZ	ENV216	101543-WX	03/09/2015	03/08/2016
LISN	EMCO	3825/2	8901-1459	03/09/2015	03/08/2016
Temp. / Humidity Meter	VICTOR	HTC-1	N/A	03/04/2015	03/03/2016
Test S/W	FARAD	EZ-EMC/ CCS-3A1-CE			

8. RADIATED EMISSION

8.1 TEST LIMIT

Standard FCC15.249

Fundamental Frequency	Field Strength of Fundamental (millivolts/meter)	Field Strength of Harmonics (microvolts/meter)
900-928MHz	50	500
2400-2483.5MHz	50	500
5725-5875MHz	50	500
24.0-24.25GHz	250	2500

Standard FCC 15.209

Frequency (MHz)	Distance Meters	Field Strengths Limit	
		μ V/m	dB(μ V)/m
0.009 ~ 0.490	300	2400/F(kHz)	---
0.490 ~ 1.705	30	24000/F(kHz)	---
1.705 ~ 30	30	30	---
30 ~ 88	3	100	40.0
88 ~ 216	3	150	43.5
216 ~ 960	3	200	46.0
960 ~ 1000	3	500	54.0
Above 1000	3	Other:74.0 dB(μ V)/m (Peak) 54.0 dB(μ V)/m (Average)	

Remark: (1) Emission level $\text{dB}\mu\text{V} = 20 \log \text{Emission level } \mu\text{V/m}$
(2) The smaller limit shall apply at the cross point between two frequency bands.
(3) Distance is the distance in meters between the measuring instrument, antenna and the closest point of any part of the device or system.

8.2. MEASUREMENT PROCEDURE

1. Configure the EUT according to ANSI C63.4. The EUT was placed on the top of the turntable 0.8 meter above ground. The phase center of the receiving antenna mounted on the top of a height-variable antenna tower was placed 3 meters far away from the turntable.
2. Power on the EUT and all the supporting units. The turntable was rotated by 360 degrees to determine the position of the highest radiation.
3. The height of the broadband receiving antenna was varied between one meter and four meters above ground to find the maximum emissions field strength of both horizontal and vertical polarization.
4. For each suspected emissions, the antenna tower was scan (from 1 M to 4 M) and then the turntable was rotated (from 0 degree to 360 degrees) to find the maximum reading.
5. Set the test-receiver system to Peak or CISPR quasi-peak Detect Function with specified bandwidth under Maximum Hold Mode.
6. For emissions above 1GHz, use 1.5MHz VBW and RBW for peak reading. Then 1.5MHz RBW and 10Hz VBW for average reading in spectrum analyzer.
7. When the radiated emissions limits are expressed in terms of the average value of the emissions, and pulsed operation is employed, the measurement field strength shall be determined by averaging over one complete pulse train, including blanking intervals, as long as the pulse train does not exceed 0.1 seconds. As an alternative (provided the transmitter operates for longer than 0.1 seconds) or in cases where the pulse train exceeds 0.1 seconds, the measured field strength shall be determined from the average absolute voltage during a 0.1 second interval during which the field strength is at its maximum values.
8. If the emissions level of the EUT in peak mode was 3 dB lower than the average limit specified, then testing will be stopped and peak values of EUT will be reported, otherwise, the emissions which do not have 3 dB margin will be repeated one by one using the quasi-peak method for below 1GHz.
9. For testing above 1GHz, the emissions level of the EUT in peak mode was lower than average limit (that means the emissions level in peak mode also complies with the limit in average mode), then testing will be stopped and peak values of EUT will be reported, otherwise, the emissions will be measured in average mode again and reported.
10. In case the emission is lower than 30MHz, loop antenna has to be used for measurement and the recorded data should be QP measured by receiver. High - Low scan is not required in this case.

The following table is the setting of spectrum analyzer and receiver.

Spectrum Parameter	Setting
Start ~Stop Frequency	9KHz~150KHz/RB 200Hz for QP
Start ~Stop Frequency	150KHz~30MHz/RB 9KHz for QP
Start ~Stop Frequency	30MHz~1000MHz/RB 120KHz for QP
Start ~Stop Frequency	1GHz~26.5GHz 1.5MHz/1.5MHz for Peak, 1.5MHz/10Hz for Average

Receiver Parameter	Setting
Start ~Stop Frequency	9KHz~150KHz/RB 200Hz for QP
Start ~Stop Frequency	150KHz~30MHz/RB 9KHz for QP
Start ~Stop Frequency	30MHz~1000MHz/RB 120KHz for QP

8.3. TEST SETUP

Radiated Emission Test-Setup Frequency Below 30MHz

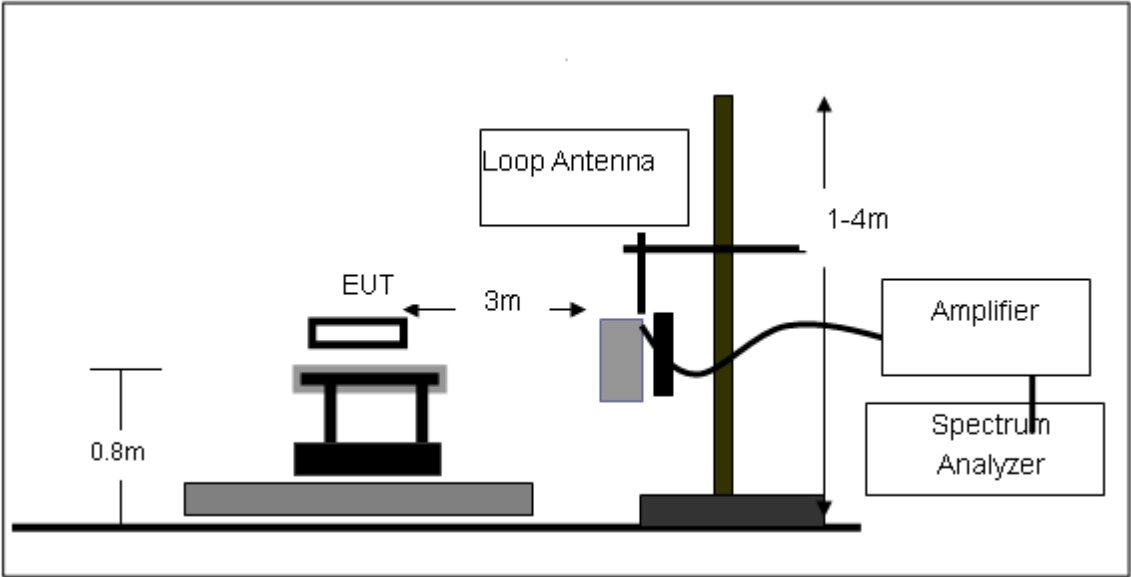

RADIATED EMISSION TEST SETUP 30MHz-1000MHz

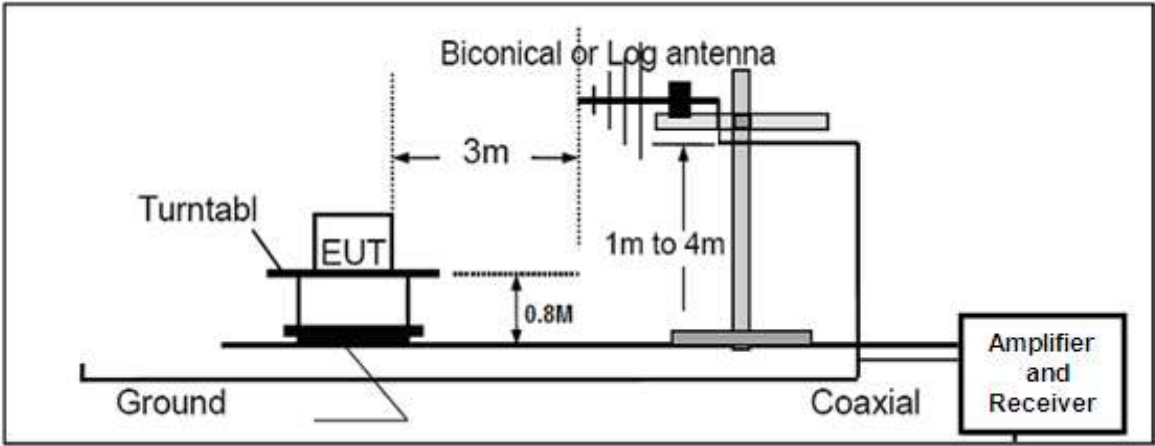

RADIATED EMISSION TEST SETUP ABOVE 1000MHz

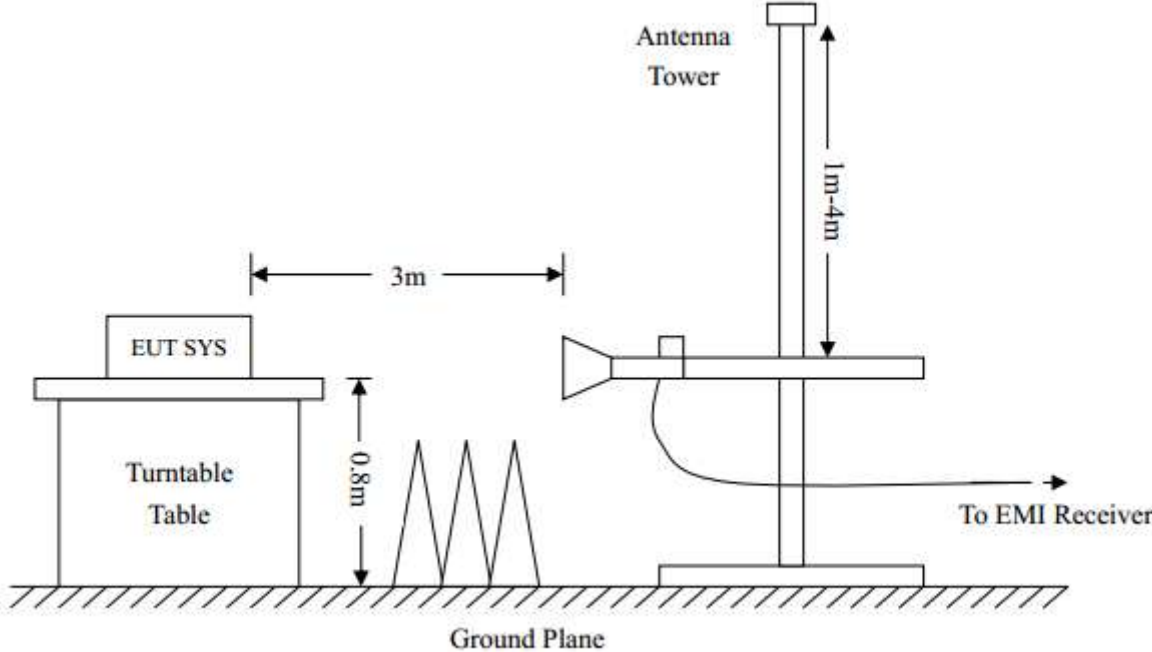

8.4. TEST RESULT

(Worst modulation:GFSK)

FOR TRADITIONAL BLUETOOTH

RADIATED EMISSION BELOW 30MHZ

No emission found between lowest internal used/generated frequencies to 30MHz.

RADIATED EMISSION BELOW 1GHZ

RADIATED EMISSION TEST- (30MHZ-1GHZ)-LOW CHANNEL-HORIZONTAL

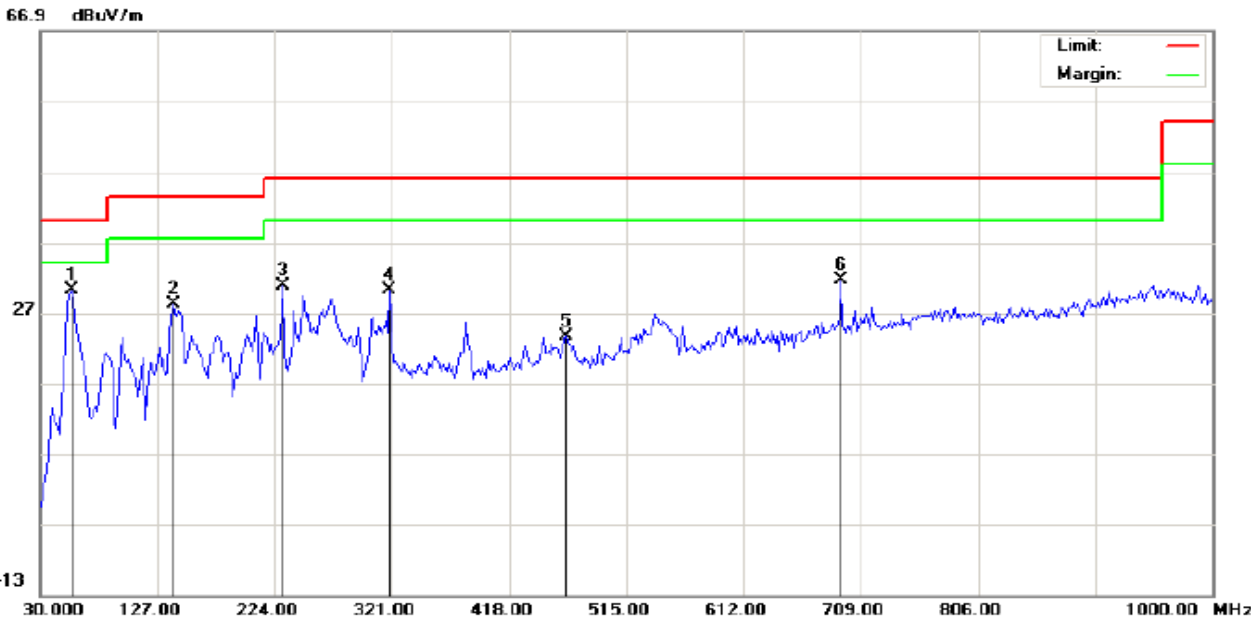

Site: site #1	Polarization: <i>Horizontal</i>	Temperature: 22.4
Limit: FCC Class B 3M Radiation	Power:	Humidity: 53.8 %
EUT: Bluetooth Car Kit	Distance: 3m	
M/N: Aukey BR-C8		
Mode: Low Channel TX		
Note:		

No.	Mk	Freq.	Reading	Factor	Measurement	Limit	Over	Detector	Antenna Height	Table Degree	Comment
		MHz	dBuV	dB/m	dBuV/m	dBuV/m	dB		cm	degree	
1	*	55.8667	19.01	11.19	30.20	40.00	-9.80	peak			
2		139.9333	13.10	15.19	28.29	43.50	-15.21	peak			
3		230.4667	17.55	13.16	30.71	46.00	-15.29	peak			
4		319.3833	13.50	16.70	30.20	46.00	-15.80	peak			
5		464.8833	2.80	20.75	23.55	46.00	-22.45	peak			
6		692.8333	6.52	25.00	31.52	46.00	-14.48	peak			

RESULT: PASS

RADIATED EMISSION TEST- (30MHZ-1GHZ)-LOW CHANNEL -VERTICAL

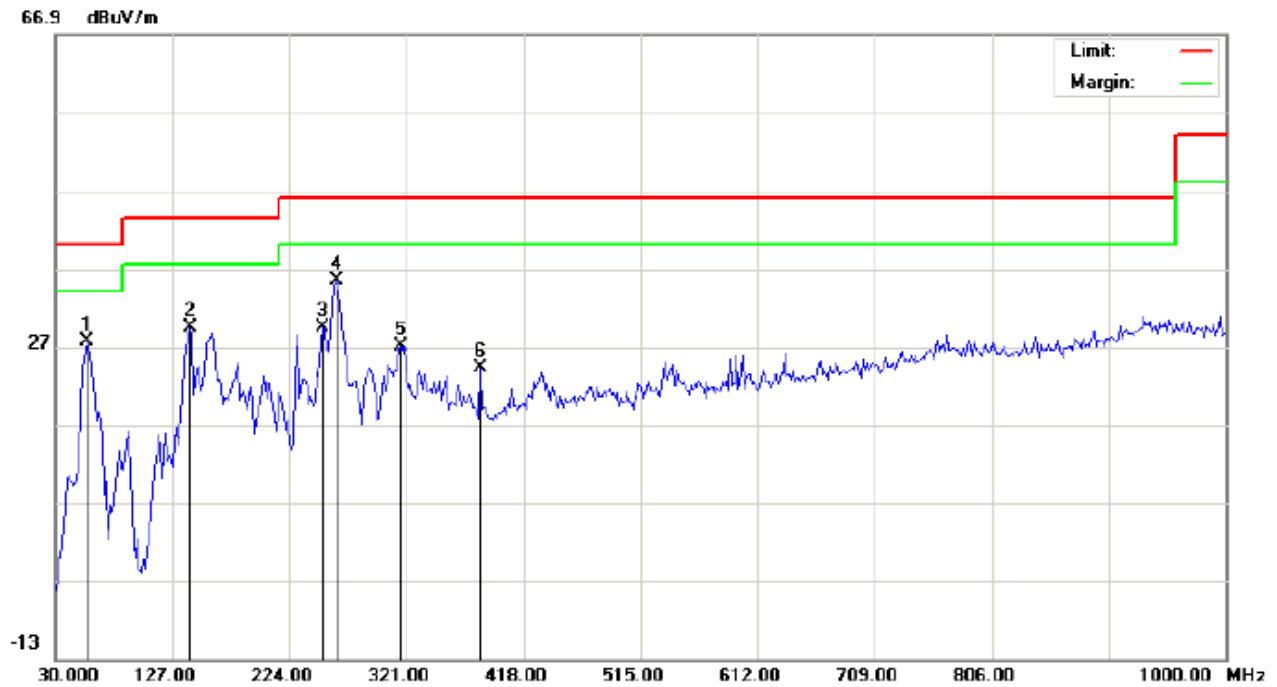

Site: site #1
Limit: FCC Class B 3M Radiation
EUT: Bluetooth Car Kit
M/N: Aukey BR-C8
Mode: Low Channel TX
Note:

Polarization: **Vertical**
Power:
Distance: 3m

Temperature: 22.4
Humidity: 53.8 %

No.	Mk	Freq.	Reading	Factor	Measurement	Limit	Over	Detector	Antenna Height	Table Degree	Comment
		MHz	dBuV	dB/m	dBuV/m	dBuV/m	dB		cm	degree	
1		55.8667	19.35	8.19	27.54	40.00	-12.46	peak			
2		141.5500	14.15	15.21	29.36	43.50	-14.14	peak			
3		251.4833	15.56	13.94	29.50	46.00	-16.50	peak			
4	*	262.8000	21.18	14.29	35.47	46.00	-10.53	peak			
5		316.1500	10.58	16.49	27.07	46.00	-18.93	peak			
6		382.4333	5.26	18.95	24.21	46.00	-21.79	peak			

RESULT: PASS

Note: 1. Factor=Antenna Factor + Cable loss, Margin=Measurement-Limit.

2. The "Factor" value can be calculated automatically by software of measurement system.

RADIATED EMISSION TEST- (30MHZ-1GHZ)-MIDDLE CHANNEL-HORIZONTAL

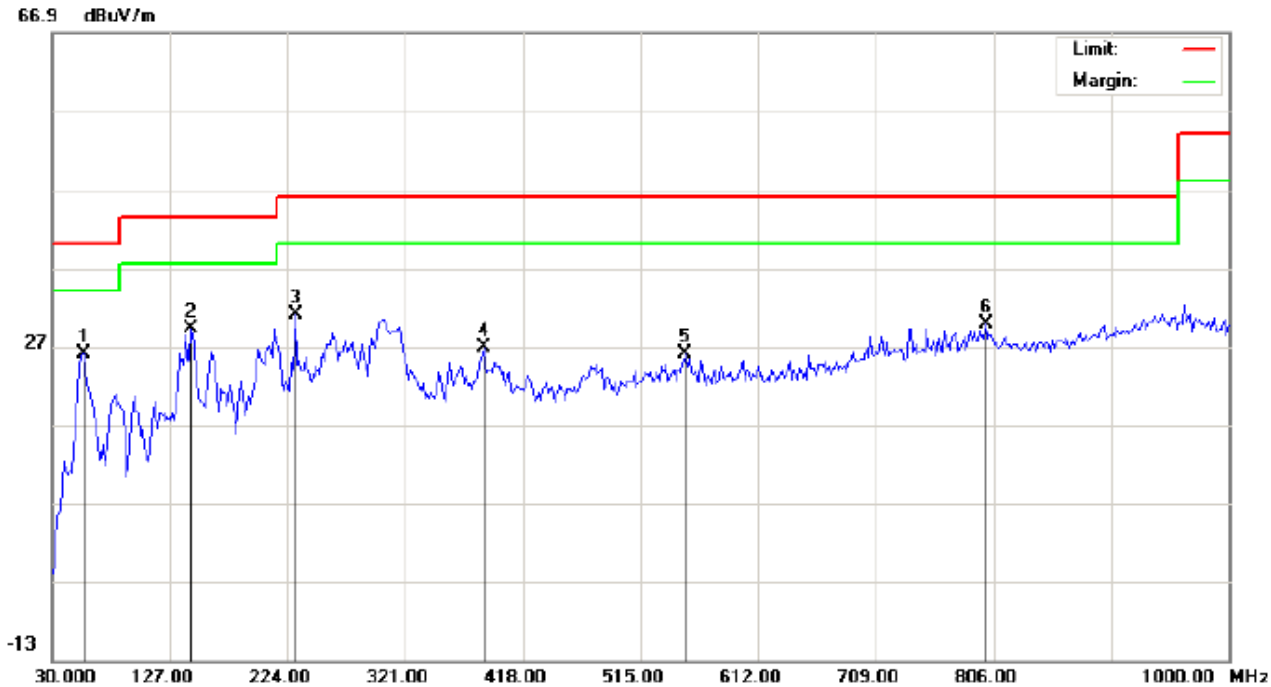

Site: site #1
 Limit: FCC Class B 3M Radiation
 EUT: Bluetooth Car Kit
 M/N: Aukey BR-C8
 Mode: Middle Channel TX
 Note:

Polarization: *Horizontal*
 Power:
 Distance: 3m

Temperature: 22.4
 Humidity: 53.8 %

No.	Mk	Freq.	Reading	Factor	Measurement	Limit	Over	Detector	Antenna Height	Table Degree	Comment
		MHz	dBuV	dB/m	dBuV/m	dBuV/m	dB		cm	degree	
1	*	55.8667	14.90	11.19	26.09	40.00	-13.91	peak			
2		144.7833	13.91	15.23	29.14	43.50	-14.36	peak			
3		230.4667	17.85	13.16	31.01	46.00	-14.99	peak			
4		385.6667	7.81	18.98	26.79	46.00	-19.21	peak			
5		552.1833	3.43	22.53	25.96	46.00	-20.04	peak			
6		799.5333	2.55	27.31	29.86	46.00	-16.14	peak			

RESULT: PASS

RADIATED EMISSION TEST- (30MHZ-1GHZ)- MIDDLE CHANNEL -VERTICAL

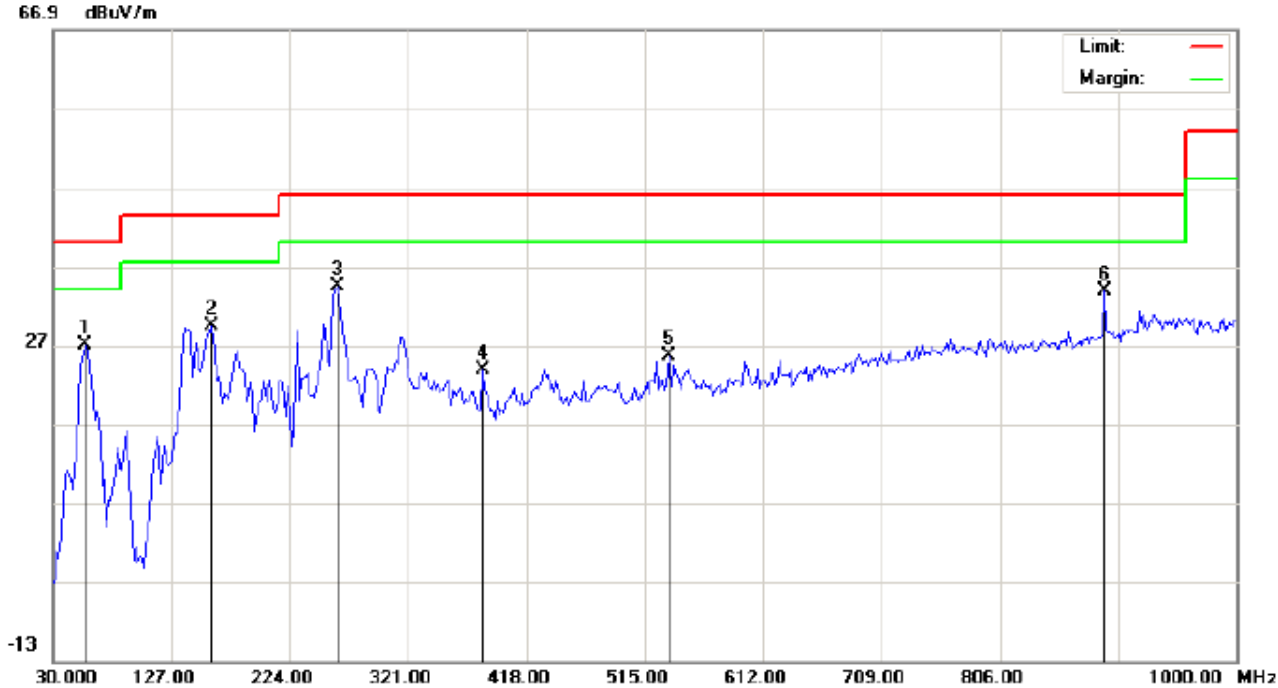

Site: site #1 Polarization: **Vertical** Temperature: 22.4
 Limit: FCC Class B 3M Radiation Power: Humidity: 53.8 %
 EUT: Bluetooth Car Kit Distance: 3m
 M/N: Aukey BR-C8
 Mode: Middle Channrel TX
 Note:

No.	Mk	Freq.	Reading	Factor	Measurement	Limit	Over	Detector	Antenna Height	Table Degree	Comment
		MHz	dBuV	dB/m	dBuV/m	dBuV/m	dB		cm	degree	
1		55.8667	18.79	8.19	26.98	40.00	-13.02	peak			
2		159.3333	14.15	15.33	29.48	43.50	-14.02	peak			
3	*	262.8000	20.02	14.29	34.31	46.00	-11.69	peak			
4		382.4333	4.87	18.95	23.82	46.00	-22.18	peak			
5		534.4000	3.48	22.06	25.54	46.00	-20.46	peak			
6		891.6833	5.37	28.39	33.76	46.00	-12.24	peak			

RESULT: PASS

- Note:** 1. Factor=Antenna Factor + Cable loss, Margin=Measurement-Limit.
 2. The "Factor" value can be calculated automatically by software of measurement system.

RADIATED EMISSION TEST- (30MHZ-1GHZ)-HIGH CHANNEL-HORIZONTAL

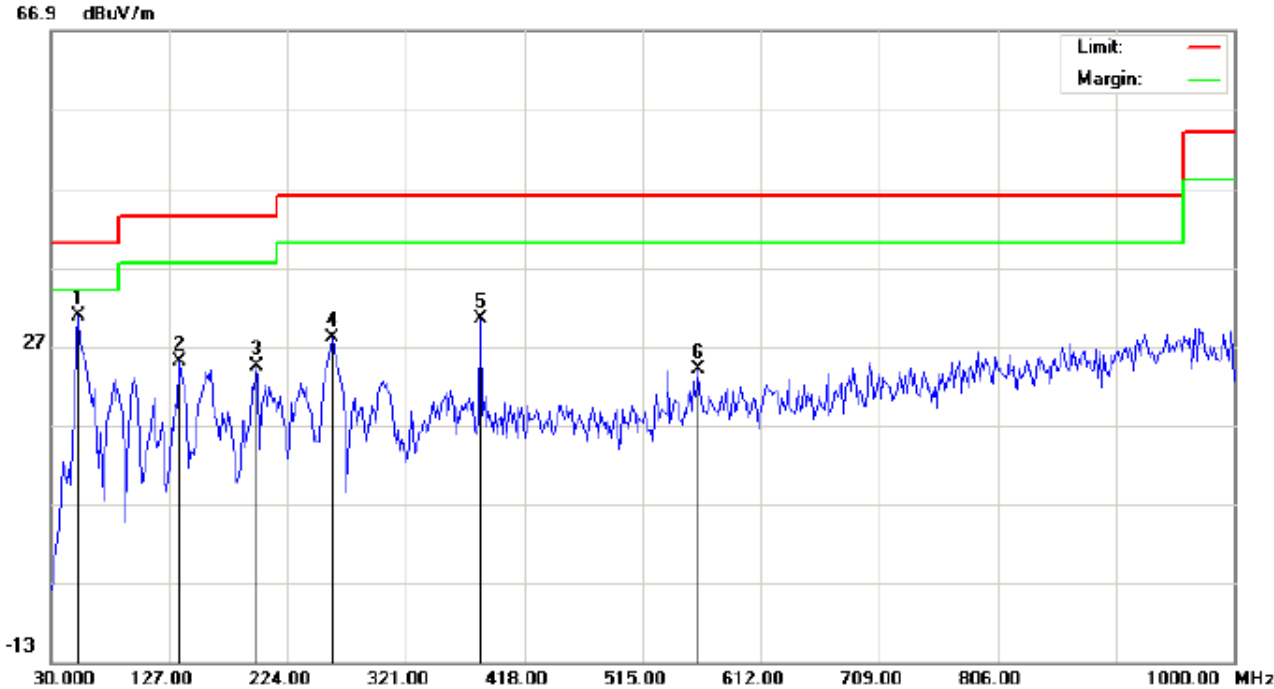

Site: site #1
 Limit: FCC Class B 3M Radiation
 EUT: Bluetooth Car Kit
 M/N: Aukey BR-C8
 Mode: High Channel TX
 Note:

Polarization: *Horizontal*
 Power:
 Distance: 3m

Temperature: 22.4
 Humidity: 53.8 %

No.	Mk	Freq.	Reading	Factor	Measurement	Limit	Over	Detector	Antenna Height	Table Degree	Comment
		MHz	dBuV	dB/m	dBuV/m	dBuV/m	dB		cm	degree	
1	*	52.6333	19.65	11.22	30.87	40.00	-9.13	peak			
2		135.0833	10.63	14.38	25.01	43.50	-18.49	peak			
3		198.1333	12.57	11.91	24.48	43.50	-19.02	peak			
4		261.1833	13.85	14.24	28.09	46.00	-17.91	peak			
5		382.4333	11.51	18.95	30.46	46.00	-15.54	peak			
6		560.2667	1.34	22.74	24.08	46.00	-21.92	peak			

RESULT: PASS

RADIATED EMISSION TEST- (30MHZ-1GHZ)-HIGH CHANNEL -VERTICAL

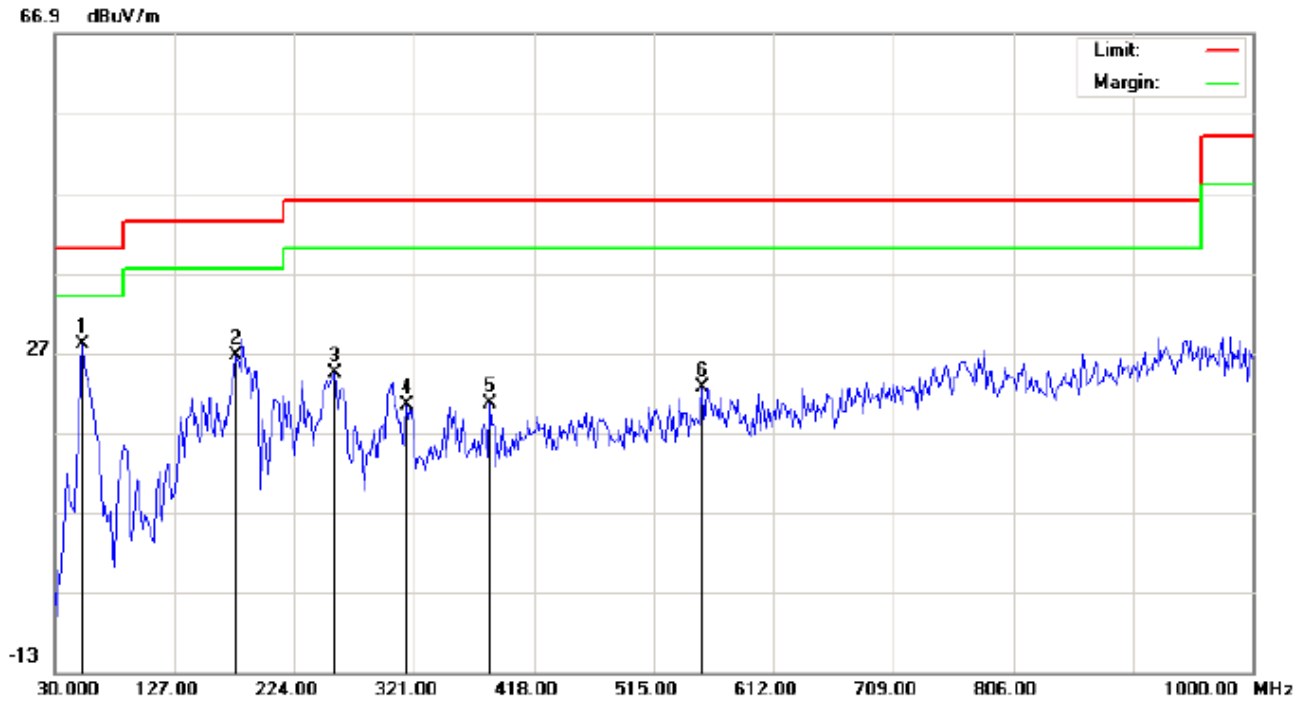

Site: site #1	Polarization: <i>Vertical</i>	Temperature: 22.4
Limit: FCC Class B 3M Radiation	Power:	Humidity: 53.8 %
EUT: Bluetooth Car Kit	Distance: 3m	
M/N: Aukey BR-C8		
Mode: High Channel TX		
Note:		

No.	Mk	Freq.	Reading	Factor	Measurement	Limit	Over	Detector	Antenna Height	Table Degree	Comment
		MHz	dBuV	dB/m	dBuV/m	dBuV/m	dB		cm	degree	
1	*	52.6333	19.70	8.22	27.92	40.00	-12.08	peak			
2		177.1167	12.39	14.25	26.64	43.50	-16.86	peak			
3		256.3333	10.23	14.09	24.32	46.00	-21.68	peak			
4		314.5333	3.99	16.38	20.37	46.00	-25.63	peak			
5		382.4333	1.72	18.95	20.67	46.00	-25.33	peak			
6		553.8000	0.11	22.50	22.61	46.00	-23.39	peak			

RESULT: PASS

Note: 1. Factor=Antenna Factor + Cable loss, Margin=Measurement-Limit.

2. The "Factor" value can be calculated automatically by software of measurement system.

FOR BLE

RADIATED EMISSION BELOW 30MHZ

No emission found between lowest internal used/generated frequencies to 30MHz.

RADIATED EMISSION BELOW 1GHZ

RADIATED EMISSION TEST- (30MHZ-1GHZ)-LOW CHANNEL-HORIZONTAL

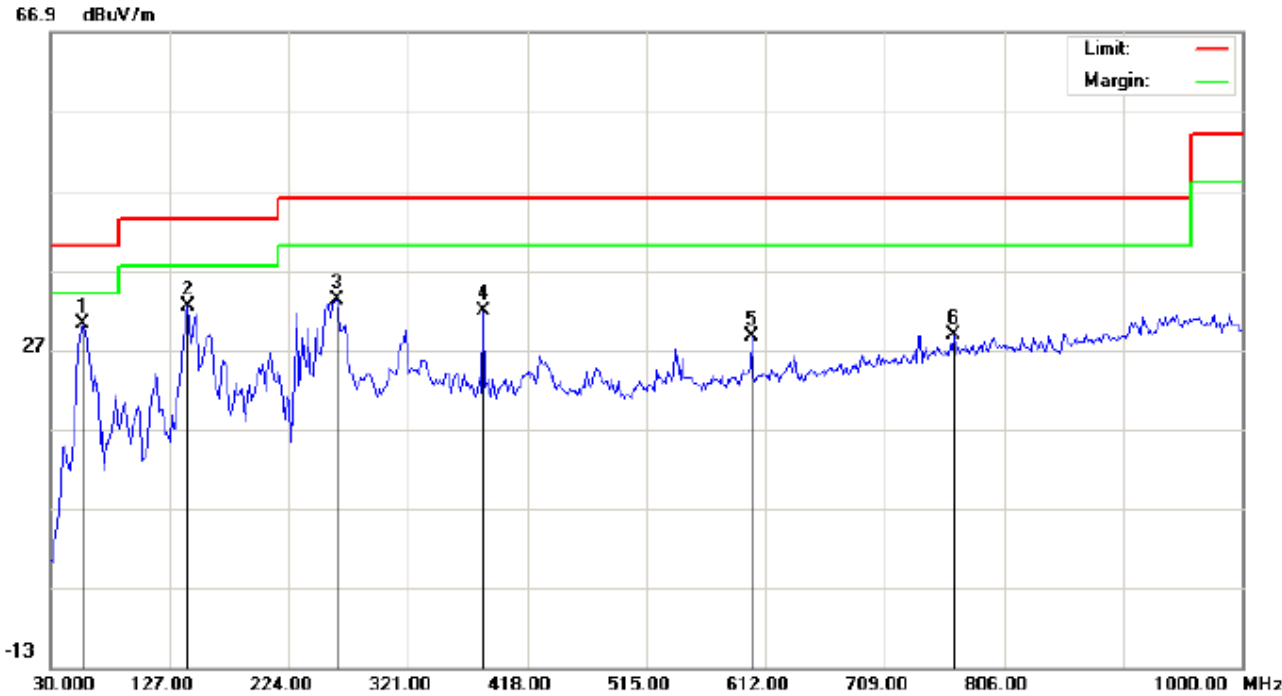

Site: site #1
 Limit: FCC Class B 3M Radiation
 EUT: Bluetooth Car Kit
 M/N: Aukey BR-C8
 Mode: Low Channel TX
 Note:

Polarization: *Horizontal*
 Power:
 Distance: 3m

Temperature: 22.4
 Humidity: 53.8 %

No.	Mk	Freq.	Reading	Factor	Measurement	Limit	Over	Detector	Antenna Height	Table Degree	Comment
		MHz	dBuV	dB/m	dBuV/m	dBuV/m	dB		cm	degree	
1	*	55.8667	18.92	11.19	30.11	40.00	-9.89	peak			
2		141.5500	17.19	15.21	32.40	43.50	-11.10	peak			
3		262.8000	18.85	14.29	33.14	46.00	-12.86	peak			
4		382.4333	12.79	18.95	31.74	46.00	-14.26	peak			
5		600.6833	4.81	23.73	28.54	46.00	-17.46	peak			
6		765.5833	1.90	26.85	28.75	46.00	-17.25	peak			

RESULT: PASS

RADIATED EMISSION TEST- (30MHZ-1GHZ)-LOW CHANNEL -VERTICAL

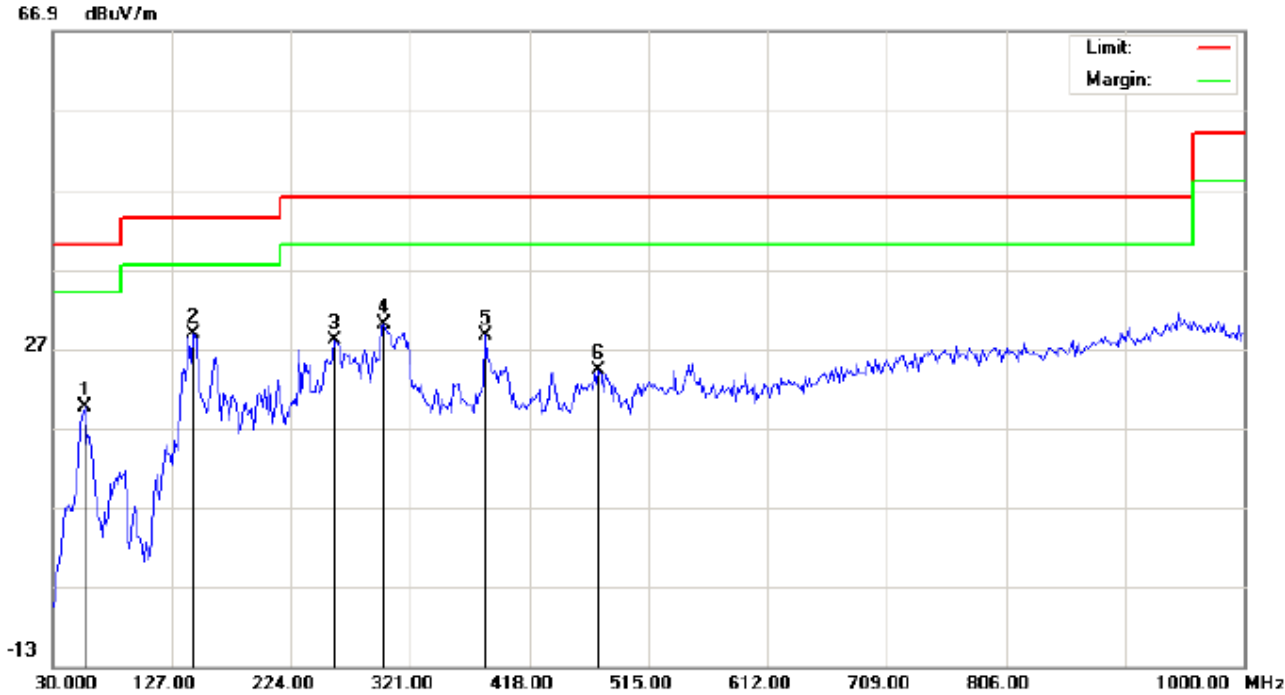

Site: site #1
 Limit: FCC Class B 3M Radiation
 EUT: Bluetooth Car Kit
 M/N: Aukey BR-C8
 Mode: Low Channel TX
 Note:

Polarization: *Vertical*
 Power:
 Distance: 3m

Temperature: 22.4
 Humidity: 53.8 %

No.	Mk	Freq.	Reading	Factor	Measurement	Limit	Over	Detector	Antenna Height	Table Degree	Comment
		MHz	dBuV	dB/m	dBuV/m	dBuV/m	dB		cm	degree	
1		55.8667	11.32	8.19	19.51	40.00	-20.49	peak			
2	*	144.7833	13.54	15.23	28.77	43.50	-14.73	peak			
3		259.5667	13.72	14.19	27.91	46.00	-18.09	peak			
4		299.9833	14.66	15.41	30.07	46.00	-15.93	peak			
5		382.4332	9.65	18.95	28.60	46.00	-17.40	peak			
6		474.5833	3.43	20.86	24.29	46.00	-21.71	peak			

RESULT: PASS

- Note:** 1. Factor=Antenna Factor + Cable loss, Margin=Measurement-Limit.
 2. The "Factor" value can be calculated automatically by software of measurement system.

RADIATED EMISSION TEST- (30MHZ-1GHZ)-MIDDLE CHANNEL-HORIZONTAL

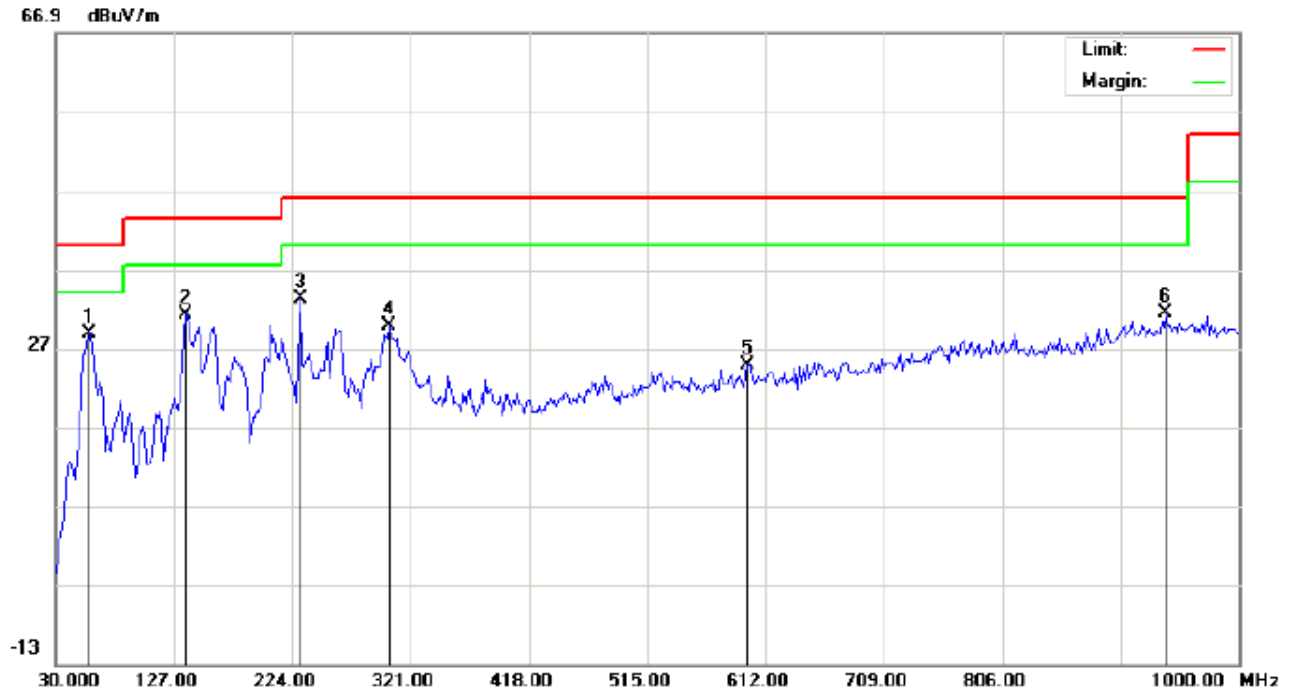

Site: site #1
Limit: FCC Class B 3M Radiation
EUT: Bluetooth Car Kit
M/N: Aukey BR-C8
Mode: Middle Channel TX
Note:

Polarization: *Horizontal*
Power:
Distance: 3m

Temperature: 22.4
Humidity: 53.8 %

No.	Mk	Freq.	Reading	Factor	Measurement	Limit	Over	Detector	Antenna Height	Table Degree	Comment
		MHz	dBuV	dB/m	dBuV/m	dBuV/m	dB		cm	degree	
1	*	57.4833	17.67	11.17	28.84	40.00	-11.16	peak			
2		136.7000	16.62	14.65	31.27	43.50	-12.23	peak			
3		230.4667	20.14	13.16	33.30	46.00	-12.70	peak			
4		303.2167	14.15	15.62	29.77	46.00	-16.23	peak			
5		597.4500	1.12	23.67	24.79	46.00	-21.21	peak			
6		940.1833	1.76	29.73	31.49	46.00	-14.51	peak			

RESULT: PASS

RADIATED EMISSION TEST- (30MHZ-1GHZ)- MIDDLE CHANNEL -VERTICAL

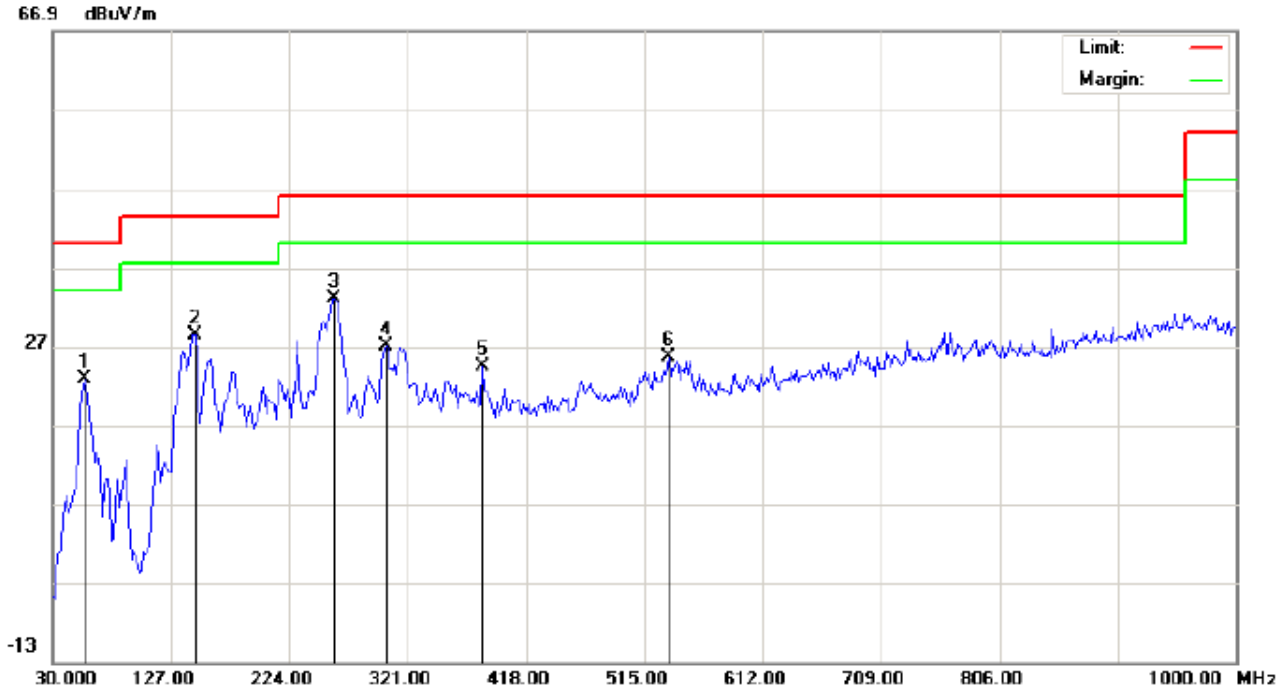

Site: site #1
 Limit: FCC Class B 3M Radiation
 EUT: Bluetooth Car Kit
 M/N: Aukey BR-C8
 Mode: Middle Channel TX
 Note:

Polarization: *Vertical*
 Power:
 Distance: 3m

Temperature: 22.4
 Humidity: 53.8 %

No.	Mk	Freq.	Reading	Factor	Measurement	Limit	Over	Detector	Antenna Height	Table Degree	Comment
		MHz	dBuV	dB/m	dBuV/m	dBuV/m	dB		cm	degree	
1		55.8667	14.63	8.19	22.82	40.00	-17.18	peak			
2		146.4000	13.25	15.24	28.49	43.50	-15.01	peak			
3	*	261.1833	18.76	14.24	33.00	46.00	-13.00	peak			
4		303.2167	11.40	15.62	27.02	46.00	-18.98	peak			
5		382.4333	5.44	18.95	24.39	46.00	-21.61	peak			
6		534.4000	3.50	22.06	25.56	46.00	-20.44	peak			

RESULT: PASS

- Note:** 1. Factor=Antenna Factor + Cable loss, Margin=Measurement-Limit.
 2. The "Factor" value can be calculated automatically by software of measurement system.

RADIATED EMISSION TEST- (30MHZ-1GHZ)-HIGH CHANNEL-HORIZONTAL

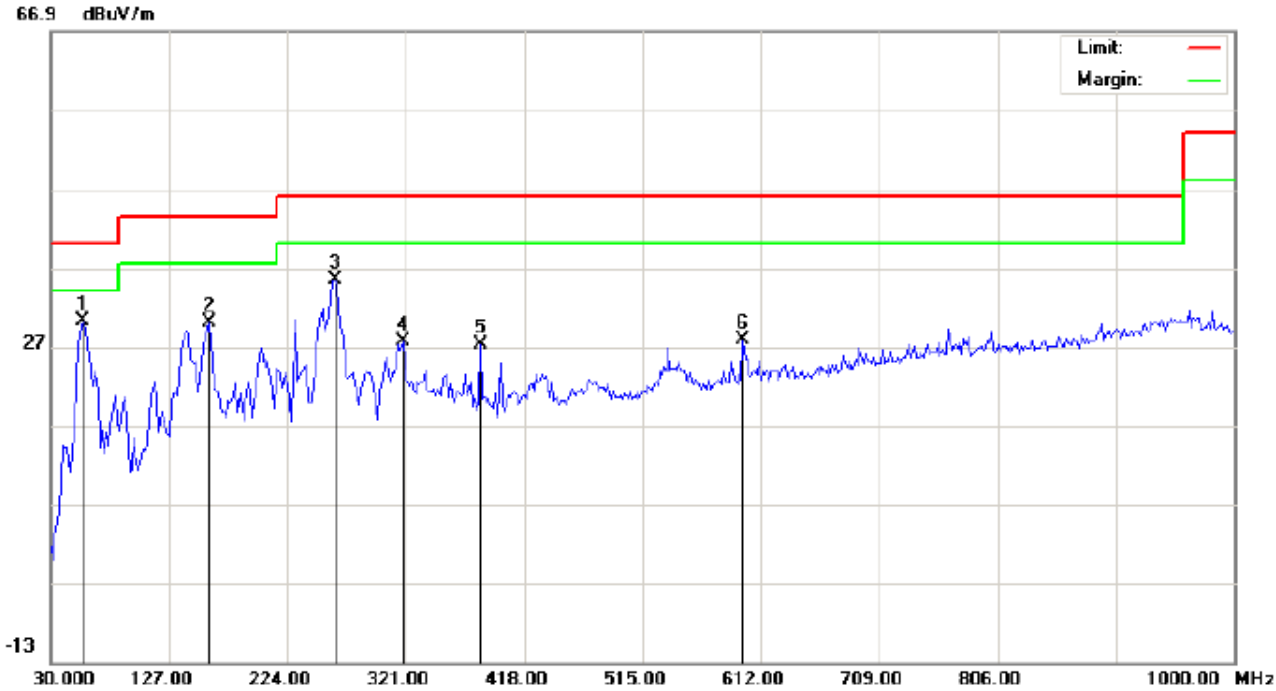

Site: site #1
 Limit: FCC Class B 3M Radiation
 EUT: Bluetooth Car Kit
 M/N: Aukey BR-C8
 Mode: High Channel TX
 Note:

Polarization: *Horizontal*
 Power:
 Distance: 3m

Temperature: 22.4
 Humidity: 53.8 %

No.	Mk	Freq.	Reading	Factor	Measurement	Limit	Over	Detector	Antenna Height	Table Degree	Comment
		MHz	dBuV	dB/m	dBuV/m	dBuV/m	dB		cm	degree	
1	*	55.8667	18.95	11.19	30.14	40.00	-9.86	peak			
2		159.3333	14.76	15.33	30.09	43.50	-13.41	peak			
3		262.8000	21.10	14.29	35.39	46.00	-10.61	peak			
4		319.3833	10.91	16.70	27.61	46.00	-18.39	peak			
5		382.4333	8.33	18.95	27.28	46.00	-18.72	peak			
6		597.4500	4.08	23.67	27.75	46.00	-18.25	peak			

RESULT: PASS

**RADIATED EMISSION ABOVE 1GHZ
 FOR TRADITIONAL BLUETOOTH**

RADIATED EMISSION TEST- (ABOVE 1GHZ)-LOW CHANNEL-HORIZONTAL

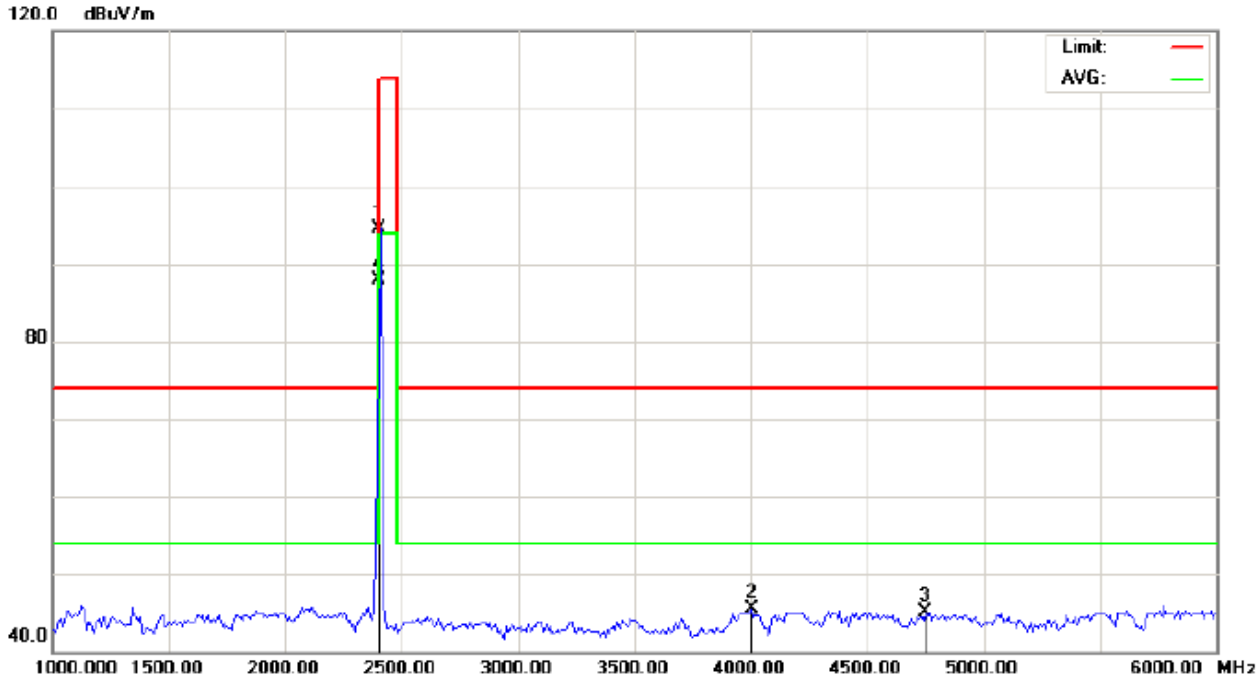

Site: site #1
 Limit: FCC Class B 3M Radiation above 1GHZ(PK)-
 EUT: Bluetooth Car Kit
 M/N: Aukey BR-C8
 Mode: Low Channel TX
 Note:

Polarization: *Horizontal*
 Power:
 Distance: 3m

Temperature: 26
 Humidity: 60 %

No.	Mk	Freq.	Reading	Factor	Measurement	Limit	Over	Detector	Antenna Height	Table Degree	Comment
		MHz	dBuV	dB/m	dBuV/m	dBuV/m	dB		cm	degree	
1		2402.000	104.23	-9.68	94.55	114.00	-19.45	peak			
2		4000.000	50.24	-4.81	45.43	74.00	-28.57	peak			
3		4750.000	47.53	-2.45	45.08	74.00	-28.92	peak			
4	*	2402.000	97.62	-9.68	87.94	94.00	-6.06	AVG	100	352	

RESULT: PASS

RADIATED EMISSION TEST- (ABOVE 1GHZ)-MIDDLE CHANNEL-HORIZONTAL

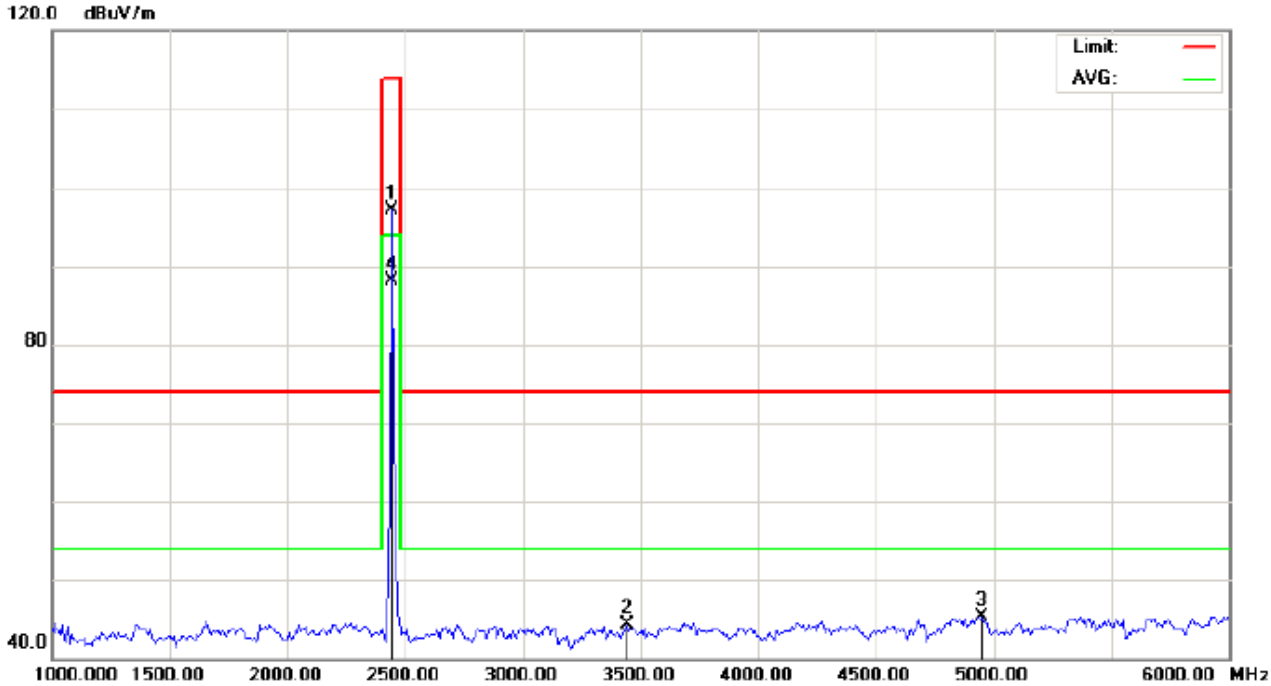

Site: site #1
 Limit: FCC Class B 3M Radiation above 1GHZ(PK)-
 EUT: Bluetooth Car Kit
 M/N: Aukey BR-C8
 Mode: Middle Channel TX
 Note:

Polarization: *Horizontal*
 Power:
 Distance: 3m

Temperature: 26
 Humidity: 60 %

No.	Mk	Freq.	Reading	Factor	Measurement	Limit	Over	Detector	Antenna Height	Table Degree	Comment
		MHz	dBuV	dB/m	dBuV/m	dBuV/m	dB		cm	degree	
1		2441.000	106.79	-9.63	97.16	114.00	-16.84	peak			
2		3441.667	52.30	-7.94	44.36	74.00	-29.64	peak			
3		4950.000	47.32	-1.93	45.39	74.00	-28.61	peak			
4	*	2441.000	97.75	-9.63	88.12	94.00	-5.88	AVG	100	197	

RESULT: PASS

RADIATED EMISSION TEST- (ABOVE 1GHZ)-MIDDLE CHANNEL- VERTICAL

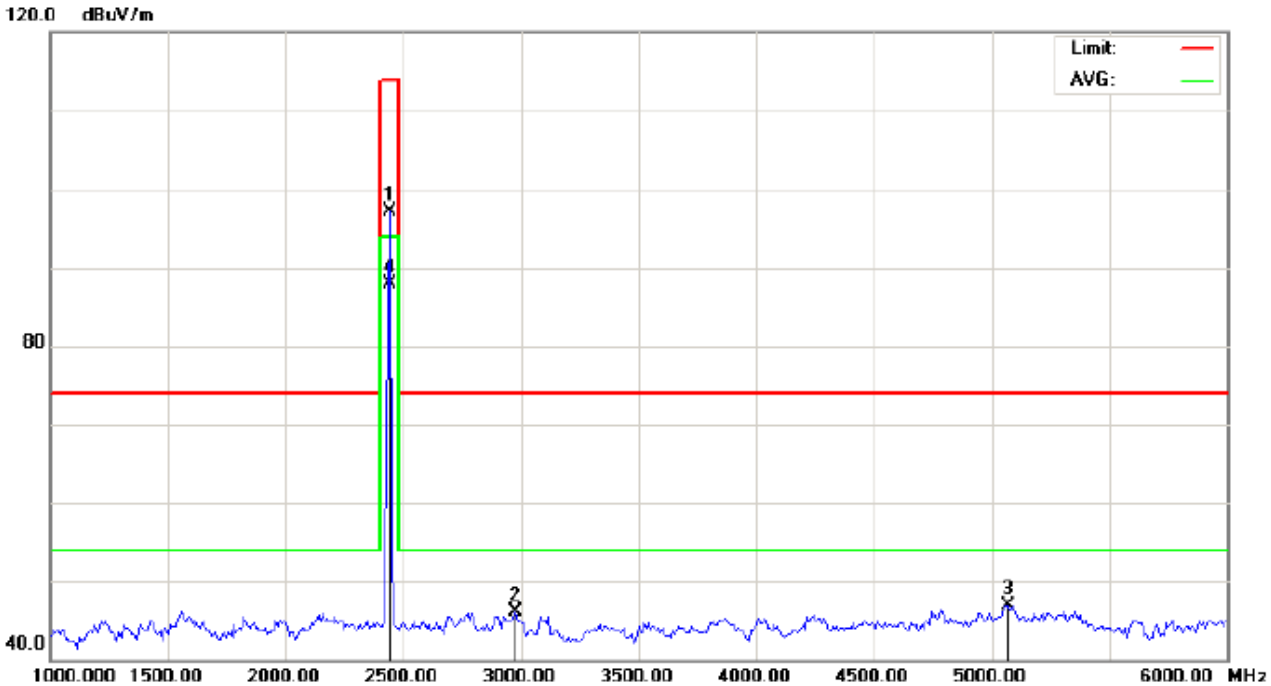

Site: site #1 Polarization: *Vertical* Temperature: 26
 Limit: FCC Class B 3M Radiation above 1GHZ(PK)- Power: Humidity: 60 %
 EUT: Bluetooth Car Kit Distance: 3m
 M/N: Aukey BR-C8
 Mode: Middle Channel TX
 Note:

No.	Mk	Freq.	Reading	Factor	Measurement	Limit	Over	Detector	Antenna Height	Table Degree	Comment
		MHz	dBuV	dB/m	dBuV/m	dBuV/m	dB		cm	degree	
1		2441.000	106.73	-9.63	97.10	114.00	-16.90	peak			
2		2975.000	54.45	-8.42	46.03	74.00	-27.97	peak			
3		5066.667	48.74	-1.80	46.94	74.00	-27.06	peak			
4	*	2441.000	97.55	-9.63	87.92	94.00	-6.08	AVG	100	351	

RESULT: PASS

Field strength of the fundamental signal

Peak value

Frequency	Reading Level	Factor	Measurement	Limit	Over	Antenna
(MHz)	(dBuv)	(dB/m)	(dBuv/m)	(dBuv/m)	(dB)	Polarization
2402	104.23	-9.68	94.55	114	-19.45	Horizontal
2402	104.16	-9.68	94.48	114	-19.52	Vertical
2441	106.79	-9.63	97.16	114	-16.84	Horizontal
2441	106.73	-9.63	97.10	114	-16.90	Vertical
2480	106.37	-9.59	96.78	114	-17.22	Horizontal
2480	106.42	-9.59	96.83	114	-17.17	Vertical

Average value

Frequency	Reading Level	Factor	Measurement	Limit	Over	Antenna
(MHz)	(dBuv)	(dB/m)	(dBuv/m)	(dBuv/m)	(dB)	Polarization
2402	97.62	-9.68	87.94	94	-6.06	Horizontal
2402	97.81	-9.68	88.13	94	-5.87	Vertical
2441	97.75	-9.63	88.12	94	-5.88	Horizontal
2441	97.55	-9.63	87.92	94	-6.08	Vertical
2480	98.04	-9.59	88.45	94	-5.55	Horizontal
2480	97.31	-9.59	87.72	94	-6.28	Vertical

RADIATED EMISSION TEST- (ABOVE 1GHZ)-MIDDLE CHANNEL-HORIZONTAL

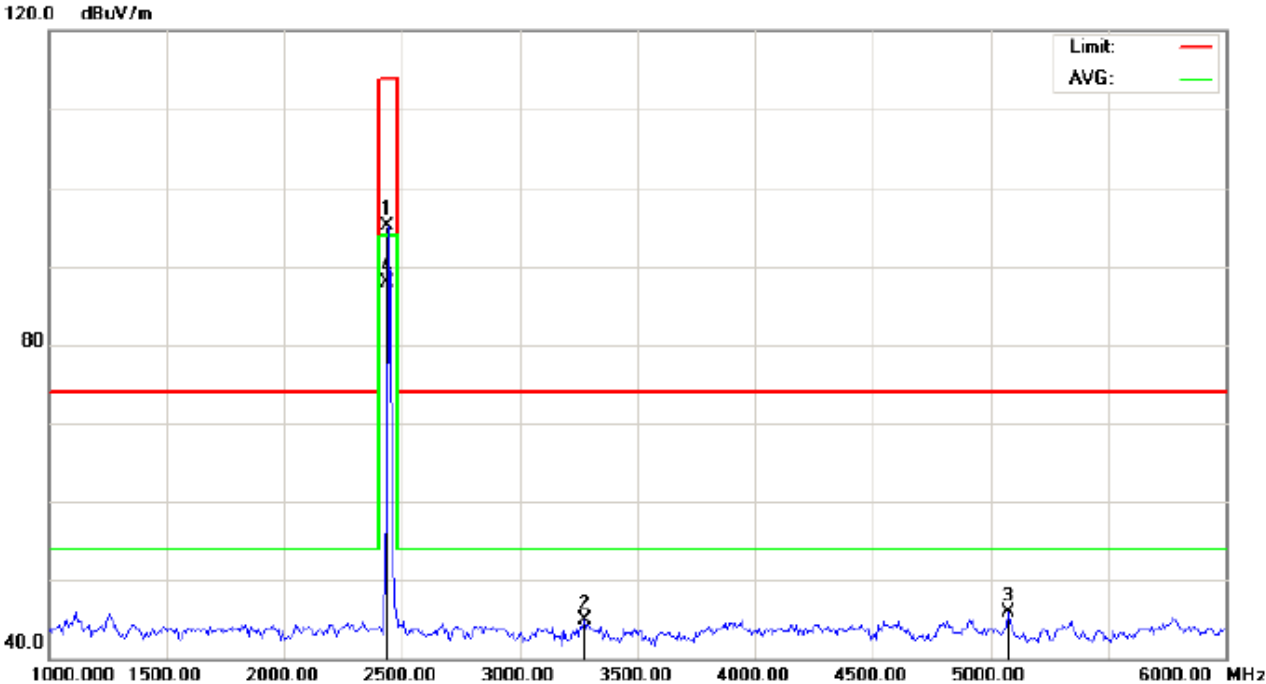

Site: site #1
 Limit: FCC Class B 3M Radiation above 1GHZ(PK)-
 EUT: Bluetooth Car Kit
 M/N: Aukey BR-C8
 Mode: Middle Channel TX
 Note:

Polarization: *Horizontal*
 Power:
 Distance: 3m

Temperature: 26
 Humidity: 60 %

No.	Mk	Freq.	Reading	Factor	Measurement	Limit	Over	Detector	Antenna Height	Table Degree	Comment
		MHz	dBuV	dB/m	dBuV/m	dBuV/m	dB		cm	degree	
1		2440.000	104.80	-9.64	95.16	114.00	-18.84	peak			
2		3275.000	52.99	-8.10	44.89	74.00	-29.11	peak			
3		5075.000	47.62	-1.80	45.82	74.00	-28.18	peak			
4	*	2440.000	97.61	-9.64	87.97	94.00	-6.03	AVG	100	292	

RESULT: PASS

Field strength of the fundamental signal

Peak value

Frequency	Reading Level	Factor	Measurement	Limit	Over	Antenna
(MHz)	(dBuv)	(dB/m)	(dBuv/m)	(dBuv/m)	(dB)	Polarization
2402	101.23	-9.68	91.55	114	-22.45	Horizontal
2402	101.31	-9.68	91.63	114	-22.37	Vertical
2440	104.80	-9.64	95.16	114	-18.84	Horizontal
2440	104.74	-9.64	95.10	114	-18.90	Vertical
2480	103.94	-9.59	94.35	114	-19.65	Horizontal
2480	104.30	-9.59	94.71	114	-19.29	Vertical

Average value

Frequency	Reading Level	Factor	Measurement	Limit	Over	Antenna
(MHz)	(dBuv)	(dB/m)	(dBuv/m)	(dBuv/m)	(dB)	Polarization
2402	98.15	-9.68	88.47	94	-5.53	Horizontal
2402	97.62	-9.68	87.94	94	-6.06	Vertical
2440	97.61	-9.64	87.97	94	-6.03	Horizontal
2440	98.17	-9.64	88.53	94	-5.47	Vertical
2480	97.42	-9.59	87.83	94	-6.17	Horizontal
2480	96.79	-9.59	87.20	94	-6.80	Vertical

9. BAND EDGE EMISSION

9.1. MEASUREMENT PROCEDURE

1The EUT operates at hopping-off test mode. The lowest or highest channels are tested to verify the largest transmission and spurious emissions power at the continuous transmission mode.

2Max hold the trace of the setp 1,and the EUT operates at hopping-on test mode to verify the largest spurious emissions power.

3Set the spectrum analyzer in the following setting in order to capture the lower and upper band-edges of the emission: (a) PEAK: RBW=VBW=1.5MHz / Sweep=AUTO

9.2 TEST SETUP

RADIATED EMISSION TEST SETUP

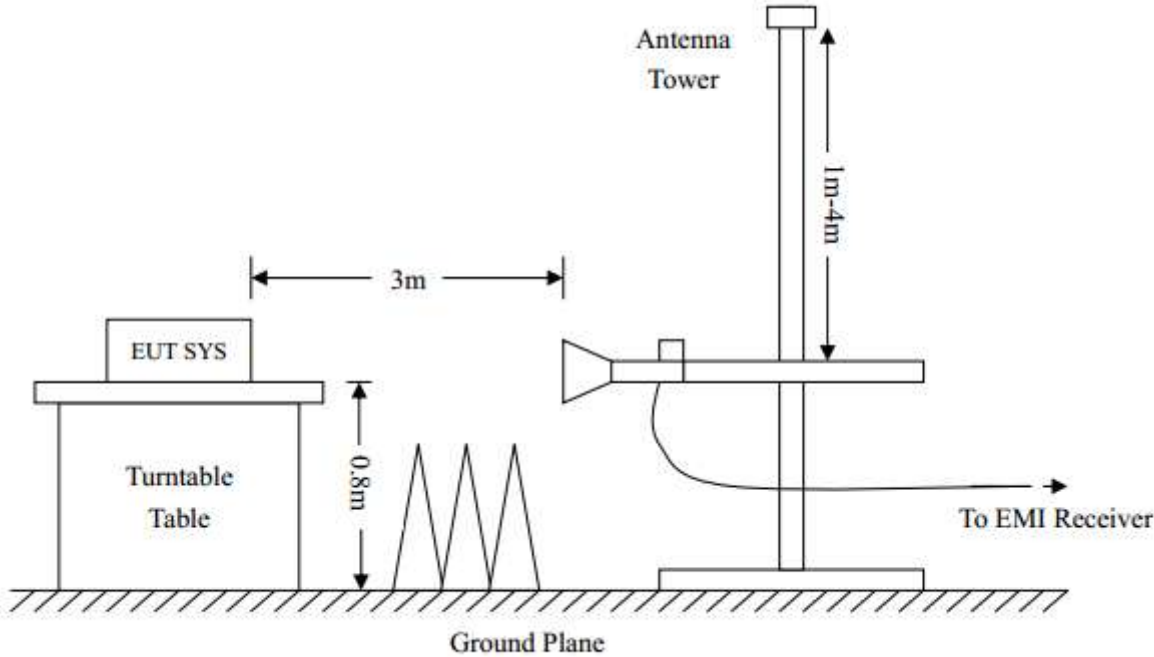

CONDUCTED TEST SETUP

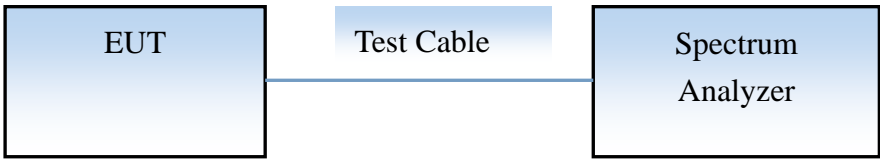

9.3 RADIATED TEST RESULT

(Worst modulation:GFSK)

FOR TRADITIONAL BLEUETOOTH

TEST PLOT OF BAND EDGE FOR LOW CHANNEL-Horizontal

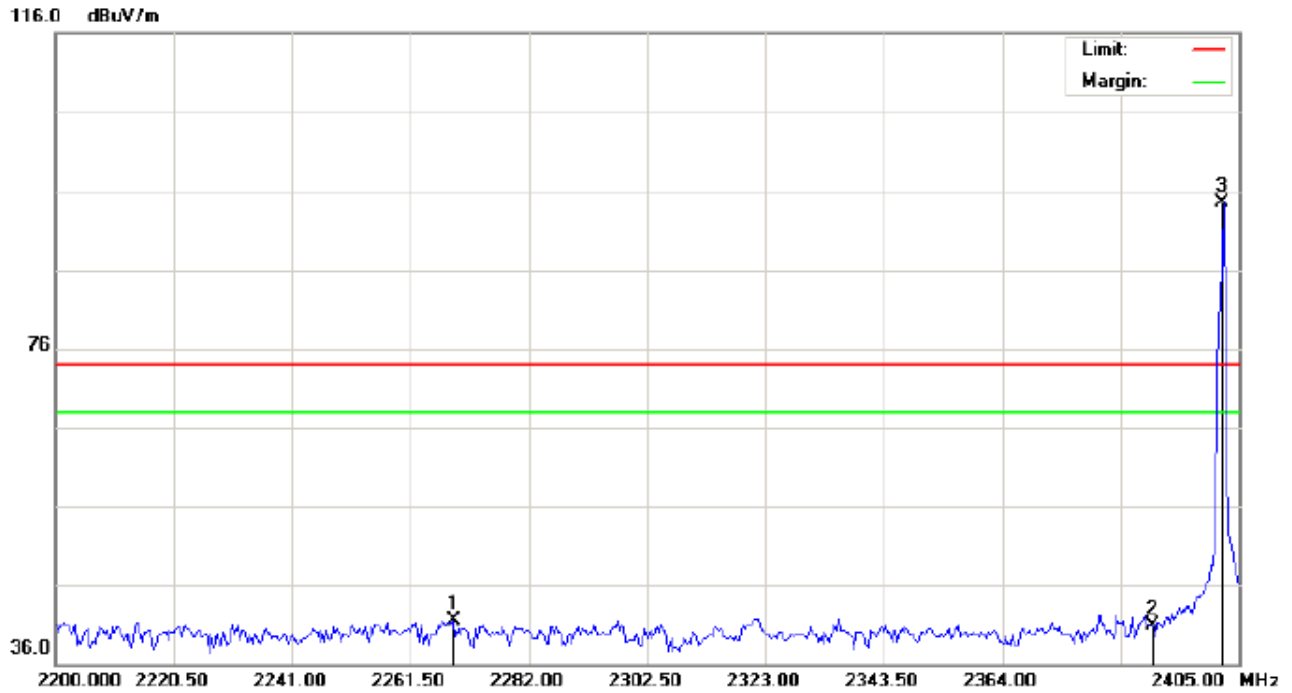

Site: site #1 Polarization: *Horizontal* Temperature: 26
Limit: FCC Class B 3M Radiation above 1GHZ(PK) Power: Humidity: 60 %
EUT: Bluetooth Car Kit Distance:
M/N: Aukey BR-C8
Mode: Low Channel TX
Note:

No.	Mk	Freq.	Reading	Factor	Measurement	Limit	Over	Detector	Antenna Height	Table Degree	Comment
		MHz	dBuV	dB/m	dBuV/m	dBuV/m	dB		cm	degree	
1		2269.017	31.37	10.18	41.55	74.00	-32.45	peak			
2		2390.000	30.50	10.31	40.81	74.00	-33.19	peak			
3	*	2402.000	84.22	10.32	94.54	74.00	20.54	peak			

TEST PLOT OF BAND EDGE FOR LOW CHANNEL -Vertical

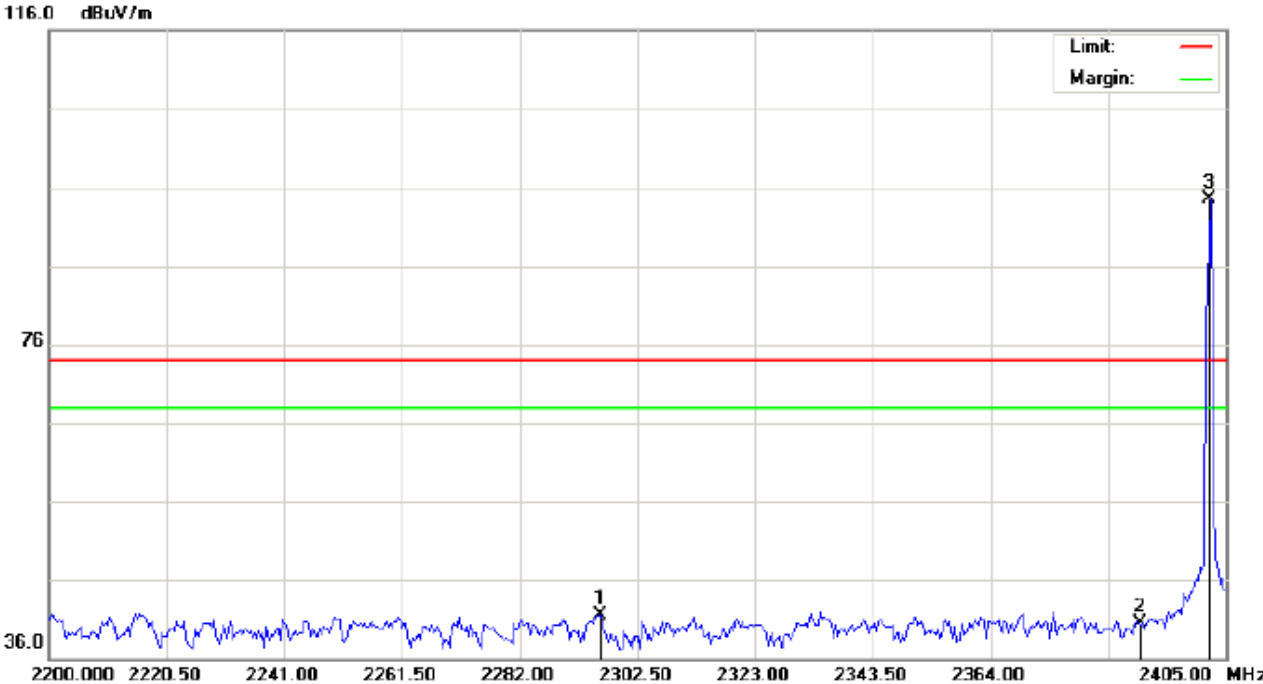

Site: site #1	Polarization: Vertical	Temperature: 26
Limit: FCC Class B 3M Radiation above 1GHZ(PK)	Power:	Humidity: 60 %
EUT: Bluetooth Car Kit	Distance:	
M/N: Aukey BR-C8		
Mode: Low Channel TX		
Note:		

No.	Mk	Freq.	Reading	Factor	Measurement	Limit	Over	Detector	Antenna Height	Table Degree	Comment
		MHz	dBuV	dB/m	dBuV/m	dBuV/m	dB		cm	degree	
1		2296.008	31.33	10.21	41.54	74.00	-32.46	peak			
2		2390.000	30.21	10.31	40.52	74.00	-33.48	peak			
3	*	2402.000	84.09	10.32	94.41	74.00	20.41	peak			

TEST PLOT OF BAND EDGE FOR HIGH CHANNEL -Horizontal

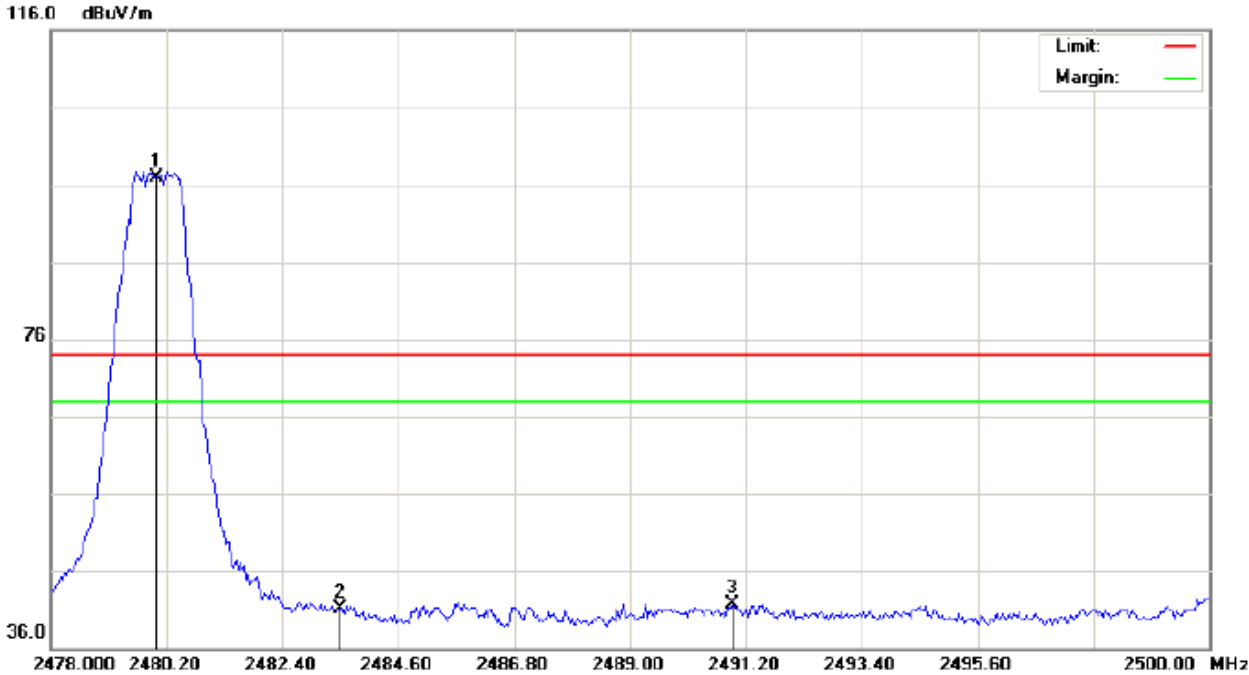

Site: site #1 Polarization: *Horizontal* Temperature: 26
 Limit: FCC Class B 3M Radiation above 1GHZ(PK) Power: Humidity: 60 %
 EUT: Bluetooth Car Kit Distance:
 M/N: Aukey BR-C8
 Mode: High Channel TX
 Note:

No.	Mk	Freq.	Reading	Factor	Measurement	Limit	Over	Detector	Antenna Height	Table Degree	Comment
		MHz	dBuV	dB/m	dBuV/m	dBuV/m	dB		cm	degree	
1	*	2480.000	86.55	10.41	96.96	74.00	22.96	peak			
2		2483.500	30.69	10.41	41.10	74.00	-32.90	peak			
3		2490.943	31.35	10.42	41.77	74.00	-32.23	peak			

TEST PLOT OF BAND EDGE FOR HIGH CHANNEL-Vertical



Site: site #1 Polarization: *Vertical* Temperature: 26
 Limit: FCC Class B 3M Radiation above 1GHZ(PK) Power: Humidity: 60 %
 EUT: Bluetooth Car Kit Distance:
 M/N: Aukey BR-C8
 Mode: High Channel TX
 Note:

No.	Mk	Freq.	Reading	Factor	Measurement	Limit	Over	Detector	Antenna Height	Table Degree	Comment
		MHz	dBuV	dB/m	dBuV/m	dBuV/m	dB		cm	degree	
1	*	2480.000	86.40	10.41	96.81	74.00	22.81	peak			
2		2483.500	29.26	10.41	39.67	74.00	-34.33	peak			
3		2489.477	31.21	10.42	41.63	74.00	-32.37	peak			

RESULT: PASS

Note: The other modes radiation emission have enough 20dB margin.
 Factor=Antenna Factor + Cable loss - Amplifier gain, Over=Measure-Limit.
 The "Factor" value can be calculated automatically by software of measurement system.

FOR BLE

TEST PLOT OF BAND EDGE FOR LOW CHANNEL-Horizontal

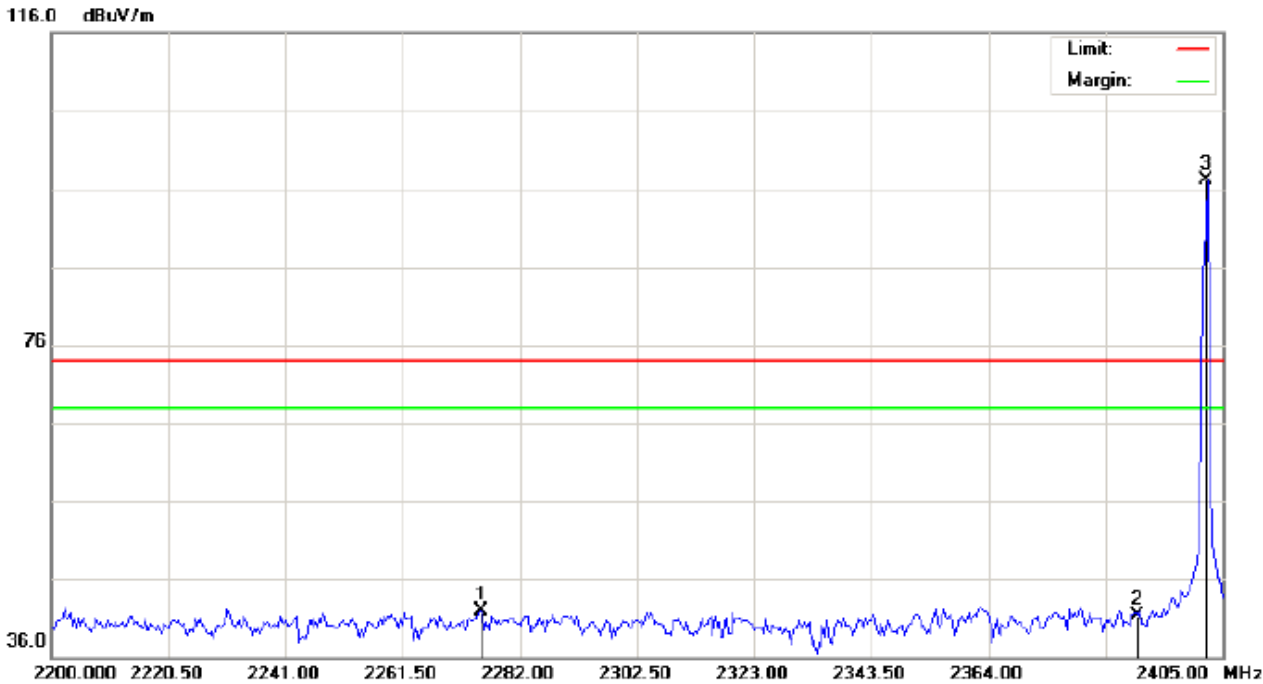

Site: site #1 Polarization: *Horizontal* Temperature: 26
Limit: FCC Class B 3M Radiation above 1GHZ(PK) Power: Humidity: 60 %
EUT: Bluetooth Car Kit Distance:
M/N: Aukey BR-C8
Mode: Low Channel TX
Note:

No.	Mk	Freq.	Reading	Factor	Measurement	Limit	Over	Detector	Antenna Height	Table Degree	Comment
		MHz	dBuV	dB/m	dBuV/m	dBuV/m	dB		cm	degree	
1		2275.167	31.72	10.18	41.90	74.00	-32.10	peak			
2		2390.000	31.00	10.31	41.31	74.00	-32.69	peak			
3	*	2402.000	86.72	10.32	97.04	74.00	23.04	peak			

TEST PLOT OF BAND EDGE FOR LOW CHANNEL -Vertical

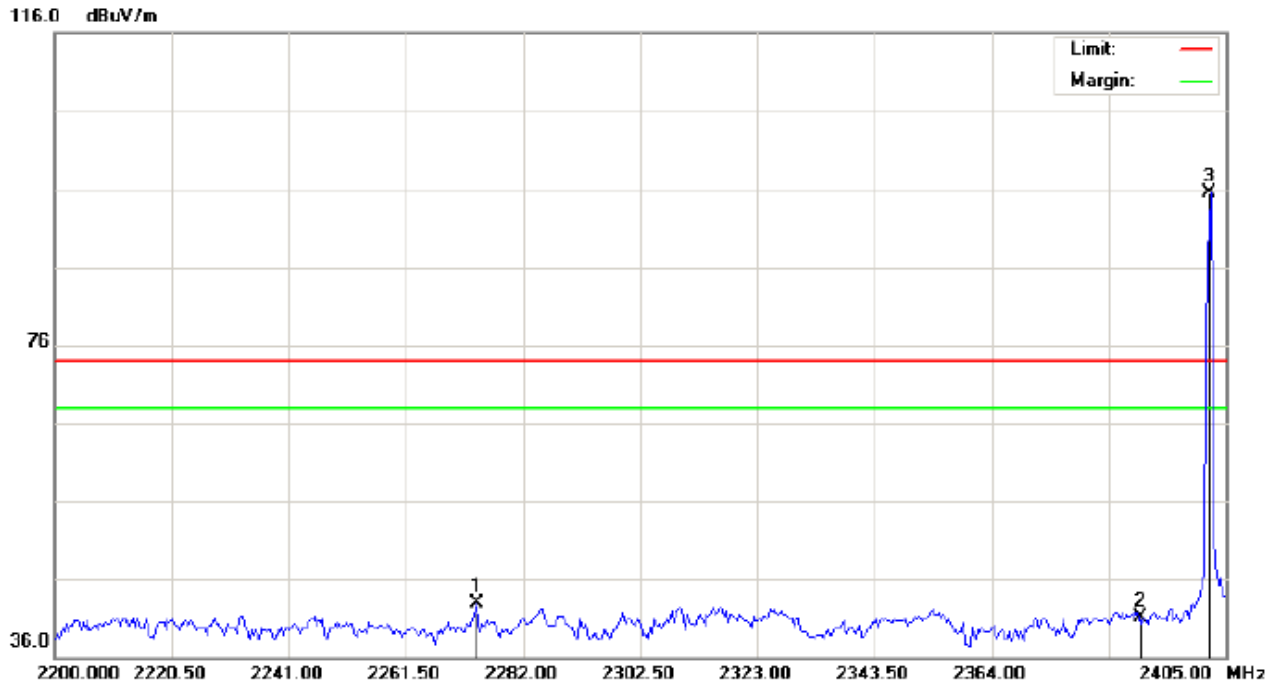

Site: site #1 Polarization: *Vertical* Temperature: 26
Limit: FCC Class B 3M Radiation above 1GHZ(PK) Power: Humidity: 60 %
EUT: Bluetooth Car Kit Distance:
M/N: Aukey BR-C8
Mode: Low Channel TX
Note:

No.	Mk	Freq.	Reading	Factor	Measurement	Limit	Over	Detector	Antenna Height	Table Degree	Comment
		MHz	dBuV	dB/m	dBuV/m	dBuV/m	dB		cm	degree	
1		2273.800	32.72	10.18	42.90	74.00	-31.10	peak			
2		2390.000	30.71	10.31	41.02	74.00	-32.98	peak			
3	*	2402.000	85.09	10.32	95.41	74.00	21.41	peak			

TEST PLOT OF BAND EDGE FOR HIGH CHANNEL -Horizontal

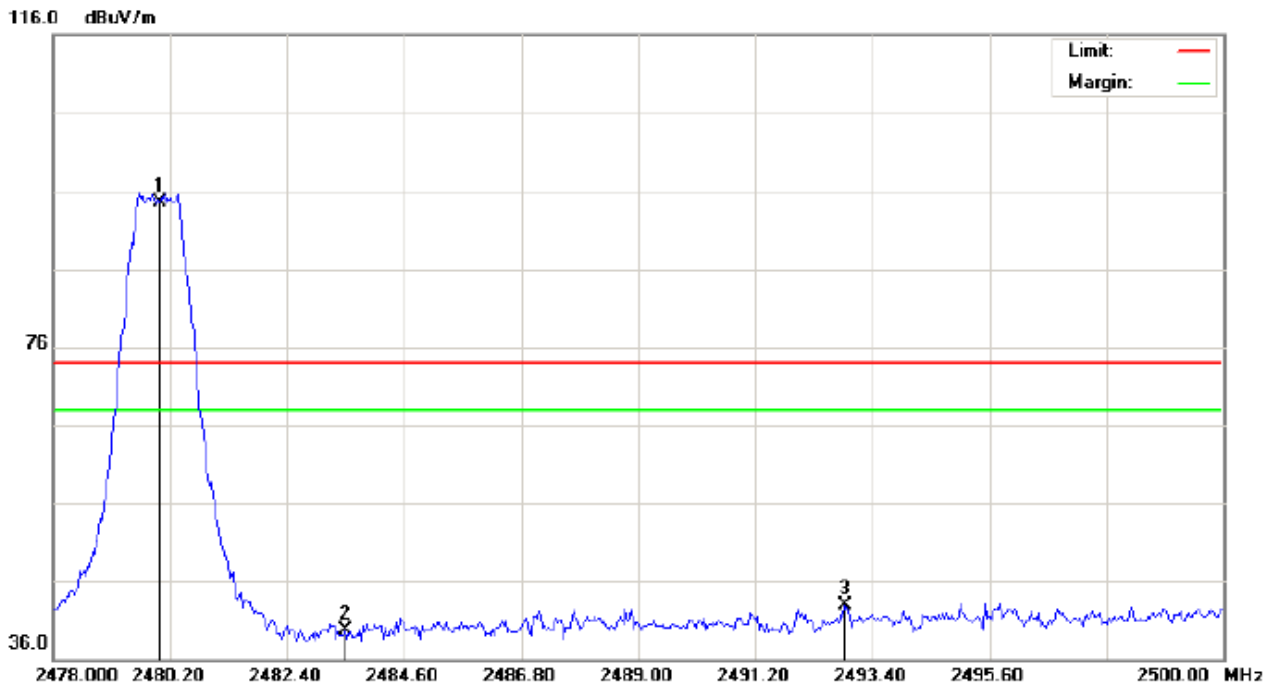

Site: site #1
Limit: FCC Class B 3M Radiation above 1GHZ(PK)
EUT: Bluetooth Car Kit
M/N: Aukey BR-C8
Mode: High Channel TX
Note:

Polarization: **Horizontal**
Power:
Distance:

Temperature: 26
Humidity: 60 %

No.	Mk	Freq.	Reading	Factor	Measurement	Limit	Over	Detector	Antenna Height	Table Degree	Comment
		MHz	dBuV	dB/m	dBuV/m	dBuV/m	dB		cm	degree	
1	*	2480.000	84.05	10.41	94.46	74.00	20.46	peak			
2		2483.500	29.19	10.41	39.60	74.00	-34.40	peak			
3		2492.887	32.43	10.42	42.85	74.00	-31.15	peak			

TEST PLOT OF BAND EDGE FOR HIGH CHANNEL-Vertical

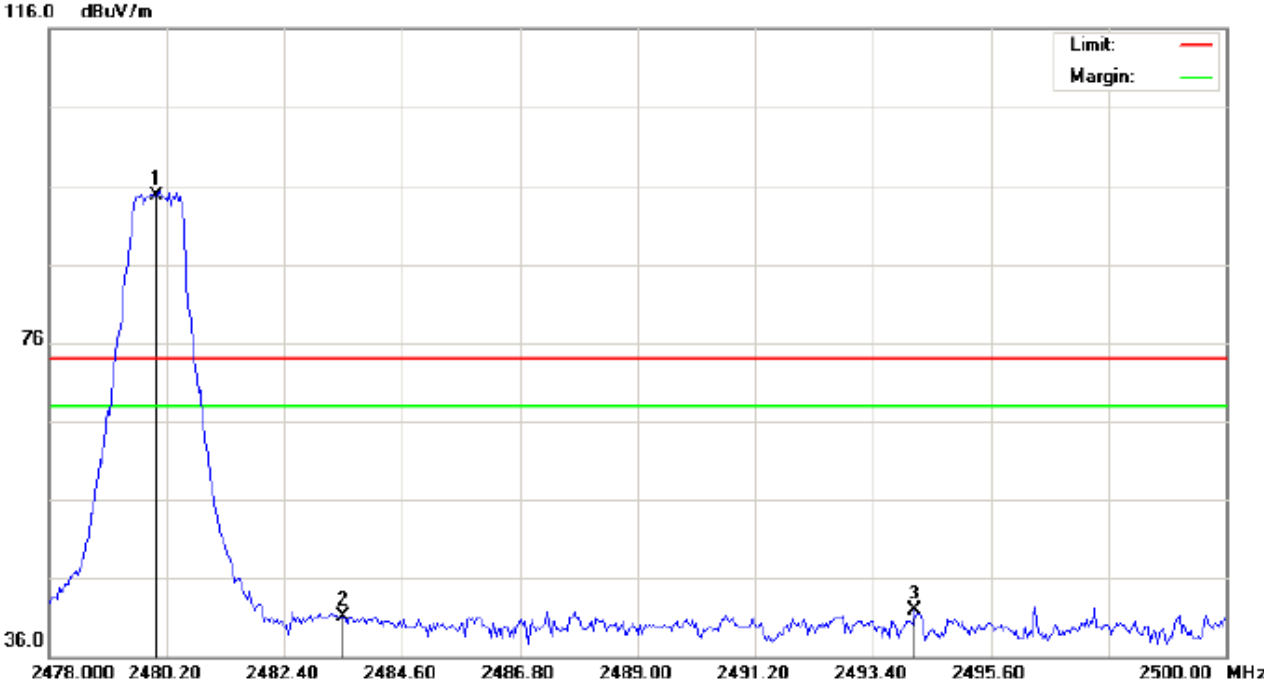

Site: site #1	Polarization: <i>Vertical</i>	Temperature: 26
Limit: FCC Class B 3M Radiation above 1GHZ(PK)	Power:	Humidity: 60 %
EUT: Bluetooth Car Kit	Distance:	
M/N: Aukey BR-C8		
Mode: High Channel TX		
Note:		

No.	Mk	Freq.	Reading	Factor	Measurement	Limit	Over	Detector	Antenna Height	Table Degree	Comment
		MHz	dBuV	dB/m	dBuV/m	dBuV/m	dB				
1	*	2480.000	84.32	10.41	94.73	74.00	20.73	peak			
2		2483.500	30.76	10.41	41.17	74.00	-32.83	peak			
3		2494.170	31.47	10.42	41.89	74.00	-32.11	peak			

RESULT: PASS

Note: The other modes radiation emission have enough 20dB margin.
Factor=Antenna Factor + Cable loss - Amplifier gain, Over=Measure-Limit.
The “Factor” value can be calculated automatically by software of measurement system.

10. 20DB BANDWIDTH

10.1. MEASUREMENT PROCEDURE

1. Connect EUT RF output port to the Spectrum Analyzer through an RF attenuator
2. Set the EUT Work on the top, the middle and the bottom operation frequency individually.
3. Set Span = approximately 2 to 3 times the 20 dB bandwidth, centered on a hopping channel
RBW \geq 1% of the 20 dB bandwidth, VBW \geq RBW; Sweep = auto; Detector function = peak
4. Set SPA Trace 1 Max hold, then View.

10.2. TEST SET-UP

(BLOCK DIAGRAM OF CONFIGURATION)

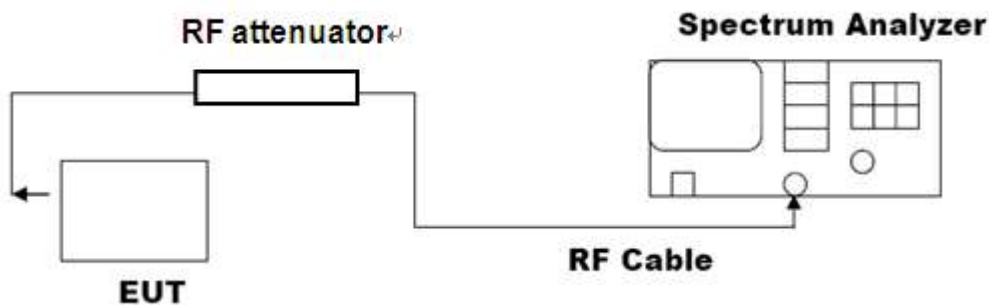

10.3. LIMITS AND MEASUREMENT RESULTS

FOR TRADITIONAL BLUETOOTH

BLUETOOTH 1MBPS LIMITS AND MEASUREMENT RESULT			
Applicable Limits	Measurement Result		
	Test Data (MHz)		Criteria
N/A	Low Channel	0.891	PASS
	Middle Channel	0.876	PASS
	High Channel	0.859	PASS

TEST PLOT OF BANDWIDTH FOR LOW CHANNEL

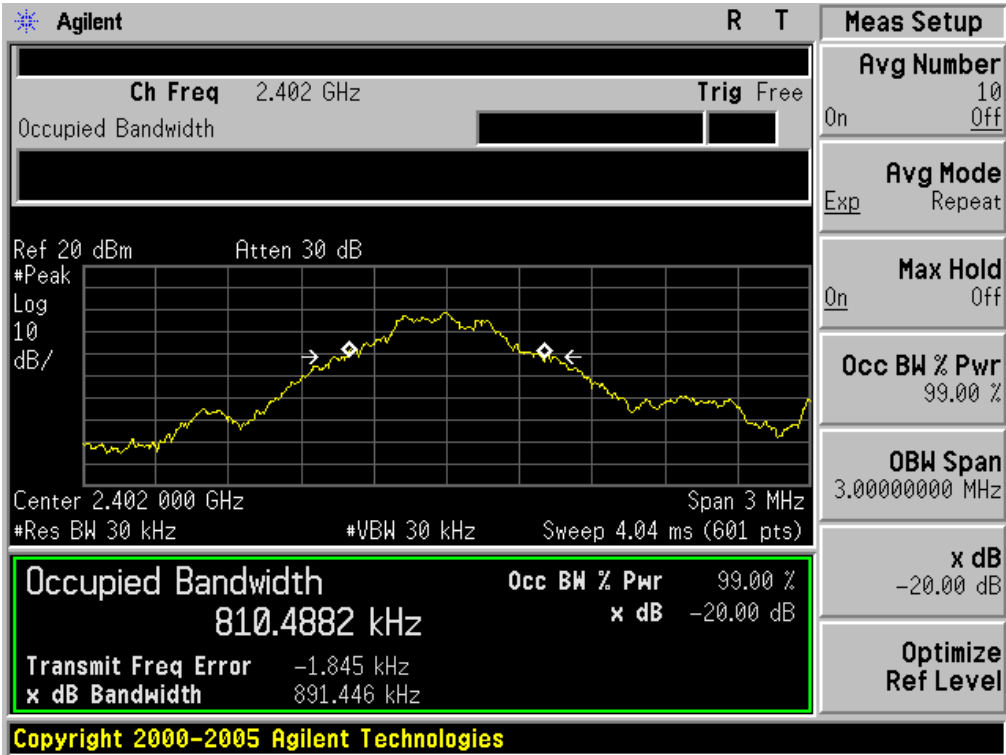

TEST PLOT OF BANDWIDTH FOR MIDDLE CHANNEL



TEST PLOT OF BANDWIDTH FOR HIGH CHANNEL

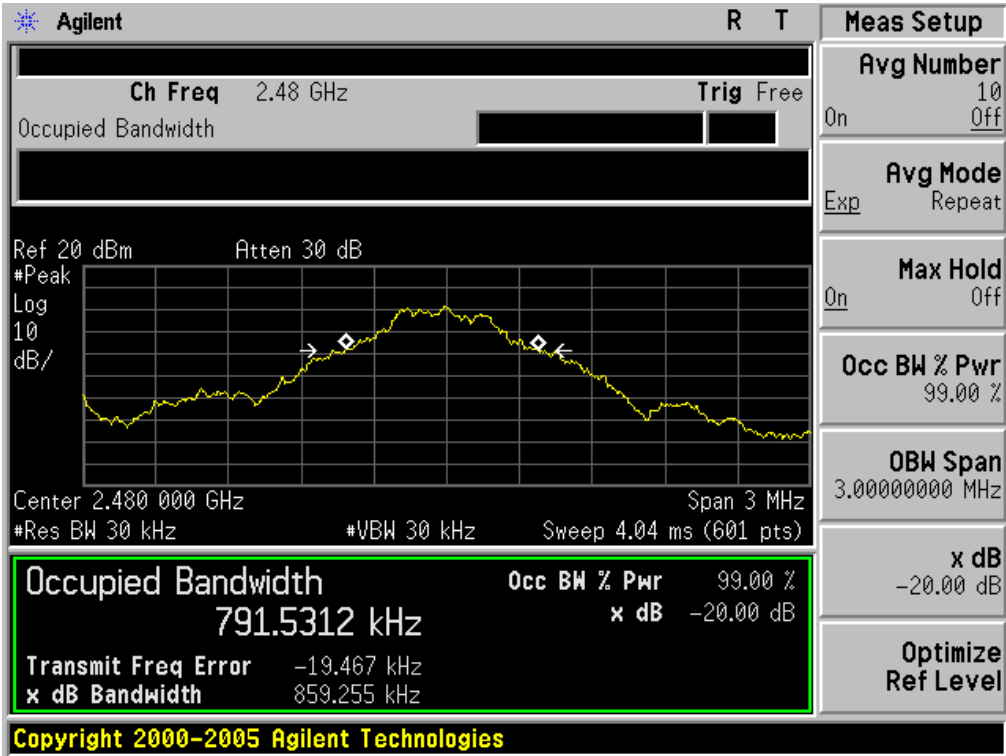

BLUETOOTH 2Mbps LIMITS AND MEASUREMENT RESULT			
Applicable Limits	Measurement Result		
	Test Data (MHz)		Criteria
N/A	Low Channel	1.167	PASS
	Middle Channel	1.106	PASS
	High Channel	1.077	PASS

TEST PLOT OF BANDWIDTH FOR LOW CHANNEL

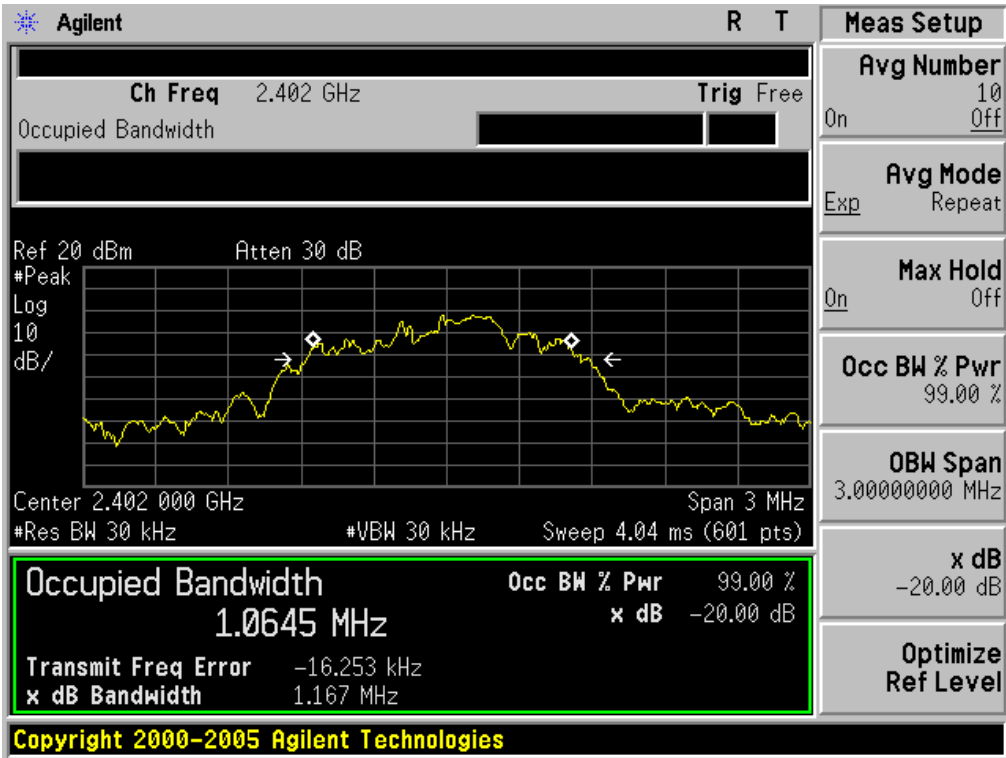

TEST PLOT OF BANDWIDTH FOR MIDDLE CHANNEL

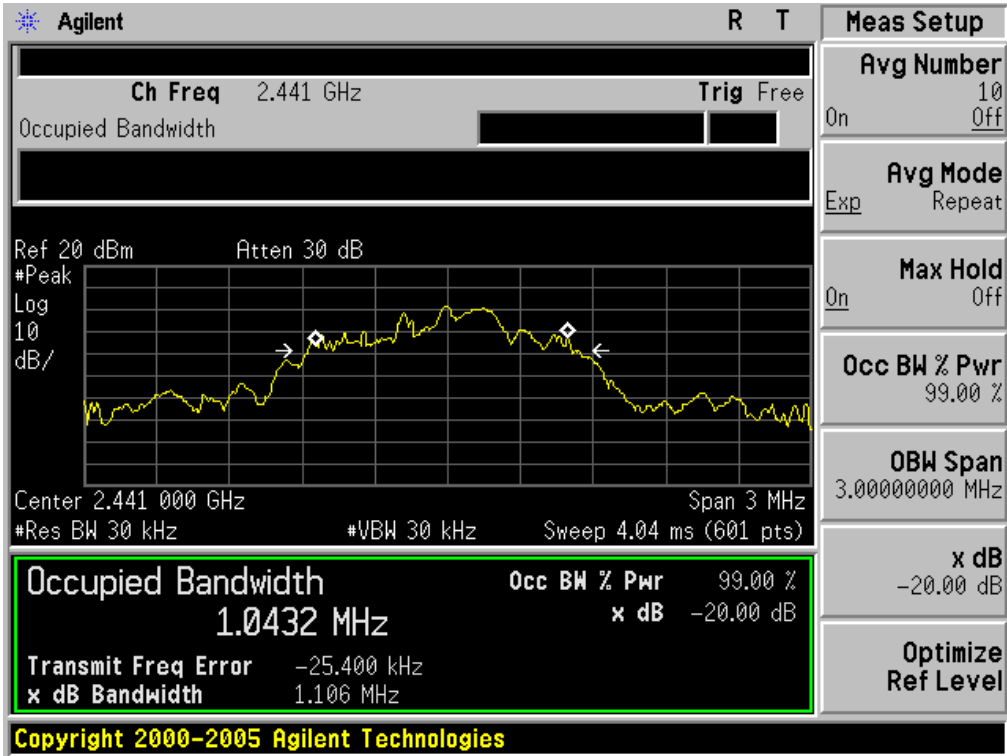

TEST PLOT OF BANDWIDTH FOR HIGH CHANNEL

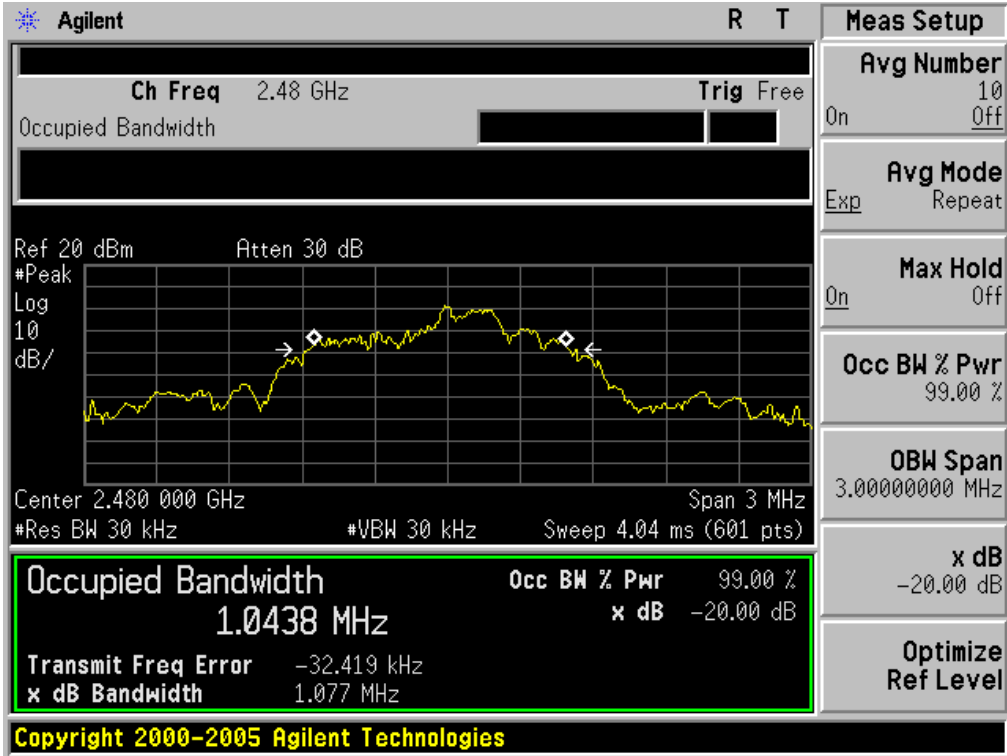

BLUETOOTH 3MBPS LIMITS AND MEASUREMENT RESULT			
Applicable Limits	Measurement Result		
	Test Data (MHz)		Criteria
N/A	Low Channel	1.112	PASS
	Middle Channel	1.102	PASS
	High Channel	1.062	PASS

TEST PLOT OF BANDWIDTH FOR LOW CHANNEL

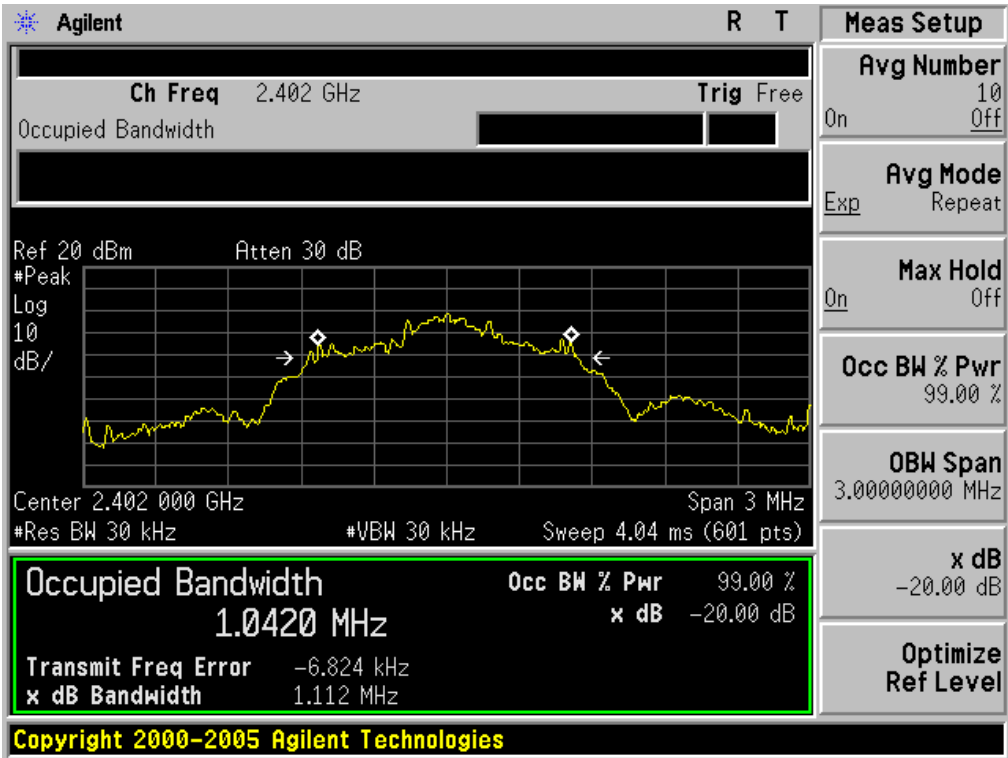

TEST PLOT OF BANDWIDTH FOR MIDDLE CHANNEL

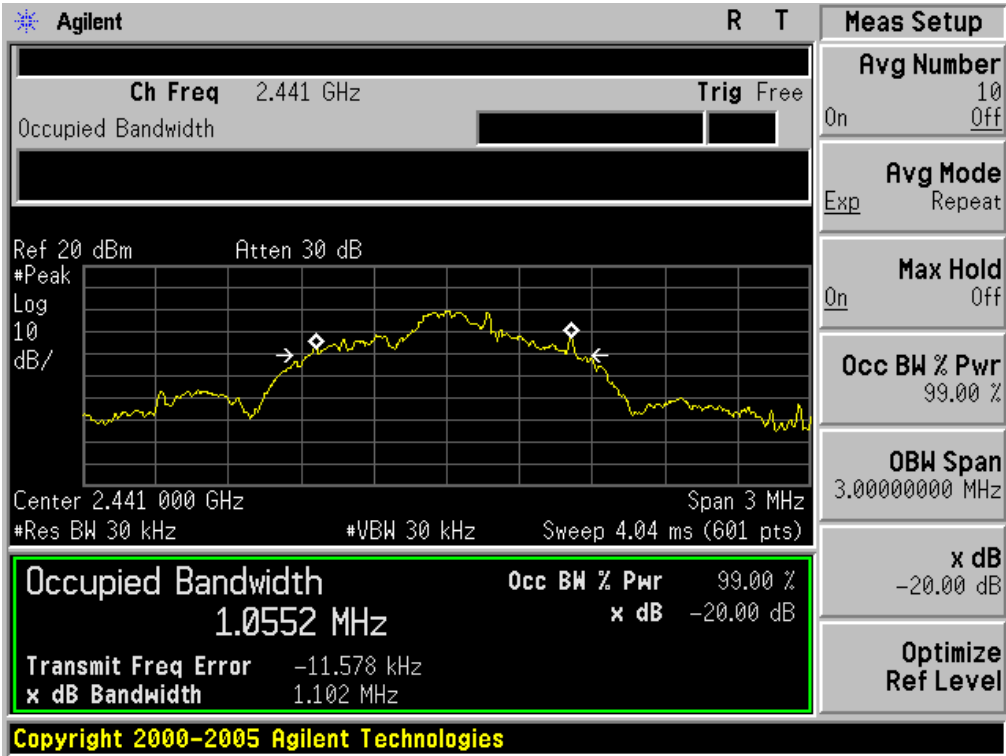

TEST PLOT OF BANDWIDTH FOR HIGH CHANNEL

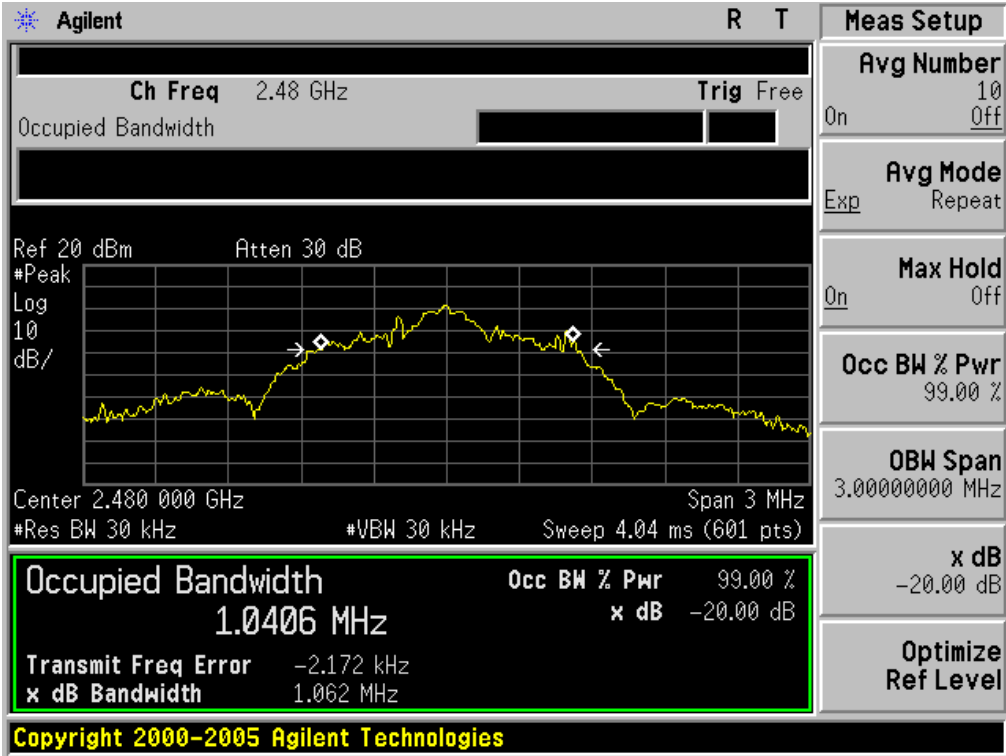

FOR BLE

BLUETOOTH 1MBPS LIMITS AND MEASUREMENT RESULT			
Applicable Limits	Measurement Result		
	Test Data (MHz)		Criteria
N/A	Low Channel	1.210	PASS
	Middle Channel	1.213	PASS
	High Channel	1.216	PASS

TEST PLOT OF BANDWIDTH FOR LOW CHANNEL

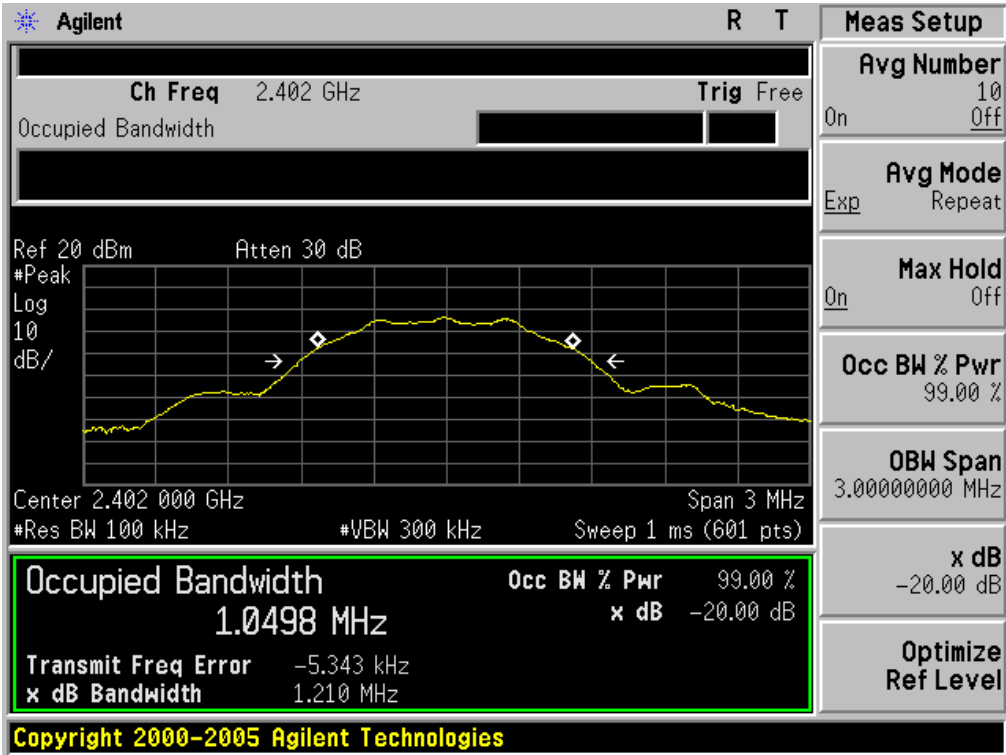

TEST PLOT OF BANDWIDTH FOR MIDDLE CHANNEL

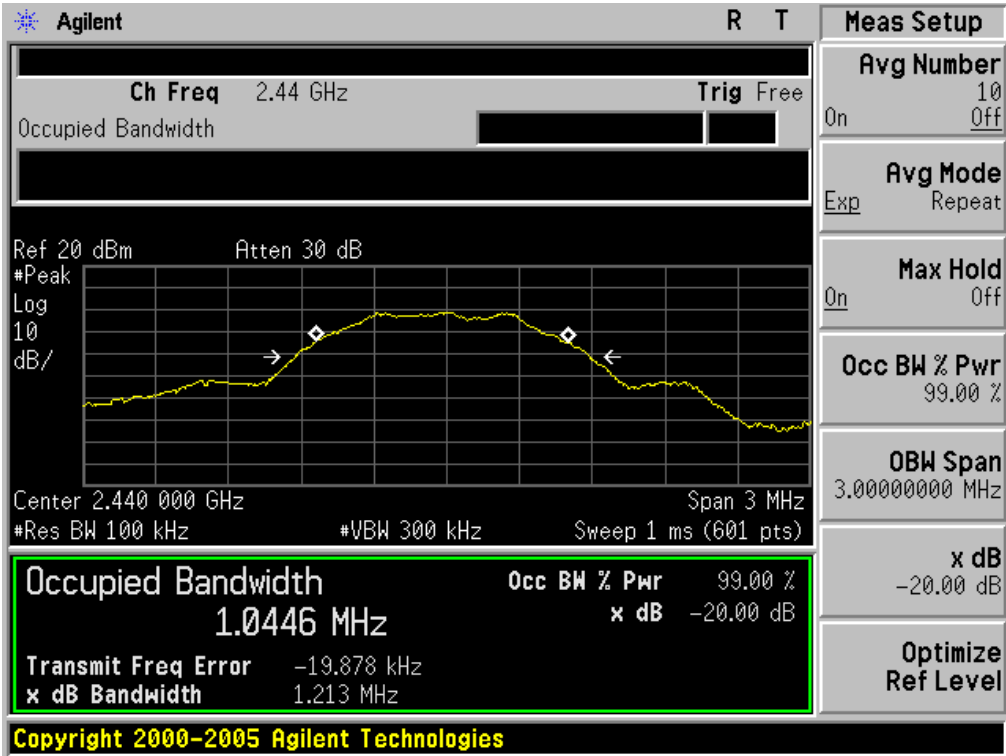

TEST PLOT OF BANDWIDTH FOR HIGH CHANNEL

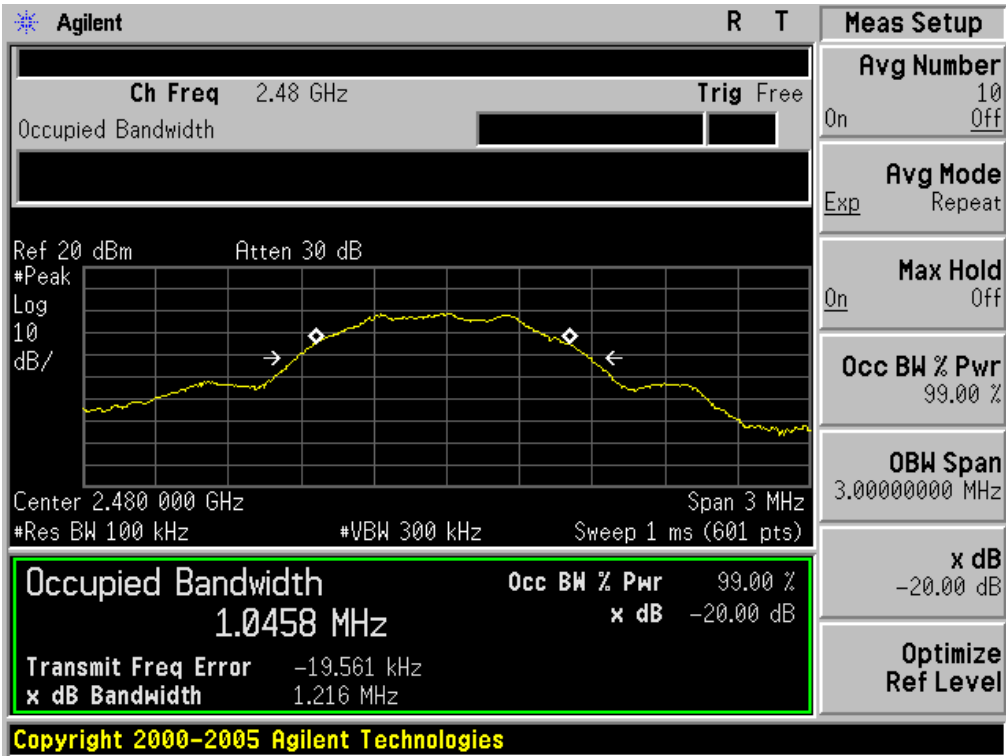

11. FCC LINE CONDUCTED EMISSION TEST

11.1. LIMITS OF LINE CONDUCTED EMISSION TEST

Frequency	Maximum RF Line Voltage	
	Q.P.(dBuV)	Average(dBuV)
150kHz~500kHz	66-56	56-46
500kHz~5MHz	56	46
5MHz~30MHz	60	50

Note:

- 1. The lower limit shall apply at the transition frequency.
- 2. The limit decreases linearly with the logarithm of the frequency in the range 0.15 MHz to 0.50 MHz.

11.2. BLOCK DIAGRAM OF LINE CONDUCTED EMISSION TEST

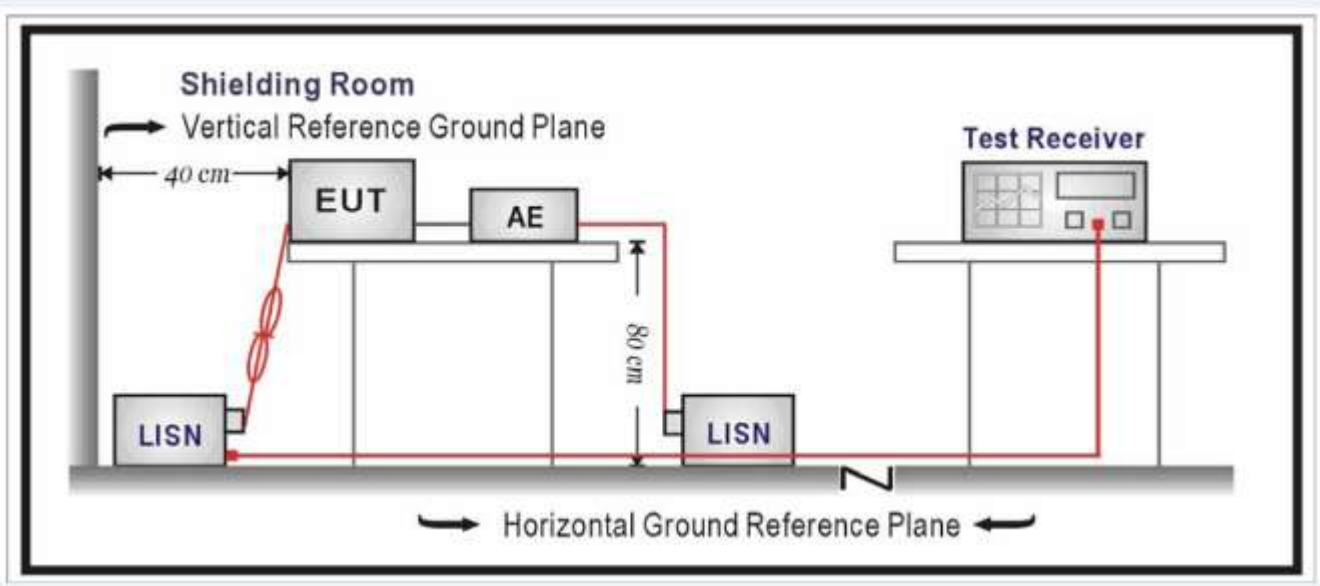

11.3. PRELIMINARY PROCEDURE OF LINE CONDUCTED EMISSION TEST

1. The equipment was set up as per the test configuration to simulate typical actual usage per the user's manual. When the EUT is a tabletop system, a wooden table with a height of 0.8 meters is used and is placed on the ground plane as per ANSI C63.4 (see Test Facility for the dimensions of the ground plane used). When the EUT is a floor-standing equipment, it is placed on the ground plane which has a 3-12 mm non-conductive covering to insulate the EUT from the ground plane.
2. Support equipment, if needed, was placed as per ANSI C63.4.
3. All I/O cables were positioned to simulate typical actual usage as per ANSI C63.4.
4. All support equipments received AC120V/60Hz power from a LISN, if any.
5. The EUT received DC charging voltage by PC which received 120V/60Hz power by a LISN..
6. The test program was started. Emissions were measured on each current carrying line of the EUT using a spectrum Analyzer / Receiver connected to the LISN powering the EUT. The LISN has two monitoring points: Line 1 (Hot Side) and Line 2 (Neutral Side). Two scans were taken: one with Line 1 connected to Analyzer / Receiver and Line 2 connected to a 50 ohm load; the second scan had Line 1 connected to a 50 ohm load and Line 2 connected to the Analyzer / Receiver.
7. Analyzer / Receiver scanned from 150 kHz to 30MHz for emissions in each of the test modes.
8. During the above scans, the emissions were maximized by cable manipulation.
9. The test mode(s) were scanned during the preliminary test.

Then, the EUT configuration and cable configuration of the above highest emission level were recorded for reference of final testing.

11.4. FINAL PROCEDURE OF LINE CONDUCTED EMISSION TEST

- EUT and support equipment was set up on the test bench as per step 2 of the preliminary test.
2. A scan was taken on both power lines, Line 1 and Line 2, recording at least the six highest emissions. Emission frequency and amplitude were recorded into a computer in which correction factors were used to calculate the emission level and compare reading to the applicable limit. If EUT emission level was less -2dB to the A.V. limit in Peak mode, then the emission signal was re-checked using Q.P and Average detector.
3. The test data of the worst case condition(s) was reported on the Summary Data page.

**11.5. TEST RESULT OF LINE CONDUCTED EMISSION TEST
 FOR TRADITIONAL BLUETOOTH**

Line Conducted Emission Test Line 1-L

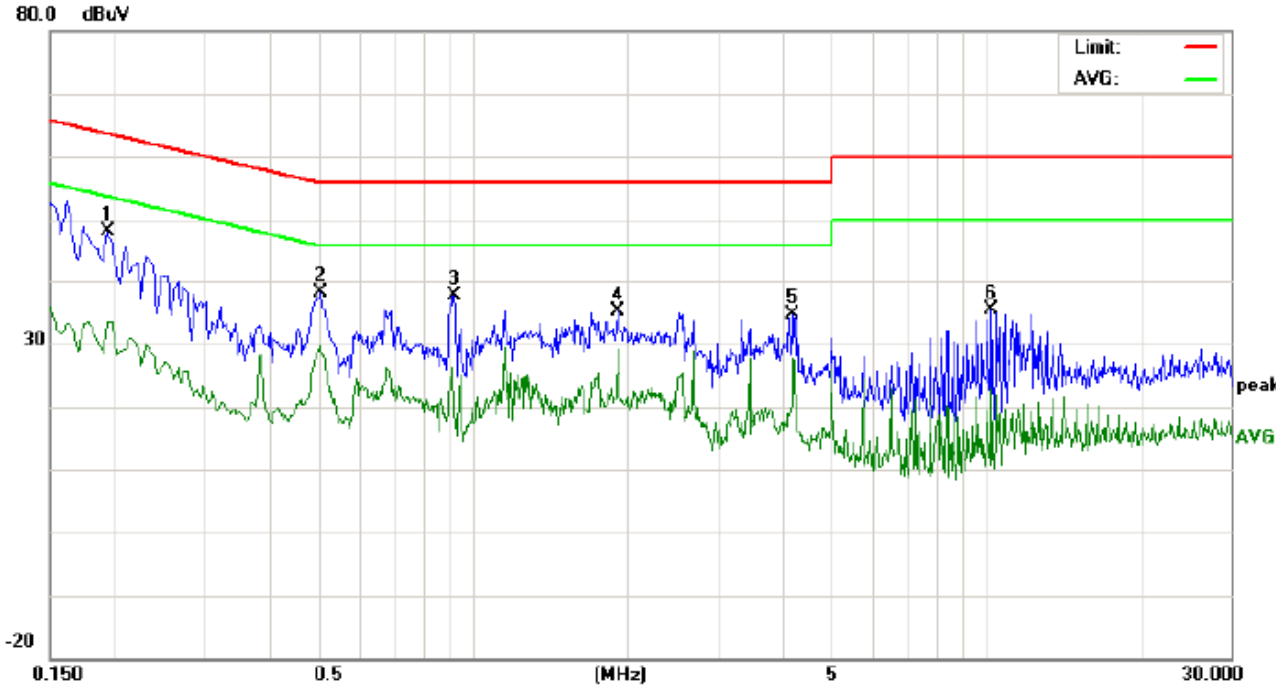

Site: Conduction Phase: **L1** Temperature: 25.3
 Limit: FCC Class B Conduction(QP) Power: Humidity: 51.2 %
 EUT: Bluetooth Car Kit
 M/N: Aukey BR-C8
 Mode: BT Link + Line out
 Note:

No.	Freq. (MHz)	Reading_Level (dBuV)			Correct Factor (dB)	Measurement (dBuV)			Limit (dBuV)		Margin (dB)		P/F	Comment
		Peak	QP	AVG		Peak	QP	AVG	QP	AVG	QP	AVG		
1	0.1940	37.90		23.12	10.21	48.11		33.33	63.86	53.86	-15.75	-20.53	P	
2	0.5060	27.63		18.97	10.39	38.02		29.36	56.00	46.00	-17.98	-16.64	P	
3	0.9220	27.23		8.64	10.40	37.63		19.04	56.00	46.00	-18.37	-26.96	P	
4	1.9220	24.85		18.83	10.24	35.09		29.07	56.00	46.00	-20.91	-16.93	P	
5	4.2219	24.33		17.21	10.33	34.66		27.54	56.00	46.00	-21.34	-18.46	P	
6	10.2539	25.22		12.77	10.09	35.31		22.86	60.00	50.00	-24.69	-27.14	P	

Line Conducted Emission Test Line 2-N

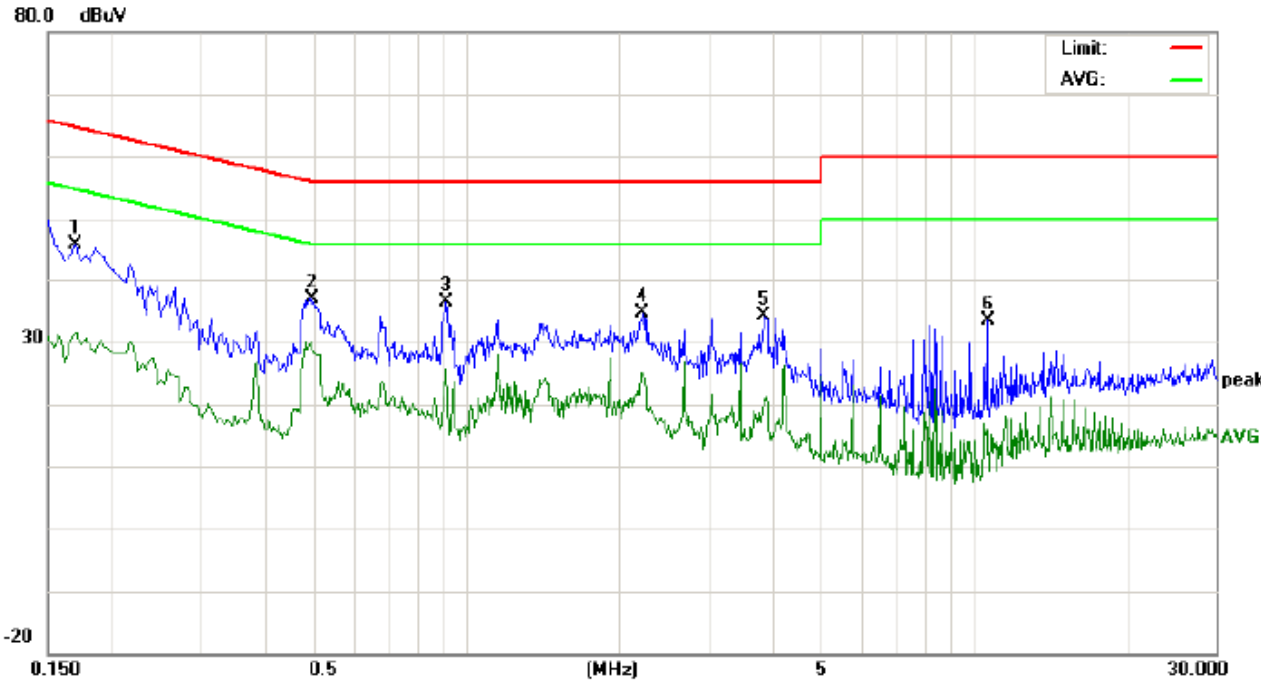

Site: Conduction Phase: **N** Temperature: 25.3
 Limit: FCC Class B Conduction(QP) Power: Humidity: 51.2 %
 EUT: Bluetooth Car Kit
 M/N: Aukey BR-C8
 Mode: BT Link + Line out
 Note:

No.	Freq. (MHz)	Reading_Level (dBuV)			Correct Factor (dB)	Measurement (dBuV)			Limit (dBuV)		Margin (dB)		P/F	Comment
		Peak	QP	AVG		Peak	QP	AVG	QP	AVG	QP	AVG		
1	0.1700	35.75		21.27	10.18	45.93		31.45	64.96	54.96	-19.03	-23.51	P	
2	0.4980	26.49		18.60	10.40	36.89		29.00	56.03	46.03	-19.14	-17.03	P	
3	0.9140	25.86		15.10	10.40	36.26		25.50	56.00	46.00	-19.74	-20.50	P	
4	2.2260	24.30		14.32	10.31	34.61		24.63	56.00	46.00	-21.39	-21.37	P	
5	3.8780	23.62		10.15	10.45	34.07		20.60	56.00	46.00	-21.93	-25.40	P	
6	10.6659	23.35		5.82	10.10	33.45		15.92	60.00	50.00	-26.55	-34.08	P	

FOR BLE

Line Conducted Emission Test Line 1-L

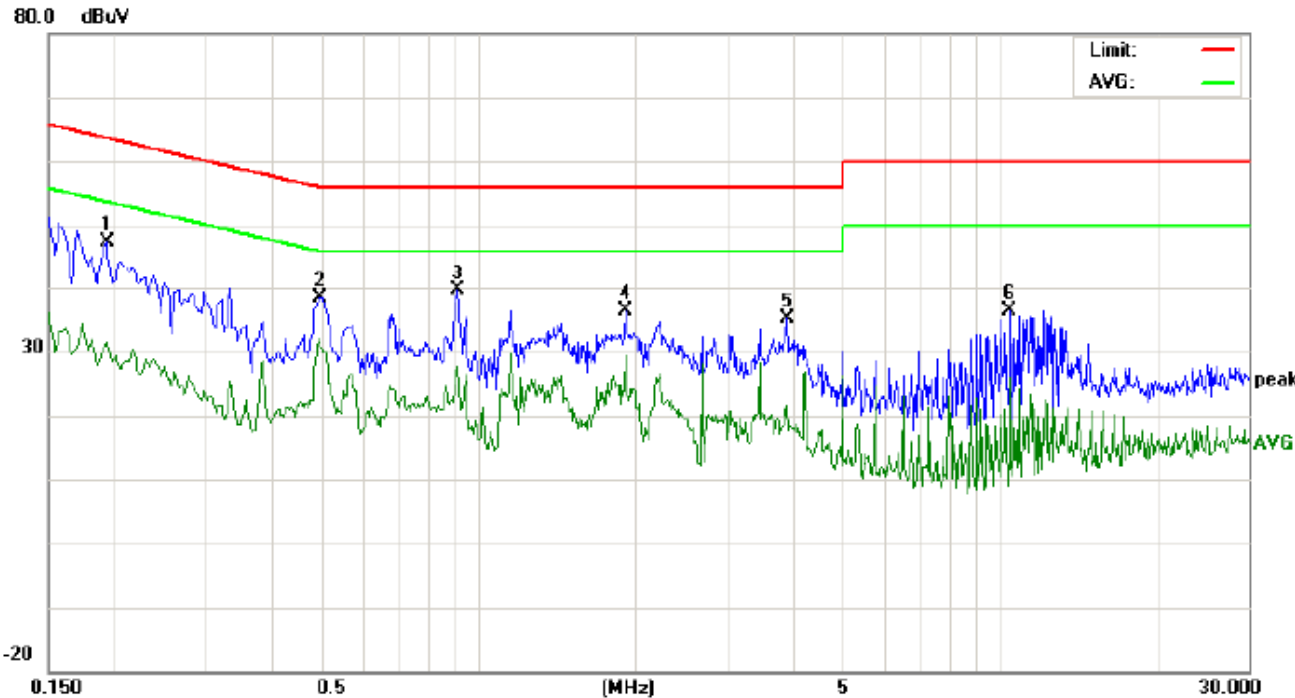

Site: Conduction Phase: **L1** Temperature: 25.3
 Limit: FCC Class B Conduction(QP) Power: Humidity: 51.2 %
 EUT: Bluetooth Car Kit
 M/N: Aukey BR-C8
 Mode: BT Link + Line out
 Note:

No.	Freq. (MHz)	Reading_Level (dBuV)			Correct Factor (dB)	Measurement (dBuV)			Limit (dBuV)		Margin (dB)		P/F	Comment
		Peak	QP	AVG		Peak	QP	AVG	QP	AVG	QP	AVG		
1	0.1940	37.23		21.20	10.21	47.44		31.41	63.86	53.86	-16.42	-22.45	P	
2	0.4980	27.98		20.38	10.40	38.38		30.78	56.03	46.03	-17.65	-15.25	P	
3	0.9180	29.33		16.95	10.40	39.73		27.35	56.00	46.00	-16.27	-18.65	P	
4	1.9180	26.09		19.15	10.25	36.34		29.40	56.00	46.00	-19.66	-16.60	P	
5	3.9060	24.61		11.29	10.44	35.05		21.73	56.00	46.00	-20.95	-24.27	P	
6	10.4779	26.38		15.79	10.09	36.47		25.88	60.00	50.00	-23.53	-24.12	P	

Line Conducted Emission Test Line 2-N

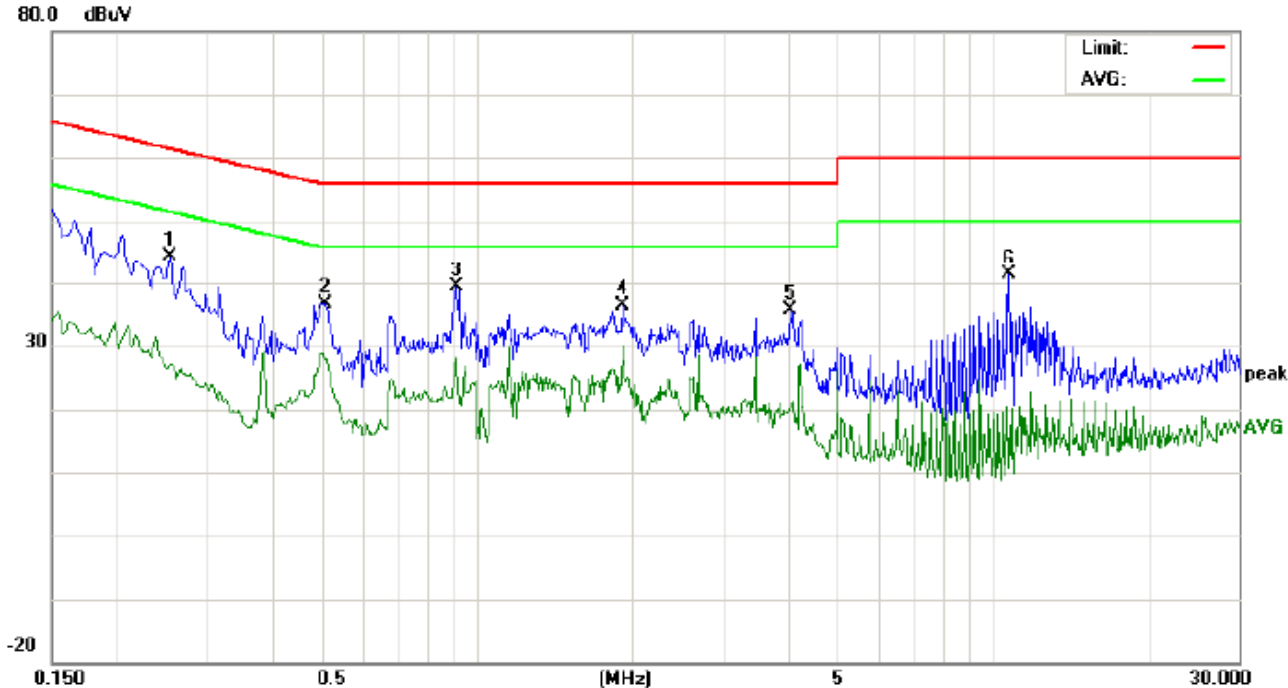

Site: Conduction Phase: **N** Temperature: 25.3
 Limit: FCC Class B Conduction(QP) Power: Humidity: 51.2 %
 EUT: Bluetooth Car Kit
 M/N: Aukey BR-C8
 Mode: BT Link + Line out
 Note:

No.	Freq. (MHz)	Reading_Level (dBuV)			Correct Factor (dB)	Measurement (dBuV)			Limit (dBuV)		Margin (dB)		P/F	Comment
		Peak	QP	AVG		Peak	QP	AVG	QP	AVG	QP	AVG		
1	0.2540	34.12		16.91	10.27	44.39		27.18	61.62	51.62	-17.23	-24.44	P	
2	0.5100	26.32		17.55	10.39	36.71		27.94	56.00	46.00	-19.29	-18.06	P	
3	0.9180	29.00		16.83	10.40	39.40		27.23	56.00	46.00	-16.60	-18.77	P	
4	1.9180	26.11		19.71	10.25	36.36		29.96	56.00	46.00	-19.64	-16.04	P	
5	4.0620	25.32		9.97	10.40	35.72		20.37	56.00	46.00	-20.28	-25.63	P	
6	10.7660	31.39		0.89	10.10	41.49		10.99	60.00	50.00	-18.51	-39.01	P	

APPENDIX A: PHOTOGRAPHS OF TEST SETUP
FCC LINE CONDUCTED EMISSION TEST SETUP



FCC RADIATED EMISSION TEST SETUP





APPENDIX B: PHOTOGRAPHS OF EUT
TOP VIEW OF EUT



BOTTOM VIEW OF EUT



FRONT VIEW OF EUT



BACK VIEW OF EUT



LEFT VIEW OF EUT



RIGHT VIEW OF EUT



OPEN VIEW OF EUT



INTERNAL VIEW OF EUT-1

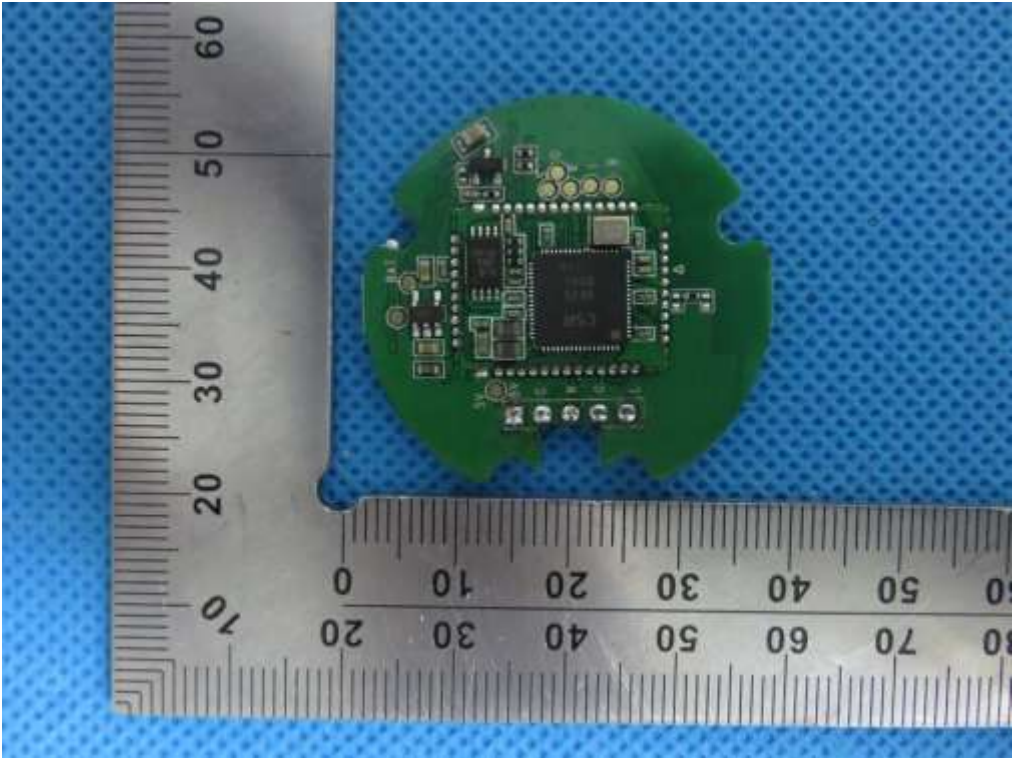

INTERNAL VIEW OF EUT-2

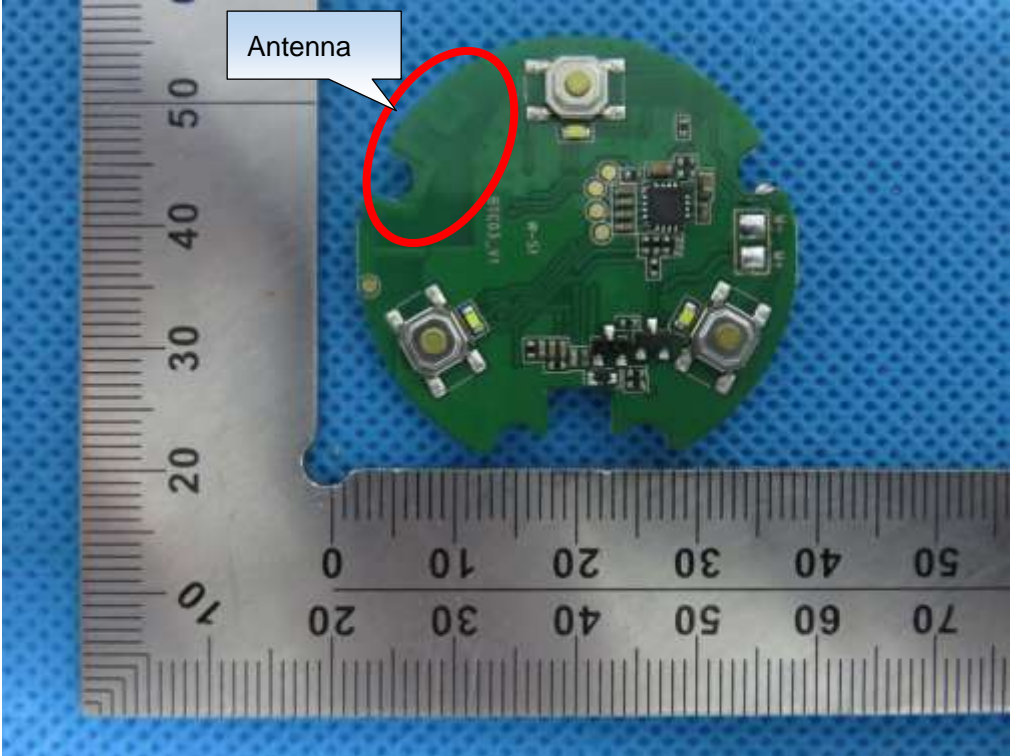

INTERNAL VIEW OF EUT-3

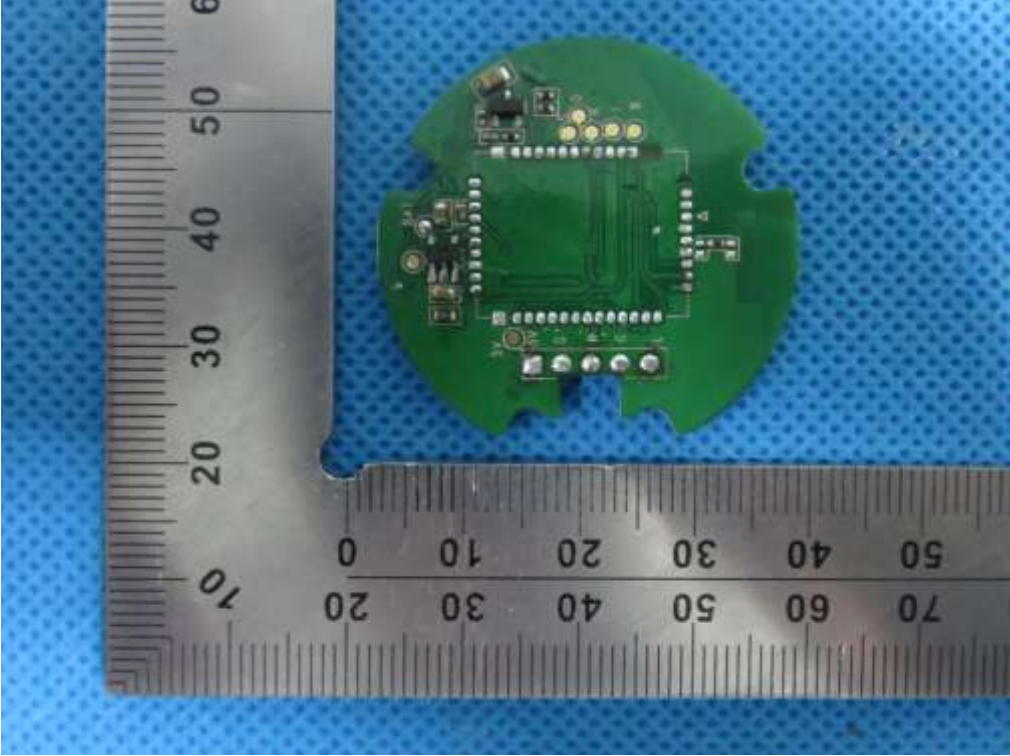

INTERNAL VIEW OF EUT-4

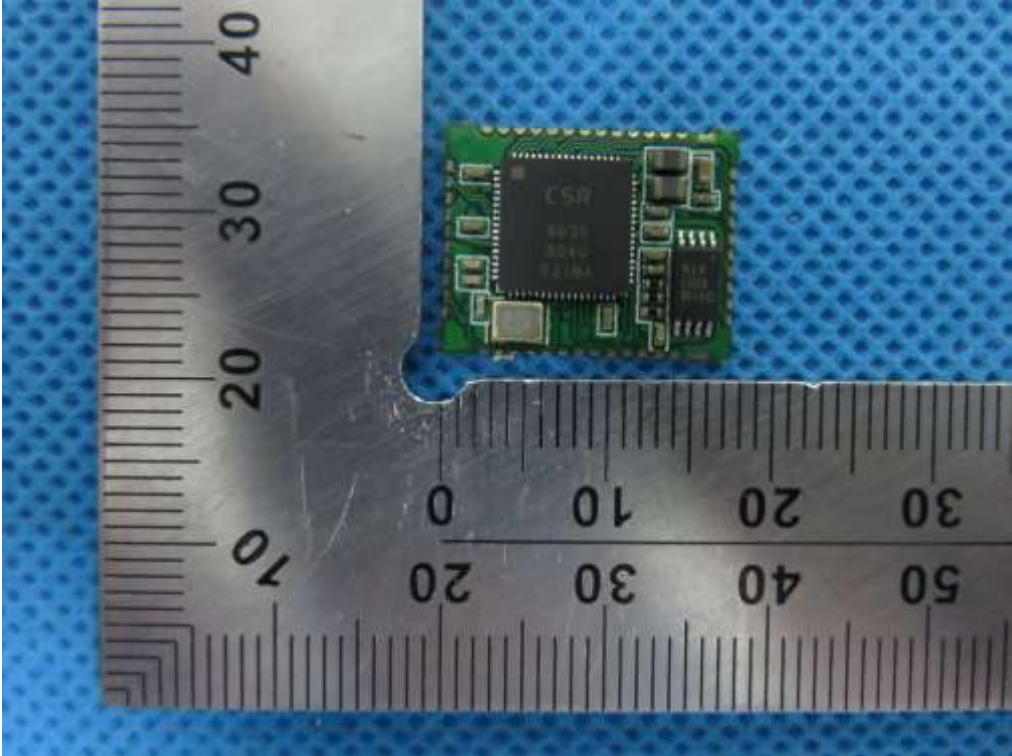

INTERNAL VIEW OF EUT-5

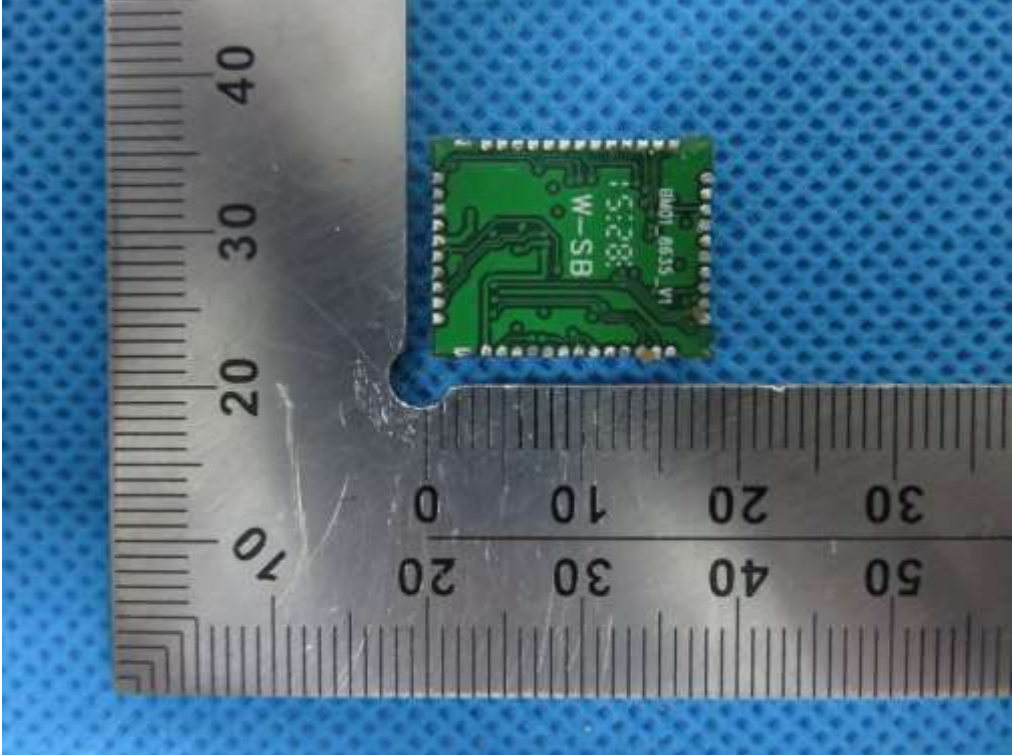

----END OF REPORT----