

FCC Radio Test Report

FCC ID: 2AFHP-EP-B67

Original Grant

Report No. : TB-FCC158288
Applicant : SHENZHEN AUKEY E BUSINESS CO., LTD.
Equipment Under Test (EUT)
EUT Name : Bluetooth Earbuds
Model No. : EP-B67
Series Model No. : EP-B65, EP-B66, EP-B67, EP-B68, EP-B69, EP-B36, EP-B32
Brand Name : AUKEY
Receipt Date : 2018-02-05
Test Date : 2018-02-06 to 2018-02-26
Issue Date : 2018-02-27
Standards : FCC Part 15: 2017, Subpart C(15.247)
Test Method : ANSI C63.10: 2013
Conclusions : **PASS**

In the configuration tested, the EUT complied with the standards specified above,
The EUT technically complies with the FCC requirements

Test/Witness Engineer : Terry.Su

Engineer Supervisor : IVAN SU

Engineer Manager : Long.Li.



This report details the results of the testing carried out on one sample. The results contained in this test report do not relate to other samples of the same product. The manufacturer should ensure that all products in series production are in conformity with the product sample detailed in the report.

Contents

CONTENTS.....	2
1. GENERAL INFORMATION ABOUT EUT	5
1.1 Client Information.....	5
1.2 General Description of EUT (Equipment Under Test)	5
1.3 Block Diagram Showing the Configuration of System Tested.....	6
1.4 Description of Support Units	7
1.5 Description of Test Mode.....	7
1.6 Description of Test Software Setting	8
1.7 Measurement Uncertainty	8
1.8 Test Facility.....	9
2. TEST SUMMARY	10
3. TEST EQUIPMENT.....	11
4. CONDUCTED EMISSION TEST	12
4.1 Test Standard and Limit.....	12
4.2 Test Setup.....	12
4.3 Test Procedure.....	12
4.4 EUT Operating Mode	13
4.5 Test Data.....	13
5. RADIATED EMISSION TEST	14
5.1 Test Standard and Limit.....	14
5.2 Test Setup.....	15
5.3 Test Procedure.....	16
5.4 EUT Operating Condition	16
5.5 Test Data.....	16
6. RESTRICTED BANDS REQUIREMENT	17
6.1 Test Standard and Limit.....	17
6.2 Test Setup.....	17
6.3 Test Procedure.....	17
6.4 EUT Operating Condition	18
6.5 Test Data.....	18
7. NUMBER OF HOPPING CHANNEL	19
7.1 Test Standard and Limit.....	19
7.2 Test Setup.....	19
7.3 Test Procedure.....	19
7.4 EUT Operating Condition	19
7.5 Test Data.....	19
8. AVERAGE TIME OF OCCUPANCY.....	20
8.1 Test Standard and Limit.....	20
8.2 Test Setup.....	20

8.3 Test Procedure.....	20
8.4 EUT Operating Condition	20
8.5 Test Data.....	21
9. CHANNEL SEPARATION AND BANDWIDTH TEST	22
9.1 Test Standard and Limit.....	22
9.2 Test Setup.....	22
9.3 Test Procedure.....	22
9.4 EUT Operating Condition	22
9.5 Test Data.....	23
10. PEAK OUTPUT POWER TEST.....	24
10.1 Test Standard and Limit	24
10.2 Test Setup.....	24
10.3 Test Procedure.....	24
10.4 EUT Operating Condition	24
10.5 Test Data.....	24
11. ANTENNA REQUIREMENT.....	25
11.1 Standard Requirement.....	25
11.2 Antenna Connected Construction	25
11.3 Result.....	25
ATTACHMENT A-- CONDUCTED EMISSION TEST DATA	26
ATTACHMENT B-- RADIATED EMISSION TEST DATA	30
ATTACHMENT C-- RESTRICTED BANDS REQUIREMENT TEST DATA.....	50
ATTACHMENT D-- NUMBER OF HOPPING CHANNEL TEST DATA.....	68
ATTACHMENT E-- AVERAGE TIME OF OCCUPANCY TEST DATA.....	70
ATTACHMENT F-- CHANNEL SEPARATION AND BANDWIDTH TEST DATA.....	76
ATTACHMENT G-- PEAK OUTPUT POWER TEST DATA	88

Revision History

Report No.	Version	Description	Issued Date
TB-FCC158288	Rev.01	Initial issue of report	2018-02-26

1. General Information about EUT

1.1 Client Information

Applicant : SHENZHEN AUKEY E BUSINESS CO., LTD.
Address : Room 102, Bld P09, Huanan International Zone, No.1 Huanan Rd, PinghuTownLonggang District, Shenzhen, China
Manufacturer : Dongguan Tenji Industrial Co.,Ltd
Address : 7 Hai Yi Road, Yongtou Community, Chang an Town, Dongguan City, Guangdong Province, China

1.2 General Description of EUT (Equipment Under Test)

EUT Name	:	Bluetooth Earbuds	
Models No.	:	EP-B67, EP-B65, EP-B66, EP-B67, EP-B68, EP-B69, EP-B36, EP-B32	
Model Difference	:	All these models are identical in the same PCB, layout and electrical circuit, the only difference is model name for commercial.	
Product Description	:	Operation Frequency:	Bluetooth V4.1: 2402~2480 MHz
	:	Number of Channel:	Bluetooth: 79 Channels <small>See Note 2</small>
	:	Max Peak Output Power:	Bluetooth: 5.417dBm(GFSK)
	:	Antenna Gain:	2dBi Ceramic Antenna
	:	Modulation Type:	GFSK (1 Mbps) π/4-DQPSK (2 Mbps) 8-DPSK (3 Mbps)
Power Supply	:	DC Voltage Supply from USB Port. DC Supply by the Li-ion Battery.	
Power Rating	:	DC 5.0 V from the USB Cable. DC 3.7V by 60mAh*2 Li-ion Battery.	
Software Version	:	V07	
Hardware Version	:	V01	
Connecting I/O Port(S)	:	Please refer to the User's Manual	

Note:

- (1) For a more detailed features description, please refer to the manufacturer's specifications or the User's Manual.
- (2) Channel List:

Bluetooth Channel List					
Channel	Frequency (MHz)	Channel	Frequency (MHz)	Channel	Frequency (MHz)
00	2402	27	2429	54	2456

01	2403	28	2430	55	2457
02	2404	29	2431	56	2458
03	2405	30	2432	57	2459
04	2406	31	2433	58	2460
05	2407	32	2434	59	2461
06	2408	33	2435	60	2462
07	2409	34	2436	61	2463
08	2410	35	2437	62	2464
09	2411	36	2438	63	2465
10	2412	37	2439	64	2466
11	2413	38	2440	65	2467
12	2414	39	2441	66	2468
13	2415	40	2442	67	2469
14	2416	41	2443	68	2470
15	2417	42	2444	69	2471
16	2418	43	2445	70	2472
17	2419	44	2446	71	2473
18	2420	45	2447	72	2474
19	2421	46	2448	73	2475
20	2422	47	2449	74	2476
21	2423	48	2450	75	2477
22	2424	49	2451	76	2478
23	2425	50	2452	77	2479
24	2426	51	2453	78	2480
25	2427	52	2454		
26	2428	53	2455		

(3) The Antenna information about the equipment is provided by the applicant.

1.3 Block Diagram Showing the Configuration of System Tested

Charging + TX Mode



TX Mode

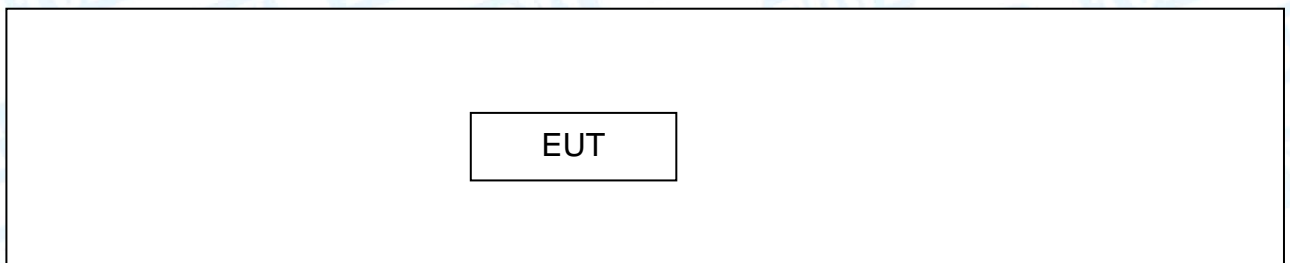

1.4 Description of Support Units

Equipment Information				
Name	Model	FCC ID/VOC	Manufacturer	Used “√”
Adapter	BSY02D050200V	----	BSY	√
Cable Information				
Number	Shielded Type	Ferrite Core	Length	Note
Cable 1	NO	NO	0.6M	

1.5 Description of Test Mode

To investigate the maximum EMI emission characteristics generates from EUT, the test system was pre-scanning tested base on the consideration of following EUT operation mode or test configuration mode which possible have effect on EMI emission level. Each of these EUT operation mode(s) or test configuration mode(s) mentioned follow was evaluated respectively.

For Conducted Test	
Final Test Mode	Description
Mode 1	Charging + TX Mode

For Radiated Test	
Final Test Mode	Description
Mode 1	TX GFSK Mode
Mode 2	TX Mode(GFSK) Channel 00/39/78
Mode 3	TX Mode($\pi/4$ -DQPSK) Channel 00/39/78
Mode 4	TX Mode(8-DPSK) Channel 00/39/78
Mode 5	Hopping Mode(GFSK)
Mode 6	Hopping Mode($\pi/4$ -DQPSK)
Mode 7	Hopping Mode(8-DPSK)

Note:

- (1) For all test, we have verified the construction and function in typical operation. And all the test modes were carried out with the EUT in transmitting operation in maximum power with all kinds of data rate. We have pretested all the test modes above.

According to ANSI C63.10 standards, the measurements are performed at the highest, middle, lowest available channels, and the worst case data rate as follows:

- TX Mode: GFSK (1 Mbps)
- TX Mode: $\pi/4$ -DQPSK (2 Mbps)
- TX Mode: 8-DPSK (3Mbps)

(2) The EUT is considered a portable unit; it was pre-tested on the positioned of each 3 axis, X-plane, Y-plane and Z-plane. The worst case was found positioned on X-plane as the normal use. Therefore only the test data of this X-plane was used for radiated emission measurement test.

1.6 Description of Test Software Setting

During testing channel power controlling software provided by the customer was used to control the operating channel as well as the output power level. The RF output power selection is for the setting of RF output power expected by the customer and is going to be fixed on the firmware of the final end product power parameters of Bluetooth mode.

Test Software Version	BlueTest3.exe		
	2402 MHz	2441MHz	2480 MHz
Frequency	2402 MHz	2441MHz	2480 MHz
GFSK	DEF	DEF	DEF
π /4-DQPSK	DEF	DEF	DEF
8-DPSK	DEF	DEF	DEF

1.7 Measurement Uncertainty

The reported uncertainty of measurement $y \pm U$, where expended uncertainty U is based on a standard uncertainty multiplied by a coverage factor of $k=2$, providing a level of confidence of approximately 95 %.

Test Item	Parameters	Expanded Uncertainty (U_{Lab})
Conducted Emission	Level Accuracy: 9kHz~150kHz 150kHz to 30MHz	± 3.42 dB ± 3.42 dB
Radiated Emission	Level Accuracy: 9kHz to 30 MHz	± 4.60 dB
Radiated Emission	Level Accuracy: 30MHz to 1000 MHz	± 4.40 dB
Radiated Emission	Level Accuracy: Above 1000MHz	± 4.20 dB

1.8 Test Facility

The testing report were performed by the Shenzhen Toby Technology Co., Ltd., in their facilities located at 1A/F., Bldg.6, Yusheng Industrial Zone, The National Road No.107 Xixiang Section 467, Xixiang, Bao'an, Shenzhen, Guangdong, China. At the time of testing, the following bodies accredited the Laboratory:

CNAS (L5813)

The Laboratory has been accredited by CNAS to ISO/IEC 17025: 2005 General Requirements for the Competence of Testing and Calibration Laboratories for the competence in the field of testing. And the Registration No.: CNAS L5813.

A2LA Certificate No.: 4750.01

The laboratory has been accredited by American Association for Laboratory Accreditation(A2LA) to ISO/IEC 17025: 2005 General Requirements for the Competence of Testing and Calibration Laboratories for the technical competence in the field of Electrical Testing. And the A2LA Certificate No.: 4750.01.

IC Registration No.: (11950A-1)

The Laboratory has been registered by Certification and Engineering Bureau of Industry Canada for radio equipment testing. The site registration: Site# 11950A-1.

2. Test Summary

FCC Part 15 Subpart C(15.247)/ RSS 247 Issue 1				
Standard Section		Test Item	Judgment	Remark
FCC	IC			
15.203		Antenna Requirement	PASS	N/A
15.207	RSS-GEN 7.2.2	Conducted Emission	PASS	N/A
15.205	RSS-Gen 7.2.3	Restricted Bands	PASS	N/A
15.247(a)(1)	RSS 247 5.1 (2)	Hopping Channel Separation	PASS	N/A
15.247(a)(1)	RSS 247 5.1 (4)	Dwell Time	PASS	N/A
15.247(b)(1)	RSS 247 5.4 (2)	Peak Output Power	PASS	N/A
15.247(b)(1)	RSS 247 5.1 (4)	Number of Hopping Frequency	PASS	N/A
15.247(d)	RSS 247 5.5	Band Edge	PASS	N/A
15.247(c)& 15.209	RSS 247 5.5	Radiated Spurious Emission	PASS	N/A
15.247(a)	RSS 247 5.1 (1)	99% Occupied Bandwidth & 20dB Bandwidth	PASS	99%OBW: GFSK: 801.8924kHz π /4-DQPSK: 1183.0kHz 8-DPSK: 1173.6KHz

Note: N/A is an abbreviation for Not Applicable.

3. Test Equipment

Conducted Emission Test					
Equipment	Manufacturer	Model No.	Serial No.	Last Cal.	Cal. Due Date
EMI Test Receiver	Rohde & Schwarz	ESCI	100321	Jul. 20, 2017	Jul. 19, 2018
RF Switching Unit	Compliance Direction Systems Inc	RSU-A4	34403	Jul. 20, 2017	Jul. 19, 2018
AMN	SCHWARZBECK	NNBL 8226-2	8226-2/164	Jul. 20, 2017	Jul. 19, 2018
LISN	Rohde & Schwarz	ENV216	101131	Jul. 20, 2017	Jul. 19, 2018
Radiation Emission Test					
Equipment	Manufacturer	Model No.	Serial No.	Last Cal.	Cal. Due Date
Spectrum Analyzer	Agilent	E4407B	MY45106456	Jul. 20, 2017	Jul. 19, 2018
EMI Test Receiver	Rohde & Schwarz	ESPI	100010/007	Jul. 20, 2017	Jul. 19, 2018
Bilog Antenna	ETS-LINDGREN	3142E	00117537	Mar.25, 2017	Mar. 24, 2018
Bilog Antenna	ETS-LINDGREN	3142E	00117542	Mar.25, 2017	Mar. 24, 2018
Horn Antenna	ETS-LINDGREN	3117	00143207	Mar.24, 2017	Mar. 23, 2018
Horn Antenna	ETS-LINDGREN	3117	00143209	Mar.24, 2017	Mar. 23, 2018
Loop Antenna	Laplace instrument	RF300	0701	Mar.24, 2017	Mar. 23, 2018
Pre-amplifier	Sonoma	310N	185903	Mar.24, 2017	Mar. 23, 2018
Pre-amplifier	HP	8449B	3008A00849	Mar.25, 2017	Mar. 24, 2018
Cable	HUBER+SUHNER	100	SUCOFLEX	Mar.24, 2017	Mar. 23, 2018
Positioning Controller	ETS-LINDGREN	2090	N/A	N/A	N/A
Antenna Conducted Emission					
Equipment	Manufacturer	Model No.	Serial No.	Last Cal.	Cal. Due Date
Spectrum Analyzer	Agilent	E4407B	MY45106456	Jul. 20, 2017	Jul. 19, 2018
Spectrum Analyzer	Rohde & Schwarz	ESCI	100010/007	Jul. 20, 2017	Jul. 19, 2018
MXA Signal Analyzer	Agilent	N9020A	MY49100060	Oct. 26, 2017	Oct. 25, 2018
Vector Signal Generator	Agilent	N5182A	MY50141294	Oct. 26, 2017	Oct. 25, 2018
Analog Signal Generator	Agilent	N5181A	MY50141953	Oct. 26, 2017	Oct. 25, 2018
RF Power Sensor	DARE!! Instruments	RadiPowerRPR3006W	17I00015SNO26	Oct. 26, 2017	Oct. 25, 2018
	DARE!! Instruments	RadiPowerRPR3006W	17I00015SNO29	Oct. 26, 2017	Oct. 25, 2018
	DARE!! Instruments	RadiPowerRPR3006W	17I00015SNO31	Oct. 26, 2017	Oct. 25, 2018
	DARE!! Instruments	RadiPowerRPR3006W	17I00015SNO33	Oct. 26, 2017	Oct. 25, 2018

4. Conducted Emission Test

4.1 Test Standard and Limit

4.1.1 Test Standard
FCC Part 15.207

4.1.2 Test Limit

Conducted Emission Test Limit

Frequency	Maximum RF Line Voltage (dB μ V)	
	Quasi-peak Level	Average Level
150kHz~500kHz	66 ~ 56 *	56 ~ 46 *
500kHz~5MHz	56	46
5MHz~30MHz	60	50

Notes:

- (1) *Decreasing linearly with logarithm of the frequency.
- (2) The lower limit shall apply at the transition frequencies.
- (3) The limit decrease in line with the logarithm of the frequency in the range of 0.15 to 0.50MHz.

4.2 Test Setup

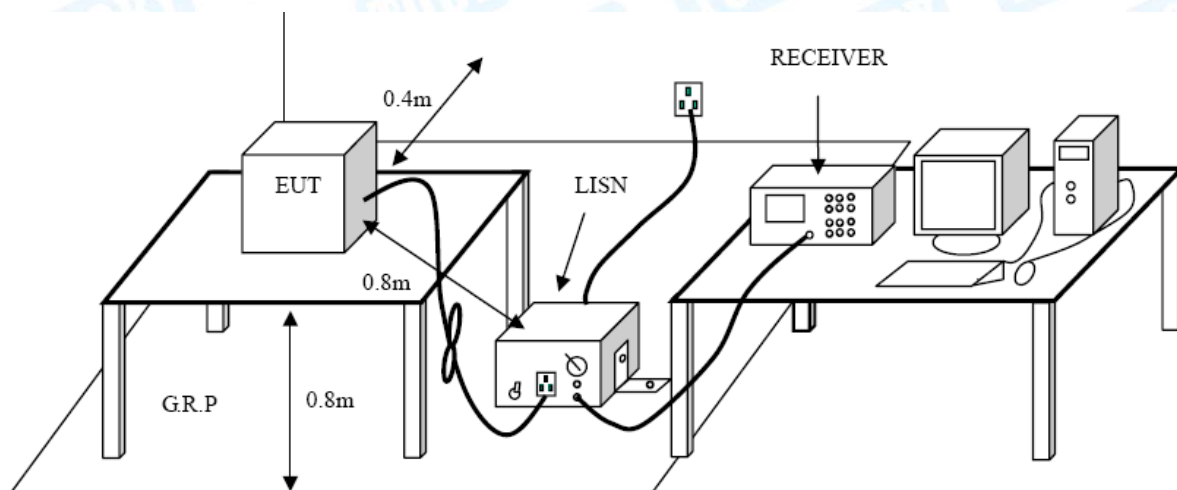

4.3 Test Procedure

The EUT was placed 0.8 meters from the horizontal ground plane with EUT being connected to the power mains through a line impedance stabilization network (LISN). All other support equipments powered from additional LISN(s). The LISN provide 50 Ohm/ 50uH of coupling impedance for the measuring instrument.

Interconnecting cables that hang closer than 40 cm to the ground plane shall be folded back and forth in the center forming a bundle 30 to 40 cm long.

I/O cables that are not connected to a peripheral shall be bundled in the center. The end of the cable may be terminated, if required, using the correct terminating impedance. The overall length shall not exceed 1 m.

LISN at least 80 cm from nearest part of EUT chassis

The bandwidth of EMI test receiver is set at 9kHz, and the test frequency band is from 0.15MHz to 30MHz.

4.4 EUT Operating Mode

Please refer to the description of test mode.

4.5 Test Data

Please refer to the Attachment A.

5. Radiated Emission Test

5.1 Test Standard and Limit

5.1.1 Test Standard

FCC Part 15.209

5.1.2 Test Limit

Radiated Emission Limit (9 kHz~1000MHz)

Frequency (MHz)	Field Strength (microvolt/meter)	Measurement Distance (meters)
0.009~0.490	2400/F(KHz)	300
0.490~1.705	24000/F(KHz)	30
1.705~30.0	30	30
30~88	100	3
88~216	150	3
216~960	200	3
Above 960	500	3

Radiated Emission Limit (Above 1000MHz)

Frequency (MHz)	Class B (dBuV/m)(at 3m)	
	Peak	Average
Above 1000	74	54

Note:

- (1) The tighter limit applies at the band edges.
- (2) Emission Level (dBuV/m)=20log Emission Level (uV/m)

5.2 Test Setup

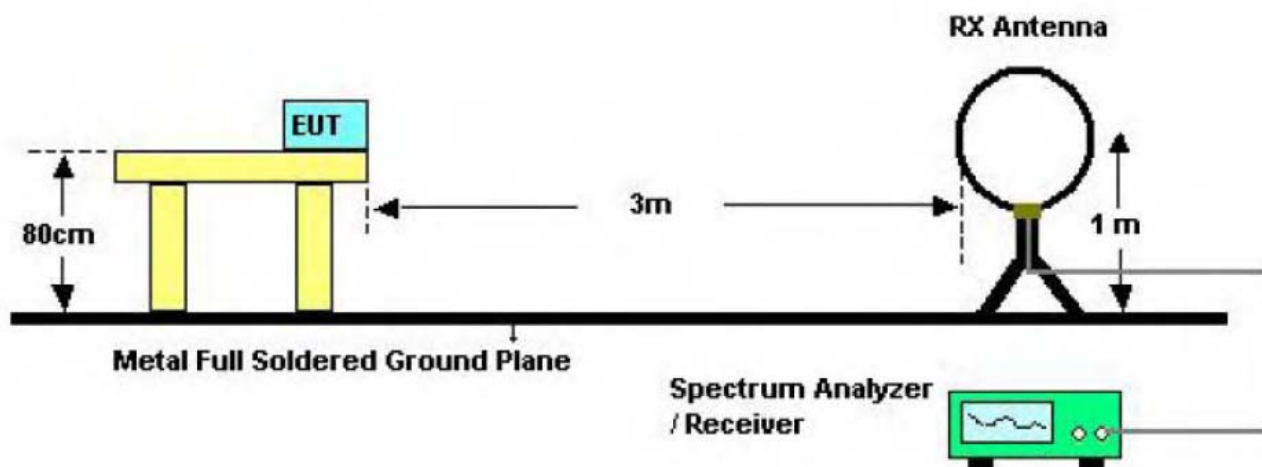

Below 30MHz Test Setup

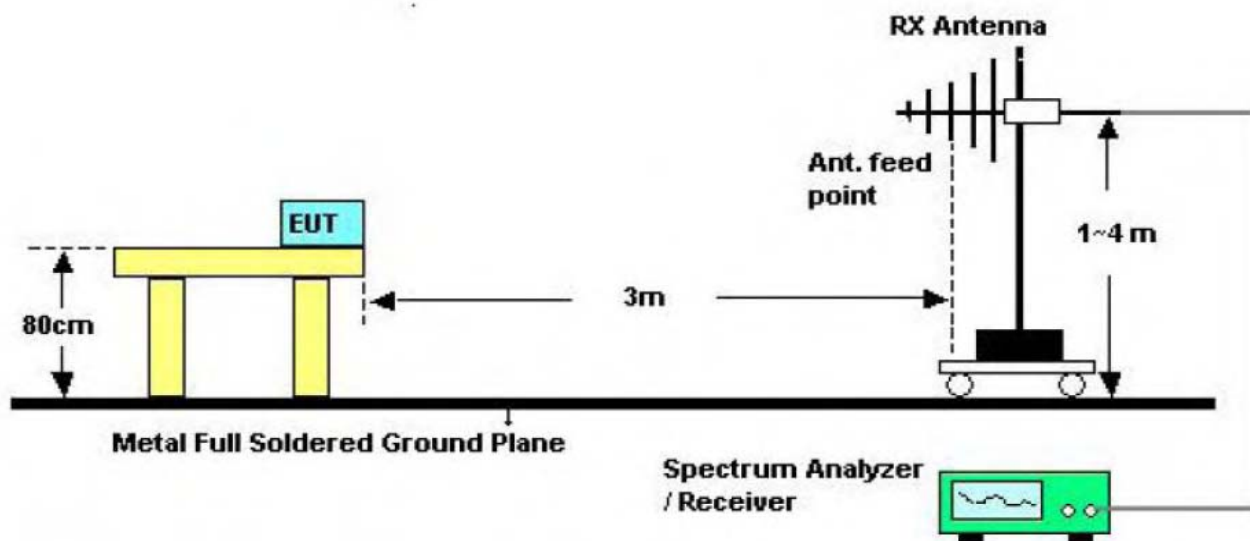

Below 1000MHz Test Setup

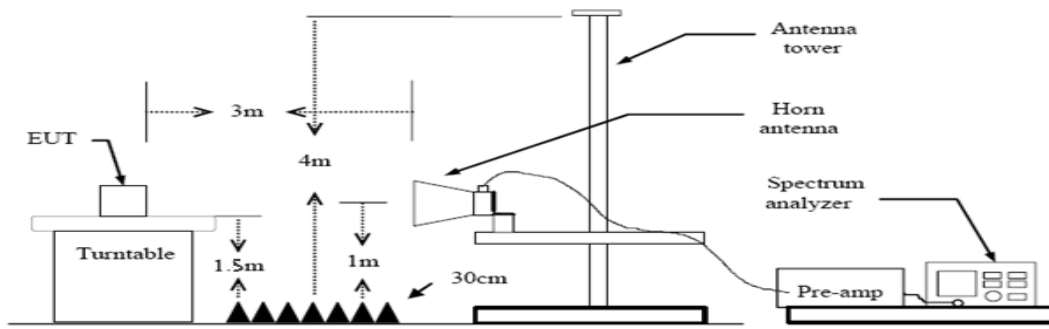

Above 1GHz Test Setup

5.3 Test Procedure

- (1) The measuring distance of 3m shall be used for measurements at frequency up to 1GHz and above 1 GHz. The EUT was placed on a rotating 0.8m high above ground, the table was rotated 360 degrees to determine the position of the highest radiation.
- (2) Measurements at frequency above 1GHz. The EUT was placed on a rotating 1.5m high above the ground. RF absorbers covered the ground plane with a minimum area of 3.0m by 3.0m between the EUT and measurement receiver antenna. The RF absorber shall not exceed 30cm in high above the conducting floor. The table was rotated 360 degrees to determine the position of the highest radiation.
- (3) The Test antenna shall vary between 1m and 4m, Both Horizontal and Vertical antenna are set to make measurement.
- (4) The initial step in collecting conducted emission data is a spectrum analyzer peak detector mode pre-scanning the measurement frequency range. Significant peaks are then marked and then Quasi Peak detector mode re-measured.
- (5) If the Peak Mode measured value compliance with and lower than Quasi Peak Mode Limit Bellow 1 GHz, the EUT shall be deemed to meet QP Limits and then no additional QP Mode measurement performed. But the Peak Value and average value both need to comply with applicable limit above 1 GHz.
- (6) Testing frequency range below 1GHz the measuring instrument use VBW=120 kHz with Quasi-peak detection.
- (7) Testing frequency range above 1GHz the measuring instrument use RBW=1 MHz and VBW=3 MHz with Peak Detector for Peak Values, and use RBW=1 MHz and VBW=10 Hz with Peak Detector for Average Values.
- (8) For the actual test configuration, please see the test setup photo.

5.4 EUT Operating Condition

The Equipment Under Test was set to Continual Transmitting in maximum power in TX mode.

5.5 Test Data

Remark: During testing above 1GHz the measuring instrument use RBW=1 MHz and VBW=3 MHz with Peak Detector for Peak Values, and use RBW=1 MHz and VBW=10 Hz with Peak Detector for Average Values.

Please refer to the Attachment B.

6. Restricted Bands Requirement

6.1 Test Standard and Limit

6.1.1 Test Standard

FCC Part 15.209

FCC Part 15.205

6.1.2 Test Limit

Restricted Frequency Band (MHz)	Class B (dBuV/m)(at 3m)	
	Peak	Average
2310 ~2390	74	54
2483.5 ~2500	74	54

Note: All restriction bands have been tested, only the worst case is reported.

6.2 Test Setup

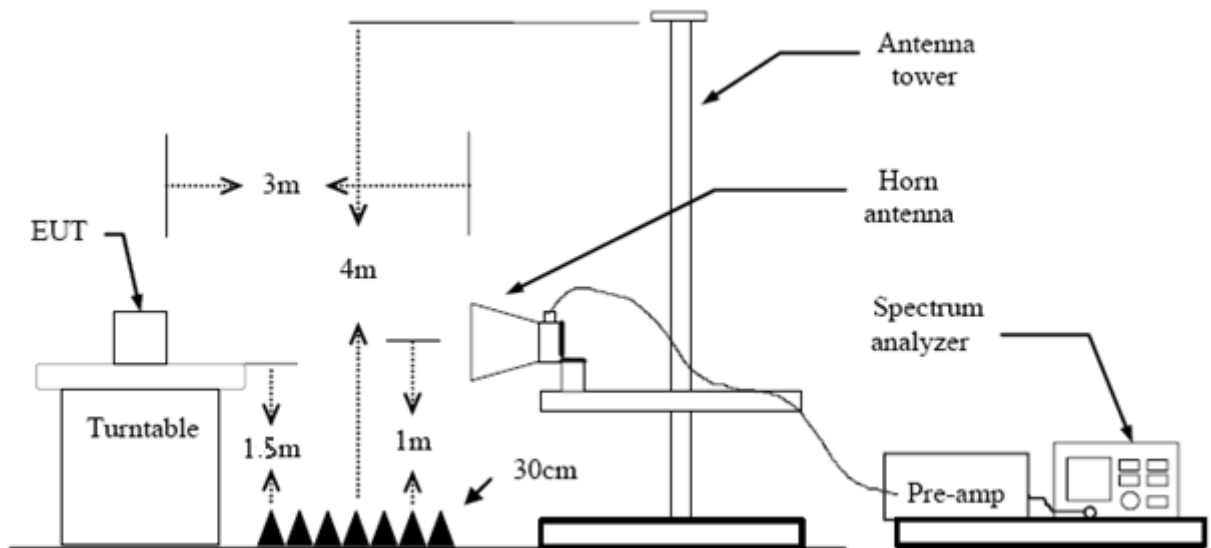

6.3 Test Procedure

- (1) The measuring distance of 3m shall be used for measurements at frequency up to 1GHz and above 1 GHz. The EUT was placed on a rotating 0.8m high above ground, the table was rotated 360 degrees to determine the position of the highest radiation.
- (2) Measurements at frequency above 1GHz. The EUT was placed on a rotating 1.5m high above the ground. RF absorbers covered the ground plane with a minimum area of 3.0m by 3.0m between the EUT and measurement receiver antenna. The RF absorber shall not exceed 30cm in high above the conducting floor. The table was rotated 360 degrees to determine the position of the highest radiation.

- (3) The Test antenna shall vary between 1m and 4m, Both Horizontal and Vertical antenna are set to make measurement.
- (4) The initial step in collecting conducted emission data is a spectrum analyzer peak detector mode pre-scanning the measurement frequency range. Significant peaks are then marked and then Quasi Peak detector mode re-measured.
- (5) If the Peak Mode measured value compliance with and lower than Quasi Peak Mode Limit Bellow 1 GHz, the EUT shall be deemed to meet QP Limits and then no additional QP Mode measurement performed. But the Peak Value and average value both need to comply with applicable limit above 1 GHz.
- (6) Testing frequency range below 1GHz the measuring instrument use VBW=120 kHz with Quasi-peak detection.
- (7) Testing frequency range above 1GHz the measuring instrument use RBW=1 MHz and VBW=3 MHz with Peak Detector for Peak Values, and use RBW=1 MHz and VBW=10 Hz with AVG Detector for Average Values.
- (8) For the actual test configuration, please see the test setup photo.

6.4 EUT Operating Condition

The Equipment Under Test was set to Continual Transmitting in maximum power.

6.5 Test Data

Remark: During testing above 1GHz the measuring instrument use RBW=1 MHz and VBW=3 MHz with Peak Detector for Peak Values, and use RBW=1 MHz and VBW=10 Hz with Peak Detector for Average Values.

All restriction bands have been tested, only the worst case is reported.

Please refer to the Attachment C.

7. Number of Hopping Channel

7.1 Test Standard and Limit

- 6.1.1 Test Standard
FCC Part 15.247 (a)(1)
- 6.1.2 Test Limit

Section	Test Item	Limit
15.247	Number of Hopping Channel	>15

7.2 Test Setup

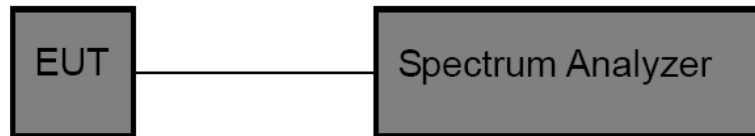

7.3 Test Procedure

- (1) The EUT was directly connected to the spectrum analyzer and antenna output port as show in the block diagram above.
- (2) Spectrum Setting: RBW=100 KHz, VBW=100 KHz, Sweep time= Auto.

7.4 EUT Operating Condition

The EUT was set to the Hopping Mode by the Customer.

7.5 Test Data

Please refer to the Attachment D.

8. Average Time of Occupancy

8.1 Test Standard and Limit

- 8.1.1 Test Standard
FCC Part 15.247 (a)(1)
- 8.1.2 Test Limit

Section	Test Item	Limit
15.247(a)(1)/ RSS-210 Annex 8(A8.1d)	Average Time of Occupancy	0.4 sec

8.2 Test Setup

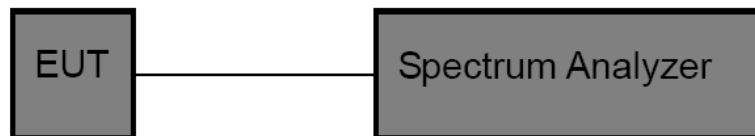

8.3 Test Procedure

- (1) The EUT was directly connected to the spectrum analyzer and antenna output port as show in the block diagram above.
- (2) Spectrum Setting: RBW=1MHz, VBW=1MHz.
- (3) Use video trigger with the trigger level set to enable triggering only on full pulses.
- (4) Sweep Time is more than once pulse time.
- (5) Set the center frequency on any frequency would be measure and set the frequency span to zero.
- (6) Measure the maximum time duration of one single pulse.
- (7) Set the EUT for packet transmitting.
- (8) Measure the maximum time duration of one single pulse.

8.4 EUT Operating Condition

The average time of occupancy on any channel within the Period can be calculated with formulas:

$$\{Total\ of\ Dwell\} = \{Pulse\ Time\} * (1600 / X) / \{Number\ of\ Hopping\ Frequency\} * \{Period\}$$

$$\{Period\} = 0.4s * \{Number\ of\ Hopping\ Frequency\}$$

Note: X=2 or 4 or 6 (1DH1=2, 1DH3=4, 1DH5=6. 2DH1=2, 2DH3=4, 2DH5=6. 3DH1=2, 3DH3=4, 3DH5=6)

The lowest, middle and highest channels are selected to perform testing to record the dwell time of each occupation measured in this channel, which is called Pulse Time here.

The EUT was set to the Hopping Mode by the Customer.

8.5 Test Data

Please refer to the Attachment E.

9. Channel Separation and Bandwidth Test

9.1 Test Standard and Limit

- 9.1.1 Test Standard
FCC Part 15.247
- 9.1.2 Test Limit

Test Item	Limit	Frequency Range(MHz)
Bandwidth	≤ 1 MHz (20dB bandwidth)	2400~2483.5
Channel Separation	>25 KHz or $>$ two-thirds of the 20 dB bandwidth Which is greater	2400~2483.5

9.2 Test Setup

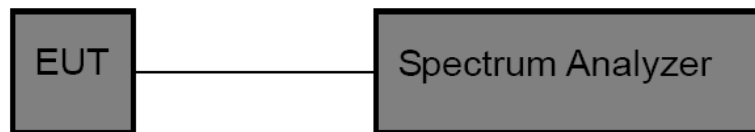

9.3 Test Procedure

- (1) The EUT was directly connected to the spectrum analyzer and antenna output port as show in the block diagram above.
- (2) Spectrum Setting:
Channel Separation: RBW=100 kHz, VBW=100 kHz.
Bandwidth: RBW=30 kHz, VBW=100 kHz.
- (3) The bandwidth is measured at an amplitude level reduced 20dB from the reference level. The reference level is the level of the highest amplitude signal observed from the transmitter at the fundamental frequency. Once the reference level is established, the equipment is conditioned with typical modulating signal to produce the worst –case (i.e the widest) bandwidth.
- (4) Measure the channel separation the spectrum analyzer was set to Resolution Bandwidth:30 kHz, and Video Bandwidth:100 kHz. Sweep Time set auto.

9.4 EUT Operating Condition

The EUT was set to the Hopping Mode for Channel Separation Test and continuously transmitting for the Bandwidth Test.

9.5 Test Data

Please refer to the Attachment F.

10. Peak Output Power Test

10.1 Test Standard and Limit

10.1.1 Test Standard

FCC Part 15.247 (b) (1)

10.1.2 Test Limit

Test Item	Limit	Frequency Range(MHz)
Peak Output Power	Hopping Channels>75 Power<1W(30dBm) Other <125 mW(21dBm)	2400~2483.5

10.2 Test Setup

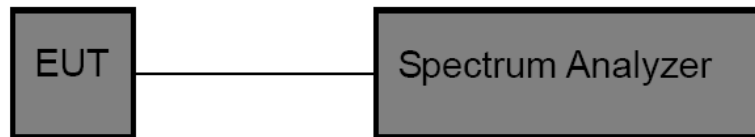

10.3 Test Procedure

- (1) The EUT was directly connected to the spectrum analyzer and antenna output port as show in the block diagram above.
- (2) Spectrum Setting:
 Peak Detector: RBW=1 MHz, VBW=3 MHz for bandwidth less than 1MHz.
 RBW=3 MHz, VBW=3 MHz for bandwidth more than 1MHz.

10.4 EUT Operating Condition

The EUT was set to continuously transmitting in the max power during the test.

10.5 Test Data

Please refer to the Attachment G.

11. Antenna Requirement

11.1 Standard Requirement

11.1.1 Standard

FCC Part 15.203

11.1.2 Requirement

An intentional radiator shall be designed to ensure that no antenna other than that furnished by the responsible party shall be used with the device. The use of a permanently attached antenna or of an antenna that uses a unique coupling to the intentional radiator shall be considered sufficient to comply with the provisions of this Section. The manufacturer may design the unit so that a broken antenna can be replaced by the user, but the use of a standard antenna jack or electrical connector is prohibited.

11.2 Antenna Connected Construction

The directional gains of the antenna used for transmitting is 2dBi, and the antenna connector is de-signed with permanent attachment and no consideration of replacement. Please see the EUT photo for details.

11.3 Result

The EUT antenna is a Ceramic Antenna. It complies with the standard requirement.

Antenna Type
<input checked="" type="checkbox"/> Permanent attached antenna
<input type="checkbox"/> Unique connector antenna
<input type="checkbox"/> Professional installation antenna

Attachment A-- Conducted Emission Test Data

Temperature:	25°C	Relative Humidity:	55%
Test Voltage:	AC 120V/60 Hz		
Terminal:	Line		
Test Mode:	USB Charging Mode		
Remark:	Only worse case is reported		

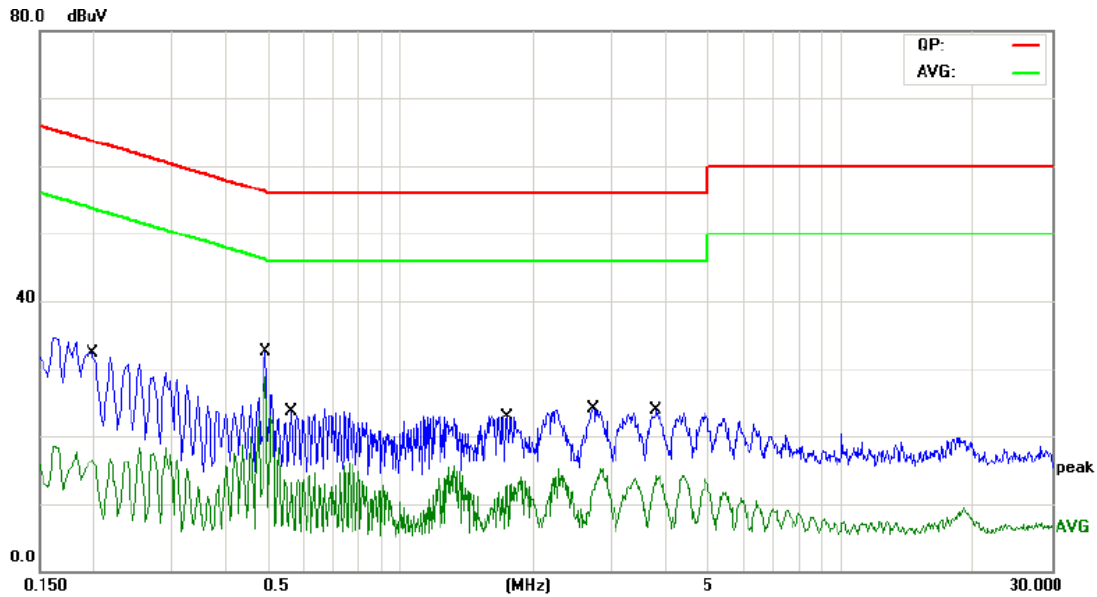

No.	Mk.	Freq. MHz	Reading Level dBuV	Correct Factor dB	Measure- ment dBuV	Limit dBuV	Over dB	Detector
1		0.1980	20.51	9.58	30.09	63.69	-33.60	QP
2		0.1980	5.65	9.58	15.23	53.69	-38.46	AVG
3		0.4900	20.96	9.60	30.56	56.17	-25.61	QP
4	*	0.4900	19.12	9.60	28.72	46.17	-17.45	AVG
5		0.5620	10.41	9.60	20.01	56.00	-35.99	QP
6		0.5620	3.22	9.60	12.82	46.00	-33.18	AVG
7		1.7380	9.11	9.61	18.72	56.00	-37.28	QP
8		1.7380	2.71	9.61	12.32	46.00	-33.68	AVG
9		2.7340	10.36	9.64	20.00	56.00	-36.00	QP
10		2.7340	2.20	9.64	11.84	46.00	-34.16	AVG
11		3.7860	9.63	9.67	19.30	56.00	-36.70	QP
12		3.7860	3.31	9.67	12.98	46.00	-33.02	AVG

Emission Level= Read Level+ Correct Factor

Temperature:	25°C	Relative Humidity:	55%
Test Voltage:	AC 120V/60 Hz		
Terminal:	Neutral		
Test Mode:	USB Charging Mode		
Remark:	Only worse case is reported		

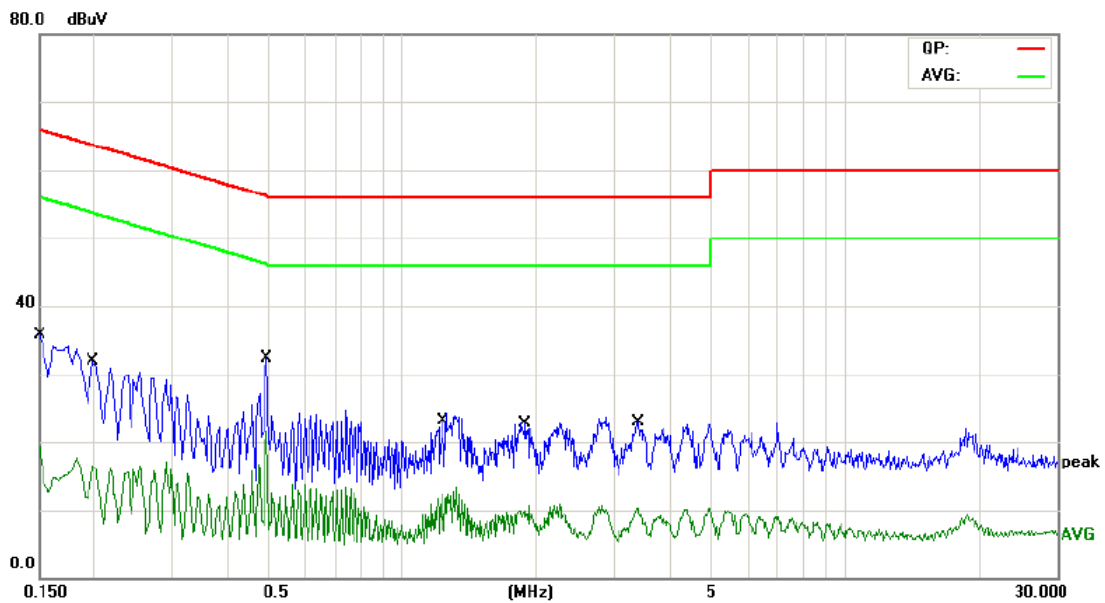

No.	Mk.	Freq. MHz	Reading Level dBuV	Correct Factor dB	Measure- ment dBuV	Limit dBuV	Over dB	Detector
1		0.1500	24.82	9.64	34.46	65.99	-31.53	QP
2		0.1500	8.15	9.64	17.79	55.99	-38.20	AVG
3		0.1980	19.63	9.65	29.28	63.69	-34.41	QP
4		0.1980	4.91	9.65	14.56	53.69	-39.13	AVG
5	*	0.4900	15.66	9.58	25.24	56.17	-30.93	QP
6		0.4900	3.59	9.58	13.17	46.17	-33.00	AVG
7		1.2300	4.86	9.59	14.45	56.00	-41.55	QP
8		1.2300	-2.51	9.59	7.08	46.00	-38.92	AVG
9		1.8780	8.06	9.61	17.67	56.00	-38.33	QP
10		1.8780	-0.06	9.61	9.55	46.00	-36.45	AVG
11		3.4020	6.31	9.69	16.00	56.00	-40.00	QP
12		3.4020	-1.00	9.69	8.69	46.00	-37.31	AVG

Emission Level= Read Level+ Correct Factor

Temperature:	25°C	Relative Humidity:	55%
Test Voltage:	AC 240V/60 Hz		
Terminal:	Line		
Test Mode:	USB Charging Mode		
Remark:	Only worse case is reported		

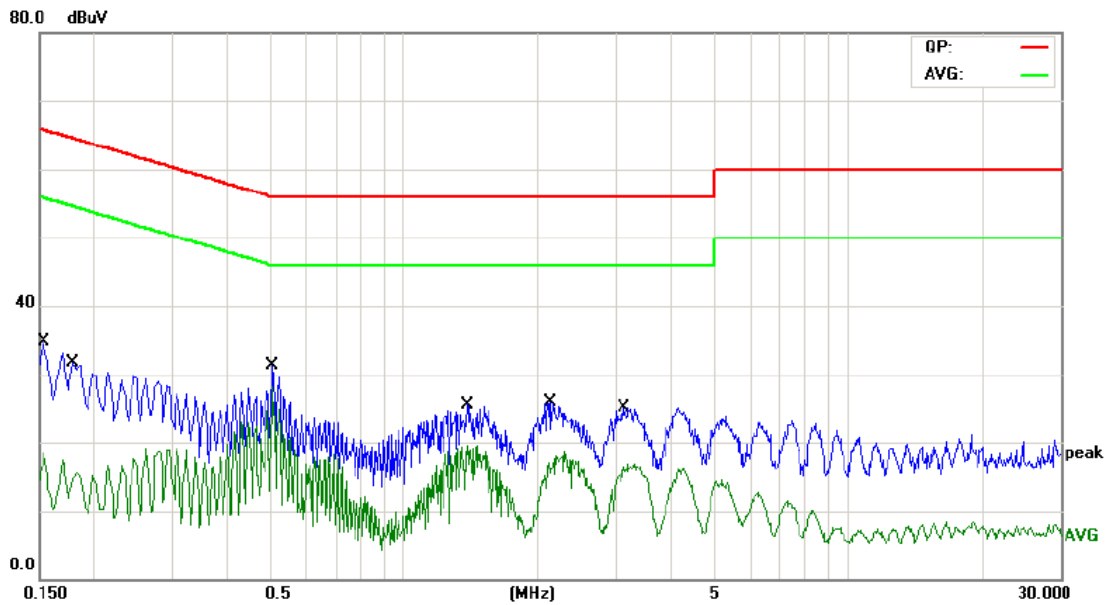

No.	Mk.	Freq. MHz	Reading Level dBuV	Correct Factor dB	Measure- ment dBuV	Limit dBuV	Over dB	Detector
1		0.1539	23.14	9.58	32.72	65.78	-33.06	QP
2		0.1539	6.68	9.58	16.26	55.78	-39.52	AVG
3		0.1787	15.04	9.58	24.62	64.54	-39.92	QP
4		0.1787	0.82	9.58	10.40	54.54	-44.14	AVG
5		0.5060	19.76	9.60	29.36	56.00	-26.64	QP
6	*	0.5060	17.79	9.60	27.39	46.00	-18.61	AVG
7		1.3820	12.82	9.60	22.42	56.00	-33.58	QP
8		1.3820	9.46	9.60	19.06	46.00	-26.94	AVG
9		2.1340	11.79	9.61	21.40	56.00	-34.60	QP
10		2.1340	6.69	9.61	16.30	46.00	-29.70	AVG
11		3.1140	10.78	9.65	20.43	56.00	-35.57	QP
12		3.1140	6.17	9.65	15.82	46.00	-30.18	AVG

Emission Level= Read Level+ Correct Factor

Temperature:	25°C	Relative Humidity:	55%
Test Voltage:	AC 240V/60 Hz		
Terminal:	Neutral		
Test Mode:	USB Charging Mode		
Remark:	Only worse case is reported		

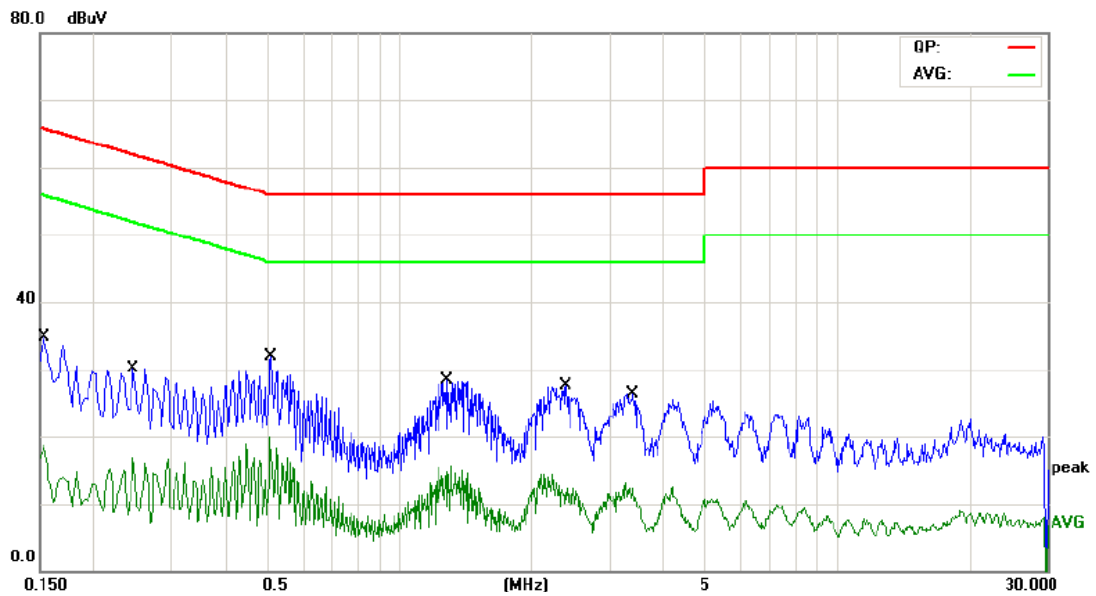

No.	Mk.	Freq. MHz	Reading Level dBuV	Correct Factor dB	Measure- ment dBuV	Limit dBuV	Over dB	Detector
1		0.1539	23.35	9.64	32.99	65.78	-32.79	QP
2		0.1539	5.50	9.64	15.14	55.78	-40.64	AVG
3		0.2460	17.58	9.61	27.19	61.89	-34.70	QP
4		0.2460	4.38	9.61	13.99	51.89	-37.90	AVG
5	*	0.5100	16.99	9.58	26.57	56.00	-29.43	QP
6		0.5100	5.74	9.58	15.32	46.00	-30.68	AVG
7		1.2780	11.73	9.60	21.33	56.00	-34.67	QP
8		1.2780	0.46	9.60	10.06	46.00	-35.94	AVG
9		2.3860	6.65	9.63	16.28	56.00	-39.72	QP
10		2.3860	-2.61	9.63	7.02	46.00	-38.98	AVG
11		3.4140	6.94	9.69	16.63	56.00	-39.37	QP
12		3.4140	-1.60	9.69	8.09	46.00	-37.91	AVG

Emission Level= Read Level+ Correct Factor

Attachment B-- Radiated Emission Test Data

9KHz~30MHz

From 9KHz to 30MHz: Conclusion: PASS

Note: The amplitude of spurious emissions which are attenuated by more than 20dB below the permissible value has no need to be reported.

30MHz~1GHz

Temperature:	25°C	Relative Humidity:	55%
Test Voltage:	DC 3.7V		
Ant. Pol.	Horizontal		
Test Mode:	TX GFSK Mode 2402MHz		
Remark:	Only worse case is reported		

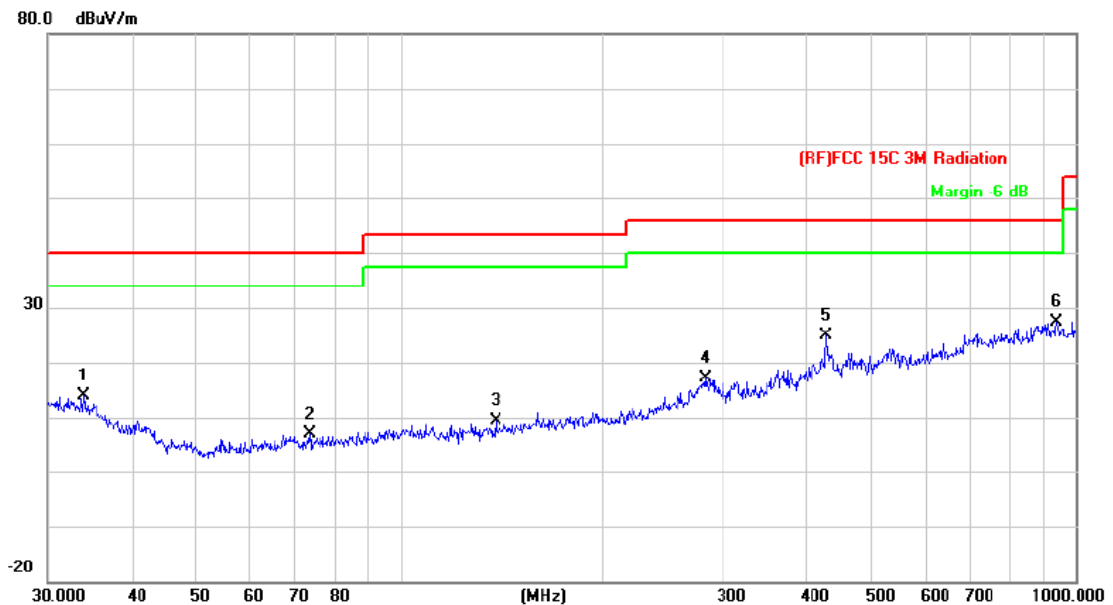

No.	Mk.	Freq. MHz	Reading Level dBuV	Correct Factor dB/m	Measure- ment dBuV/m	Limit dBuV/m	Over dB	Detector
1		33.9174	29.64	-15.87	13.77	40.00	-26.23	QP
2		73.3593	29.84	-22.95	6.89	40.00	-33.11	QP
3		138.3873	30.73	-21.38	9.35	43.50	-34.15	QP
4		282.9852	33.51	-16.30	17.21	46.00	-28.79	QP
5		428.0193	36.84	-11.90	24.94	46.00	-21.06	QP
6	*	938.8326	30.79	-3.38	27.41	46.00	-18.59	QP

*:Maximum data x:Over limit !:over margin

Emission Level= Read Level+ Correct Factor

Temperature:	25°C	Relative Humidity:	55%
Test Voltage:	DC 3.7V		
Ant. Pol.	Vertical		
Test Mode:	TX GFSK Mode 2402MHz		
Remark:	Only worse case is reported		

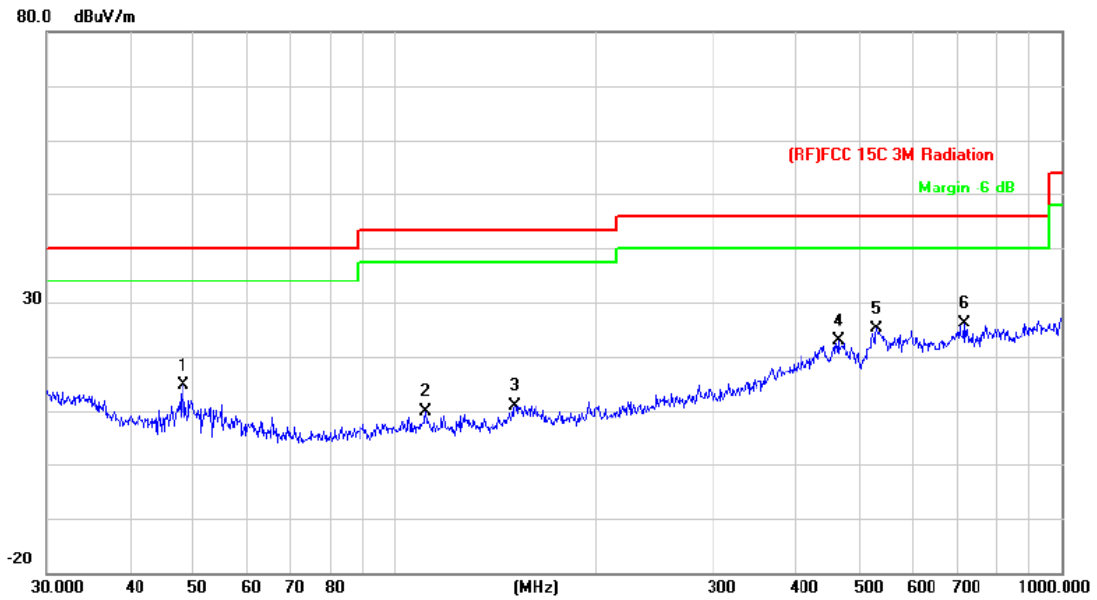

No.	Mk.	Freq. MHz	Reading Level dBuV	Correct Factor dB/m	Measure- ment dBuV/m	Limit dBuV/m	Over dB	Detector
1		48.1626	37.65	-23.01	14.64	40.00	-25.36	QP
2		111.3468	31.15	-21.35	9.80	43.50	-33.70	QP
3		151.5972	31.38	-20.40	10.98	43.50	-32.52	QP
4		462.3455	33.92	-11.11	22.81	46.00	-23.19	QP
5		528.2458	34.31	-9.24	25.07	46.00	-20.93	QP
6	*	714.1734	32.06	-5.91	26.15	46.00	-19.85	QP

*:Maximum data x:Over limit !:over margin

Emission Level= Read Level+ Correct Factor

Above 1GHz(Only worse case is reported)

Temperature:	25°C	Relative Humidity:	55%
Test Voltage:	DC 3.7V		
Ant. Pol.	Horizontal		
Test Mode:	TX GFSK Mode 2402MHz		
Remark:	No report for the emission which more than 10 dB below the prescribed limit.		

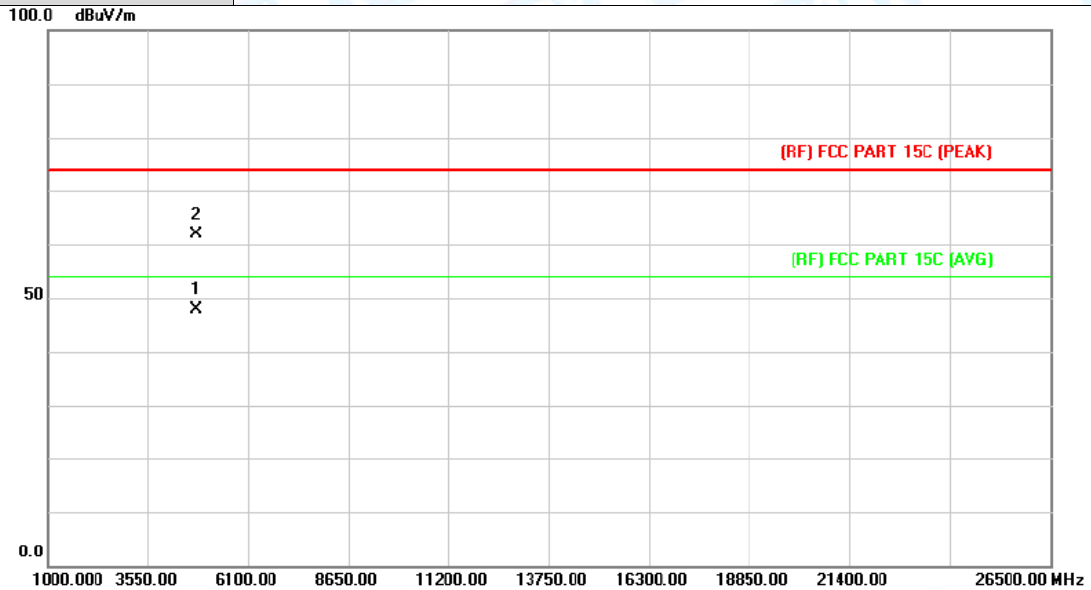

No.	Mk.	Freq.	Reading Level	Correct Factor	Measurement	Limit	Over	Detector
		MHz	dBuV	dB/m	dBuV/m	dBuV/m	dB	
1	*	4804.192	33.32	14.56	47.88	54.00	-6.12	AVG
2		4804.328	47.38	14.56	61.94	74.00	-12.06	peak

Emission Level= Read Level+ Correct Factor

Temperature:	25°C	Relative Humidity:	55%
Test Voltage:	DC 3.7V		
Ant. Pol.	Vertical		
Test Mode:	TX GFSK Mode 2402MHz		
Remark:	No report for the emission which more than 10 dB below the prescribed limit.		

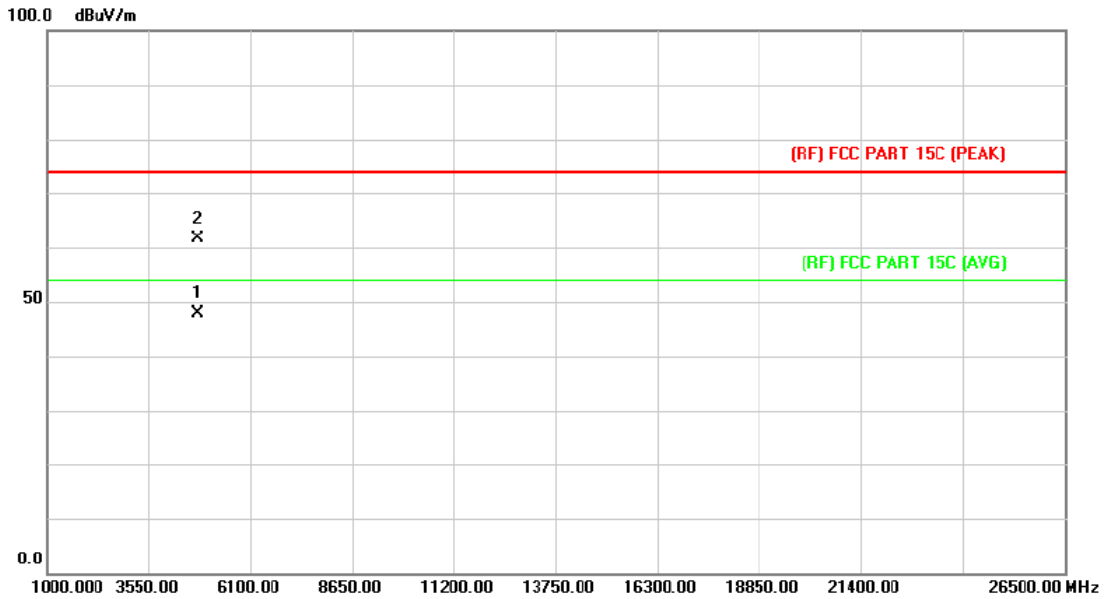

No.	Mk.	Freq. MHz	Reading Level dBuV	Correct Factor dB/m	Measure- ment dBuV/m	Limit dBuV/m	Over dB	Detector
1	*	4804.152	33.38	14.56	47.94	54.00	-6.06	AVG
2		4804.366	47.02	14.56	61.58	74.00	-12.42	peak

Emission Level= Read Level+ Correct Factor

Temperature:	25°C	Relative Humidity:	55%
Test Voltage:	DC 3.7V		
Ant. Pol.	Horizontal		
Test Mode:	TX GFSK Mode 2441MHz		
Remark:	No report for the emission which more than 10 dB below the prescribed limit.		

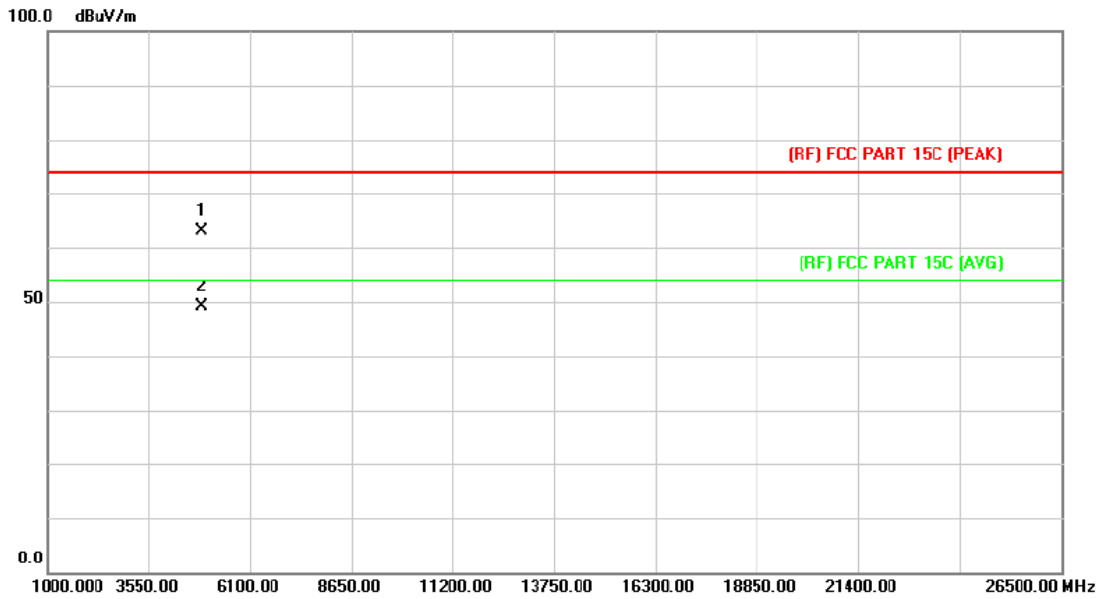

No.	Mk.	Freq. MHz	Reading Level dBuV	Correct Factor dB/m	Measure- ment dBuV/m	Limit dBuV/m	Over dB	Detector
1		4881.056	48.08	15.16	63.24	74.00	-10.76	peak
2	*	4881.344	33.85	15.16	49.01	54.00	-4.99	AVG

Emission Level= Read Level+ Correct Factor

Temperature:	25°C	Relative Humidity:	55%
Test Voltage:	DC 3.7V		
Ant. Pol.	Vertical		
Test Mode:	TX GFSK Mode 2441MHz		
Remark:	No report for the emission which more than 10 dB below the prescribed limit.		

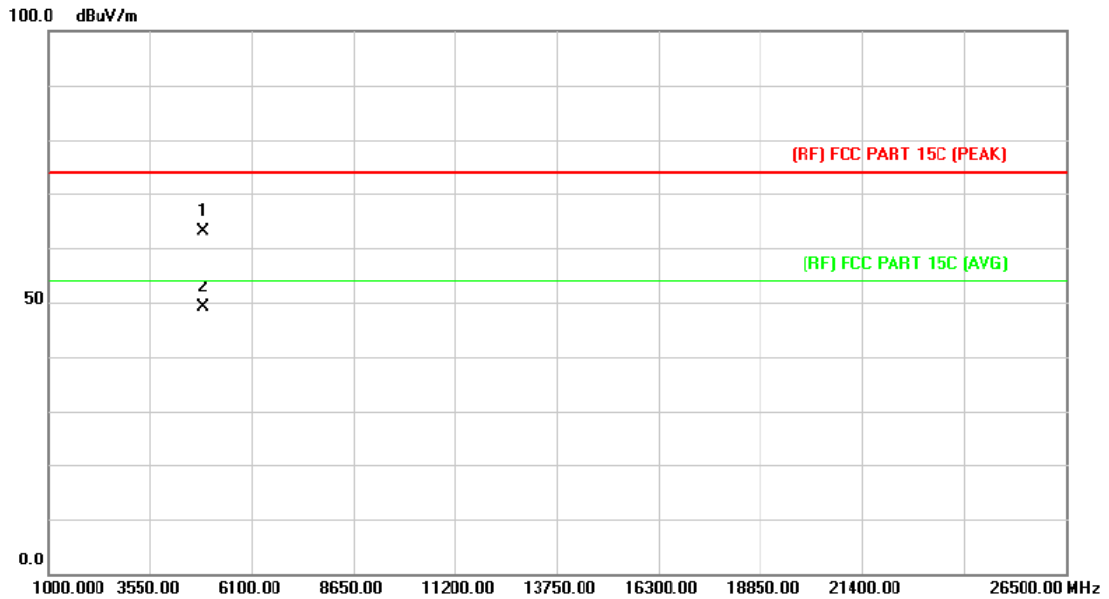

No.	Mk.	Freq. MHz	Reading Level dBuV	Correct Factor dB/m	Measure- ment dBuV/m	Limit dBuV/m	Over dB	Detector
1		4882.036	47.99	15.16	63.15	74.00	-10.85	peak
2	*	4882.596	33.86	15.16	49.02	54.00	-4.98	AVG

Emission Level= Read Level+ Correct Factor

Temperature:	25°C	Relative Humidity:	55%
Test Voltage:	DC 3.7V		
Ant. Pol.	Horizontal		
Test Mode:	TX GFSK Mode 2480MHz		
Remark:	No report for the emission which more than 10 dB below the prescribed limit.		

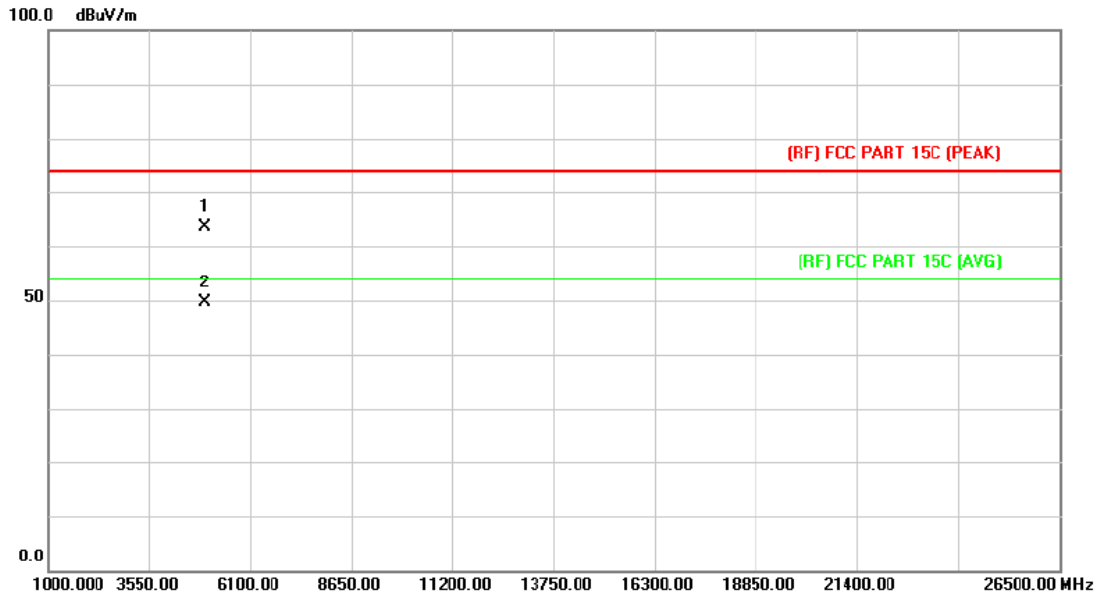

No.	Mk.	Freq. MHz	Reading Level dBuV	Correct Factor dB/m	Measure- ment dBuV/m	Limit dBuV/m	Over dB	Detector
1		4960.660	47.93	15.76	63.69	74.00	-10.31	peak
2	*	4961.000	33.94	15.76	49.70	54.00	-4.30	AVG

Emission Level= Read Level+ Correct Factor

Temperature:	25°C	Relative Humidity:	55%
Test Voltage:	DC 3.7V		
Ant. Pol.	Vertical		
Test Mode:	TX GFSK Mode 2480MHz		
Remark:	No report for the emission which more than 10 dB below the prescribed limit.		

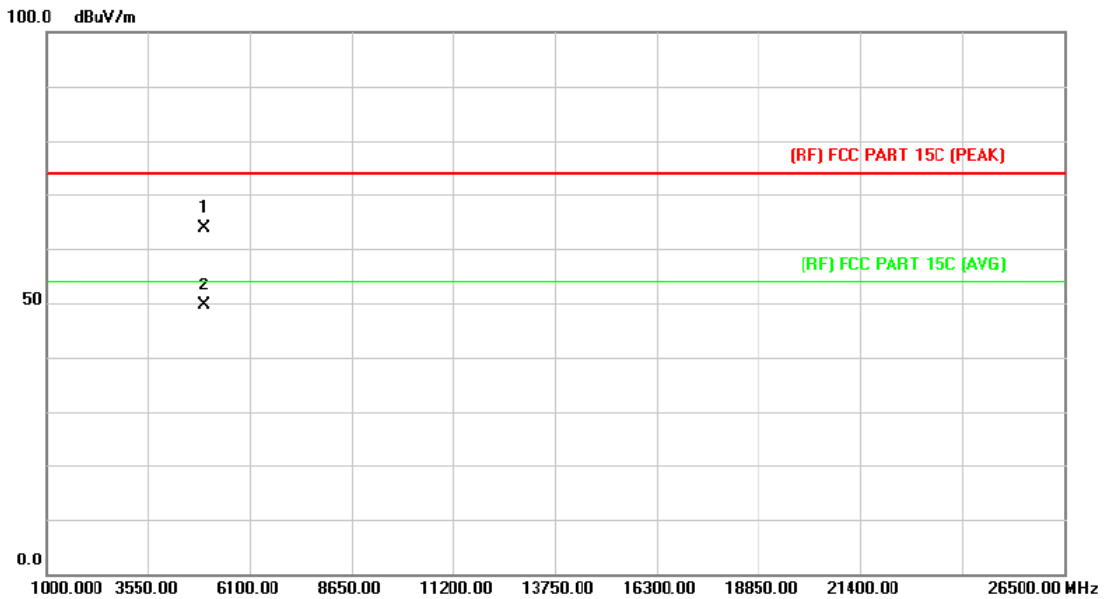

No.	Mk.	Freq. MHz	Reading Level dBuV	Correct Factor dB/m	Measure- ment dBuV/m	Limit dBuV/m	Over dB	Detector
1		4959.550	48.12	15.76	63.88	74.00	-10.12	peak
2	*	4960.252	33.92	15.76	49.68	54.00	-4.32	AVG

Emission Level= Read Level+ Correct Factor

Temperature:	25°C	Relative Humidity:	55%
Test Voltage:	DC 3.7V		
Ant. Pol.	Horizontal		
Test Mode:	TX π /4-DQPSK Mode 2402MHz		
Remark:	No report for the emission which more than 10 dB below the prescribed limit.		

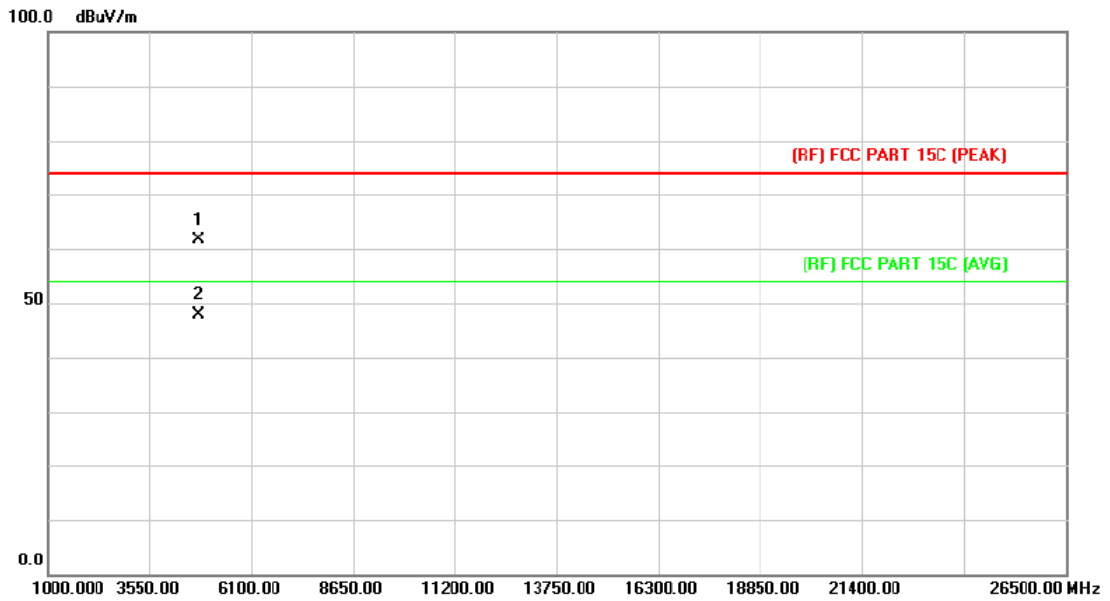

No.	Mk.	Freq. MHz	Reading Level dBuV	Correct Factor dB/m	Measure- ment dBuV/m	Limit dBuV/m	Over dB	Detector
1		4803.440	47.17	14.56	61.73	74.00	-12.27	peak
2	*	4804.170	33.34	14.56	47.90	54.00	-6.10	AVG

Emission Level= Read Level+ Correct Factor

Temperature:	25°C	Relative Humidity:	55%
Test Voltage:	DC 3.7V		
Ant. Pol.	Vertical		
Test Mode:	TX π /4-DQPSK Mode 2402MHz		
Remark:	No report for the emission which more than 10 dB below the prescribed limit.		

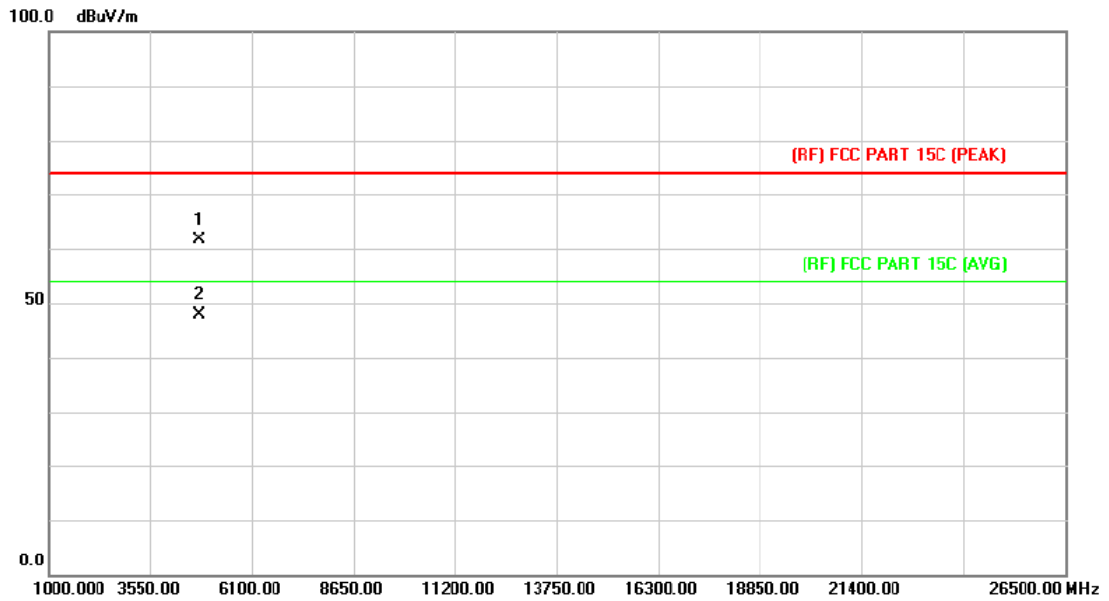

No.	Mk.	Freq. MHz	Reading Level dBuV	Correct Factor dB/m	Measure- ment dBuV/m	Limit dBuV/m	Over dB	Detector
1		4803.076	47.06	14.55	61.61	74.00	-12.39	peak
2	*	4804.192	33.37	14.56	47.93	54.00	-6.07	AVG

Emission Level= Read Level+ Correct Factor

Temperature:	25°C	Relative Humidity:	55%
Test Voltage:	DC 3.7V		
Ant. Pol.	Horizontal		
Test Mode:	TX π /4-DQPSK Mode 2441MHz		
Remark:	No report for the emission which more than 10 dB below the prescribed limit.		

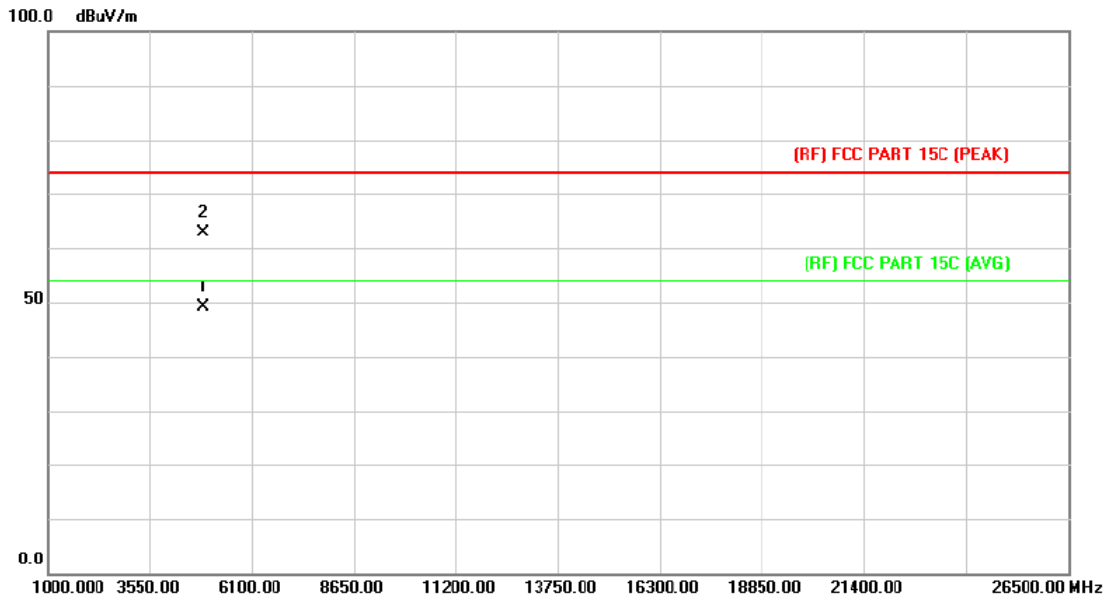

No.	Mk.	Freq. MHz	Reading Level dBuV	Correct Factor dB/m	Measure- ment dBuV/m	Limit dBuV/m	Over dB	Detector
1	*	4882.736	33.86	15.16	49.02	54.00	-4.98	AVG
2		4882.884	47.61	15.16	62.77	74.00	-11.23	peak

Emission Level= Read Level+ Correct Factor

Temperature:	25°C	Relative Humidity:	55%
Test Voltage:	DC 3.7V		
Ant. Pol.	Vertical		
Test Mode:	TX π /4-DQPSK Mode 2441MHz		
Remark:	No report for the emission which more than 10 dB below the prescribed limit.		

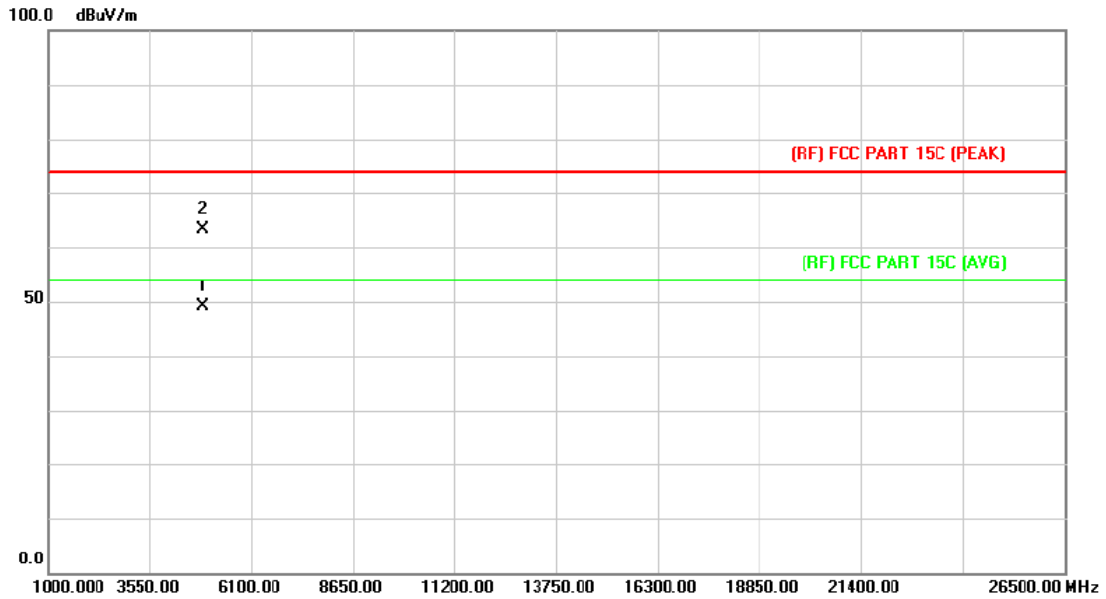

No.	Mk.	Freq. MHz	Reading Level dBuV	Correct Factor dB/m	Measure- ment dBuV/m	Limit dBuV/m	Over dB	Detector
1	*	4882.454	33.88	15.16	49.04	54.00	-4.96	AVG
2		4882.510	48.28	15.16	63.44	74.00	-10.56	peak

Emission Level= Read Level+ Correct Factor

Temperature:	25°C	Relative Humidity:	55%
Test Voltage:	DC 3.7V		
Ant. Pol.	Horizontal		
Test Mode:	TX π /4-DQPSK Mode 2480MHz		
Remark:	No report for the emission which more than 10 dB below the prescribed limit.		

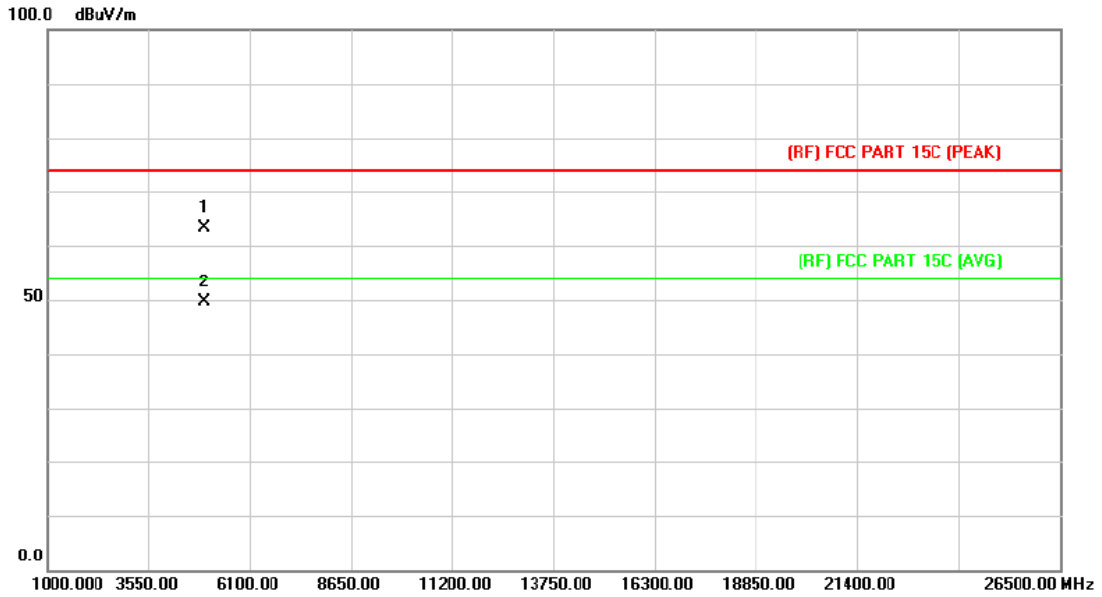

No.	Mk.	Freq. MHz	Reading Level dBuV	Correct Factor dB/m	Measure- ment dBuV/m	Limit dBuV/m	Over dB	Detector
1		4960.392	47.63	15.76	63.39	74.00	-10.61	peak
2	*	4960.798	33.93	15.76	49.69	54.00	-4.31	AVG

Emission Level= Read Level+ Correct Factor

Temperature:	25°C	Relative Humidity:	55%
Test Voltage:	DC 3.7V		
Ant. Pol.	Vertical		
Test Mode:	TX π /4-DQPSK Mode 2480MHz		
Remark:	No report for the emission which more than 10 dB below the prescribed limit.		

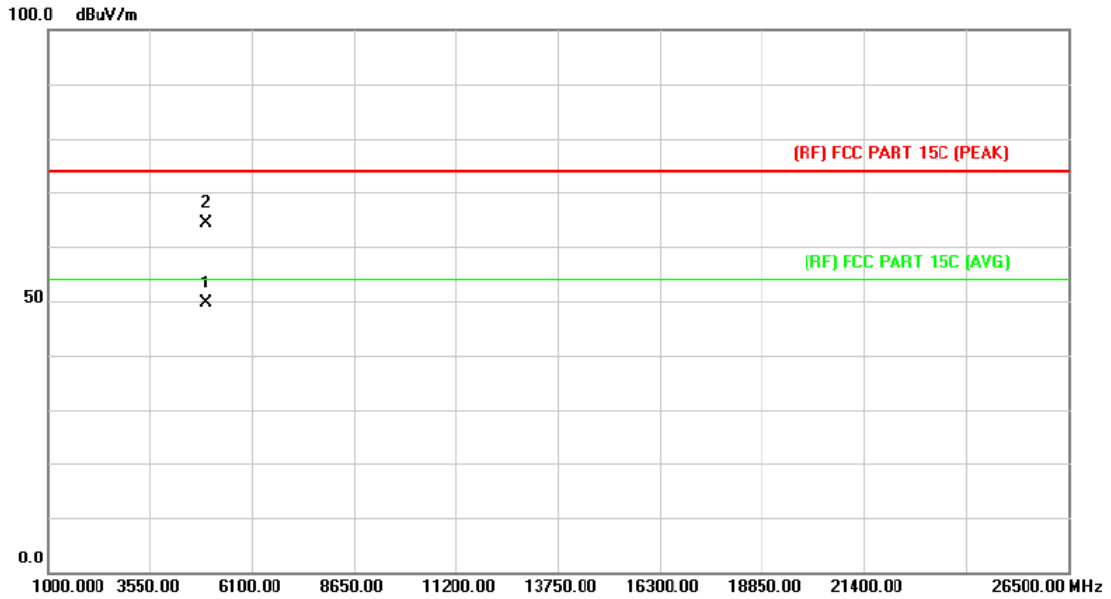

No.	Mk.	Freq. MHz	Reading Level dBuV	Correct Factor dB/m	Measure- ment dBuV/m	Limit dBuV/m	Over dB	Detector
1	*	4959.202	33.91	15.76	49.67	54.00	-4.33	AVG
2		4959.704	48.51	15.76	64.27	74.00	-9.73	peak

Emission Level= Read Level+ Correct Factor

Temperature:	25°C	Relative Humidity:	55%
Test Voltage:	DC 3.7V		
Ant. Pol.	Horizontal		
Test Mode:	TX 8-DPSK Mode 2402MHz		
Remark:	No report for the emission which more than 10 dB below the prescribed limit.		

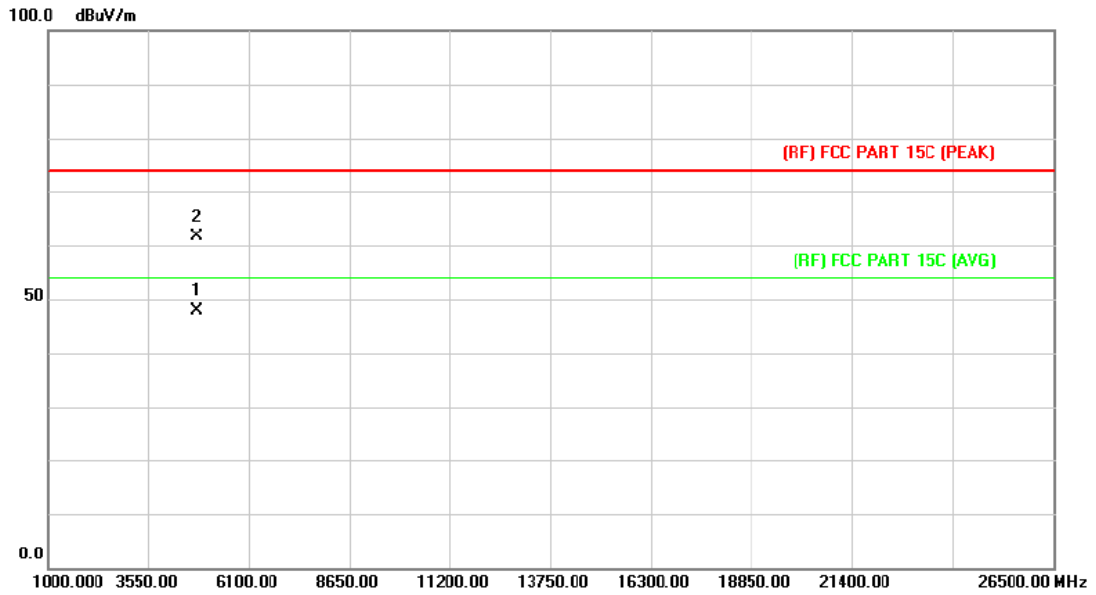

No.	Mk.	Freq. MHz	Reading Level dBuV	Correct Factor dB/m	Measure- ment dBuV/m	Limit dBuV/m	Over dB	Detector
1	*	4804.414	33.33	14.56	47.89	54.00	-6.11	AVG
2		4804.714	47.02	14.56	61.58	74.00	-12.42	peak

Emission Level= Read Level+ Correct Factor

Temperature:	25°C	Relative Humidity:	55%
Test Voltage:	DC 3.7V		
Ant. Pol.	Vertical		
Test Mode:	TX 8-DPSK Mode 2402MHz		
Remark:	No report for the emission which more than 10 dB below the prescribed limit.		

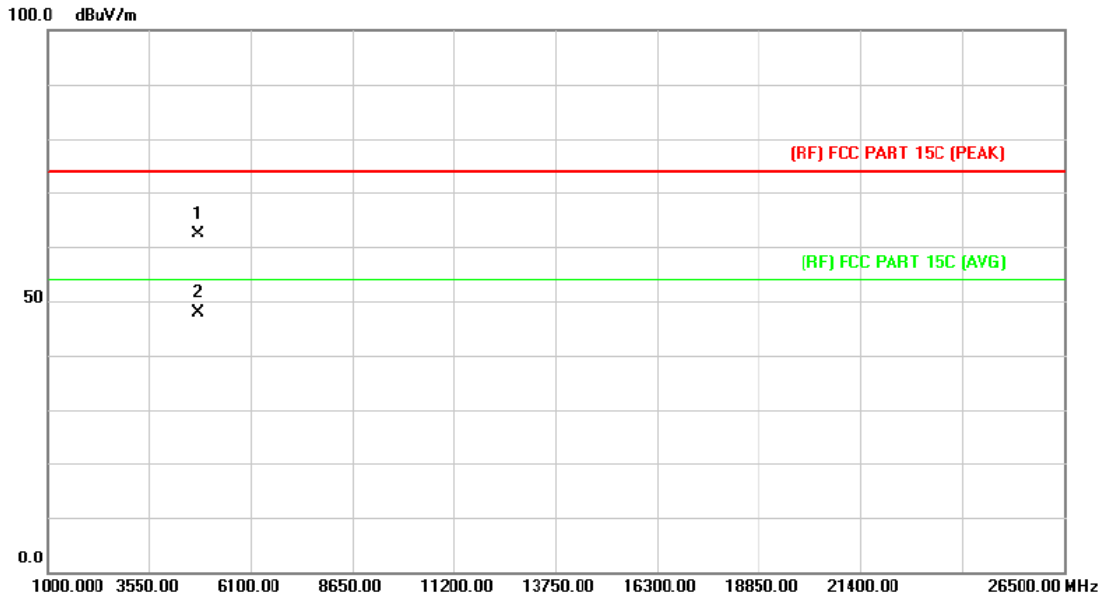

No.	Mk.	Freq. MHz	Reading Level dBuV	Correct Factor dB/m	Measure- ment dBuV/m	Limit dBuV/m	Over dB	Detector
1		4804.418	47.75	14.56	62.31	74.00	-11.69	peak
2	*	4804.616	33.32	14.56	47.88	54.00	-6.12	AVG

Emission Level= Read Level+ Correct Factor

Temperature:	25°C	Relative Humidity:	55%
Test Voltage:	DC 3.7V		
Ant. Pol.	Horizontal		
Test Mode:	TX 8-DPSK Mode 2441MHz		
Remark:	No report for the emission which more than 10 dB below the prescribed limit.		

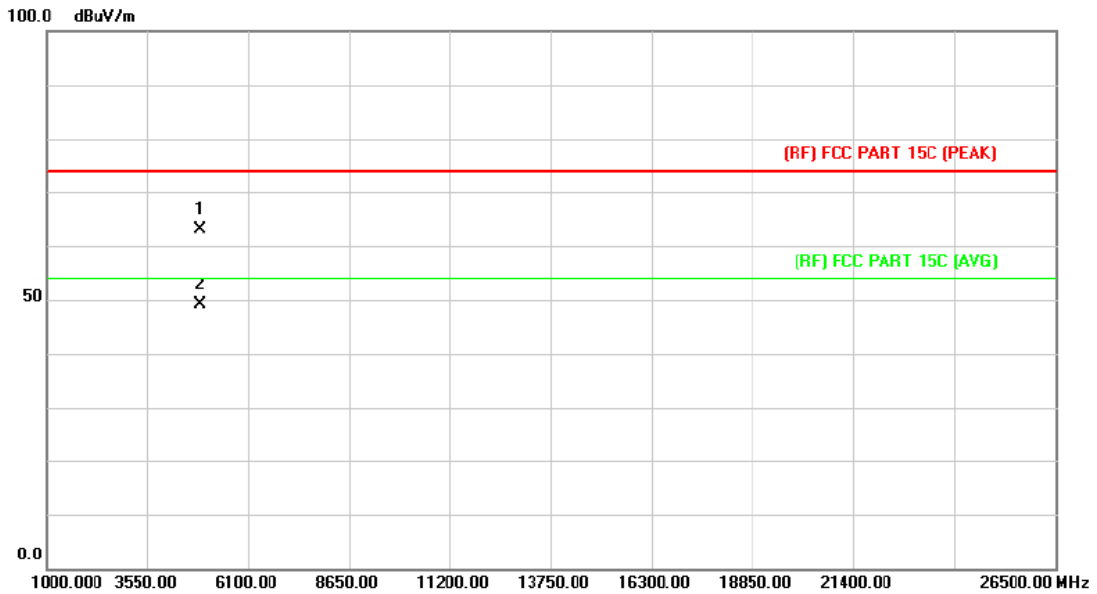

No.	Mk.	Freq. MHz	Reading Level dBuV	Correct Factor dB/m	Measure- ment dBuV/m	Limit dBuV/m	Over dB	Detector
1		4882.560	47.93	15.16	63.09	74.00	-10.91	peak
2	*	4882.658	33.85	15.16	49.01	54.00	-4.99	AVG

Emission Level= Read Level+ Correct Factor

Temperature:	25°C	Relative Humidity:	55%
Test Voltage:	DC 3.7V		
Ant. Pol.	Vertical		
Test Mode:	TX 8-DPSK Mode 2441MHz		
Remark:	No report for the emission which more than 10 dB below the prescribed limit.		

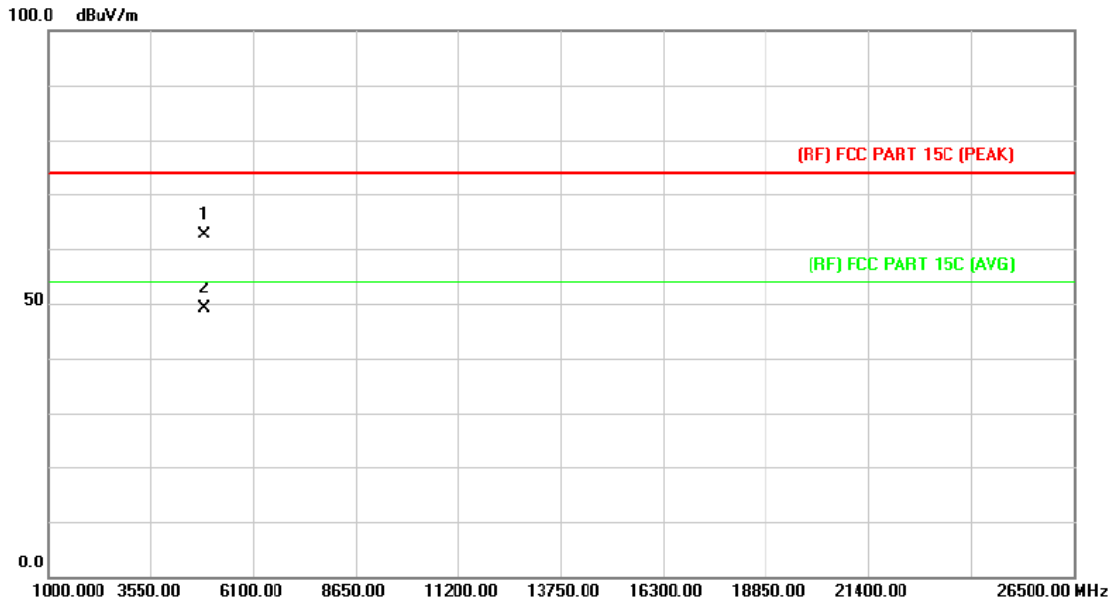

No.	Mk.	Freq. MHz	Reading Level dBuV	Correct Factor dB/m	Measure- ment dBuV/m	Limit dBuV/m	Over dB	Detector
1		4881.970	47.58	15.16	62.74	74.00	-11.26	peak
2	*	4882.616	33.87	15.16	49.03	54.00	-4.97	AVG

Emission Level= Read Level+ Correct Factor

Temperature:	25°C	Relative Humidity:	55%
Test Voltage:	DC 3.7V		
Ant. Pol.	Horizontal		
Test Mode:	TX 8-DPSK Mode 2480MHz		
Remark:	No report for the emission which more than 10 dB below the prescribed limit.		

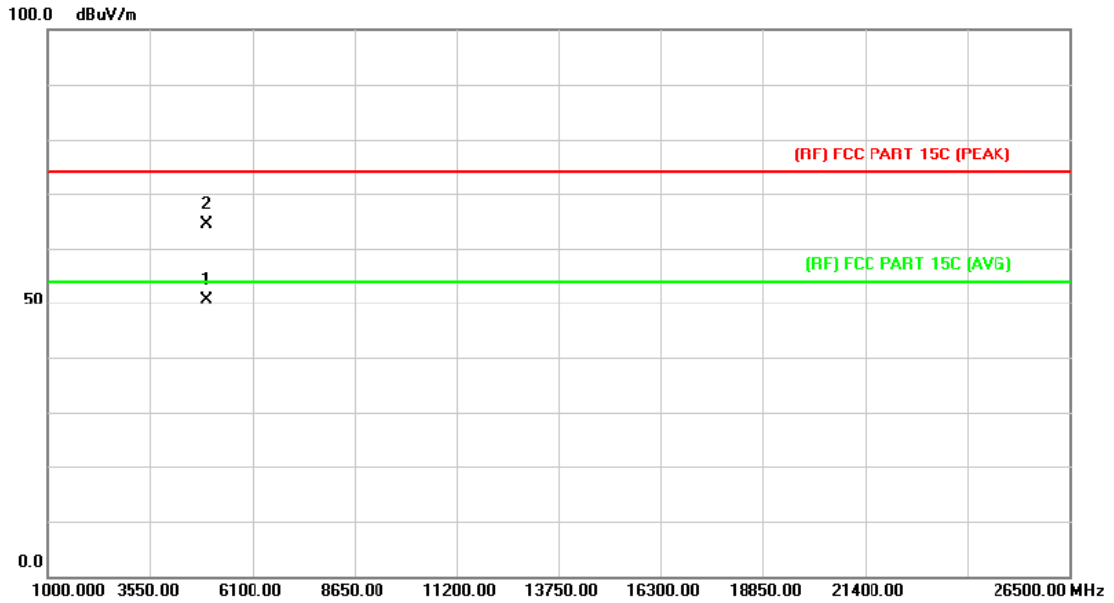

No.	Mk.	Freq. MHz	Reading Level dBuV	Correct Factor dB/m	Measure- ment dBuV/m	Limit dBuV/m	Over dB	Detector
1	*	4959.930	34.82	15.76	50.58	54.00	-3.42	AVG
2		4959.966	48.53	15.76	64.29	74.00	-9.71	peak

Emission Level= Read Level+ Correct Factor

Temperature:	25°C	Relative Humidity:	55%
Test Voltage:	DC 3.7V		
Ant. Pol.	Vertical		
Test Mode:	TX 8-DPSK Mode 2480MHz		
Remark:	No report for the emission which more than 10 dB below the prescribed limit.		

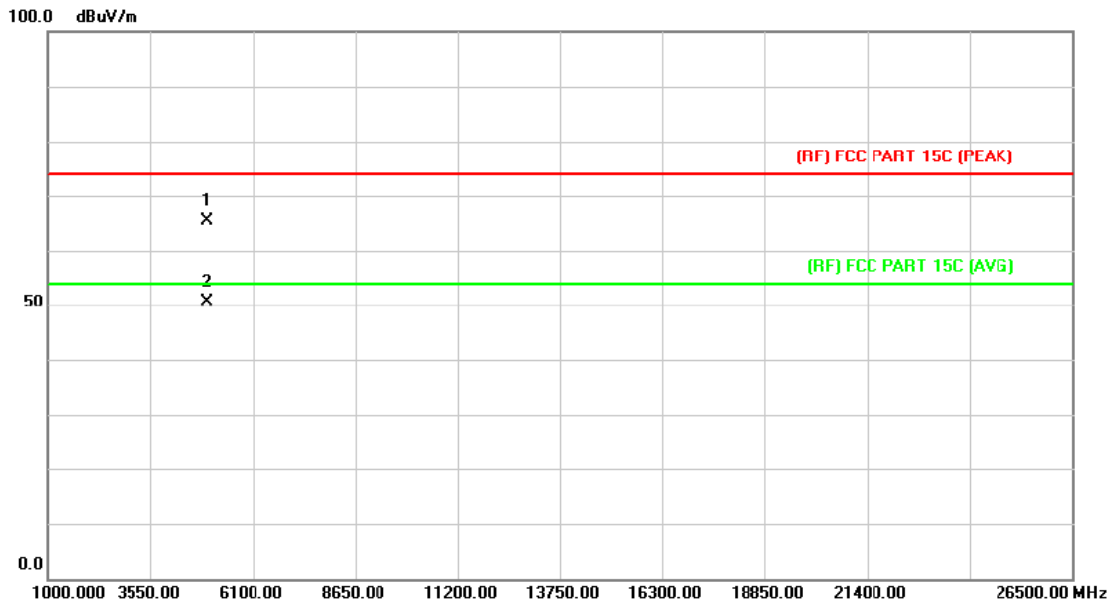

No.	Mk.	Freq. MHz	Reading Level dBuV	Correct Factor dB/m	Measure- ment dBuV/m	Limit dBuV/m	Over dB	Detector
1		4959.784	49.61	15.76	65.37	74.00	-8.63	peak
2	*	4960.050	34.83	15.76	50.59	54.00	-3.41	AVG

Emission Level= Read Level+ Correct Factor

Attachment C-- Restricted Bands Requirement Test Data

(1) Radiation Test

Temperature:	25°C	Relative Humidity:	55%
Test Voltage:	DC 3.7V		
Ant. Pol.	Horizontal		
Test Mode:	TX GFSK Mode 2402MHz		
Remark:	Only worse case is reported		

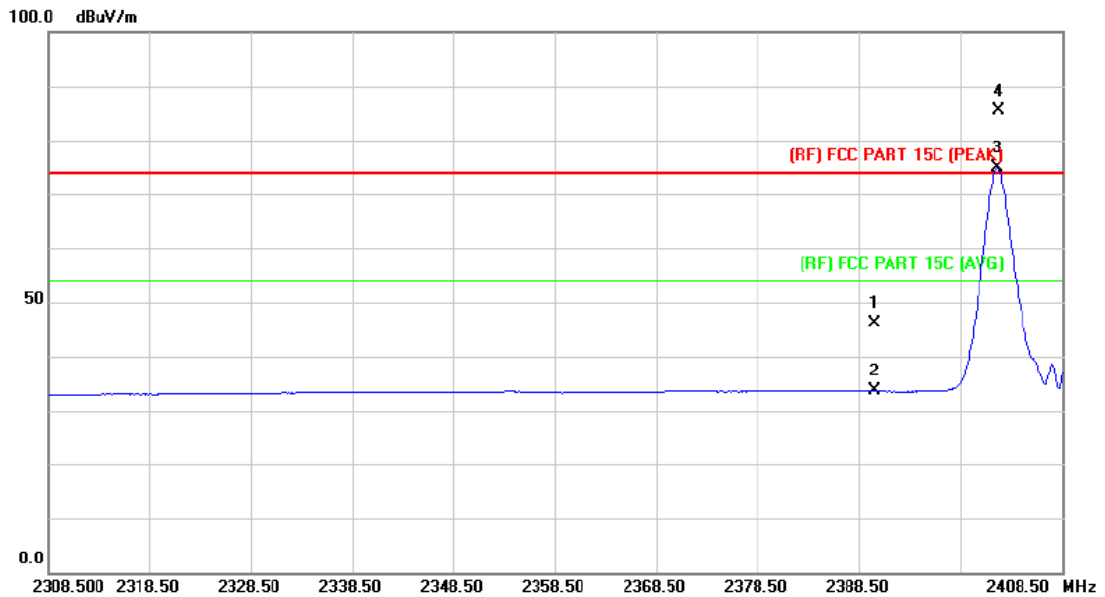

No.	Mk.	Freq. MHz	Reading Level dBuV	Correct Factor dB/m	Measure- ment dBuV/m	Limit dBuV/m	Over dB	Detector
1		2390.000	45.11	0.97	46.08	74.00	-27.92	peak
2		2390.000	32.69	0.97	33.66	54.00	-20.34	AVG
3	*	2402.200	73.86	1.03	74.89	Fundamental Frequency		AVG
4	X	2402.300	84.32	1.03	85.35	Fundamental Frequency		peak

Emission Level= Read Level+ Correct Factor

Temperature:	25°C	Relative Humidity:	55%
Test Voltage:	DC 3.7V		
Ant. Pol.	Vertical		
Test Mode:	TX GFSK Mode 2402MHz		
Remark:	Only worse case is reported		

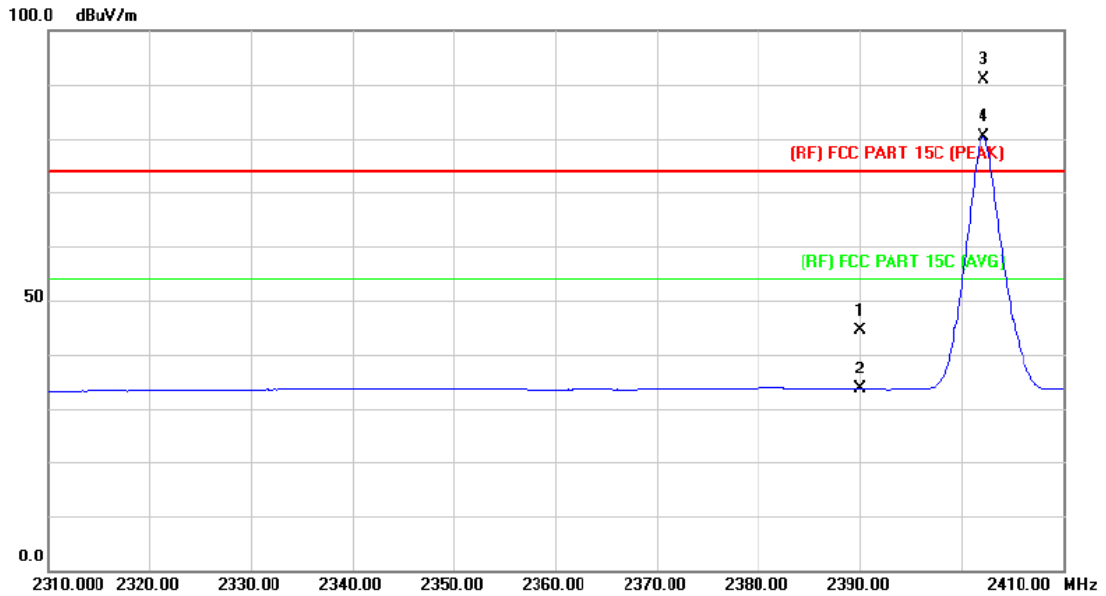

No.	Mk.	Freq. MHz	Reading Level dBuV	Correct Factor dB/m	Measure- ment dBuV/m	Limit dBuV/m	Over dB	Detector
1		2390.000	43.34	0.97	44.31	74.00	-29.69	peak
2		2390.000	32.71	0.97	33.68	54.00	-20.32	AVG
3	X	2402.200	89.89	1.03	90.92	Fundamental Frequency		peak
4	*	2402.200	79.28	1.03	80.31	Fundamental Frequency		AVG

Emission Level= Read Level+ Correct Factor

Temperature:	25°C	Relative Humidity:	55%
Test Voltage:	DC 3.7V		
Ant. Pol.	Horizontal		
Test Mode:	TX GFSK Mode 2480 MHz		
Remark:	Only worse case is reported		

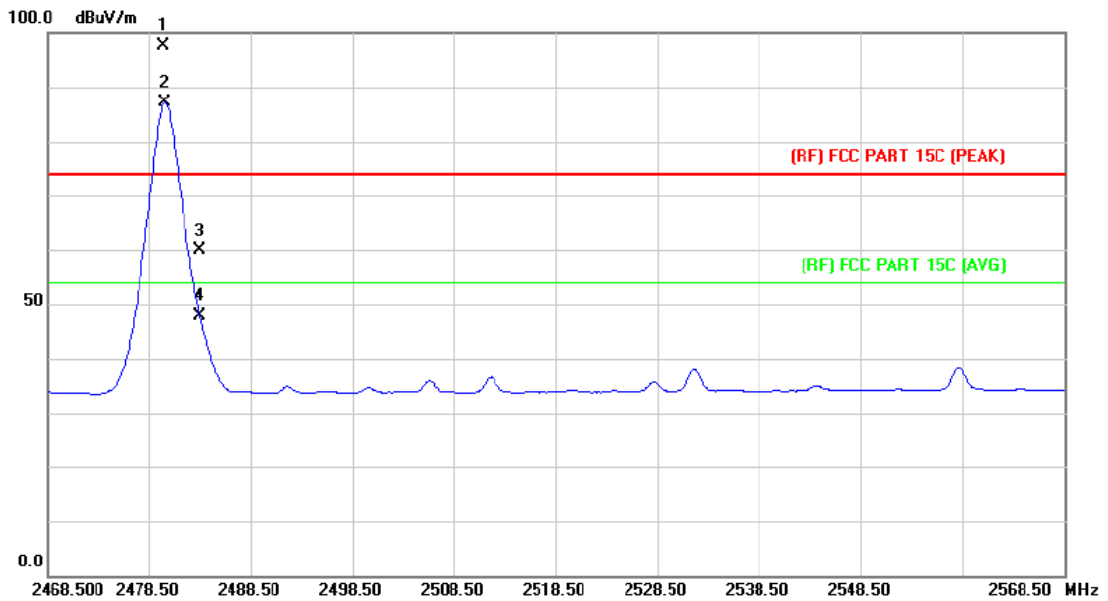

No.	Mk.	Freq. MHz	Reading Level dBuV	Correct Factor dB/m	Measure- ment dBuV/m	Limit dBuV/m	Over dB	Detector
1	X	2479.900	96.30	1.38	97.68	Fundamental Frequency		peak
2	*	2480.100	85.84	1.38	87.22	Fundamental Frequency		AVG
3		2483.500	58.51	1.40	59.91	74.00	-14.09	peak
4		2483.500	46.51	1.40	47.91	54.00	-6.09	AVG

Emission Level= Read Level+ Correct Factor

Temperature:	25°C	Relative Humidity:	55%
Test Voltage:	DC 3.7V		
Ant. Pol.	Vertical		
Test Mode:	TX GFSK Mode 2480 MHz		
Remark:	Only worse case is reported		

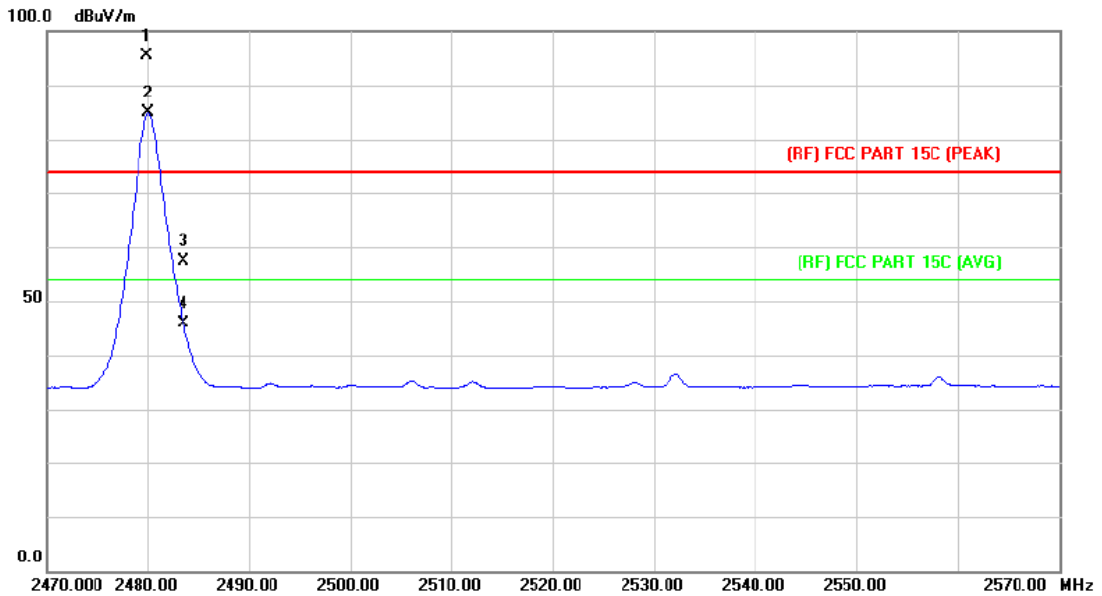

No.	Mk.	Freq.	Reading Level	Correct Factor	Measurement	Limit	Over	Detector
		MHz	dBuV	dB/m	dBuV/m	dBuV/m	dB	
1	X	2479.900	93.92	1.38	95.30	Fundamental Frequency		peak
2	*	2480.100	83.44	1.38	84.82	Fundamental Frequency		AVG
3		2483.500	55.97	1.40	57.37	74.00	-16.63	peak
4		2483.500	44.47	1.40	45.87	54.00	-8.13	AVG

Emission Level= Read Level+ Correct Factor

Temperature:	25°C	Relative Humidity:	55%
Test Voltage:	DC 3.7V		
Ant. Pol.	Horizontal		
Test Mode:	TX π /4-DQPSK Mode 2402MHz		
Remark:	Only worse case is reported		

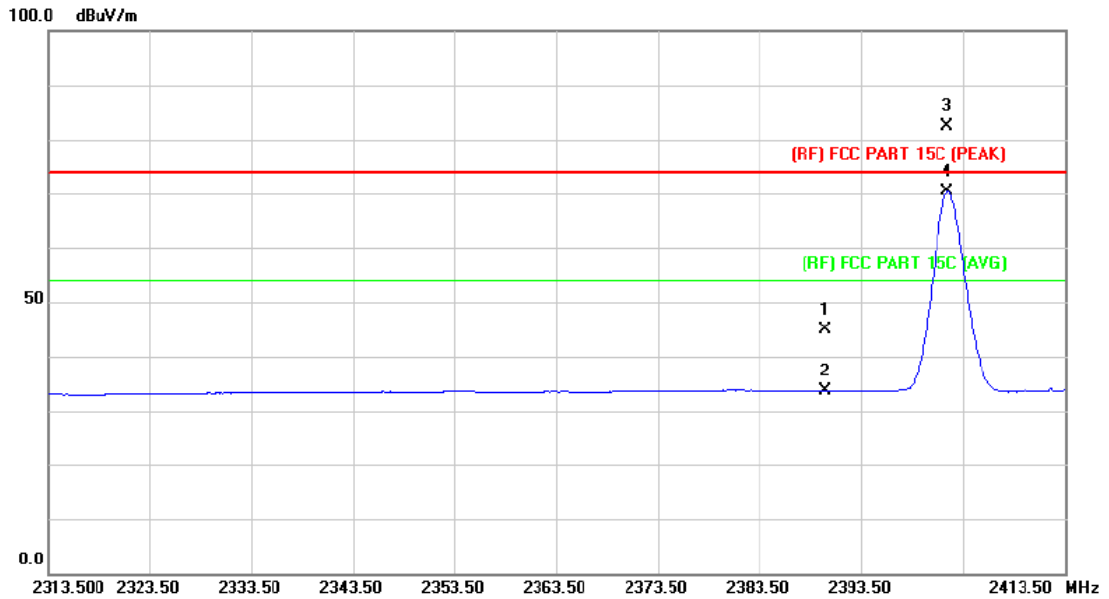

No.	Mk.	Freq. MHz	Reading Level dBuV	Correct Factor dB/m	Measure- ment dBuV/m	Limit dBuV/m	Over dB	Detector
1		2390.000	43.98	0.97	44.95	74.00	-29.05	peak
2		2390.000	32.69	0.97	33.66	54.00	-20.34	AVG
3	X	2402.000	81.46	1.03	82.49	Fundamental Frequency		peak
4	*	2402.000	69.23	1.03	70.26	Fundamental Frequency		AVG

Emission Level= Read Level+ Correct Factor

Temperature:	25°C	Relative Humidity:	55%
Test Voltage:	DC 3.7V		
Ant. Pol.	Vertical		
Test Mode:	TX π /4-DQPSK Mode 2402MHz		
Remark:	Only worse case is reported		

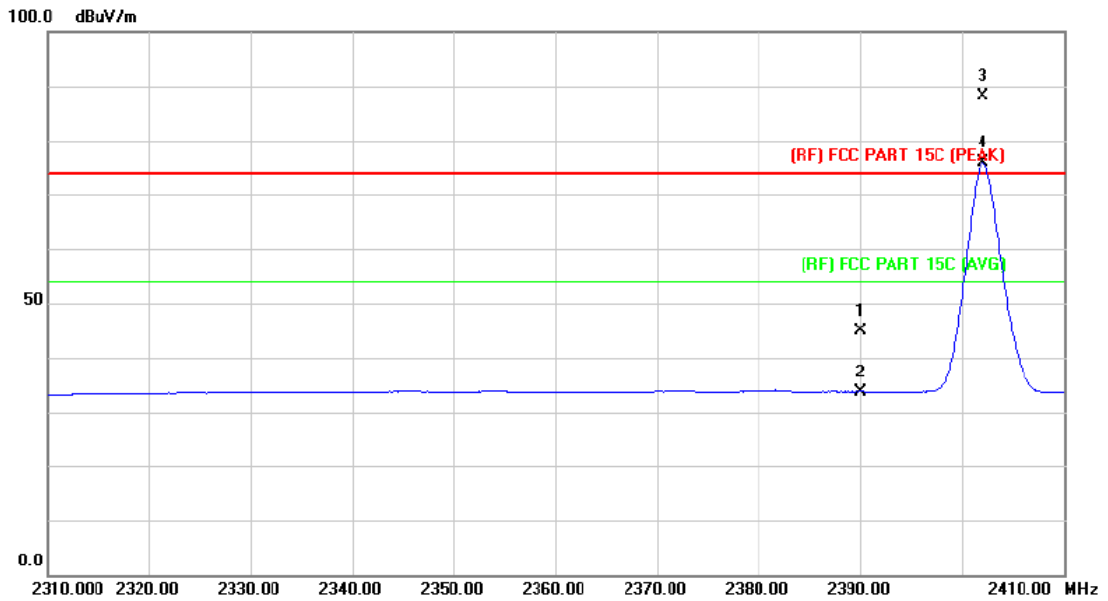

No.	Mk.	Freq. MHz	Reading Level dBuV	Correct Factor dB/m	Measure- ment dBuV/m	Limit dBuV/m	Over dB	Detector
1		2390.000	44.00	0.97	44.97	74.00	-29.03	peak
2		2390.000	32.78	0.97	33.75	54.00	-20.25	AVG
3	X	2402.100	86.98	1.03	88.01	Fundamental Frequency		peak
4	*	2402.100	74.80	1.03	75.83	Fundamental Frequency		AVG

Emission Level= Read Level+ Correct Factor

Temperature:	25°C	Relative Humidity:	55%
Test Voltage:	DC 3.7V		
Ant. Pol.	Horizontal		
Test Mode:	TX π /4-DQPSK Mode 2480MHz		
Remark:	Only worse case is reported		

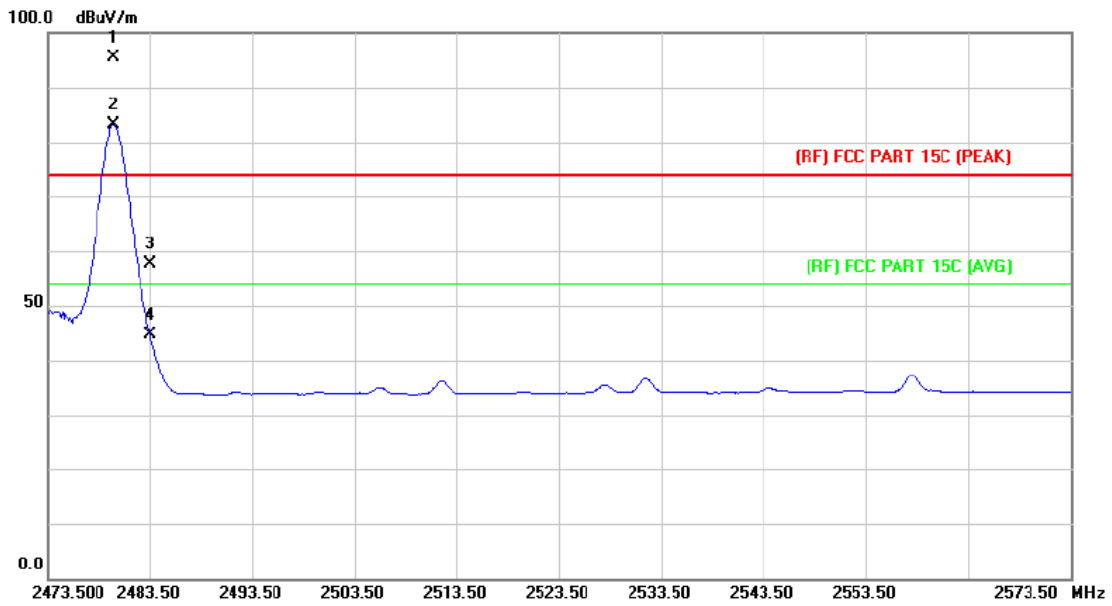

No.	Mk.	Freq. MHz	Reading Level dBuV	Correct Factor dB/m	Measure- ment dBuV/m	Limit dBuV/m	Over dB	Detector
1	X	2479.900	94.05	1.38	95.43	Fundamental Frequency		peak
2	*	2480.000	81.82	1.38	83.20	Fundamental Frequency		AVG
3		2483.500	56.12	1.40	57.52	74.00	-16.48	peak
4		2483.500	43.30	1.40	44.70	54.00	-9.30	AVG

Emission Level= Read Level+ Correct Factor

Temperature:	25°C	Relative Humidity:	55%
Test Voltage:	DC 3.7V		
Ant. Pol.	Vertical		
Test Mode:	TX π /4-DQPSK Mode 2480MHz		
Remark:	Only worse case is reported		

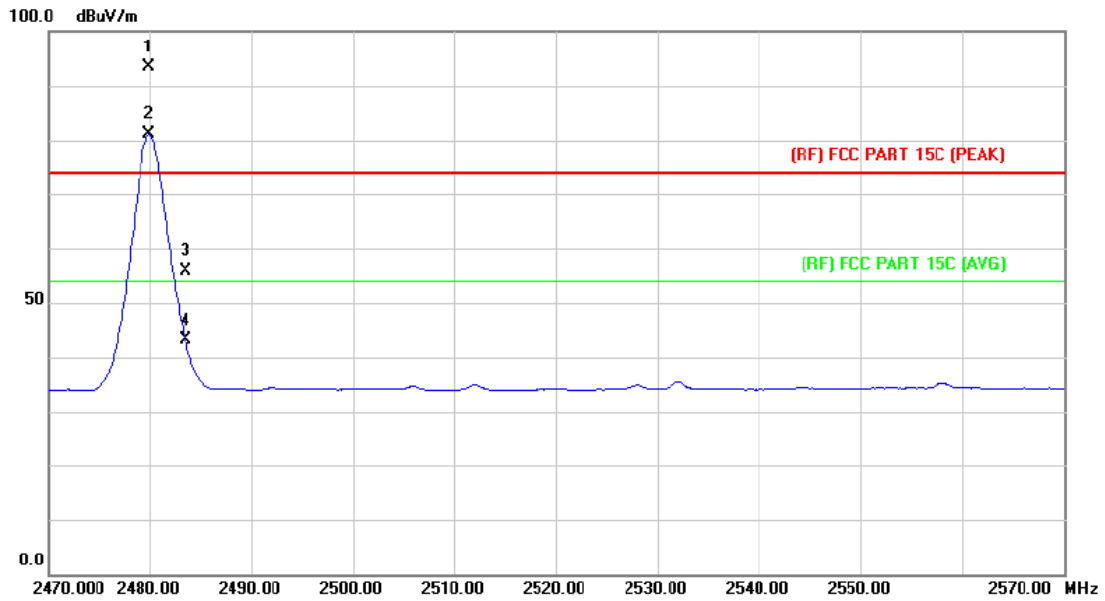

No.	Mk.	Freq. MHz	Reading Level dBuV	Correct Factor dB/m	Measure- ment dBuV/m	Limit dBuV/m	Over dB	Detector
1	X	2479.900	91.97	1.38	93.35	Fundamental Frequency		peak
2	*	2479.900	79.70	1.38	81.08	Fundamental Frequency		AVG
3		2483.500	54.39	1.40	55.79	74.00	-18.21	peak
4		2483.500	41.65	1.40	43.05	54.00	-10.95	AVG

Emission Level= Read Level+ Correct Factor

Temperature:	25°C	Relative Humidity:	55%
Test Voltage:	DC 3.7V		
Ant. Pol.	Horizontal		
Test Mode:	TX 8-DPSK Mode 2402MHz		
Remark:	Only worse case is reported		

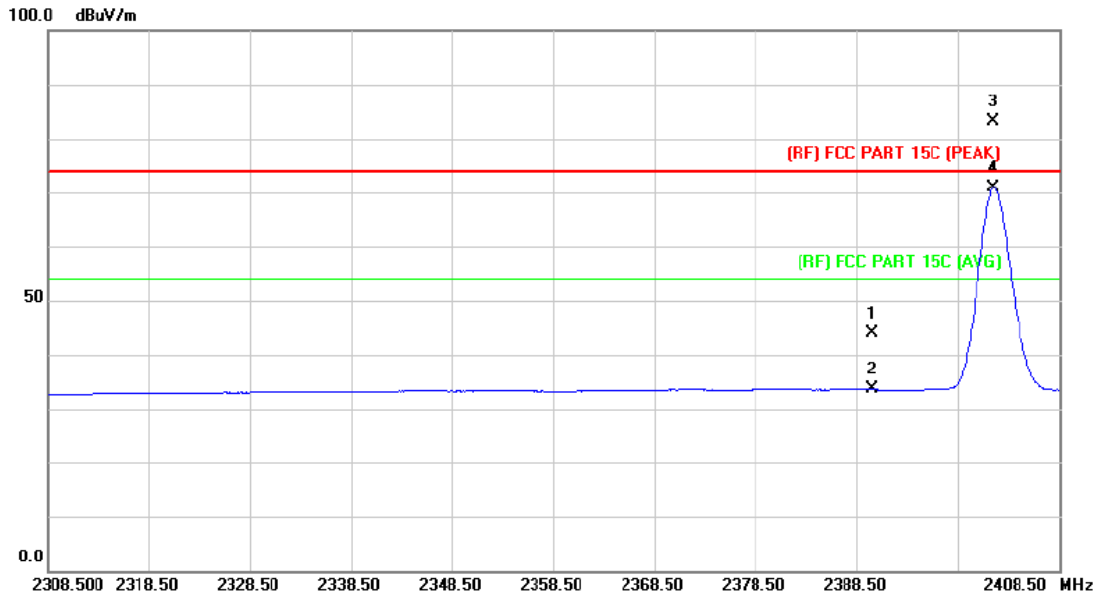

No.	Mk.	Freq. MHz	Reading Level dBuV	Correct Factor dB/m	Measure- ment dBuV/m	Limit dBuV/m	Over dB	Detector
1		2390.000	42.98	0.97	43.95	74.00	-30.05	peak
2		2390.000	32.59	0.97	33.56	54.00	-20.44	AVG
3	X	2402.000	82.14	1.03	83.17	Fundamental Frequency		peak
4	*	2402.100	69.89	1.03	70.92	Fundamental Frequency		AVG

Emission Level= Read Level+ Correct Factor

Temperature:	25°C	Relative Humidity:	55%
Test Voltage:	DC 3.7V		
Ant. Pol.	Vertical		
Test Mode:	TX 8-DPSK Mode 2402MHz		
Remark:	Only worse case is reported		

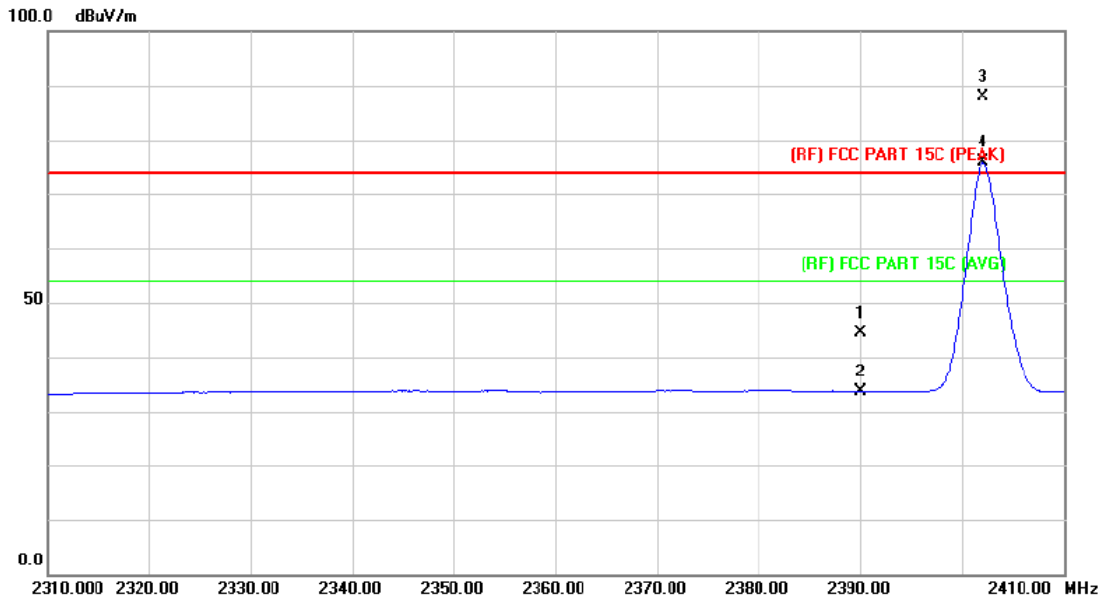

No.	Mk.	Freq. MHz	Reading Level dBuV	Correct Factor dB/m	Measure- ment dBuV/m	Limit dBuV/m	Over dB	Detector
1		2390.000	43.33	0.97	44.30	74.00	-29.70	peak
2		2390.000	32.75	0.97	33.72	54.00	-20.28	AVG
3	X	2402.000	86.91	1.03	87.94	Fundamental Frequency		peak
4	*	2402.100	74.74	1.03	75.77	Fundamental Frequency		AVG

Emission Level= Read Level+ Correct Factor

Temperature:	25°C	Relative Humidity:	55%
Test Voltage:	DC 3.7V		
Ant. Pol.	Horizontal		
Test Mode:	TX 8-DPSK Mode 2480MHz		
Remark:	Only worse case is reported		

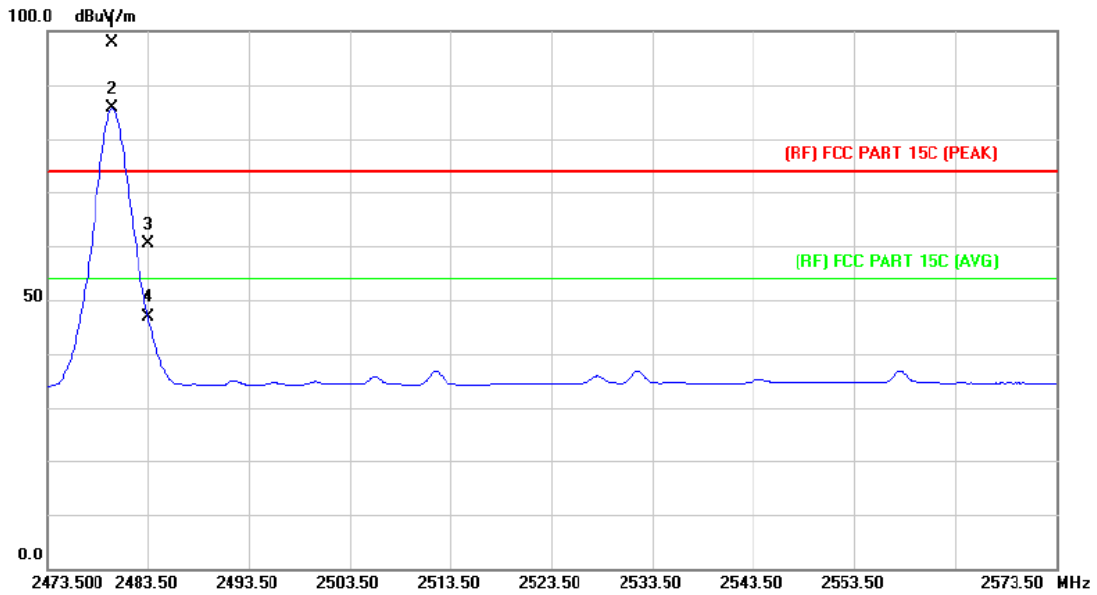

No.	Mk.	Freq. MHz	Reading Level dBuV	Correct Factor dB/m	Measure- ment dBuV/m	Limit dBuV/m	Over dB	Detector
1	X	2479.900	96.48	1.38	97.86	Fundamental Frequency		peak
2	*	2480.000	84.24	1.38	85.62	Fundamental Frequency		AVG
3		2483.500	58.96	1.40	60.36	74.00	-13.64	peak
4		2483.500	45.57	1.40	46.97	54.00	-7.03	AVG

Emission Level= Read Level+ Correct Factor

Temperature:	25°C	Relative Humidity:	55%
Test Voltage:	DC 3.7V		
Ant. Pol.	Vertical		
Test Mode:	TX 8-DPSK Mode 2480MHz		
Remark:	Only worse case is reported		

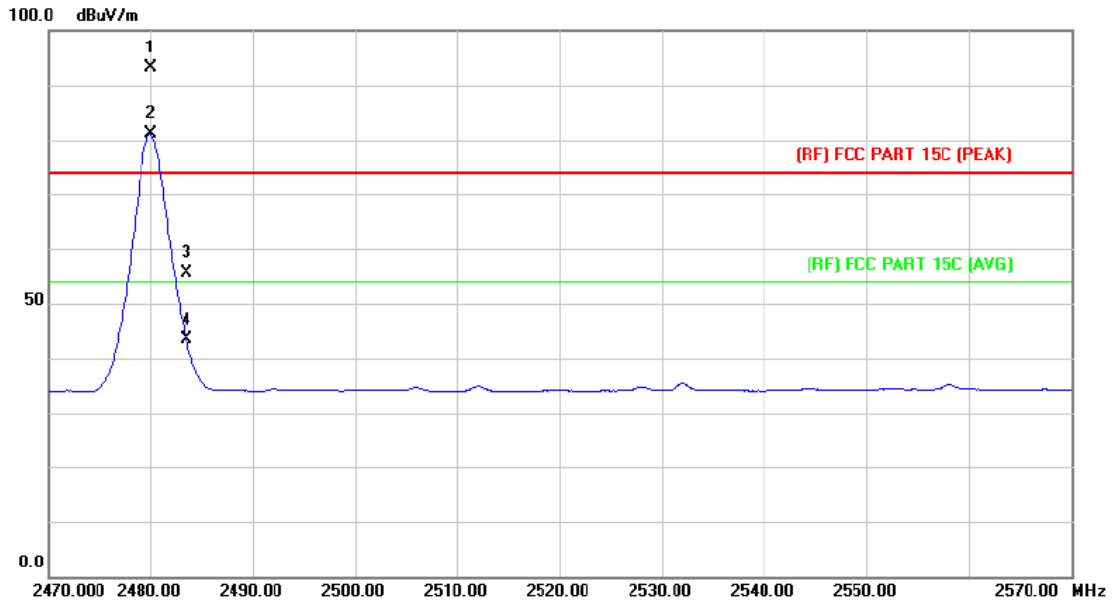

No.	Mk.	Freq. MHz	Reading Level dBuV	Correct Factor dB/m	Measure- ment dBuV/m	Limit dBuV/m	Over dB	Detector
1	X	2480.000	91.78	1.38	93.16	Fundamental Frequency		peak
2	*	2480.000	79.66	1.38	81.04	Fundamental Frequency		AVG
3		2483.500	54.29	1.40	55.69	74.00	-18.31	peak
4		2483.500	41.95	1.40	43.35	54.00	-10.65	AVG

Emission Level= Read Level+ Correct Factor

(2) Conducted Test

Temperature:	25°C	Relative Humidity:	55%
Test Voltage:	DC 3.7V		
Test Mode:	TX GFSK Mode 2402MHz/2480 MHz		
Remark:	Only worse case is reported		

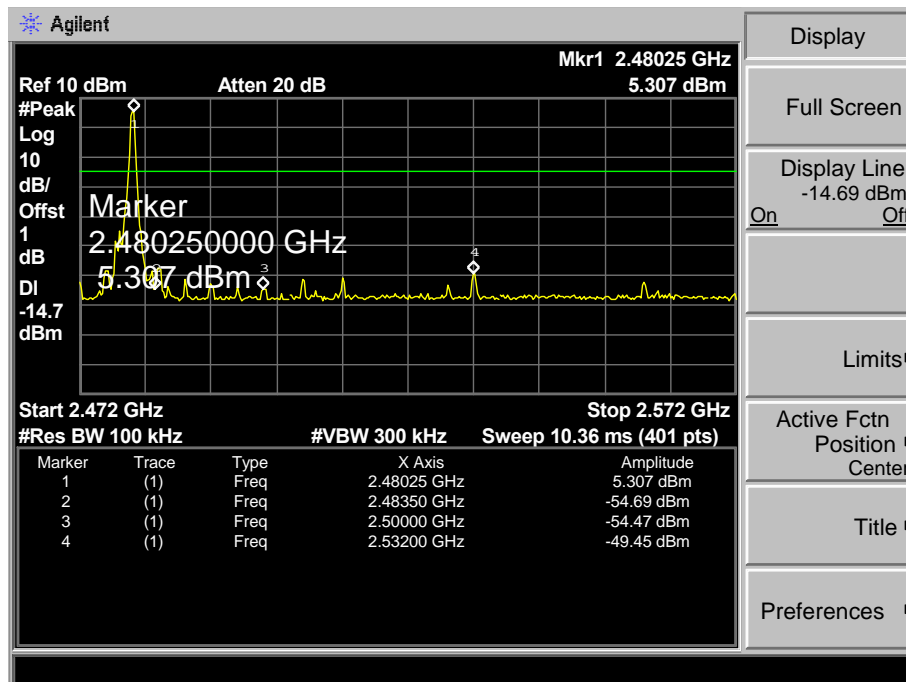
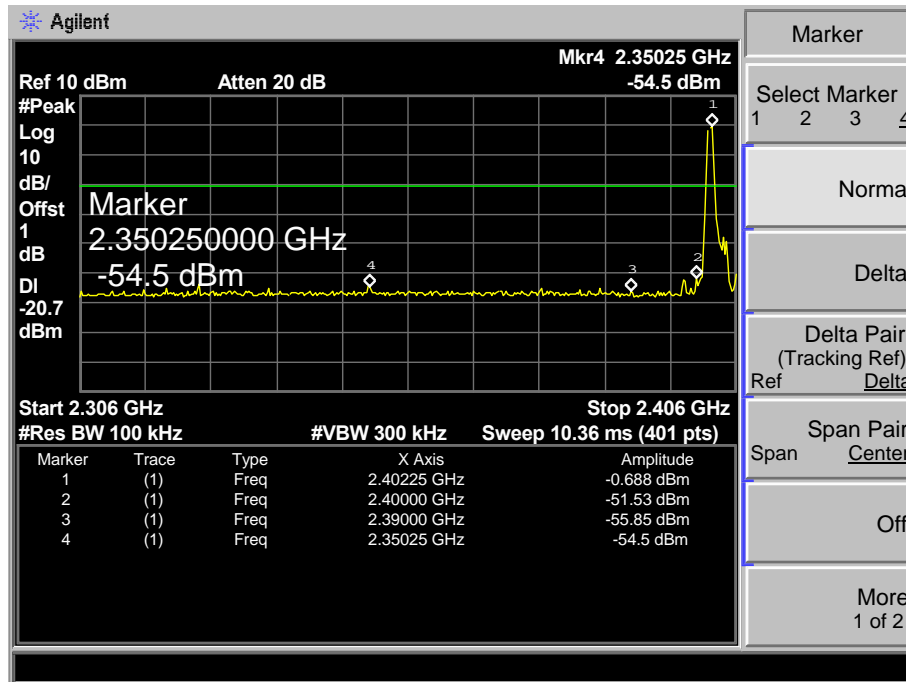

Temperature:	25°C	Relative Humidity:	55%
Test Voltage:	DC 3.7V		
Test Mode:	GFSK Hopping Mode		
Remark:	Only worse case is reported		

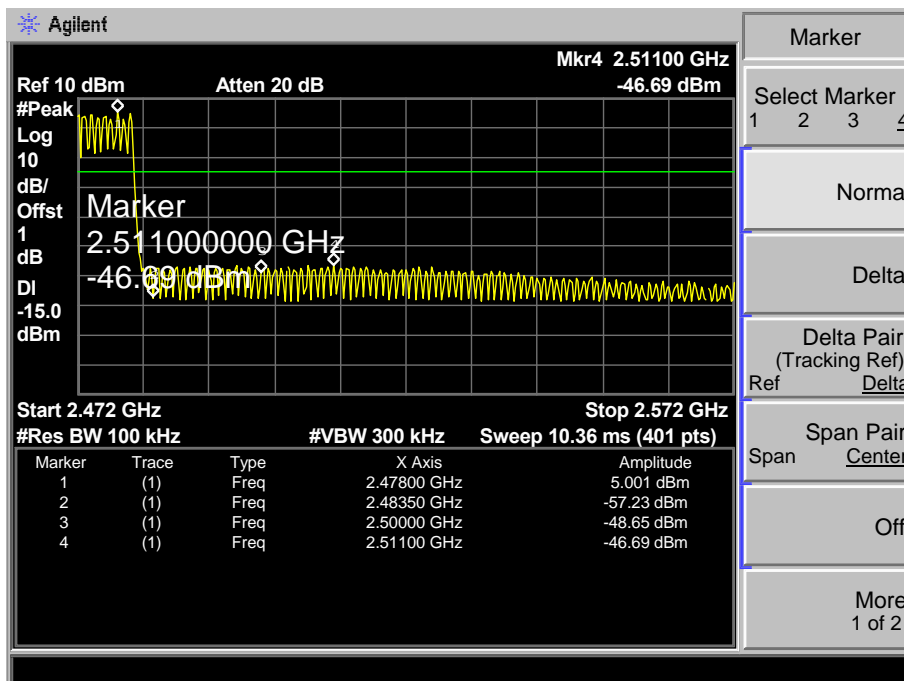
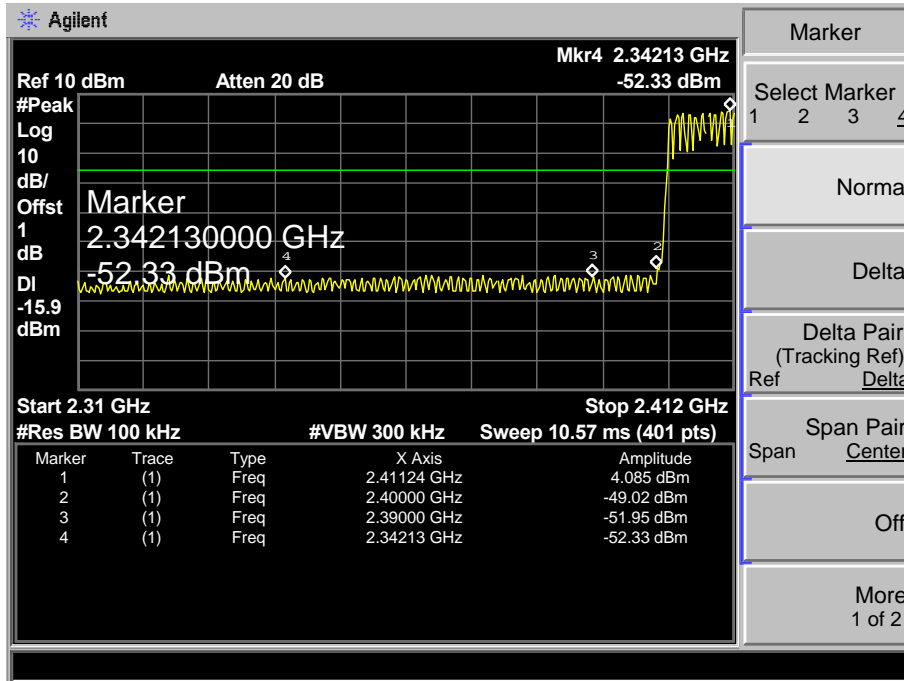

Temperature:	25°C	Relative Humidity:	55%
Test Voltage:	DC 3.7V		
Test Mode:	TX π /4-DQPSK Mode 2402MHz/2480 MHz		
Remark:	Only worse case is reported		

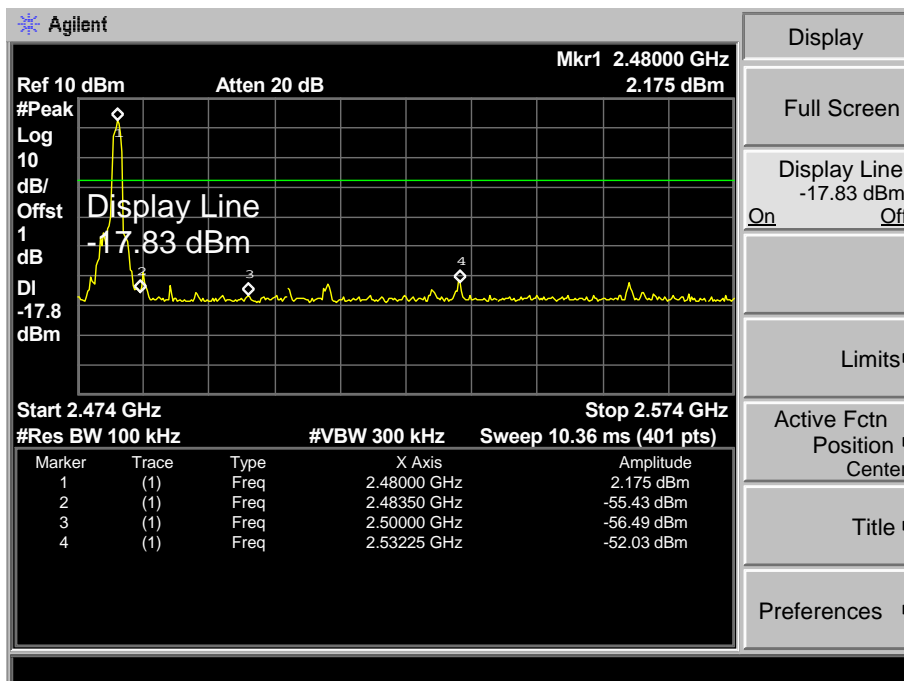
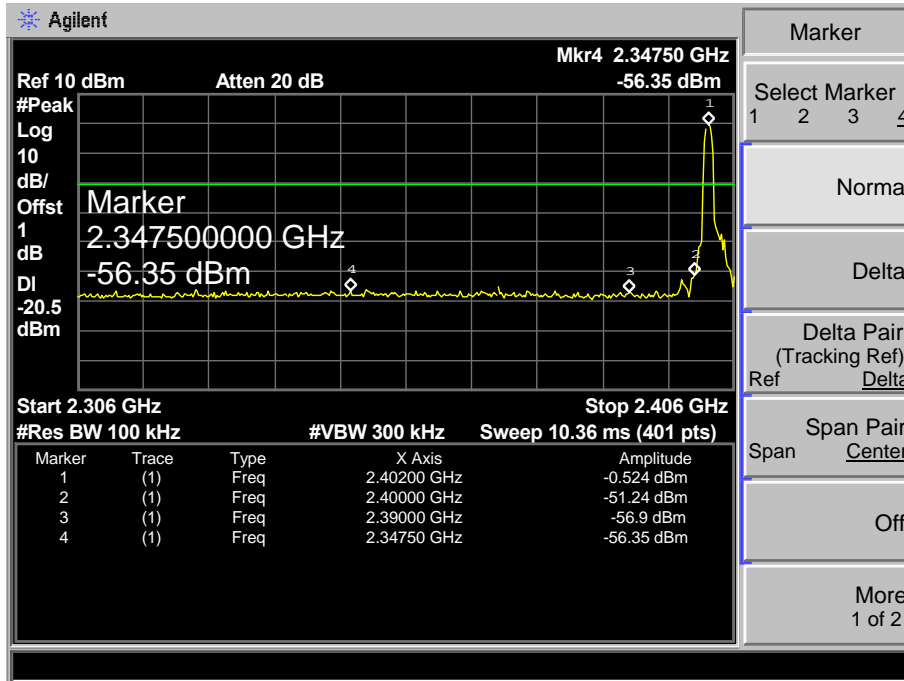

Temperature:	25°C	Relative Humidity:	55%
Test Voltage:	DC 3.7V		
Test Mode:	π /4-DQPSK Hopping Mode		
Remark:	Only worse case is reported		

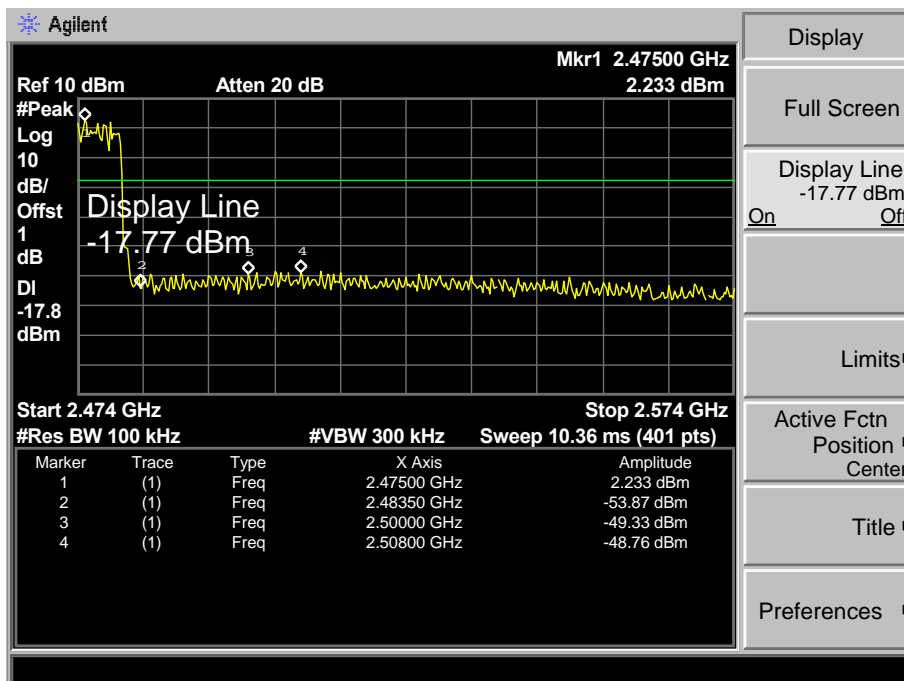
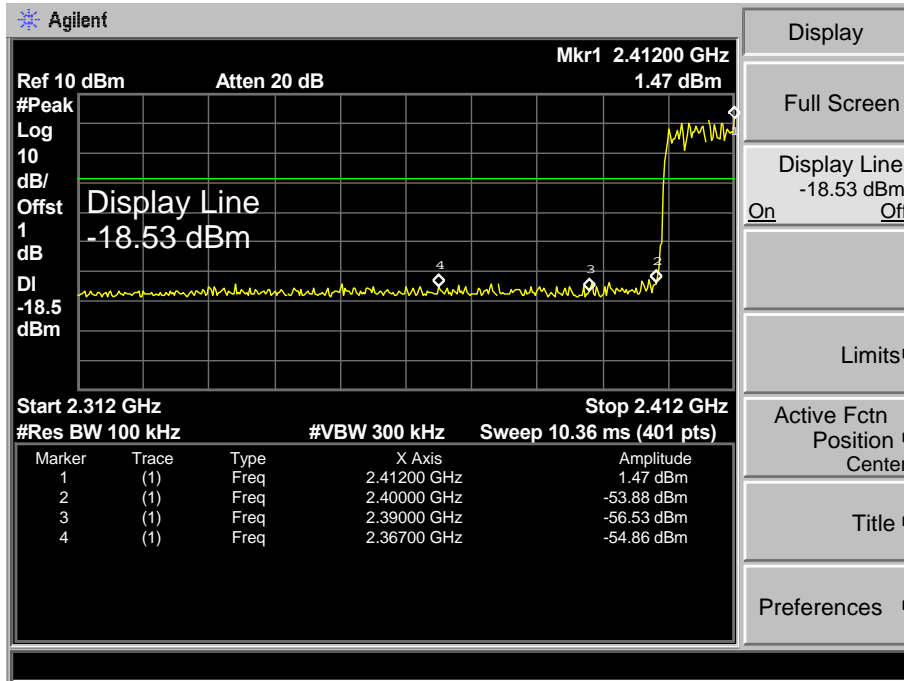

Temperature:	25°C	Relative Humidity:	55%
Test Voltage:	DC 3.7V		
Test Mode:	TX 8-DPSK Mode 2402MHz/2480 MHz		
Remark:	Only worse case is reported		

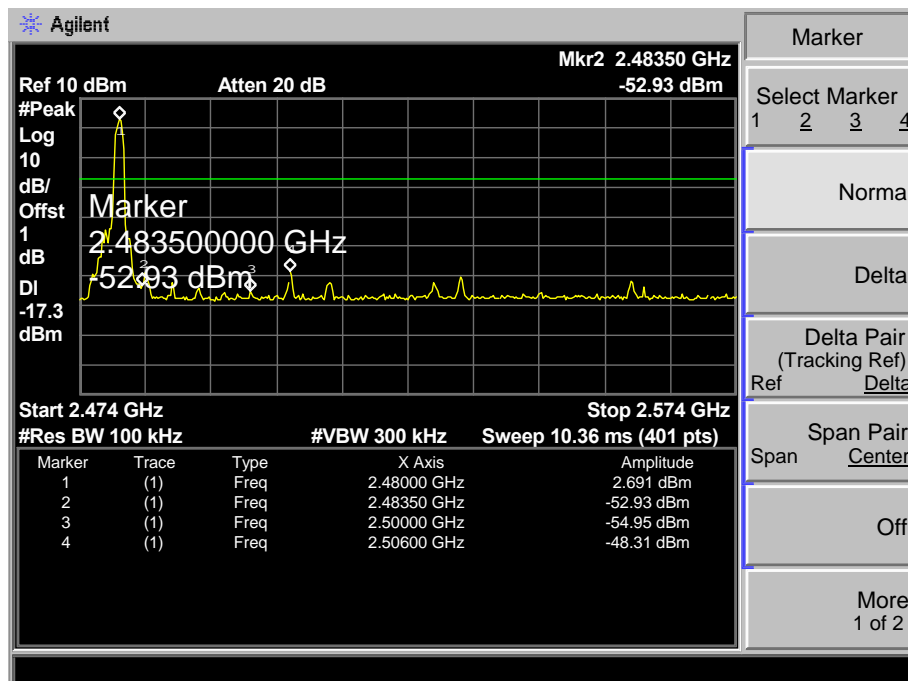
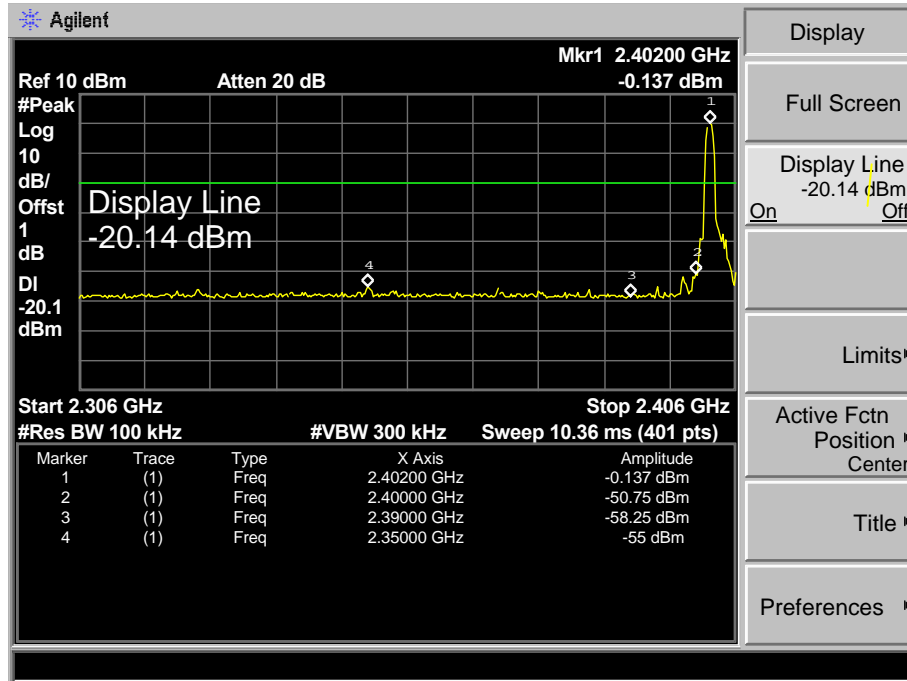

Temperature:	25°C	Relative Humidity:	55%
Test Voltage:	DC 3.7V		
Test Mode:	8-DPSK Hopping Mode		
Remark:	Only worse case is reported		

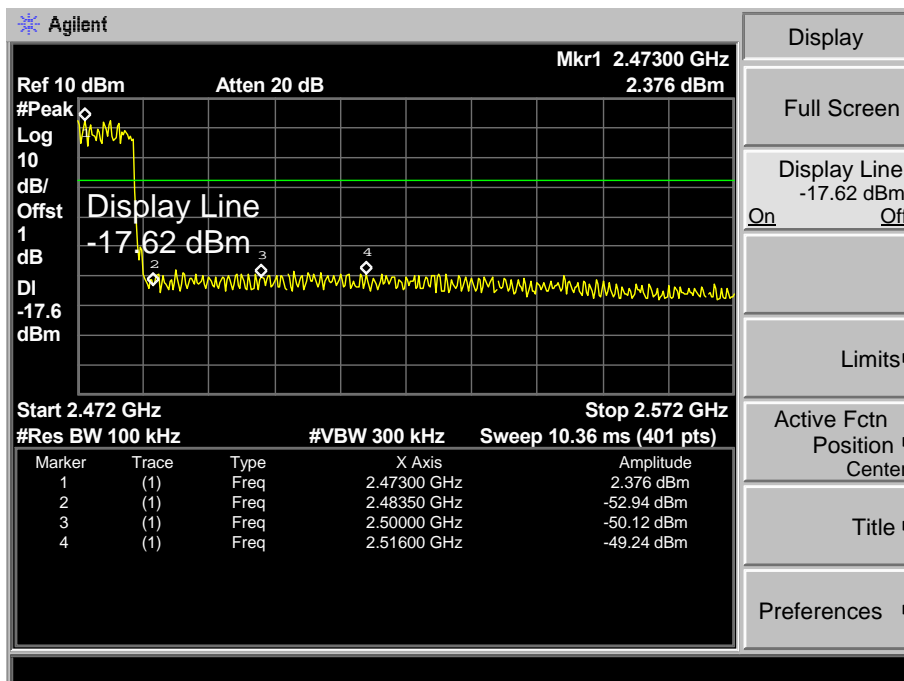
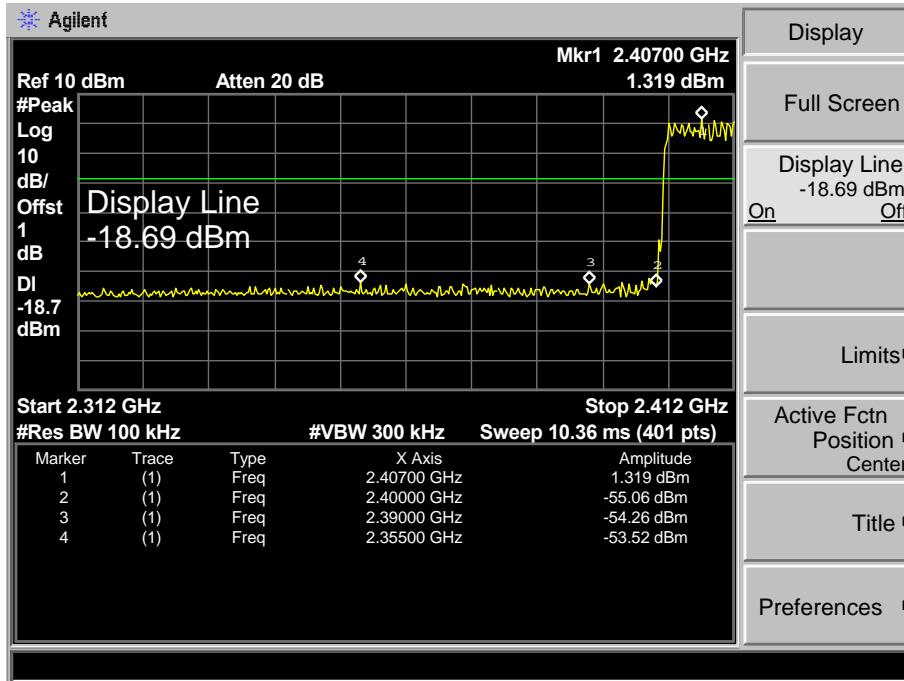

Attachment D-- Number of Hopping Channel Test Data

Temperature:	25°C	Relative Humidity:	55%
Test Voltage:	DC 3.7V		
Test Mode:	Hopping Mode		
Frequency Range	Test Mode	Quantity of Hopping Channel	Limit
2402MHz~2480MHz	GFSK	79	>15
	$\pi/4$ -DQPSK	79	
	8-DPSK	79	

GFSK Mode

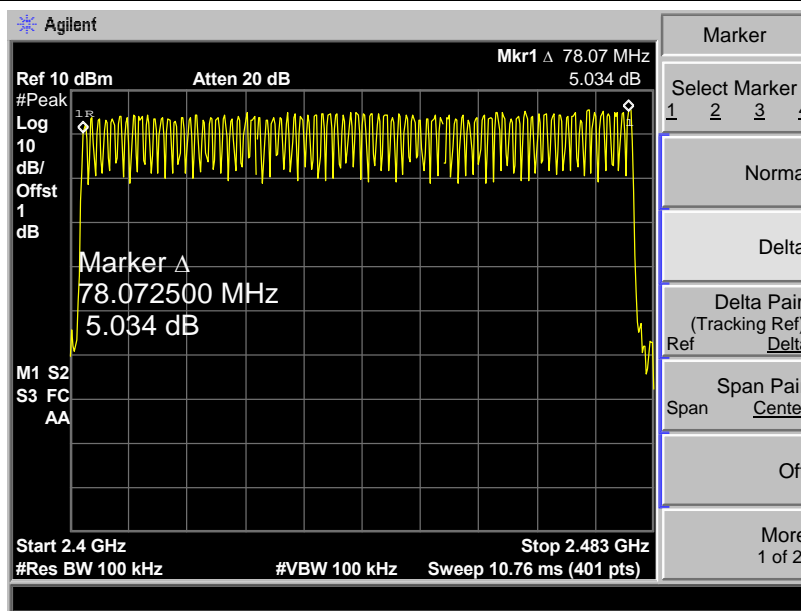

$\pi/4$ -DQPSK Mode

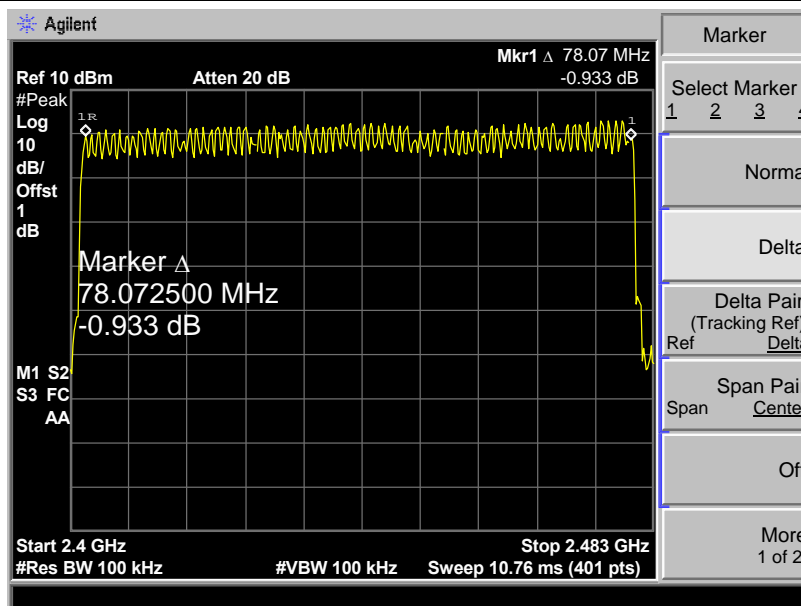

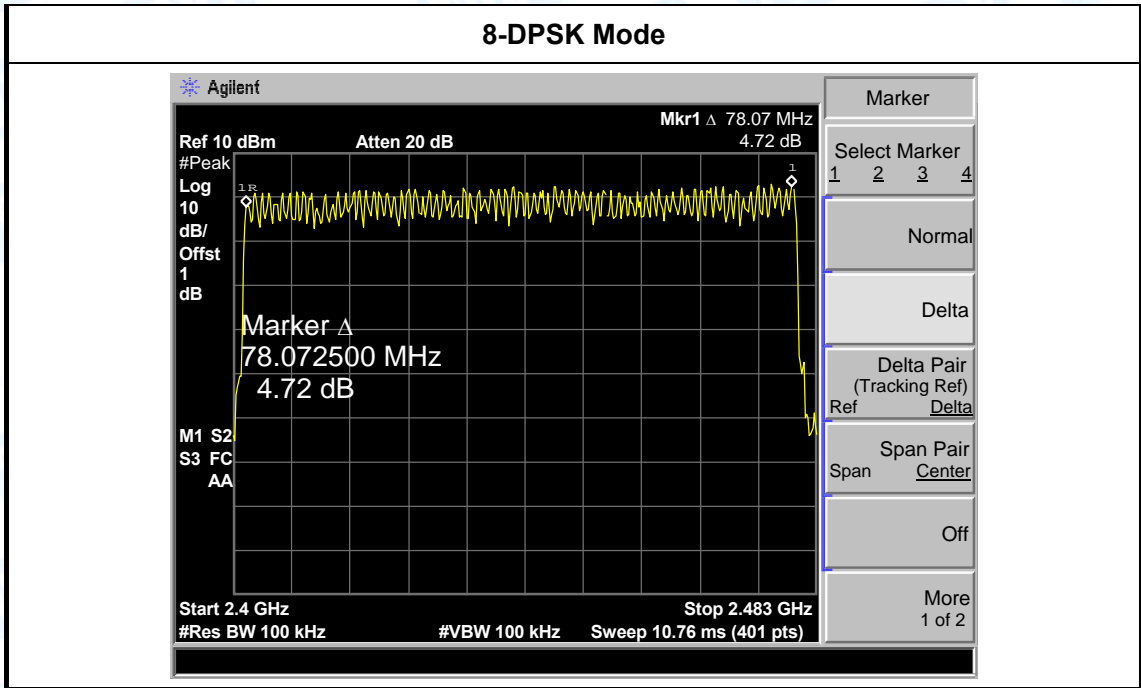

Attachment E-- Average Time of Occupancy Test Data

Temperature:		25°C		Relative Humidity:		55%	
Test Voltage:		DC 3.7V					
Test Mode:		Hopping Mode (GFSK)					
Test Mode	Channel (MHz)	Pulse Time (ms)	Total of Dwell (ms)	Period Time (s)	Limit (ms)	Result	
1DH1	2441	0.45	144.00	31.60	400	PASS	
1DH3	2441	1.71	273.60	31.60	400	PASS	
1DH5	2441	2.94	313.60	31.60	400	PASS	

1DH1 Total of Dwell= Pulse Time*(1600/2)*31.6/79

1DH3 Total of Dwell= Pulse Time*(1600/4)*31.6/79

1DH5 Total of Dwell= Pulse Time*(1600/6)*31.6/79

GFSK Hopping Mode 1DH1

2441 MHz

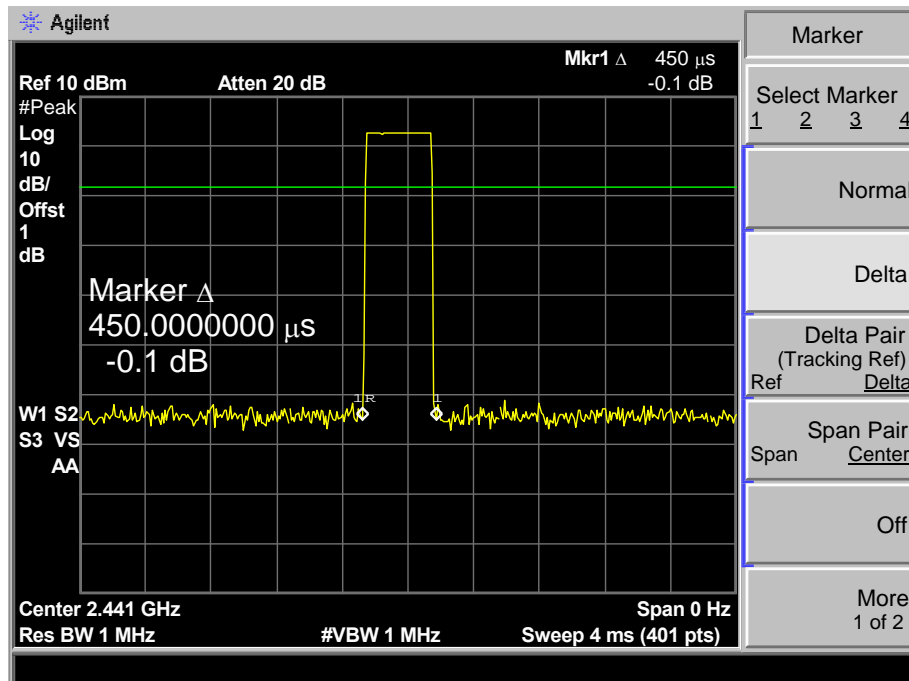

GFSK Hopping Mode 1DH3

2441 MHz

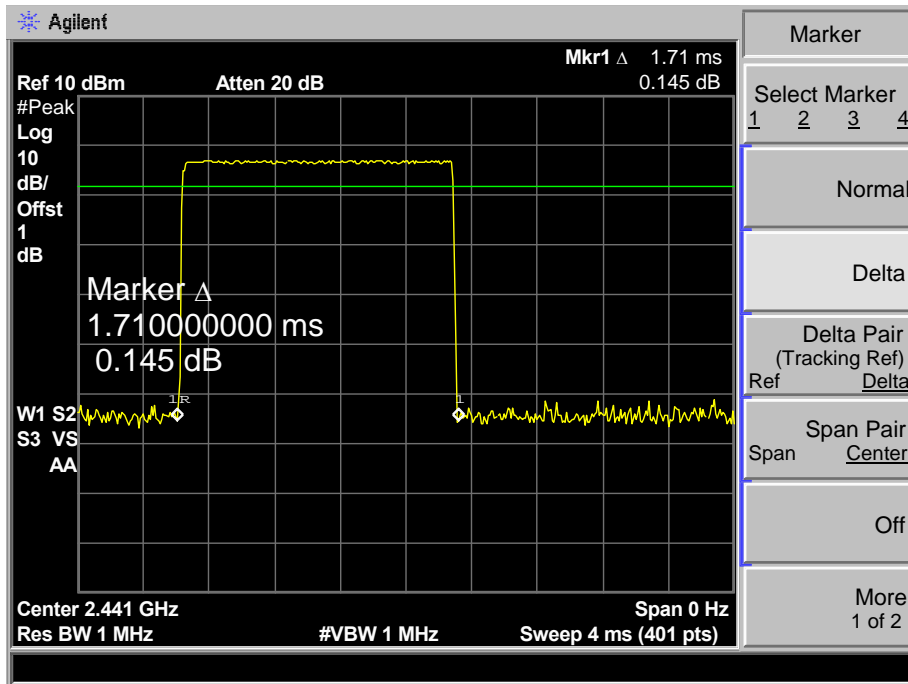

GFSK Hopping Mode 1DH5

2441 MHz

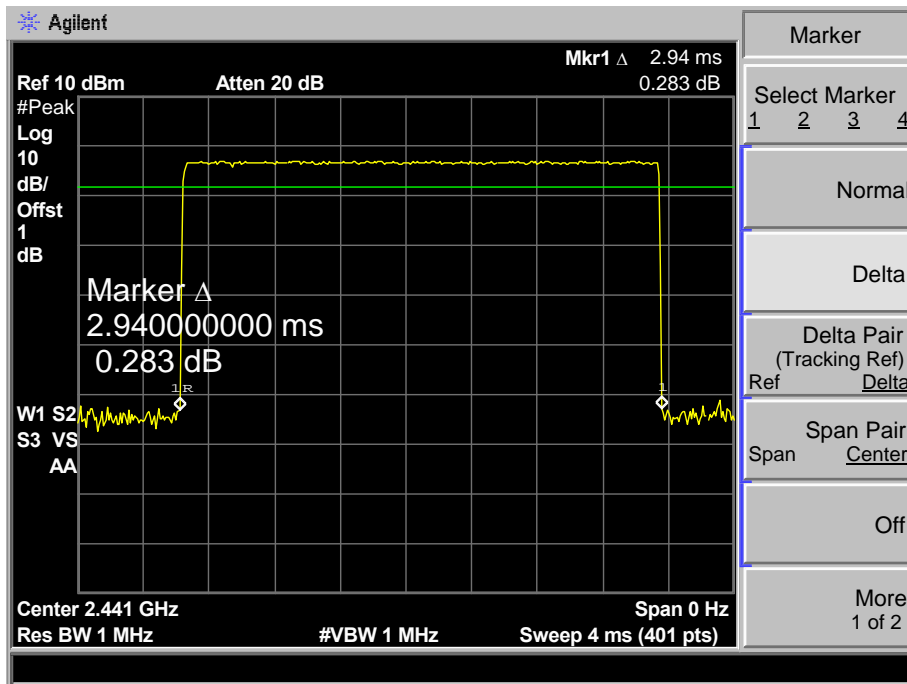

Temperature:		25°C		Relative Humidity:		55%	
Test Voltage:		DC 3.7V					
Test Mode:		Hopping Mode (π /4-DQPSK)					
Test Mode	Channel (MHz)	Pulse Time (ms)	Total of Dwell (ms)	Period Time (s)	Limit (ms)	Result	
2DH1	2441	0.47	150.40	31.60	400	PASS	
2DH3	2441	1.70	272.00	31.60	400	PASS	
2DH5	2441	2.95	314.67	31.60	400	PASS	
2DH1 Total of Dwell= Pulse Time*(1600/2)*31.6/79 2DH3 Total of Dwell= Pulse Time*(1600/4)*31.6/79 2DH5 Total of Dwell= Pulse Time*(1600/6)*31.6/79							
π /4-DQPSK Hopping Mode 2DH1							
2441 MHz							

$\pi/4$ -DQPSK Hopping Mode 2DH3

2441 MHz

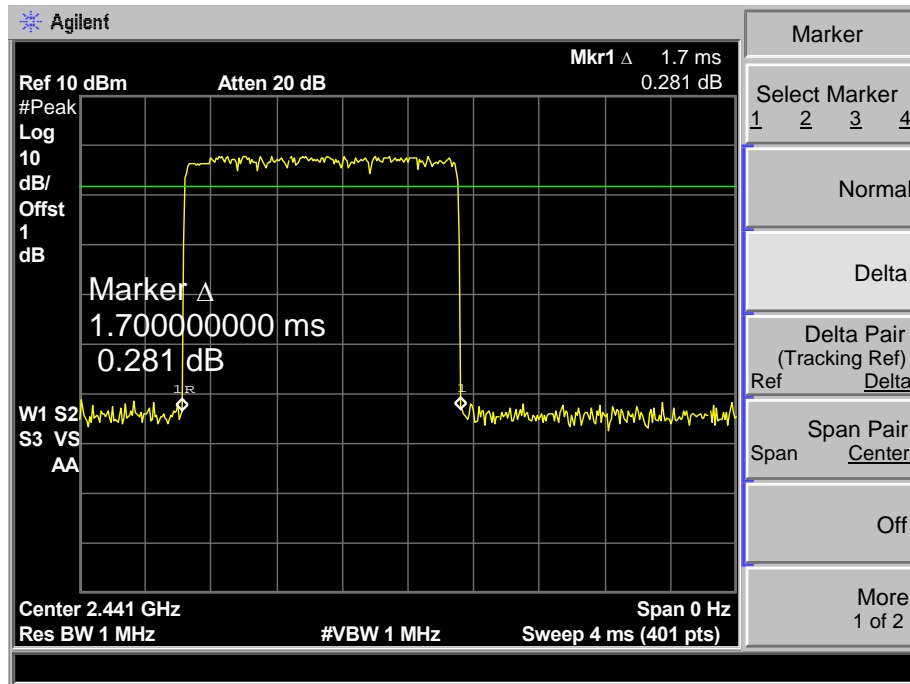

$\pi/4$ -DQPSK Hopping Mode 2DH5

2441 MHz

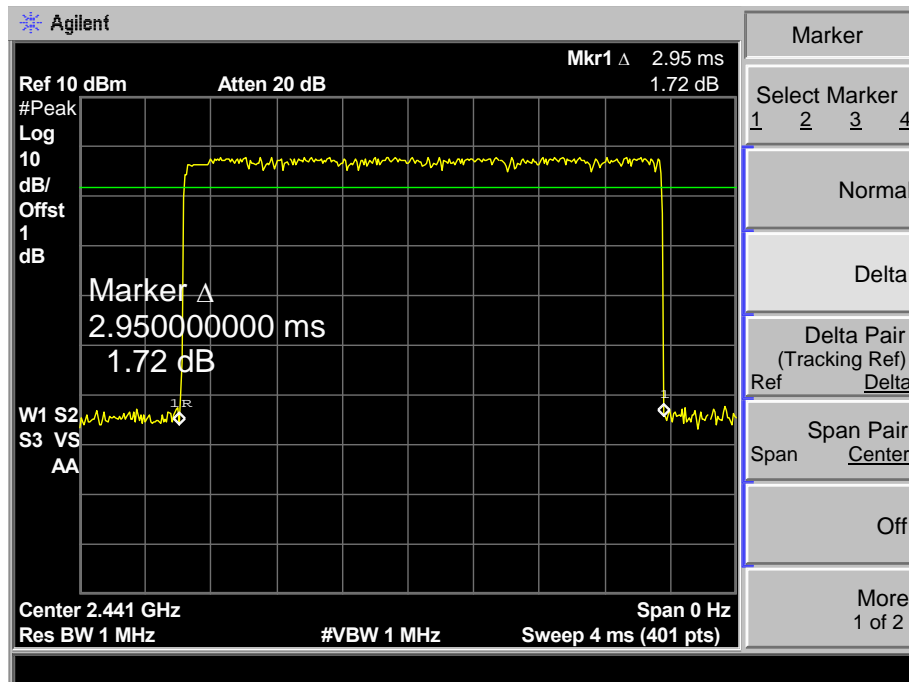

Temperature:		25°C		Relative Humidity:		55%	
Test Voltage:		DC 3.7V					
Test Mode:		Hopping Mode (8-DPSK)					
Test Mode	Channel (MHz)	Pulse Time (ms)	Total of Dwell (ms)	Period Time (s)	Limit (ms)	Result	
3DH1	2441	0.47	150.40	31.60	400	PASS	
3DH3	2441	1.70	272.00	31.60	400	PASS	
3DH5	2441	2.96	315.73	31.60	400	PASS	
<p>1DH1 Total of Dwell= Pulse Time*(1600/2)*31.6/79</p> <p>1DH3 Total of Dwell= Pulse Time*(1600/4)*31.6/79</p> <p>1DH5 Total of Dwell= Pulse Time*(1600/6)*31.6/79</p>							
8-DPSK Hopping Mode 3DH1							
2441 MHz							
<p>Agilent</p> <p>Ref 10 dBm Atten 20 dB Mkr1 Δ 470 μs -1.518 dB</p> <p>#Peak Log 10 dB/Offst 1 dB</p> <p>Marker Δ 470.0000000 μs -1.518 dB</p> <p>W1 S2 S3 VS AA</p> <p>Center 2.441 GHz Res BW 1 MHz #VBW 1 MHz Sweep 4 ms (401 pts) Span 0 Hz</p> <p>Marker: Select Marker 1 2 3 4</p> <p>Normal</p> <p>Delta</p> <p>Delta Pair (Tracking Ref) Ref Delta</p> <p>Span Pair Span Center</p> <p>Off</p> <p>More 1 of 2</p>							

8-DPSK Hopping Mode 3DH3

2441 MHz

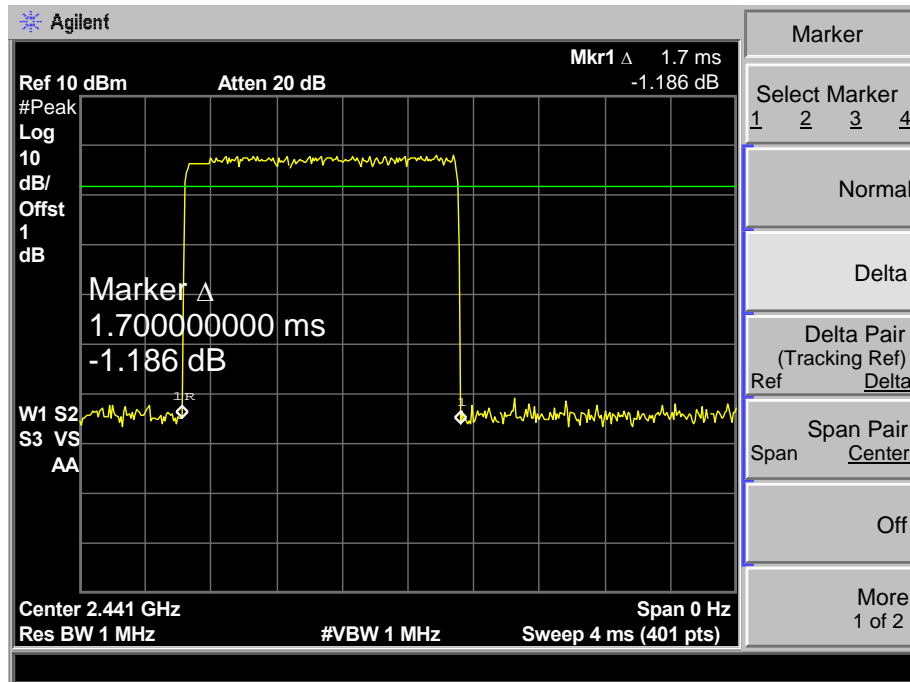

8-DPSK Hopping Mode 3DH5

2441 MHz

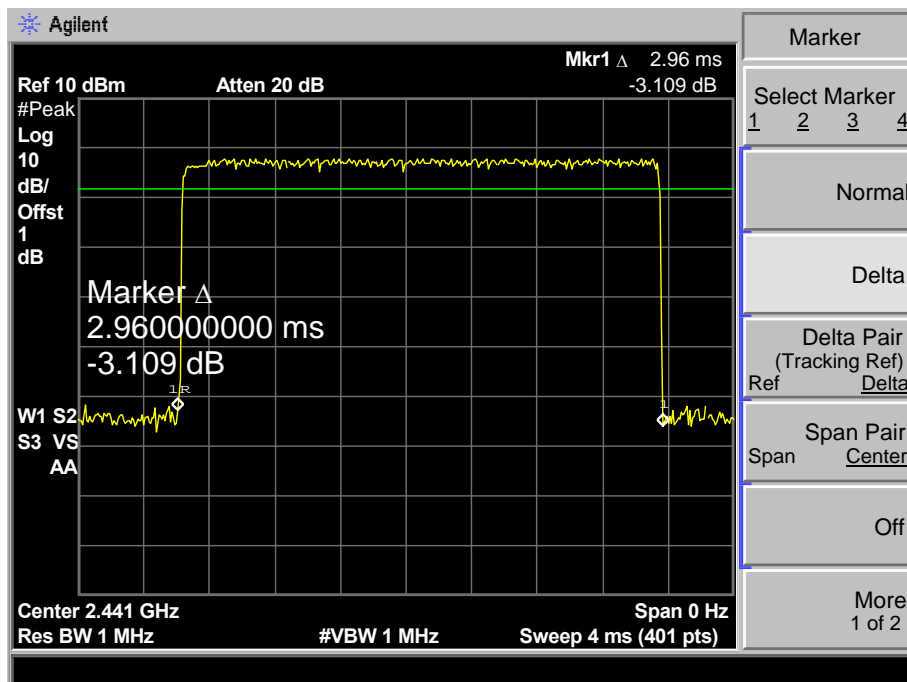

Attachment F-- Channel Separation and Bandwidth Test Data

Temperature:	25°C	Relative Humidity:	55%
Test Voltage:	DC 3.7V		
Test Mode:	TX Mode (GFSK)		
Channel frequency (MHz)	99% OBW (kHz)	20dB Bandwidth (kHz)	20dB Bandwidth *2/3 (kHz)
2402	791.5176	886.760	
2441	801.8924	890.331	
2480	777.8481	889.336	
GFSK TX Mode			
2402 MHz			
<p>Agilent Spectrum Analyzer Screenshot Data:</p> <ul style="list-style-type: none"> Ch Freq: 2.402 GHz Center: 2.40200000 GHz Start Freq: 2.40050000 GHz Stop Freq: 2.40350000 GHz CF Step: 300.000000 kHz Freq Offset: 0.00000000 Hz Occupied Bandwidth: 791.5176 kHz 20dB Bandwidth: 886.760 kHz Transmit Freq Error: 64.937 kHz Occ BW % Pwr: 99.00 % x dB Bandwidth: -20.00 dB 			

GFSK TX Mode

2441 MHz

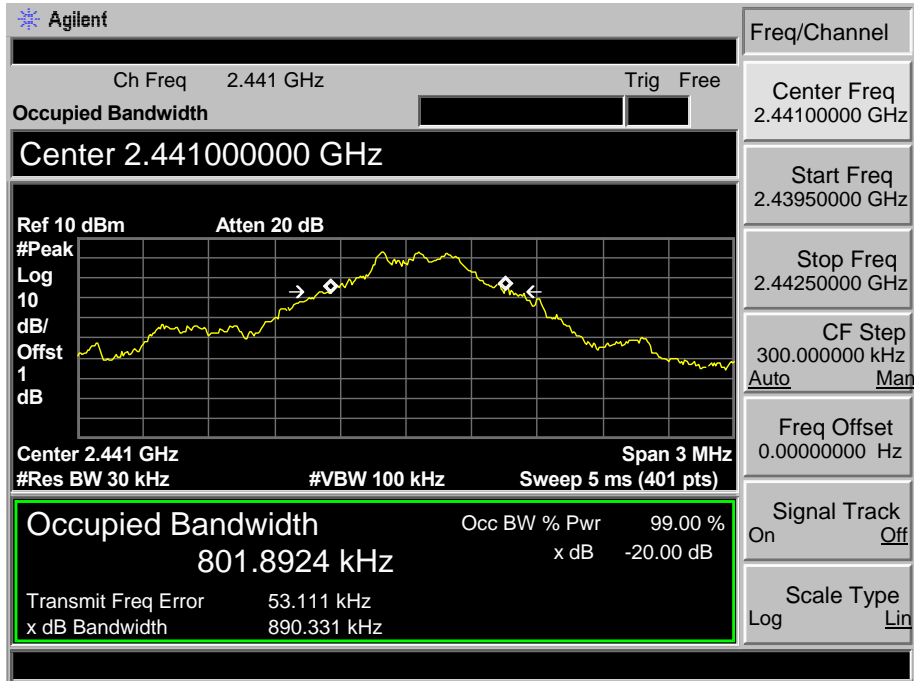

GFSK TX Mode

2480 MHz

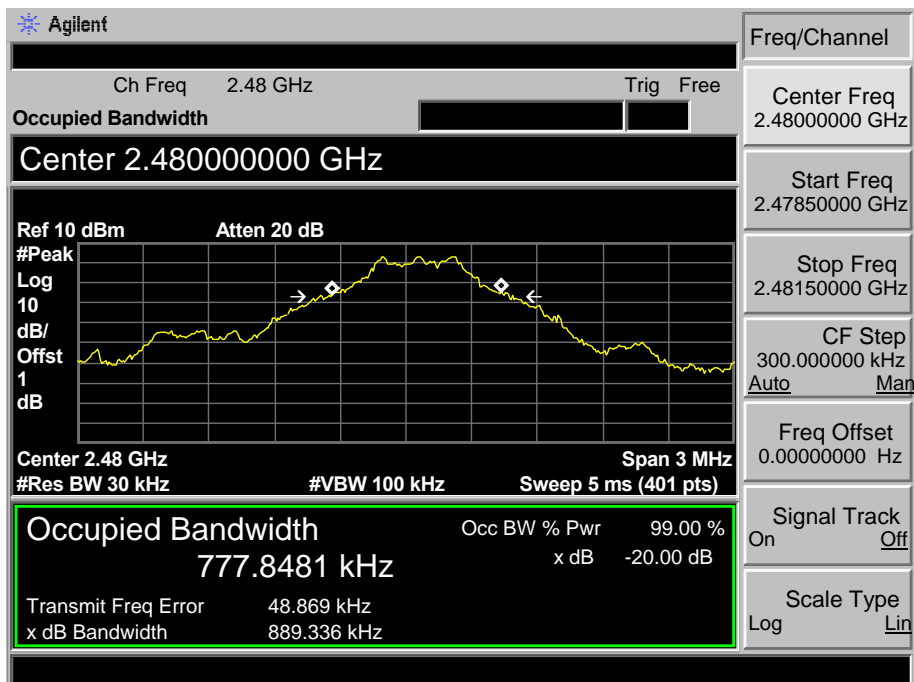

Temperature:	25°C	Relative Humidity:	55%
Test Voltage:	DC 3.7V		
Test Mode:	TX Mode ($\pi/4$ -DQPSK)		
Channel frequency (MHz)	99% OBW (kHz)	20dB Bandwidth (kHz)	20dB Bandwidth *2/3 (kHz)
2402	1174.7	1258	838.67
2441	1165.1	1246	830.67
2480	1183.0	1281	854.00

$\pi/4$ -DQPSK TX Mode

2402 MHz

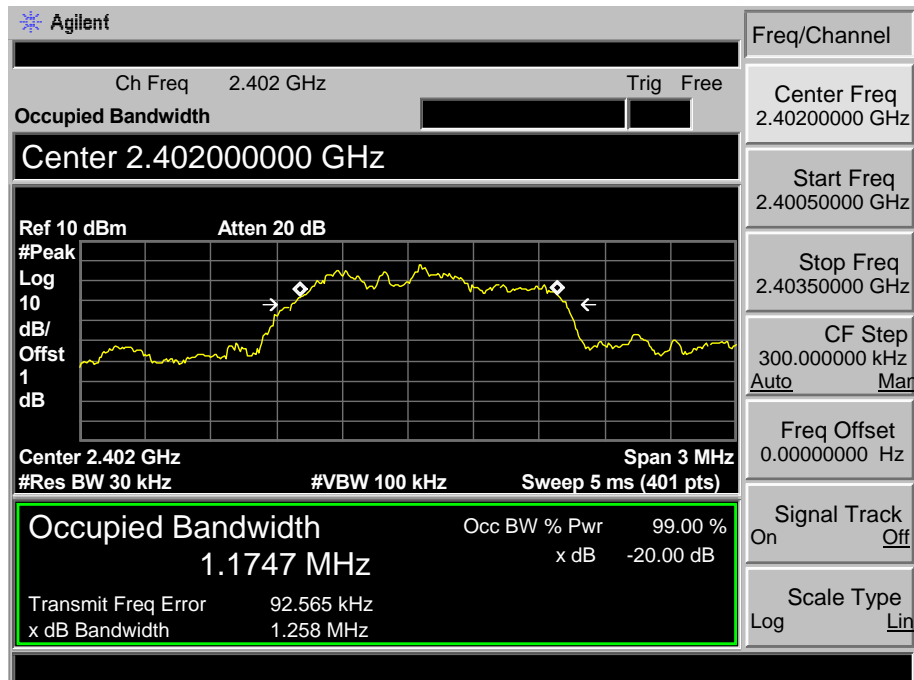

$\pi/4$ -DQPSK TX Mode

2441 MHz

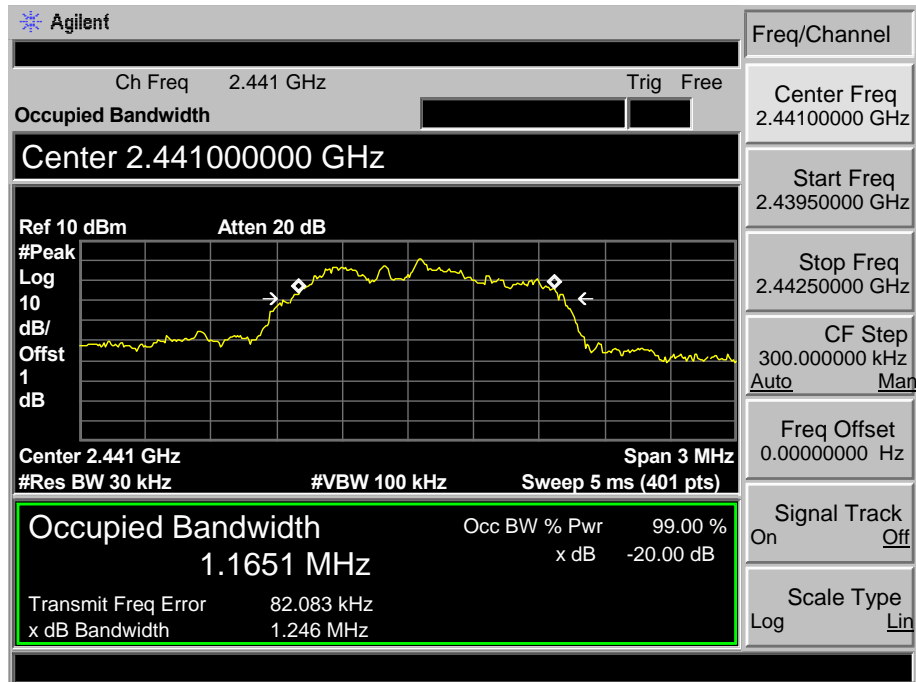

$\pi/4$ -DQPSK TX Mode

2480 MHz

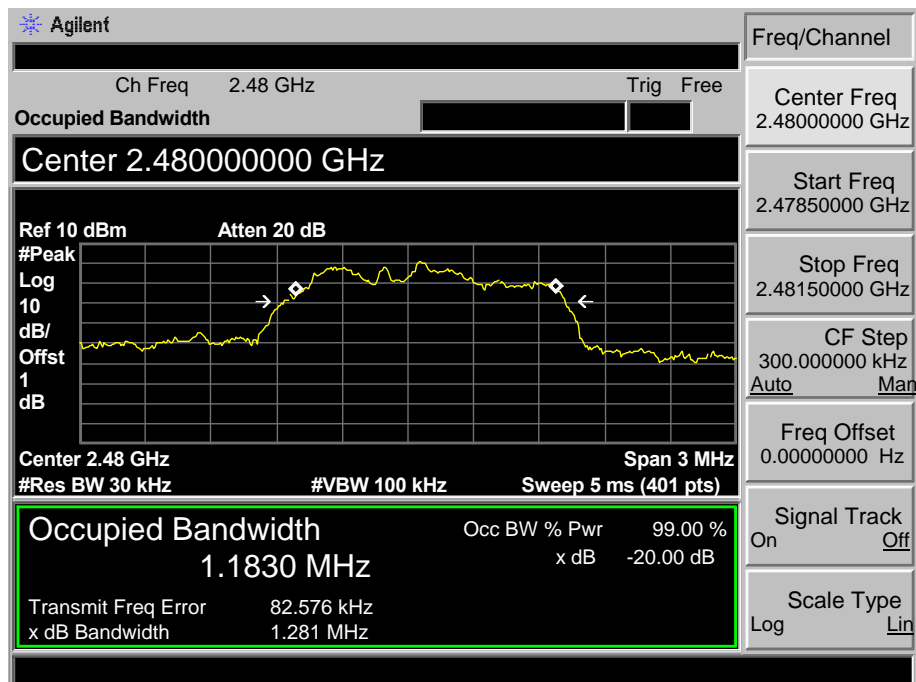

Temperature:	25°C	Relative Humidity:	55%
Test Voltage:	DC 3.7V		
Test Mode:	TX Mode (8-DPSK)		
Channel frequency (MHz)	99% OBW (kHz)	20dB Bandwidth (kHz)	20dB Bandwidth *2/3 (kHz)
2402	1160.4	1234	822.67
2441	1173.6	1283	855.33
2480	1170.4	1284	856.00

8-DPSK TX Mode

2402 MHz

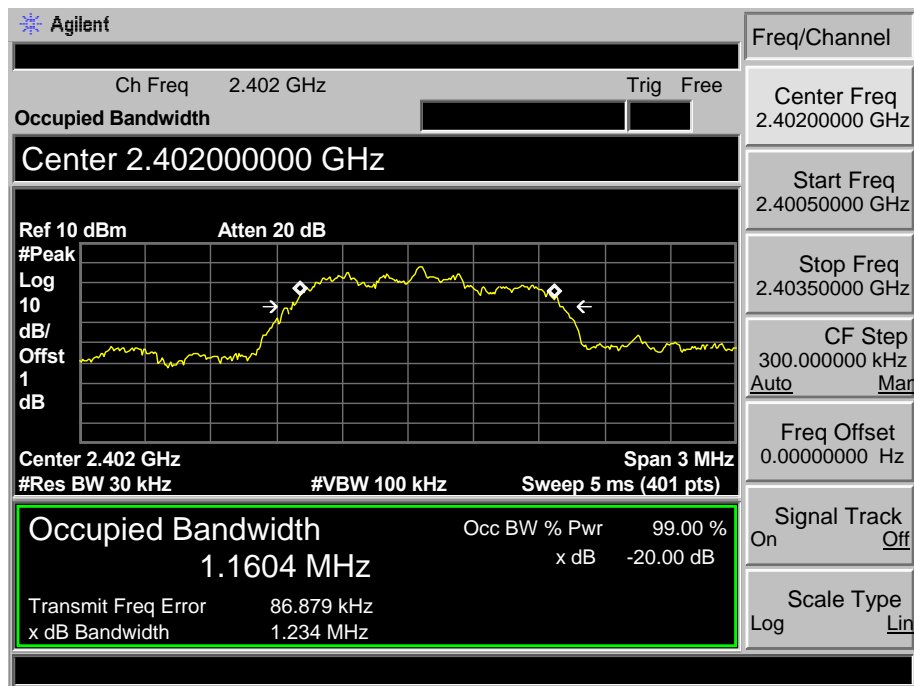

8-DPSK TX Mode

2441 MHz

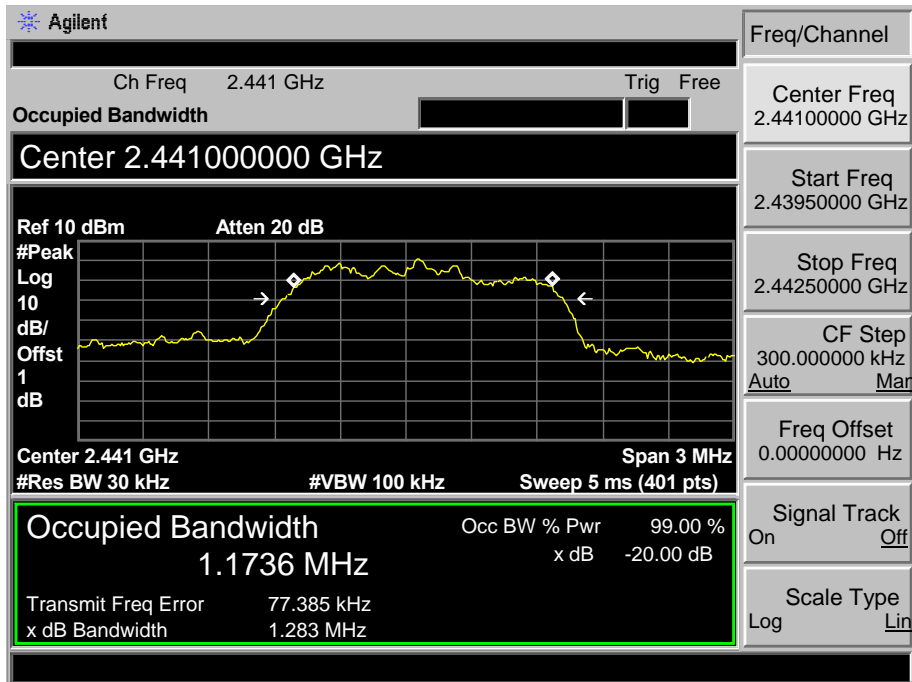

8-DPSK TX Mode

2480 MHz

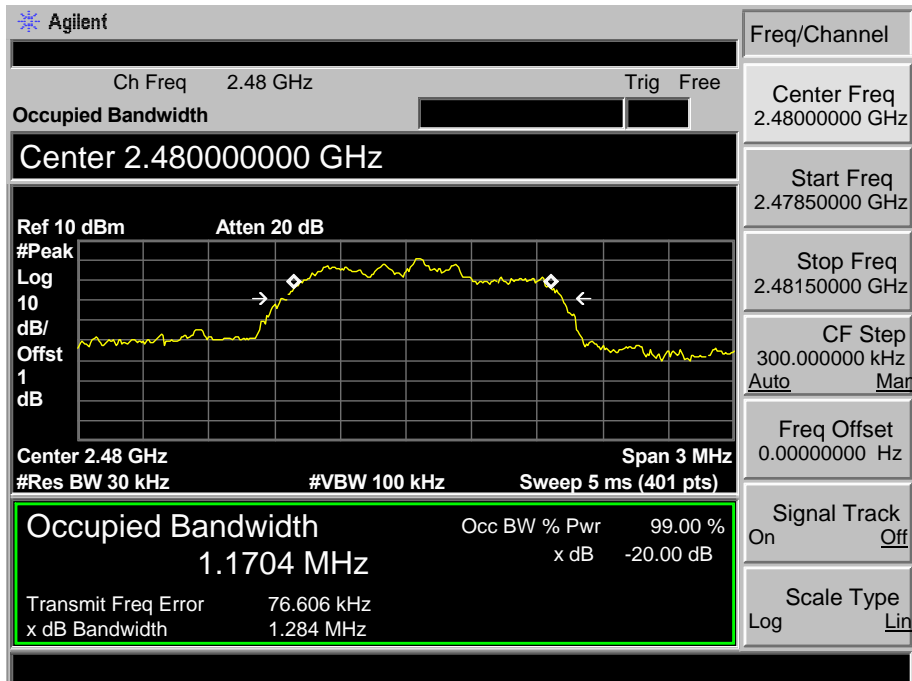

Temperature:	25°C	Relative Humidity:	55%
Test Voltage:	DC 3.7V		
Test Mode:	Hopping Mode (GFSK)		
Channel frequency (MHz)	Separation Read Value (kHz)	Separation Limit (kHz)	
2402	982.5	886.760	
2441	997.5	890.331	
2480	997.5	889.336	

GFSK Hopping Mode

2402 MHz

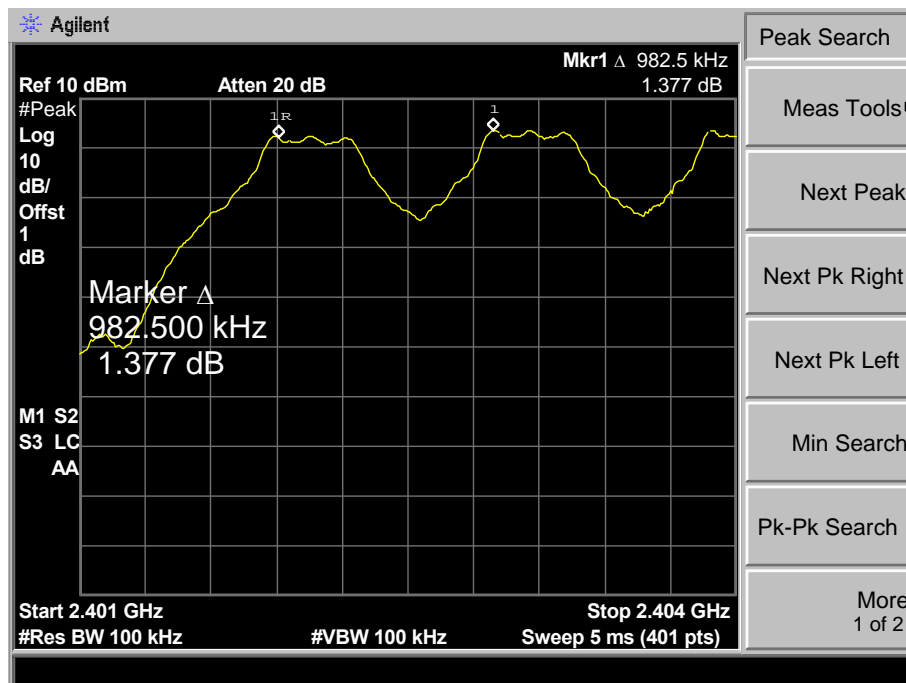

GFSK Hopping Mode

2441 MHz

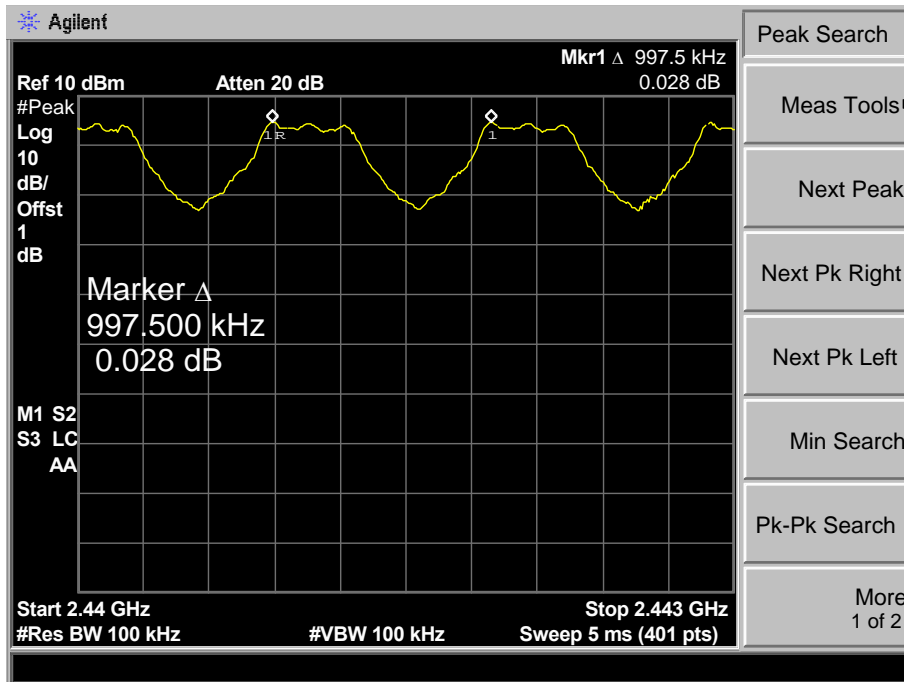

GFSK Hopping Mode

2480 MHz

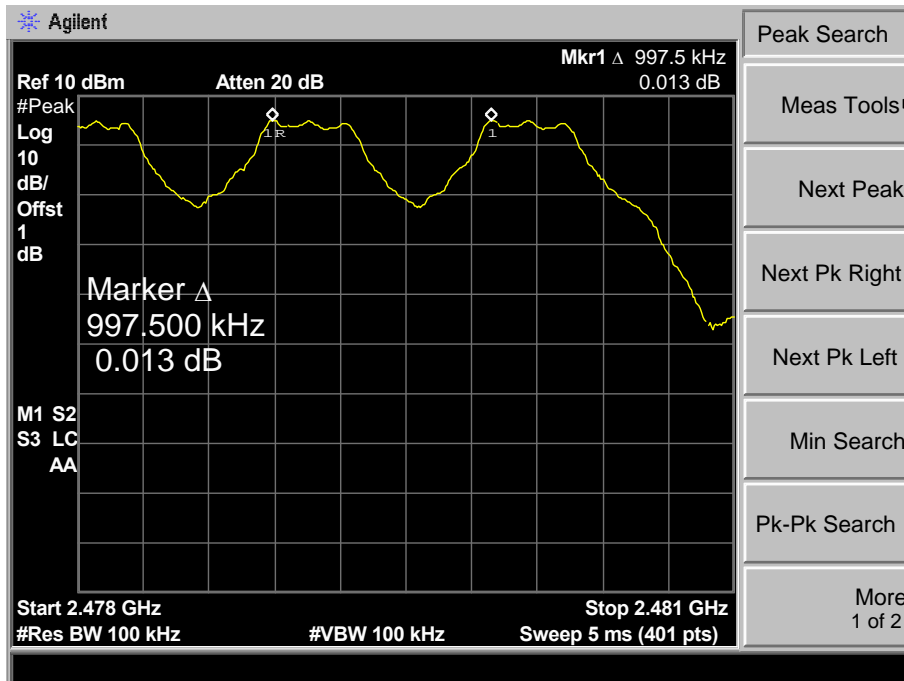

Temperature:	25°C	Relative Humidity:	55%
Test Voltage:	DC 3.7V		
Test Mode:	Hopping Mode ($\pi/4$ -DQPSK)		
Channel frequency (MHz)	Separation Read Value (kHz)	Separation Limit (kHz)	
2402	997.5	838.67	
2441	1005	830.67	
2480	997.5	854.00	

$\pi/4$ -DQPSK Hopping Mode

2402 MHz

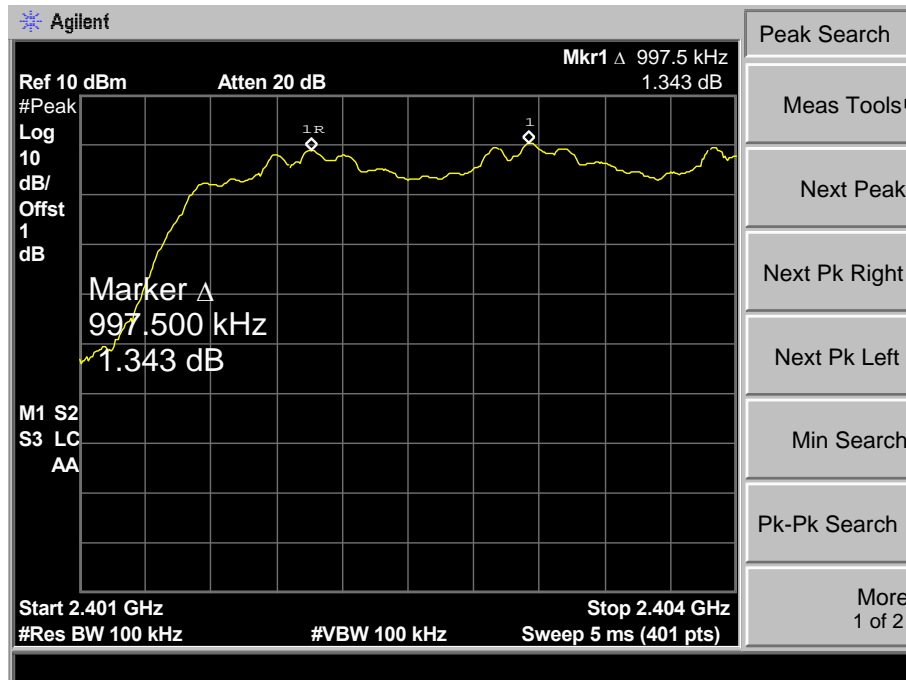

π /4-DQPSK Hopping Mode

2441 MHz

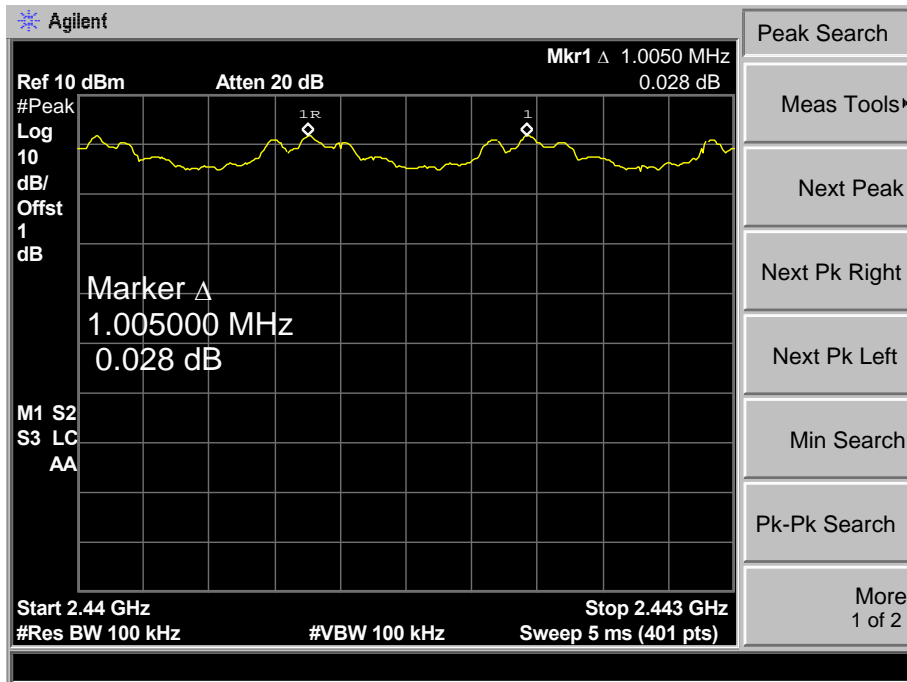

π /4-DQPSK Hopping Mode

2480 MHz

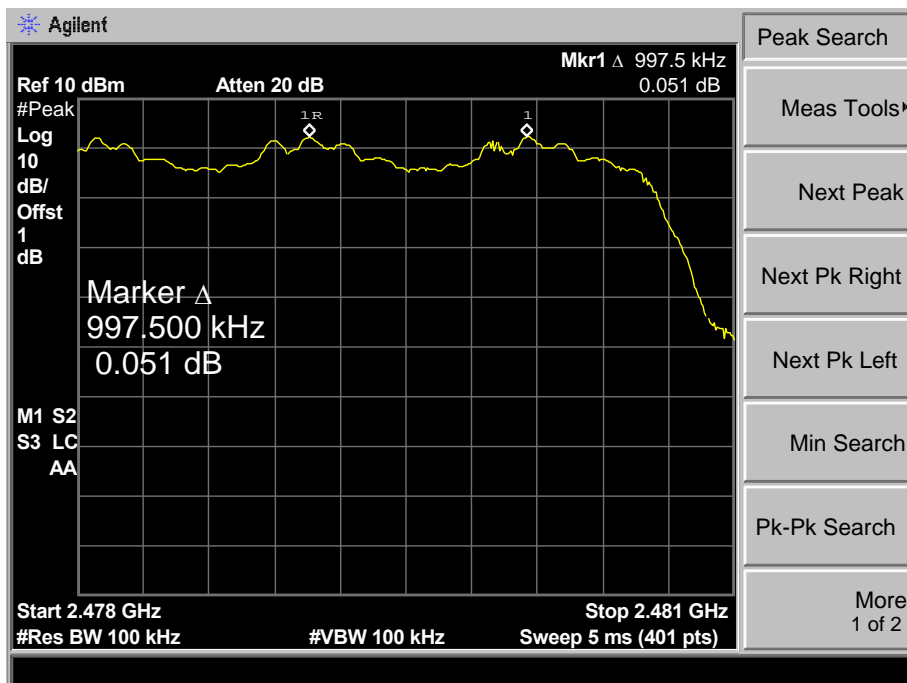

Temperature:	25°C	Relative Humidity:	55%
Test Voltage:	DC 3.7V		
Test Mode:	Hopping Mode (8-DPSK)		
Channel frequency (MHz)	Separation Read Value (kHz)	Separation Limit (kHz)	
2402	997.5	822.67	
2441	997.5	855.33	
2480	997.5	856.00	
8-DPSK Hopping Mode			
2402 MHz			

8-DPSK Hopping Mode

2441 MHz

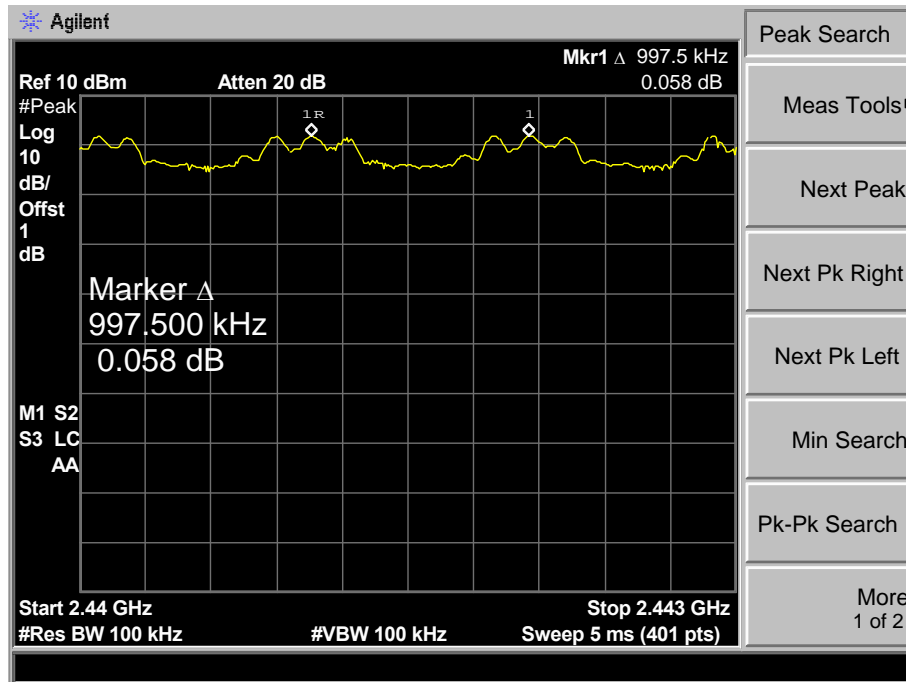

8-DPSK Hopping Mode

2480 MHz

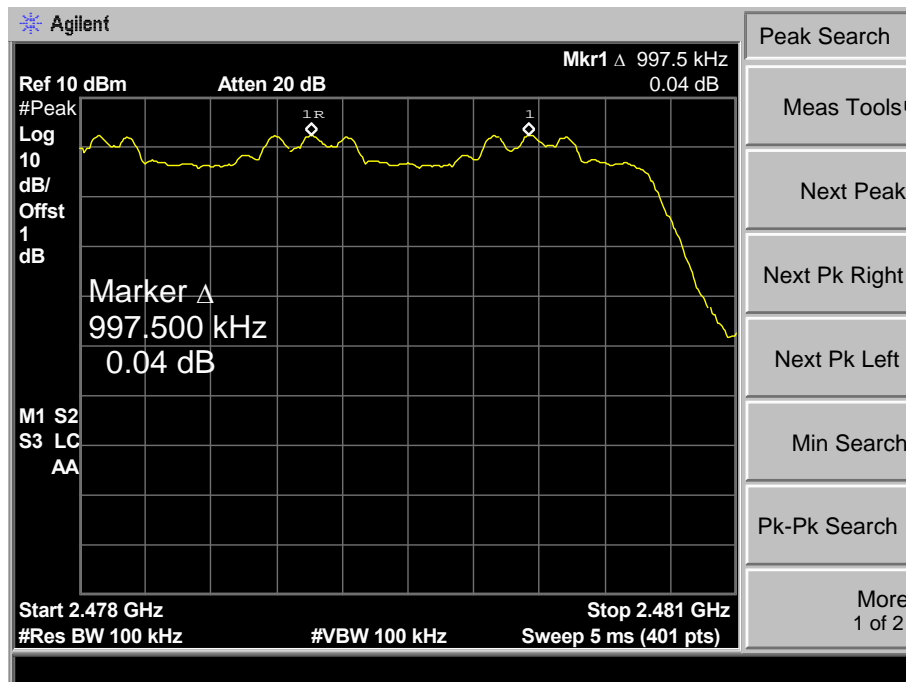

Attachment G-- Peak Output Power Test Data

Temperature:	25°C	Relative Humidity:	55%
Test Voltage:	DC 3.7V		
Test Mode:	TX Mode (GFSK)		
Channel frequency (MHz)	Test Result (dBm)	Limit (dBm)	
2402	3.612	30	
2441	5.417		
2480	5.260		
GFSK TX Mode			
2402 MHz			

GFSK TX Mode

2441 MHz

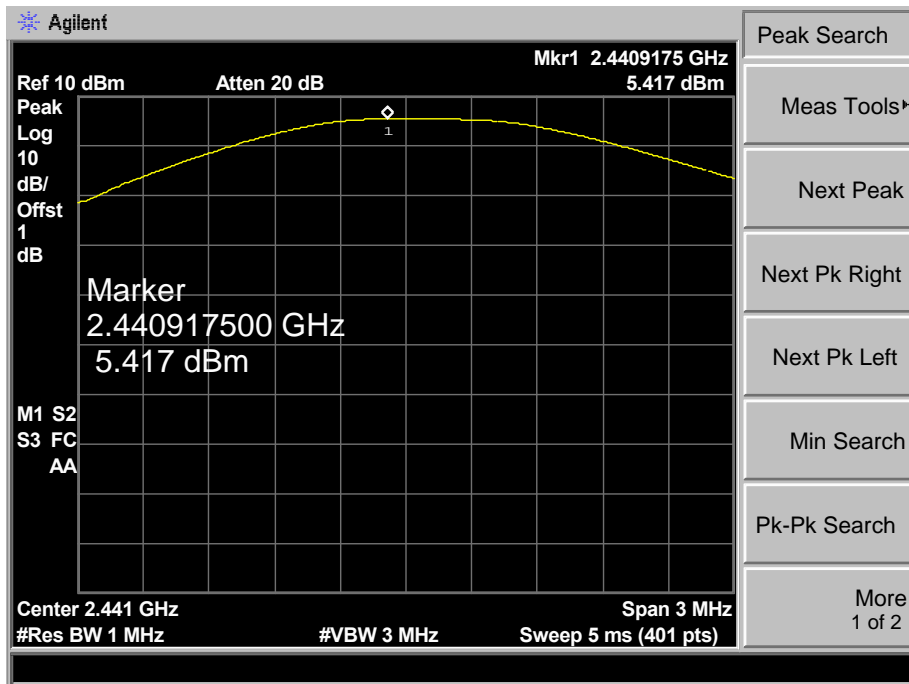

GFSK TX Mode

2480 MHz

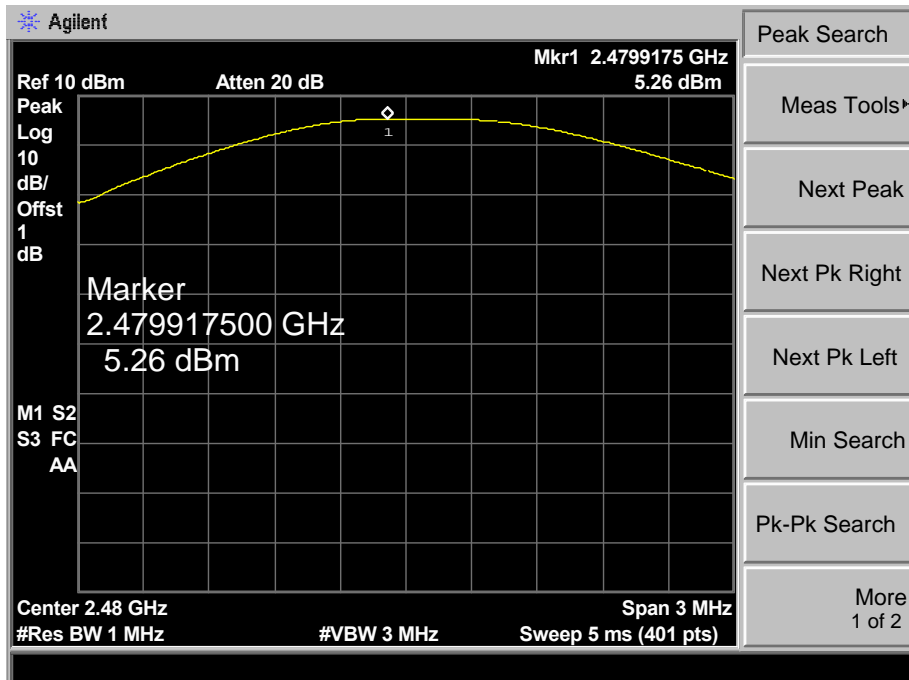

Temperature:	25°C	Relative Humidity:	55%
Test Voltage:	DC 3.7V		
Test Mode:	TX Mode ($\pi/4$ -DQPSK)		
Channel frequency (MHz)	Test Result (dBm)	Limit (dBm)	
2402	-0.254	21	
2441	3.551		
2480	3.904		

$\pi/4$ -DQPSK TX Mode

2402 MHz

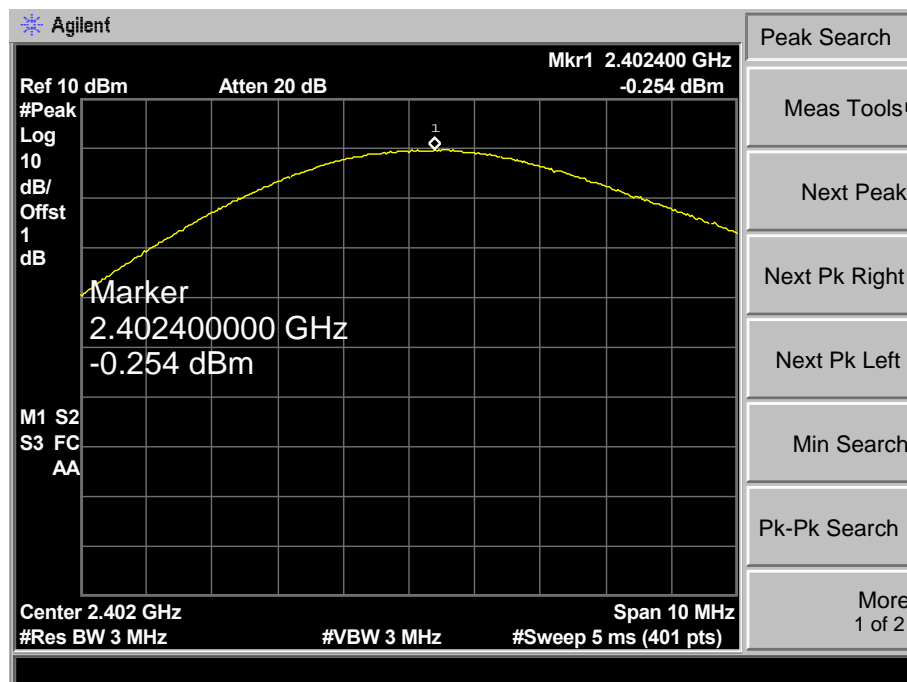

$\pi/4$ -DQPSK TX Mode

2441 MHz

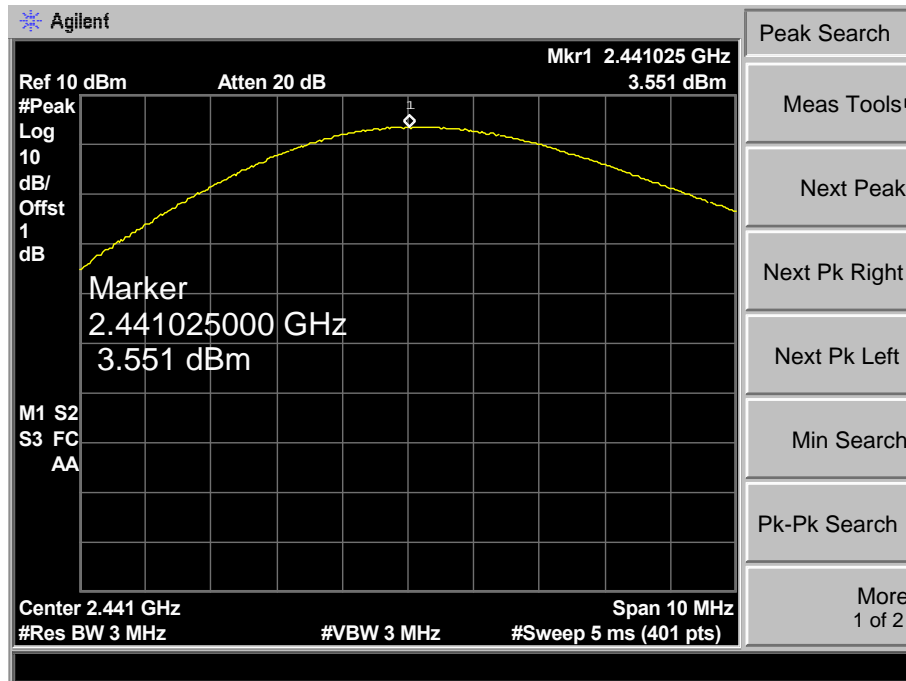

$\pi/4$ -DQPSK TX Mode

2480 MHz

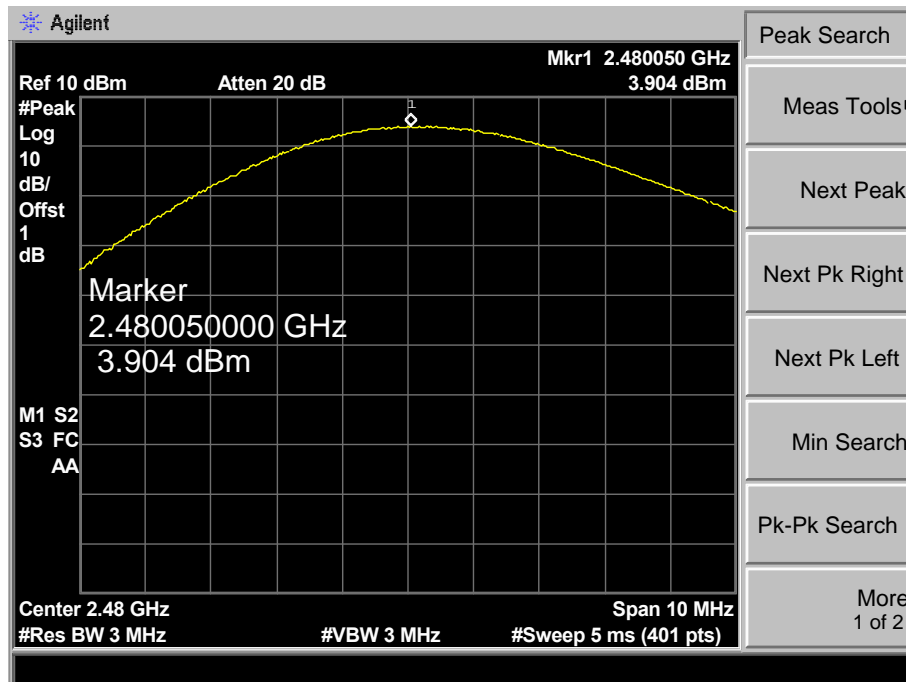

Temperature:	25°C	Relative Humidity:	55%
Test Voltage:	DC 3.7V		
Test Mode:	TX Mode (8-DPSK)		
Channel frequency (MHz)	Test Result (dBm)	Limit (dBm)	
2402	1.336	21	
2441	3.761		
2480	4.401		

8-DPSK TX Mode

2402 MHz

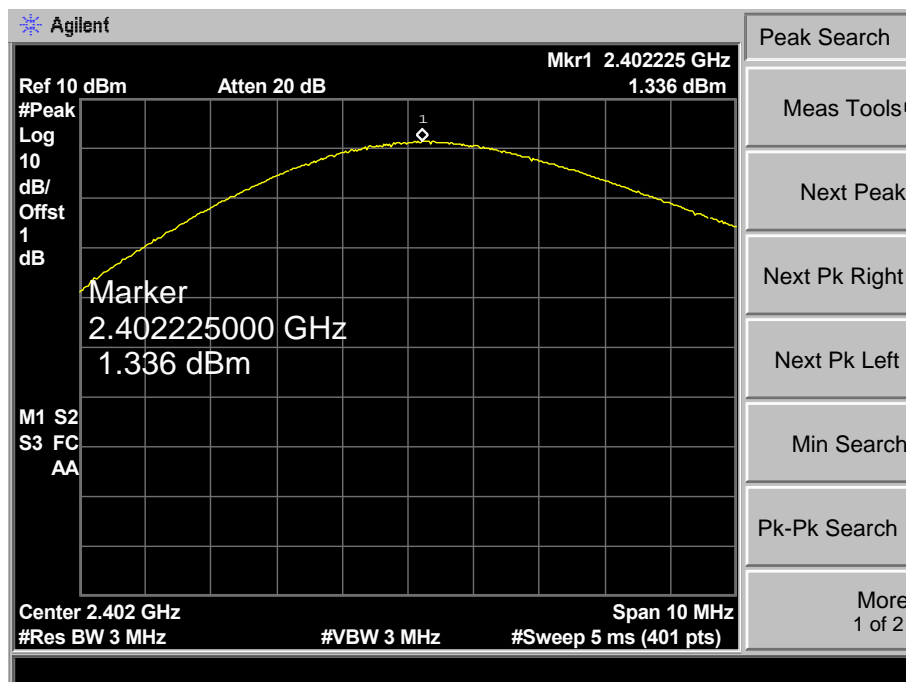

8-DPSK TX Mode

2441 MHz

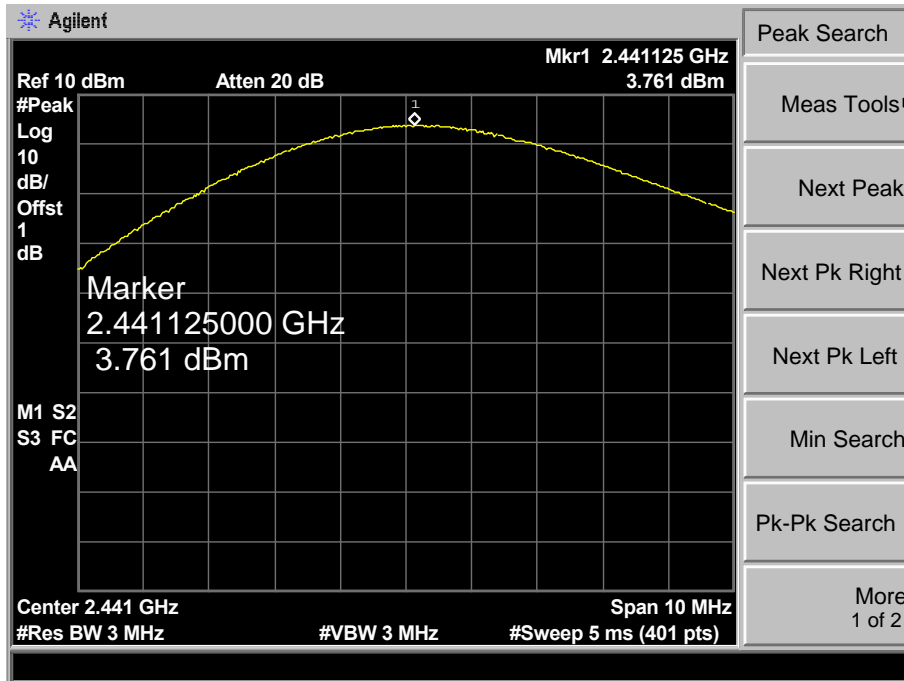

8-DPSK TX Mode

2480 MHz

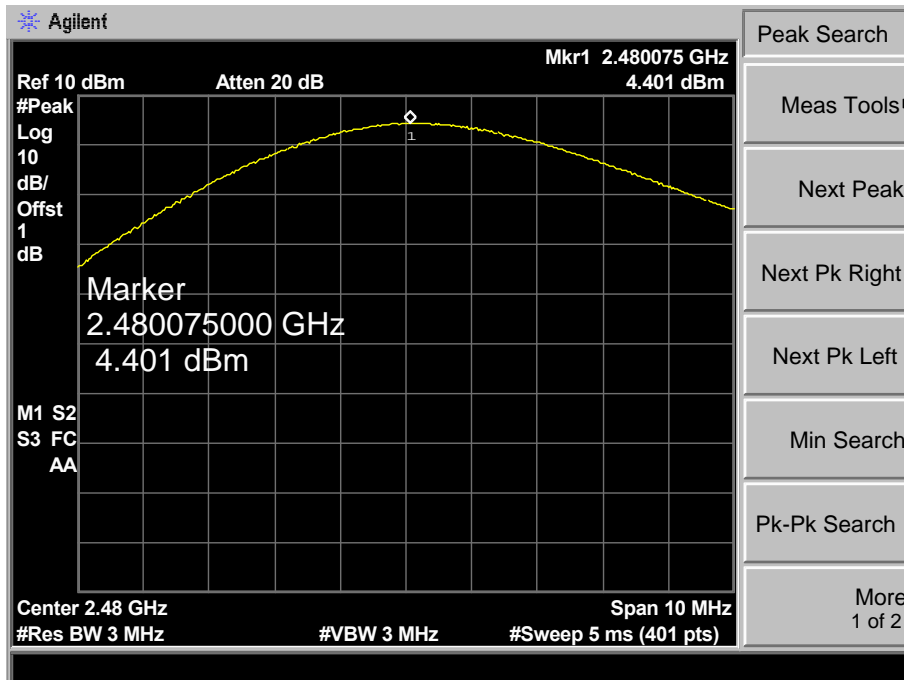

-----END OF REPORT-----