



RADIO TEST REPORT

Report No: STS2109062W01

Issued for

HAMATON AUTOMOTIVE TECHNOLOGY CO. ,LTD

12 East Zhenxing Road,Linping, Yuhang, Hangzhou, China

| | |
|-----------------------|---|
| Product Name: | US2.5 88_NFC sensor |
| Brand Name: | Hamaton |
| Model Name: | HTS-2400 |
| Series Model: | N/A |
| FCC ID: | 2AFH7PHT240 |
| IC: | 20466-PHT240 |
| Test Standard: | FCC Part 15.231 RSS-210 Issue 10, Amendment, April 2020 RSS-Gen Issue 5, Amendment 2, February 2021 |

Any reproduction of this document must be done in full. No single part of this document may be reproduced without permission from STS, all test data presented in this report is only applicable to presented test sample.

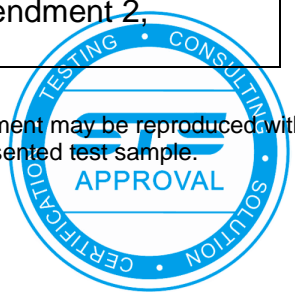



TEST REPORT CERTIFICATION

Applicant's Name: HAMATON AUTOMOTIVE TECHNOLOGY CO. ,LTD
Address.....: 12 East Zhenxing Road,Linping, Yuhang, Hangzhou, China
Manufacturer's Name: HAMATON AUTOMOTIVE TECHNOLOGY CO. ,LTD
Address.....: 12 East Zhenxing Road,Linping, Yuhang, Hangzhou, China

Product Description

Product Name: US2.5 88_NFC sensor
Brand Name.....: Hamaton
Model Name.....: HTS-2400
Series Model: N/A
Test Standards.....: FCC Part 15.231
ANSI C63.10-2013
Test Procedure.....: RSS-210 Issue 10, Amendment, April 2020
RSS-Gen Issue 5, Amendment 2, February 2021

This device described above has been tested by STS, the test results show that the equipment under test (EUT) is in compliance with the FCC/IC requirements. And it is applicable only to the tested sample identified in the report.

This report shall not be reproduced except in full, without the written approval of STS, this document only be altered or revised by STS, personal only, and shall be noted in the revision of the document.

Date of Test.....:
Date of Receipt of Test Item: 08 Sept. 2021
Date of performance of tests ...: 08 Sept. 2021 ~ 07 Dec. 2021
Date of Issue.....: 07 Dec. 2021
Test Result: Pass

Testing Engineer :

Chris Chen

(Chris Chen)

Technical Manager :

Sean She

(Sean she)

Authorized Signatory :

Vita Li

(Vita Li)





| TABLE OF CONTENTS | Page |
|--|-----------|
| 1. SUMMARY OF TEST RESULTS | 6 |
| 1.1 TEST FACTORY | 6 |
| 1.2 MEASUREMENT UNCERTAINTY | 6 |
| 2. GENERAL INFORMATION | 7 |
| 2.1 GENERAL DESCRIPTION OF THE EUT | 7 |
| 2.2 DESCRIPTION OF THE TEST MODES | 8 |
| 2.3 BLOCK DIAGRAM SHOWING THE CONFIGURATION OF SYSTEM TESTED | 8 |
| 2.4 DESCRIPTION OF NECESSARY ACCESSORIES AND SUPPORT UNITS | 9 |
| 2.5 EQUIPMENTS LIST | 10 |
| 3. EMC EMISSION TEST | 11 |
| 3.1 CONDUCTED EMISSION MEASUREMENT | 11 |
| 3.2 TEST PROCEDURE | 12 |
| 3.3 TEST SETUP | 12 |
| 3.4 TEST RESULTS | 12 |
| 4. RADIATED EMISSION MEASUREMENT | 13 |
| 4.1 RADIATED EMISSION LIMITS | 13 |
| 4.2 TEST PROCEDURE | 16 |
| 4.3 DEVIATION FROM TEST STANDARD | 16 |
| 4.4 TEST SETUP | 17 |
| 4.5 EUT OPERATING CONDITIONS | 18 |
| 4.6 TEST RESULTS | 18 |
| 4.7 FIELD STRENGTH CALCULATION | 19 |
| 4.8 TEST RESULTS (EMISSION) | 19 |
| 5. BANDWIDTH TEST | 30 |
| 5.1 LIMIT | 30 |
| 5.2 TEST REQUIREMENTS | 30 |
| 5.3 TEST PROCEDURE | 30 |
| 5.4 TEST SETUP | 30 |
| 5.5 EUT OPERATION CONDITIONS | 30 |
| 5.6 TEST RESULTS | 31 |
| 6. TRANSMITTER TIMEOUT | 35 |
| 6.1 LIMIT | 35 |
| 6.2 TEST PROCEDURE | 35 |
| 6.3 TEST SETUP | 35 |



| TABLE OF CONTENTS | Page |
|--|-----------|
| 6.4 TEST RESULTS | 36 |
| 7. PERIODIC OPERATION | 40 |
| 7.1 TEST PROCEDURE | 40 |
| 7.2 TEST SETUP | 40 |
| 7.3 EUT OPERATION CONDITIONS | 40 |
| 7.4 TEST RESULTS | 41 |
| 8. ANTENNA REQUIREMENT | 49 |
| 8.1 STANDARD REQUIREMENT | 49 |
| 8.2 EUT ANTENNA | 49 |
| APPENDIX 1-PHOTOS OF TEST SETUP | 50 |

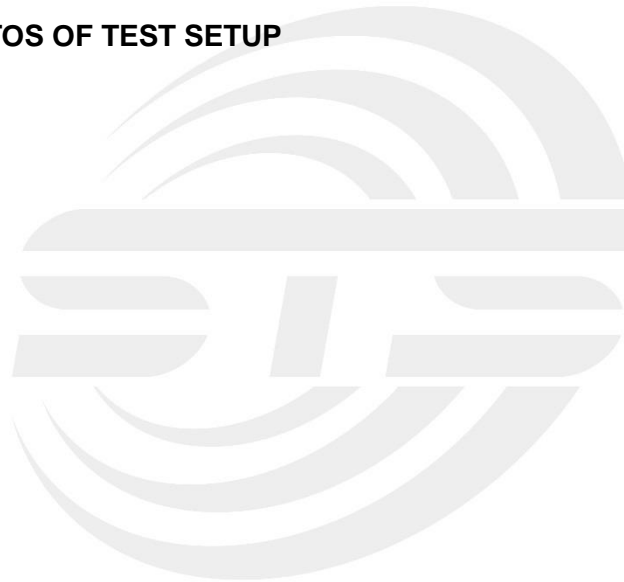



Revision History

| Rev. | Issue Date | Report NO. | Effect Page | Contents |
|------|--------------|---------------|-------------|---------------|
| 00 | 07 Dec. 2021 | STS2109062W01 | ALL | Initial Issue |
| | | | | |





1. SUMMARY OF TEST RESULTS

Test procedures according to the technical standards:

| FCC Part 15.231, Subpart C RSS 210 Issue 10 | | | |
|--|----------------------------|----------|--------|
| Standard Section | Test Item | Judgment | Remark |
| 15.207 RSS-Gen Issue 5 | Conducted Emission | N/A | -- |
| 15.205(a)/15.209/ 15.231(e) RSS 210 Issue 10 (A.1.4) | Radiated Spurious Emission | PASS | -- |
| 15.231(e) RSS 210 Issue 10 (A.1.4) | Transmission requirement | PASS | -- |
| 15.231(C) RSS 210 Issue 10 (A.1.3) | 20 dB Bandwidth | PASS | -- |
| 15.203 RSS-Gen Issue 5 | Antenna Requirement | PASS | -- |

NOTE: (1) "N/A" denotes test is not applicable in this Test Report.

(2) All tests are according to ANSI C63.10-2013.

1.1 TEST FACTORY

SHENZHEN STS TEST SERVICES CO., LTD

Add. : A 1/F, Building B, Zhuoke Science Park, No.190 Chongqing Road, HepingShequ, Fuyong Sub-District, Bao'an District, Shenzhen, Guang Dong, China

FCC test Firm Registration Number: 625569

IC test Firm Registration Number: 12108A

A2LA Certificate No.: 4338.01

1.2 MEASUREMENT UNCERTAINTY

The reported uncertainty of measurement $y \pm U$, where expanded uncertainty U is based on a standard uncertainty multiplied by a coverage factor of $k=2$, providing a level of confidence of approximately **95 %**.

| No. | Item | Uncertainty |
|-----|-----------------------------------|----------------------|
| 1 | RF output power, conducted | $\pm 0.68\text{dB}$ |
| 2 | Unwanted Emissions, conducted | $\pm 2.988\text{dB}$ |
| 3 | All emissions, radiated 9K-30MHz | $\pm 2.68\text{dB}$ |
| 4 | All emissions, radiated 30M-1GHz | $\pm 4.39\text{dB}$ |
| 5 | All emissions, radiated 1G-6GHz | $\pm 5.10\text{dB}$ |
| 6 | All emissions, radiated >6G | $\pm 5.48\text{dB}$ |
| 7 | Conducted Emission (9KHz-150KHz) | $\pm 2.79\text{dB}$ |
| 8 | Conducted Emission (150KHz-30MHz) | $\pm 2.80\text{dB}$ |



2. GENERAL INFORMATION

2.1 GENERAL DESCRIPTION OF THE EUT

| | |
|------------------------------|---|
| Product Name/PMN | US2.5 88_NFC sensor |
| Trade Name | Hamaton |
| Model Name/HVIN | HTS-2400 |
| Series Model | N/A |
| Model Difference | N/A |
| Product Description | The EUT is a US2.5 88_NFC sensor |
| | Operation Frequency: 315MHz, 433.92MHz |
| | Modulation Type: ASK, FSK |
| | Antenna Designation: Internal Antenna |
| | Antenna Gain(Peak) 2 dBi |
| | More details of EUT technical specification, please refer to the User Manual. |
| Battery | Rated Voltage: 3V Capacity: 345mAh |
| Hardware version number | V0.0.1 |
| Software version number/FVIN | V1.0 |
| Serial Numbers | 054B1C8008 |
| Connecting I/O Port(s) | Please refer to Note 1. |

Note:

1. For a more detailed features description, please refer to the manufacturer's specifications or the User Manual.

2. Table for filed Antenna

| Ant. | Brand | Model Name | Antenna Type | Connector | Gain (dBi) | NOTE |
|------|---------|------------|--------------|-----------|------------|---------|
| 1 | Hamaton | HTS-2400 | Internal | N/A | 2 | Antenna |



2.2 DESCRIPTION OF THE TEST MODES

To investigate the maximum EMI emission characteristics generates from EUT, the test system was pre-scanning tested base on the consideration of following EUT operation mode or test configuration mode which possible have effect on EMI emission level. Each of these EUT operation mode(s) or test configuration mode(s) mentioned above was evaluated respectively.

| Pretest Mode | Description |
|--------------|-------------------------|
| Mode 1 | TX Mode(315MHz, ASK) |
| Mode 2 | TX Mode(315MHz, FSK) |
| Mode 3 | TX Mode(433.92MHz, ASK) |
| Mode 4 | TX Mode(433.92MHz, FSK) |

| | For Radiated Emission |
|-----------------|-------------------------|
| Final Test Mode | Description |
| Mode 1 | TX Mode(315MHz, ASK) |
| Mode 2 | TX Mode(315MHz, FSK) |
| Mode 3 | TX Mode(433.92MHz, ASK) |
| Mode 4 | TX Mode(433.92MHz, FSK) |

Note:

(2)The measurements are performed at all Bit Rate of Transmitter, the worst data was reported

2.3 BLOCK DIAGRAM SHOWING THE CONFIGURATION OF SYSTEM TESTED

During testing channel & power controlling software provided by the customer was used to control the operating channel as well as the output power level. The RF output power selection is for the setting of RF output power expected by the customer and is going to be fixed on the firmware of the final end product power parameters

E-1
EUT



2.4 DESCRIPTION OF NECESSARY ACCESSORIES AND SUPPORT UNITS

The EUT has been tested as an independent unit together with other necessary accessories or support units. The following support units or accessories were used to form a representative test configuration during the tests.

Necessary accessories

| Item | Equipment | Mfr/Brand | Model/Type No. | Series No. | Note |
|------|-----------|-----------|----------------|------------|------|
| N/A | N/A | N/A | N/A | N/A | N/A |
| | | | | | |
| | | | | | |
| | | | | | |

Support units

| Item | Equipment | Mfr/Brand | Model/Type No. | Series No. | Note |
|------|-----------|-----------|----------------|------------|------|
| N/A | N/A | N/A | N/A | N/A | N/A |
| | | | | | |
| | | | | | |
| | | | | | |

Note:

(1) For detachable type I/O cable should be specified the length in cm in 『Length』 column.



2.5 EQUIPMENTS LIST

Radiation Test equipment

| Kind of Equipment | Manufacturer | Type No. | Serial No. | Last calibration | Calibrated until |
|----------------------------------|--------------|----------------------------|--------------|------------------|------------------|
| Test Receiver | R&S | ESCI | 101427 | 2021.09.30 | 2022.09.29 |
| Signal Analyzer | R&S | FSV 40-N | 101823 | 2021.09.30 | 2022.09.29 |
| Active loop Antenna | ZHINAN | ZN30900C | 16035 | 2021.04.11 | 2023.04.10 |
| Bilog Antenna | TESEQ | CBL6111D | 34678 | 2020.10.12 | 2022.10.11 |
| Horn Antenna | SCHWARZBECK | BBHA 9120D | 02014 | 2021.10.11 | 2023.10.10 |
| SHF-EHF Horn Antenna (18G-40GHz) | A-INFO | LB-180400-KF | J211020657 | 2020.10.12 | 2022.10.11 |
| Pre-Amplifier(0.1M-3 GHz) | EM | EM330 | 060665 | 2021.10.08 | 2022.10.07 |
| Pre-Amplifier (1G-18GHz) | SKET | LNPA-01018G-45 | SK2018080901 | 2021.09.30 | 2022.09.29 |
| Pre-Amplifier (18G-40GHz) | SKET | LNPA-1840-50 | SK2018101801 | 2021.09.28 | 2022.09.27 |
| Temperature & Humidity | HH660 | Mieo | N/A | 2021.10.09 | 2022.10.08 |
| Turn table | EM | SC100_1 | 60531 | N/A | N/A |
| Antenna mast | EM | SC100 | N/A | N/A | N/A |
| Test SW | FARAD | EZ-EMC(Ver.STSLAB-03A1 RE) | | | |

RF Connected Test

| Kind of Equipment | Manufacturer | Type No. | Serial No. | Last calibration | Calibrated until |
|------------------------|--------------|----------------------------|------------|------------------|------------------|
| Power Sensor | Keysight | U2021XA | MY55520005 | 2021.09.30 | 2022.09.29 |
| | | | MY55520006 | 2021.09.30 | 2022.09.29 |
| | | | MY56120038 | 2021.09.30 | 2022.09.29 |
| | | | MY56280002 | 2021.09.30 | 2022.09.29 |
| Signal Analyzer | Agilent | N9020A | MY51110105 | 2021.03.04 | 2022.03.03 |
| Temperature & Humidity | HH660 | Mieo | N/A | 2021.10.09 | 2022.10.08 |
| Test SW | FARAD | EZ-EMC(Ver.STSLAB-03A1 RE) | | | |

3. EMC EMISSION TEST

3.1 CONDUCTED EMISSION MEASUREMENT

3.1.1 POWER LINE CONDUCTED EMISSION LIMITS

The radio frequency voltage that is conducted back onto the AC power line on any frequency or frequencies, within the band 150 kHz to 30 MHz, shall not exceed the limits in the following table.

| FREQUENCY (MHz) | Class B (dBuV) | | Standard |
|-----------------|----------------|-----------|----------|
| | Quasi-peak | Average | |
| 0.15 -0.5 | 66 - 56 * | 56 - 46 * | CISPR |
| 0.50 -5.0 | 56.00 | 46.00 | CISPR |
| 5.0 -30.0 | 60.00 | 50.00 | CISPR |

| | | | |
|-----------|-----------|-----------|-----|
| 0.15 -0.5 | 66 - 56 * | 56 - 46 * | FCC |
| 0.50 -5.0 | 56.00 | 46.00 | FCC |
| 5.0 -30.0 | 60.00 | 50.00 | FCC |

Note:

(1) The tighter limit applies at the band edges.

(2) The limit of " * " marked band means the limitation decreases linearly with the logarithm of the frequency in the range.

The following table is the setting of the receiver

| Receiver Parameters | Setting |
|---------------------|----------|
| Attenuation | 10 dB |
| Start Frequency | 0.15 MHz |
| Stop Frequency | 30 MHz |
| IF Bandwidth | 9 kHz |

3.2 TEST PROCEDURE

- a. The EUT is 0.8 m from the horizontal ground plane and 0.4 m from the vertical ground plane with EUT being connected to the power mains through a line impedance stabilization network (LISN). All other support equipments are powered from additional LISN(s). The LISN provides 50 Ohm/ 50uH of coupling impedance for the measuring instrument.
- b. Interconnecting cables that hang closer than 40 cm to the ground plane shall be folded back and forth in the center forming a bundle 30 to 40 cm long.
- c. I/O cables that are not connected to a peripheral shall be bundled in the center. The end of the cable may be terminated, if required, using the correct terminating impedance. The overall length shall not exceed 1 m.
- d. LISN at least 80 cm from nearest part of EUT chassis.
- e. For the actual test configuration, please refer to the related Item –EUT Test Photos.

3.3 TEST SETUP

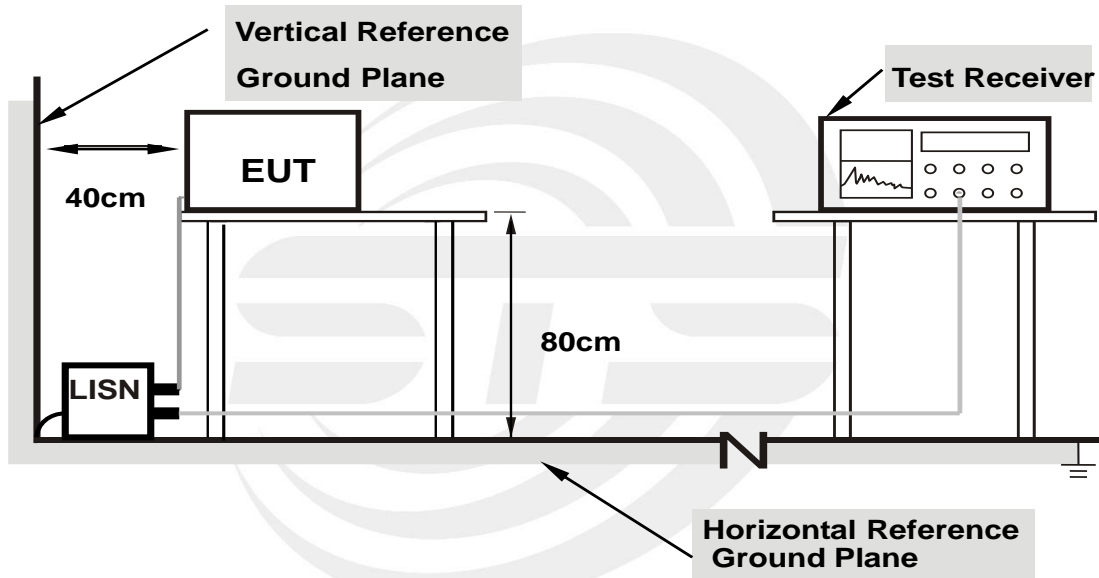

- Note: 1. Support units were connected to second LISN.**
2. Both of LISNs (AMN) are 80 cm from EUT and at least 80 cm from other units and other metal planes support units.

3.4 TEST RESULTS

| | | | |
|--------------|-----|--------------------|-----|
| Temperature: | N/A | Relative Humidity: | N/A |
| Phase: | L/N | Test Mode: | N/A |

Note: EUT is only power by battery, So it is not applicable for this test.



4. RADIATED EMISSION MEASUREMENT

4.1 RADIATED EMISSION LIMITS

In case the emission fall within the restricted band specified on Part 15.205(a), then the Part 15.209(a), Part 15.231(e), RSS-Gen Issue 5 and RSS 210 Issue 10 (A.1.4) limit in the table below has to be followed.

LIMITS OF RADIATED EMISSION MEASUREMENT (0.009MHz - 1000MHz)

| Frequencies (MHz) | Field Strength (microvolts/meter) | Measurement Distance (meters) |
|-------------------|-----------------------------------|-------------------------------|
| 0.009~0.490 | 2400/F(KHz) | 300 |
| 0.490~1.705 | 24000/F(KHz) | 30 |
| 1.705~30.0 | 30 | 30 |
| 30~88 | 100** | 3 |
| 88~216 | 150** | 3 |
| 216~960 | 200** | 3 |
| Above 960 | 500 | 3 |

| Fundamental Frequency (MHz) | Field Strength of fundamental (microvolts/meter) | Field Strength of Unwanted Emissions (microvolts/meter) |
|-----------------------------|--|---|
| 40.66 - 40.70 | 1,000 | 100 |
| 70 - 130 | 500 | 50 |
| 130 - 174 | 500 to 1,500 ** | 50 to 1,50 ** |
| 174 - 260 | 1,500 | 1,50 |
| 260 - 470 | 1,500 to 5,000 ** | 1,50 to 5,00 ** |
| Above 470 | 5,000 | 5,00 |

LIMITS OF RADIATED EMISSION MEASUREMENT (Above 1000MHz)

| FREQUENCY (MHz) | Class B (dBuV/m) (at 3M) | |
|-----------------|--------------------------|---------|
| | PEAK | AVERAGE |
| Above 1000 | 74 | 54 |

NOTE:** linear interpolations

[Where F is the frequency in MHz, the formulas for calculating the maximum permitted fundamental

field strengths are as follows: for the band 130-174 MHz, $\mu\text{V}/\text{m}$ at 3 meters = $22.72727(F) - 2454.545$; for the band 260-470 MHz, $\mu\text{V}/\text{m}$ at 3 meters = $16.6667(F) - 2833.3333$. The maximum permitted unwanted emission level is 20 dB below the maximum permitted fundamental level.]

The limits on the field strength of the spurious emissions in the above table are based on the fundamental frequency of the intentional radiator. Spurious emissions shall be attenuated to the average (or, alternatively, CISPR quasi-peak) limits shown in this table or to the general limits shown in 93 Section 15.209, whichever limit permits a higher field strength.



LIMITS OF RESTRICTED FREQUENCY BANDS

FCC:

| FREQUENCY (MHz) | FREQUENCY (MHz) | FREQUENCY (MHz) | FREQUENCY (GHz) |
|-------------------|---------------------|-----------------|-----------------|
| 0.090-0.110 | 16.42-16.423 | 399.9-410 | 4.5-5.15 |
| 0.495-0.505 | 16.69475-16.69525 | 608-614 | 5.35-5.46 |
| 2.1735-2.1905 | 16.80425-16.80475 | 960-1240 | 7.25-7.75 |
| 4.125-4.128 | 25.5-25.67 | 1300-1427 | 8.025-8.5 |
| 4.17725-4.17775 | 37.5-38.25 | 1435-1626.5 | 9.0-9.2 |
| 4.20725-4.20775 | 73-74.6 | 1645.5-1646.5 | 9.3-9.5 |
| 6.215-6.218 | 74.8-75.2 | 1660-1710 | 10.6-12.7 |
| 6.26775-6.26825 | 108-121.94 | 1718.8-1722.2 | 13.25-13.4 |
| 6.31175-6.31225 | 123-138 | 2200-2300 | 14.47-14.5 |
| 8.291-8.294 | 149.9-150.05 | 2310-2390 | 15.35-16.2 |
| 8.362-8.366 | 156.52475-156.52525 | 2483.5-2500 | 17.7-21.4 |
| 8.37625-8.38675 | 156.7-156.9 | 2690-2900 | 22.01-23.12 |
| 8.41425-8.41475 | 162.0125-167.17 | 3260-3267 | 23.6-24.0 |
| 12.29-12.293 | 167.72-173.2 | 3332-3339 | 31.2-31.8 |
| 12.51975-12.52025 | 240-285 | 3345.8-3358 | 36.43-36.5 |
| 12.57675-12.57725 | 322-335.4 | 3600-4400 | Above 38.6 |
| 13.36-13.41 | | | |

IC:

| FREQUENCY (MHz) | FREQUENCY (MHz) | FREQUENCY (GHz) |
|---------------------|-----------------------|-----------------|
| 0.090 - 0.110 | 149.9 - 150.05 | 9.0 - 9.2 |
| 0.495 - 0.505 | 156.52475 - 156.52525 | 9.3 - 9.5 |
| 2.1735 - 2.1905 | 156.7 - 156.9 | 10.6 - 12.7 |
| 3.020 - 3.026 | 162.0125 - 167.17 | 13.25 - 13.4 |
| 4.125 - 4.128 | 167.72 - 173.2 | 14.47 - 14.5 |
| 4.17725 - 4.17775 | 240 - 285 | 15.35 - 16.2 |
| 4.20725 - 4.20775 | 322 - 335.4 | 17.7 - 21.4 |
| 5.677 - 5.683 | 399.9 - 410 | 22.01 - 23.12 |
| 6.215 - 6.218 | 608 - 614 | 23.6 - 24.0 |
| 6.26775 - 6.26825 | 960 - 1427 | 31.2 - 31.8 |
| 6.31175 - 6.31225 | 1435 - 1626.5 | 36.43 - 36.5 |
| 8.291 - 8.294 | 1645.5 - 1646.5 | Above 38.6 |
| 8.362 - 8.366 | 1660 - 1710 | |
| 8.37625 - 8.38675 | 1718.8 - 1722.2 | |
| 8.41425 - 8.41475 | 2200 - 2300 | |
| 12.29 - 12.293 | 2310 - 2390 | |
| 12.51975 - 12.52025 | 2483.5 - 2500 | |
| 12.57675 - 12.57725 | 2655 - 2900 | |
| 13.36 - 13.41 | 3260 - 3267 | |
| 16.42 - 16.423 | 3332 - 3339 | |
| 16.69475 - 16.69525 | 3345.8 - 3358 | |



| | | |
|---------------------|-------------|--|
| 16.80425 - 16.80475 | 3500 - 4400 | |
| 25.5 - 25.67 | 4500 - 5150 | |
| 37.5 - 38.25 | 5350 - 5460 | |
| 73 - 74.6 | 7250 - 7750 | |
| 74.8 - 75.2 | 8025 - 8500 | |
| 108 - 138 | | |

| Spectrum Parameter | Setting |
|---------------------------------------|-----------------------|
| Detector | Peak |
| Attenuation | Auto |
| Start Frequency | 1000 MHz |
| Stop Frequency | 10th carrier harmonic |
| RB / VB (emission in restricted band) | 1MHz / 3MHz |

| Receiver Parameter | Setting |
|------------------------|--------------------------------------|
| Attenuation | Auto |
| Start ~ Stop Frequency | 9kHz~90kHz / RB 200Hz for PK & AV |
| Start ~ Stop Frequency | 90kHz~110kHz / RB 200Hz for QP |
| Start ~ Stop Frequency | 110kHz~490kHz / RB 200Hz for PK & AV |
| Start ~ Stop Frequency | 490kHz~30MHz / RB 9kHz for QP |
| Start ~ Stop Frequency | 30MHz~1000MHz / RB 120kHz for QP |



4.2 TEST PROCEDURE

- a. The test is performed in a 3m Semi-Anechoic Chamber; the antenna factor, cable loss and so on of the site (factors) is calculated to correct the reading. The EUT is placed on a 0.8m high insulating Turn Table, and keeps 3m away from the Test Antenna, which is mounted on a variable-height antenna master tower.
During test, The table was rotated 360 degrees to determine the position of the highest radiation.
- b. In the frequency range of 9KHz to 30MHz, magnetic field is measured with Loop Test Antenna. The Test Antenna is positioned with its plane vertical at 1m distance from the EUT. The center of the Loop Test Antenna is 1m above the ground. During the measurement the Loop Test Antenna rotates about its vertical axis for maximum response at each azimuth about the EUT.
- c. In the frequency range 30MHz-1GHz, Bi-Log Test Antenna used. Test Antenna is 3m away from the EUT. Test Antenna height is varied from 1m to 4m above the ground to determine the maximum value of the field strength. The emission levels at both horizontal and vertical polarizations should be tested.
- d. In the frequency above 1GHz, Place the measurement antenna 3m away from the EUT for each area of the EUT determined to be a source of emissions at the specified measurement distance, while keeping the measurement antenna aimed at the source of emissions at each frequency of significant emissions, with polarization oriented for maximum response. The measurement antenna elevation for maximum emissions shall be restricted to a range of heights of from 1 m to 4 m above the ground or reference ground plane.
- f. The initial step in collecting conducted emission data is a spectrum analyzer peak detector mode pre-scanning the measurement frequency range. Significant peaks are then marked and then Quasi Peak detector mode re-measured.
- g. If the Peak Mode measured value compliance with and lower than Quasi Peak Mode Limit, the EUT shall be deemed to meet QP Limits and then no additional QP Mode measurement performed.
- h. For the actual test configuration, please refer to the related Item –EUT Test Photos.
Note: Both horizontal and vertical antenna polarities were tested and performed pretest to three orthogonal axis. The worst case emissions were reported

4.3 DEVIATION FROM TEST STANDARD

No deviation

4.4 TEST SETUP

(A) Radiated Emission Test-Up Frequency Below 30MHz

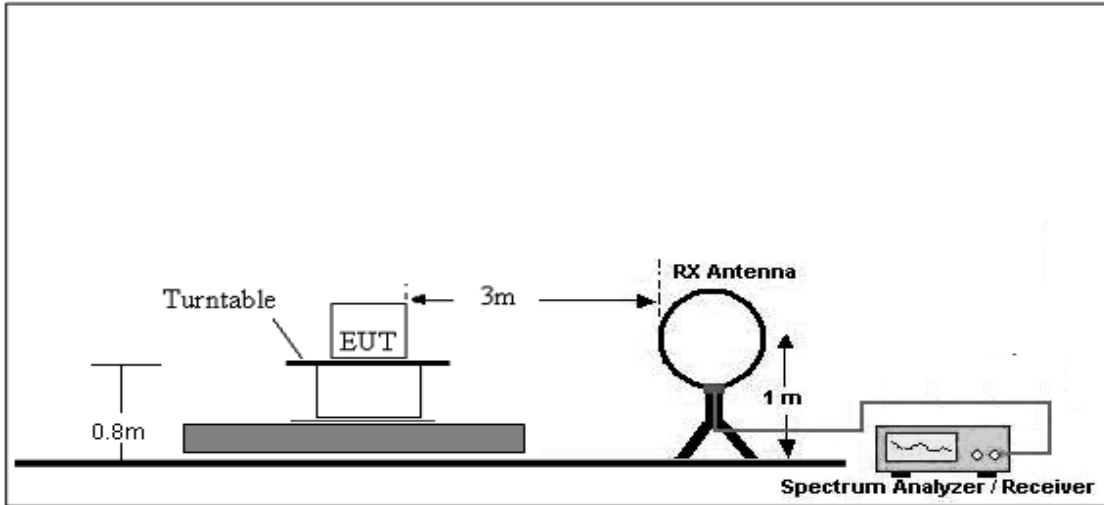

(B) Radiated Emission Test-Up Frequency 30MHz~1GHz

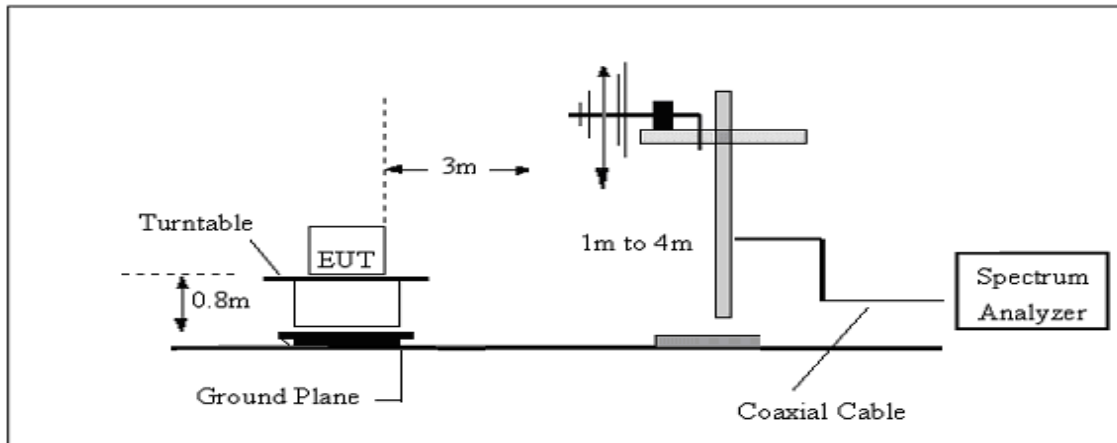

(C) Radiated Emission Test-Up Frequency Above 1GHz

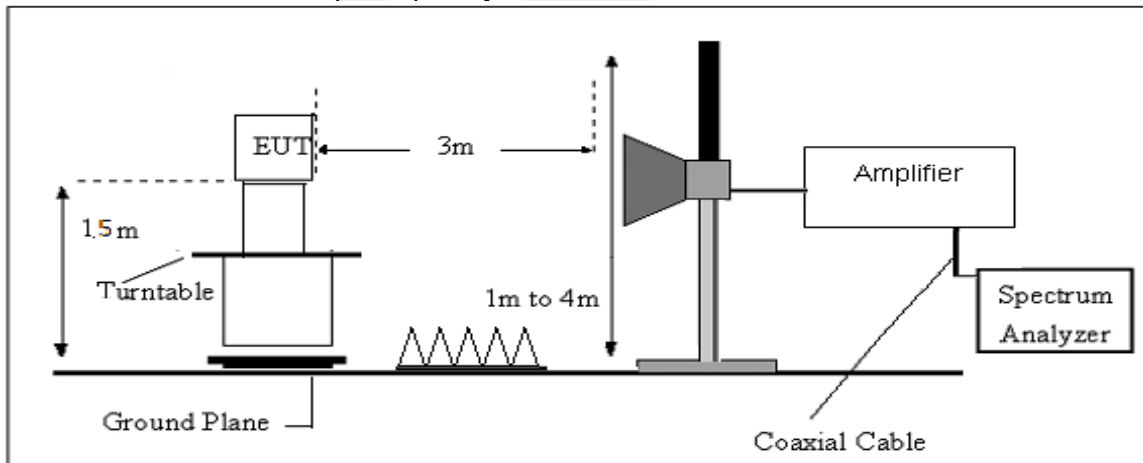

4.5 EUT OPERATING CONDITIONS

The EUT tested system was configured as the statements of 2.4 Unless otherwise a special operating condition is specified in the follows during the testing.

4.6 TEST RESULTS

INTRODUCTION TO PDCF

Reference: (§15.35 Measurement detector functions and bandwidths.)

- a. Part 15 of the FCC Rules provides for the operation of low power communication devices without an individual license (e.g., intrusion detectors, pulsed water tank level gauges, etc.), subject to certain requirements. Some of these devices use extremely narrow pulses to generate wideband emissions, which are measured to determine compliance with the rules. These measurements are typically performed with a receiver or spectrum analyzer. Depending on a number of factors (e.g., resolution bandwidth, pulsewidth, etc.), the spectrum analyzer may not always display the true peak value of the measured emission. This effect, called “pulse desensitization,” relates to the capabilities of the measuring instrument. For the measurement and reporting of the true peak of pulsed emissions, it may be necessary to apply a “pulse desensitization correction factor” (PDCF) to the measured value, pursuant to 47 CFR 15.35(a).

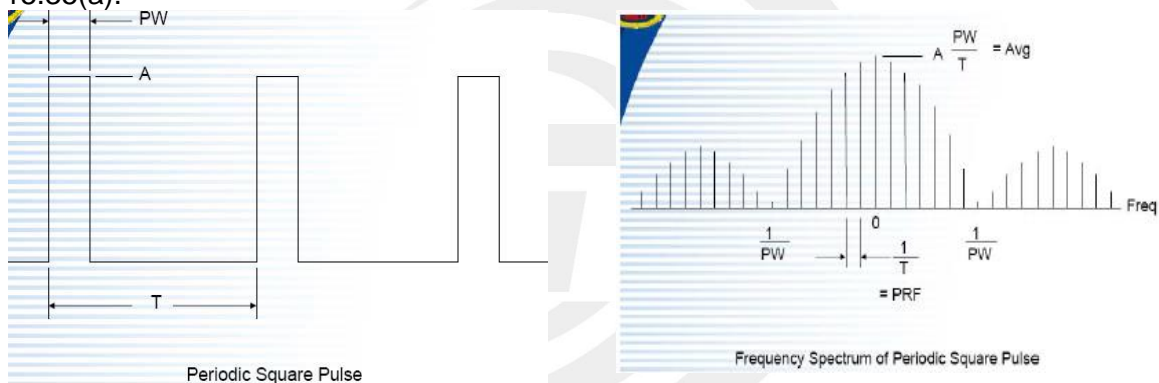

If using spectrum analyzer to measure pulse signal, it have to make sure the RBW use is at least $2/PW$.

•When RBW is less than $2/PW$, you are able to measure the true peak level of the pulse signal. If this is the case, PDCF is required to compensate to determine true peak value.

Pulse desensitization:

315MHz, ASK

PW =28800usec,Period=100000usec, Level=A

RBW>2/PW=0.069K , PRF=1/T=0.01K ,

315MHz, FSK

PW =29600usec,Period=100000usec, Level=A

RBW>2/PW=0.068K , PRF=1/T=0.01K ,

433.92MHz, ASK

PW =16730usec,Period=100000usec, Level=A

RBW>2/PW=0.1K , PRF=1/T=0.01K ,

433.92MHz, FSK

PW =17600usec,Period=100000usec, Level=A

RBW>2/PW=0.1K , PRF=1/T=0.01K

NOTE: $2 / PW < RBW$, first don't need

- b. For the actual test, please refer to the ANSI C63.10,Annex C refer to section 7 for more detail



4.7 FIELD STRENGTH CALCULATION

The field strength is calculated by adding the Antenna Factor and Cable Factor and subtracting the Amplifier Gain and Duty Cycle Correction Factor (if any) from the measured reading. The basic equation with a sample calculation is as follows:

$$FS = RA + AF + CL - AG$$

Where

FS = Field Strength

CL = Cable Attenuation Factor (Cable Loss)

RA = Reading Amplitude

AG = Amplifier Gain

AF = Antenna Factor

For example

| Frequency (MHz) | FS (dB μ V/m) | RA (dB μ V/m) | AF (dB) | CL (dB) | AG (dB) | Factor (dB) |
|--------------------|----------------------|----------------------|------------|------------|------------|----------------|
| 300 | 40 | 58.1 | 12.2 | 1.6 | 31.9 | -18.1 |

$$\text{Factor} = \text{AF} + \text{CL} - \text{AG}$$

4.8 TEST RESULTS (EMISSION)

(Radiated Emission < 30MHz (9KHz-30MHz, H-field))

| | | | |
|--------------|--------|--------------------|-----|
| Temperature: | 20 °C | Relative Humidity: | 48% |
| Test Mode: | Mode 1 | Polarization: | -- |

| Freq. (MHz) | Reading (dBuV/m) | Limit (dBuV/m) | Margin (dB) | State P/F |
|----------------|---------------------|-------------------|----------------|--------------|
| -- | -- | -- | -- | PASS |
| -- | -- | -- | -- | PASS |

Note: The amplitude of spurious emissions which are attenuated by more than 20dB below the permissible value has no need to be reported.

Distance extrapolation factor = $40 \log(\text{specific distance}/\text{test distance})$ (dB);

Limit line = specific limits (dBuV) + distance extrapolation factor.



Between 30MHz – 5000 MHz

| | | | |
|--------------|------------|--------------------|--------|
| Temperature: | 23.1℃ | Relative Humidity: | 60% |
| Phase: | Horizontal | Test Mode: | Mode 1 |

| No. | Frequency (MHz) | Reading (dBuV) | Factor (dB) | Results (dBuV/m) | Limit (dBuV/m) | Margin (dB) | Detector |
|-----|-----------------|----------------|-------------|------------------|----------------|-------------|----------|
| 1 | 30.9700 | 31.01 | -13.35 | 17.66 | 40.00 | -22.34 | peak |
| 3 | 439.3400 | 30.10 | -10.10 | 20.00 | 46.00 | -26.00 | peak |
| 4 | 630.4300 | 34.82 | -5.03 | 29.79 | 46.00 | -16.21 | peak |
| 5 | 731.3100 | 28.30 | -2.42 | 25.88 | 46.00 | -20.12 | peak |
| 6 | 898.1500 | 31.67 | -0.49 | 31.18 | 46.00 | -14.82 | peak |

Fundamental Frequency

| No. | Frequency (MHz) | Reading (dBuV) | Correct Factor(dB/m) | Duty cycle Factor(dB) | Result (dBuV/m) | Limit (dBuV/m) | Margin (dB) | Remark |
|-----|-----------------|----------------|----------------------|-----------------------|-----------------|----------------|-------------|--------|
| 2 | 315.0000 | 83.11 | -14.22 | - | 68.89 | 87.66 | -18.77 | Peak |
| 7 | 315.0000 | 83.11 | -14.22 | 10.81 | 58.08 | 67.66 | -9.58 | AVG |

Remark:

- Margin = Result (Result =Reading + Factor) –Limit
- Factor= Antenna factor+Cable attenuation factor(cable loss)-Amplifier gain

100.0 dBuV/m

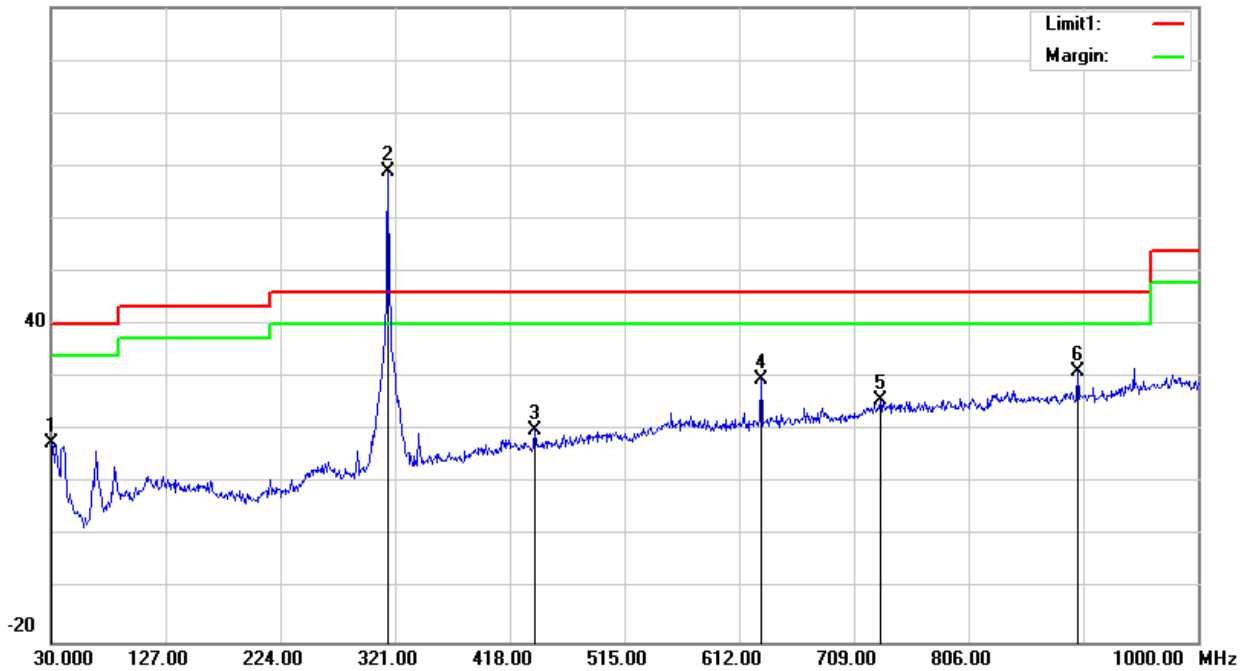



| | | | |
|--------------|----------|--------------------|--------|
| Temperature: | 23.1°C | Relative Humidity: | 60% |
| Phase: | Vertical | Test Mode: | Mode 1 |

| No. | Frequency (MHz) | Reading (dBuV) | Factor (dB) | Results (dBuV/m) | Limit (dBuV/m) | Margin (dB) | Detector |
|-----|-----------------|----------------|-------------|------------------|----------------|-------------|----------|
| 1 | 67.8300 | 55.33 | -25.28 | 30.05 | 40.00 | -9.95 | peak |
| 3 | 433.5200 | 39.35 | -10.13 | 29.22 | 46.00 | -16.78 | peak |
| 4 | 630.4300 | 38.62 | -5.03 | 33.59 | 46.00 | -12.41 | peak |
| 5 | 847.7100 | 29.61 | -0.66 | 28.95 | 46.00 | -17.05 | peak |
| 6 | 981.5700 | 27.47 | 2.57 | 30.04 | 54.00 | -23.96 | peak |

Fundamental Frequency

| No. | Frequency (MHz) | Reading (dBuV) | Correct Factor(dB/m) | Duty cycle Factor(dB) | Result (dBuV/m) | Limit (dBuV/m) | Margin (dB) | Remark |
|-----|-----------------|----------------|----------------------|-----------------------|-----------------|----------------|-------------|--------|
| 2 | 315.0000 | 78.79 | -14.22 | - | 64.57 | 87.66 | -23.09 | Peak |
| 7 | 315.0000 | 78.79 | -14.22 | 10.81 | 53.76 | 67.66 | -13.90 | AVG |

Remark:

- Margin = Result (Result = Reading + Factor) - Limit
- Factor = Antenna factor + Cable attenuation factor (cable loss) - Amplifier gain

100.0 dBuV/m

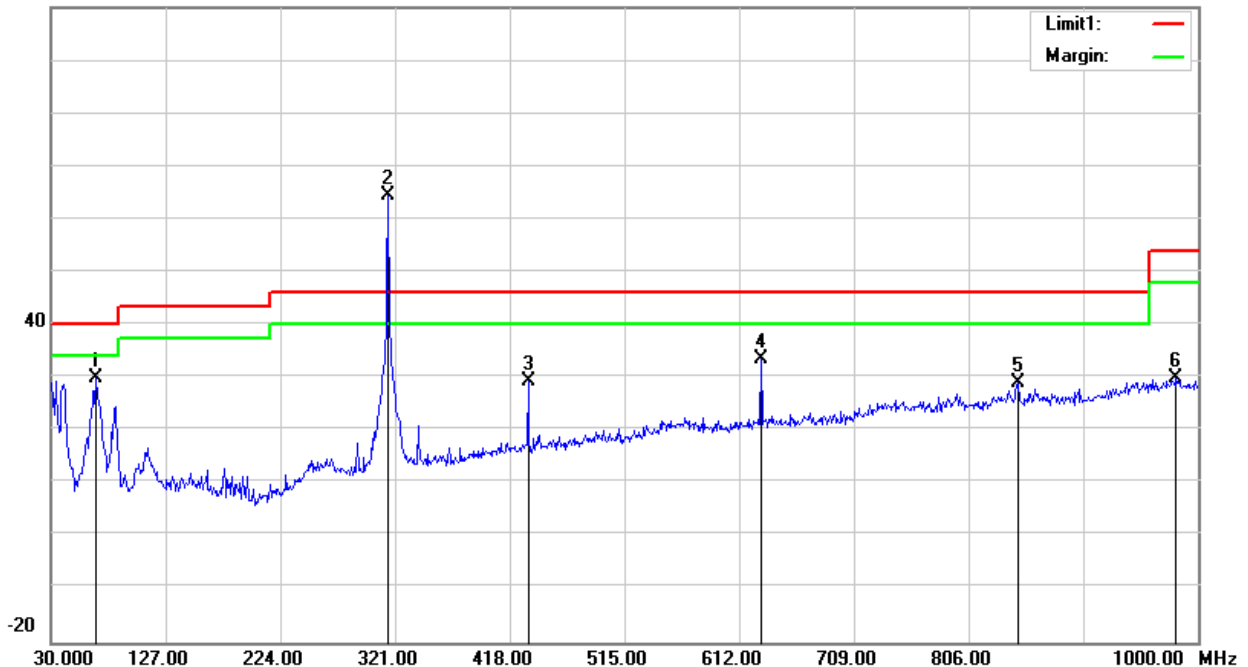



| | | | |
|--------------|------------|--------------------|--------|
| Temperature: | 23.1 °C | Relative Humidity: | 60% |
| Phase: | Horizontal | Test Mode: | Mode 2 |

| No. | Frequency (MHz) | Reading (dBuV) | Factor (dB) | Results (dBuV/m) | Limit (dBuV/m) | Margin (dB) | Detector |
|-----|-----------------|----------------|-------------|------------------|----------------|-------------|----------|
| 1 | 67.8300 | 50.11 | -25.28 | 24.83 | 40.00 | -15.17 | peak |
| 2 | 250.1900 | 31.21 | -16.10 | 15.11 | 46.00 | -30.89 | peak |
| 4 | 525.6700 | 29.07 | -7.61 | 21.46 | 46.00 | -24.54 | peak |
| 5 | 630.4300 | 37.02 | -5.03 | 31.99 | 46.00 | -14.01 | peak |
| 6 | 945.6800 | 29.78 | 1.50 | 31.28 | 46.00 | -14.72 | peak |

Fundamental Frequency

| No. | Frequency (MHz) | Reading (dBuV) | Correct Factor(dB/m) | Duty cycle Factor(dB) | Result (dBuV/m) | Limit (dBuV/m) | Margin (dB) | Remark |
|-----|-----------------|----------------|----------------------|-----------------------|-----------------|----------------|-------------|--------|
| 3 | 315.0000 | 83.00 | -14.22 | - | 68.78 | 87.66 | -18.88 | Peak |
| 7 | 315.0000 | 83.00 | -14.22 | 10.57 | 58.21 | 67.66 | -9.45 | AVG |

Remark:

- Margin = Result (Result = Reading + Factor) - Limit
- Factor = Antenna factor + Cable attenuation factor (cable loss) - Amplifier gain

100.0 dBuV/m

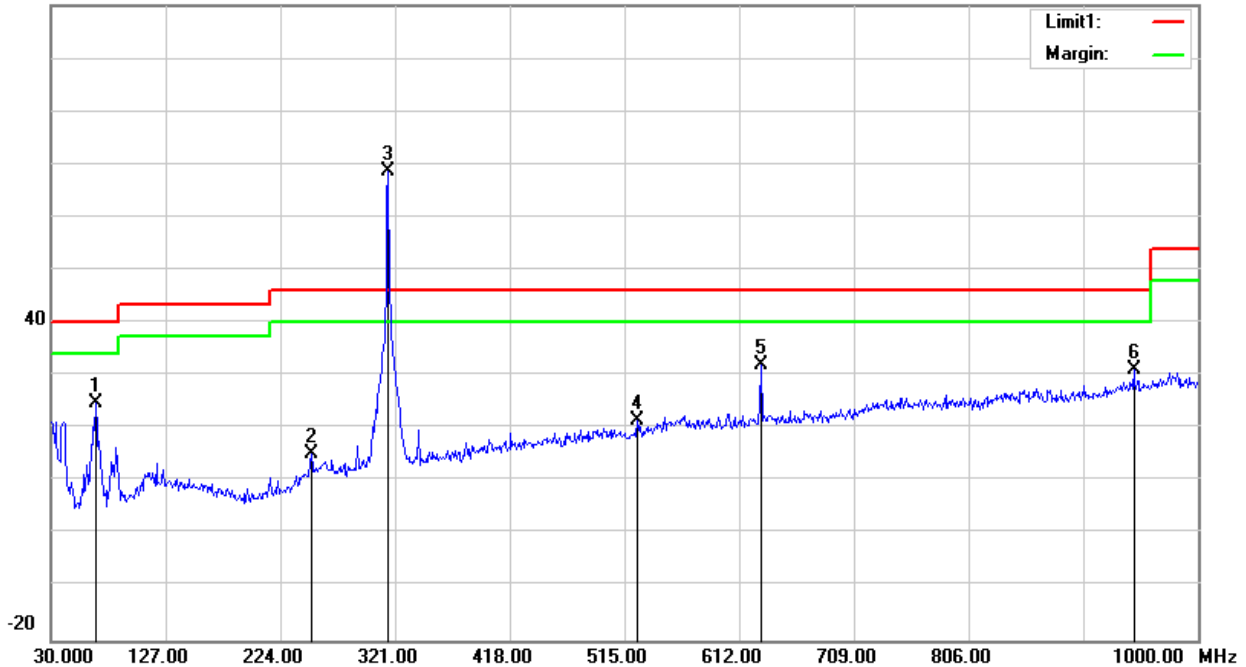



| | | | |
|--------------|----------|--------------------|--------|
| Temperature: | 23.1°C | Relative Humidity: | 60% |
| Phase: | Vertical | Test Mode: | Mode 2 |

| No. | Frequency (MHz) | Reading (dBuV) | Factor (dB) | Results (dBuV/m) | Limit (dBuV/m) | Margin (dB) | Detector |
|-----|-----------------|----------------|-------------|------------------|----------------|-------------|----------|
| 1 | 67.8300 | 55.43 | -25.28 | 30.15 | 40.00 | -9.85 | peak |
| 3 | 557.6800 | 28.82 | -5.55 | 23.27 | 46.00 | -22.73 | peak |
| 4 | 630.4300 | 40.50 | -5.03 | 35.47 | 46.00 | -10.53 | peak |
| 5 | 833.1600 | 27.94 | -0.62 | 27.32 | 46.00 | -18.68 | peak |
| 6 | 973.8100 | 27.99 | 2.25 | 30.24 | 54.00 | -23.76 | peak |

Fundamental Frequency

| No. | Frequency (MHz) | Reading (dBuV) | Correct Factor(dB/m) | Duty cycle Factor(dB) | Result (dBuV/m) | Limit (dBuV/m) | Margin (dB) | Remark |
|-----|-----------------|----------------|----------------------|-----------------------|-----------------|----------------|-------------|--------|
| 2 | 315.0000 | 78.49 | -14.22 | - | 64.27 | 87.66 | -23.39 | Peak |
| 7 | 315.0000 | 78.49 | -14.22 | 10.57 | 53.7 | 67.66 | -13.96 | AVG |

Remark:

- Margin = Result (Result = Reading + Factor) - Limit
- Factor = Antenna factor + Cable attenuation factor (cable loss) - Amplifier gain

100.0 dBuV/m

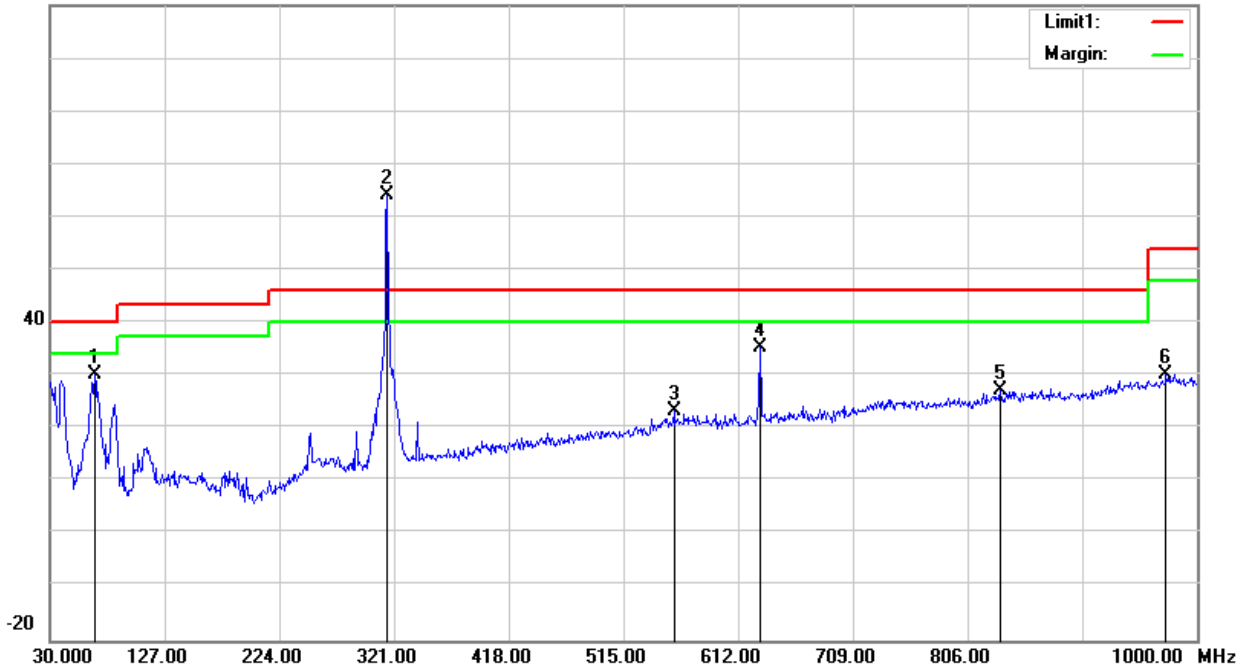



| | | | |
|--------------|------------|--------------------|--------|
| Temperature: | 23.1 °C | Relative Humidity: | 60% |
| Phase: | Horizontal | Test Mode: | Mode 3 |

| No. | Frequency (MHz) | Reading (dBuV) | Factor (dB) | Results (dBuV/m) | Limit (dBuV/m) | Margin (dB) | Detector |
|-----|-----------------|----------------|-------------|------------------|----------------|-------------|----------|
| 1 | 180.3500 | 48.89 | -20.04 | 28.85 | 43.50 | -14.65 | peak |
| 2 | 329.7300 | 42.04 | -13.71 | 28.33 | 46.00 | -17.67 | peak |
| 4 | 706.0900 | 27.53 | -3.98 | 23.55 | 46.00 | -22.45 | peak |
| 5 | 868.0800 | 32.41 | -0.51 | 31.90 | 46.00 | -14.10 | peak |
| 6 | 978.6600 | 26.99 | 2.58 | 29.57 | 54.00 | -24.43 | peak |

Fundamental Frequency

| No. | Frequency (MHz) | Reading (dBuV) | Correct Factor(dB/m) | Duty cycle Factor(dB) | Result (dBuV/m) | Limit (dBuV/m) | Margin (dB) | Remark |
|-----|-----------------|----------------|----------------------|-----------------------|-----------------|----------------|-------------|--------|
| 3 | 433.9200 | 77.46 | -10.13 | - | 67.33 | 92.87 | -25.54 | Peak |

Remark:

- Margin = Result (Result =Reading + Factor) –Limit
- Factor= Antenna factor+Cable attenuation factor(cable loss)-Amplifier gain

100.0 dBuV/m

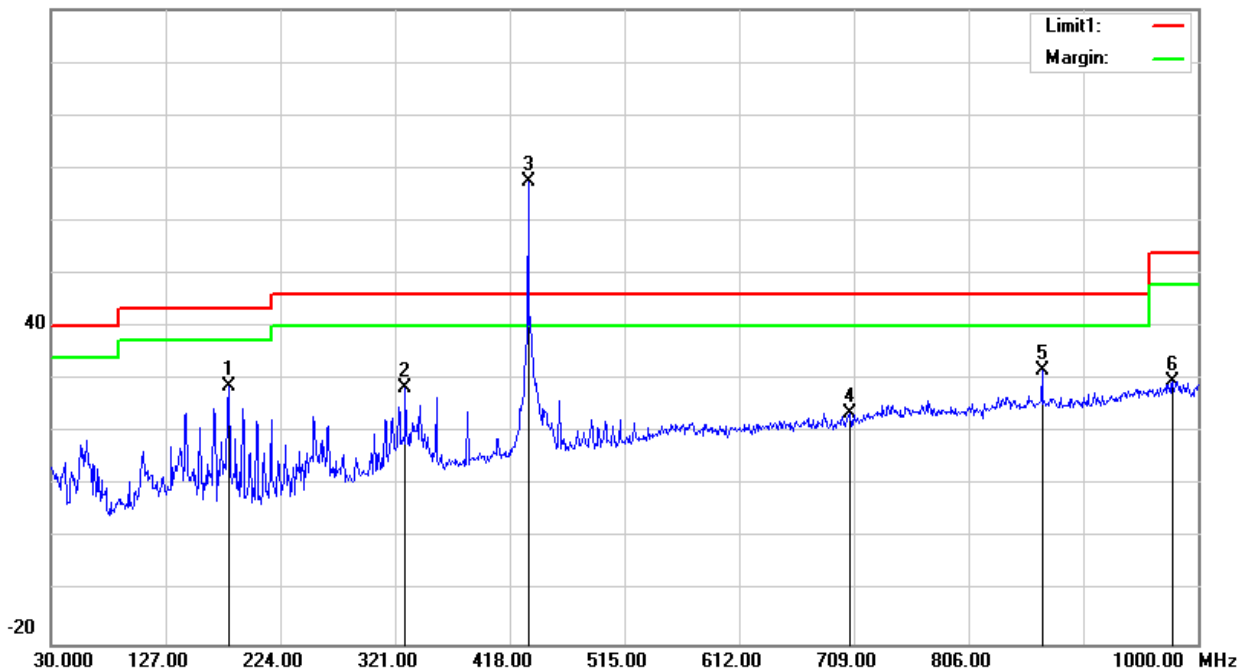



| | | | |
|--------------|----------|--------------------|--------|
| Temperature: | 23.1°C | Relative Humidity: | 60% |
| Phase: | Vertical | Test Mode: | Mode 3 |

| No. | Frequency (MHz) | Reading (dBuV) | Factor (dB) | Results (dBuV/m) | Limit (dBuV/m) | Margin (dB) | Detector |
|-----|-----------------|----------------|-------------|------------------|----------------|-------------|----------|
| 1 | 180.3500 | 48.52 | -20.04 | 28.48 | 43.50 | -15.02 | peak |
| 2 | 329.7300 | 40.72 | -13.71 | 27.01 | 46.00 | -18.99 | peak |
| 4 | 618.7900 | 27.22 | -5.49 | 21.73 | 46.00 | -24.27 | peak |
| 5 | 739.0700 | 27.06 | -2.15 | 24.91 | 46.00 | -21.09 | peak |
| 6 | 868.0800 | 31.64 | -0.51 | 31.13 | 46.00 | -14.87 | peak |

Fundamental Frequency

| No. | Frequency (MHz) | Reading (dBuV) | Correct Factor(dB/m) | Duty cycle Factor(dB) | Result (dBuV/m) | Limit (dBuV/m) | Margin (dB) | Remark |
|-----|-----------------|----------------|----------------------|-----------------------|-----------------|----------------|-------------|--------|
| 3 | 433.9200 | 83.51 | -10.13 | - | 73.38 | 92.87 | -19.49 | Peak |
| 7 | 433.9200 | 77.46 | -10.13 | 15.53 | 57.85 | 72.87 | -15.02 | AVG |

Remark:

- Margin = Result (Result = Reading + Factor) - Limit
- Factor = Antenna factor + Cable attenuation factor (cable loss) - Amplifier gain

100.0 dBuV/m

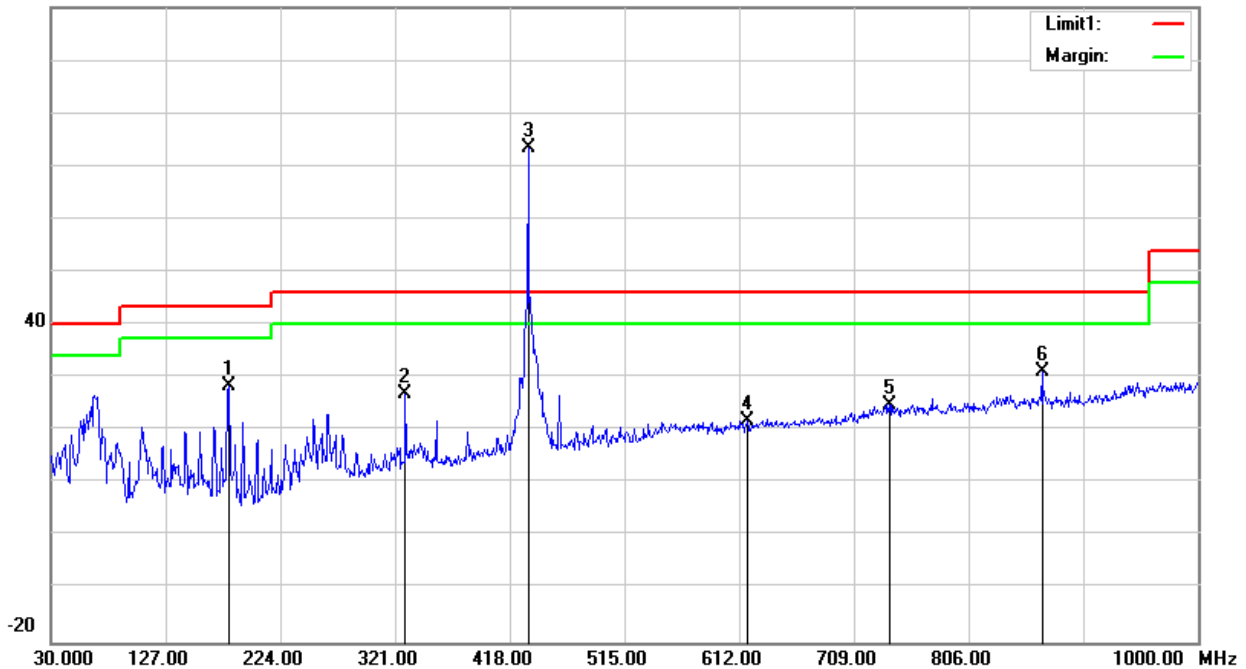



| | | | |
|--------------|------------|--------------------|--------|
| Temperature: | 23.1 °C | Relative Humidity: | 60% |
| Phase: | Horizontal | Test Mode: | Mode 4 |

| No. | Frequency (MHz) | Reading (dBuV) | Factor (dB) | Results (dBuV/m) | Limit (dBuV/m) | Margin (dB) | Detector |
|-----|-----------------|----------------|-------------|------------------|----------------|-------------|----------|
| 1 | 256.0100 | 46.03 | -15.24 | 30.79 | 46.00 | -15.21 | peak |
| 2 | 352.0400 | 34.36 | -13.02 | 21.34 | 46.00 | -24.66 | peak |
| 4 | 630.4300 | 37.81 | -5.03 | 32.78 | 46.00 | -13.22 | peak |
| 5 | 883.6000 | 29.78 | -0.67 | 29.11 | 46.00 | -16.89 | peak |
| 6 | 996.1200 | 28.03 | 2.04 | 30.07 | 54.00 | -23.93 | peak |

Fundamental Frequency

| No. | Frequency (MHz) | Reading (dBuV) | Correct Factor(dB/m) | Duty cycle Factor(dB) | Result (dBuV/m) | Limit (dBuV/m) | Margin (dB) | Remark |
|-----|-----------------|----------------|----------------------|-----------------------|-----------------|----------------|-------------|--------|
| 3 | 433.9200 | 74.04 | -10.13 | - | 63.91 | 92.87 | -28.96 | Peak |

Remark:

- Margin = Result (Result =Reading + Factor) –Limit
- Factor= Antenna factor+Cable attenuation factor(cable loss)-Amplifier gain

100.0 dBuV/m

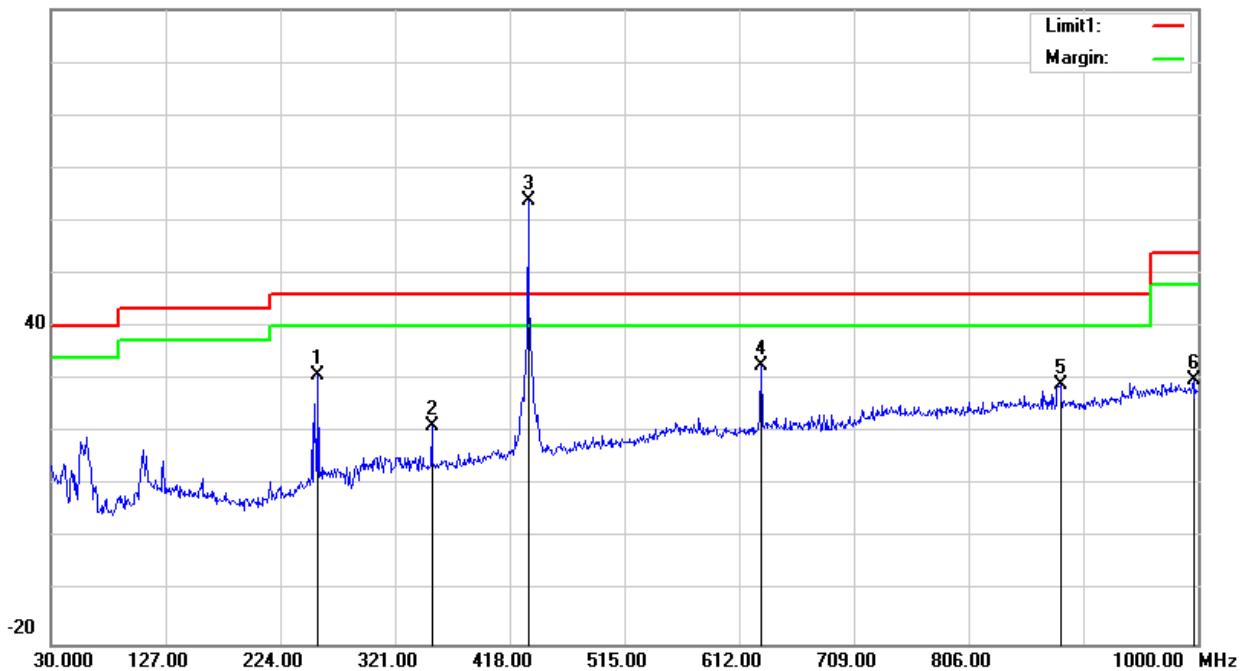



| | | | |
|--------------|----------|--------------------|--------|
| Temperature: | 23.1°C | Relative Humidity: | 60% |
| Phase: | Vertical | Test Mode: | Mode 4 |

| No. | Frequency (MHz) | Reading (dBuV) | Factor (dB) | Results (dBuV/m) | Limit (dBuV/m) | Margin (dB) | Detector |
|-----|-----------------|----------------|-------------|------------------|----------------|-------------|----------|
| 1 | 60.0700 | 48.95 | -25.86 | 23.09 | 40.00 | -16.91 | peak |
| 2 | 298.6900 | 29.14 | -14.86 | 14.28 | 46.00 | -31.72 | peak |
| 4 | 637.2200 | 28.04 | -4.90 | 23.14 | 46.00 | -22.86 | peak |
| 5 | 834.1300 | 42.60 | -0.59 | 42.01 | 46.00 | -3.99 | peak |
| 6 | 987.3900 | 27.05 | 2.21 | 29.26 | 54.00 | -24.74 | peak |

Fundamental Frequency

| No. | Frequency (MHz) | Reading (dBuV) | Correct Factor(dB/m) | Duty cycle Factor(dB) | Result (dBuV/m) | Limit (dBuV/m) | Margin (dB) | Remark |
|-----|-----------------|----------------|----------------------|-----------------------|-----------------|----------------|-------------|--------|
| 3 | 433.9200 | 83.45 | -10.13 | - | 73.32 | 92.87 | -19.55 | Peak |
| 7 | 433.9200 | 83.45 | -10.13 | 15.09 | 58.23 | 72.87 | -14.64 | AVG |

Remark:

- Margin = Result (Result = Reading + Factor) - Limit
- Factor = Antenna factor + Cable attenuation factor (cable loss) - Amplifier gain

100.0 dBuV/m

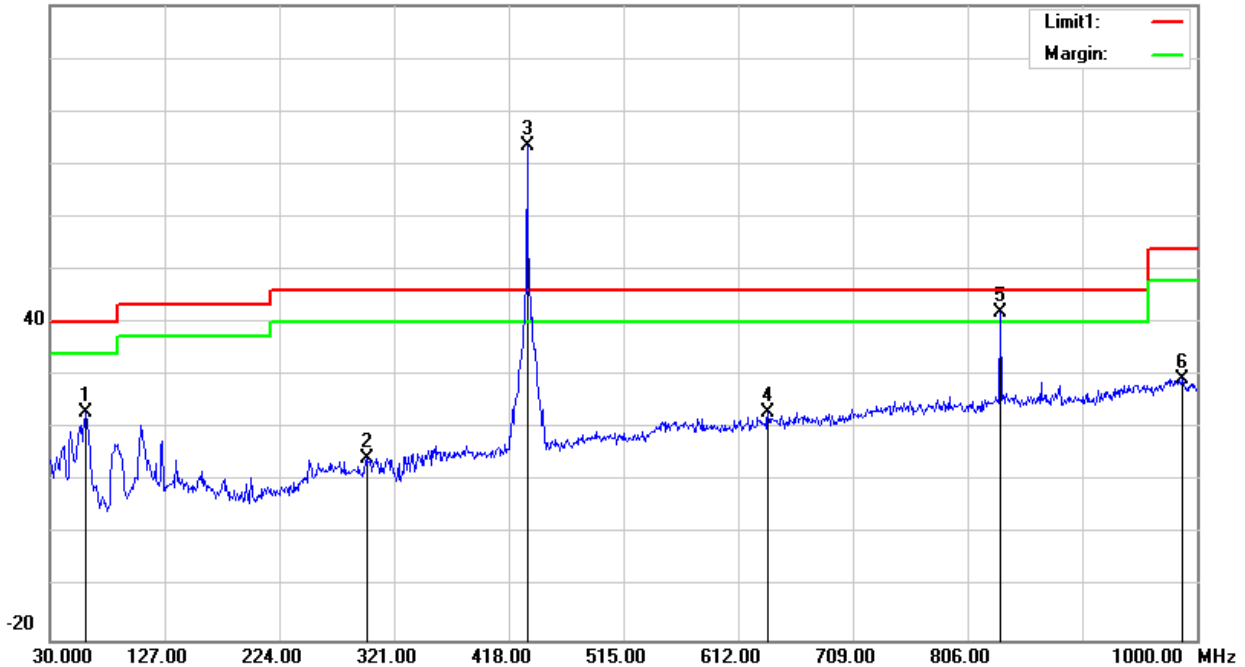



PEAK TEST RESULTS:

Mode 1

| Frequency | Reading | Detector | Amplifier | Loss | Antenna Factor | Corrected Factor | Corrected Amplitude | FCC Part 15.231/15.209/205 | | RX |
|-----------|----------------|------------|-----------|------|----------------|------------------|---------------------|----------------------------|--------|---------|
| | | | | | | | | Limit | Margin | Antenna |
| (MHz) | (dB μ V/m) | (PK/QP/AV) | (dB) | (dB) | (dB) | (dB) | (dB μ V/m) | (dB μ V/m) | (dB) | (H/V) |
| 1260.10 | 65.17 | PK | 45.1 | 4.0 | 25.1 | -16.00 | 49.17 | 74 | -24.83 | H |
| 1260.10 | 65.47 | PK | 45.1 | 4.0 | 25.1 | -16.00 | 49.47 | 74 | -24.53 | V |
| 1575.07 | 62.81 | PK | 44.1 | 5.3 | 25 | -13.80 | 49.01 | 74 | -24.99 | H |
| 1575.07 | 64.25 | PK | 44.1 | 5.3 | 25 | -13.80 | 50.45 | 74 | -23.55 | V |
| 1890.17 | 61.74 | PK | 43.8 | 5.4 | 25.9 | -12.47 | 49.28 | 74 | -24.72 | H |
| 1890.17 | 61.86 | PK | 43.8 | 5.4 | 25.9 | -12.47 | 49.39 | 74 | -24.61 | V |

Mode 2

| Frequency | Reading | Detector | Amplifier | Loss | Antenna Factor | Corrected Factor | Corrected Amplitude | FCC Part 15.231/15.209/205 | | RX |
|-----------|----------------|------------|-----------|------|----------------|------------------|---------------------|----------------------------|--------|---------|
| | | | | | | | | Limit | Margin | Antenna |
| (MHz) | (dB μ V/m) | (PK/QP/AV) | (dB) | (dB) | (dB) | (dB) | (dB μ V/m) | (dB μ V/m) | (dB) | (H/V) |
| 1260.04 | 65.16 | PK | 45.1 | 4.0 | 25.1 | -16.00 | 49.16 | 74 | -24.84 | H |
| 1260.04 | 65.43 | PK | 45.1 | 4.0 | 25.1 | -16.00 | 49.43 | 74 | -24.57 | V |
| 1574.95 | 63.03 | PK | 44.1 | 5.3 | 25 | -13.80 | 49.23 | 74 | -24.77 | H |
| 1574.95 | 64.54 | PK | 44.1 | 5.3 | 25 | -13.80 | 50.74 | 74 | -23.26 | V |
| 1889.94 | 61.48 | PK | 43.8 | 5.4 | 25.9 | -12.47 | 49.02 | 74 | -24.98 | H |
| 1889.94 | 61.93 | PK | 43.8 | 5.4 | 25.9 | -12.47 | 49.46 | 74 | -24.54 | V |



Mode 3

| Frequency | Reading | Detector | Amplifier | Loss | Antenna Factor | Corrected Factor | Corrected Amplitude | FCC Part 15.231/15.209/205 | | RX |
|-----------|----------------|------------|-----------|------|----------------|------------------|---------------------|----------------------------|--------|---------|
| | | | | | | | | Limit | Margin | Antenna |
| (MHz) | (dB μ V/m) | (PK/QP/AV) | (dB) | (dB) | (dB) | (dB) | (dB μ V/m) | (dB μ V/m) | (dB) | (H/V) |
| 1301.72 | 63.97 | PK | 45.1 | 4.0 | 25.1 | -16.00 | 47.97 | 74 | -26.03 | H |
| 1301.72 | 64.05 | PK | 45.1 | 4.0 | 25.1 | -16.00 | 48.05 | 74 | -25.95 | V |
| 1735.75 | 61.91 | PK | 44.1 | 5.3 | 25 | -13.80 | 48.11 | 74 | -25.89 | H |
| 1735.75 | 63.06 | PK | 44.1 | 5.3 | 25 | -13.80 | 49.26 | 74 | -24.74 | V |
| 2169.69 | 60.21 | PK | 43.8 | 5.4 | 25.9 | -12.47 | 47.75 | 74 | -26.25 | H |
| 2169.69 | 61.10 | PK | 43.8 | 5.4 | 25.9 | -12.47 | 48.63 | 74 | -25.37 | V |
| 2603.61 | 55.55 | PK | 44.4 | 6.0 | 27.6 | -10.77 | 44.79 | 74 | -29.21 | H |
| 2603.61 | 56.26 | PK | 44.4 | 6.0 | 27.6 | -10.77 | 45.50 | 74 | -28.50 | V |

Mode 4

| Frequency | Reading | Detector | Amplifier | Loss | Antenna Factor | Corrected Factor | Corrected Amplitude | FCC Part 15.231/15.209/205 | | RX |
|-----------|----------------|------------|-----------|------|----------------|------------------|---------------------|----------------------------|--------|---------|
| | | | | | | | | Limit | Margin | Antenna |
| (MHz) | (dB μ V/m) | (PK/QP/AV) | (dB) | (dB) | (dB) | (dB) | (dB μ V/m) | (dB μ V/m) | (dB) | (H/V) |
| 1301.75 | 65.13 | PK | 45.1 | 4.0 | 25.1 | -16.00 | 49.13 | 74 | -24.87 | H |
| 1301.75 | 65.52 | PK | 45.1 | 4.0 | 25.1 | -16.00 | 49.52 | 74 | -24.48 | V |
| 1735.82 | 63.02 | PK | 44.1 | 5.3 | 25 | -13.80 | 49.22 | 74 | -24.78 | H |
| 1735.82 | 64.53 | PK | 44.1 | 5.3 | 25 | -13.80 | 50.73 | 74 | -23.27 | V |
| 2169.73 | 61.46 | PK | 43.8 | 5.4 | 25.9 | -12.47 | 48.99 | 74 | -25.01 | H |
| 2169.73 | 61.96 | PK | 43.8 | 5.4 | 25.9 | -12.47 | 49.49 | 74 | -24.51 | V |
| 2603.56 | 57.03 | PK | 44.4 | 6.0 | 27.6 | -10.77 | 46.26 | 74 | -27.74 | H |
| 2603.56 | 57.46 | PK | 44.4 | 6.0 | 27.6 | -10.77 | 46.69 | 74 | -27.31 | V |

Note:

1. Above 2.6 GHz The amplitude of spurious emissions which are attenuated by more than 20dB below the permissible value has no need to be reported.
2. The peak value is less than the AV limit, so AV data does not need to be tested.

5. BANDWIDTH TEST

5.1 LIMIT

| FCC Part15.231,Subpart C RSS 210 Issue 10 | | | |
|--|---------------------------------|---|--------|
| Section | Test Item | Limit | Result |
| 15.231(C) RSS 210 A.1.3 | 20 Bandwidth & 99% Bandwidth | The 20dB bandwidth & 99% Bandwidth of the emissions shall not exceed 0.25% of the center frequency | PASS |

| Spectrum Parameter | Setting |
|--------------------|-------------------------|
| Attenuation | Auto |
| Span Frequency | > Measurement Bandwidth |
| RB | 1% to 5% of the OBW |
| VB | ≥3RB |
| Detector | Peak |
| Trace | Max Hold |
| Sweep Time | Auto |

5.2 TEST REQUIREMENTS

The bandwidth of the emission shall be no wider than 0.25% of the center frequency for devices operating above 70 MHz and below 900 MHz. For devices operating above 900 MHz, the emission shall be no wider than 0.5% of the center frequency. Bandwidth is determined at the points 20 dB down from the modulated carrier.

5.3 TEST PROCEDURE

- The EUT was directly connected to the spectrum analyzer and antenna output port as show in the block diagram below.
- Spectrum Setting: 1% to 5% of the OBW, VBW ≥ 3RBW, Sweep time = Auto.

5.4 TEST SETUP



5.5 EUT OPERATION CONDITIONS

TX mode.



5.6 TEST RESULTS

| | | | |
|--------------|--------|--------------------|-----|
| Temperature: | 25 °C | Relative Humidity: | 60% |
| Test Mode: | Mode 1 | | |

| Centre Frequency | Measurement | | | |
|------------------|----------------------|---------------------|------------|-----------------------|
| | 20dB Bandwidth (KHz) | 99% Bandwidth (KHz) | Limit(kHz) | Frequency Range (MHz) |
| 315 MHz | 27.16 | 55.951 | 787.5 | PASS |

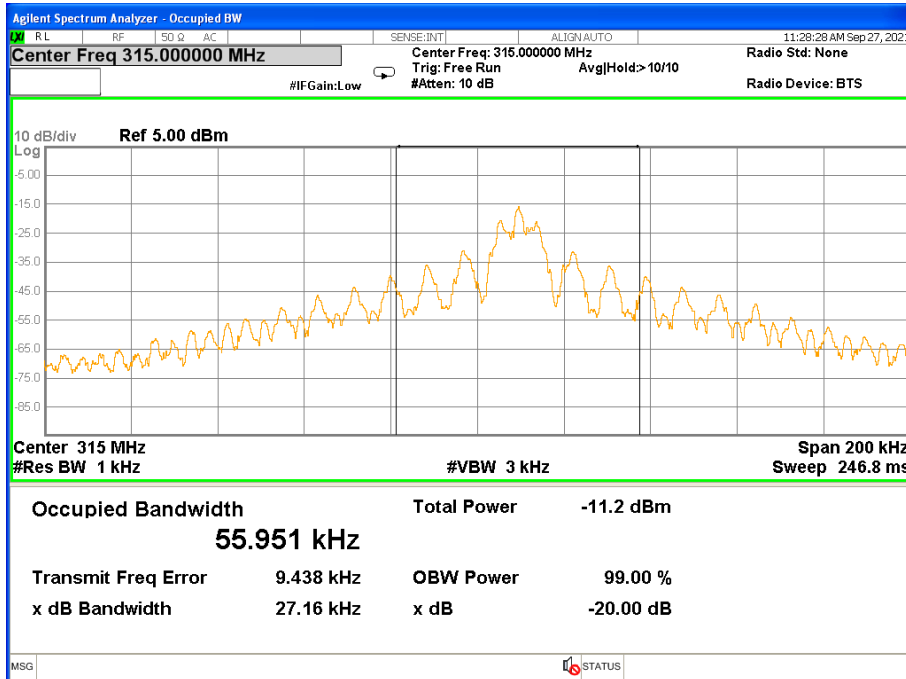



| | | | |
|--------------|--------|--------------------|-----|
| Temperature: | 25 °C | Relative Humidity: | 60% |
| Test Mode: | Mode 2 | | |

| Centre Frequency | Measurement | | | |
|------------------|----------------------|---------------------|------------|-----------------------|
| | 20dB Bandwidth (KHz) | 99% Bandwidth (KHz) | Limit(kHz) | Frequency Range (MHz) |
| 315 MHz | 110.0 | 112.81 | 787.5 | PASS |

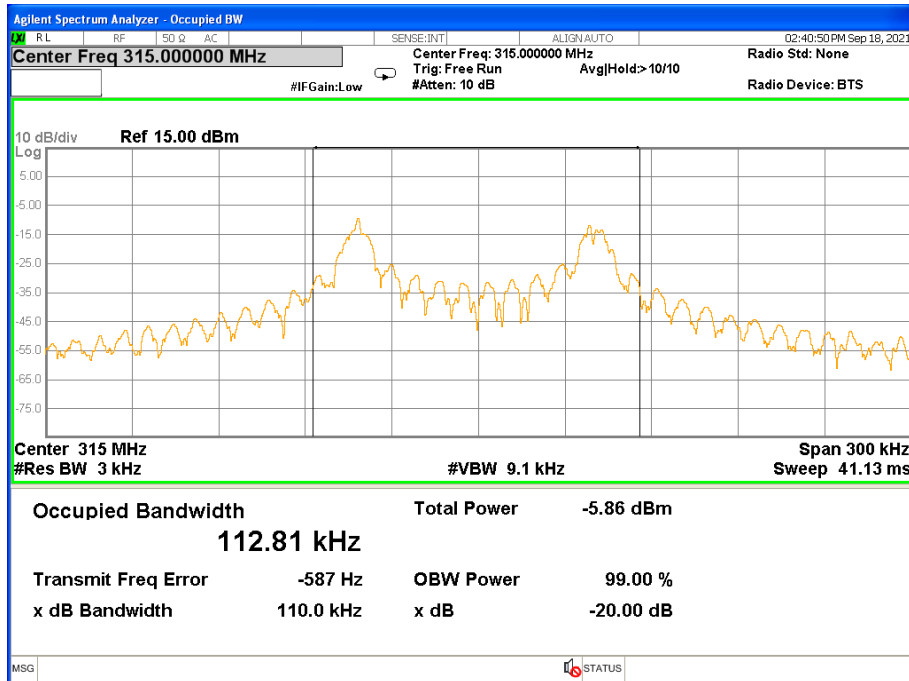



| | | | |
|--------------|--------|--------------------|-----|
| Temperature: | 25 °C | Relative Humidity: | 60% |
| Test Mode: | Mode 3 | | |

| Centre Frequency | Measurement | | | |
|------------------|----------------------|---------------------|------------|-----------------------|
| | 20dB Bandwidth (KHz) | 99% Bandwidth (KHz) | Limit(kHz) | Frequency Range (MHz) |
| 433.92 MHz | 26.63 | 42.844 | 1085 | PASS |

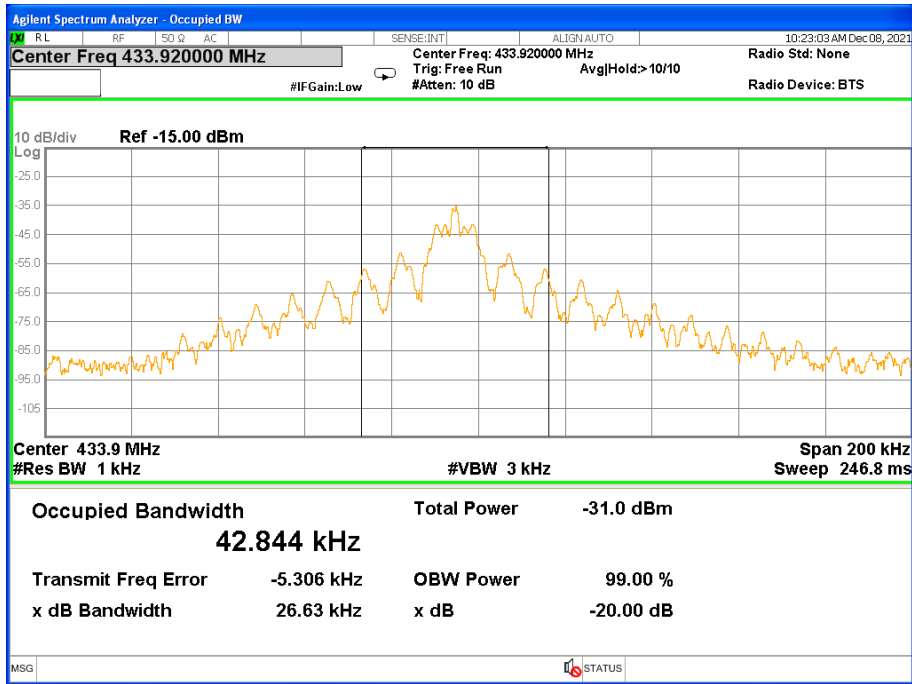



| | | | |
|--------------|--------|--------------------|-----|
| Temperature: | 25 °C | Relative Humidity: | 60% |
| Test Mode: | Mode 4 | | |

| Centre Frequency | Measurement | | | |
|------------------|----------------------|---------------------|------------|-----------------------|
| | 20dB Bandwidth (KHz) | 99% Bandwidth (KHz) | Limit(kHz) | Frequency Range (MHz) |
| 433.92 MHz | 98.23 | 111.45 | 1085 | PASS |

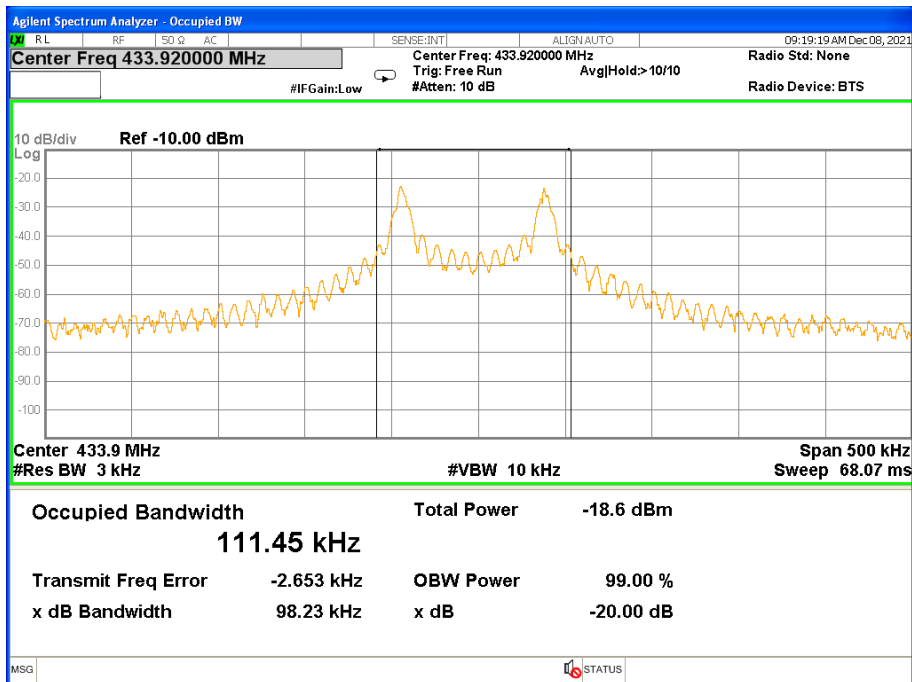

6. TRANSMITTER TIMEOUT

6.1 LIMIT

In addition, devices operated under the provisions of this paragraph shall be provided with a means for automatically limiting operation so that the duration of each transmission shall not be greater than one second and the silent period between transmissions shall be at least 30 times the duration of the but in no case less than 10 seconds.

6.2 TEST PROCEDURE

- (1) Put the EUT on the support in its standard position with associated equipment and switched on.
- (2) Set center frequency of spectrum analyzer = operating frequency.
- (3) Set the spectrum analyzer as RBW=100kHz, VBW=100kHz, Span=0Hz, Adjust Sweep=Auto.
- (4) record the duration time

6.3 TEST SETUP





6.4 TEST RESULTS

| | | | |
|--------------|--------|--------------------|-----|
| Temperature: | 26 °C | Relative Humidity: | 53% |
| Test Mode: | Mode 1 | | |

| Frequency(MHz) | Each transmission time(s) | silent period between transmissions(s) |
|----------------|---------------------------|--|
| 315 | 0.39 | 15.6 |
| Limit | <1s | >10s and > 30*(duration of transmission) |
| Result | Pass | |





| | | | |
|--------------|--------|--------------------|-----|
| Temperature: | 26 °C | Relative Humidity: | 53% |
| Test Mode: | Mode 2 | | |

| Frequency(MHz) | Each transmission time(s) | silent period between transmissions(s) |
|----------------|---------------------------|--|
| 315 | 0.39 | 15.54 |
| Limit | <1s | >10s and > 30*(duration of transmission) |
| Result | Pass | |





| | | | |
|--------------|--------|--------------------|-----|
| Temperature: | 26 °C | Relative Humidity: | 53% |
| Test Mode: | Mode 3 | | |

| Frequency(MHz) | Each transmission time(s) | silent period between transmissions(s) |
|----------------|---------------------------|--|
| 433.92 | 0.92 | 30.4 |
| Limit | <1s | >10s and > 30*(duration of transmission) |
| Result | Pass | |





| | | | |
|--------------|--------|--------------------|-----|
| Temperature: | 26 °C | Relative Humidity: | 53% |
| Test Mode: | Mode 4 | | |

| Frequency(MHz) | Each transmission time(s) | silent period between transmissions(s) |
|----------------|---------------------------|--|
| 433.92 | 0.88 | 28.56 |
| Limit | <1s | >10s and > 30*(duration of transmission) |
| Result | Pass | |



7. PERIODIC OPERATION

7.1 TEST PROCEDURE

The EUT was directly connected to the spectrum analyzer and antenna output port as show in the block diagram below.

The Duty Cycle Was Determined By The Following Equation: To Calculate The Actual Field Intensity,The Duty Cycle Correction Factor In Decibel Is Needed For Later Use And Can Be Obtained From Following Conversion

Duty Cycle(%)=Total On Interval In A Complete Pulse Train/ Length Of A Complete Pulse Train * %

Duty Cycle Correction Factor(dB)=20 * Log10(Duty Cycle(%))

7.2 TEST SETUP



7.3 EUT OPERATION CONDITIONS

TX mode.



7.4 TEST RESULTS

Mode 1

| FCC Part15.231(e) RSS 210 Issue 10 | |
|---|--------|
| Total On interval in a complete pulse train(ms) | 28.8 |
| Length of a complete pulse train(ms) | 100 |
| Duty Cycle(%) | 28.80% |
| Duty Cycle Correction Factor(dB) | 10.81 |

Refer to the duty cycle plot (as below), This device meets the FCC requirement. Length of a complete pulse train

Remark:FCC part15.35(c) and RSS 210 required that a complete pulse train is more than 0.1 seconds, the measured field strength shall be determined from the average absolute voltage during a 0.1 second interval during which the field strength is at its maximum value.







Mode 2

| FCC Part15.231(e) RSS 210 Issue 10 | |
|---|--------|
| Total On interval in a complete pulse train(ms) | 29.6 |
| Length of a complete pulse train(ms) | 100 |
| Duty Cycle(%) | 29.60% |
| Duty Cycle Correction Factor(dB) | 10.57 |

Refer to the duty cycle plot (as below), This device meets the FCC requirement. Length of a complete pulse train

Remark:FCC part15.35(c) and RSS 210 required that a complete pulse train is more than 0.1 seconds, the measured field strength shall be determined from the average absolute voltage during a 0.1 second interval during which the field strength is at its maximum value.



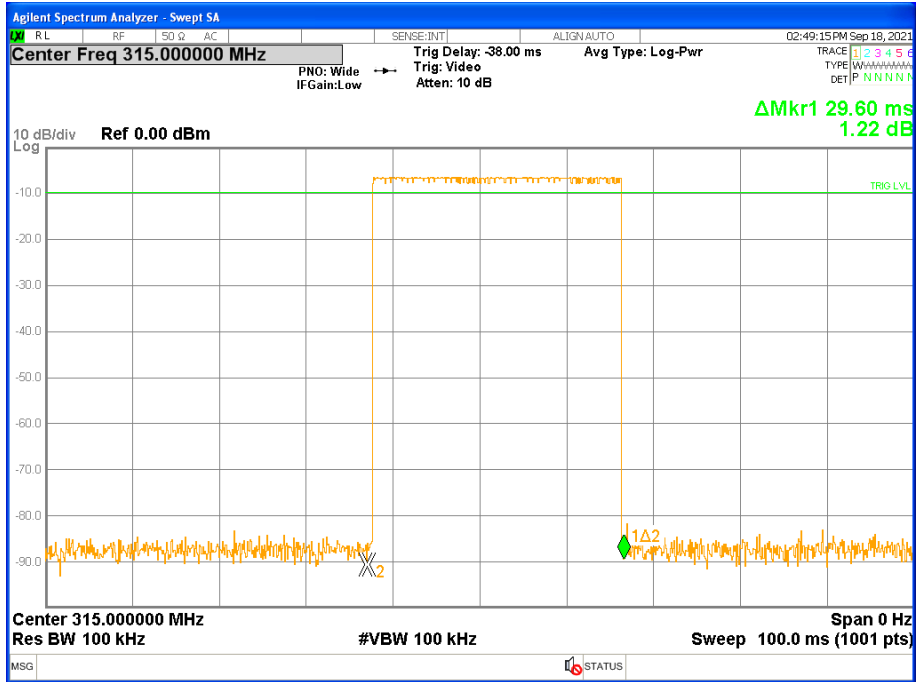



Mode 3

| FCC Part15.231(e) RSS 210 Issue 10 | |
|---|--------|
| Total On interval in a complete pulse train(ms) | 16.73 |
| Length of a complete pulse train(ms) | 100 |
| Duty Cycle(%) | 16.73% |
| Duty Cycle Correction Factor(dB) | 15.53 |

Refer to the duty cycle plot (as below), This device meets the FCC requirement. Length of a complete pulse train
Remark:FCC part15.35(c) and RSS 210 required that a complete pulse train is more than 0.1 seconds, the measured field strength shall be determined from the average absolute voltage during a 0.1 second interval during which the field strength is at its maximum value.

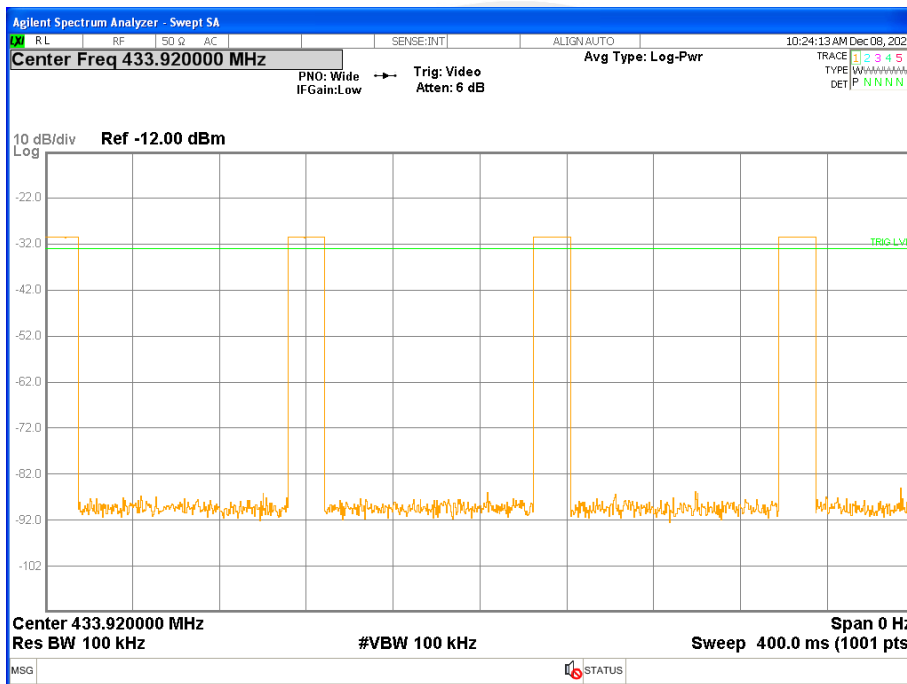

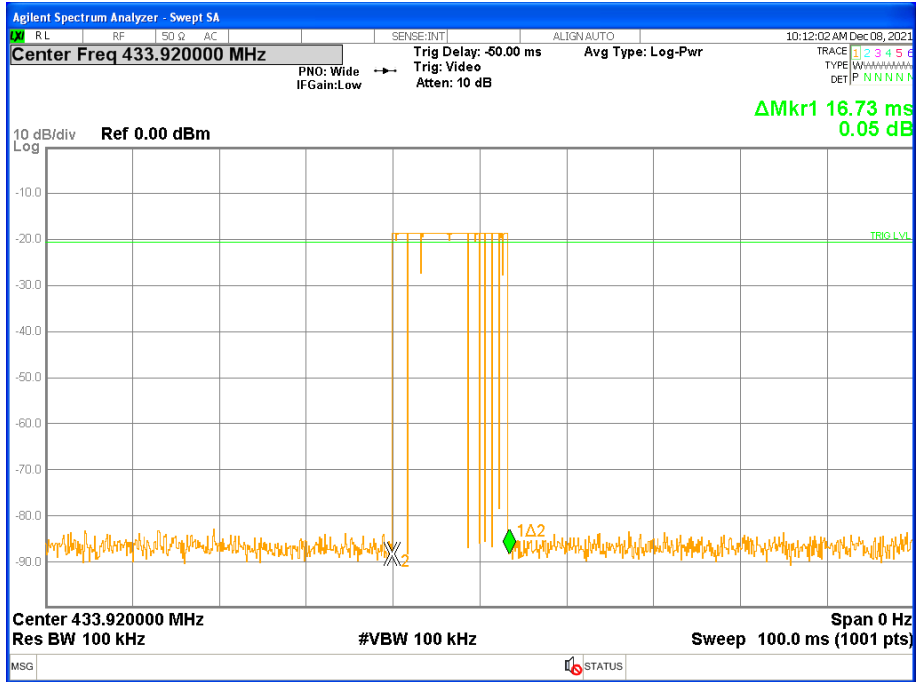



Mode 4

| FCC Part15.231(e) RSS 210 Issue 10 | |
|---|--------|
| Total On interval in a complete pulse train(ms) | 17.6 |
| Length of a complete pulse train(ms) | 100 |
| Duty Cycle(%) | 17.60% |
| Duty Cycle Correction Factor(dB) | 15.09 |

Refer to the duty cycle plot (as below), This device meets the FCC requirement. Length of a complete pulse train

Remark:FCC part15.35(c) and RSS 210 required that a complete pulse train is more than 0.1 seconds, the measured field strength shall be determined from the average absolute voltage during a 0.1 second interval during which the field strength is at its maximum value.

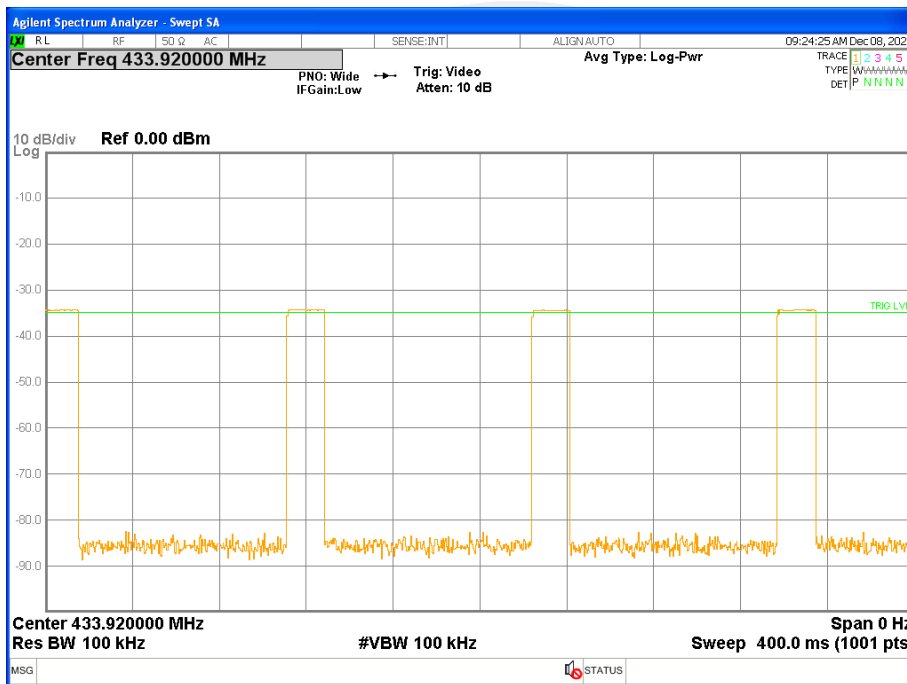

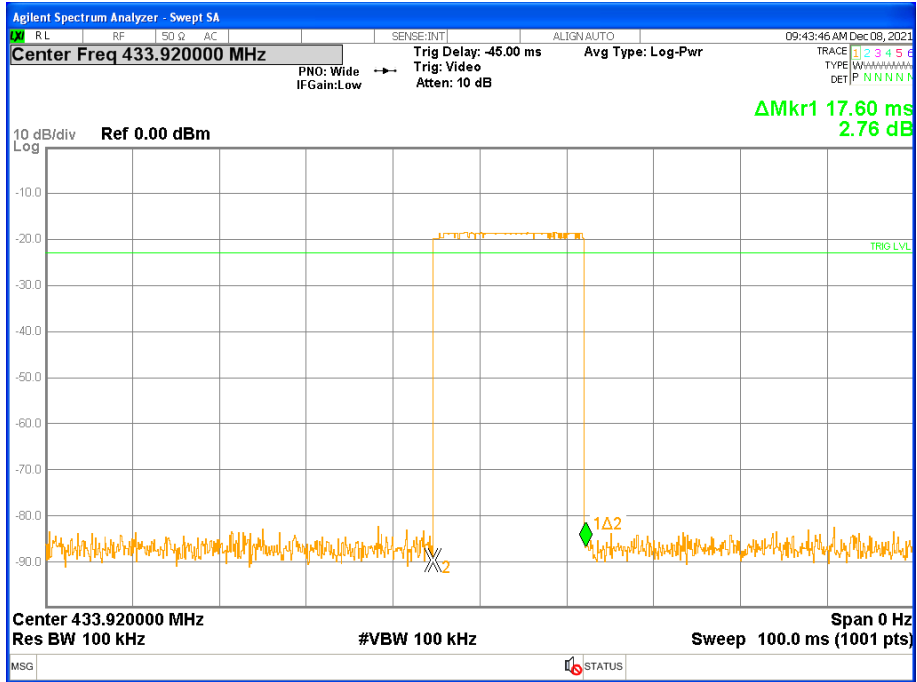



8. ANTENNA REQUIREMENT

8.1 STANDARD REQUIREMENT

According to the FCC Part 15 Paragraph 15.203 and RSS Gen, an intentional radiator shall be designed to ensure that no antenna other than that furnished by the responsible party shall be used with the device. The use of a permanently attached antenna to the intentional radiator shall be considered sufficient to comply with the provisions of this section. This product use a permanent ceramic printed antenna, fulfill the requirement of this section

8.2 EUT ANTENNA

The EUT antenna is Internal antenna.It conforms to the standard requirements.





APPENDIX 1-PHOTOS OF TEST SETUP

Note: See test photos in setup photo document for the actual connections between Product and support equipment.

*****END OF THE REPORT*****

