



Test report No:  
2180930R-RF-US-P06V02

## FCC & ISED TEST REPORT

Product Name	DriveWell Tag
Trademark	
Model and /or type reference	DriveWell Tag v6.2
FCC ID	2AFGD000620
IC	22582-000620
Applicant's name / address	Cambridge Mobile Telematics 314 Main Street, Suite 1200, Cambridge, MA 02142, USA
Test method requested, standard	FCC CFR Title 47 Part 15 Subpart C Section 15.247 ANSI C63.10: 2013 KD558074 D01 15.247 Meas Guidance v05r02 RSS-Gen Issue 5 RSS-247 Issue 2
Verdict Summary	IN COMPLIANCE
Tested by (name / position & signature)	Adma Lu / Project Engineer 
Approved by (name / position & signature)	Jack Zhang/Supervisor 
Date of issue	2021-09-14
Report Version	V1.0
Report template No	Template_FCC 15.247-RF-V1.0

## INDEX

	page
General conditions .....	4
Environmental conditions .....	4
Possible test case verdicts .....	5
Abbreviations.....	5
Document History.....	6
Remarks and Comments .....	6
Used Equipment.....	7
Uncertainty .....	9
1 General Information .....	10
1.1 General Description of the Item(s).....	10
1.2 Antenna Information .....	11
1.3 Channel List.....	11
2 Description of Test Setup.....	12
2.1 Operating mode(s) used for tests .....	12
2.2 Auxiliary equipment / Test software for the EUT .....	12
2.3 Test Configuration / Block diagram used for tests.....	13
2.4 Testing process .....	14
3 Verdict summary section.....	15
3.1 Standards .....	15
3.2 Deviation(s) from the Standard(s) / Test Specification(s).....	15
3.3 Overview of results .....	16
3.4 Test Facility.....	17
4 Test Results .....	18
4.1 AC Power Line Conducted Emission.....	18
4.1.1 Limit .....	18
4.1.2 Test Setup .....	18
4.1.3 Test Procedure .....	18
4.1.4 Test Data .....	19
4.2 Emissions in restricted frequency bands .....	20
4.2.1 Limit .....	20
4.2.2 Test Setup .....	22
4.2.3 Test Procedure .....	22
4.2.4 Test Data .....	23
4.3 Emissions in non-restricted frequency band .....	37

---

4.3.1	Limit .....	37
4.3.2	Test Setup .....	37
4.3.3	Test Procedure .....	37
4.3.4	Test Data .....	38
4.4	Duty cycle .....	40
4.4.1	Limit .....	40
4.4.2	Test Setup .....	40
4.4.3	Test Procedure .....	40
4.4.4	Test Data .....	41
4.5	Radiated Emission Band Edge .....	42
4.5.1	Limit .....	42
4.5.2	Test Setup .....	42
4.5.3	Test Procedure .....	42
4.5.4	Test Data .....	43
4.6	DTS Bandwidth .....	59
4.6.1	Limit .....	59
4.6.2	Test Setup .....	59
4.6.3	Test Procedure .....	59
4.6.4	Test Data .....	60
4.7	Fundamental emission output power .....	61
4.7.1	Limit .....	61
4.7.2	Test Setup .....	61
4.7.3	Test Procedure .....	62
4.7.4	Test Data .....	63
4.8	Power Density .....	64
4.8.1	Limit: .....	64
4.8.2	Test Setup .....	64
4.8.3	Test Procedure .....	64
4.8.4	Test Data .....	65
4.9	Antenna Requirement .....	66
4.9.1	Limit: .....	66
4.9.2	Antenna Connector Construction: .....	66
5	Test setup photo and EUT Photo .....	67

## COMPETENCES AND GUARANTEES

DEKRA is a testing laboratory competent to carry out the tests described in this report.

In order to assure the traceability to other national and international laboratories, DEKRA has a calibration and maintenance program for its measurement equipment.

DEKRA guarantees the reliability of the data presented in this report, which is the result of the measurements and the tests performed to the item under test on the date and under the conditions stated in the report and it is based on the knowledge and technical facilities available at DEKRA at the time of performance of the test.

DEKRA is liable to the client for the maintenance of the confidentiality of all information related to the item under test and the results of the test.

The results presented in this Test Report apply only to the particular item under test established in this document.

**IMPORTANT:** No parts of this report may be reproduced or quoted out of context, in any form or by any means, except in full, without the previous written permission of DEKRA.

## GENERAL CONDITIONS

Test Location	No. 99, Hongye Road, Suzhou Industrial Park Suzhou, 215006, P.R. China
Date(receive sample)	Aug. 23, 2021
Date (start test)	Aug. 26, 2021
Date (finish test)	Sep. 08, 2021

1. This report is only referred to the item that has undergone the test.
2. This report does not constitute or imply on its own an approval of the product by the Certification Bodies or Competent Authorities.
3. This document is only valid if complete; no partial reproduction can be made without previous written permission of DEKRA.
4. This test report cannot be used partially or in full for publicity and/or promotional purposes without previous written permission of DEKRA.

## ENVIRONMENTAL CONDITIONS

The climatic conditions during the tests are within the limits specified by the manufacturer for the operation of the EUT and the test equipment. The climatic conditions during the tests were within the following limits:

Ambient temperature	15 °C – 35 °C
Relative Humidity air	30% - 60%

If explicitly required in the basic standard or applied product / product family standard the climatic values are recorded and documented separately in this test report.

## POSSIBLE TEST CASE VERDICTS

Test case does not apply to test object	N/A
Test object does meet requirement	P (Pass) / PASS
Test object does not meet requirement	F (Fail) / FAIL
Not measured	N/M

## ABBREVIATIONS

For the purposes of the present document, the following abbreviations apply:

EUT	: Equipment Under Test
QP	: Quasi-Peak
CAV	: CISPR Average
AV	: Average
CDN	: Coupling Decoupling Network
SAC	: Semi-Anechoic Chamber
OATS	: Open Area Test Site
BW	: Bandwidth
AM	: Amplitude Modulation
PM	: Pulse Modulation
HCP	: Horizontal Coupling Plane
VCP	: Vertical Coupling Plane
$U_N$	: Nominal voltage
$T_x$	: Transmitter
$R_x$	: Receiver
N/A	: Not Applicable
N/M	: Not Measured

## DOCUMENT HISTORY

Report No.	Version	Description	Issued Date
2180930R-RF-US-P06V02	V1.0	Initial issue of report.	2021-09-14

## REMARKS AND COMMENTS

1. The equipment under test (EUT) does meet the essential requirements of the stated standard(s)/test(s).
2. These test results on a sample of the device are for the purpose of demonstrating Compliance with Part 15 Subpart C Paragraph 15.247, RSS-Gen Issue 5, RSS-247 Issue 2.
3. The measurement result is considered in conformance with the requirement if it is within the prescribed limit, It is not necessary to account the uncertainty associated with the measurement result.
4. The test results presented in this report relate only to the object tested.
5. The test report shall not be reproduced without the written approval of DEKRA Testing and Certification (Suzhou) Co., Ltd.
6. This report will not be used for social proof function in China market.
7. DEKRA declines any responsibility with the following test data provided by customer that may affect the validity of result:
  - Chapter 1.1 General Description of the Item(s);
  - Chapter 1.2 Antenna Information;
  - Chapter 1.3 Channel List.

## USED EQUIPMENT

### AC Power Line Conducted Emission / TR1

Instrument	Manufacturer	Model No.	Serial No.	Cal. Date	Next Cal. Date
Two-Line V-Network	R&S	ENV216	101044	2021.03.20	2022.03.19
50ohm Termination	SHX	TF2	7081402	2020.09.23	2021.09.22
50ohm Termination	SHX	TF2	7081403	2020.09.23	2021.09.22
50ohm Coaxial Switch	Anritsu	MP59B	6200464462	N/A	N/A
Temperature/Humidity Meter	RTS	RTS-8S	TR1-TH	2021.07.09	2022.07.08
Dekra test software	Dekra	-	-	-	-

### Emissions in non-restricted frequency bands/ Occupied Bandwidth/ Fundamental emission output power/ Power Spectral Density / TR8

Instrument	Manufacturer	Model No.	Serial No.	Cal. Date	Next Cal. Date
Spectrum Analyzer	Agilent	N9010A	MY48030494	2021.07.11	2022.07.10
EXA Spectrum Analyzer	Keysight	N9010A	MY55370495	2021.03.20	2022.03.19
MXA Signal Analyzer	Keysight	N9020A	MY56060147	2021.07.11	2022.07.10
4TX MIMO Power Sensor	Keysight	X8750A	MY59400102	2021.03.31	2022.03.30
Coaxial Cable	Woken	SFL402	F02-150410-044	2021.01.01	2021.12.31
Temperature/Humidity Meter	RTS	RTS-8S	RF08	2021.07.09	2022.07.08

### Radiated Emission(30MHz-1GHz) / AC3

Instrument	Manufacturer	Model No.	Serial No.	Cal. Date	Next Cal. Date
EMI Test Receiver	R&S	ESCI	100176	2021.08.15	2022.08.14
Bilog Antenna	Teseq GmbH	CBL6112D	27613	2020.11.27	2021.11.26
Coaxial Cable	Huber+Suhner	RG 214	AC3-C	2021.03.31	2022.03.30
Temperature/Humidity Meter	RTS	RTS-8S	AC3-TH	2021.07.09	2022.07.08
Dekra test software	Dekra	-	-	-	-

## Radiated Emission(1GHz-40GHz) / AC5

Instrument	Manufacturer	Model No.	Serial No.	Cal. Date	Next Cal. Date
EXA Spectrum Analyzer	Keysight	N9010A	MY55370495	2021.03.20	2022.03.19
Amplifier	Keleto	LNPA	SK20190225	2020.09.25	2021.09.24
Preamplifier	EMCI	EMC184045SE	980263	2021.05.22	2022.05.21
DRG Horn Antenna	ETS-Lindgren	3117	00167055	2020.09.21	2021.09.20
Broad-Band Horn Antenna	Schwarzbeck	BBHA9170	294	2021.04.14	2023.04.13
Coaxial Cable	Huber+Suhner	SUCOFLEX 106	AC5-C2	2021.03.31	2022.03.30
Coaxial Cable	ROSENBERGER	LA1-C011- 2000/3000	AC5-40G	2021.03.20	2022.03.19
Temperature/Humidity Meter	RTS	RTS-8S	AC5-TH	2021.07.09	2022.07.08
Dekra test software	Dekra	-	-	-	-



## UNCERTAINTY

Uncertainties have been calculated according to the DEKRA internal document. The reported expanded uncertainties are based on a standard uncertainty multiplied by a coverage factor of  $k=2$ , providing a level of confidence of approximately 95%. The Uncertainties is comply with standard required as below.

Test item	Uncertainty
AC Power Line Conducted Emission	9kHz~150kHz: 2.80dB 150kHz~30MHz: 2.40dB
Peak Power Output	$\pm 1.27$ dB
Radiated Emission(30MHz~1GHz)	Horizontal: 30MHz~200MHz: 3.50 dB 300MHz~1GHz: 3.60 dB Vertical: 30MHz~200MHz: 3.60 dB 300MHz~1GHz: 3.50 dB
Radiated Emission(1GHz~26.5GHz)	Horizontal: 1GHz~18GHz: 5.00 dB Vertical: 1GHz~18GHz: 4.80 dB
RF antenna conducted test	$\pm 1.27$ dB
Radiated Emission Band Edge	$\pm 3.9$ dB
DTS Bandwidth	$\pm 150$ Hz
Occupied Bandwidth	$\pm 1$ kHz
Power Density	$\pm 1.27$ dB

# 1 GENERAL INFORMATION

## 1.1 General Description of the Item(s)

Product Name .....	DriveWell Tag
Model No. ....	DriveWell Tag v6.2
FCC ID .....	2AFGD000620
IC .....	22582-000620
Manufacturer .....	Cambridge Mobile Telematics
Manufacturer Address .....	314 Main Street, Suite 1200, Cambridge, MA 02142, USA

Wireless specification.....	Bluetooth					
Operating frequency range(s) .....	2400~2483.5MHz					
Type of Modulation.....	GFSK					
PHYs .....	<input checked="" type="checkbox"/>	LE 1M	<input checked="" type="checkbox"/>	LE 2M	<input type="checkbox"/>	LE Coded S=2/8
Data Rate .....	<input checked="" type="checkbox"/>	1Mbit/s	<input checked="" type="checkbox"/>	2Mbit/s	<input type="checkbox"/>	500/125 Kbit/s
Number of channel .....	40					

Rated power supply .....	Voltage and Frequency					
	<input type="checkbox"/>	AC: 220 – 240 V, 50/60 Hz				
	<input type="checkbox"/>	AC: 110 – 130 Vac, 50/60 Hz				
	<input type="checkbox"/>	DC: 2.5 – 3.6 Vdc				
	<input checked="" type="checkbox"/>	Battery:3Vdc				
Mounting position .....	<input type="checkbox"/>	Table top equipment				
	<input type="checkbox"/>	Wall/Ceiling mounted equipment				
	<input type="checkbox"/>	Floor standing equipment				
	<input type="checkbox"/>	Head-mounted equipment				
	<input checked="" type="checkbox"/>	Other: The is affixed to any hard surface in the vehicle				

## 1.2 Antenna Information

Antenna model / type number .....	N/A		
Antenna serial number .....	N/A		
Antenna Delivery .....	<input checked="" type="checkbox"/>	1TX + 1RX	
	<input type="checkbox"/>	2TX + 2RX	
Antenna technology .....	<input checked="" type="checkbox"/>	SISO	
	<input type="checkbox"/>	MIMO	<input type="checkbox"/> CDD
			<input type="checkbox"/> Beam-forming
Antenna Type .....	<input type="checkbox"/>	External	<input type="checkbox"/> Dipole
			<input type="checkbox"/> Sectorized
	<input checked="" type="checkbox"/>	Internal	<input type="checkbox"/> PIFA
			<input checked="" type="checkbox"/> PCB
			<input type="checkbox"/> Metal Monopole Antenna
			<input type="checkbox"/> Others.....
Antenna Gain .....	1.1dbi		

## 1.3 Channel List

Bluetooth Working Frequency of Each Channel:							
Channel	Frequency	Channel	Frequency	Channel	Frequency	Channel	Frequency
00	2402 MHz	01	2404 MHz	02	2406 MHz	03	2408 MHz
04	2410 MHz	05	2412 MHz	06	2414 MHz	07	2416 MHz
08	2418 MHz	09	2420 MHz	10	2422 MHz	11	2424 MHz
12	2426 MHz	13	2428 MHz	14	2430 MHz	15	2432 MHz
16	2434 MHz	17	2436 MHz	18	2438 MHz	19	2440 MHz
20	2442 MHz	21	2444 MHz	22	2446 MHz	23	2448 MHz
24	2450 MHz	25	2452 MHz	26	2454 MHz	27	2456 MHz
28	2458 MHz	29	2460 MHz	30	2462 MHz	31	2464 MHz
32	2466 MHz	33	2468 MHz	34	2470 MHz	35	2472 MHz
36	2474 MHz	37	2476 MHz	38	2478 MHz	39	2480 MHz

Note: The general description of the Item(s), antenna information and channel list in clause 1 are provided and confirmed by the client.

## 2 DESCRIPTION OF TEST SETUP

### 2.1 Operating mode(s) used for tests

During the tests the following operating mode(s) has(have) been used.

Test Mode For Bluetooth	Mode1: Transmit by LE_1Mbps
	Mode2: Transmit by LE_2Mbps

### 2.2 Auxiliary equipment / Test software for the EUT

Auxiliary equipment	Type / Version	Manufacturer	Supplied by
Notebook	Think pad x220	Lenovo	Adapter
Software	Type / Version	Manufacturer	Supplied by
N/A	N/A	N/A	N/A

### 2.3 Test Configuration / Block diagram used for tests

Test setup Diagram- AC Line Conducted Emission Test

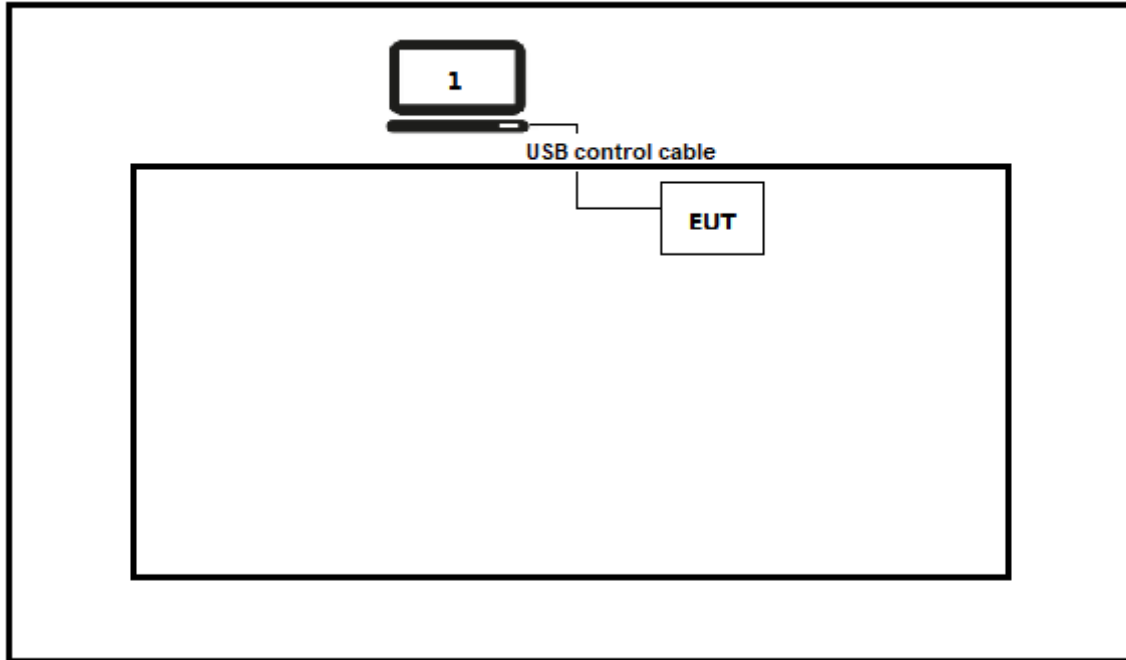

Test setup Diagram- Radiated Emission

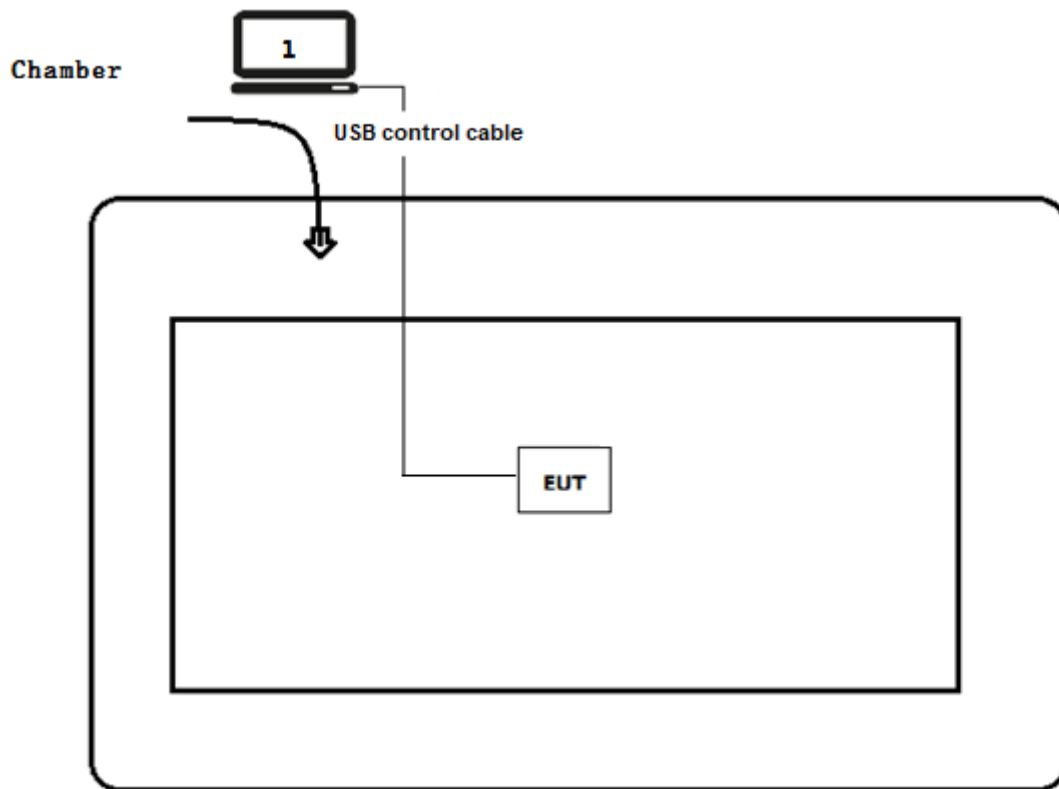

---

## 2.4 Testing process

1	Setup the EUT as shown in Section 2.3.
2	Configure the test mode, the test channel, and the data rate.
3	Verify that the EUT works properly.

### 3 VERDICT SUMMARY SECTION

This chapter presents an overview of standards and results. Refer to the next chapters for details of measured test results and applied test levels.

#### 3.1 Standards

Standard	Year	Description
FCC CFR Title 47 Part 15 Subpart C Section 15.247	2021	Operation within the bands 902–928 MHz, 2400–2483.5 MHz, and 5725–5850 MHz.
ANSI C63.10	2013	American National Standard of Procedures for Compliance Testing of Unlicensed Wireless Devices
KDB558074 D01 v05r02	2019	Guidance for performing compliance measurements on Digital Transmission System (DTS) operating under section 15.247
RSS-Gen Issue 5 Amendment 2	2021	General Requirements for Compliance of Radio Apparatus
RSS-247 Issue 2	2017	Digital Transmission Systems (DTSs), Frequency Hopping Systems (FHSs) and Licence-Exempt Local Area Network (LE-LAN) Devices

#### 3.2 Deviation(s) from the Standard(s) / Test Specification(s)

The following deviation(s) was / were made from the published requirements of the listed standards: N/A.

*(Please define the deviations from the standard(s) if applicable)*

### 3.3 Overview of results

#### For FCC

Requirement – Test case	Basic standard(s)	Verdict	Remark
AC Power Line Conducted Emission	FCC 15.207	PASS	---
Emissions in restricted frequency bands	FCC 15.247(b)(3)	PASS	---
Duty cycle	ANSI C63.10:2013	PASS	---
Emissions in non-restricted frequency bands	FCC 15.247(d), FCC 15.209	PASS	---
Radiated Emission Band Edge	FCC 15.247(d)	PASS	---
Fundamental emission output power	FCC 15.247(d), FCC 15.209	PASS	---
DTS Bandwidth	FCC 15.247(a)(2)	PASS	---
Power Spectral Density	FCC 15.247(e)	PASS	---
Antenna Requirement	FCC 15.203	PASS	---

#### For ISED

Requirement – Test case	Basic standard(s)	Verdict	Remark
AC Power Line Conducted Emission	RSS-Gen Issue 5 Section 8.8	PASS	---
Emissions in restricted frequency bands	RSS-Gen Issue 5 Section 8.9	PASS	---
Duty cycle	ANSI C63.10:2013	PASS	---
Emissions in non-restricted frequency bands	RSS-247 Issue 2 Section 5.5	PASS	---
Radiated Emission Band Edge	RSS-Gen Issue 5 Section 8.10	PASS	---
Fundamental emission output power	RSS-247 Issue 2 Section 5.4(d)	PASS	---
DTS Bandwidth	RSS-Gen Issue 5 Section 6.7	PASS	---
Power Spectral Density	RSS-247 Issue 2 Section 5.2(b)	PASS	---
Antenna Requirement	RSS-Gen Issue 5 Section 6.8	PASS	---



---

### 3.4 Test Facility

<b>USA</b>	<b>:</b>	<b>FCC Designation Number: CN1199</b>
<b>CA</b>	<b>:</b>	<b>ISED CAB identifier: CN0040</b>

## 4 TEST RESULTS

### 4.1 AC Power Line Conducted Emission

VERDICT: PASS

#### 4.1.1 Limit

Standard FCC Part 15 Subpart C Paragraph 15.207

Frequency range [MHz]	Limit: QP [dB(μV) <sup>1)</sup>	Limit: AV [dB(μV) <sup>1)</sup>
0,15 - 0,50	66 - 56 <sup>2)</sup>	56 - 46 <sup>2)</sup>
0,50 - 5,0	56	46
5,0 - 30	60	50

<sup>1)</sup> At the transition frequency, the lower limit applies.

<sup>2)</sup> The limit decreases linearly with the logarithm of the frequency.

**NOTE 1:** The exclusion band for transmitters shall be considered for transmitters operating at frequencies below 30 MHz.

**NOTE 2:** Where the AC output port is directly connected (or via a circuit breaker) to the AC power input port of the EUT the AC power output port need not to be tested.

#### 4.1.2 Test Setup

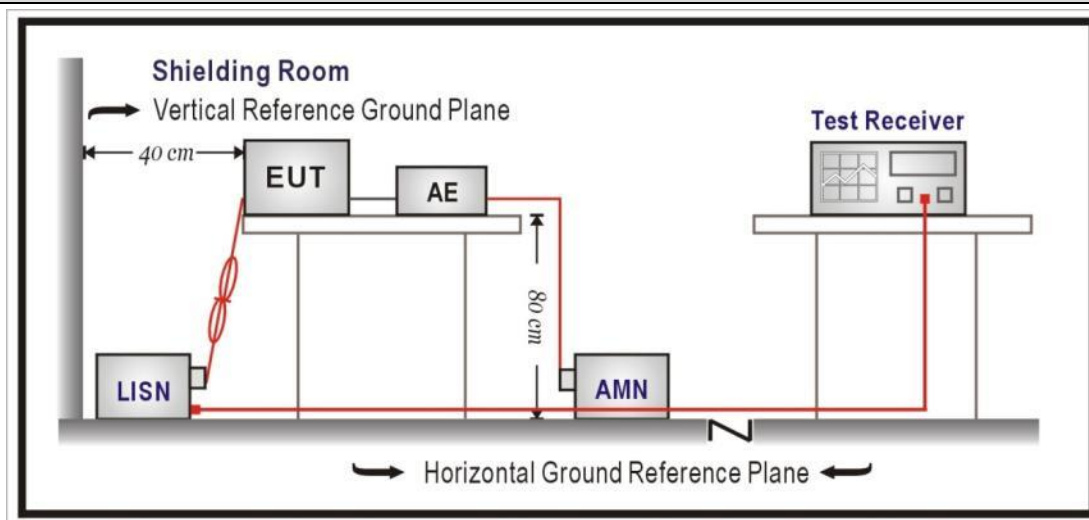

#### 4.1.3 Test Procedure

	References Rule	Chapter	Item
<input checked="" type="checkbox"/>	ANSI C63.10-2013	6.2	Standard test method for ac power-line conducted emissions from unlicensed wireless devices

#### 4.1.4 Test Data

Note: EUT is Battery powered

<b>4.2 Emissions in restricted frequency bands</b>	<b>VERDICT: PASS</b>
--	----------------------

4.2.1 Limit			
Standard		FCC Part 15 Subpart C Paragraph 15.209	
Restricted Bands of operation for FCC			
Frequency (MHz)	Frequency (MHz)	Frequency (MHz)	Frequency (GHz)
0.090 – 0.110	16.42 – 16.423	399.9 – 410	4.5 – 5.15
0.495 – 0.505	16.69475 – 16.69525	608 – 614	5.35 – 5.46
2.1735 – 2.1905	16.80425 – 16.80475	960 – 1240	7.25 – 7.75
4.125 – 4.128	25.5 – 25.67	1300 – 1427	8.025 – 8.5
4.17725 – 4.17775	37.5 – 38.25	1435 – 1626.5	9.0 – 9.2
4.20725 – 4.20775	73 – 74.6	1645.5 – 1646.5	9.3 – 9.5
6.215 – 6.218	74.8 – 75.2	1660 – 1710	10.6 – 12.7
6.26775 – 6.26825	108 – 121.94	1718.8 – 1722.2	13.25 – 13.4
6.31175 – 6.31225	123 – 138	2200 – 2300	14.47 – 14.5
8.291 – 8.294	149.9 – 150.05	2310 – 2390	15.35 – 16.2
8.362 – 8.366	156.52475 – 156.52525	2483.5 – 2500	17.7 – 21.4
8.37625 – 8.38675	156.7 – 156.9	2690 – 2900	22.01 – 23.12
8.81425 – 8.81475	162.0125 – 167.17	3260 – 3267	23.6 – 24.0
12.29 – 12.293	167.72 – 173.2	3332 – 3339	31.2 – 31.8
12.51975 – 12.52025	240 – 285	3345.8 – 3358	36.43 – 36.5
12.57675 – 12.57725	322 – 335.4	3600 – 4400	
13.36 – 13.41			
Restricted Bands of operation for IC			
0.090 - 0.110	13.36 - 13.41	960 - 1427	9.0 - 9.2
0.495 - 0.505	16.42 - 16.423	1435 - 1626.5	9.3 - 9.5
2.1735 - 2.1905	16.69475 - 16.69525	1645.5 - 1646.5	10.6 - 12.7
3.020 - 3.026	16.80425 - 16.80475	1660 - 1710	13.25 - 13.4
4.125 - 4.128	25.5 - 25.67	1718.8 - 1722.2	14.47 - 14.5
4.17725 - 4.17775	37.5 - 38.25	2200 - 2300	15.35 - 16.2
4.20725 - 4.20775	73 - 74.6	2310 - 2390	17.7 - 21.4
5.677 - 5.683	74.8 - 75.2	2483.5 - 2500	22.01 - 23.12
6.215 - 6.218	108 - 138	2655 - 2900	23.6 - 24.0
6.26775 - 6.26825	149.9 - 150.05	3260 - 3267	31.2 - 31.8
6.31175 - 6.31225	156.52475 - 156.52525	3332 - 3339	36.43 - 36.5
8.291 - 8.294	156.7 - 156.9	3345.8 - 3358	Above 38.6
8.362 - 8.366	162.0125 - 167.17	3500 - 4400	
8.37625 - 8.38675	167.72 - 173.2	4500 - 5150	
8.81425 - 8.81475	240 - 285	5350 - 5460	
12.29 - 12.293	322 - 335.4	7250 - 7750	
12.51975 - 12.52025	399.9 - 410	8025 - 8500	
12.57675 - 12.57725	608 - 614	--	

Restricted Band Emissions Limit			
Frequency (MHz)	Field strength ( $\mu\text{V/m}$ )	Field strength ( $\text{dB}\mu\text{V/m}$ )	Measurement distance (m)
0.009 - 0.49	2400/F(kHz)	48.5 – 13.8	300 <sub>(Note 1)</sub>
0.49 - 1.705	24000/F(kHz)	33.8 - 23	30 <sub>(Note 1)</sub>
1.705 - 30	30	29.5	30 <sub>(Note 1)</sub>
30 -88	100	40	3 <sub>(Note 2)</sub>
88-216	150	43.5	3 <sub>(Note 2)</sub>
216 - 960	200	46	3 <sub>(Note 2)</sub>
Above 960	500	54	3 <sub>(Note 2)</sub>

Note 1: At frequencies below 30 MHz, measurements may be performed at a distance closer than that specified in the regulations; however, an attempt should be made to avoid making measurements in the near field. Pending the development of an appropriate measurement procedure for measurements performed below 30 MHz, when performing measurements at a closer distance than specified, the results shall be extrapolated to the specified distance by either making measurements at a minimum of two distances on at least one radial to determine the proper extrapolation factor or by using the square of an inverse linear distance extrapolation factor (40 dB/decade).

Note 2: At frequencies at or above 30 MHz, measurements may be performed at a distance other than what is specified provided: measurements are not made in the near field except where it can be shown that near field measurements are appropriate due to the characteristics of the device; and it can be demonstrated that the signal levels needed to be measured at the distance employed can be detected by the measurement equipment. Measurements shall not be performed at a distance greater than 30 meters unless it can be further demonstrated that measurements at a distance of 30 meters or less are impractical. When performing measurements at a distance other than that specified, the results shall be extrapolated to the specified distance using an extrapolation factor of 20 dB/decade (inverse linear-distance for field strength measurements; inverse-linear-distance-squared for power density measurements).

### 4.2.2 Test Setup

30MHz-1GHz Test Setup:

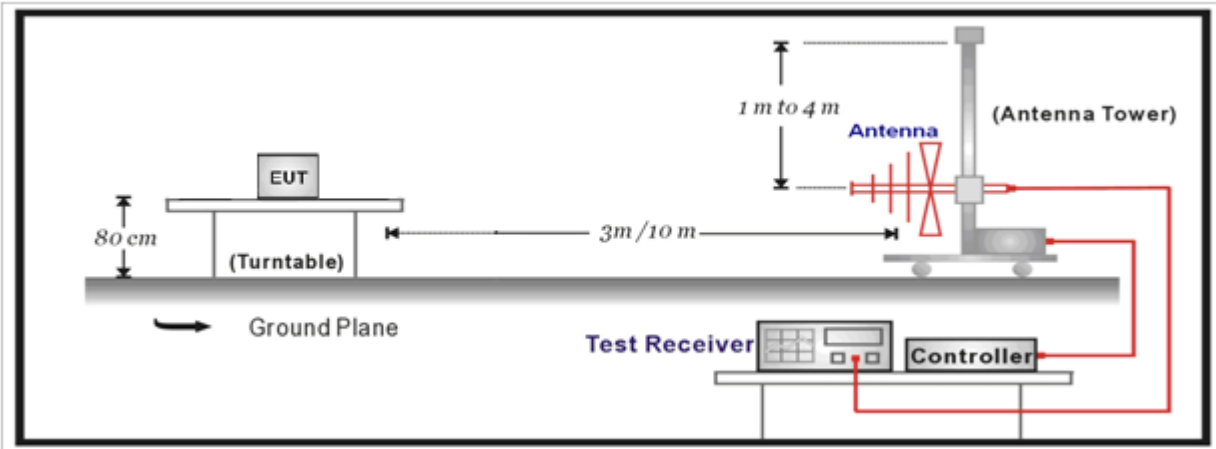

Above 1GHz Test Setup:

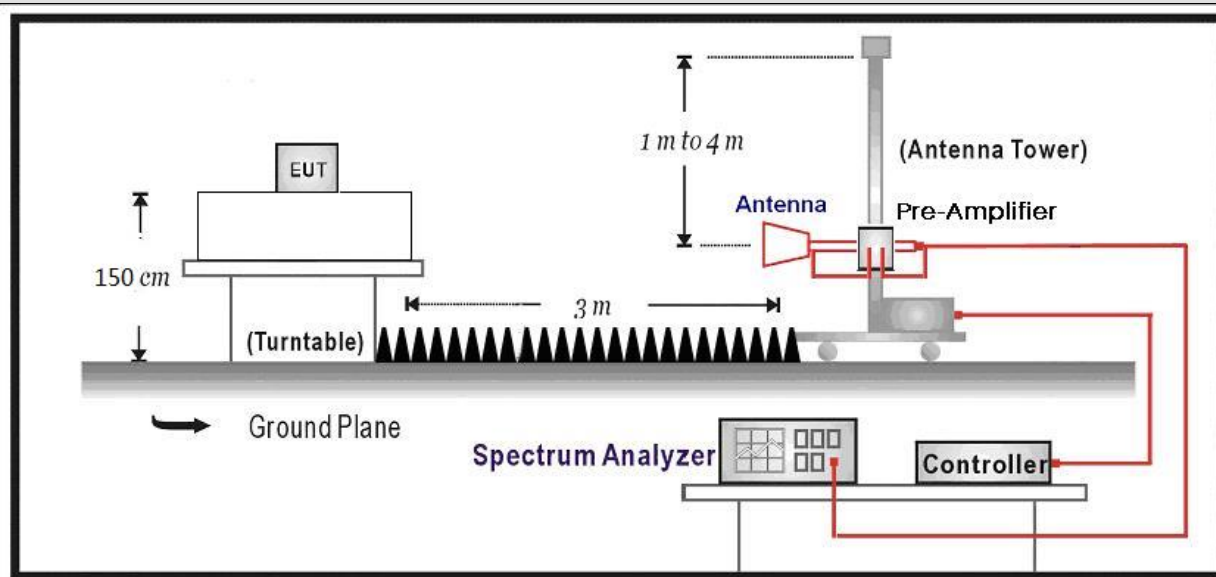

### 4.2.3 Test Procedure

References Rule	Chapter	Description
<input checked="" type="checkbox"/> ANSI C63.10	11.12	Emissions in restricted frequency bands
<input checked="" type="checkbox"/> ANSI C63.10	11.12.1	Radiated emission measurements
<input checked="" type="checkbox"/> ANSI C63.10	11.12.2.7	Radiated spurious emission test
<input checked="" type="checkbox"/> ANSI C63.10	6.4	Radiated emissions from unlicensed wireless devices below 30 MHz
<input checked="" type="checkbox"/> ANSI C63.10	6.5	Radiated emissions from unlicensed wireless devices in the frequency range of 30 MHz to 1000 MHz
<input checked="" type="checkbox"/> ANSI C63.10	6.6	Radiated emissions from unlicensed wireless devices above 1 GHz

**4.2.4 Test Data**

Profile: 2180930R	Page No.: 181
Engineer: Juliuszhou	
Site: AC5	Time: 2021/09/05 - 14:38
Limit: FCC_Part15.209_RE(3m)	Margin: 0
Probe: Horn_3117_00123988_(1-18GHz)	Polarity: Horizontal
EUT: DriveWell Tag	Power: AC 120V/60Hz
Note: Mode 1:Transmit at 2402MHz by ble1M	

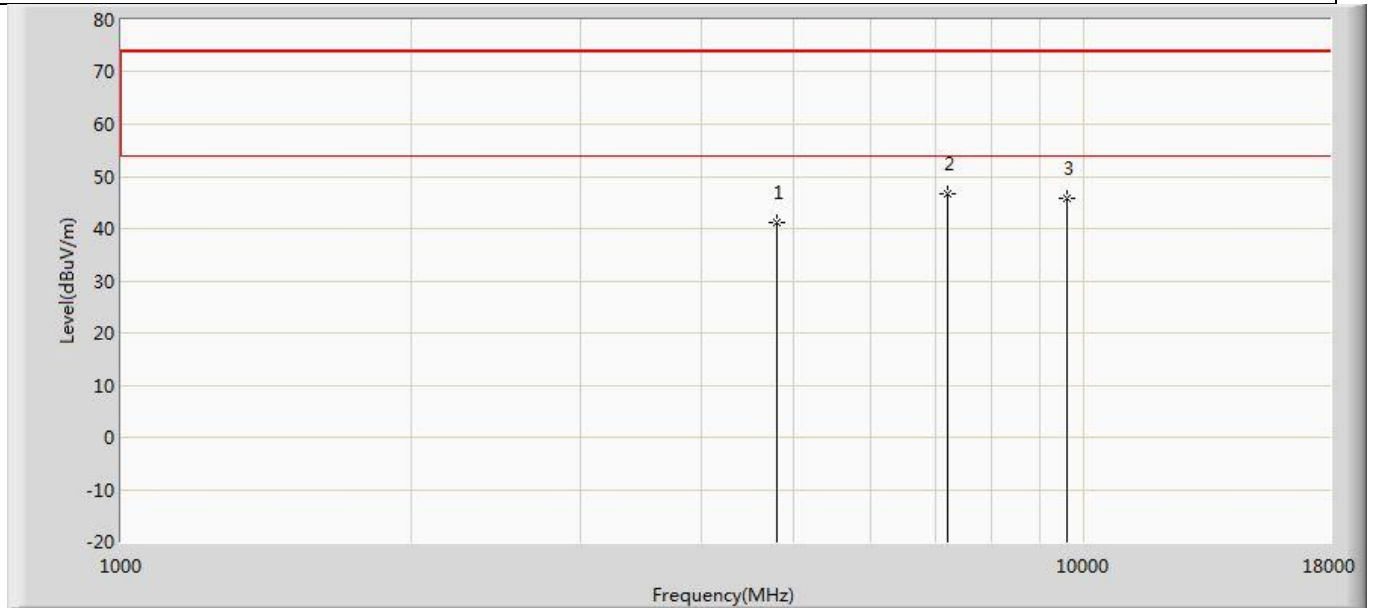

No	Mark	Frequency (MHz)	Measure Level (dBuV/m)	Reading Level (dBuV)	Over Limit (dB)	Limit (dBuV/m)	Factor (dB)	Type
1		4804.000	41.154	46.197	-32.846	74.000	-5.044	PK
2	*	7206.000	46.572	47.618	-27.428	74.000	-1.046	PK
3		9608.000	45.659	42.829	-28.341	74.000	2.830	PK

Profile: 2180930R	Page No.: 182
Engineer: Juliuszhou	
Site: AC5	Time: 2021/09/05 - 14:38
Limit: FCC_Part15.209_RE(3m)	Margin: 0
Probe: Horn_3117_00123988_(1-18GHz)	Polarity: Vertical
EUT: DriveWell Tag	Power: AC 120V/60Hz
Note: Mode 1:Transmit at 2402MHz by ble1M	

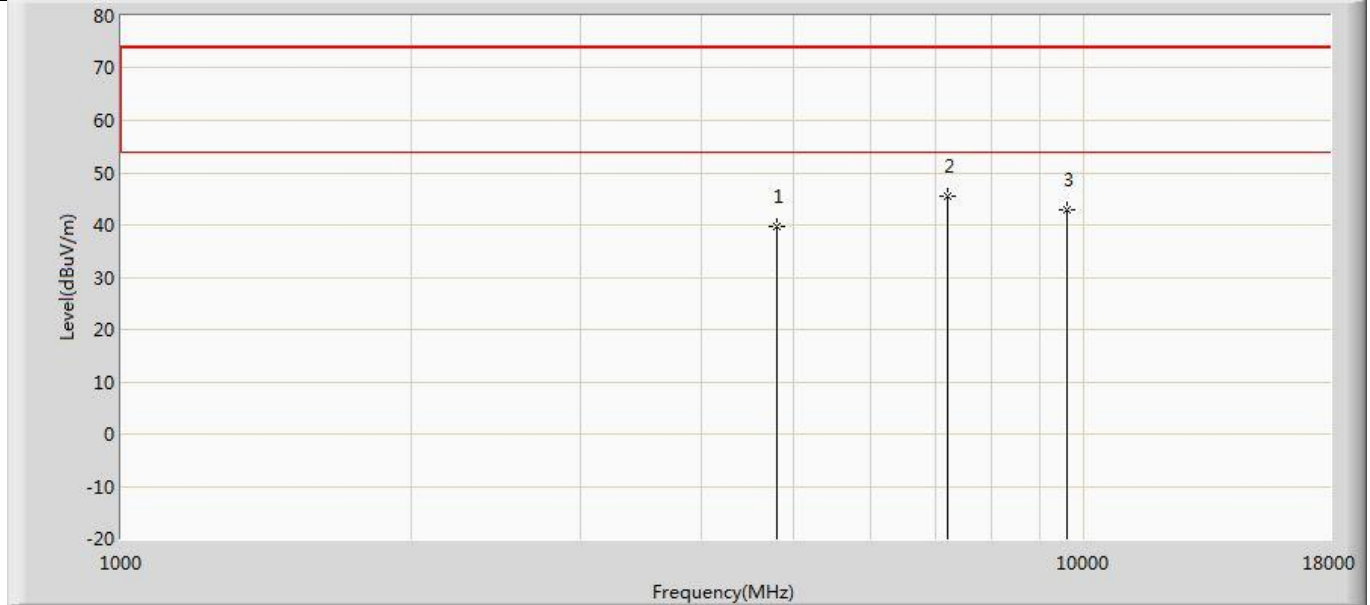

No	Mark	Frequency (MHz)	Measure Level (dBuV/m)	Reading Level (dBuV)	Over Limit (dB)	Limit (dBuV/m)	Factor (dB)	Type
1		4804.000	39.708	44.751	-34.292	74.000	-5.044	PK
2	*	7206.000	45.484	46.530	-28.516	74.000	-1.046	PK
3		9608.000	42.958	40.128	-31.042	74.000	2.830	PK



Profile: 2180930R	Page No.: 183
Engineer: Juliuszhou	
Site: AC5	Time: 2021/09/05 - 14:38
Limit: FCC_Part15.209_RE(3m)	Margin: 0
Probe: Horn_3117_00123988_(1-18GHz)	Polarity: Horizontal
EUT: DriveWell Tag	Power: AC 120V/60Hz
Note: Mode 1:Transmit at 2440MHz by ble1M	

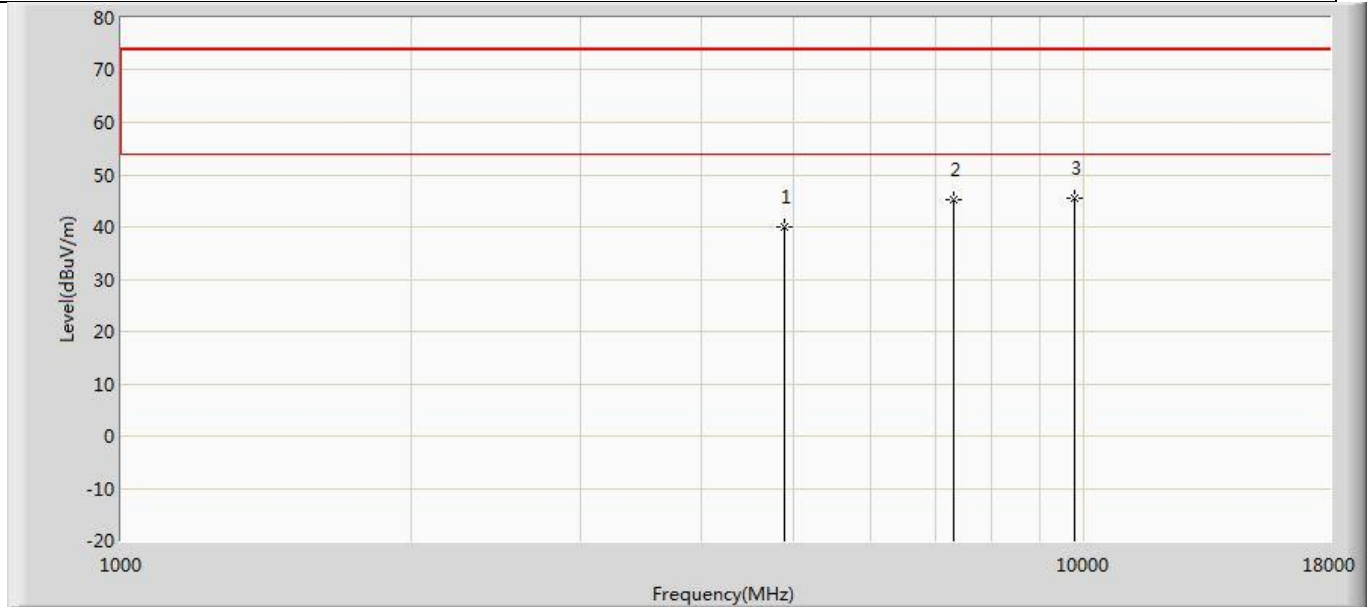

No	Mark	Frequency (MHz)	Measure Level (dBuV/m)	Reading Level (dBuV)	Over Limit (dB)	Limit (dBuV/m)	Factor (dB)	Type
1		4880.000	40.026	44.853	-33.974	74.000	-4.827	PK
2		7320.000	45.339	46.232	-28.661	74.000	-0.893	PK
3	*	9760.000	45.563	42.565	-28.437	74.000	2.998	PK

Profile: 2180930R	Page No.: 184
Engineer: Juliuszhou	
Site: AC5	Time: 2021/09/05 - 14:38
Limit: FCC_Part15.209_RE(3m)	Margin: 0
Probe: Horn_3117_00123988_(1-18GHz)	Polarity: Vertical
EUT: DriveWell Tag	Power: AC 120V/60Hz
Note: Mode 1:Transmit at 2440MHz by ble1M	

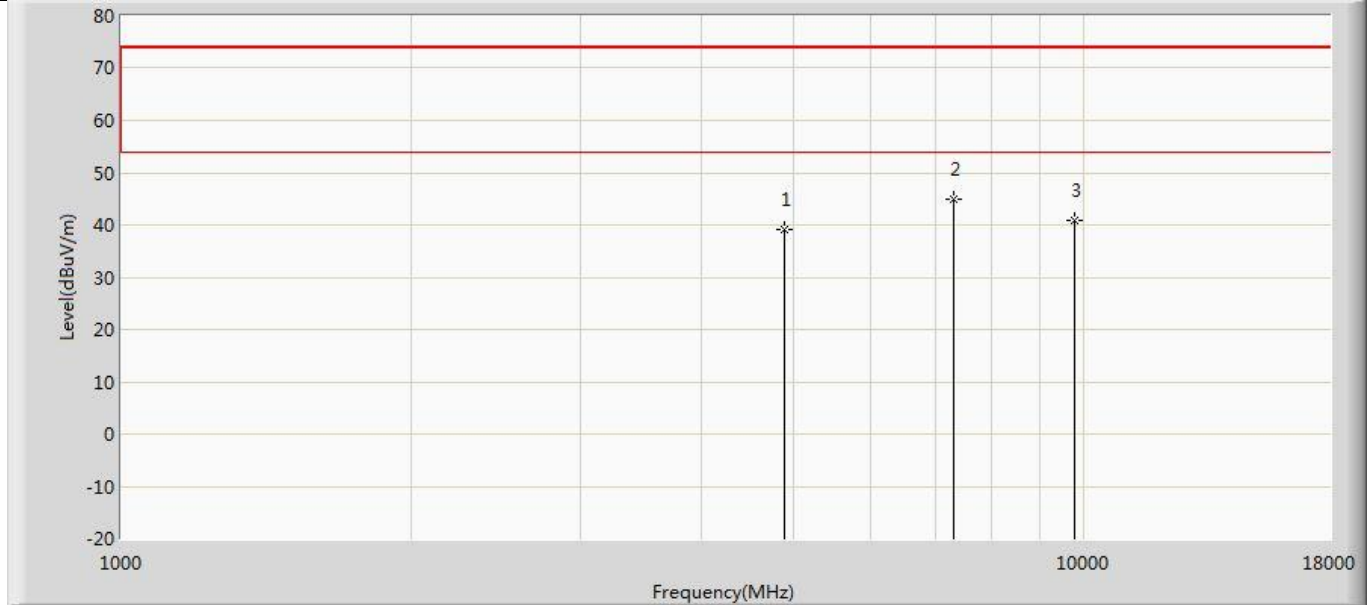

No	Mark	Frequency (MHz)	Measure Level (dBuV/m)	Reading Level (dBuV)	Over Limit (dB)	Limit (dBuV/m)	Factor (dB)	Type
1		4880.000	39.118	43.945	-34.882	74.000	-4.827	PK
2	*	7320.000	44.962	45.855	-29.038	74.000	-0.893	PK
3		9760.000	40.899	37.901	-33.101	74.000	2.998	PK

Profile: 2180930R	Page No.: 185
Engineer: Juliuszhou	
Site: AC5	Time: 2021/09/05 - 14:39
Limit: FCC_Part15.209_RE(3m)	Margin: 0
Probe: Horn_3117_00123988_(1-18GHz)	Polarity: Horizontal
EUT: DriveWell Tag	Power: AC 120V/60Hz
Note: Mode 1:Transmit at 2480MHz by ble1M	

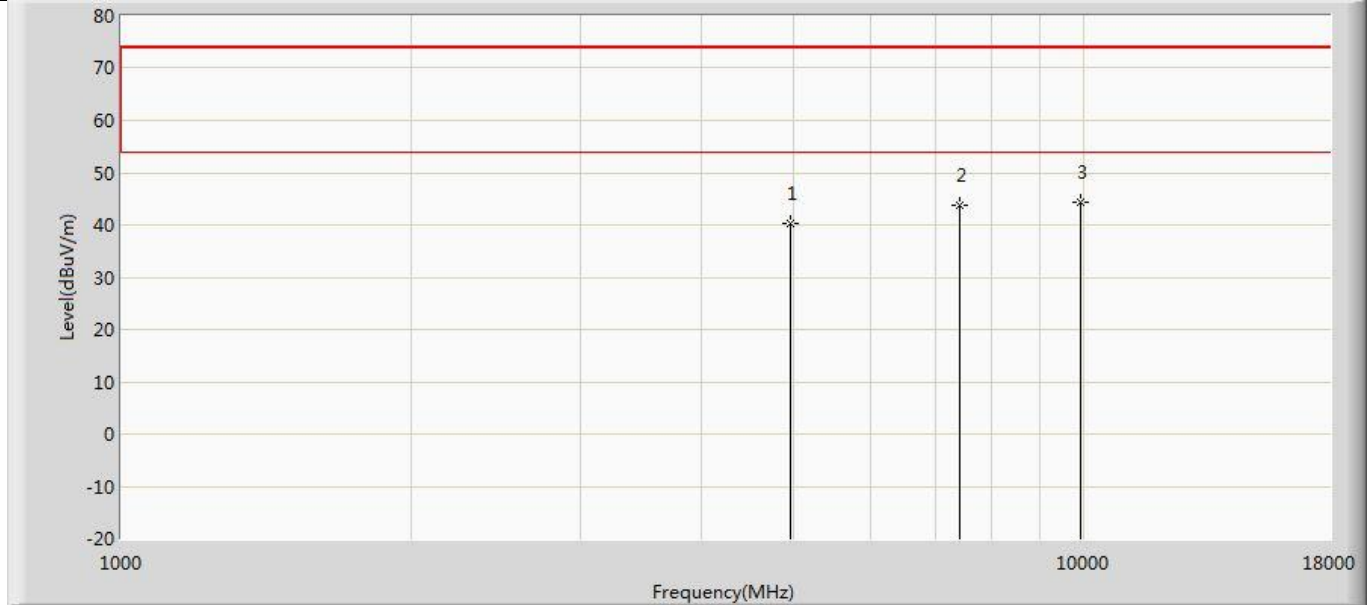

No	Mark	Frequency (MHz)	Measure Level (dBuV/m)	Reading Level (dBuV)	Over Limit (dB)	Limit (dBuV/m)	Factor (dB)	Type
1		4960.000	40.296	44.958	-33.704	74.000	-4.662	PK
2		7440.000	43.847	44.890	-30.153	74.000	-1.043	PK
3	*	9920.000	44.289	41.242	-29.711	74.000	3.047	PK

Profile: 2180930R	Page No.: 186
Engineer: Juliuszhou	
Site: AC5	Time: 2021/09/05 - 14:39
Limit: FCC_Part15.209_RE(3m)	Margin: 0
Probe: Horn_3117_00123988_(1-18GHz)	Polarity: Vertical
EUT: DriveWell Tag	Power: AC 120V/60Hz
Note: Mode 1:Transmit at 2480MHz by ble1M	

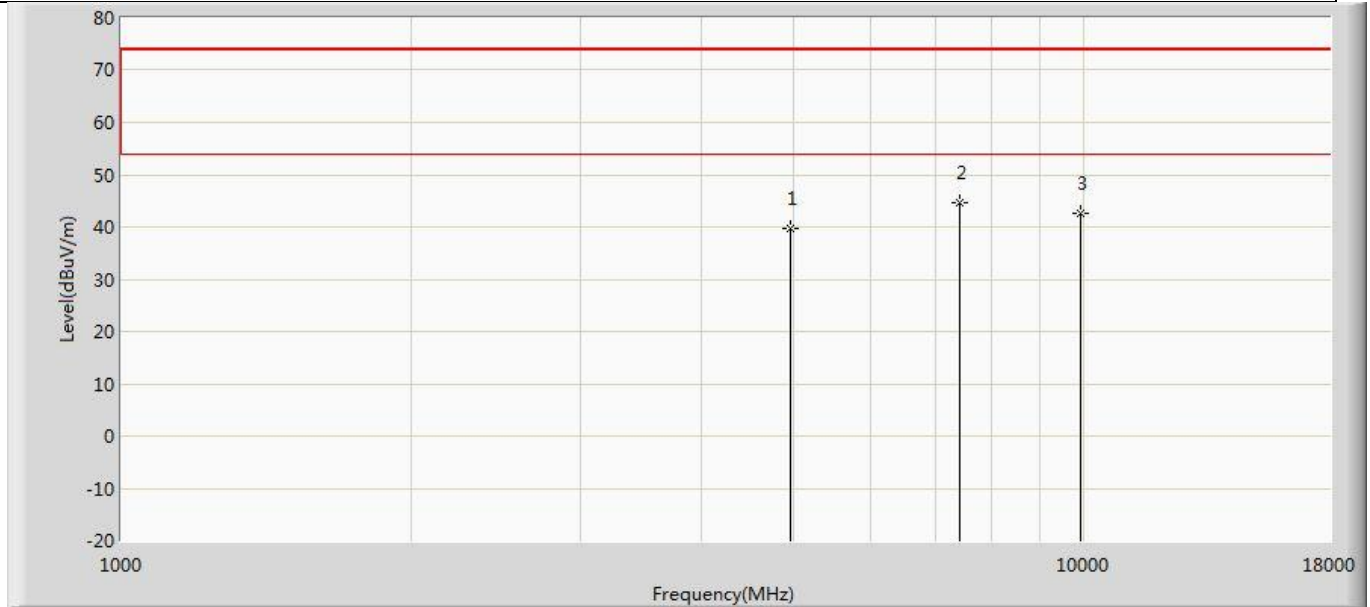

No	Mark	Frequency (MHz)	Measure Level (dBuV/m)	Reading Level (dBuV)	Over Limit (dB)	Limit (dBuV/m)	Factor (dB)	Type
1		4960.000	39.652	44.314	-34.348	74.000	-4.662	PK
2	*	7440.000	44.582	45.625	-29.418	74.000	-1.043	PK
3		9920.000	42.578	39.531	-31.422	74.000	3.047	PK

Profile: 2180930R	Page No.: 187
Engineer: Juliuszhou	
Site: AC5	Time: 2021/09/05 - 14:39
Limit: FCC_Part15.209_RE(3m)	Margin: 0
Probe: Horn_3117_00123988_(1-18GHz)	Polarity: Horizontal
EUT: DriveWell Tag	Power: AC 120V/60Hz
Note: Mode 2:Transmit at 2402MHz by ble2M	

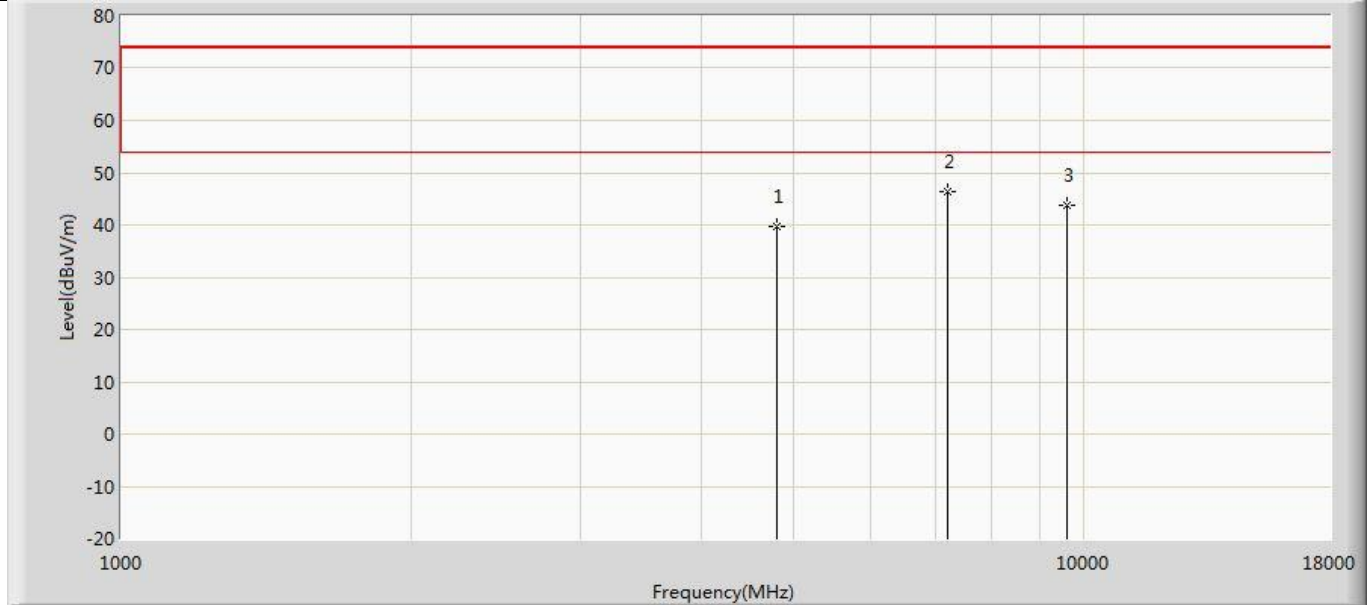

No	Mark	Frequency (MHz)	Measure Level (dBuV/m)	Reading Level (dBuV)	Over Limit (dB)	Limit (dBuV/m)	Factor (dB)	Type
1		4804.000	39.723	44.766	-34.277	74.000	-5.044	PK
2	*	7206.000	46.488	47.534	-27.512	74.000	-1.046	PK
3		9608.000	43.858	41.028	-30.142	74.000	2.830	PK

Profile: 2180930R	Page No.: 188
Engineer: Juliuszhou	
Site: AC5	Time: 2021/09/05 - 14:39
Limit: FCC_Part15.209_RE(3m)	Margin: 0
Probe: Horn_3117_00123988_(1-18GHz)	Polarity: Vertical
EUT: DriveWell Tag	Power: AC 120V/60Hz
Note: Mode 2:Transmit at 2402MHz by ble2M	

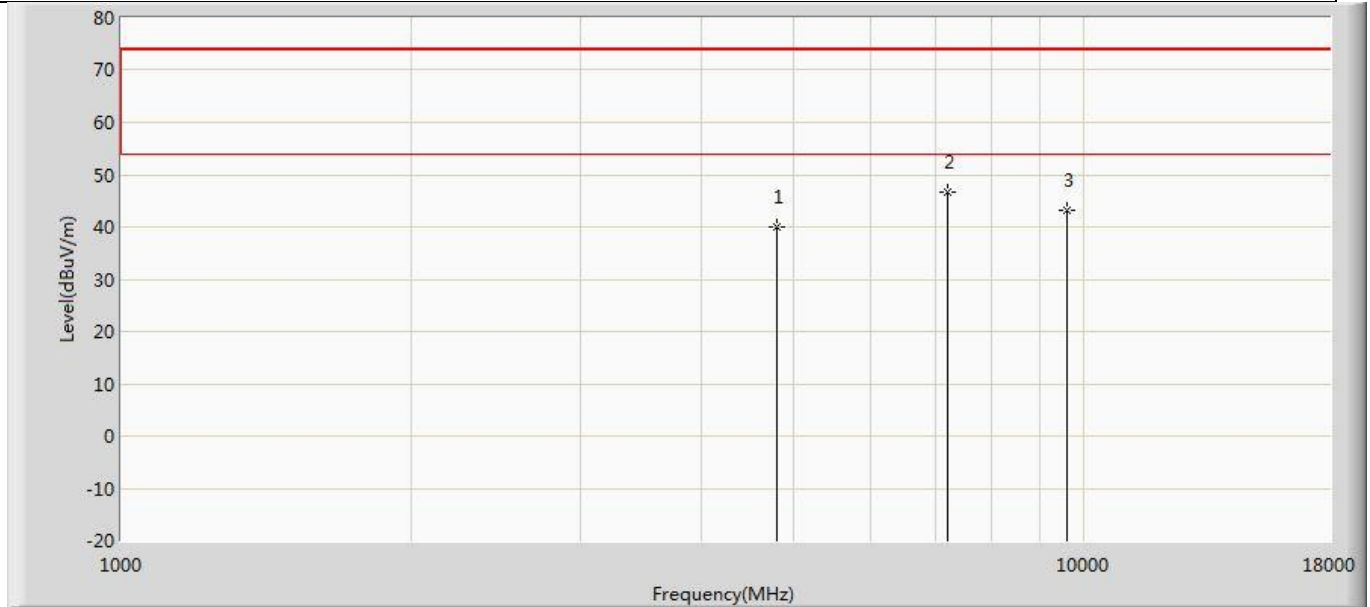

No	Mark	Frequency (MHz)	Measure Level (dBuV/m)	Reading Level (dBuV)	Over Limit (dB)	Limit (dBuV/m)	Factor (dB)	Type
1		4804.000	39.939	44.982	-34.061	74.000	-5.044	PK
2	*	7206.000	46.771	47.817	-27.229	74.000	-1.046	PK
3		9608.000	43.219	40.389	-30.781	74.000	2.830	PK

Profile: 2180930R	Page No.: 189
Engineer: Juliuszhou	
Site: AC5	Time: 2021/09/05 - 14:39
Limit: FCC_Part15.209_RE(3m)	Margin: 0
Probe: Horn_3117_00123988_(1-18GHz)	Polarity: Horizontal
EUT: DriveWell Tag	Power: AC 120V/60Hz
Note: Mode 2:Transmit at 2440MHz by ble2M	

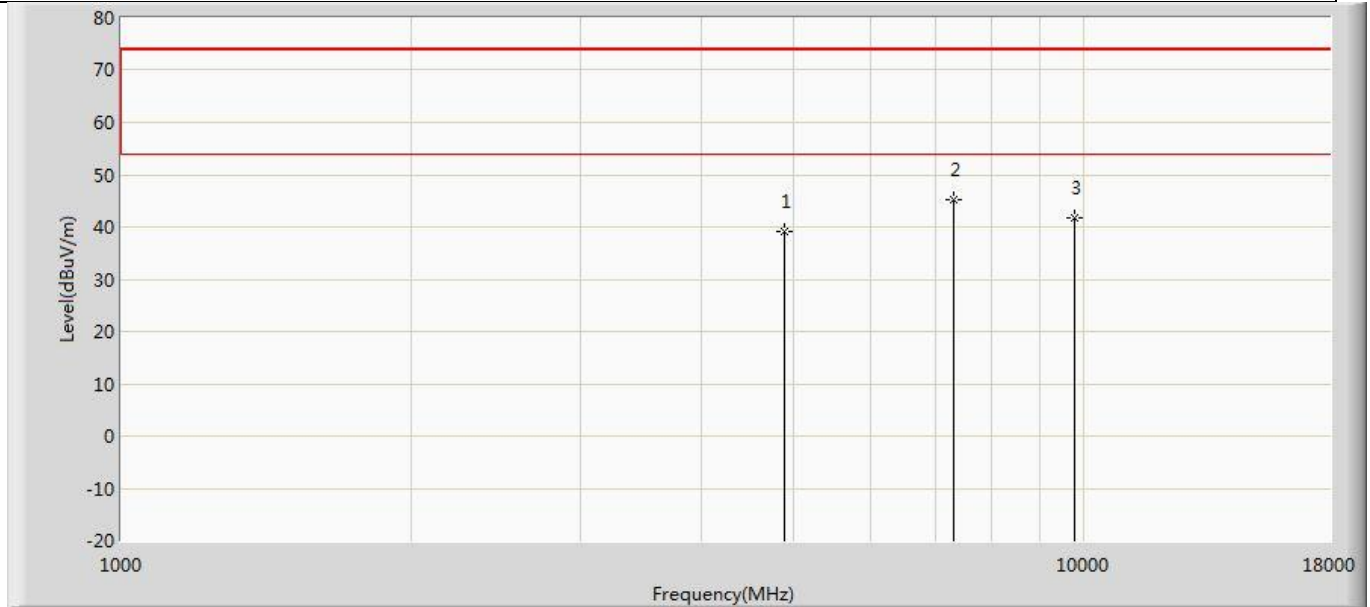

No	Mark	Frequency (MHz)	Measure Level (dBuV/m)	Reading Level (dBuV)	Over Limit (dB)	Limit (dBuV/m)	Factor (dB)	Type
1		4880.000	39.085	43.912	-34.915	74.000	-4.827	PK
2	*	7320.000	45.259	46.152	-28.741	74.000	-0.893	PK
3		9760.000	41.616	38.618	-32.384	74.000	2.998	PK

Profile: 2180930R	Page No.: 190
Engineer: Juliuszhou	
Site: AC5	Time: 2021/09/05 - 14:39
Limit: FCC_Part15.209_RE(3m)	Margin: 0
Probe: Horn_3117_00123988_(1-18GHz)	Polarity: Vertical
EUT: DriveWell Tag	Power: AC 120V/60Hz
Note: Mode 2:Transmit at 2440MHz by ble2M	

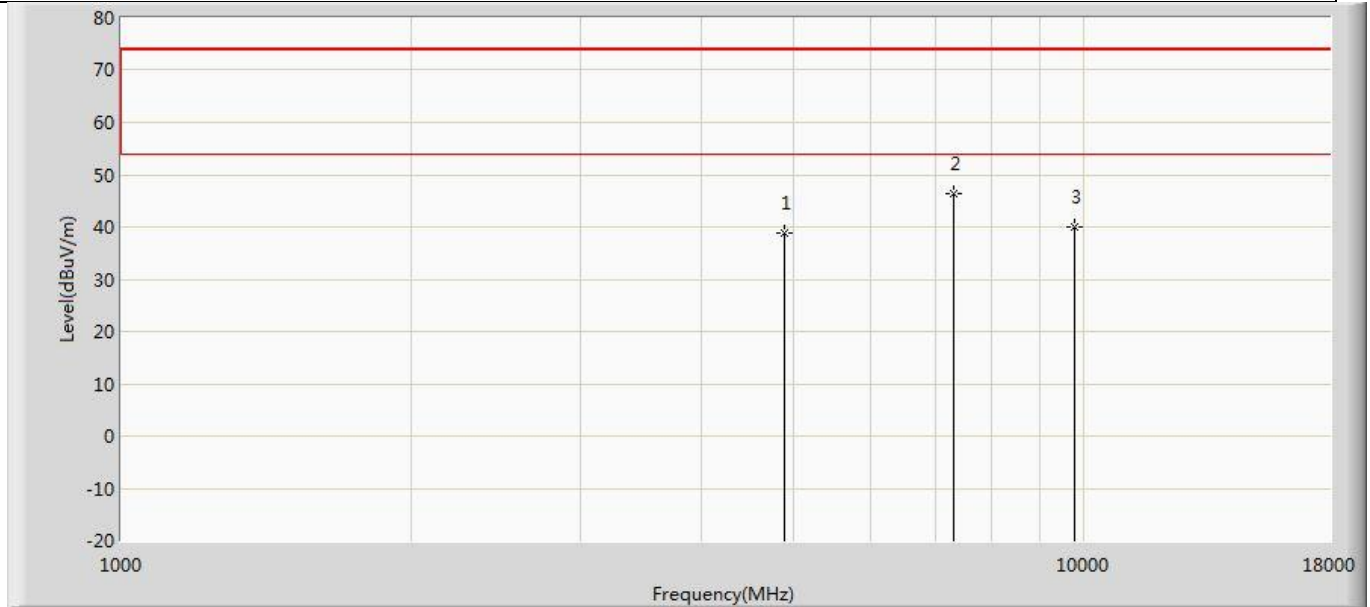

No	Mark	Frequency (MHz)	Measure Level (dBuV/m)	Reading Level (dBuV)	Over Limit (dB)	Limit (dBuV/m)	Factor (dB)	Type
1		4880.000	38.772	43.599	-35.228	74.000	-4.827	PK
2	*	7320.000	46.366	47.259	-27.634	74.000	-0.893	PK
3		9760.000	40.104	37.106	-33.896	74.000	2.998	PK



Profile: 2180930R	Page No.: 191
Engineer: Juliuszhou	
Site: AC5	Time: 2021/09/05 - 14:39
Limit: FCC_Part15.209_RE(3m)	Margin: 0
Probe: Horn_3117_00123988_(1-18GHz)	Polarity: Horizontal
EUT: DriveWell Tag	Power: AC 120V/60Hz
Note: Mode 2:Transmit at 2480MHz by ble2M	

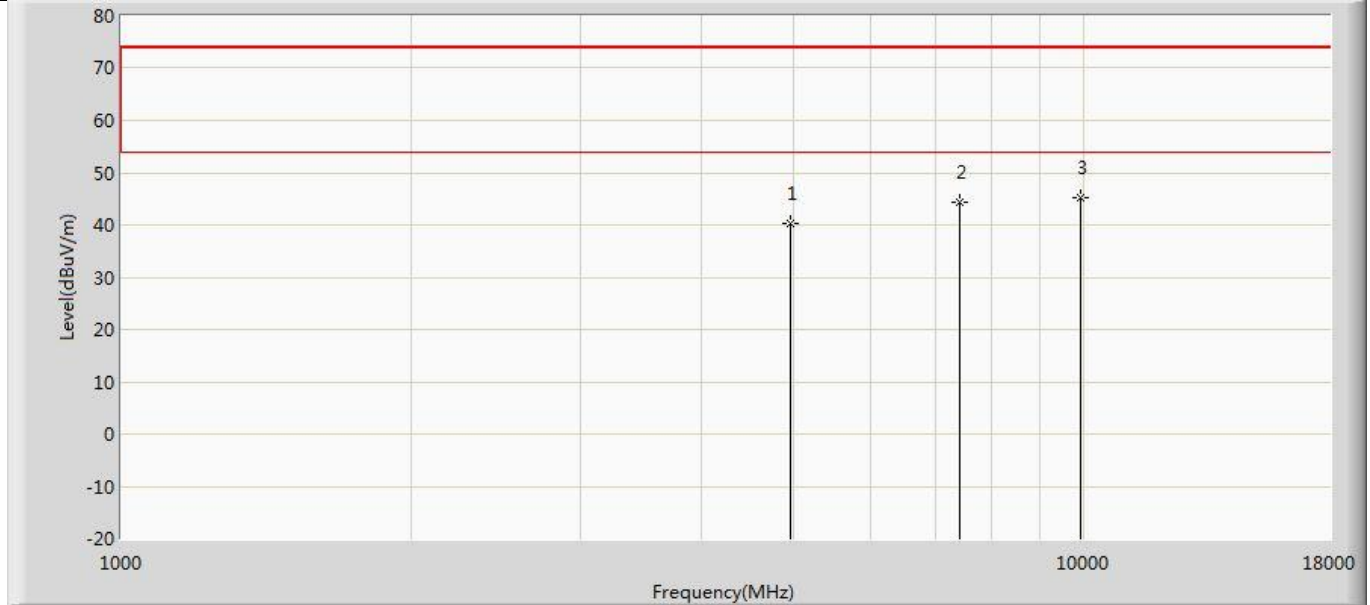

No	Mark	Frequency (MHz)	Measure Level (dBuV/m)	Reading Level (dBuV)	Over Limit (dB)	Limit (dBuV/m)	Factor (dB)	Type
1		4960.000	40.193	44.855	-33.807	74.000	-4.662	PK
2		7440.000	44.435	45.478	-29.565	74.000	-1.043	PK
3	*	9920.000	45.110	42.063	-28.890	74.000	3.047	PK

Profile: 2180930R	Page No.: 192
Engineer: Juliuszhou	
Site: AC5	Time: 2021/09/05 - 14:39
Limit: FCC_Part15.209_RE(3m)	Margin: 0
Probe: Horn_3117_00123988_(1-18GHz)	Polarity: Vertical
EUT: DriveWell Tag	Power: AC 120V/60Hz
Note: Mode 2:Transmit at 2480MHz by ble2M	

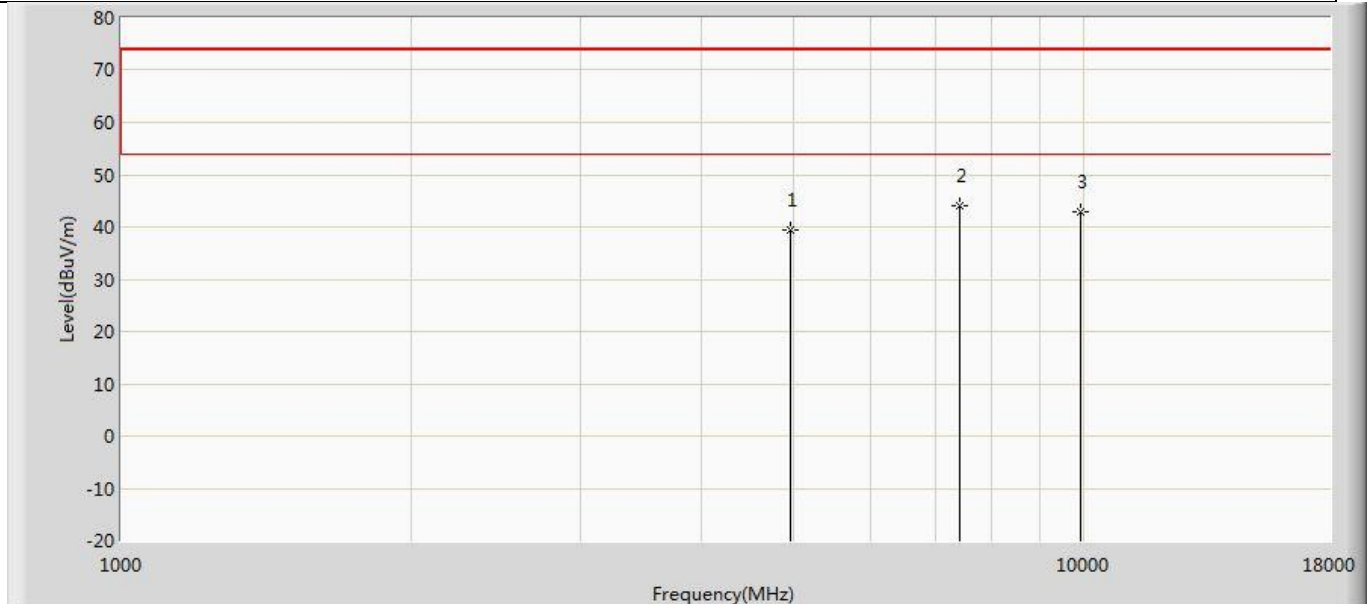

No	Mark	Frequency (MHz)	Measure Level (dBuV/m)	Reading Level (dBuV)	Over Limit (dB)	Limit (dBuV/m)	Factor (dB)	Type
1		4960.000	39.287	43.949	-34.713	74.000	-4.662	PK
2	*	7440.000	43.960	45.003	-30.040	74.000	-1.043	PK
3		9920.000	42.756	39.709	-31.244	74.000	3.047	PK

Note:

1. Measured Level = Reading Level + Factor.
2. The test frequency range, 9kHz~30MHz, 18GHz~26GHz, both of the worst case are at least 20dB below the limits, therefore no data appear in the report.
3. This limit applies for using average detector, if the test result on peak is lower than average limit, then average measurement needn't be performed.
4. As the radiated emission was performed, so conducted emission was not tested.

**The worst case of Radiated Emission below 1GHz:**

Profile:2180930R	Page No.: 1
Engineer:Carlos shen	
Site: AC3	Time: 2021/09/08 - 04:31
Limit: FCC_Part15.209_RE(3m)_ClassB	Margin: 0
Probe: AC3_3m (30-1000MHz)	Polarity: Vertical
EUT: DriveWell Tag	Power: AC 120V/60Hz
Note: Mode 1	

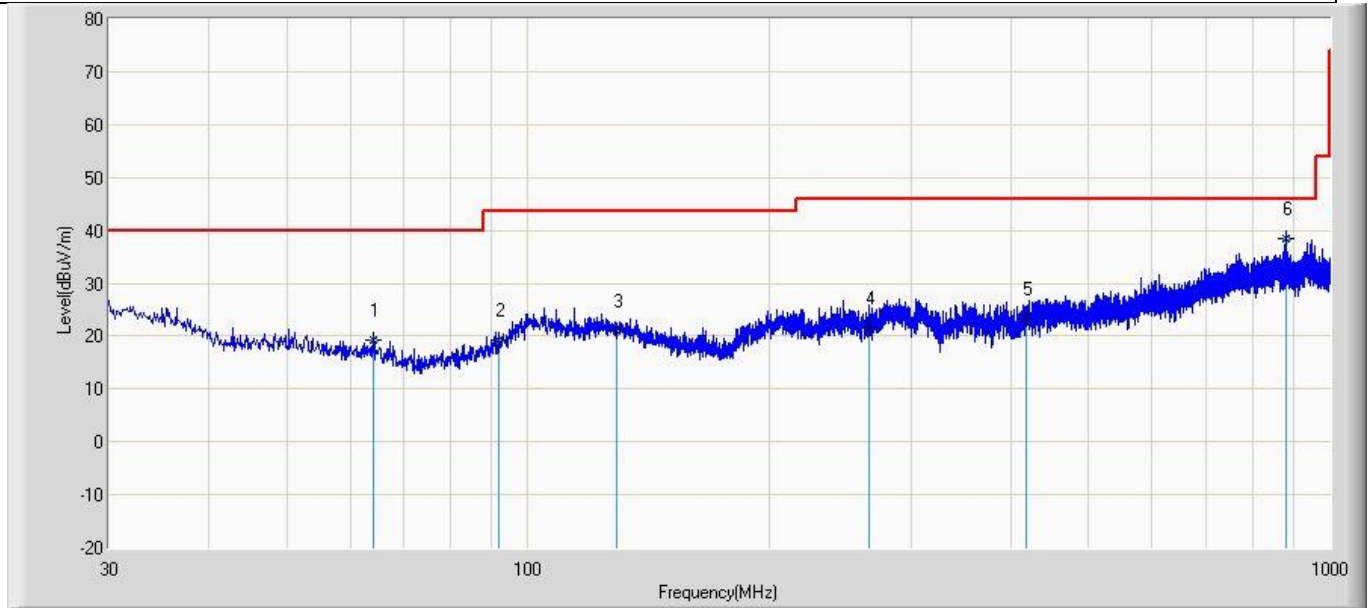

No	Mark	Frequency (MHz)	Measure Level (dBuV/m)	Reading Level (dBuV)	Over Limit (dB)	Limit (dBuV/m)	Factor (dB)	Type
1		64.192	19.254	3.493	-20.746	40.000	15.761	QP
2		91.959	19.123	1.082	-24.377	43.500	18.042	QP
3		128.697	21.035	0.034	-22.465	43.500	21.002	QP
4		265.831	21.459	-1.182	-24.541	46.000	22.641	QP
5		418.121	23.195	-1.915	-22.805	46.000	25.110	QP
6	*	879.841	38.524	5.891	-7.476	46.000	32.633	QP

Profile:2180930R	Page No.: 2
Engineer:Carlos shen	
Site: AC3	Time: 2021/09/08 - 04:39
Limit: FCC_Part15.209_RE(3m)_ClassB	Margin: 0
Probe: AC3_3m (30-1000MHz)	Polarity: Horizontal
EUT: DriveWell Tag	Power: AC 120V/60Hz
Note: Mode 1	

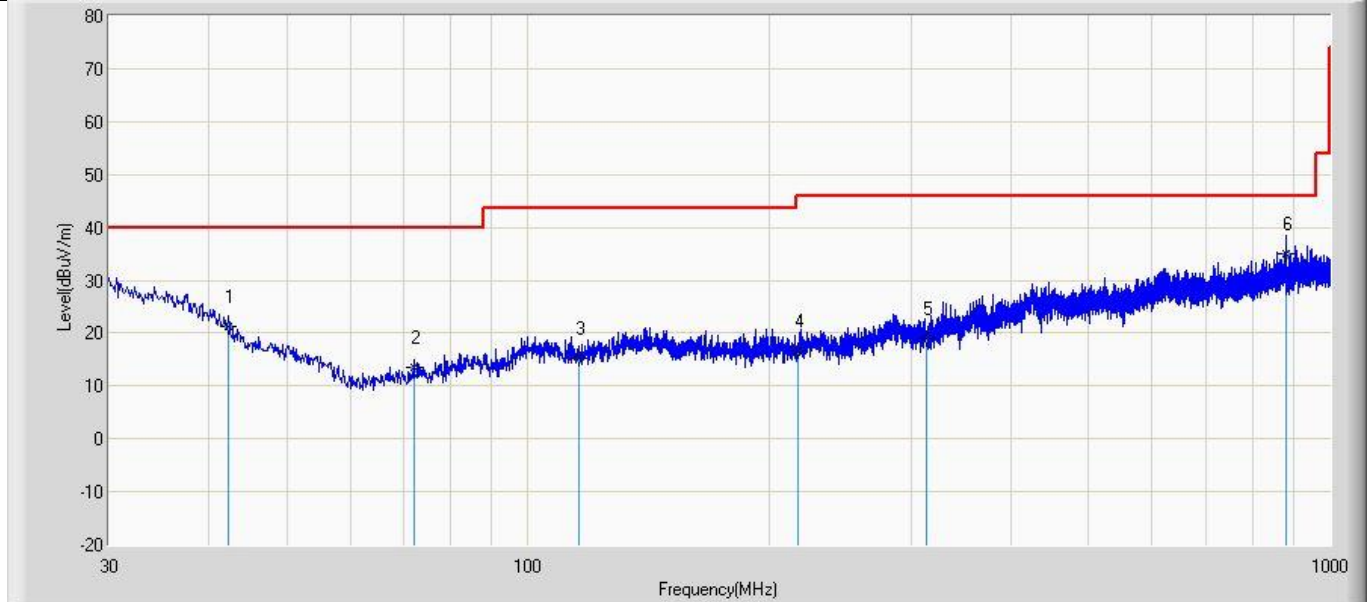

No	Mark	Frequency (MHz)	Measure Level (dBuV/m)	Reading Level (dBuV)	Over Limit (dB)	Limit (dBuV/m)	Factor (dB)	Type
1		42.246	21.124	1.545	-18.876	40.000	19.580	QP
2		72.074	13.586	2.402	-26.414	40.000	11.184	QP
3		115.481	15.148	-0.582	-28.352	43.500	15.730	QP
4		217.331	16.548	-0.879	-29.452	46.000	17.428	QP
5		313.725	18.875	-2.126	-27.125	46.000	21.001	QP
6	*	879.841	35.124	4.035	-10.876	46.000	31.089	QP

<b>4.3 Emissions in non-restricted frequency band</b>	<b>VERDICT: PASS</b>
---	----------------------

<b>4.3.1 Limit</b>	
<b>Standard</b>	FCC Part 15 Subpart C Paragraph 15.247(d)
RF Output power (Detection methods)	Limit(dB)
RF Output power(Average detector)	30dBc(Note1)
RF Output power(PK detector)	20dBc(Note2)
<p>Note 1: If maximum conducted (average) output power was used to demonstrate compliance as described in 9.2, then the peak power in any 100 kHz bandwidth outside of the authorized frequency band shall be attenuated by at least 30 dB relative to the maximum in-band peak PSD level in 100 kHz (i.e., 30 dBc).</p> <p>Note 2: If the maximum peak conducted output power procedure was used, then the peak output power measured in any 100 kHz bandwidth outside of the authorized frequency band shall be attenuated by at least 20 dB relative to the maximum in-band peak PSD level in 100 kHz (i.e., 20 dBc).</p>	

**4.3.2 Test Setup**

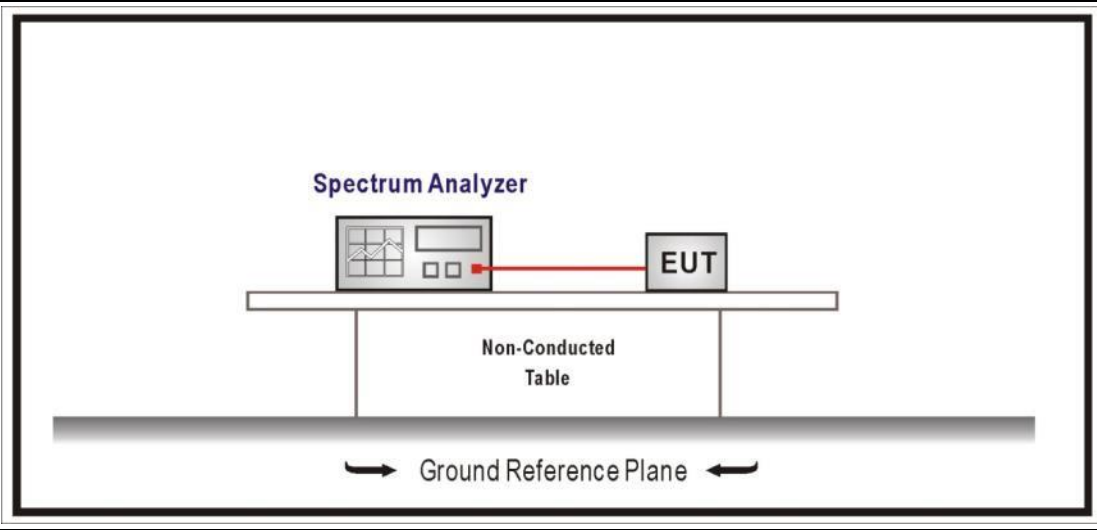

**4.3.3 Test Procedure**

References Rule	Chapter	Description
<input checked="" type="checkbox"/> ANSI C63.10	11.11	Emissions in non-restricted frequency bands
<input checked="" type="checkbox"/> ANSI C63.10	11.11.1	General
<input checked="" type="checkbox"/> ANSI C63.10	11.11.2	Reference level measurement
<input checked="" type="checkbox"/> ANSI C63.10	11.11.3	Emission level measurement

### 4.3.4 Test Data

Mode	Channel	Test Frequency (MHz)	Maximum In-Band PSD[a] (dBm/100kHz)	Frequency (MHz)	Out-Band PSD[b] (dBm/100kHz)	[a]-[b] (dB)	Limit (dB)
1	00	2402	3.473	2400	-51.733	55.206	>20
	39	2480	3.880	2500	-58.787	62.667	>20
2	00	2402	1.842	2400	-30.893	32.735	>20
	39	2480	2.144	2500	-60.164	62.308	>20

Note 1: The worst data plot as below:

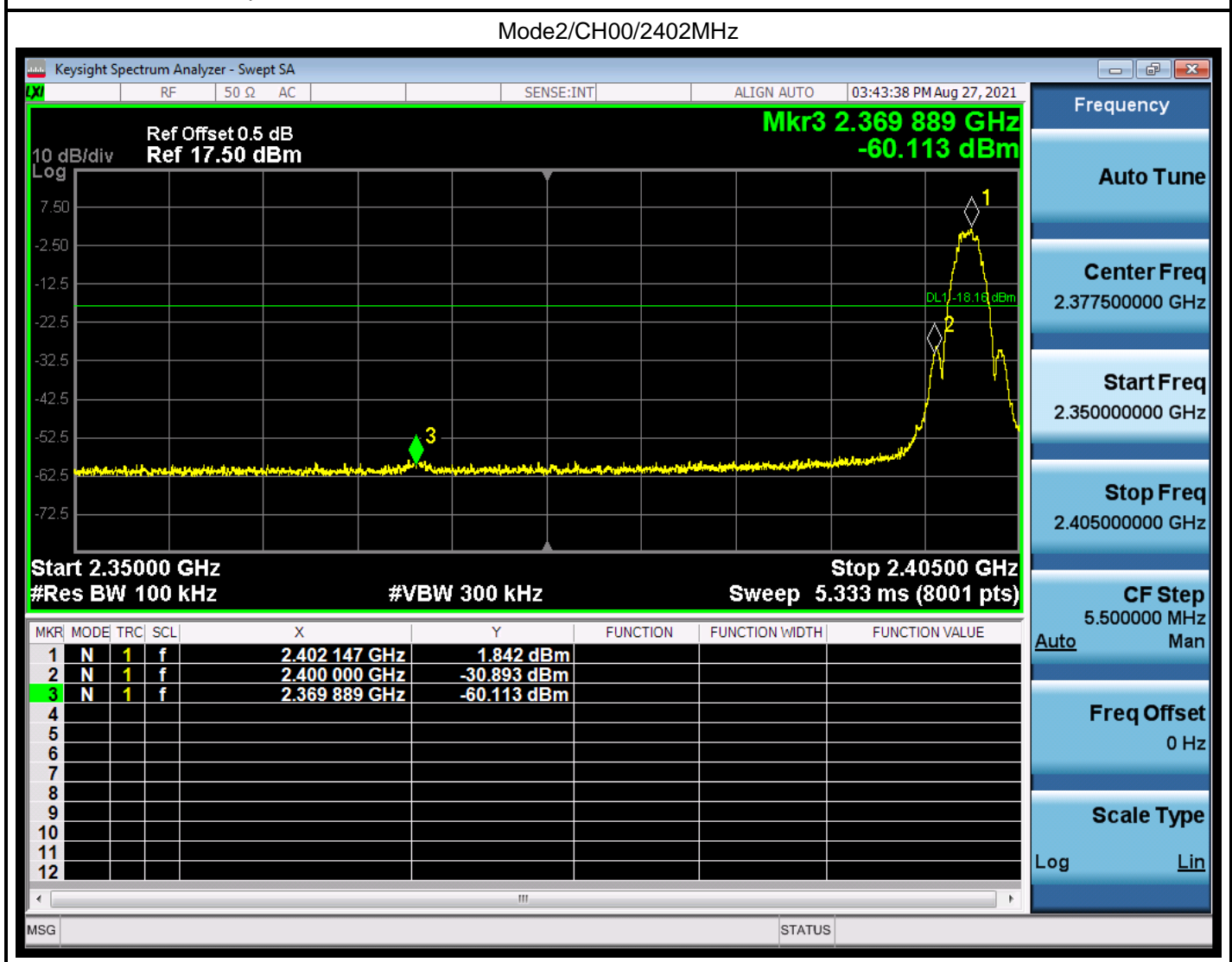

Mode 1 CH00 (2402MHz)

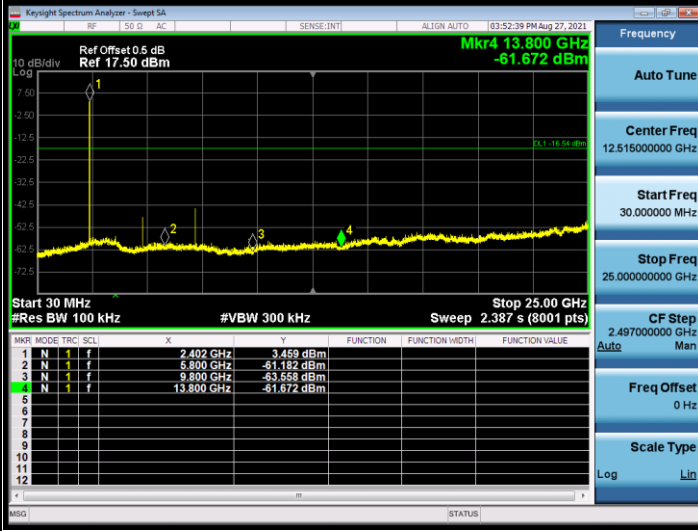

Mode 1 CH39 (2480MHz)

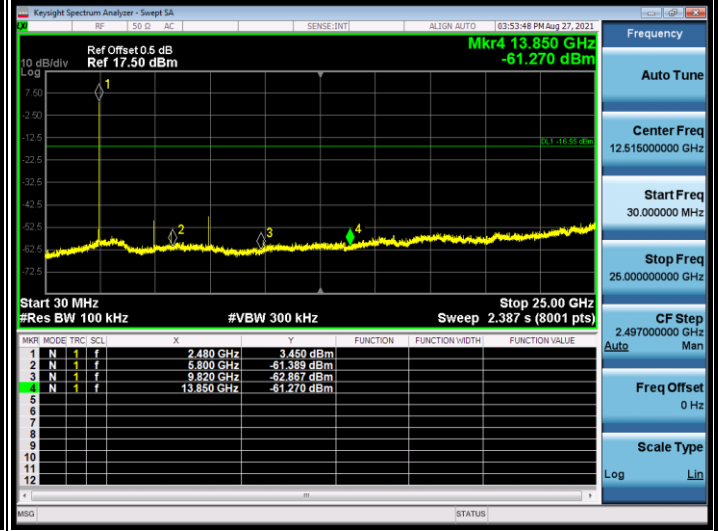

Mode 2 CH00 (2402MHz)

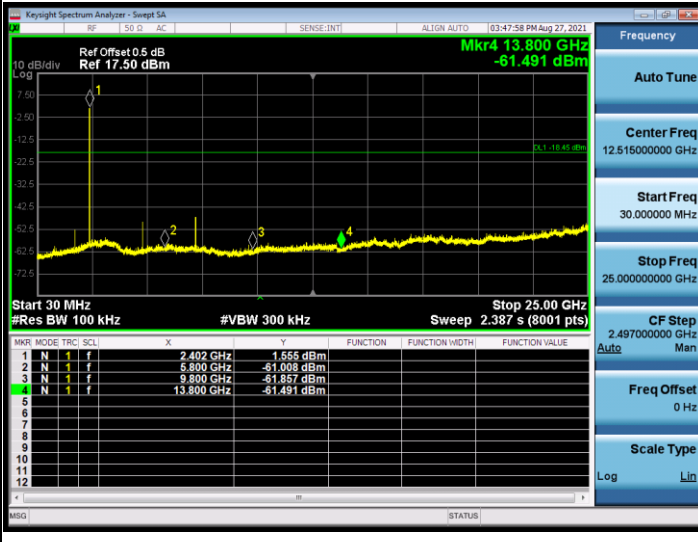

Mode 2 CH39 (2480MHz)

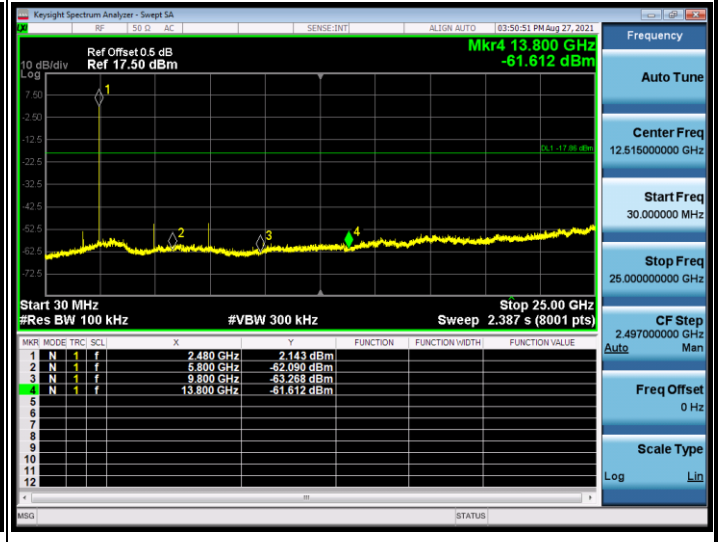

**4.4 Duty cycle**

**VERDICT: PASS**

**4.4.1 Limit**

N/A

**4.4.2 Test Setup**

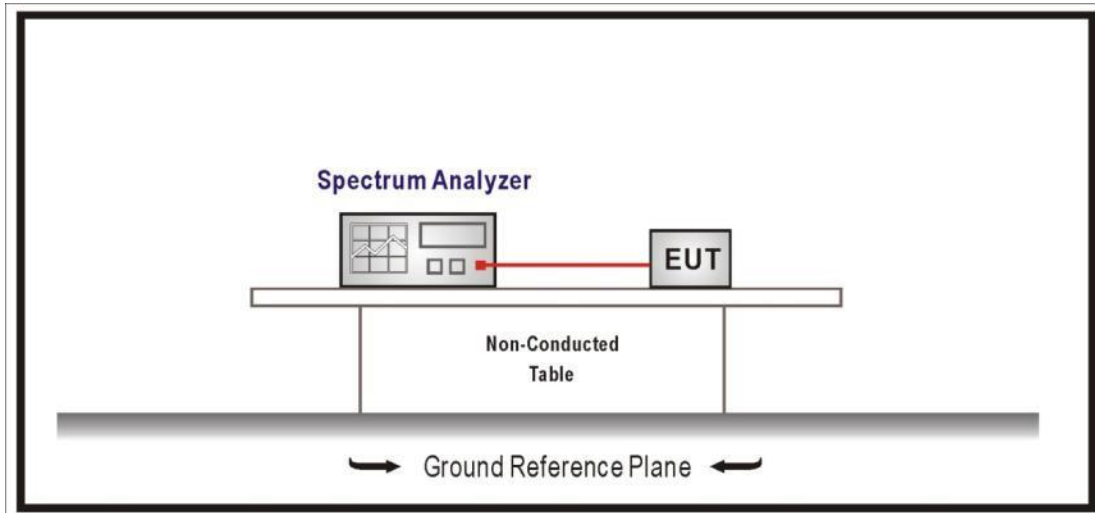

**4.4.3 Test Procedure**

References Rule	Chapter	Description
<input checked="" type="checkbox"/> ANSI C63.10	11.6	Duty cycle (D), transmission duration (T), and maximum power control level



**4.4.4 Test Data**

Test Mode	Tx On (us)	Tx Off (us)	VBW (Hz)	Tx On + Tx Off (us)	Duty Cycle (%)
Mode 1	N/A	N/A	10	N/A	100
Mode 2	N/A	N/A	10	N/A	100

Note 1: T means the minimum transmission duration over which the transmitter is on and is transmitting at its maximum power control level for the tested mode of operation.

Note 2: According to KDB 558074, when test for Radiated Emission Band Edge and Radiated Emission, for average detector set:  $VBW \geq 1/T$  will be used.

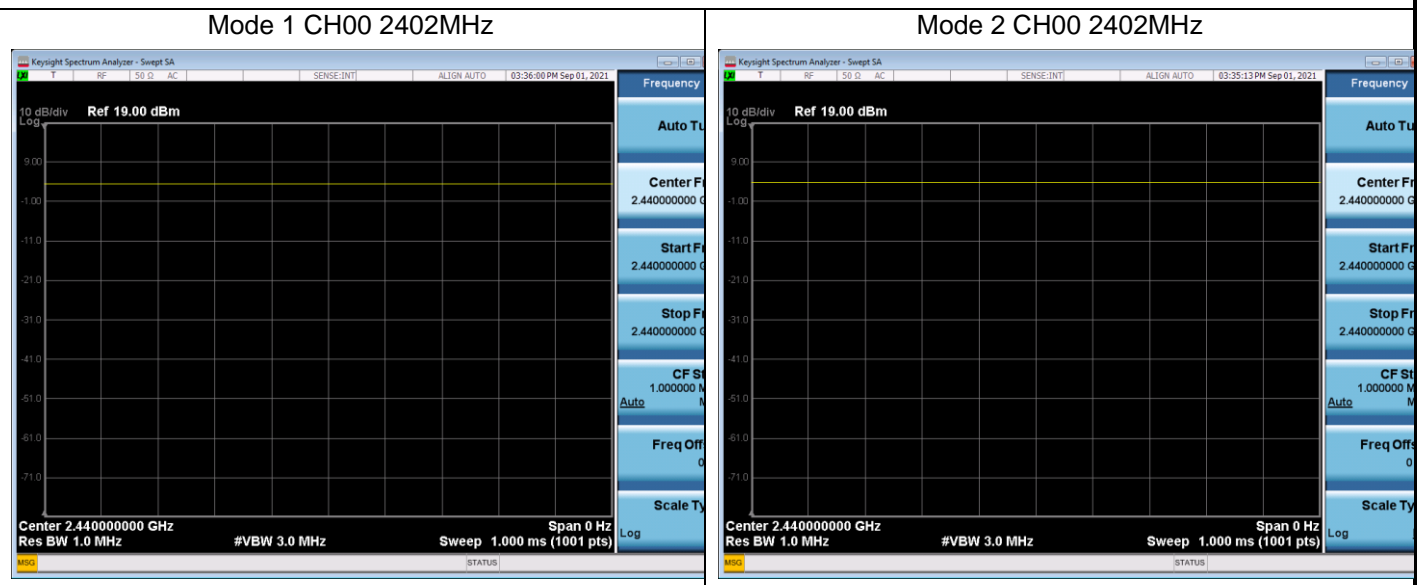

<b>4.5 Radiated Emission Band Edge</b>	<b>VERDICT:</b>	<b>PASS</b>
--	-----------------	-------------

**4.5.1 Limit**

<b>Standard</b>		FCC Part 15 Subpart C Paragraph 15.247(d) ,15.209		
Frequency bands (MHz)	Detector	Limit (dBµV/m)	RBW (MHz)	Distance (m)
2310-2390	PK	74	1	3
2483.5-2500	AV	54	1	3

Note: The field strength of emissions appearing within these frequency bands shall not exceed the limits.

**4.5.2 Test Setup**

Above 1GHz Test Setup:

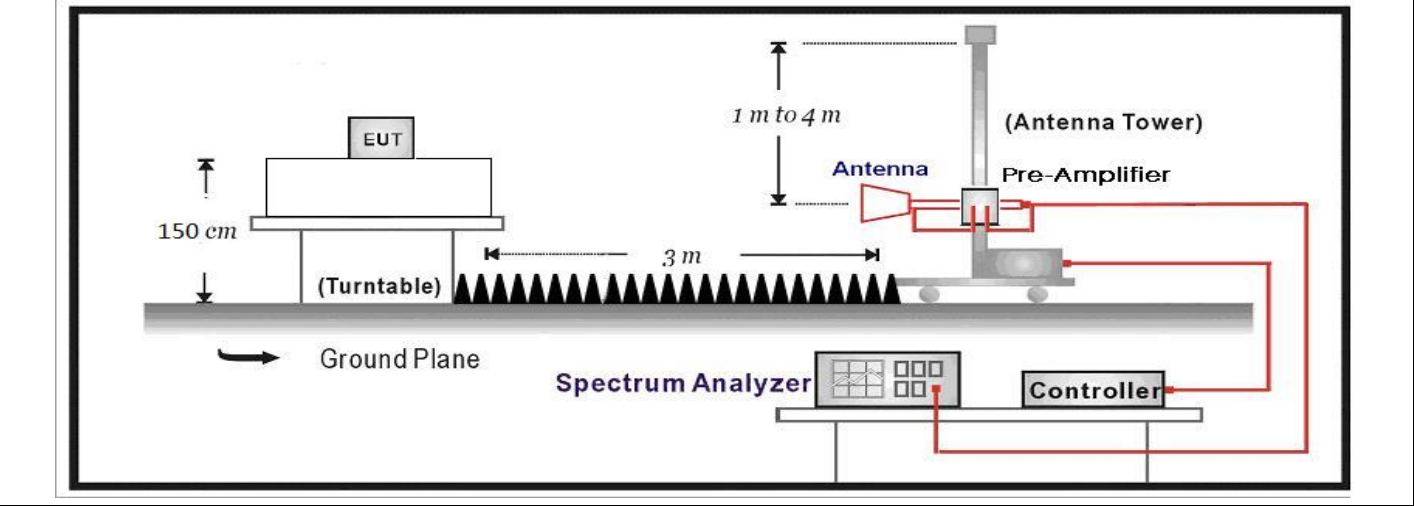

**4.5.3 Test Procedure**

	References Rule	Chapter	Description
<input checked="" type="checkbox"/>	ANSI C63.10	6.10	Band-edge testing
	<input checked="" type="checkbox"/> ANSI C63.10	6.10.5	Restricted-band band-edge measurements
	<input type="checkbox"/> ANSI C63.10	6.10.6	Marker-delta method
<input checked="" type="checkbox"/>	ANSI C63.10	11.12	Emissions in restricted frequency bands
	<input checked="" type="checkbox"/> ANSI C63.10	11.12.1	Radiated emission measurements
	<input checked="" type="checkbox"/> ANSI C63.10	11.12.2.7	Radiated spurious emission test
<input type="checkbox"/>	ANSI C63.10	6.4	Radiated emissions from unlicensed wireless devices below 30 MHz
<input type="checkbox"/>	ANSI C63.10	6.5	Radiated emissions from unlicensed wireless devices in the frequency range of 30 MHz to 1000 MHz
<input checked="" type="checkbox"/>	ANSI C63.10	6.6	Radiated emissions from unlicensed wireless devices above 1 GHz

**4.5.4 Test Data**

Profile: 2180930R	Page No.: 157
Engineer: Juliuszhou	
Site: AC5	Time: 2021/09/05 - 13:06
Limit: FCC_Part15.209_RE(3m)	Margin: 0
Probe: Horn_3117_00123988_(1-18GHz)	Polarity: Horizontal
EUT: DriveWell Tag	Power: AC 120V/60Hz
Note: Mode 1:Transmit at 2402MHz by ble1M	

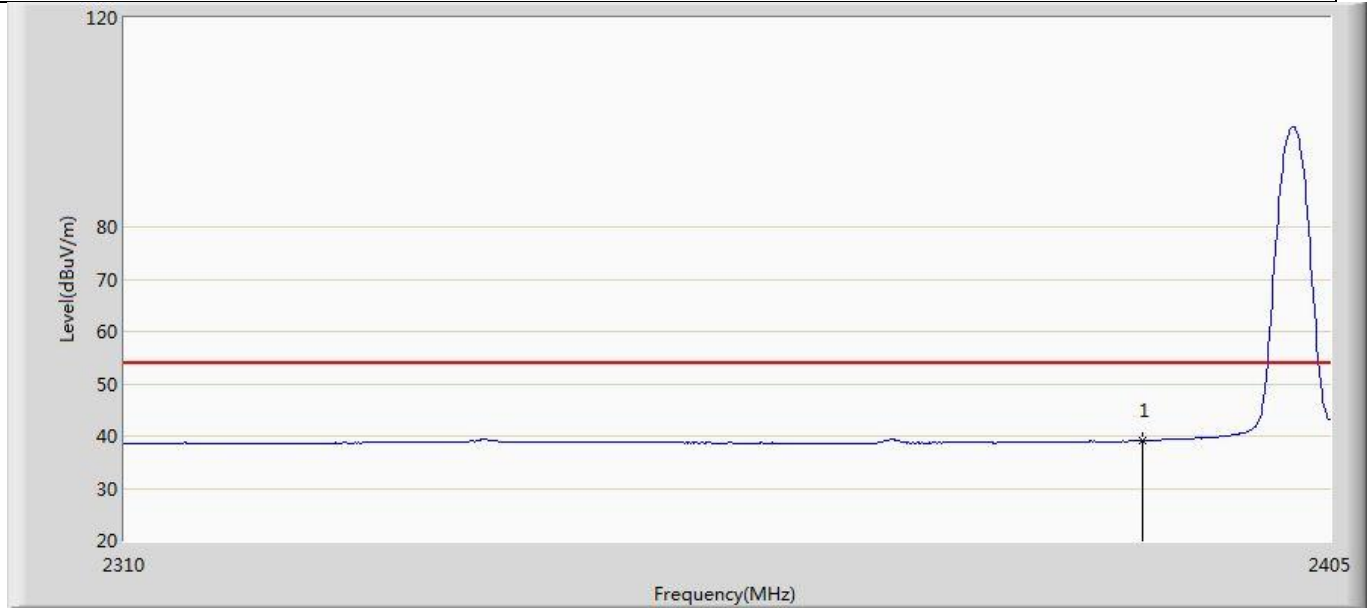

No	Mark	Frequency (MHz)	Measure Level (dBuV/m)	Reading Level (dBuV)	Over Limit (dB)	Limit (dBuV/m)	Factor (dB)	Type
1	*	2390.000	39.097	3.638	-14.903	54.000	35.459	AV

Profile: 2180930R	Page No.: 158
Engineer: Juliuszhou	
Site: AC5	Time: 2021/09/05 - 13:10
Limit: FCC_Part15.209_RE(3m)	Margin: 0
Probe: Horn_3117_00123988_(1-18GHz)	Polarity: Horizontal
EUT: DriveWell Tag	Power: AC 120V/60Hz
Note: Mode 1:Transmit at 2402MHz by ble1M	

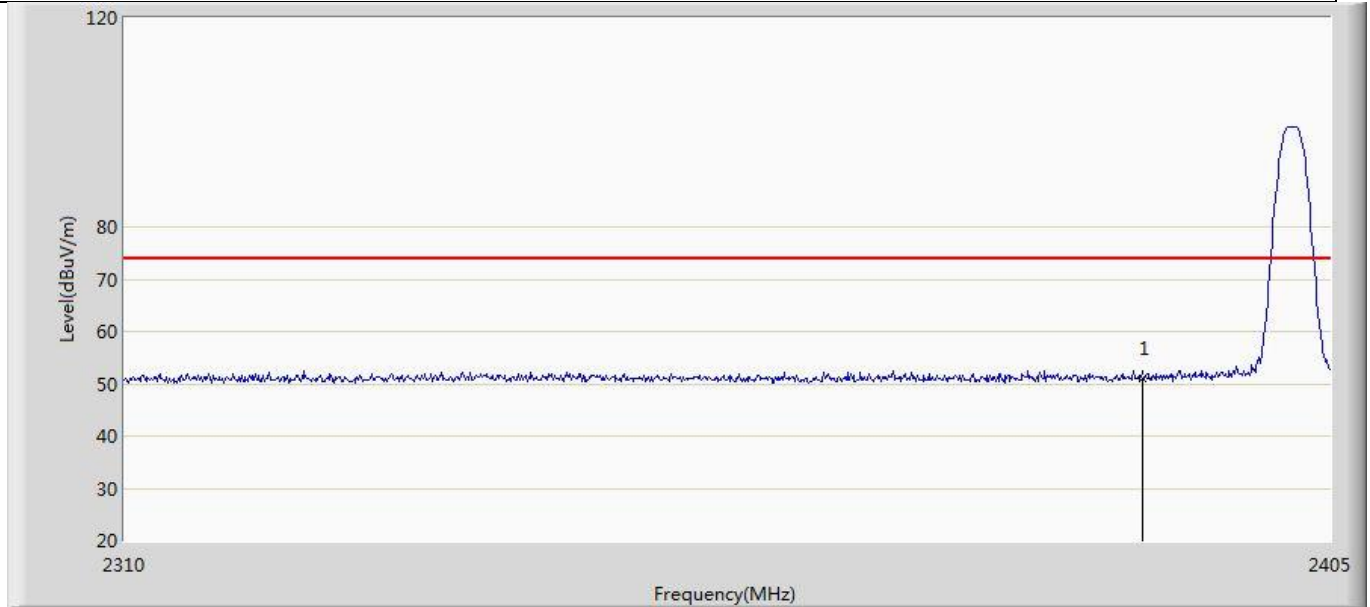

No	Mark	Frequency (MHz)	Measure Level (dBuV/m)	Reading Level (dBuV)	Over Limit (dB)	Limit (dBuV/m)	Factor (dB)	Type
1	*	2390.000	50.920	15.461	-23.080	74.000	35.459	PK

Profile: 2180930R	Page No.: 159
Engineer: Juliuszhou	
Site: AC5	Time: 2021/09/05 - 13:12
Limit: FCC_Part15.209_RE(3m)	Margin: 0
Probe: Horn_3117_00123988_(1-18GHz)	Polarity: Vertical
EUT: DriveWell Tag	Power: AC 120V/60Hz
Note: Mode 1:Transmit at 2402MHz by ble1M	

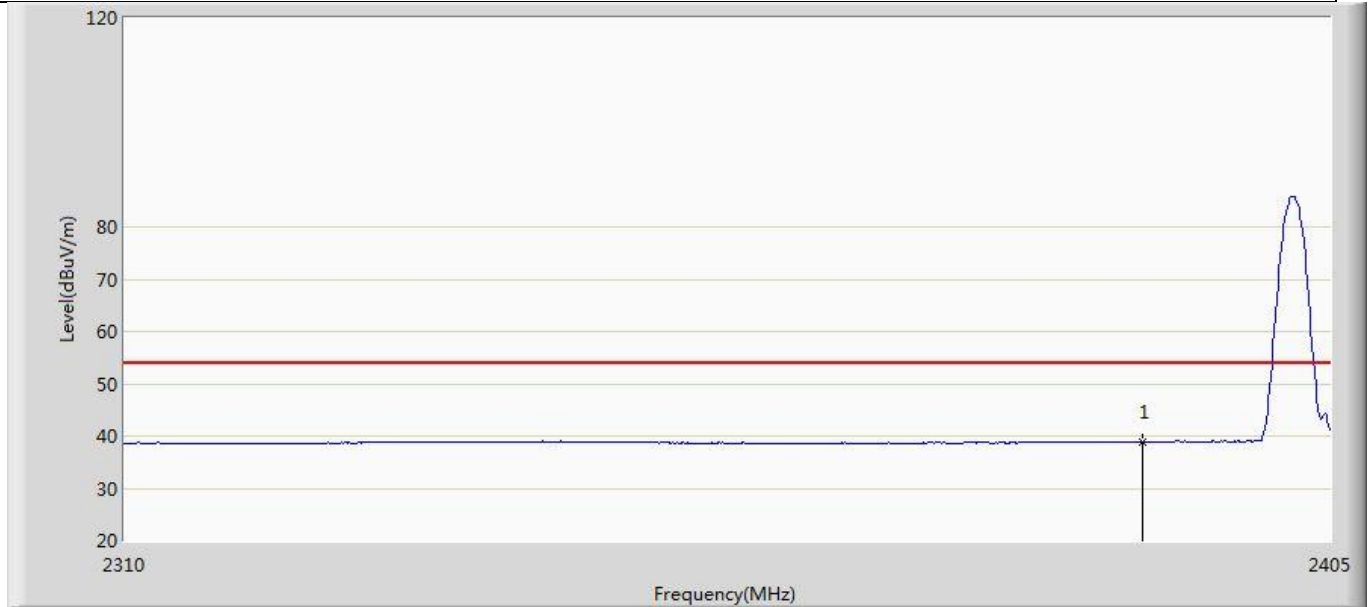

No	Mark	Frequency (MHz)	Measure Level (dBuV/m)	Reading Level (dBuV)	Over Limit (dB)	Limit (dBuV/m)	Factor (dB)	Type
1	*	2390.000	38.782	3.323	-15.218	54.000	35.459	AV

Profile: 2180930R	Page No.: 160
Engineer: Juliuszhou	
Site: AC5	Time: 2021/09/05 - 13:13
Limit: FCC_Part15.209_RE(3m)	Margin: 0
Probe: Horn_3117_00123988_(1-18GHz)	Polarity: Vertical
EUT: DriveWell Tag	Power: AC 120V/60Hz
Note: Mode 1:Transmit at 2402MHz by ble1M	

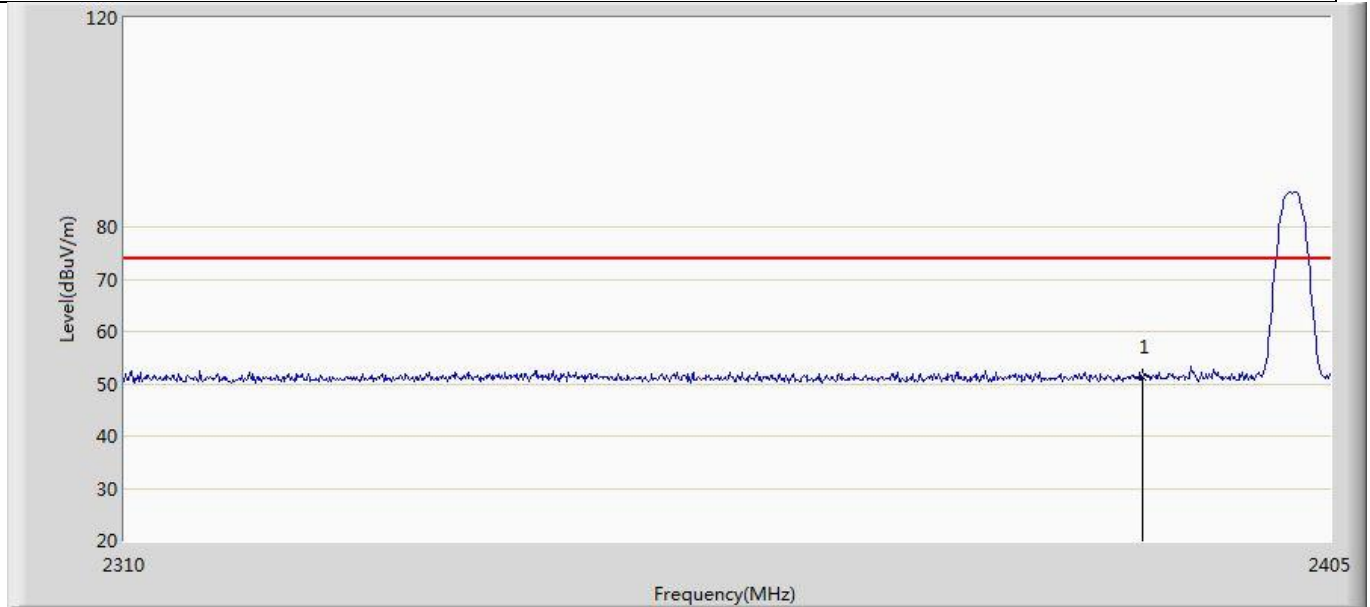

No	Mark	Frequency (MHz)	Measure Level (dBuV/m)	Reading Level (dBuV)	Over Limit (dB)	Limit (dBuV/m)	Factor (dB)	Type
1	*	2390.000	51.190	15.731	-22.810	74.000	35.459	PK

Profile: 2180930R	Page No.: 161
Engineer: Juliuszhou	
Site: AC5	Time: 2021/09/05 - 13:16
Limit: FCC_Part15.209_RE(3m)	Margin: 0
Probe: Horn_3117_00123988_(1-18GHz)	Polarity: Horizontal
EUT: DriveWell Tag	Power: AC 120V/60Hz
Note: Mode 1:Transmit at 2480MHz by ble1M	

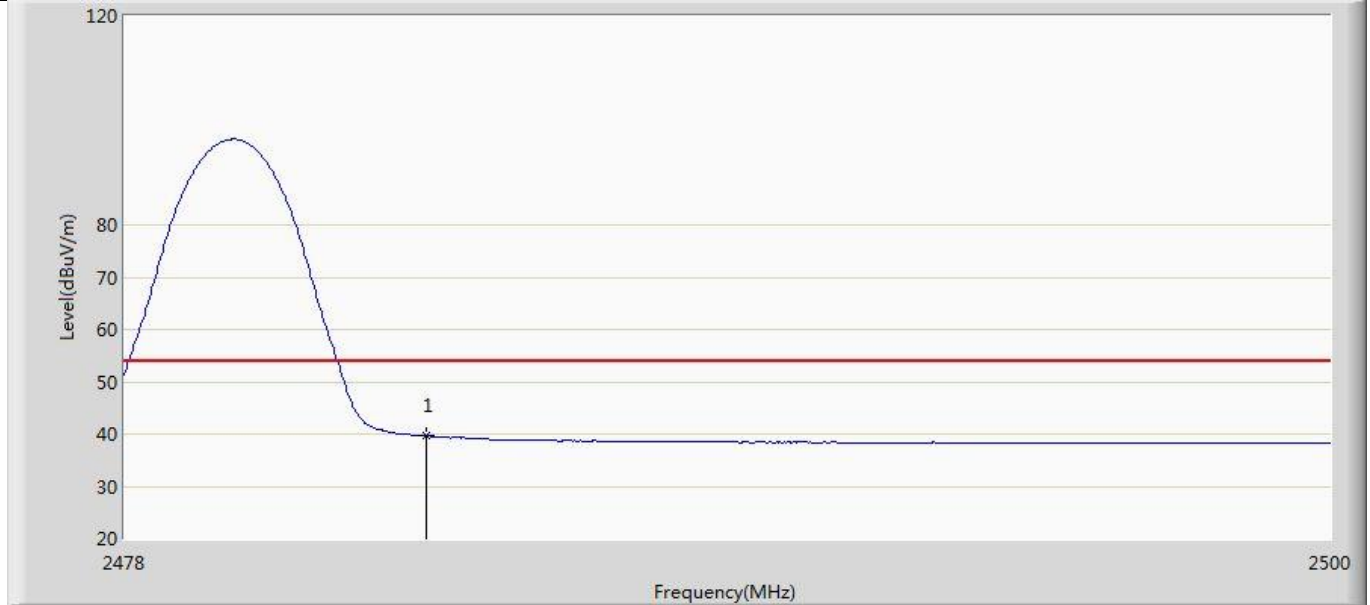

No	Mark	Frequency (MHz)	Measure Level (dBuV/m)	Reading Level (dBuV)	Over Limit (dB)	Limit (dBuV/m)	Factor (dB)	Type
1	*	2483.500	39.614	3.939	-14.386	54.000	35.675	AV

Profile: 2180930R	Page No.: 162
Engineer: Juliuszhou	
Site: AC5	Time: 2021/09/05 - 13:18
Limit: FCC_Part15.209_RE(3m)	Margin: 0
Probe: Horn_3117_00123988_(1-18GHz)	Polarity: Horizontal
EUT: DriveWell Tag	Power: AC 120V/60Hz
Note: Mode 1:Transmit at 2480MHz by ble1M	

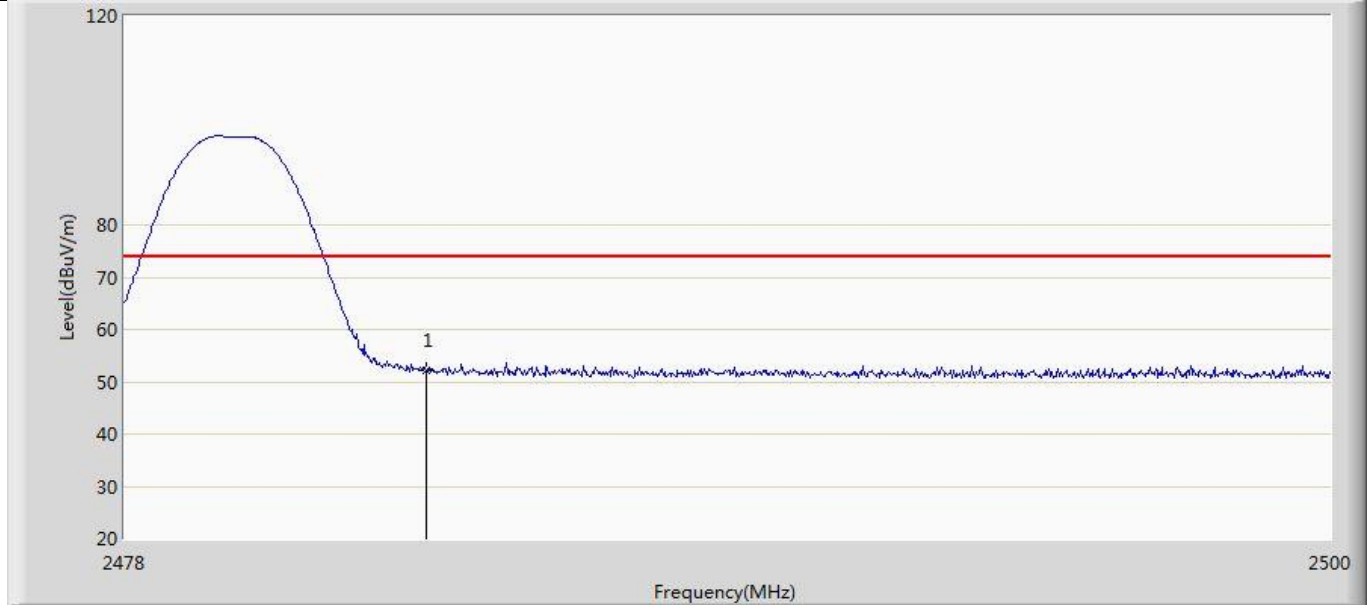

No	Mark	Frequency (MHz)	Measure Level (dBuV/m)	Reading Level (dBuV)	Over Limit (dB)	Limit (dBuV/m)	Factor (dB)	Type
1	*	2483.500	52.167	16.492	-21.833	74.000	35.675	PK



Profile: 2180930R	Page No.: 163
Engineer: Juliuszhou	
Site: AC5	Time: 2021/09/05 - 13:19
Limit: FCC_Part15.209_RE(3m)	Margin: 0
Probe: Horn_3117_00123988_(1-18GHz)	Polarity: Vertical
EUT: DriveWell Tag	Power: AC 120V/60Hz
Note: Mode 1:Transmit at 2480MHz by ble1M	

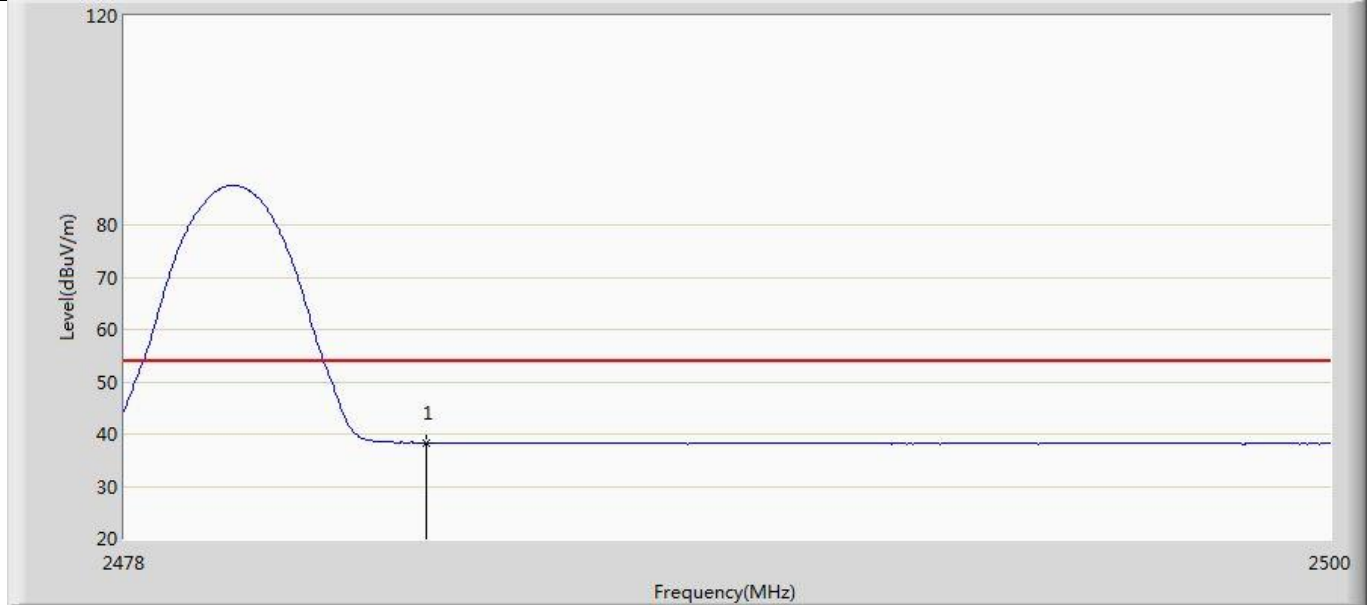

No	Mark	Frequency (MHz)	Measure Level (dBuV/m)	Reading Level (dBuV)	Over Limit (dB)	Limit (dBuV/m)	Factor (dB)	Type
1	*	2483.500	38.245	2.570	-15.755	54.000	35.675	AV

Profile: 2180930R	Page No.: 164
Engineer: Juliuszhou	
Site: AC5	Time: 2021/09/05 - 13:20
Limit: FCC_Part15.209_RE(3m)	Margin: 0
Probe: Horn_3117_00123988_(1-18GHz)	Polarity: Vertical
EUT: DriveWell Tag	Power: AC 120V/60Hz
Note: Mode 1:Transmit at 2480MHz by ble1M	

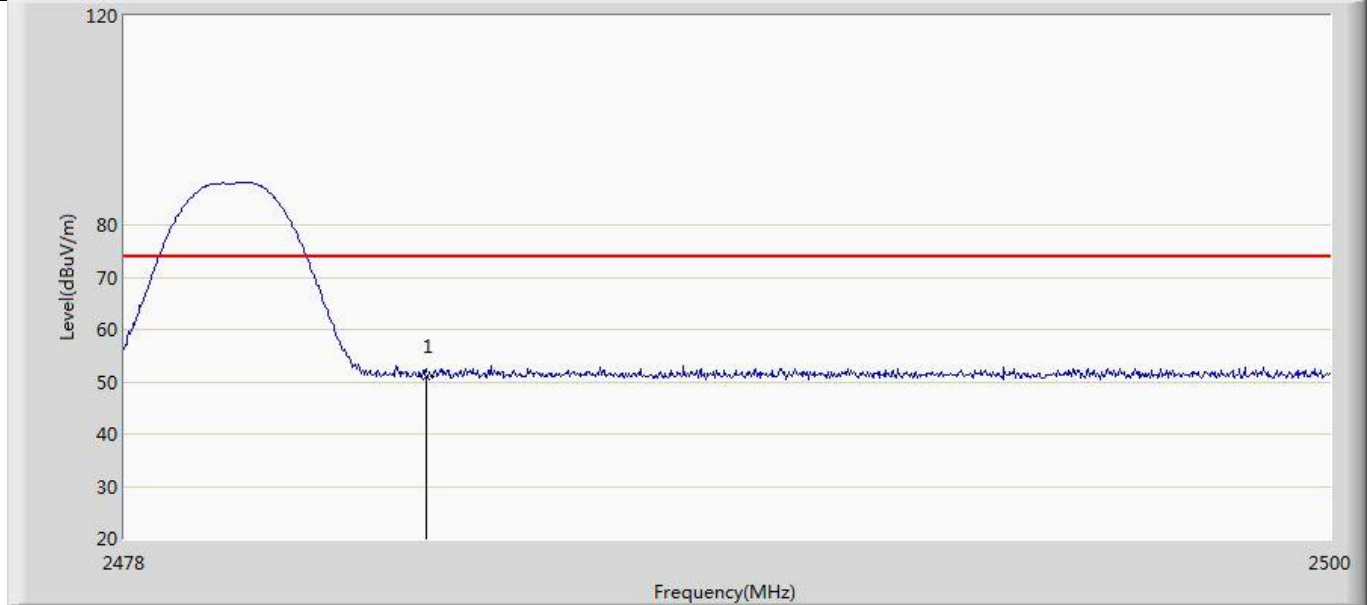

No	Mark	Frequency (MHz)	Measure Level (dBuV/m)	Reading Level (dBuV)	Over Limit (dB)	Limit (dBuV/m)	Factor (dB)	Type
1	*	2483.500	50.972	15.297	-23.028	74.000	35.675	PK

Profile: 2180930R	Page No.: 165
Engineer: Juliuszhou	
Site: AC5	Time: 2021/09/05 - 13:22
Limit: FCC_Part15.209_RE(3m)	Margin: 0
Probe: Horn_3117_00123988_(1-18GHz)	Polarity: Horizontal
EUT: DriveWell Tag	Power: AC 120V/60Hz
Note: Mode 2:Transmit at 2402MHz by ble2M	

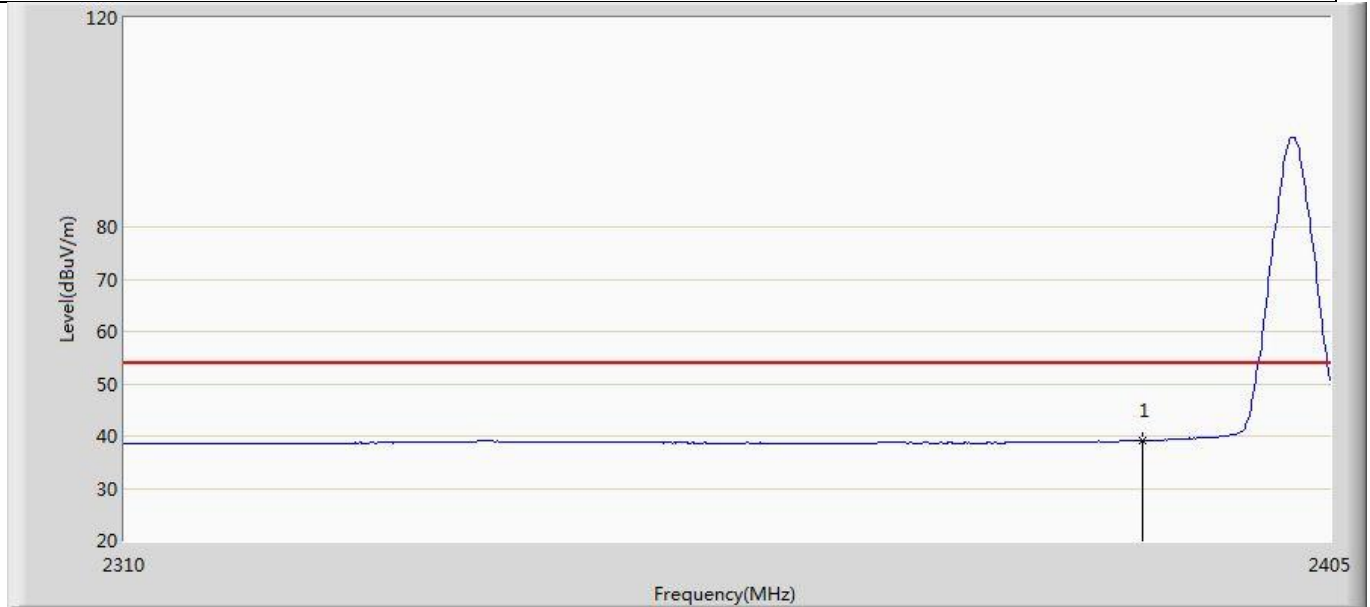

No	Mark	Frequency (MHz)	Measure Level (dBuV/m)	Reading Level (dBuV)	Over Limit (dB)	Limit (dBuV/m)	Factor (dB)	Type
1	*	2390.000	39.087	3.628	-14.913	54.000	35.459	AV

Profile: 2180930R	Page No.: 166
Engineer: Juliuszhou	
Site: AC5	Time: 2021/09/05 - 13:24
Limit: FCC_Part15.209_RE(3m)	Margin: 0
Probe: Horn_3117_00123988_(1-18GHz)	Polarity: Horizontal
EUT: DriveWell Tag	Power: AC 120V/60Hz
Note: Mode 2:Transmit at 2402MHz by ble2M	

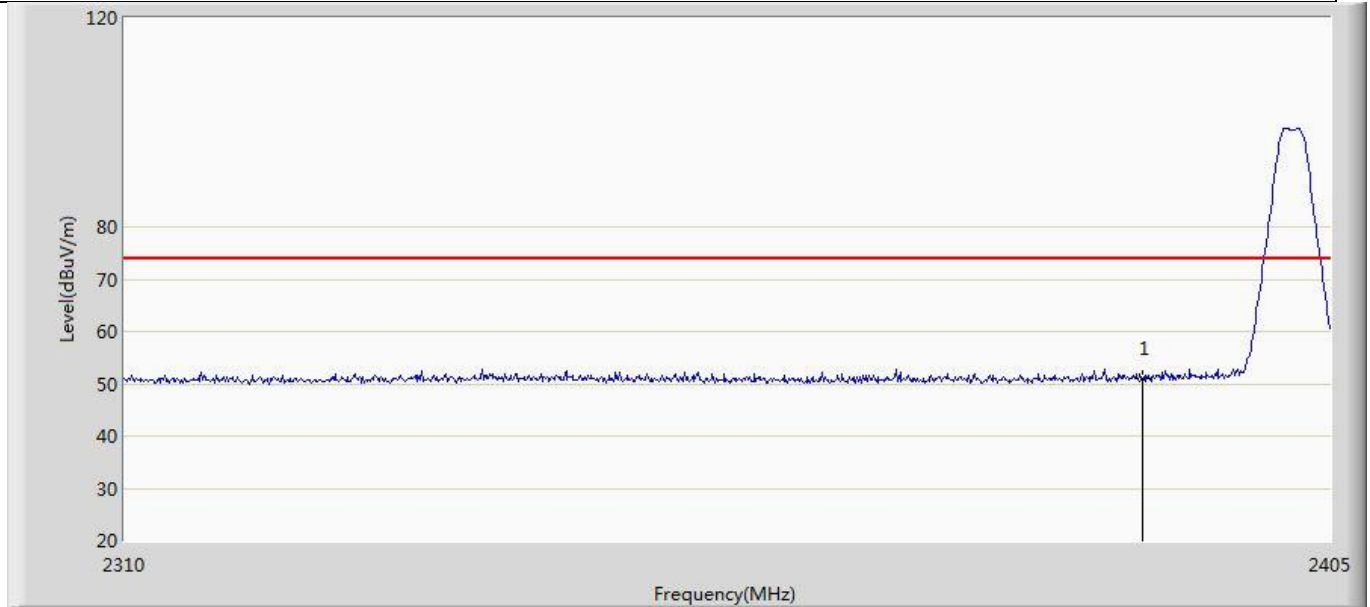

No	Mark	Frequency (MHz)	Measure Level (dBuV/m)	Reading Level (dBuV)	Over Limit (dB)	Limit (dBuV/m)	Factor (dB)	Type
1	*	2390.000	51.069	15.610	-22.931	74.000	35.459	PK

Profile: 2180930R	Page No.: 167
Engineer: Juliuszhou	
Site: AC5	Time: 2021/09/05 - 13:25
Limit: FCC_Part15.209_RE(3m)	Margin: 0
Probe: Horn_3117_00123988_(1-18GHz)	Polarity: Vertical
EUT: DriveWell Tag	Power: AC 120V/60Hz
Note: Mode 2:Transmit at 2402MHz by ble2M	

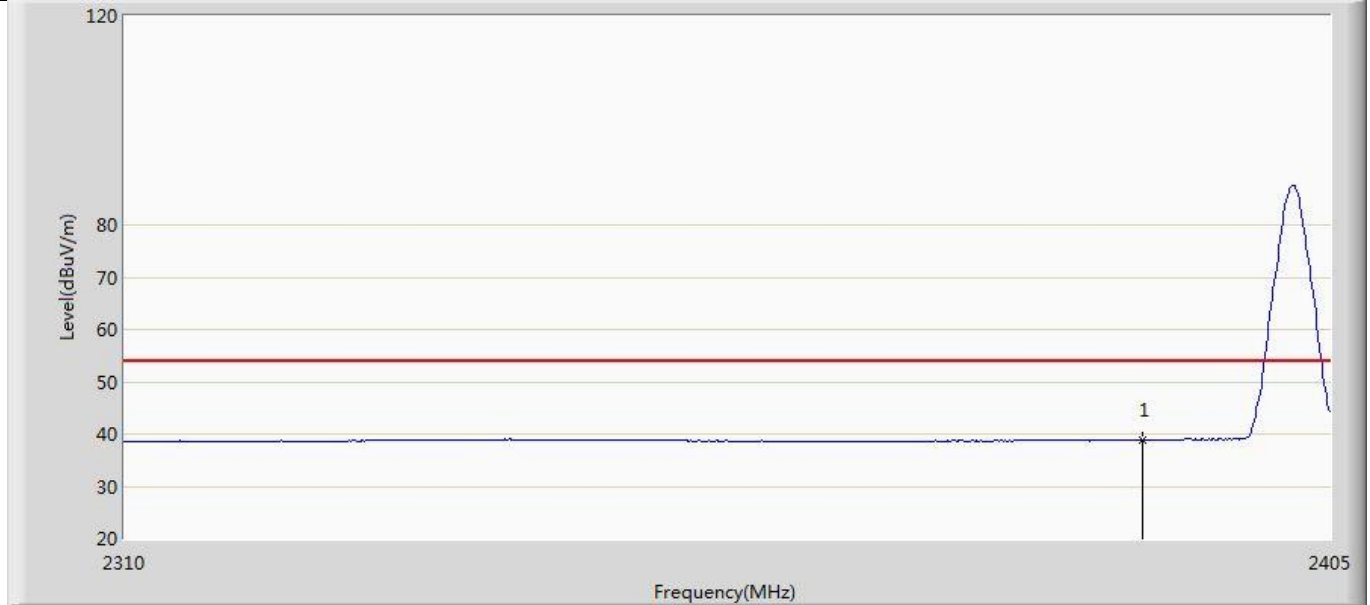

No	Mark	Frequency (MHz)	Measure Level (dBuV/m)	Reading Level (dBuV)	Over Limit (dB)	Limit (dBuV/m)	Factor (dB)	Type
1	*	2390.000	38.862	3.403	-15.138	54.000	35.459	AV

Profile: 2180930R	Page No.: 168
Engineer: Juliuszhou	
Site: AC5	Time: 2021/09/05 - 13:27
Limit: FCC_Part15.209_RE(3m)	Margin: 0
Probe: Horn_3117_00123988_(1-18GHz)	Polarity: Vertical
EUT: DriveWell Tag	Power: AC 120V/60Hz
Note: Mode 2:Transmit at 2402MHz by ble2M	

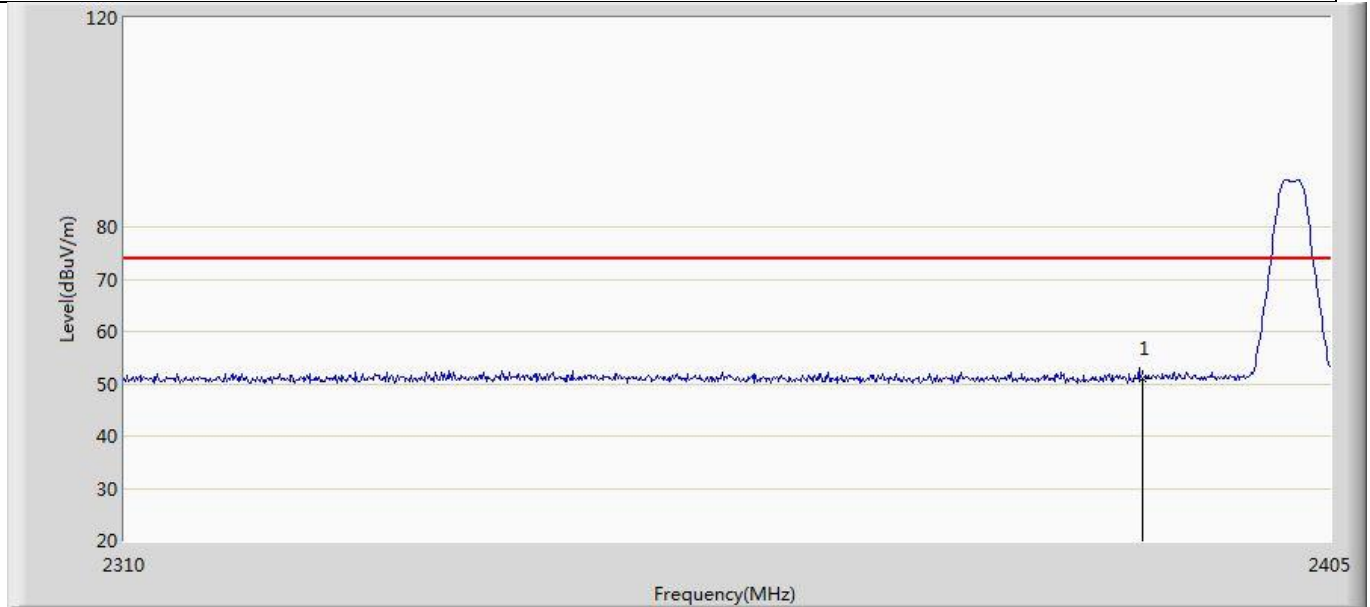

No	Mark	Frequency (MHz)	Measure Level (dBuV/m)	Reading Level (dBuV)	Over Limit (dB)	Limit (dBuV/m)	Factor (dB)	Type
1	*	2390.000	51.023	15.564	-22.977	74.000	35.459	PK

Profile: 2180930R	Page No.: 169
Engineer: Juliuszhou	
Site: AC5	Time: 2021/09/05 - 14:01
Limit: FCC_Part15.209_RE(3m)	Margin: 0
Probe: Horn_3117_00123988_(1-18GHz)	Polarity: Horizontal
EUT: DriveWell Tag	Power: AC 120V/60Hz
Note: Mode 2:Transmit at 2480MHz by ble2M	

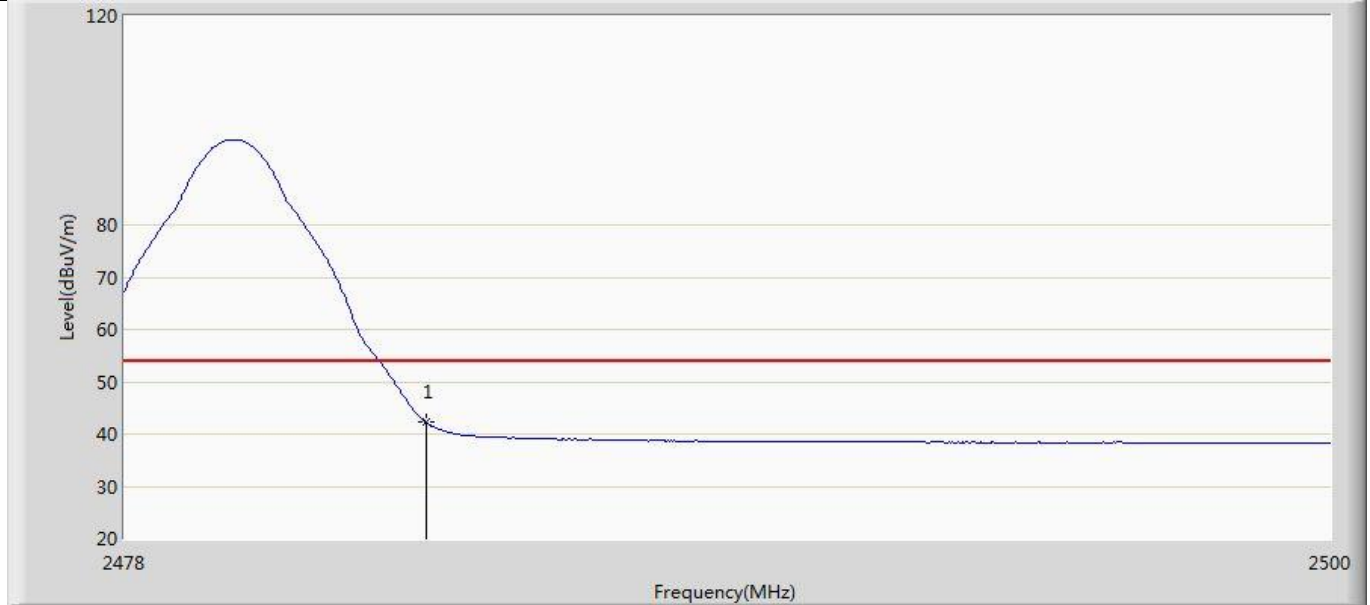

No	Mark	Frequency (MHz)	Measure Level (dBuV/m)	Reading Level (dBuV)	Over Limit (dB)	Limit (dBuV/m)	Factor (dB)	Type
1	*	2483.500	42.180	6.505	-11.820	54.000	35.675	AV

Profile: 2180930R	Page No.: 170
Engineer: Juliuszhou	
Site: AC5	Time: 2021/09/05 - 14:06
Limit: FCC_Part15.209_RE(3m)	Margin: 0
Probe: Horn_3117_00123988_(1-18GHz)	Polarity: Horizontal
EUT: DriveWell Tag	Power: AC 120V/60Hz
Note: Mode 2:Transmit at 2480MHz by ble2M	

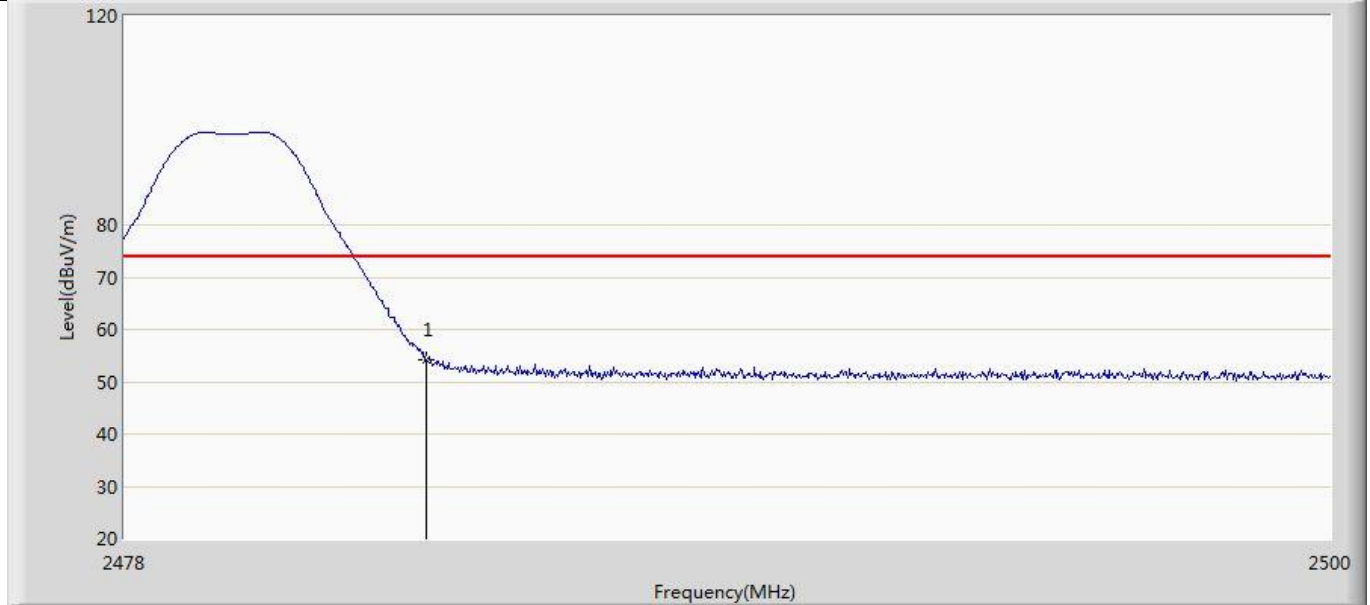

No	Mark	Frequency (MHz)	Measure Level (dBuV/m)	Reading Level (dBuV)	Over Limit (dB)	Limit (dBuV/m)	Factor (dB)	Type
1	*	2483.500	54.333	18.658	-19.667	74.000	35.675	PK



Profile: 2180930R	Page No.: 171
Engineer: Juliuszhou	
Site: AC5	Time: 2021/09/05 - 14:07
Limit: FCC_Part15.209_RE(3m)	Margin: 0
Probe: Horn_3117_00123988_(1-18GHz)	Polarity: Vertical
EUT: DriveWell Tag	Power: AC 120V/60Hz
Note: Mode 2:Transmit at 2480MHz by ble2M	

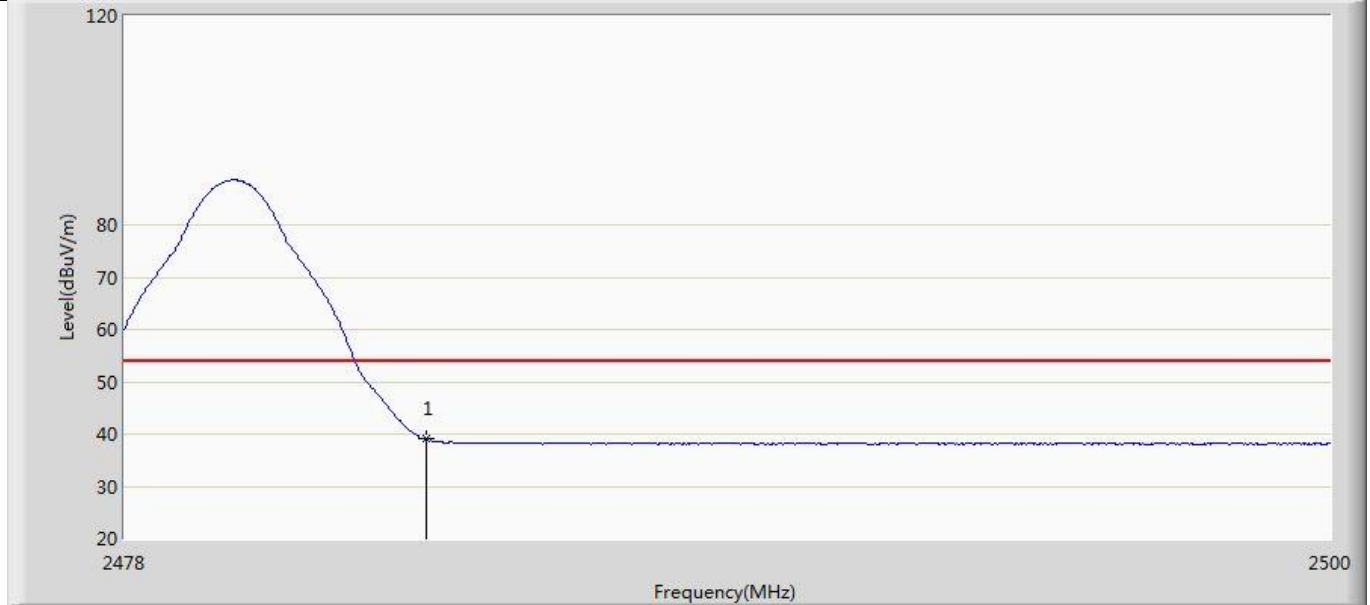

No	Mark	Frequency (MHz)	Measure Level (dBuV/m)	Reading Level (dBuV)	Over Limit (dB)	Limit (dBuV/m)	Factor (dB)	Type
1	*	2483.500	39.011	3.336	-14.989	54.000	35.675	AV

Profile: 2180930R	Page No.: 172
Engineer: Juliuszhou	
Site: AC5	Time: 2021/09/05 - 14:09
Limit: FCC_Part15.209_RE(3m)	Margin: 0
Probe: Horn_3117_00123988_(1-18GHz)	Polarity: Vertical
EUT: DriveWell Tag	Power: AC 120V/60Hz
Note: Mode 2:Transmit at 2480MHz by ble2M	

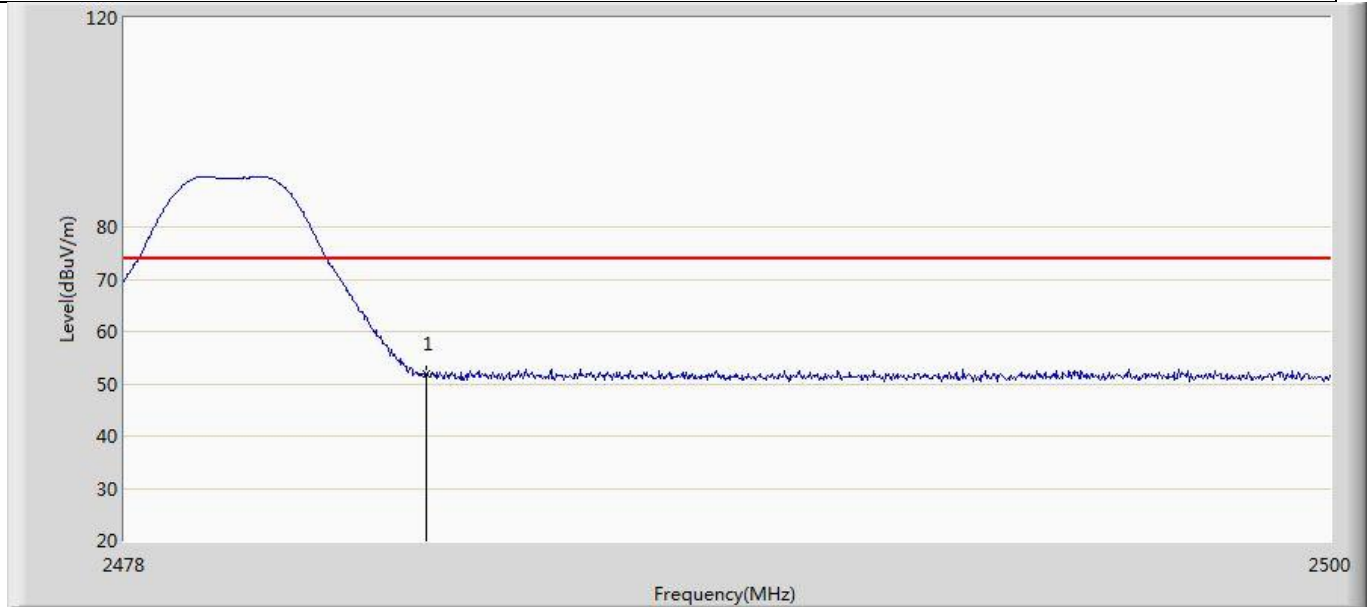

No	Mark	Frequency (MHz)	Measure Level (dBuV/m)	Reading Level (dBuV)	Over Limit (dB)	Limit (dBuV/m)	Factor (dB)	Type
1	*	2483.500	52.006	16.331	-21.994	74.000	35.675	PK

<b>4.6 DTS Bandwidth</b>	<b>VERDICT: PASS</b>
--------------------------	----------------------

<b>4.6.1 Limit</b>	
<b>Standard</b>	FCC Part 15 Subpart C Paragraph 15.247 (a)(2)
Systems using digital modulation techniques operate in the 2400-2483.5 MHz. The minimum 6 dB bandwidth shall be at least 500 kHz	

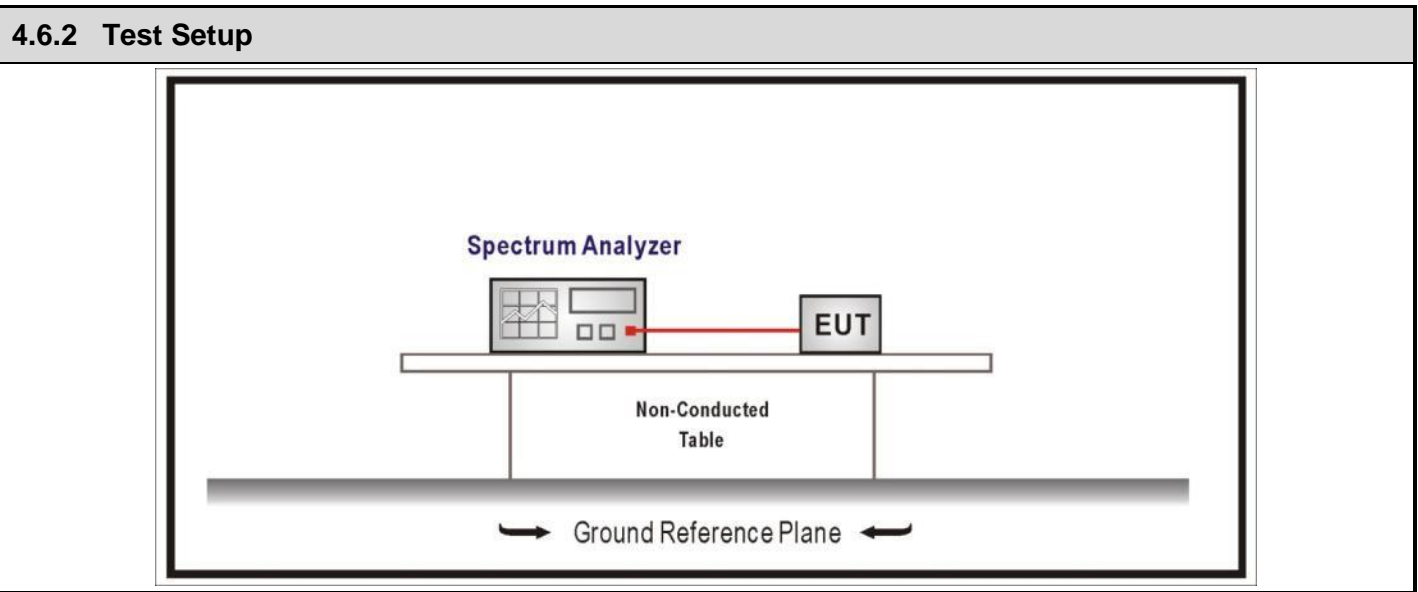

<b>4.6.3 Test Procedure</b>			
	Reference Rule	Chapter	Description
<input checked="" type="checkbox"/>	ANSI C63.10	11.8	DTS bandwidth
<input type="checkbox"/>	ANSI C63.10	11.8.1	Option 1
<input checked="" type="checkbox"/>	ANSI C63.10	11.8.2	Option 2

### 4.6.4 Test Data

Mode	CH.	Test Freq. (MHz)	99% Occupied Bandwidth (MHz)	6dB Occupied Bandwidth (kHz)	Limit (kHz)	Result
1	00	2402	1.0377	698.0	>500	Pass
	19	2440	1.0352	696.4	>500	Pass
	39	2480	1.0456	727.2	>500	Pass
2	00	2402	2.1094	1359	>500	Pass
	19	2440	2.0771	1356	>500	Pass
	39	2480	2.1067	1393	>500	Pass

Note : The worst case of Occupied Bandwidth as below:

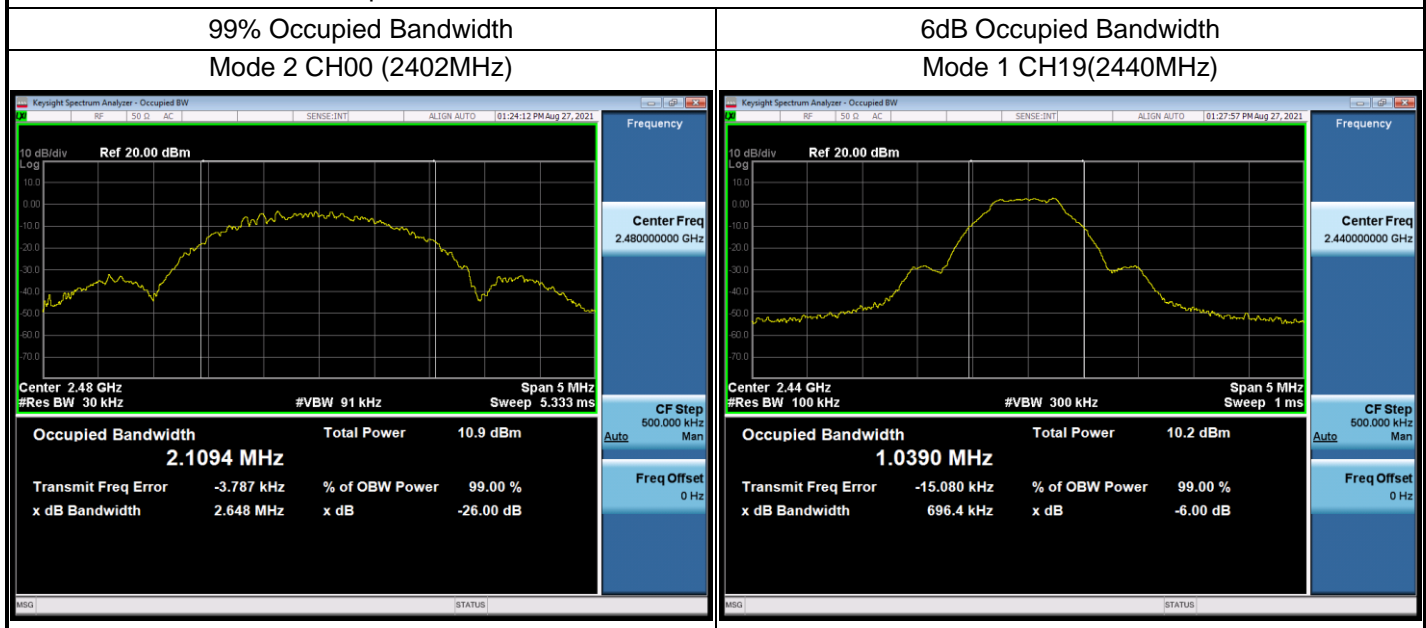

<b>4.7 Fundamental emission output power</b>	<b>VERDICT: PASS</b>
--	----------------------

4.7.1 Limit			
Standard	FCC Part 15 Subpart C Paragraph 15.247 (b)(3)		
<input checked="" type="checkbox"/>	GTX < 6dBi	Pout ≤ 30dBm	
<input type="checkbox"/>	GTX > 6dBi		
<input type="checkbox"/>	Non-Fix point-point	Pout ≤ 30 - (GTX - 6)	
<input type="checkbox"/>	Fix point-point	Pout ≤ 30 - [(GTX - 6)]/3	
<input type="checkbox"/>	Point-to-multipoint	Pout ≤ 30 - (GTX - 6)	
<input type="checkbox"/>	Overlap Beams	Pout ≤ 30 - [(GTX - 6)]/3	
<input type="checkbox"/>	Aggregate power transmitted simultaneously on all beams	Pout ≤ 30 - [(GTX - 6)]/3	
<input type="checkbox"/>	single directional beam	Pout ≤ 30 - [(GTX - 6)]/3 + 8dB	
Note 1 : GTX directional gain of transmitting antennas. Note 2 : Pout is maximum peak conducted output power .			

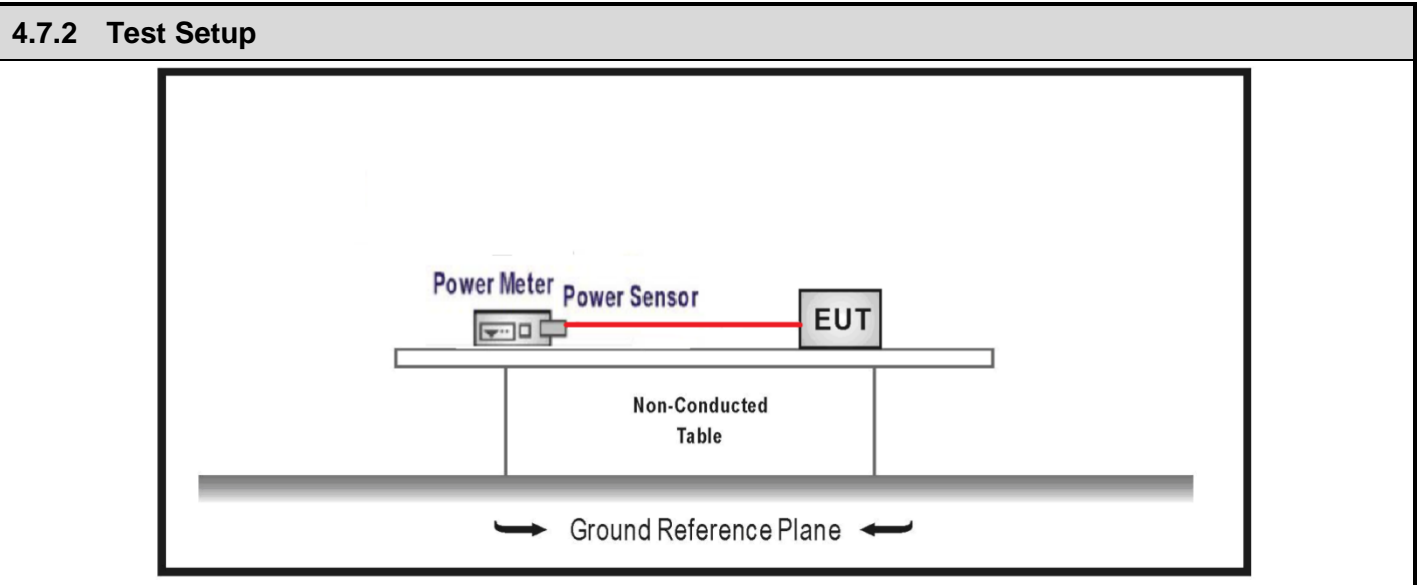

4.7.3 Test Procedure					
	References Rule		Chapter	Description	
<input checked="" type="checkbox"/>	ANSI C63.10		11.9	Fundamental emission output power	
	<input checked="" type="checkbox"/>	ANSI C63.10		11.9.1 Maximum peak conducted output power	
		<input type="checkbox"/>	ANSI C63.10	11.9.1.1 RBW $\geq$ DTS bandwidth	
		<input type="checkbox"/>	ANSI C63.10	11.9.1.2 Integrated band power method	
		<input checked="" type="checkbox"/>	ANSI C63.10	11.9.1.3 PKPM1 Peak power meter method	
	<input type="checkbox"/>	ANSI C63.10		11.9.2 Maximum conducted (average) output power	
		<input type="checkbox"/>	ANSI C63.10		11.9.2.2 Measurement using a spectrum analyzer (SA)
			<input type="checkbox"/>	ANSI C63.10	11.9.2.2.2 Method AVGSA-1(Duty cycle $\geq$ 98%)
			<input type="checkbox"/>	ANSI C63.10	11.9.2.2.3 Method AVGSA-1A(Duty cycle $\geq$ 98%)
			<input type="checkbox"/>	ANSI C63.10	11.9.2.2.4 Method AVGSA-2(Duty cycle $\leq$ 98%)
			<input type="checkbox"/>	ANSI C63.10	11.9.2.2.5 Method AVGSA-2A(Duty cycle $\leq$ 98%)
			<input type="checkbox"/>	ANSI C63.10	11.9.2.2.4 Method AVGSA-3
		<input type="checkbox"/>	ANSI C63.10	11.9.2.2.5 Method AVGSA-3A	
		<input type="checkbox"/>	ANSI C63.10		11.9.2.3 Measurement using a power meter (PM)
			<input type="checkbox"/>	ANSI C63.10	11.9.2.3.1 Method AVGPM
<input type="checkbox"/>	ANSI C63.10		11.9.2.3.2 Method AVGPM-G		

**4.7.4 Test Data**

Mode	Channel	Test Frequency (MHz)	Conducted Power (dBm)	EIRP (dBm)	Conducted Power Limit (dBm)	EIRP Limit (dBm)	Result
Mode 1	00	2402	4.39	5.49	≤30	≤36	Pass
	19	2440	4.28	5.38	≤30	≤36	Pass
	39	2480	4.54	5.64	≤30	≤36	Pass
Mode 2	00	2402	4.42	5.52	≤30	≤36	Pass
	19	2440	4.35	5.45	≤30	≤36	Pass
	39	2480	4.49	5.59	≤30	≤36	Pass

<b>4.8 Power Density</b>	<b>VERDICT: PASS</b>
--------------------------	----------------------

<b>4.8.1 Limit:</b>	
<b>Standard</b>	FCC Part 15 Subpart C Paragraph 15.247 (b)(3)
Power Spectral Density $\leq 8\text{dBm}/3\text{kHz}$	

**4.8.2 Test Setup**

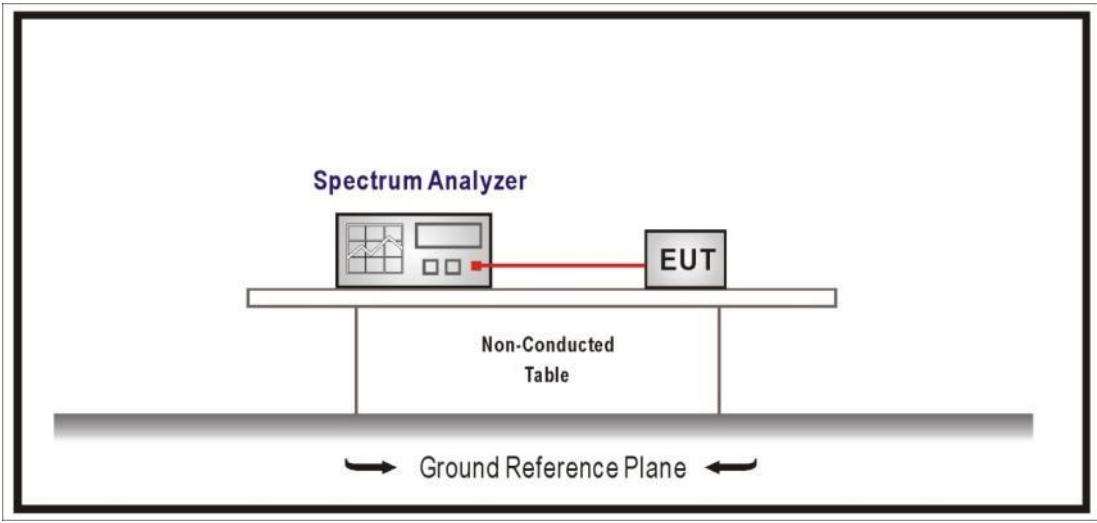

**4.8.3 Test Procedure**

	References Rule	Chapter	Description
<input checked="" type="checkbox"/>	ANSI C63.10	11.10	Maximum power spectral density level in the fundamental emission
<input checked="" type="checkbox"/>	ANSI C63.10	11.10.2	Method PKPSD (peak PSD)
<input type="checkbox"/>	ANSI C63.10	11.10.3	Method AVGPSD-1(Duty cycle $\geq 98\%$ )
<input type="checkbox"/>	ANSI C63.10	11.10.4	Method AVGPSD-1A(Duty cycle $\geq 98\%$ )
<input type="checkbox"/>	ANSI C63.10	11.10.5	Method AVGPSD-2(Duty cycle $< 98\%$ )
<input type="checkbox"/>	ANSI C63.10	11.10.6	Method AVGPSD-2A(Duty cycle $< 98\%$ )
<input type="checkbox"/>	ANSI C63.10	11.10.7	Method AVGPSD-3
<input type="checkbox"/>	ANSI C63.10	11.10.8	Method AVGPSD-3A



**4.8.4 Test Data**

Mode	Channel	Test Frequency (MHz)	Measurement PSD (dBm/3kHz)	Limit (dBm/3kHz)	Result
Mode 1	00	2402	-11.492	≤8	Pass
	19	2440	-11.793	≤8	Pass
	39	2480	-11.605	≤8	Pass
Mode 2	00	2402	-15.829	≤8	Pass
	19	2440	-16.270	≤8	Pass
	39	2480	-16.606	≤8	Pass

Note : The worst case of PSD as below:

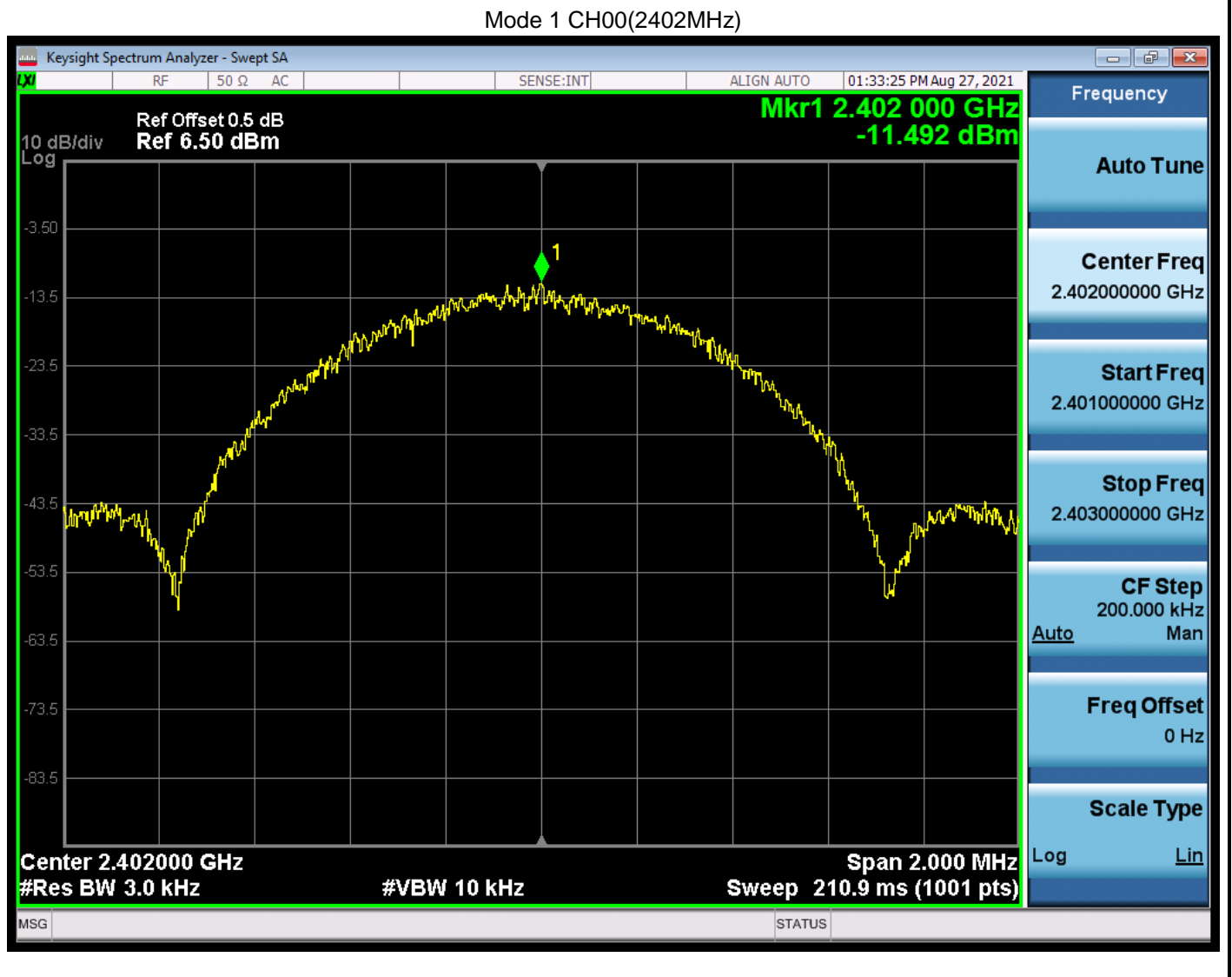

<b>4.9 Antenna Requirement</b>	<b>VERDICT: PASS</b>
--------------------------------	----------------------

<b>4.9.1 Limit:</b>	
<b>Standard</b>	FCC Part 15 Subpart C Paragraph 15.203
<p>An intentional radiator shall be designed to ensure that no antenna other than that furnished by the responsible party shall be used with the device. The use of a permanently attached antenna or of an antenna that uses a unique coupling to the intentional radiator shall be considered sufficient to comply with the provisions of this section. The manufacturer may design the unit so that a broken antenna can be replaced by the user, but the use of a standard antenna jack or electrical connector is prohibited. This requirement does not apply to carrier current devices or to devices operated under the provisions of §15.211, §15.213, §15.217, §15.219, or §15.221. Further, this requirement does not apply to intentional radiators that must be professionally installed, such as perimeter protection systems and some field disturbance sensors, or to other intentional radiators which, in accordance with §15.31(d), must be measured at the installation site. However, the installer shall be responsible for ensuring that the proper antenna is employed so that the limits in this part are not exceeded.</p>	

<b>4.9.2 Antenna Connector Construction:</b>	
<input checked="" type="checkbox"/>	The use of a permanently attached antenna
<input type="checkbox"/>	The antenna use of a unique coupling to the intentional radiator
<input type="checkbox"/>	The use of a nonstandard antenna jack or electrical connector
Please refer to the attached document "Internal Photograph" to show the antenna connector.	

---

## 5 TEST SETUP PHOTO AND EUT PHOTO

Remark: The test setup photo and EUT Photo please see appendix.

\_\_\_\_\_ The End \_\_\_\_\_