

TR-4-E-009 Radiated Emission Test Result

Test Site : DDT 3m Chamber 3# D:\E3 6.111\2022 Report Data\Q22062203-2E UCS15\FCC ABOVE 1G 5G.EM6
Test Date : 2022-08-23 **Tested By** : Bairong
EUT : Integrated video conference terminal **Model Number** : UC S15
Power Supply : AC 120V/60Hz **Test Mode** : Tx Mode
Condition : Temp:23.1°C,Humi:51.5%,Press:100.3kPa **Antenna/Distance** : 2021 BBHA 9120D 3#/3m/VERTICAL
Memo : 11A 5500

Data: 54

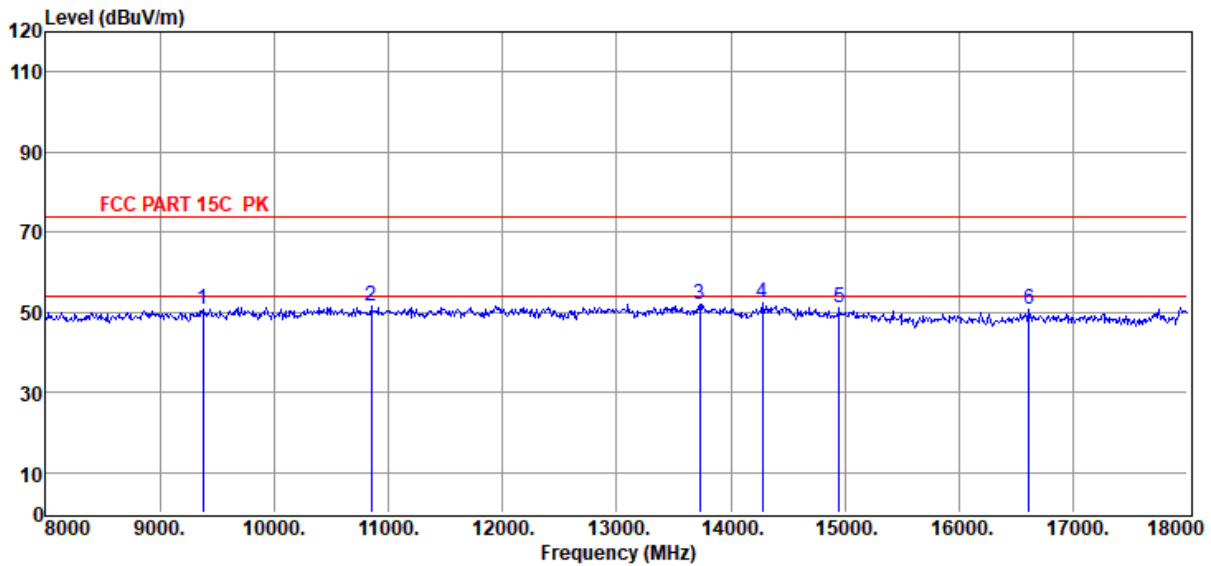

Item (Mark)	Freq. (MHz)	Read Level (dBuV)	Antenna Factor (dB/m)	PRM Factor dB	Cable Loss dB	Filter Factor dB	Result Level (dBuV/m)	Limit Line (dBuV/m)	Over Limit (dB)	Detector	Polarization
1	9380.00	45.83	38.60	40.17	3.55	2.89	50.70	74.00	-23.30	Peak	VERTICAL
2	10850.00	46.07	39.21	40.26	3.76	2.68	51.46	74.00	-22.54	Peak	VERTICAL
3	13730.00	45.08	39.95	39.89	4.24	2.68	52.06	74.00	-21.94	Peak	VERTICAL
4	14280.00	45.04	39.90	39.67	4.43	2.61	52.31	74.00	-21.69	Peak	VERTICAL
5	14950.00	44.19	39.54	39.60	4.46	2.41	51.00	74.00	-23.00	Peak	VERTICAL
6	16610.00	44.87	38.03	40.02	4.73	3.08	50.69	74.00	-23.31	Peak	VERTICAL

Note: 1. Result Level = Read Level + Antenna Factor + Cable loss + Filter Factor - PRM Factor.
 2. If Peak Result complies with AV limit, AV Result is deemed to comply with AV limit.
 3. Test setup: RBW: 1 MHz, VBW: 3 MHz, Sweep time: auto.

TR-4-E-009 Radiated Emission Test Result

Test Site : DDT 3m Chamber 3# D:\E3 6.111\2022 Report Data\Q22062203-2E UCS15\FCC ABOVE 1G 5G.EM6
Test Date : 2022-08-23 **Tested By** : Bairong
EUT : Integrated video conference terminal **Model Number** : UC S15
Power Supply : AC 120V/60Hz **Test Mode** : Tx Mode
Condition : Temp:23.1°C,Humi:51.5%,Press:100.3kPa **Antenna/Distance** : 2021 BBHA 9120D
3#/3m/HORIZONTAL
Memo : 11A 5580

Data: 55

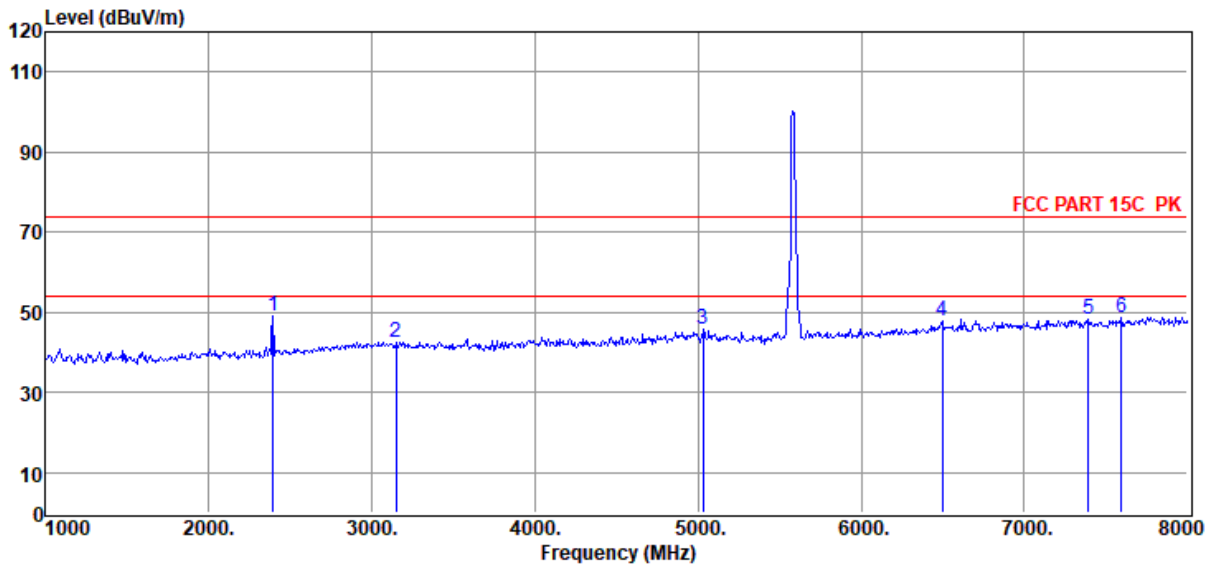

Item (Mark)	Freq. (MHz)	Read Level (dBuV)	Antenna Factor (dB/m)	PRM Factor dB	Cable Loss dB	Filter Factor dB	Result Level (dBuV/m)	Limit Line (dBuV/m)	Over Limit (dB)	Detector	Polarization
1	2393.00	58.72	27.41	39.60	1.71	0.72	48.96	74.00	-25.04	Peak	HORIZONTAL
2	3149.00	50.23	29.47	39.94	1.82	0.80	42.38	74.00	-31.62	Peak	HORIZONTAL
3	5032.00	49.47	33.08	40.40	2.54	0.92	45.61	74.00	-28.39	Peak	HORIZONTAL
4	6495.00	48.40	35.19	40.10	3.27	1.04	47.80	74.00	-26.20	Peak	HORIZONTAL
5	7391.00	47.46	36.31	39.74	3.11	1.03	48.17	74.00	-25.83	Peak	HORIZONTAL
6	7594.00	47.85	36.51	39.76	3.15	1.08	48.83	74.00	-25.17	Peak	HORIZONTAL

Note: 1. Result Level = Read Level + Antenna Factor + Cable loss + Filter Factor - PRM Factor.
 2. If Peak Result complies with AV limit, AV Result is deemed to comply with AV limit.
 3. Test setup: RBW: 1 MHz, VBW: 3 MHz, Sweep time: auto.

TR-4-E-009 Radiated Emission Test Result

Test Site : DDT 3m Chamber 3# D:\E3 6.111\2022 Report Data\Q22062203-2E UCS15\FCC ABOVE 1G 5G.EM6
Test Date : 2022-08-23 **Tested By** : Bairong
EUT : Integrated video conference terminal **Model Number** : UC S15
Power Supply : AC 120V/60Hz **Test Mode** : Tx Mode
Condition : Temp:23.1°C,Humi:51.5%,Press:100.3kPa **Antenna/Distance** : 2021 BBHA 9120D 3#/3m/VERTICAL
Memo : 11A 5580

Data: 56

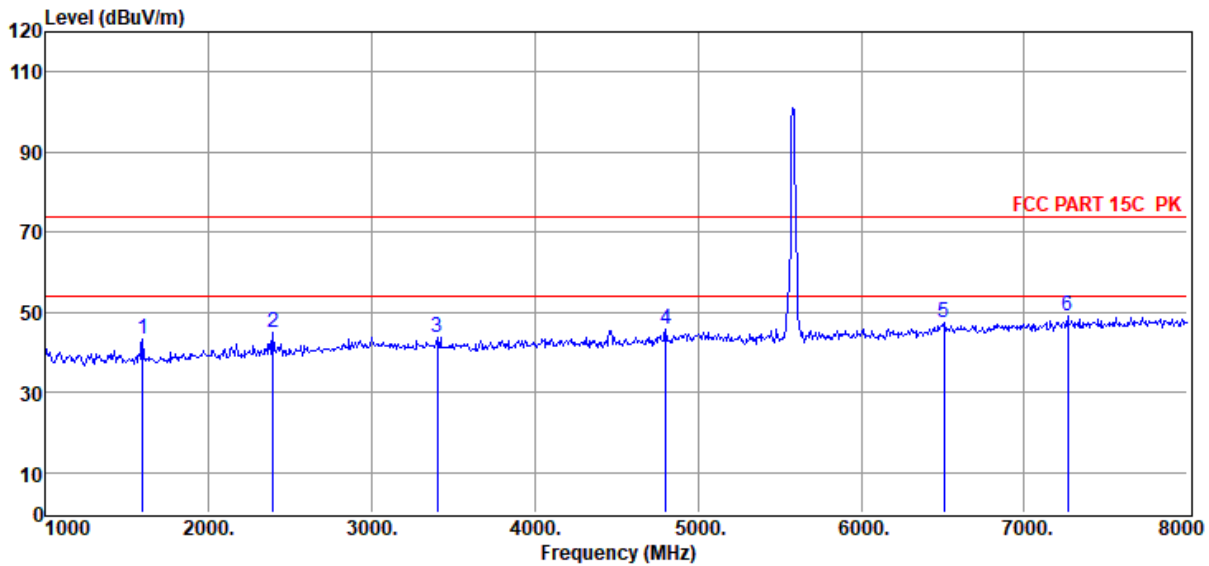

Item (Mark)	Freq. (MHz)	Read Level (dBuV)	Antenna Factor (dB/m)	PRM Factor dB	Cable Loss dB	Filter Factor dB	Result Level (dBuV/m)	Limit Line (dBuV/m)	Over Limit (dB)	Detector	Polarization
1	1595.00	54.55	25.65	38.79	1.42	0.61	43.44	74.00	-30.56	Peak	VERTICAL
2	2393.00	54.73	27.41	39.60	1.71	0.72	44.97	74.00	-29.03	Peak	VERTICAL
3	3401.00	51.84	29.42	40.02	1.73	0.82	43.79	74.00	-30.21	Peak	VERTICAL
4	4801.00	50.15	32.46	40.36	2.47	0.90	45.62	74.00	-28.38	Peak	VERTICAL
5	6509.00	47.84	35.21	40.09	3.27	1.03	47.26	74.00	-26.74	Peak	VERTICAL
6	7265.00	48.33	36.21	39.73	3.08	1.00	48.89	74.00	-25.11	Peak	VERTICAL

Note: 1. Result Level = Read Level + Antenna Factor + Cable loss + Filter Factor - PRM Factor.
 2. If Peak Result complies with AV limit, AV Result is deemed to comply with AV limit.
 3. Test setup: RBW: 1 MHz, VBW: 3 MHz, Sweep time: auto.

TR-4-E-009 Radiated Emission Test Result

Test Site : DDT 3m Chamber 3# D:\E3 6.111\2022 Report Data\Q22062203-2E UCS15\FCC ABOVE 1G 5G.EM6
Test Date : 2022-08-23 **Tested By** : Bairong
EUT : Integrated video conference terminal **Model Number** : UC S15
Power Supply : AC 120V/60Hz **Test Mode** : Tx Mode
Condition : Temp:23.1°C,Humi:51.5%,Press:100.3kPa **Antenna/Distance** : 2021 BBHA 9120D
3#/3m/HORIZONTAL
Memo : 11A 5580

Data: 57

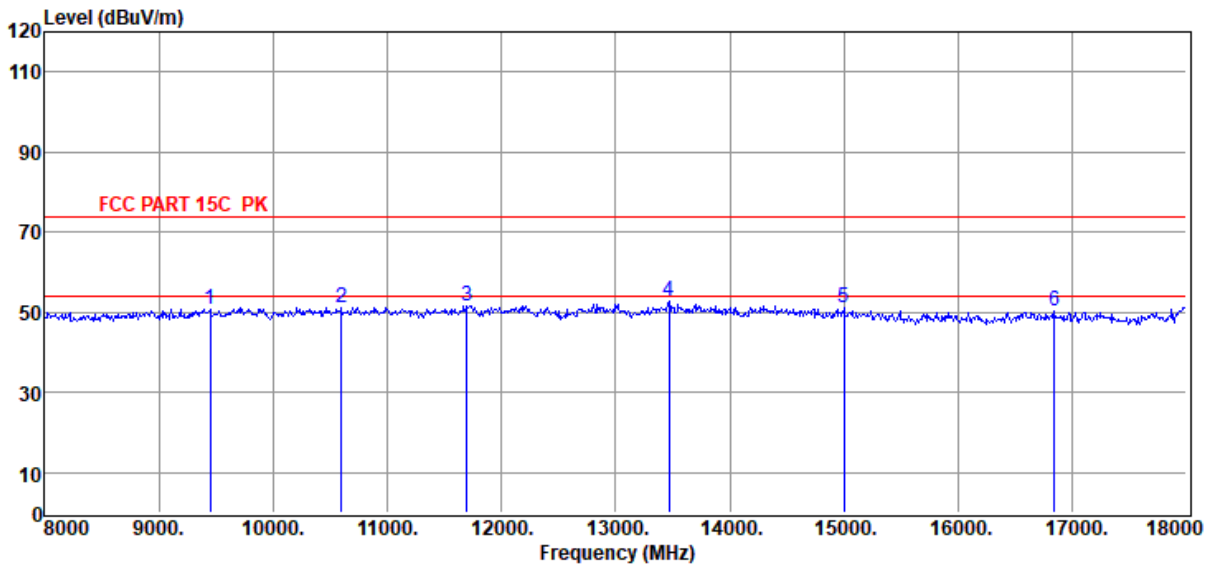

Item (Mark)	Freq. (MHz)	Read Level (dBuV)	Antenna Factor (dB/m)	PRM Factor dB	Cable Loss dB	Filter Factor dB	Result Level (dBuV/m)	Limit Line (dBuV/m)	Over Limit (dB)	Detector	Polarization
1	9450.00	45.85	38.66	40.22	3.59	2.91	50.79	74.00	-23.21	Peak	HORIZONTAL
2	10600.00	46.14	39.06	40.36	3.70	2.79	51.33	74.00	-22.67	Peak	HORIZONTAL
3	11700.00	46.12	39.08	40.13	4.00	2.44	51.51	74.00	-22.49	Peak	HORIZONTAL
4	13470.00	46.20	39.98	40.07	4.01	2.67	52.79	74.00	-21.21	Peak	HORIZONTAL
5	15000.00	44.27	39.50	39.60	4.47	2.39	51.03	74.00	-22.97	Peak	HORIZONTAL
6	16840.00	44.06	38.31	40.07	4.72	3.26	50.28	74.00	-23.72	Peak	HORIZONTAL

- Note: 1. Result Level = Read Level + Antenna Factor + Cable loss + Filter Factor - PRM Factor.
 2. If Peak Result complies with AV limit, AV Result is deemed to comply with AV limit.
 3. Test setup: RBW: 1 MHz, VBW: 3 MHz, Sweep time: auto.

TR-4-E-009 Radiated Emission Test Result

Test Site : DDT 3m Chamber 3# D:\E3 6.111\2022 Report Data\Q22062203-2E UCS15\FCC ABOVE 1G 5G.EM6
Test Date : 2022-08-23 **Tested By** : Bairong
EUT : Integrated video conference terminal **Model Number** : UC S15
Power Supply : AC 120V/60Hz **Test Mode** : Tx Mode
Condition : Temp:23.1°C,Humi:51.5%,Press:100.3kPa **Antenna/Distance** : 2021 BBHA 9120D 3#/3m/VERTICAL
Memo : 11A 5580

Data: 58

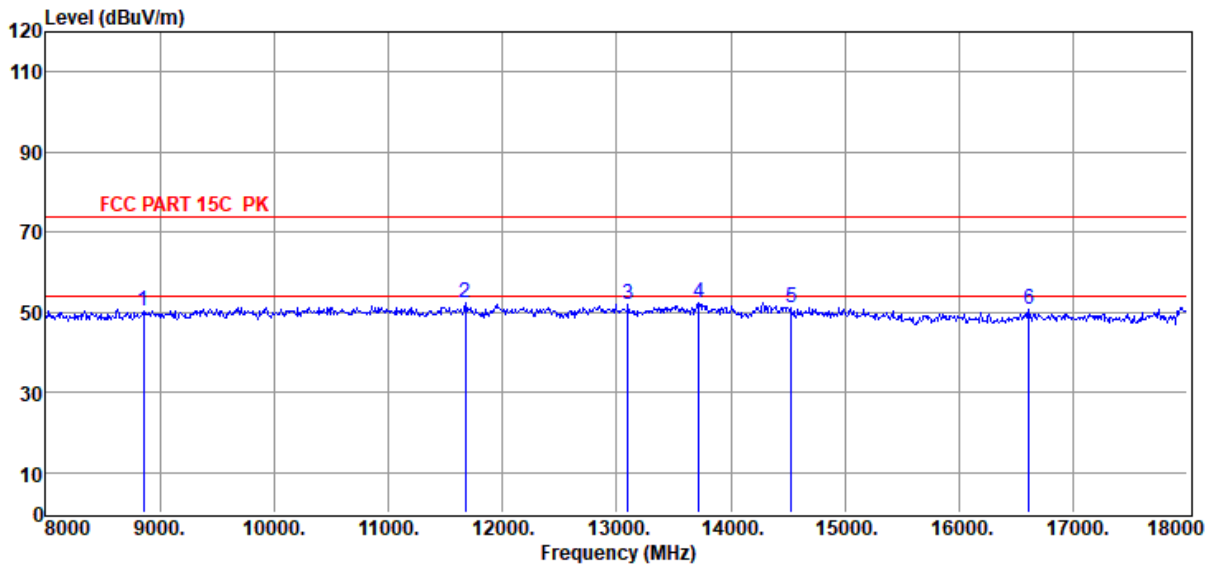

Item (Mark)	Freq. (MHz)	Read Level (dBuV)	Antenna Factor (dB/m)	PRM Factor dB	Cable Loss dB	Filter Factor dB	Result Level (dBuV/m)	Limit Line (dBuV/m)	Over Limit (dB)	Detector	Polarization
1	8860.00	46.01	38.16	39.89	3.30	2.79	50.37	74.00	-23.63	Peak	VERTICAL
2	11680.00	46.96	39.07	40.13	4.00	2.45	52.35	74.00	-21.65	Peak	VERTICAL
3	13100.00	45.72	39.68	40.33	4.32	2.65	52.04	74.00	-21.96	Peak	VERTICAL
4	13720.00	45.39	39.96	39.90	4.23	2.68	52.36	74.00	-21.64	Peak	VERTICAL
5	14530.00	44.11	39.88	39.65	4.36	2.53	51.23	74.00	-22.77	Peak	VERTICAL
6	16610.00	44.87	38.03	40.02	4.73	3.08	50.69	74.00	-23.31	Peak	VERTICAL

- Note: 1. Result Level = Read Level + Antenna Factor + Cable loss + Filter Factor - PRM Factor.
 2. If Peak Result complies with AV limit, AV Result is deemed to comply with AV limit.
 3. Test setup: RBW: 1 MHz, VBW: 3 MHz, Sweep time: auto.

TR-4-E-009 Radiated Emission Test Result

Test Site : DDT 3m Chamber 3# D:\E3 6.111\2022 Report Data\Q22062203-2E UCS15\FCC ABOVE 1G 5G.EM6
Test Date : 2022-08-24 **Tested By** : Bairong
EUT : Integrated video conference terminal **Model Number** : UC S15
Power Supply : AC 120V/60Hz **Test Mode** : Tx Mode
Condition : Temp:23.1°C,Humi:51.5%,Press:100.3kPa **Antenna/Distance** : 2021 BBHA 9120D
3#/3m/HORIZONTAL
Memo : 11A 5700

Data: 59

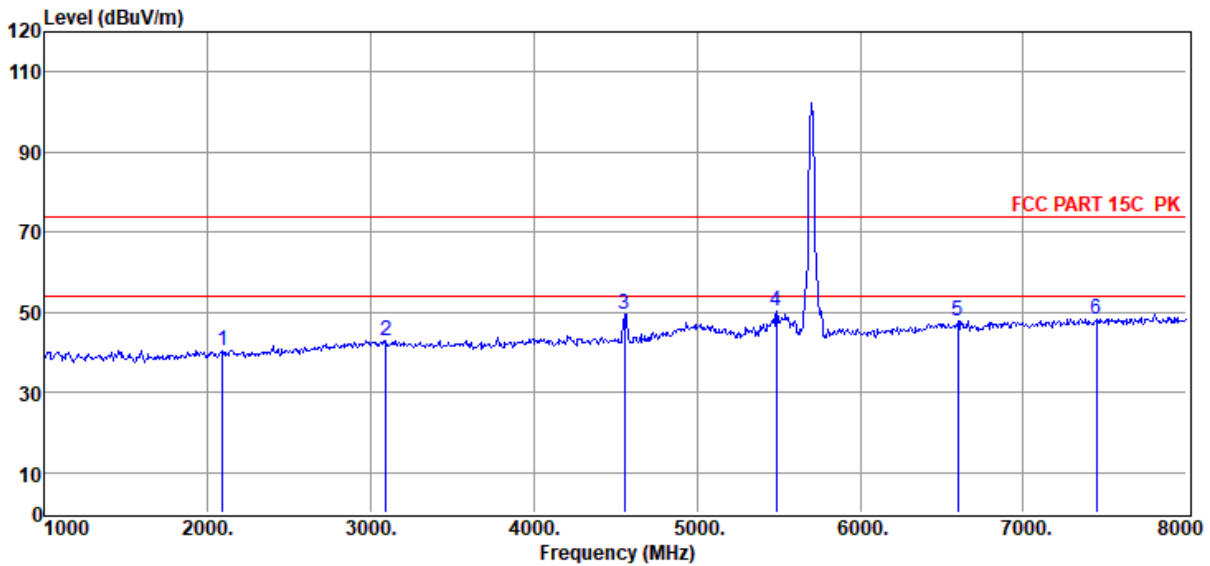

Item (Mark)	Freq. (MHz)	Read Level (dBuV)	Antenna Factor (dB/m)	PRM Factor dB	Cable Loss dB	Filter Factor dB	Result Level (dBuV/m)	Limit Line (dBuV/m)	Over Limit (dB)	Detector	Polarization
1	2092.00	50.82	26.87	39.45	1.63	0.69	40.56	74.00	-33.44	Peak	HORIZONTAL
2	3093.00	50.86	29.48	39.93	1.84	0.80	43.05	74.00	-30.95	Peak	HORIZONTAL
3	4556.00	54.99	31.68	40.31	2.38	0.89	49.63	74.00	-24.37	Peak	HORIZONTAL
4	5487.00	54.16	32.81	40.45	2.57	1.02	50.11	74.00	-23.89	Peak	HORIZONTAL
5	6600.00	48.38	35.36	40.02	3.22	1.01	47.95	74.00	-26.05	Peak	HORIZONTAL
6	7447.00	47.52	36.36	39.74	3.13	1.04	48.31	74.00	-25.69	Peak	HORIZONTAL

Note: 1. Result Level = Read Level + Antenna Factor + Cable loss + Filter Factor - PRM Factor.
 2. If Peak Result complies with AV limit, AV Result is deemed to comply with AV limit.
 3. Test setup: RBW: 1 MHz, VBW: 3 MHz, Sweep time: auto.

TR-4-E-009 Radiated Emission Test Result

Test Site : DDT 3m Chamber 3# D:\E3 6.111\2022 Report Data\Q22062203-2E UCS15\FCC ABOVE 1G 5G.EM6
Test Date : 2022-08-24 **Tested By** : Bairong
EUT : Integrated video conference terminal **Model Number** : UC S15
Power Supply : AC 120V/60Hz **Test Mode** : Tx Mode
Condition : Temp:23.1°C,Humi:51.5%,Press:100.3kPa **Antenna/Distance** : 2021 BBHA 9120D 3#/3m/VERTICAL
Memo : 11A 5700

Data: 60

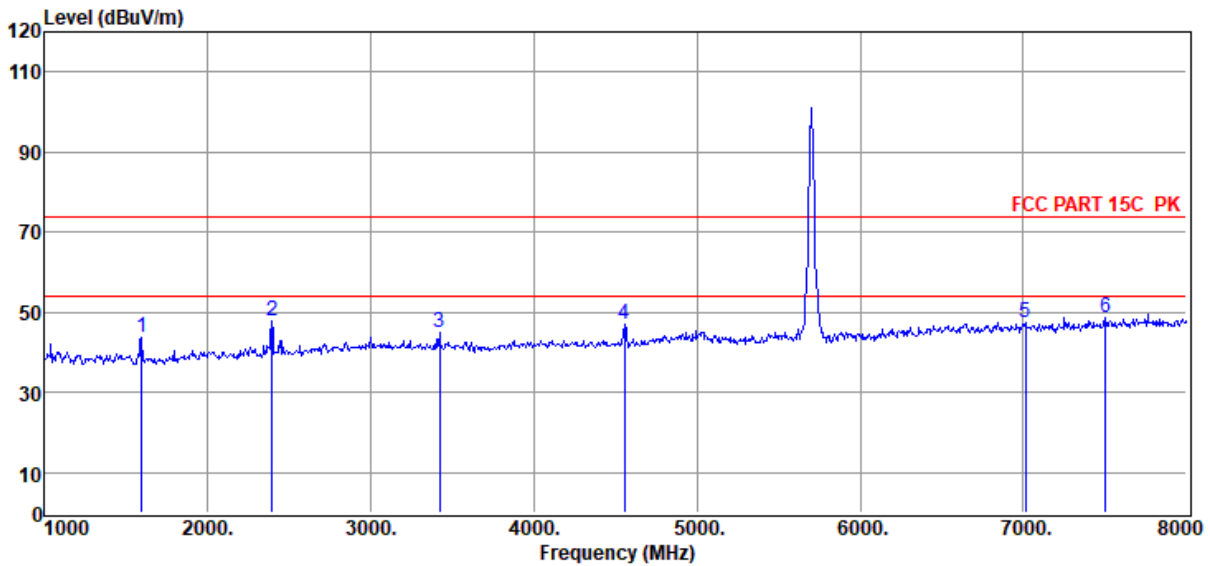

Item (Mark)	Freq. (MHz)	Read Level (dBuV)	Antenna Factor (dB/m)	PRM Factor dB	Cable Loss dB	Filter Factor dB	Result Level (dBuV/m)	Limit Line (dBuV/m)	Over Limit (dB)	Detector	Polarization
1	1595.00	54.93	25.65	38.79	1.42	0.61	43.82	74.00	-30.18	Peak	VERTICAL
2	2393.00	57.57	27.41	39.60	1.71	0.72	47.81	74.00	-26.19	Peak	VERTICAL
3	3422.00	52.87	29.42	40.03	1.72	0.82	44.80	74.00	-29.20	Peak	VERTICAL
4	4556.00	52.25	31.68	40.31	2.38	0.89	46.89	74.00	-27.11	Peak	VERTICAL
5	7013.00	47.30	36.01	39.70	3.02	0.93	47.56	74.00	-26.44	Peak	VERTICAL
6	7503.00	47.95	36.40	39.75	3.14	1.06	48.80	74.00	-25.20	Peak	VERTICAL

Note: 1. Result Level = Read Level + Antenna Factor + Cable loss + Filter Factor - PRM Factor.
 2. If Peak Result complies with AV limit, AV Result is deemed to comply with AV limit.
 3. Test setup: RBW: 1 MHz, VBW: 3 MHz, Sweep time: auto.

TR-4-E-009 Radiated Emission Test Result

Test Site : DDT 3m Chamber 3# D:\E3 6.111\2022 Report Data\Q22062203-2E UCS15\FCC ABOVE 1G 5G.EM6
Test Date : 2022-08-23 **Tested By** : Bairong
EUT : Integrated video conference terminal **Model Number** : UC S15
Power Supply : AC 120V/60Hz **Test Mode** : Tx Mode
Condition : Temp:23.1°C,Humi:51.5%,Press:100.3kPa **Antenna/Distance** : 2021 BBHA 9120D
3#/3m/HORIZONTAL
Memo : 11A 5700

Data: 61

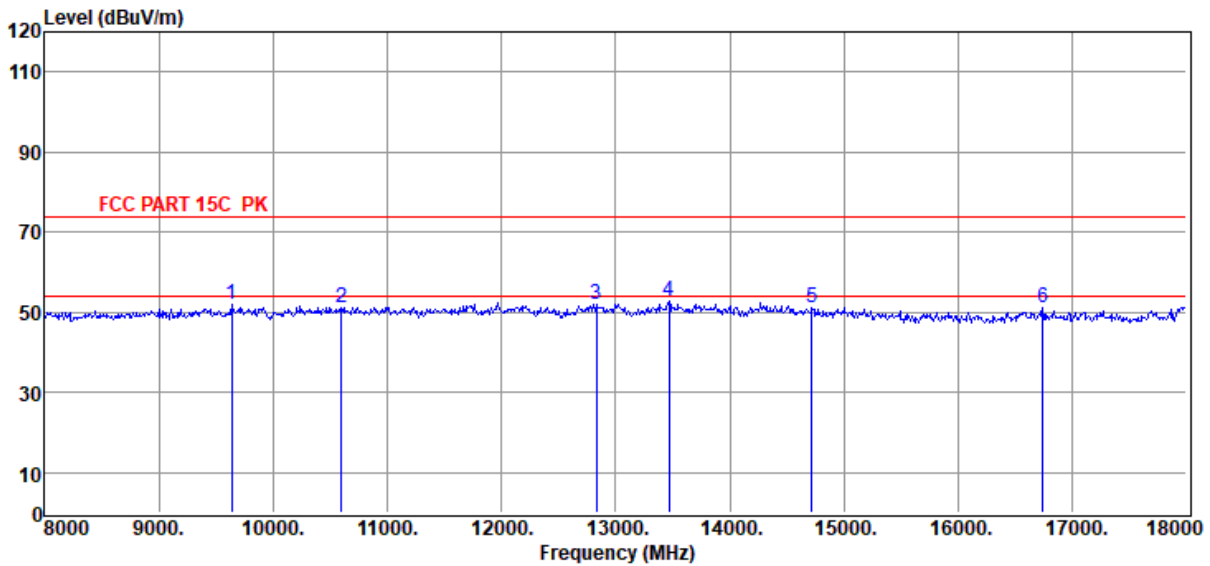

Item (Mark)	Freq. (MHz)	Read Level (dBuV)	Antenna Factor (dB/m)	PRM Factor dB	Cable Loss dB	Filter Factor dB	Result Level (dBuV/m)	Limit Line (dBuV/m)	Over Limit (dB)	Detector	Polarization
1	9640.00	47.25	38.62	40.35	3.63	2.95	52.10	74.00	-21.90	Peak	HORIZONTAL
2	10600.00	46.14	39.06	40.36	3.70	2.79	51.33	74.00	-22.67	Peak	HORIZONTAL
3	12830.00	46.31	39.40	40.35	4.17	2.60	52.13	74.00	-21.87	Peak	HORIZONTAL
4	13470.00	46.20	39.98	40.07	4.01	2.67	52.79	74.00	-21.21	Peak	HORIZONTAL
5	14720.00	44.24	39.72	39.63	4.40	2.47	51.20	74.00	-22.80	Peak	HORIZONTAL
6	16740.00	45.08	38.19	40.05	4.72	3.18	51.12	74.00	-22.88	Peak	HORIZONTAL

- Note: 1. Result Level = Read Level + Antenna Factor + Cable loss + Filter Factor - PRM Factor.
 2. If Peak Result complies with AV limit, AV Result is deemed to comply with AV limit.
 3. Test setup: RBW: 1 MHz, VBW: 3 MHz, Sweep time: auto.

TR-4-E-009 Radiated Emission Test Result

Test Site : DDT 3m Chamber 3# D:\E3 6.111\2022 Report Data\Q22062203-2E UCS15\FCC ABOVE 1G 5G.EM6
Test Date : 2022-08-23 **Tested By** : Bairong
EUT : Integrated video conference terminal **Model Number** : UC S15
Power Supply : AC 120V/60Hz **Test Mode** : Tx Mode
Condition : Temp:23.1°C,Humi:51.5%,Press:100.3kPa **Antenna/Distance** : 2021 BBHA 9120D 3#/3m/VERTICAL
Memo : 11A 5700

Data: 62

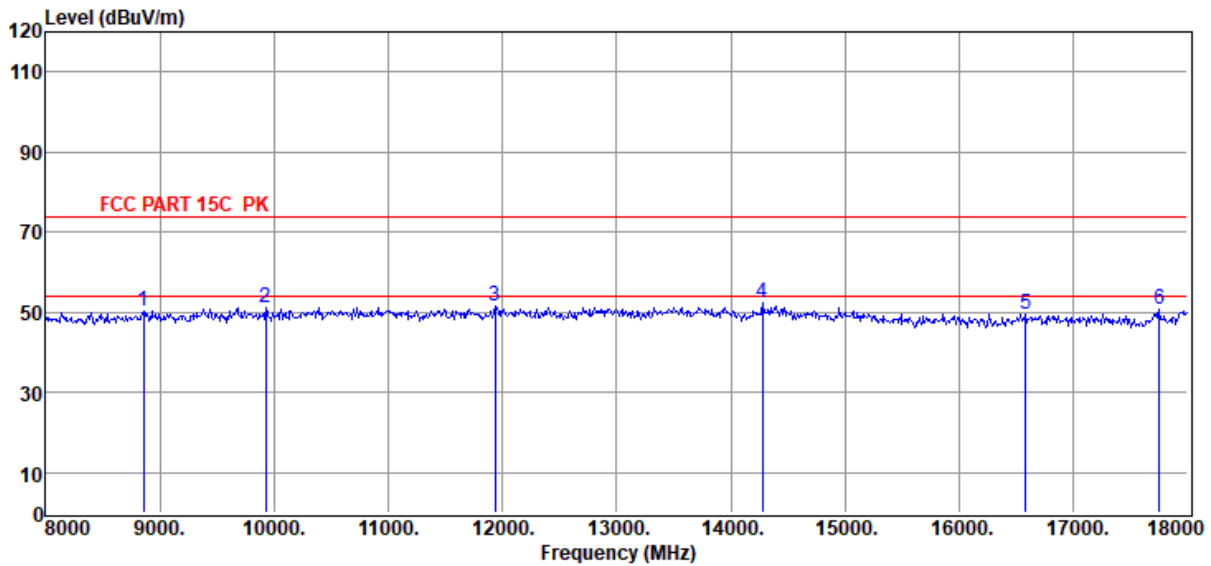

Item (Mark)	Freq. (MHz)	Read Level (dBuV)	Antenna Factor (dB/m)	PRM Factor dB	Cable Loss dB	Filter Factor dB	Result Level (dBuV/m)	Limit Line (dBuV/m)	Over Limit (dB)	Detector	Polarization
1	8860.00	46.01	38.16	39.89	3.30	2.79	50.37	74.00	-23.63	Peak	VERTICAL
2	9930.00	46.48	38.44	40.55	3.66	3.02	51.05	74.00	-22.95	Peak	VERTICAL
3	11940.00	46.03	39.18	40.11	4.04	2.38	51.52	74.00	-22.48	Peak	VERTICAL
4	14280.00	45.04	39.90	39.67	4.43	2.61	52.31	74.00	-21.69	Peak	VERTICAL
5	16580.00	43.76	38.00	40.02	4.73	3.06	49.53	74.00	-24.47	Peak	VERTICAL
6	17750.00	42.61	40.95	40.55	4.89	2.80	50.70	74.00	-23.30	Peak	VERTICAL

Note: 1. Result Level = Read Level + Antenna Factor + Cable loss + Filter Factor - PRM Factor.
 2. If Peak Result complies with AV limit, AV Result is deemed to comply with AV limit.
 3. Test setup: RBW: 1 MHz, VBW: 3 MHz, Sweep time: auto.

TR-4-E-009 Radiated Emission Test Result

Test Site : DDT 3m Chamber 3# D:\E3 6.111\2022 Report Data\Q22062203-2E UCS15\FCC ABOVE 1G 5G.EM6
Test Date : 2022-08-24 **Tested By** : Bairong
EUT : Integrated video conference terminal **Model Number** : UC S15
Power Supply : AC 120V/60Hz **Test Mode** : Tx Mode
Condition : Temp:23.1°C,Humi:51.5%,Press:100.3kPa **Antenna/Distance** : 2021 BBHA 9120D
3#/3m/HORIZONTAL
Memo : 11A 5745

Data: 63

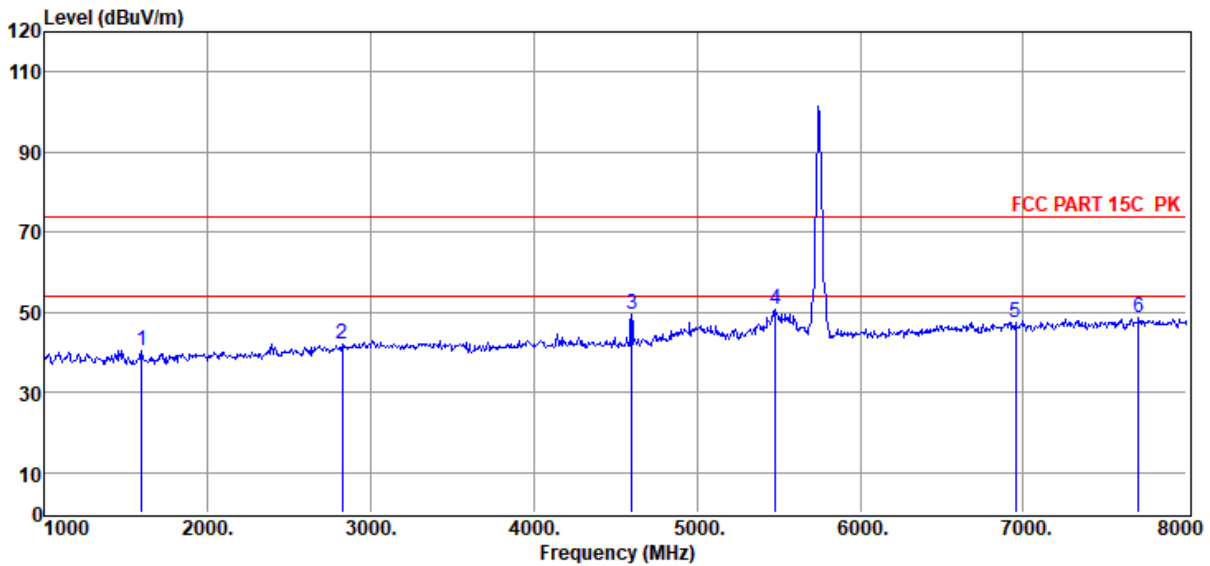

Item (Mark)	Freq. (MHz)	Read Level (dBuV)	Antenna Factor (dB/m)	PRM Factor dB	Cable Loss dB	Filter Factor dB	Result Level (dBuV/m)	Limit Line (dBuV/m)	Over Limit (dB)	Detector	Polarization
1	1595.00	51.71	25.65	38.79	1.42	0.61	40.60	74.00	-33.40	Peak	HORIZONTAL
2	2827.00	50.27	28.84	39.81	1.83	0.77	41.90	74.00	-32.10	Peak	HORIZONTAL
3	4598.00	54.73	31.81	40.32	2.40	0.89	49.51	74.00	-24.49	Peak	HORIZONTAL
4	5480.00	54.81	32.81	40.45	2.57	1.02	50.76	74.00	-23.24	Peak	HORIZONTAL
5	6950.00	47.37	35.92	39.74	3.05	0.94	47.54	74.00	-26.46	Peak	HORIZONTAL
6	7706.00	47.55	36.65	39.77	3.16	1.11	48.70	74.00	-25.30	Peak	HORIZONTAL

Note: 1. Result Level = Read Level + Antenna Factor + Cable loss + Filter Factor - PRM Factor.
 2. If Peak Result complies with AV limit, AV Result is deemed to comply with AV limit.
 3. Test setup: RBW: 1 MHz, VBW: 3 MHz, Sweep time: auto.

TR-4-E-009 Radiated Emission Test Result

Test Site : DDT 3m Chamber 3# D:\E3 6.111\2022 Report Data\Q22062203-2E UCS15\FCC ABOVE 1G 5G.EM6
Test Date : 2022-08-24 **Tested By** : Bairong
EUT : Integrated video conference terminal **Model Number** : UC S15
Power Supply : AC 120V/60Hz **Test Mode** : Tx Mode
Condition : Temp:23.1°C,Humi:51.5%,Press:100.3kPa **Antenna/Distance** : 2021 BBHA 9120D 3#/3m/VERTICAL
Memo : 11A 5745

Data: 64

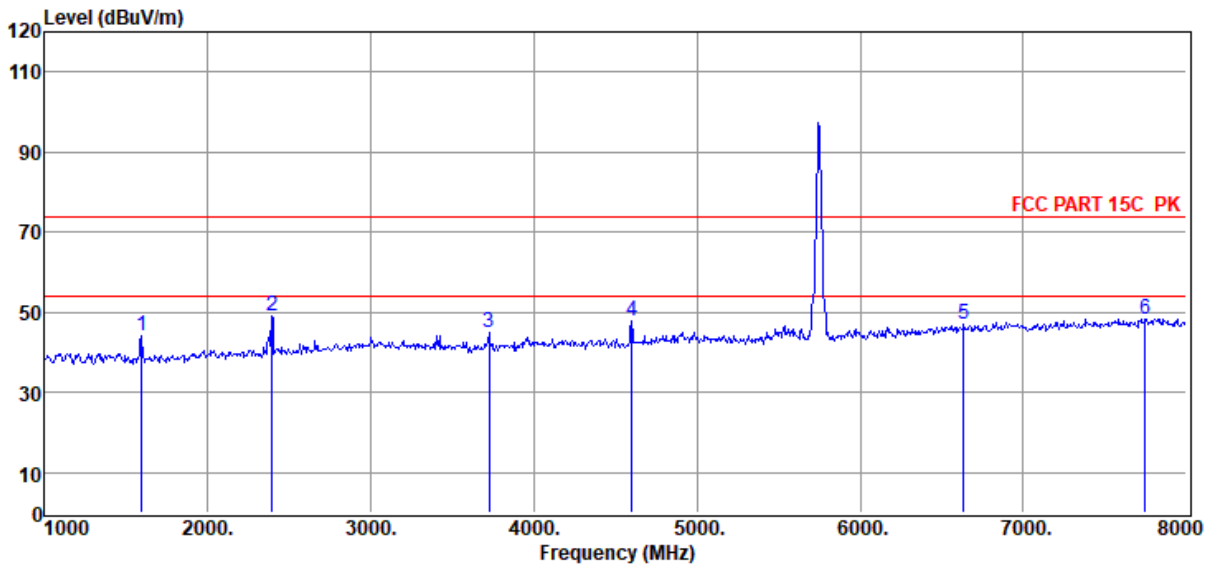

Item (Mark)	Freq. (MHz)	Read Level (dBuV)	Antenna Factor (dB/m)	PRM Factor dB	Cable Loss dB	Filter Factor dB	Result Level (dBuV/m)	Limit Line (dBuV/m)	Over Limit (dB)	Detector	Polarization
1	1595.00	55.17	25.65	38.79	1.42	0.61	44.06	74.00	-29.94	Peak	VERTICAL
2	2393.00	59.00	27.41	39.60	1.71	0.72	49.24	74.00	-24.76	Peak	VERTICAL
3	3723.00	52.35	30.16	40.12	1.88	0.84	45.11	74.00	-28.89	Peak	VERTICAL
4	4598.00	53.16	31.81	40.32	2.40	0.89	47.94	74.00	-26.06	Peak	VERTICAL
5	6635.00	47.40	35.42	39.99	3.20	1.01	47.04	74.00	-26.96	Peak	VERTICAL
6	7748.00	47.03	36.70	39.77	3.16	1.12	48.24	74.00	-25.76	Peak	VERTICAL

Note: 1. Result Level = Read Level + Antenna Factor + Cable loss + Filter Factor - PRM Factor.
 2. If Peak Result complies with AV limit, AV Result is deemed to comply with AV limit.
 3. Test setup: RBW: 1 MHz, VBW: 3 MHz, Sweep time: auto.

TR-4-E-009 Radiated Emission Test Result

Test Site : DDT 3m Chamber 3# D:\E3 6.111\2022 Report Data\Q22062203-2E UCS15\FCC ABOVE 1G 5G.EM6
Test Date : 2022-08-23 **Tested By** : Bairong
EUT : Integrated video conference terminal **Model Number** : UC S15
Power Supply : AC 120V/60Hz **Test Mode** : Tx Mode
Condition : Temp:23.1°C,Humi:51.5%,Press:100.3kPa **Antenna/Distance** : 2021 BBHA 9120D
3#/3m/HORIZONTAL
Memo : 11A 5745

Data: 65

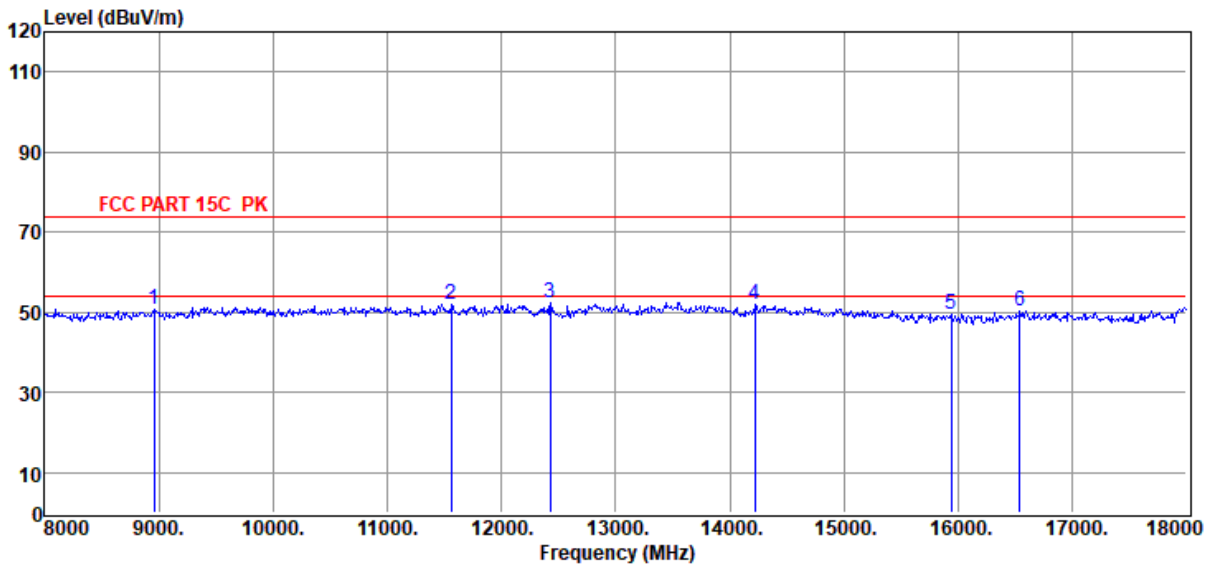

Item (Mark)	Freq. (MHz)	Read Level (dBuV)	Antenna Factor (dB/m)	PRM Factor dB	Cable Loss dB	Filter Factor dB	Result Level (dBuV/m)	Limit Line (dBuV/m)	Over Limit (dB)	Detector	Polarization
1	8960.00	46.31	38.26	39.90	3.32	2.80	50.79	74.00	-23.21	Peak	HORIZONTAL
2	11560.00	46.48	39.02	40.14	3.98	2.48	51.82	74.00	-22.18	Peak	HORIZONTAL
3	12430.00	47.14	39.03	40.23	3.76	2.49	52.19	74.00	-21.81	Peak	HORIZONTAL
4	14220.00	44.67	39.90	39.68	4.45	2.62	51.96	74.00	-22.04	Peak	HORIZONTAL
5	15940.00	44.30	38.01	39.88	4.60	2.59	49.62	74.00	-24.38	Peak	HORIZONTAL
6	16540.00	44.63	37.95	40.01	4.73	3.03	50.33	74.00	-23.67	Peak	HORIZONTAL

Note: 1. Result Level = Read Level + Antenna Factor + Cable loss + Filter Factor - PRM Factor.
 2. If Peak Result complies with AV limit, AV Result is deemed to comply with AV limit.
 3. Test setup: RBW: 1 MHz, VBW: 3 MHz, Sweep time: auto.

TR-4-E-009 Radiated Emission Test Result

Test Site : DDT 3m Chamber 3# D:\E3 6.111\2022 Report Data\Q22062203-2E UCS15\FCC ABOVE 1G 5G.EM6
Test Date : 2022-08-23 **Tested By** : Bairong
EUT : Integrated video conference terminal **Model Number** : UC S15
Power Supply : AC 120V/60Hz **Test Mode** : Tx Mode
Condition : Temp:23.1°C,Humi:51.5%,Press:100.3kPa **Antenna/Distance** : 2021 BBHA 9120D 3#/3m/VERTICAL
Memo : 11A 5745

Data: 66

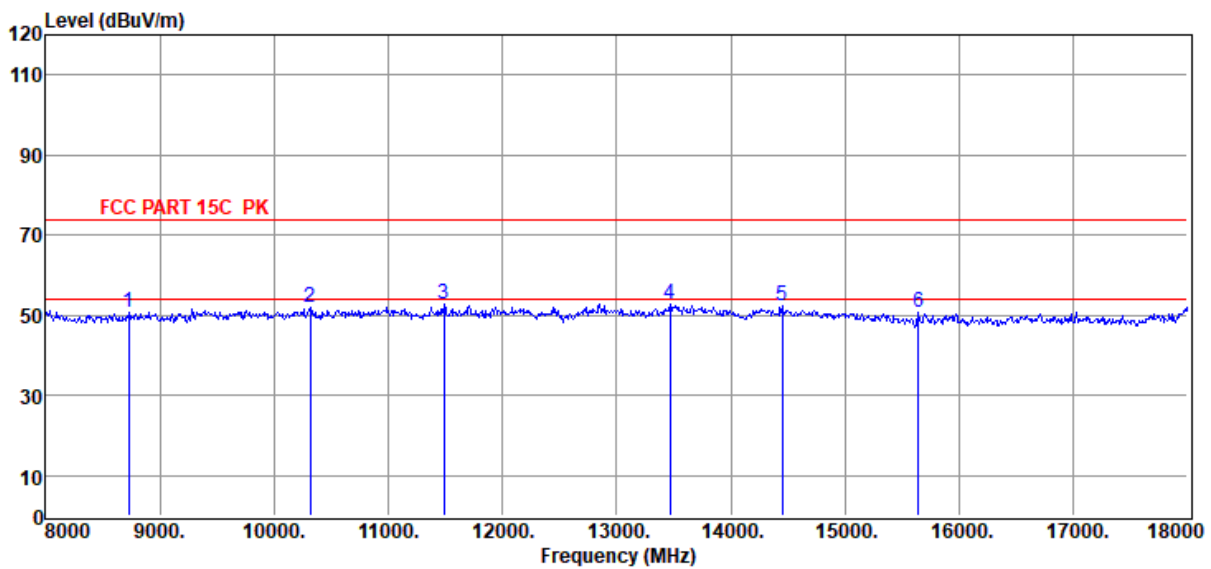

Item (Mark)	Freq. (MHz)	Read Level (dBuV)	Antenna Factor (dB/m)	PRM Factor dB	Cable Loss dB	Filter Factor dB	Result Level (dBuV/m)	Limit Line (dBuV/m)	Over Limit (dB)	Detector	Polarization
1	8730.00	46.46	38.03	39.87	3.27	2.78	50.67	74.00	-23.33	Peak	VERTICAL
2	10320.00	47.09	38.78	40.47	3.67	2.91	51.98	74.00	-22.02	Peak	VERTICAL
3	11490.00	47.64	39.01	40.15	3.97	2.50	52.97	74.00	-21.03	Peak	VERTICAL
4	13470.00	46.09	39.98	40.07	4.01	2.67	52.68	74.00	-21.32	Peak	VERTICAL
5	14450.00	45.04	39.90	39.65	4.37	2.56	52.22	74.00	-21.78	Peak	VERTICAL
6	15640.00	44.77	38.55	39.79	4.57	2.52	50.62	74.00	-23.38	Peak	VERTICAL

- Note: 1. Result Level = Read Level + Antenna Factor + Cable loss + Filter Factor - PRM Factor.
 2. If Peak Result complies with AV limit, AV Result is deemed to comply with AV limit.
 3. Test setup: RBW: 1 MHz, VBW: 3 MHz, Sweep time: auto.

TR-4-E-009 Radiated Emission Test Result

Test Site : DDT 3m Chamber 3# D:\E3 6.111\2022 Report Data\Q22062203-2E UCS15\FCC ABOVE 1G 5G.EM6
Test Date : 2022-08-24 **Tested By** : Bairong
EUT : Integrated video conference terminal **Model Number** : UC S15
Power Supply : AC 120V/60Hz **Test Mode** : Tx Mode
Condition : Temp:23.1°C,Humi:51.5%,Press:100.3kPa **Antenna/Distance** : 2021 BBHA 9120D
3#/3m/HORIZONTAL
Memo : 11A 5785

Data: 67

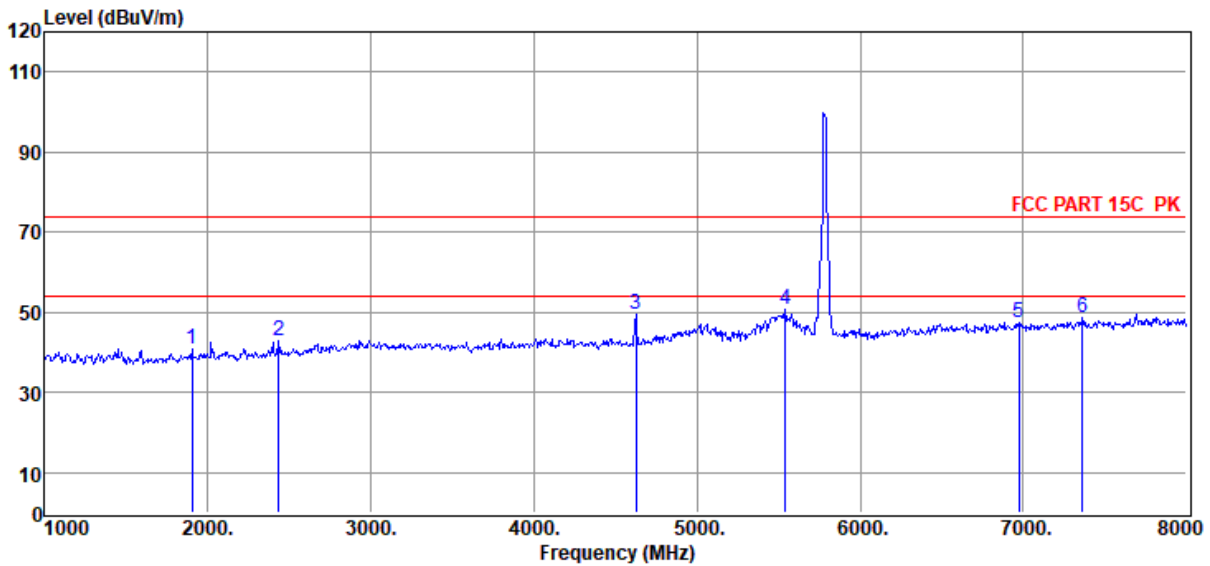

Item (Mark)	Freq. (MHz)	Read Level (dBuV)	Antenna Factor (dB/m)	PRM Factor dB	Cable Loss dB	Filter Factor dB	Result Level (dBuV/m)	Limit Line (dBuV/m)	Over Limit (dB)	Detector	Polarization
1	1903.00	51.34	26.45	39.25	1.56	0.66	40.76	74.00	-33.24	Peak	HORIZONTAL
2	2435.00	52.49	27.48	39.62	1.72	0.73	42.80	74.00	-31.20	Peak	HORIZONTAL
3	4626.00	54.42	31.90	40.33	2.41	0.89	49.29	74.00	-24.71	Peak	HORIZONTAL
4	5543.00	54.61	32.90	40.45	2.61	1.03	50.70	74.00	-23.30	Peak	HORIZONTAL
5	6971.00	47.25	35.95	39.72	3.03	0.94	47.45	74.00	-26.55	Peak	HORIZONTAL
6	7363.00	48.10	36.29	39.74	3.11	1.02	48.78	74.00	-25.22	Peak	HORIZONTAL

Note: 1. Result Level = Read Level + Antenna Factor + Cable loss + Filter Factor - PRM Factor.
 2. If Peak Result complies with AV limit, AV Result is deemed to comply with AV limit.
 3. Test setup: RBW: 1 MHz, VBW: 3 MHz, Sweep time: auto.

TR-4-E-009 Radiated Emission Test Result

Test Site : DDT 3m Chamber 3# D:\E3 6.111\2022 Report Data\Q22062203-2E UCS15\FCC ABOVE 1G 5G.EM6
Test Date : 2022-08-24 **Tested By** : Bairong
EUT : Integrated video conference terminal **Model Number** : UC S15
Power Supply : AC 120V/60Hz **Test Mode** : Tx Mode
Condition : Temp:23.1°C,Humi:51.5%,Press:100.3kPa **Antenna/Distance** : 2021 BBHA 9120D 3#/3m/VERTICAL
Memo : 11A 5785

Data: 68

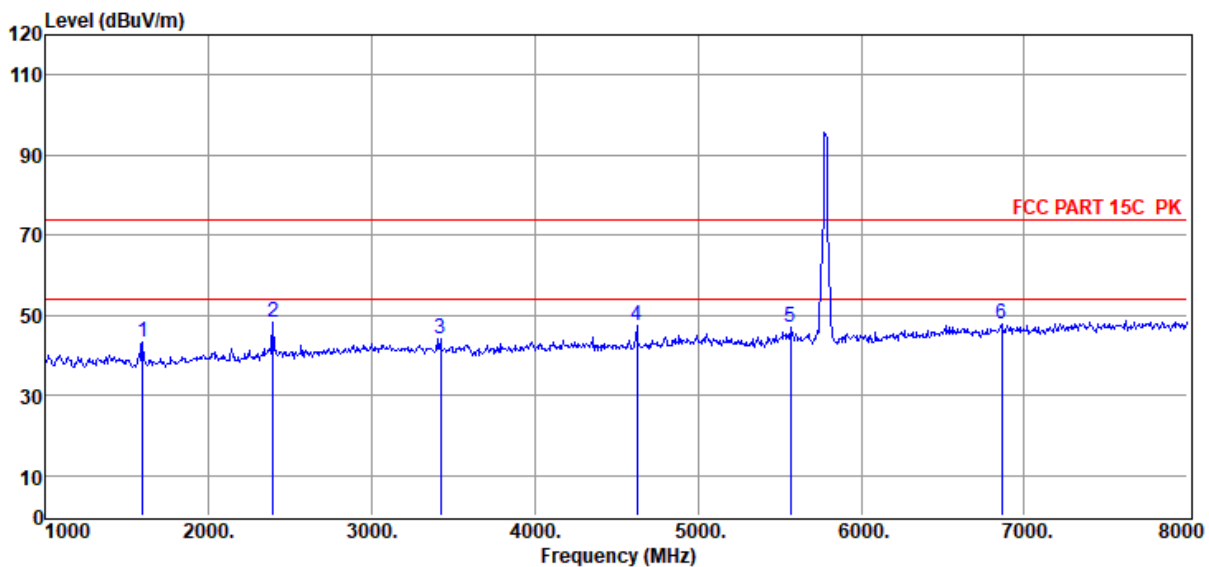

Item (Mark)	Freq. (MHz)	Read Level (dBuV)	Antenna Factor (dB/m)	PRM Factor dB	Cable Loss dB	Filter Factor dB	Result Level (dBuV/m)	Limit Line (dBuV/m)	Over Limit (dB)	Detector	Polarization
1	1595.00	54.58	25.65	38.79	1.42	0.61	43.47	74.00	-30.53	Peak	VERTICAL
2	2393.00	58.00	27.41	39.60	1.71	0.72	48.24	74.00	-25.76	Peak	VERTICAL
3	3422.00	52.37	29.42	40.03	1.72	0.82	44.30	74.00	-29.70	Peak	VERTICAL
4	4626.00	52.37	31.90	40.33	2.41	0.89	47.24	74.00	-26.76	Peak	VERTICAL
5	5564.00	50.64	32.95	40.46	2.63	1.04	46.80	74.00	-27.20	Peak	VERTICAL
6	6859.00	47.89	35.77	39.81	3.09	0.96	47.90	74.00	-26.10	Peak	VERTICAL

Note: 1. Result Level = Read Level + Antenna Factor + Cable loss + Filter Factor - PRM Factor.
 2. If Peak Result complies with AV limit, AV Result is deemed to comply with AV limit.
 3. Test setup: RBW: 1 MHz, VBW: 3 MHz, Sweep time: auto.

TR-4-E-009 Radiated Emission Test Result

Test Site : DDT 3m Chamber 3# D:\E3 6.111\2022 Report Data\Q22062203-2E UCS15\FCC ABOVE 1G 5G.EM6
Test Date : 2022-08-23 **Tested By** : Bairong
EUT : Integrated video conference terminal **Model Number** : UC S15
Power Supply : AC 120V/60Hz **Test Mode** : Tx Mode
Condition : Temp:23.1°C,Humi:51.5%,Press:100.3kPa **Antenna/Distance** : 2021 BBHA 9120D
3#/3m/HORIZONTAL
Memo : 11A 5785

Data: 69

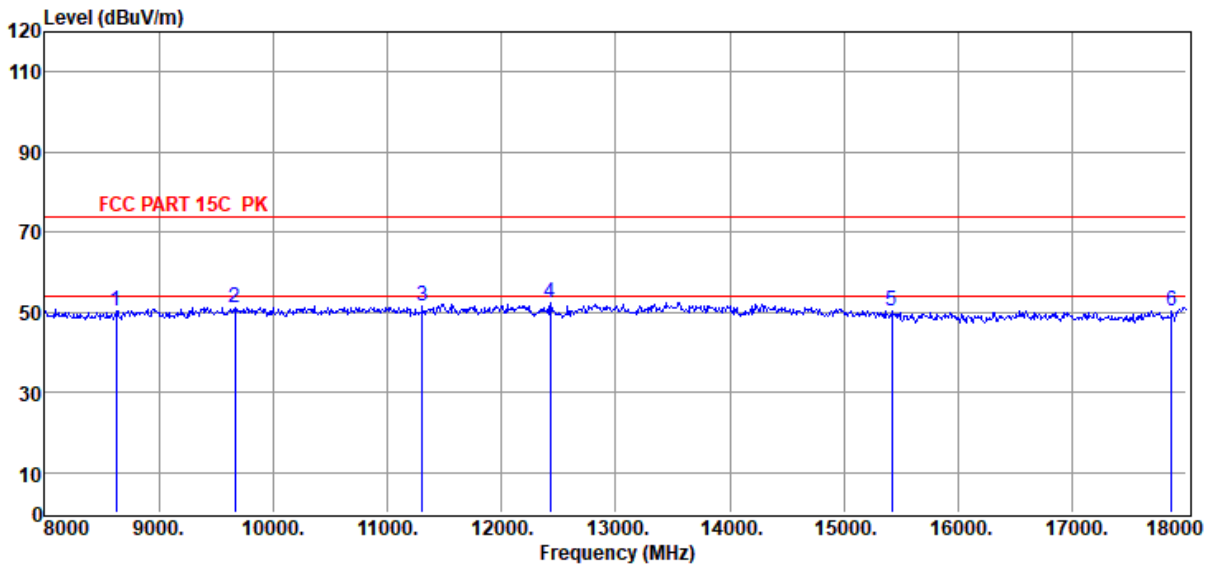

Item (Mark)	Freq. (MHz)	Read Level (dBuV)	Antenna Factor (dB/m)	PRM Factor dB	Cable Loss dB	Filter Factor dB	Result Level (dBuV/m)	Limit Line (dBuV/m)	Over Limit (dB)	Detector	Polarization
1	8630.00	46.31	37.93	39.86	3.25	2.77	50.40	74.00	-23.60	Peak	HORIZONTAL
2	9670.00	46.48	38.60	40.37	3.64	2.96	51.31	74.00	-22.69	Peak	HORIZONTAL
3	11310.00	45.99	39.11	40.17	3.91	2.54	51.38	74.00	-22.62	Peak	HORIZONTAL
4	12430.00	47.14	39.03	40.23	3.76	2.49	52.19	74.00	-21.81	Peak	HORIZONTAL
5	15420.00	44.08	38.91	39.73	4.55	2.48	50.29	74.00	-23.71	Peak	HORIZONTAL
6	17870.00	41.70	41.69	40.62	4.92	2.71	50.40	74.00	-23.60	Peak	HORIZONTAL

- Note: 1. Result Level = Read Level + Antenna Factor + Cable loss + Filter Factor - PRM Factor.
 2. If Peak Result complies with AV limit, AV Result is deemed to comply with AV limit.
 3. Test setup: RBW: 1 MHz, VBW: 3 MHz, Sweep time: auto.

TR-4-E-009 Radiated Emission Test Result

Test Site : DDT 3m Chamber 3# D:\E3 6.111\2022 Report Data\Q22062203-2E UCS15\FCC ABOVE 1G 5G.EM6
Test Date : 2022-08-23 **Tested By** : Bairong
EUT : Integrated video conference terminal **Model Number** : UC S15
Power Supply : AC 120V/60Hz **Test Mode** : Tx Mode
Condition : Temp:23.1°C,Humi:51.5%,Press:100.3kPa **Antenna/Distance** : 2021 BBHA 9120D 3#/3m/VERTICAL
Memo : 11A 5785

Data: 70

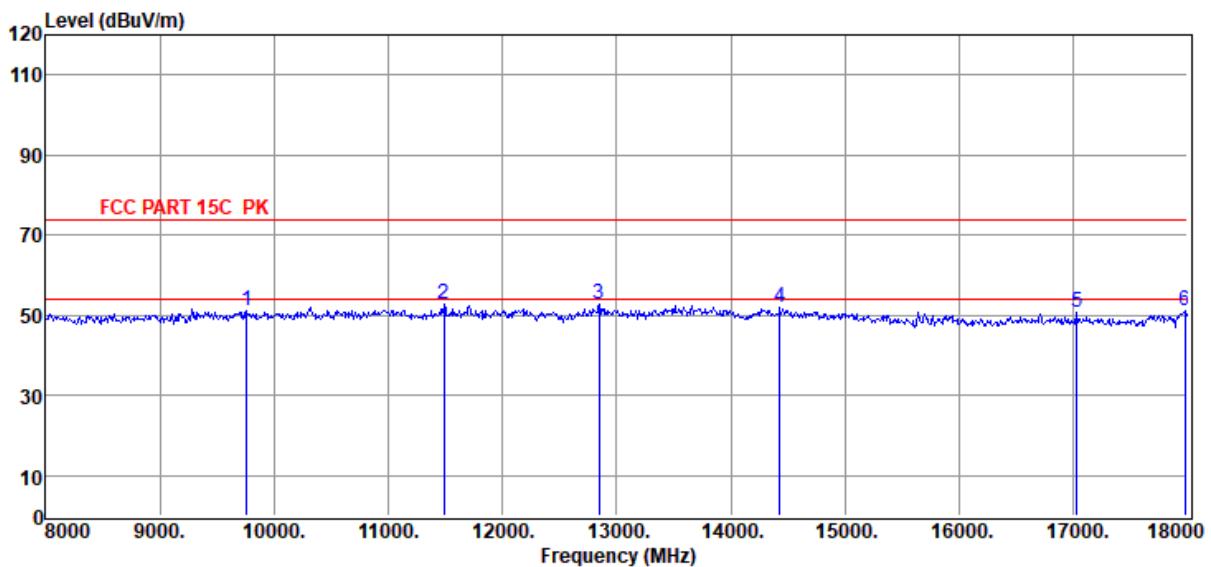

Item (Mark)	Freq. (MHz)	Read Level (dBuV)	Antenna Factor (dB/m)	PRM Factor dB	Cable Loss dB	Filter Factor dB	Result Level (dBuV/m)	Limit Line (dBuV/m)	Over Limit (dB)	Detector	Polarization
1	9760.00	46.36	38.54	40.43	3.65	2.98	51.10	74.00	-22.90	Peak	VERTICAL
2	11490.00	47.64	39.01	40.15	3.97	2.50	52.97	74.00	-21.03	Peak	VERTICAL
3	12850.00	46.94	39.42	40.35	4.19	2.61	52.81	74.00	-21.19	Peak	VERTICAL
4	14430.00	44.89	39.90	39.66	4.38	2.56	52.07	74.00	-21.93	Peak	VERTICAL
5	17030.00	44.00	38.55	40.12	4.72	3.37	50.52	74.00	-23.48	Peak	VERTICAL
6	17980.00	41.82	42.38	40.69	4.95	2.63	51.09	74.00	-22.91	Peak	VERTICAL

Note: 1. Result Level = Read Level + Antenna Factor + Cable loss + Filter Factor - PRM Factor.
 2. If Peak Result complies with AV limit, AV Result is deemed to comply with AV limit.
 3. Test setup: RBW: 1 MHz, VBW: 3 MHz, Sweep time: auto.

TR-4-E-009 Radiated Emission Test Result

Test Site : DDT 3m Chamber 3# D:\E3 6.111\2022 Report Data\Q22062203-2E UCS15\FCC ABOVE 1G 5G.EM6
Test Date : 2022-08-24 **Tested By** : Bairong
EUT : Integrated video conference terminal **Model Number** : UC S15
Power Supply : AC 120V/60Hz **Test Mode** : Tx Mode
Condition : Temp:23.1°C,Humi:51.5%,Press:100.3kPa **Antenna/Distance** : 2021 BBHA 9120D
3#/3m/HORIZONTAL
Memo : 11A 5825

Data: 71

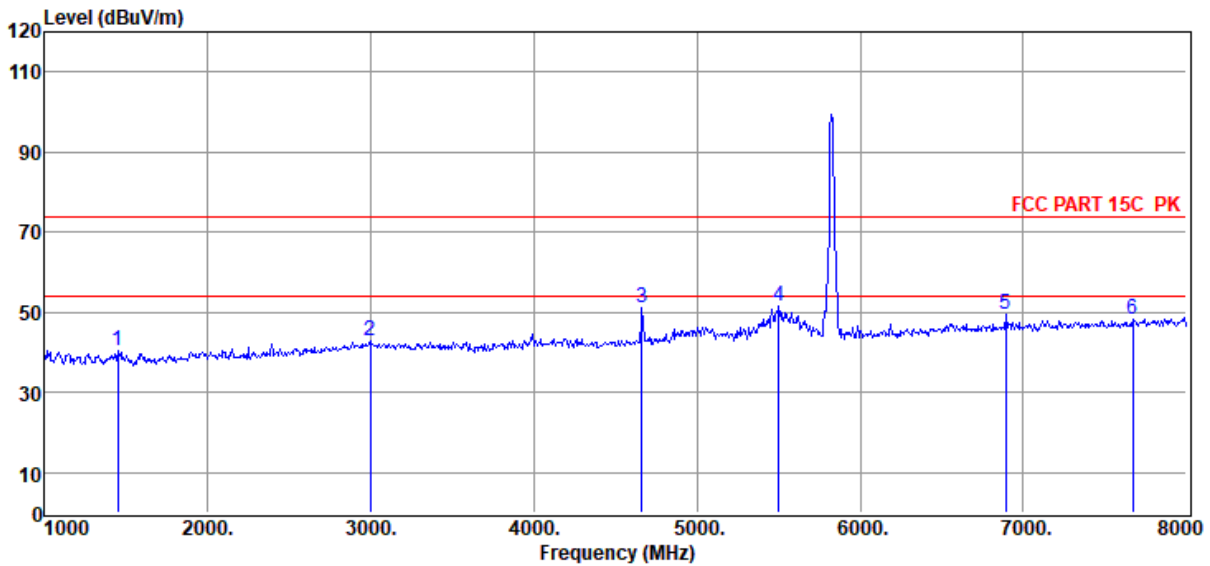

Item (Mark)	Freq. (MHz)	Read Level (dBuV)	Antenna Factor (dB/m)	PRM Factor dB	Cable Loss dB	Filter Factor dB	Result Level (dBuV/m)	Limit Line (dBuV/m)	Over Limit (dB)	Detector	Polarization
1	1448.00	51.44	25.41	38.57	1.35	0.58	40.21	74.00	-33.79	Peak	HORIZONTAL
2	2995.00	50.46	29.48	39.90	1.87	0.79	42.70	74.00	-31.30	Peak	HORIZONTAL
3	4661.00	56.09	32.02	40.33	2.42	0.89	51.09	74.00	-22.91	Peak	HORIZONTAL
4	5501.00	55.51	32.80	40.45	2.57	1.03	51.46	74.00	-22.54	Peak	HORIZONTAL
5	6894.00	49.23	35.83	39.78	3.07	0.95	49.30	74.00	-24.70	Peak	HORIZONTAL
6	7671.00	46.98	36.61	39.77	3.16	1.10	48.08	74.00	-25.92	Peak	HORIZONTAL

Note: 1. Result Level = Read Level + Antenna Factor + Cable loss + Filter Factor - PRM Factor.
 2. If Peak Result complies with AV limit, AV Result is deemed to comply with AV limit.
 3. Test setup: RBW: 1 MHz, VBW: 3 MHz, Sweep time: auto.

TR-4-E-009 Radiated Emission Test Result

Test Site : DDT 3m Chamber 3# D:\E3 6.111\2022 Report Data\Q22062203-2E UCS15\FCC ABOVE 1G 5G.EM6
Test Date : 2022-08-24 **Tested By** : Bairong
EUT : Integrated video conference terminal **Model Number** : UC S15
Power Supply : AC 120V/60Hz **Test Mode** : Tx Mode
Condition : Temp:23.1°C,Humi:51.5%,Press:100.3kPa **Antenna/Distance** : 2021 BBHA 9120D 3#/3m/VERTICAL
Memo : 11A 5825

Data: 72

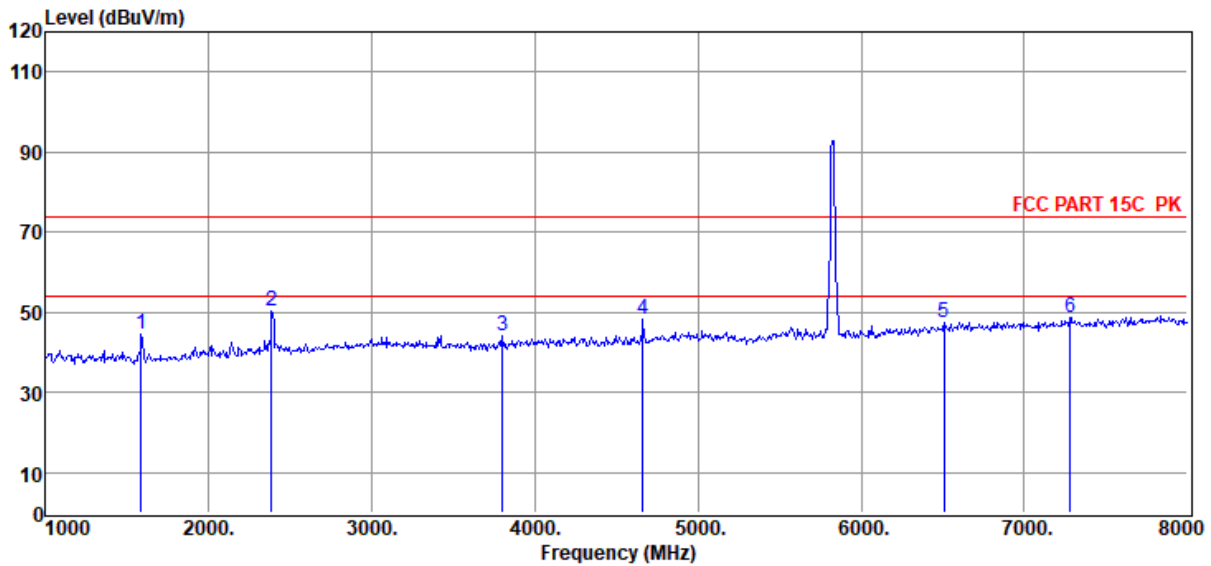

Item (Mark)	Freq. (MHz)	Read Level (dBuV)	Antenna Factor (dB/m)	PRM Factor dB	Cable Loss dB	Filter Factor dB	Result Level (dBuV/m)	Limit Line (dBuV/m)	Over Limit (dB)	Detector	Polarization
1	1588.00	55.47	25.63	38.78	1.42	0.61	44.35	74.00	-29.65	Peak	VERTICAL
2	2386.00	59.91	27.39	39.59	1.71	0.72	50.14	74.00	-23.86	Peak	VERTICAL
3	3800.00	51.16	30.42	40.14	1.94	0.85	44.23	74.00	-29.77	Peak	VERTICAL
4	4661.00	53.05	32.02	40.33	2.42	0.89	48.05	74.00	-25.95	Peak	VERTICAL
5	6509.00	47.87	35.21	40.09	3.27	1.03	47.29	74.00	-26.71	Peak	VERTICAL
6	7279.00	48.12	36.22	39.73	3.09	1.00	48.70	74.00	-25.30	Peak	VERTICAL

Note: 1. Result Level = Read Level + Antenna Factor + Cable loss + Filter Factor - PRM Factor.
 2. If Peak Result complies with AV limit, AV Result is deemed to comply with AV limit.
 3. Test setup: RBW: 1 MHz, VBW: 3 MHz, Sweep time: auto.

TR-4-E-009 Radiated Emission Test Result

Test Site : DDT 3m Chamber 3# D:\E3 6.111\2022 Report Data\Q22062203-2E UCS15\FCC ABOVE 1G 5G.EM6
Test Date : 2022-08-23 **Tested By** : Bairong
EUT : Integrated video conference terminal **Model Number** : UC S15
Power Supply : AC 120V/60Hz **Test Mode** : Tx Mode
Condition : Temp:23.1°C,Humi:51.5%,Press:100.3kPa **Antenna/Distance** : 2021 BBHA 9120D
3#/3m/HORIZONTAL
Memo : 11A 5825

Data: 73

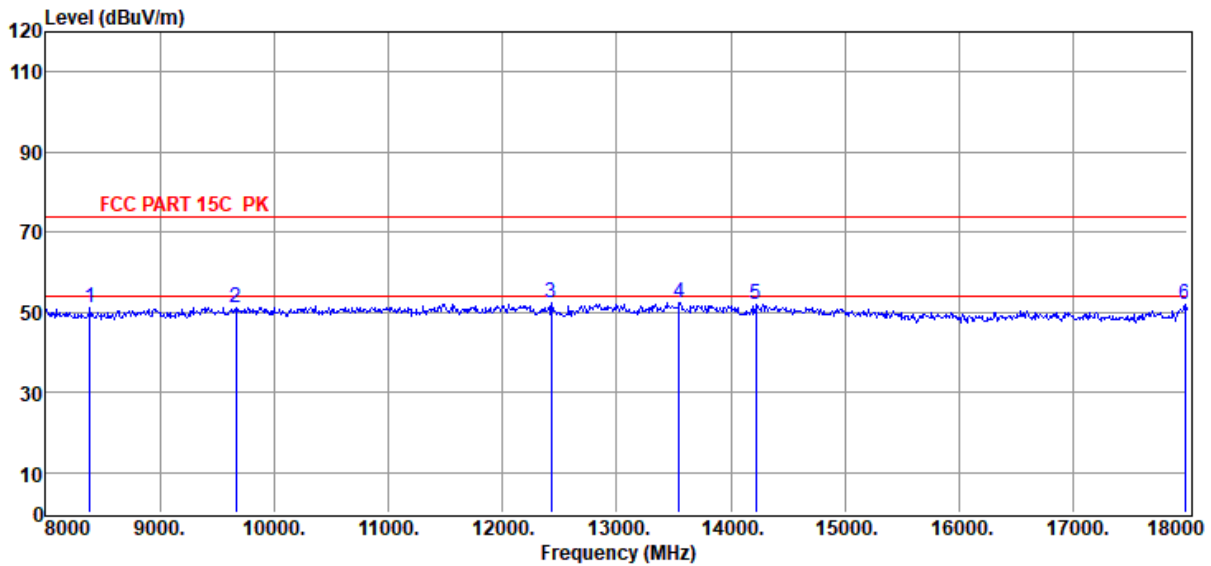

Item (Mark)	Freq. (MHz)	Read Level (dBuV)	Antenna Factor (dB/m)	PRM Factor dB	Cable Loss dB	Filter Factor dB	Result Level (dBuV/m)	Limit Line (dBuV/m)	Over Limit (dB)	Detector	Polarization
1	8390.00	47.41	37.62	39.84	3.21	2.75	51.15	74.00	-22.85	Peak	HORIZONTAL
2	9670.00	46.48	38.60	40.37	3.64	2.96	51.31	74.00	-22.69	Peak	HORIZONTAL
3	12430.00	47.14	39.03	40.23	3.76	2.49	52.19	74.00	-21.81	Peak	HORIZONTAL
4	13550.00	45.57	39.99	40.01	4.04	2.67	52.26	74.00	-21.74	Peak	HORIZONTAL
5	14220.00	44.67	39.90	39.68	4.45	2.62	51.96	74.00	-22.04	Peak	HORIZONTAL
6	17980.00	42.65	42.38	40.69	4.95	2.63	51.92	74.00	-22.08	Peak	HORIZONTAL

Note: 1. Result Level = Read Level + Antenna Factor + Cable loss + Filter Factor - PRM Factor.
 2. If Peak Result complies with AV limit, AV Result is deemed to comply with AV limit.
 3. Test setup: RBW: 1 MHz, VBW: 3 MHz, Sweep time: auto.

TR-4-E-009 Radiated Emission Test Result

Test Site : DDT 3m Chamber 3# D:\E3 6.111\2022 Report Data\Q22062203-2E UCS15\FCC ABOVE 1G 5G.EM6
Test Date : 2022-08-23 **Tested By** : Bairong
EUT : Integrated video conference terminal **Model Number** : UC S15
Power Supply : AC 120V/60Hz **Test Mode** : Tx Mode
Condition : Temp:23.1°C,Humi:51.5%,Press:100.3kPa **Antenna/Distance** : 2021 BBHA 9120D 3#/3m/VERTICAL
Memo : 11A 5825

Data: 74

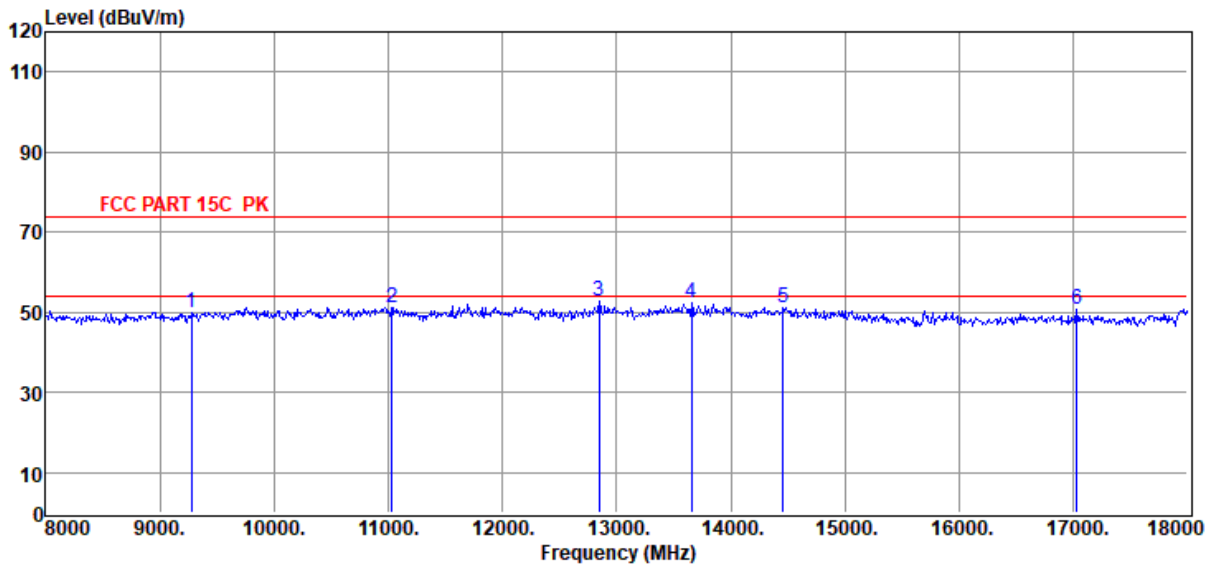

Item (Mark)	Freq. (MHz)	Read Level (dBuV)	Antenna Factor (dB/m)	PRM Factor dB	Cable Loss dB	Filter Factor dB	Result Level (dBuV/m)	Limit Line (dBuV/m)	Over Limit (dB)	Detector	Polarization
1	9280.00	45.29	38.52	40.10	3.49	2.87	50.07	74.00	-23.93	Peak	VERTICAL
2	11030.00	45.77	39.28	40.20	3.81	2.61	51.27	74.00	-22.73	Peak	VERTICAL
3	12850.00	46.94	39.42	40.35	4.19	2.61	52.81	74.00	-21.19	Peak	VERTICAL
4	13660.00	45.31	39.97	39.94	4.16	2.68	52.18	74.00	-21.82	Peak	VERTICAL
5	14460.00	44.05	39.90	39.65	4.36	2.55	51.21	74.00	-22.79	Peak	VERTICAL
6	17030.00	44.00	38.55	40.12	4.72	3.37	50.52	74.00	-23.48	Peak	VERTICAL

Note: 1. Result Level = Read Level + Antenna Factor + Cable loss + Filter Factor - PRM Factor.
 2. If Peak Result complies with AV limit, AV Result is deemed to comply with AV limit.
 3. Test setup: RBW: 1 MHz, VBW: 3 MHz, Sweep time: auto.

9. Band Edge Compliance

9.1. Block diagram of test setup

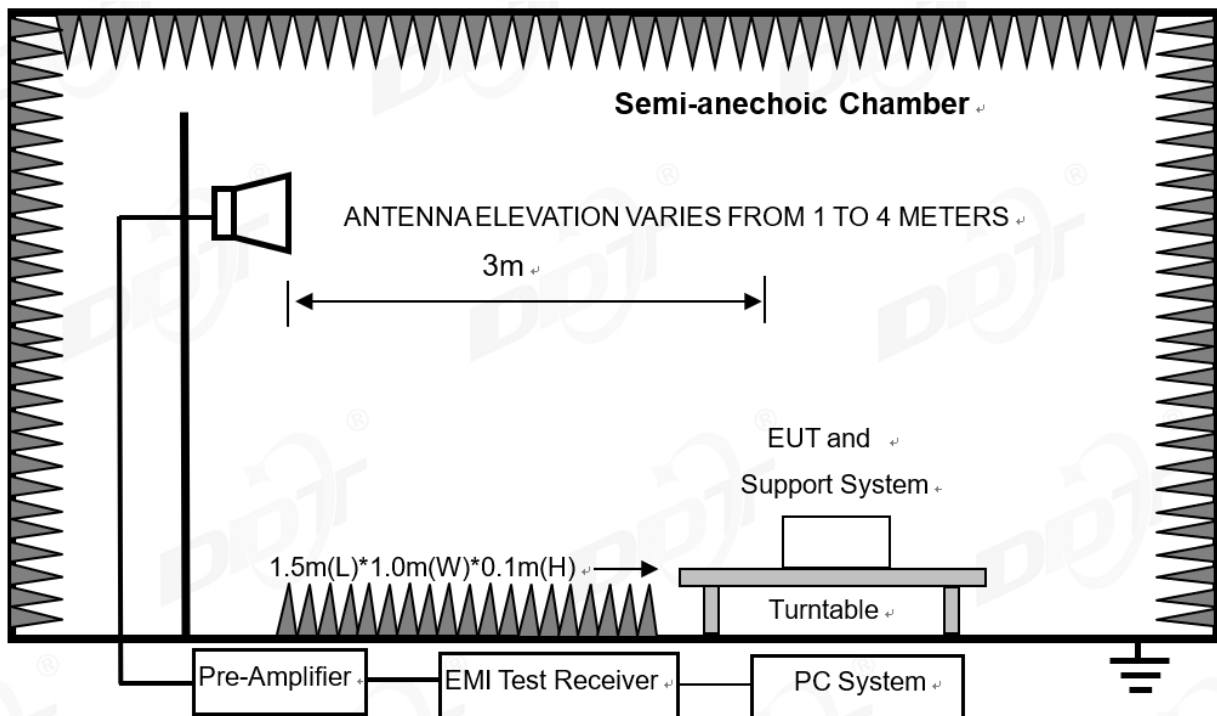

9.2. Limit

For transmitters operating in the 5.15-5.25 GHz and 5.725-5.85 GHz band: all emissions outside of the 5.15-5.35 GHz band shall not exceed an EIRP of -27 dBm/MHz.

$$-27 \text{ dBm/MHz Limit} = 95.2 + \text{EIRP}[\text{dBm}] = 95.2 - 27 = 68.2 \text{ dB}\mu\text{V/m}$$

9.3. Test Procedure

Same with clause 8.3 except change investigated frequency range from 5.15-5.25 GHz, 5250-5350 GHz, 5470-5725 GHz, 5.725-5.85 GHz.

Remark: All restriction band have been tested, and only the worst case is shown in report.

9.4. Test result

Pass. (See below detailed test result)

Note: As specified in 15.407(b), emissions above 1000 MHz that are outside of the restricted bands are subject to a peak emission limit of -27 dBm/MHz (or -17 dBm/MHz as specified in 15.407(b)(4)). However, an out-of-band emission that complies with both the average and peak limits of 15.209 is not required to satisfy the -27 dBm/MHz or -17 dBm/MHz peak emission limit

TR-4-E-009 Radiated Emission Test Result

Test Site : DDT 3m Chamber 3# D:\E3 6.111\2022 Report Data\Q22062203-2E UCS15\FCC ABOVE 1G 5G.EM6
Test Date : 2022-08-23 **Tested By** : Bairong
EUT : Integrated video conference terminal **Model Number** : UC S15
Power Supply : AC 120V/60Hz **Test Mode** : Tx Mode
Condition : Temp:23.1°C,Humi:51.5%,Press:100.3kPa **Antenna/Distance** : 2021 BBHA 9120D
3#/3m/HORIZONTAL
Memo : 11A 5180 Power:默认

Data: 17

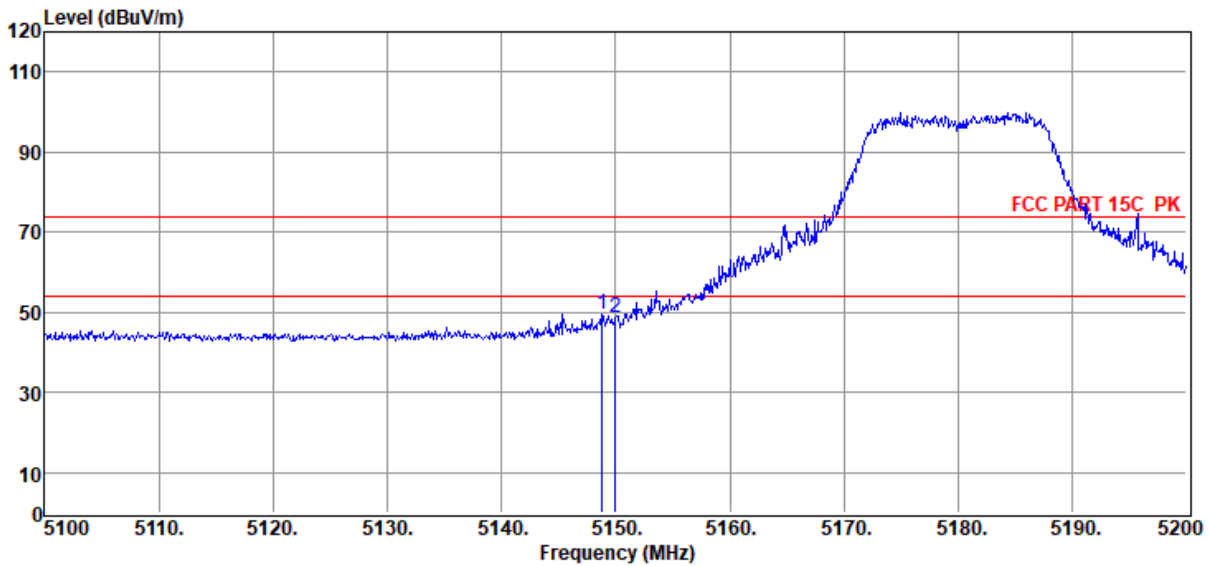

Item (Mark)	Freq. (MHz)	Read Level (dBuV)	Antenna Factor (dB/m)	PRM Factor dB	Cable Loss dB	Filter Factor dB	Result Level (dBuV/m)	Limit Line (dBuV/m)	Over Limit (dB)	Detector	Polarization
1	5148.80	53.49	33.01	40.41	2.55	0.94	49.58	74.00	-24.42	Peak	HORIZONTAL
2	5150.00	52.45	33.01	40.42	2.55	0.94	48.53	74.00	-25.47	Peak	HORIZONTAL

Note: 1. Result Level = Read Level + Antenna Factor + Cable loss + Filter Factor - PRM Factor.
 2. If Peak Result complies with AV limit, AV Result is deemed to comply with AV limit.
 3. Test setup: RBW: 1 MHz, VBW: 3 MHz, Sweep time: auto.

TR-4-E-009 Radiated Emission Test Result

Test Site : DDT 3m Chamber 3# D:\E3 6.111\2022 Report Data\Q22062203-2E UCS15\FCC ABOVE 1G 5G.EM6
Test Date : 2022-08-23 **Tested By** : Bairong
EUT : Integrated video conference terminal **Model Number** : UC S15
Power Supply : AC 120V/60Hz **Test Mode** : Tx Mode
Condition : Temp:23.1°C,Humi:51.5%,Press:100.3kPa **Antenna/Distance** : 2021 BBHA 9120D 3#/3m/VERTICAL
Memo : 11A 5180 Power:默认

Data: 18

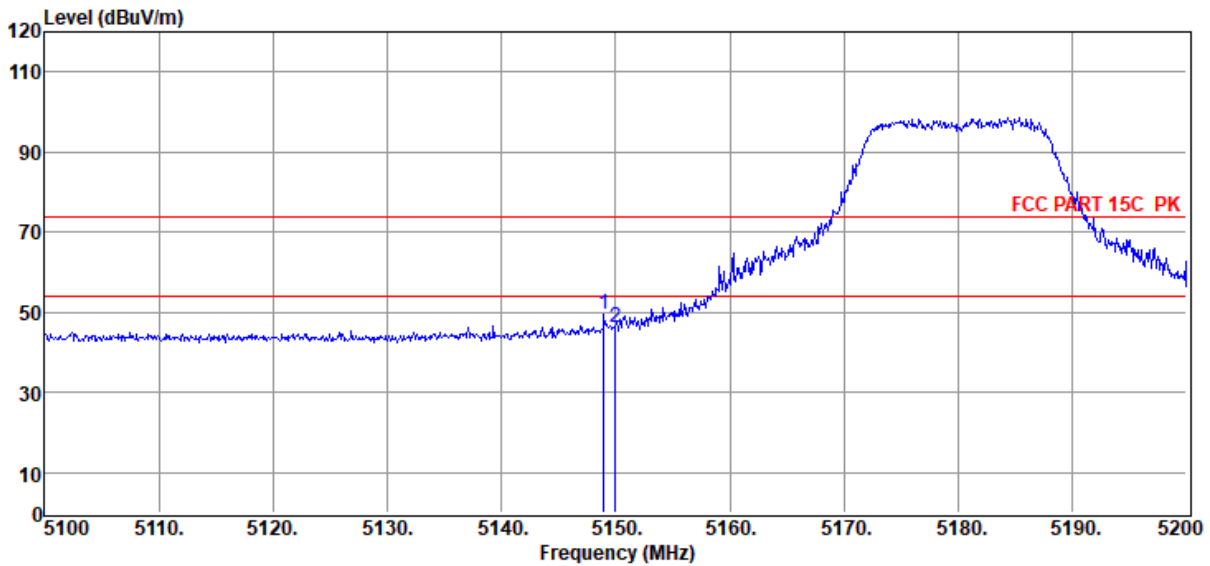

Item (Mark)	Freq. (MHz)	Read Level (dBuV)	Antenna Factor (dB/m)	PRM Factor dB	Cable Loss dB	Filter Factor dB	Result Level (dBuV/m)	Limit Line (dBuV/m)	Over Limit (dB)	Detector	Polarization
1	5149.00	53.19	33.01	40.41	2.55	0.94	49.28	74.00	-24.72	Peak	VERTICAL
2	5150.00	50.09	33.01	40.42	2.55	0.94	46.17	74.00	-27.83	Peak	VERTICAL

- Note: 1. Result Level = Read Level + Antenna Factor + Cable loss + Filter Factor - PRM Factor.
 2. If Peak Result complies with AV limit, AV Result is deemed to comply with AV limit.
 3. Test setup: RBW: 1 MHz, VBW: 3 MHz, Sweep time: auto.

TR-4-E-009 Radiated Emission Test Result

Test Site : DDT 3m Chamber 3# D:\E3 6.111\2022 Report Data\Q22062203-2E UCS15\FCC ABOVE 1G 5G.EM6
Test Date : 2022-08-24 **Tested By** : Bairong
EUT : Integrated video conference terminal **Model Number** : UC S15
Power Supply : AC 120V/60Hz **Test Mode** : Tx Mode
Condition : Temp:23.1°C,Humi:51.5%,Press:100.3kPa **Antenna/Distance** : 2021 BBHA 9120D
3#/3m/HORIZONTAL
Memo : 11A 5320 Power:默认

Data: 75

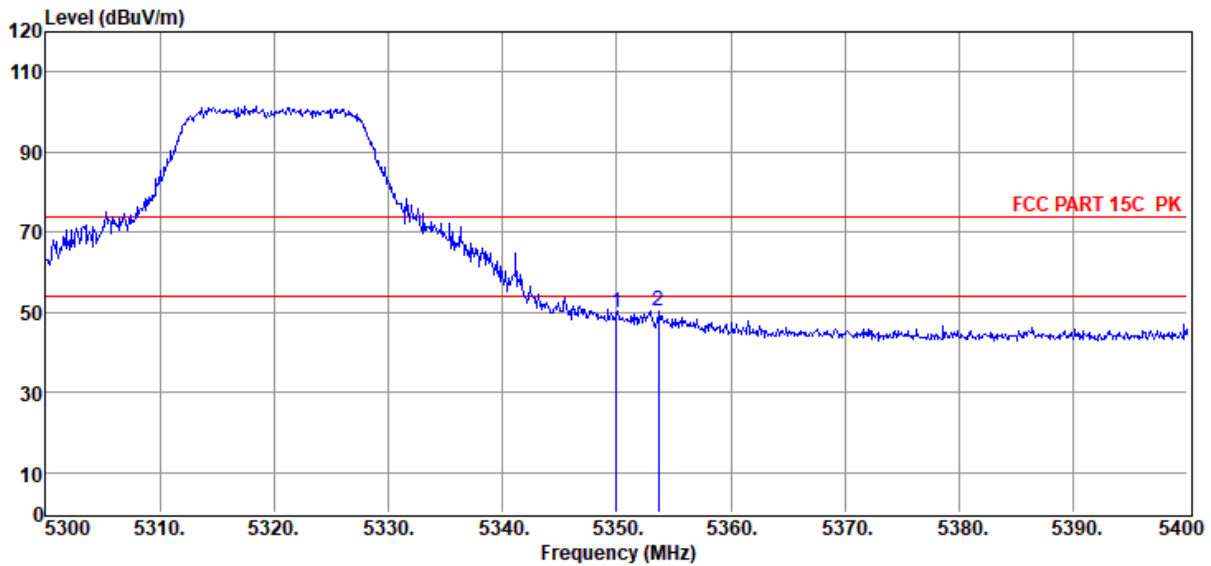

Item (Mark)	Freq. (MHz)	Read Level (dBuV)	Antenna Factor (dB/m)	PRM Factor dB	Cable Loss dB	Filter Factor dB	Result Level (dBuV/m)	Limit Line (dBuV/m)	Over Limit (dB)	Detector	Polarization
1	5350.00	53.94	32.89	40.44	2.56	0.99	49.94	74.00	-24.06	Peak	HORIZONTAL
2	5353.70	54.48	32.89	40.44	2.56	0.99	50.48	74.00	-23.52	Peak	HORIZONTAL

Note: 1. Result Level = Read Level + Antenna Factor + Cable loss + Filter Factor - PRM Factor.
 2. If Peak Result complies with AV limit, AV Result is deemed to comply with AV limit.
 3. Test setup: RBW: 1 MHz, VBW: 3 MHz, Sweep time: auto.

TR-4-E-009 Radiated Emission Test Result

Test Site : DDT 3m Chamber 3# D:\E3 6.111\2022 Report Data\Q22062203-2E UCS15\FCC ABOVE 1G 5G.EM6
Test Date : 2022-08-24 **Tested By** : Bairong
EUT : Integrated video conference terminal **Model Number** : UC S15
Power Supply : AC 120V/60Hz **Test Mode** : Tx Mode
Condition : Temp:23.1°C,Humi:51.5%,Press:100.3kPa **Antenna/Distance** : 2021 BBHA 9120D 3#/3m/VERTICAL
Memo : 11A 5320 Power:默认

Data: 76

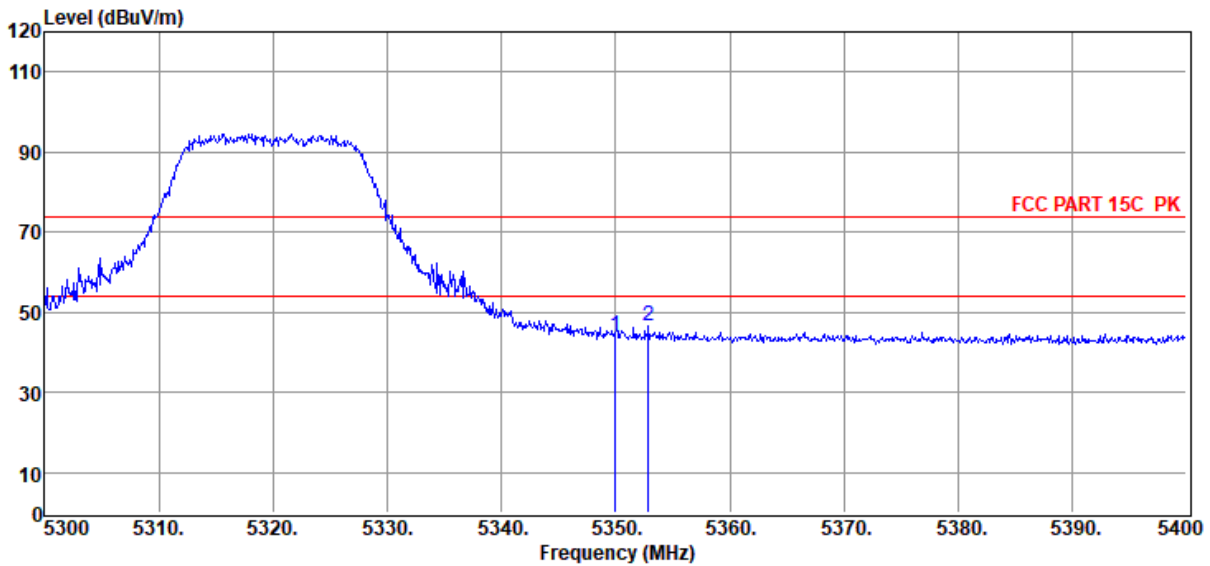

Item (Mark)	Freq. (MHz)	Read Level (dBuV)	Antenna Factor (dB/m)	PRM Factor dB	Cable Loss dB	Filter Factor dB	Result Level (dBuV/m)	Limit Line (dBuV/m)	Over Limit (dB)	Detector	Polarization
1	5350.00	48.02	32.89	40.44	2.56	0.99	44.02	74.00	-29.98	Peak	VERTICAL
2	5352.90	50.47	32.89	40.44	2.56	0.99	46.47	74.00	-27.53	Peak	VERTICAL

- Note: 1. Result Level = Read Level + Antenna Factor + Cable loss + Filter Factor - PRM Factor.
 2. If Peak Result complies with AV limit, AV Result is deemed to comply with AV limit.
 3. Test setup: RBW: 1 MHz, VBW: 3 MHz, Sweep time: auto.

TR-4-E-009 Radiated Emission Test Result

Test Site : DDT 3m Chamber 3# D:\E3 6.111\2022 Report Data\Q22062203-2E UCS15\FCC ABOVE 1G 5G.EM6
Test Date : 2022-08-23 **Tested By** : Bairong
EUT : Integrated video conference terminal **Model Number** : UC S15
Power Supply : AC 120V/60Hz **Test Mode** : Tx Mode
Condition : Temp:23.1°C,Humi:51.5%,Press:100.3kPa **Antenna/Distance** : 2021 BBHA 9120D
3#/3m/HORIZONTAL
Memo : 11N20 5180 Power:默认

Data: 19

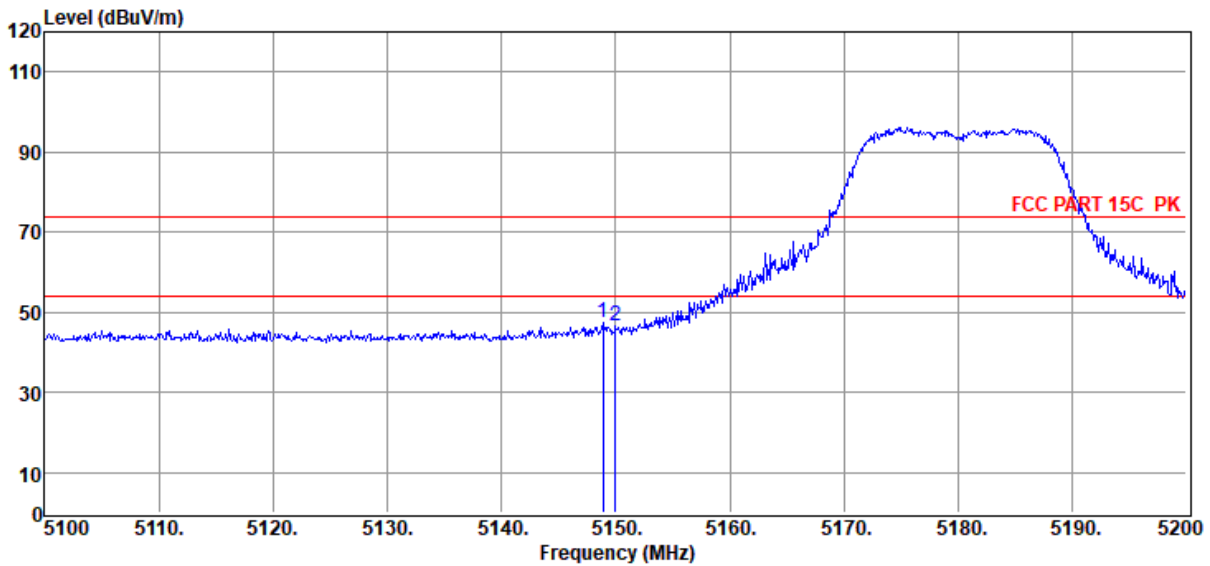

Item (Mark)	Freq. (MHz)	Read Level (dBuV)	Antenna Factor (dB/m)	PRM Factor dB	Cable Loss dB	Filter Factor dB	Result Level (dBuV/m)	Limit Line (dBuV/m)	Over Limit (dB)	Detector	Polarization
1	5148.90	51.53	33.01	40.41	2.55	0.94	47.62	74.00	-26.38	Peak	HORIZONTAL
2	5150.00	50.62	33.01	40.42	2.55	0.94	46.70	74.00	-27.30	Peak	HORIZONTAL

Note: 1. Result Level = Read Level + Antenna Factor + Cable loss + Filter Factor - PRM Factor.
 2. If Peak Result complies with AV limit, AV Result is deemed to comply with AV limit.
 3. Test setup: RBW: 1 MHz, VBW: 3 MHz, Sweep time: auto.

TR-4-E-009 Radiated Emission Test Result

Test Site : DDT 3m Chamber 3# D:\E3 6.111\2022 Report Data\Q22062203-2E UCS15\FCC ABOVE 1G 5G.EM6
Test Date : 2022-08-23 **Tested By** : Bairong
EUT : Integrated video conference terminal **Model Number** : UC S15
Power Supply : AC 120V/60Hz **Test Mode** : Tx Mode
Condition : Temp:23.1°C,Humi:51.5%,Press:100.3kPa **Antenna/Distance** : 2021 BBHA 9120D 3#/3m/VERTICAL
Memo : 11N20 5180 Power:默认

Data: 20

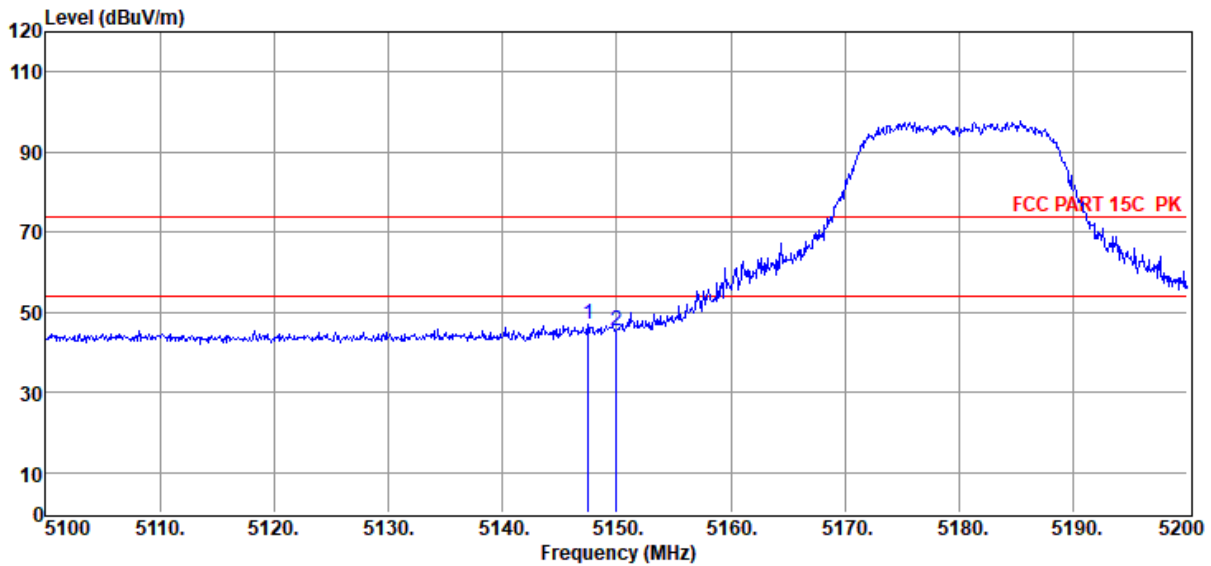

Item (Mark)	Freq. (MHz)	Read Level (dBuV)	Antenna Factor (dB/m)	PRM Factor dB	Cable Loss dB	Filter Factor dB	Result Level (dBuV/m)	Limit Line (dBuV/m)	Over Limit (dB)	Detector	Polarization
1	5147.50	50.72	33.01	40.41	2.55	0.94	46.81	74.00	-27.19	Peak	VERTICAL
2	5150.00	49.47	33.01	40.42	2.55	0.94	45.55	74.00	-28.45	Peak	VERTICAL

Note: 1. Result Level = Read Level + Antenna Factor + Cable loss + Filter Factor - PRM Factor.
 2. If Peak Result complies with AV limit, AV Result is deemed to comply with AV limit.
 3. Test setup: RBW: 1 MHz, VBW: 3 MHz, Sweep time: auto.

TR-4-E-009 Radiated Emission Test Result

Test Site : DDT 3m Chamber 3# D:\E3 6.111\2022 Report Data\Q22062203-2E UCS15\FCC ABOVE 1G 5G.EM6
Test Date : 2022-08-24 **Tested By** : Bairong
EUT : Integrated video conference terminal **Model Number** : UC S15
Power Supply : AC 120V/60Hz **Test Mode** : Tx Mode
Condition : Temp:23.1°C,Humi:51.5%,Press:100.3kPa **Antenna/Distance** : 2021 BBHA 9120D
3#/3m/HORIZONTAL
Memo : 11N20 5320 Power:默认

Data: 77

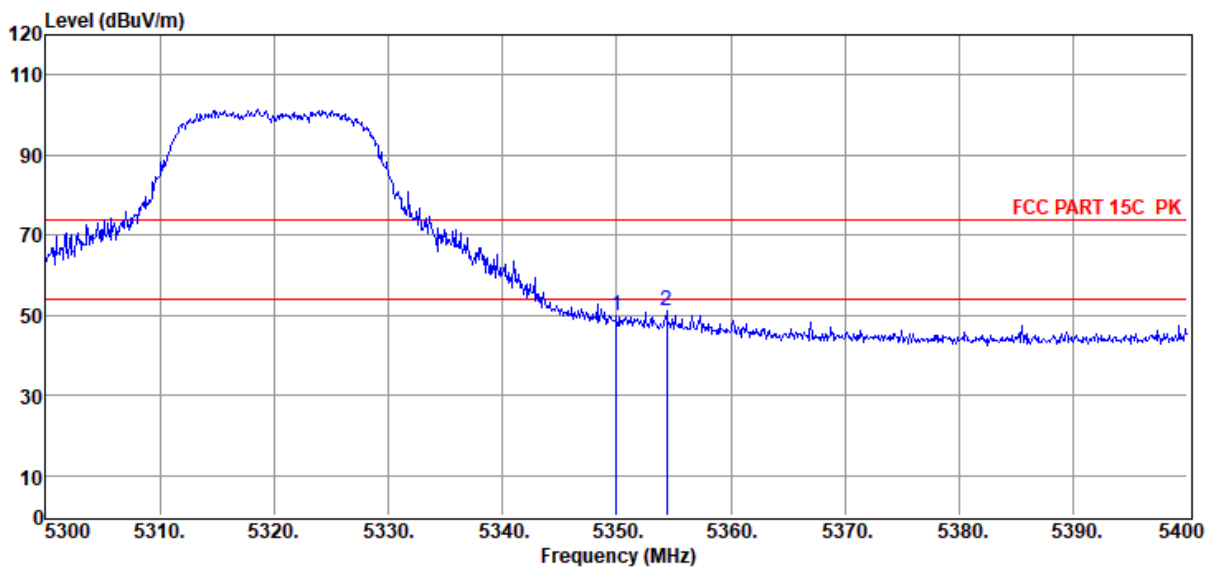

Item (Mark)	Freq. (MHz)	Read Level (dBuV)	Antenna Factor (dB/m)	PRM Factor dB	Cable Loss dB	Filter Factor dB	Result Level (dBuV/m)	Limit Line (dBuV/m)	Over Limit (dB)	Detector	Polarization
1	5350.00	53.75	32.89	40.44	2.56	0.99	49.75	74.00	-24.25	Peak	HORIZONTAL
2	5354.40	55.25	32.89	40.44	2.56	0.99	51.25	74.00	-22.75	Peak	HORIZONTAL

Note: 1. Result Level = Read Level + Antenna Factor + Cable loss + Filter Factor - PRM Factor.
 2. If Peak Result complies with AV limit, AV Result is deemed to comply with AV limit.
 3. Test setup: RBW: 1 MHz, VBW: 3 MHz, Sweep time: auto.

TR-4-E-009 Radiated Emission Test Result

Test Site : DDT 3m Chamber 3# D:\E3 6.111\2022 Report Data\Q22062203-2E UCS15\FCC ABOVE 1G 5G.EM6
Test Date : 2022-08-24 **Tested By** : Bairong
EUT : Integrated video conference terminal **Model Number** : UC S15
Power Supply : AC 120V/60Hz **Test Mode** : Tx Mode
Condition : Temp:23.1°C,Humi:51.5%,Press:100.3kPa **Antenna/Distance** : 2021 BBHA 9120D 3#/3m/VERTICAL
Memo : 11N20 5320 Power:默认

Data: 78

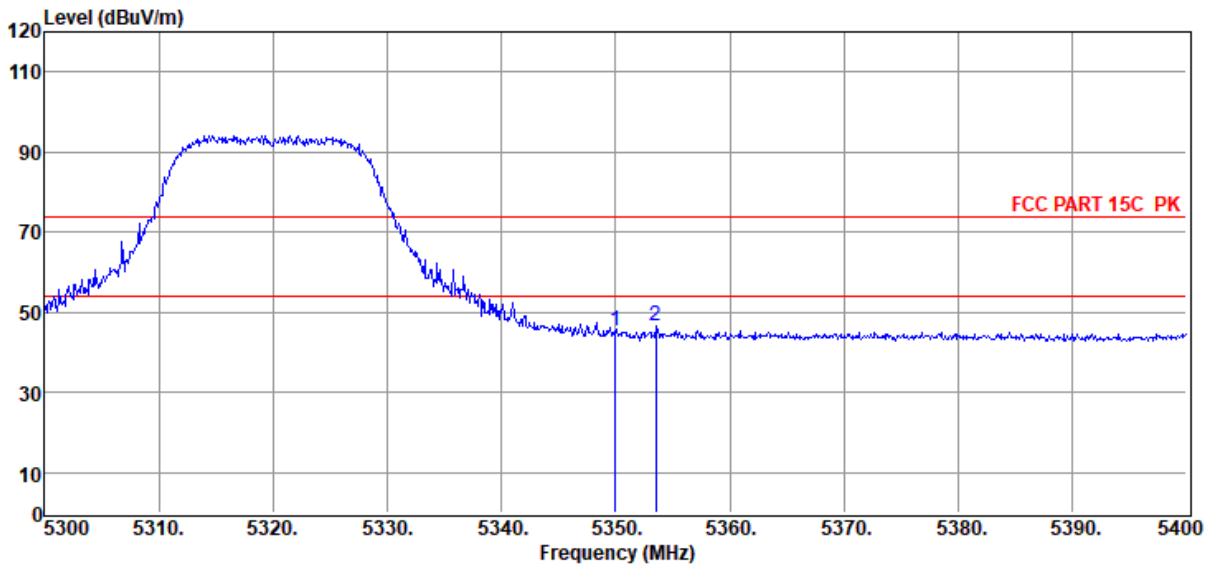

Item (Mark)	Freq. (MHz)	Read Level (dBuV)	Antenna Factor (dB/m)	PRM Factor dB	Cable Loss dB	Filter Factor dB	Result Level (dBuV/m)	Limit Line (dBuV/m)	Over Limit (dB)	Detector	Polarization
1	5350.00	49.21	32.89	40.44	2.56	0.99	45.21	74.00	-28.79	Peak	VERTICAL
2	5353.50	50.46	32.89	40.44	2.56	0.99	46.46	74.00	-27.54	Peak	VERTICAL

Note: 1. Result Level = Read Level + Antenna Factor + Cable loss + Filter Factor - PRM Factor.
 2. If Peak Result complies with AV limit, AV Result is deemed to comply with AV limit.
 3. Test setup: RBW: 1 MHz, VBW: 3 MHz, Sweep time: auto.

TR-4-E-009 Radiated Emission Test Result

Test Site : DDT 3m Chamber 3# D:\E3 6.111\2022 Report Data\Q22062203-2E UCS15\FCC ABOVE 1G 5G.EM6
Test Date : 2022-08-23 **Tested By** : Bairong
EUT : Integrated video conference terminal **Model Number** : UC S15
Power Supply : AC 120V/60Hz **Test Mode** : Tx Mode
Condition : Temp:23.1°C,Humi:51.5%,Press:100.3kPa **Antenna/Distance** : 2021 BBHA 9120D
3#/3m/HORIZONTAL
Memo : 11AX20 5180 Power:默认

Data: 23

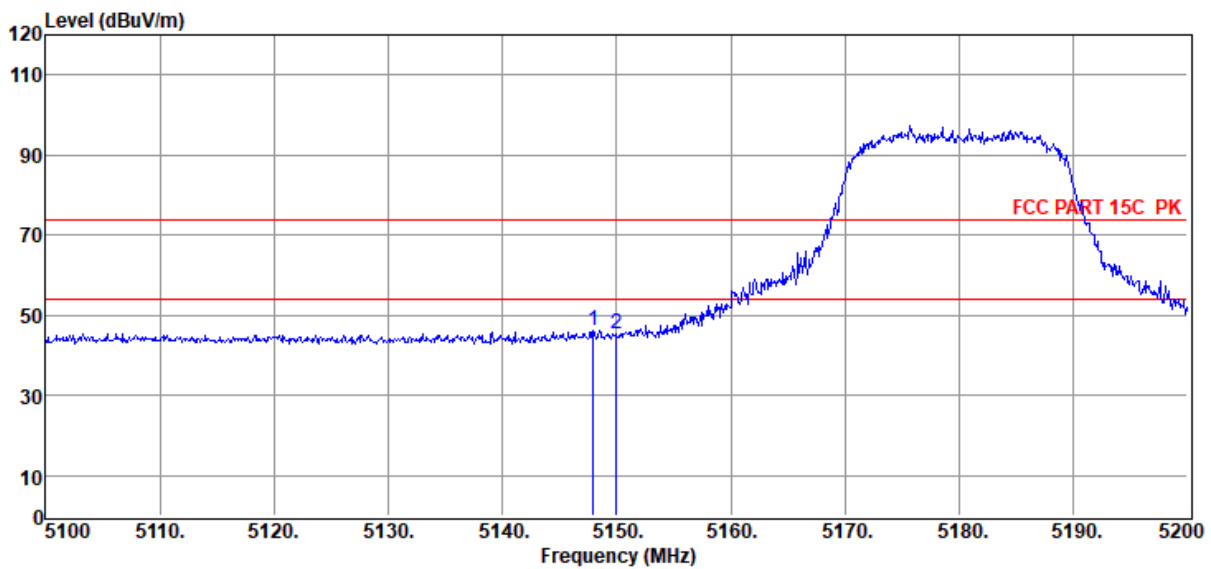

Item (Mark)	Freq. (MHz)	Read Level (dBuV)	Antenna Factor (dB/m)	PRM Factor dB	Cable Loss dB	Filter Factor dB	Result Level (dBuV/m)	Limit Line (dBuV/m)	Over Limit (dB)	Detector	Polarization
1	5148.00	49.95	33.01	40.41	2.55	0.94	46.04	74.00	-27.96	Peak	HORIZONTAL
2	5150.00	49.18	33.01	40.42	2.55	0.94	45.26	74.00	-28.74	Peak	HORIZONTAL

Note: 1. Result Level = Read Level + Antenna Factor + Cable loss + Filter Factor - PRM Factor.
 2. If Peak Result complies with AV limit, AV Result is deemed to comply with AV limit.
 3. Test setup: RBW: 1 MHz, VBW: 3 MHz, Sweep time: auto.

TR-4-E-009 Radiated Emission Test Result

Test Site : DDT 3m Chamber 3# D:\E3 6.111\2022 Report Data\Q22062203-2E UCS15\FCC ABOVE 1G 5G.EM6
Test Date : 2022-08-23 **Tested By** : Bairong
EUT : Integrated video conference terminal **Model Number** : UC S15
Power Supply : AC 120V/60Hz **Test Mode** : Tx Mode
Condition : Temp:23.1°C,Humi:51.5%,Press:100.3kPa **Antenna/Distance** : 2021 BBHA 9120D 3#/3m/VERTICAL
Memo : 11AX20 5180 Power:默认

Data: 24

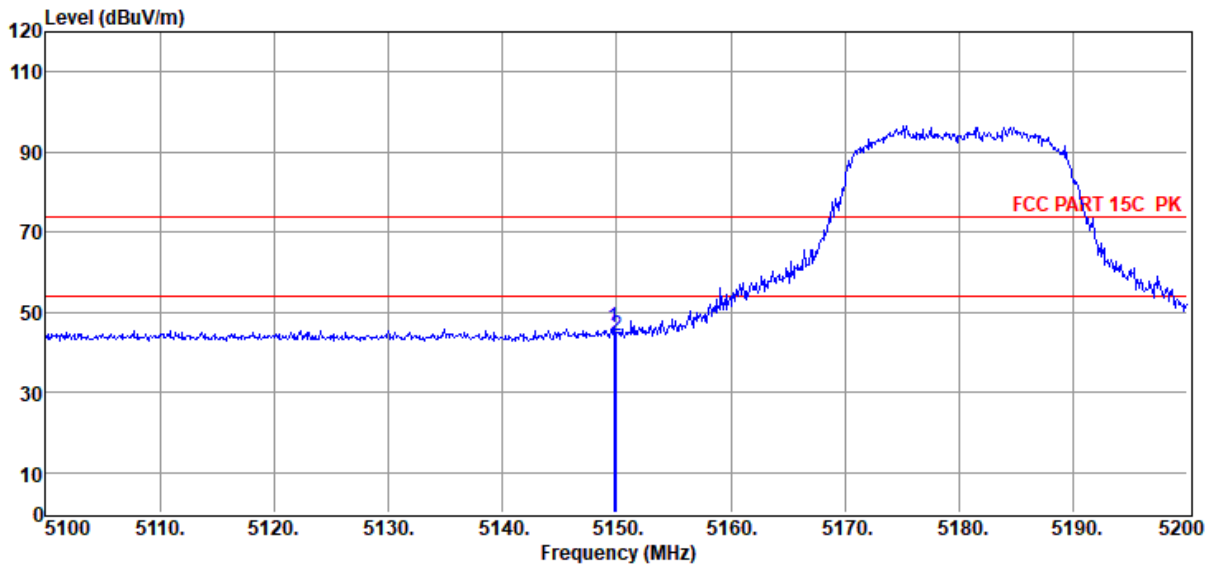

Item (Mark)	Freq. (MHz)	Read Level (dBuV)	Antenna Factor (dB/m)	PRM Factor dB	Cable Loss dB	Filter Factor dB	Result Level (dBuV/m)	Limit Line (dBuV/m)	Over Limit (dB)	Detector	Polarization
1	5149.80	50.22	33.01	40.41	2.55	0.94	46.31	74.00	-27.69	Peak	VERTICAL
2	5150.00	48.25	33.01	40.42	2.55	0.94	44.33	74.00	-29.67	Peak	VERTICAL

Note: 1. Result Level = Read Level + Antenna Factor + Cable loss + Filter Factor - PRM Factor.
 2. If Peak Result complies with AV limit, AV Result is deemed to comply with AV limit.
 3. Test setup: RBW: 1 MHz, VBW: 3 MHz, Sweep time: auto.

TR-4-E-009 Radiated Emission Test Result

Test Site : DDT 3m Chamber 3# D:\E3 6.111\2022 Report Data\Q22062203-2E UCS15\FCC ABOVE 1G 5G.EM6
Test Date : 2022-08-24 **Tested By** : Bairong
EUT : Integrated video conference terminal **Model Number** : UC S15
Power Supply : AC 120V/60Hz **Test Mode** : Tx Mode
Condition : Temp:23.1°C,Humi:51.5%,Press:100.3kPa **Antenna/Distance** : 2021 BBHA 9120D
3#/3m/HORIZONTAL
Memo : 11AX20 5320 Power:默认

Data: 81

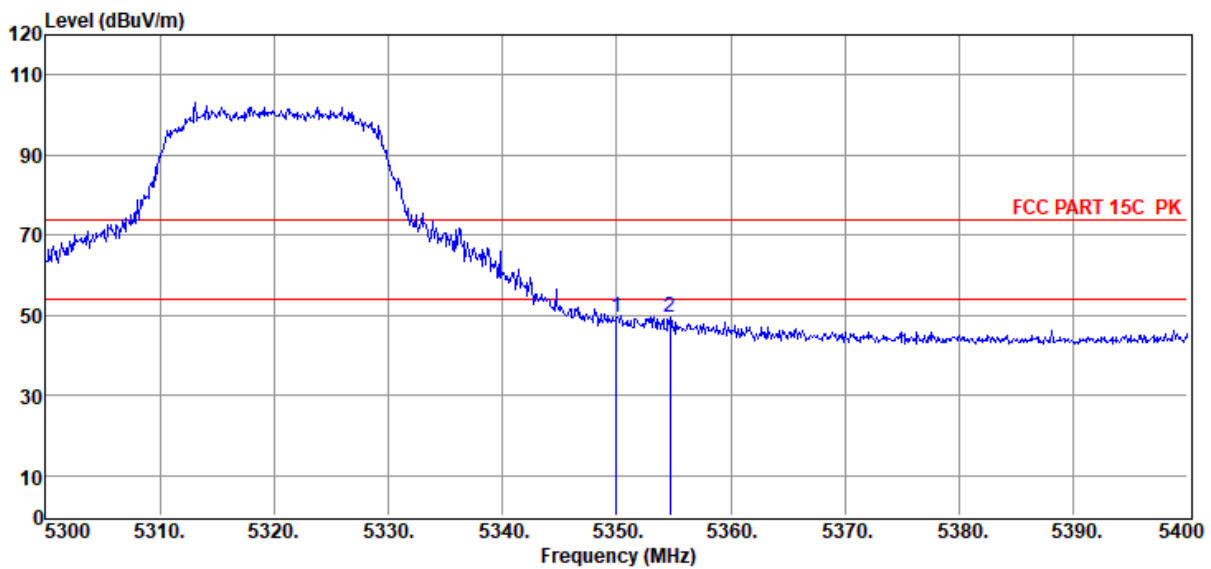

Item (Mark)	Freq. (MHz)	Read Level (dBuV)	Antenna Factor (dB/m)	PRM Factor dB	Cable Loss dB	Filter Factor dB	Result Level (dBuV/m)	Limit Line (dBuV/m)	Over Limit (dB)	Detector	Polarization
1	5350.00	53.48	32.89	40.44	2.56	0.99	49.48	74.00	-24.52	Peak	HORIZONTAL
2	5354.70	53.56	32.89	40.44	2.56	0.99	49.56	74.00	-24.44	Peak	HORIZONTAL

Note: 1. Result Level = Read Level + Antenna Factor + Cable loss + Filter Factor - PRM Factor.
 2. If Peak Result complies with AV limit, AV Result is deemed to comply with AV limit.
 3. Test setup: RBW: 1 MHz, VBW: 3 MHz, Sweep time: auto.

TR-4-E-009 Radiated Emission Test Result

Test Site : DDT 3m Chamber 3# D:\E3 6.111\2022 Report Data\Q22062203-2E UCS15\FCC ABOVE 1G 5G.EM6
Test Date : 2022-08-24 **Tested By** : Bairong
EUT : Integrated video conference terminal **Model Number** : UC S15
Power Supply : AC 120V/60Hz **Test Mode** : Tx Mode
Condition : Temp:23.1°C,Humi:51.5%,Press:100.3kPa **Antenna/Distance** : 2021 BBHA 9120D 3#/3m/VERTICAL
Memo : 11AX20 5320 Power:默认

Data: 82

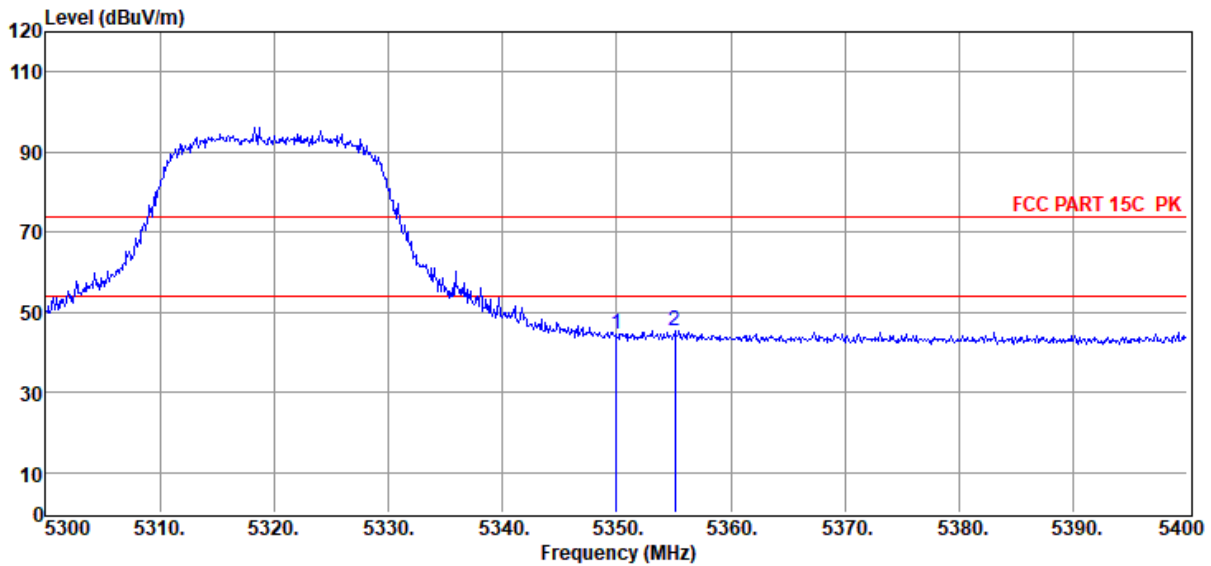

Item (Mark)	Freq. (MHz)	Read Level (dBuV)	Antenna Factor (dB/m)	PRM Factor dB	Cable Loss dB	Filter Factor dB	Result Level (dBuV/m)	Limit Line (dBuV/m)	Over Limit (dB)	Detector	Polarization
1	5350.00	48.48	32.89	40.44	2.56	0.99	44.48	74.00	-29.52	Peak	VERTICAL
2	5355.10	49.43	32.89	40.44	2.56	0.99	45.43	74.00	-28.57	Peak	VERTICAL

Note: 1. Result Level = Read Level + Antenna Factor + Cable loss + Filter Factor - PRM Factor.
 2. If Peak Result complies with AV limit, AV Result is deemed to comply with AV limit.
 3. Test setup: RBW: 1 MHz, VBW: 3 MHz, Sweep time: auto.

TR-4-E-009 Radiated Emission Test Result

Test Site : DDT 3m Chamber 3# D:\E3 6.111\2022 Report Data\Q22062203-2E UCS15\FCC ABOVE 1G 5G.EM6
Test Date : 2022-08-24 **Tested By** : Bairong
EUT : Integrated video conference terminal **Model Number** : UC S15
Power Supply : AC 120V/60Hz **Test Mode** : Tx Mode
Condition : Temp:23.1°C,Humi:51.5%,Press:100.3kPa **Antenna/Distance** : 2021 BBHA 9120D
3#/3m/HORIZONTAL
Memo : 11A 5500 Power:默认

Data: 83

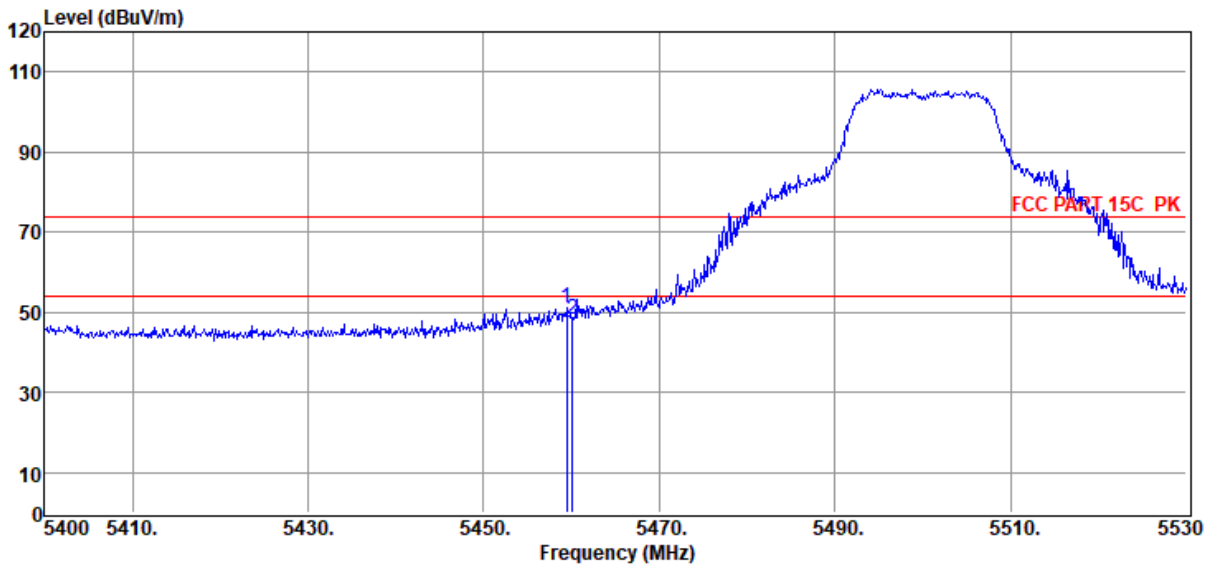

Item (Mark)	Freq. (MHz)	Read Level (dBuV)	Antenna Factor (dB/m)	PRM Factor dB	Cable Loss dB	Filter Factor dB	Result Level (dBuV/m)	Limit Line (dBuV/m)	Over Limit (dB)	Detector	Polarization
1	5459.41	55.34	32.82	40.45	2.57	1.02	51.30	74.00	-22.70	Peak	HORIZONTAL
2	5460.06	52.48	32.82	40.45	2.57	1.02	48.44	74.00	-25.56	Peak	HORIZONTAL

- Note: 1. Result Level = Read Level + Antenna Factor + Cable loss + Filter Factor - PRM Factor.
 2. If Peak Result complies with AV limit, AV Result is deemed to comply with AV limit.
 3. Test setup: RBW: 1 MHz, VBW: 3 MHz, Sweep time: auto.

TR-4-E-009 Radiated Emission Test Result

Test Site : DDT 3m Chamber 3# D:\E3 6.111\2022 Report Data\Q22062203-2E UCS15\FCC ABOVE 1G 5G.EM6
Test Date : 2022-08-24 **Tested By** : Bairong
EUT : Integrated video conference terminal **Model Number** : UC S15
Power Supply : AC 120V/60Hz **Test Mode** : Tx Mode
Condition : Temp:23.1°C,Humi:51.5%,Press:100.3kPa **Antenna/Distance** : 2021 BBHA 9120D 3#/3m/VERTICAL
Memo : 11A 5500 Power:默认

Data: 84

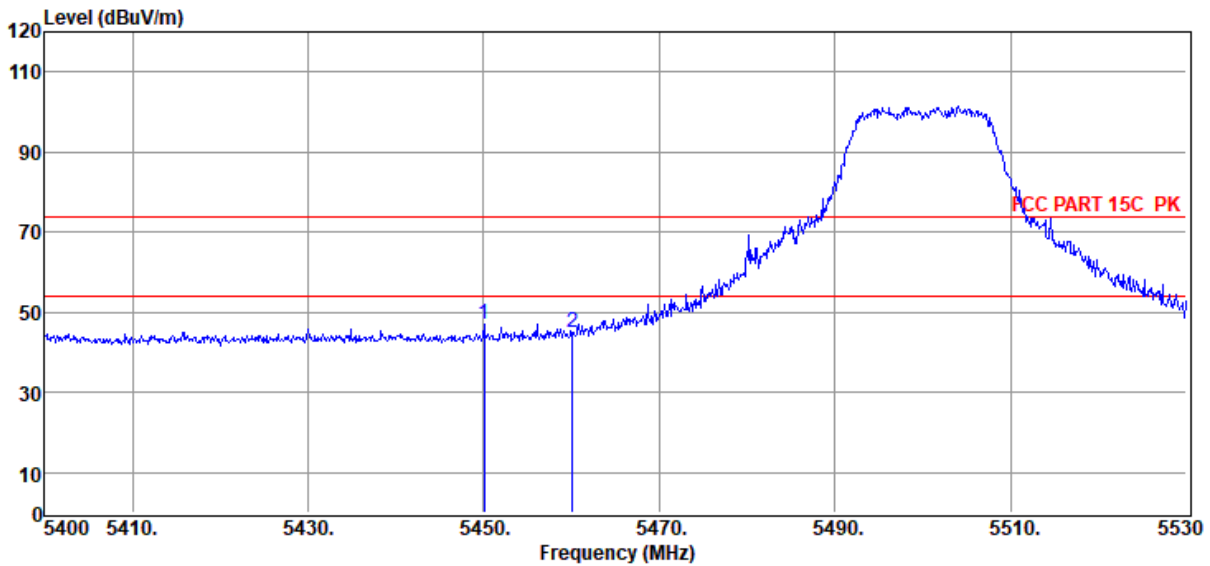

Item (Mark)	Freq. (MHz)	Read Level (dBuV)	Antenna Factor (dB/m)	PRM Factor dB	Cable Loss dB	Filter Factor dB	Result Level (dBuV/m)	Limit Line (dBuV/m)	Over Limit (dB)	Detector	Polarization
1	5450.05	51.00	32.83	40.45	2.57	1.01	46.96	74.00	-27.04	Peak	VERTICAL
2	5460.06	48.93	32.82	40.45	2.57	1.02	44.89	74.00	-29.11	Peak	VERTICAL

Note: 1. Result Level = Read Level + Antenna Factor + Cable loss + Filter Factor - PRM Factor.
 2. If Peak Result complies with AV limit, AV Result is deemed to comply with AV limit.
 3. Test setup: RBW: 1 MHz, VBW: 3 MHz, Sweep time: auto.

TR-4-E-009 Radiated Emission Test Result

Test Site : DDT 3m Chamber 3# D:\E3 6.111\2022 Report Data\Q22062203-2E UCS15\FCC ABOVE 1G 5G.EM6
Test Date : 2022-08-24 **Tested By** : Bairong
EUT : Integrated video conference terminal **Model Number** : UC S15
Power Supply : AC 120V/60Hz **Test Mode** : Tx Mode
Condition : Temp:23.1°C,Humi:51.5%,Press:100.3kPa **Antenna/Distance** : 2021 BBHA 9120D
3#/3m/HORIZONTAL
Memo : 11N20 5500 Power:默认

Data: 85

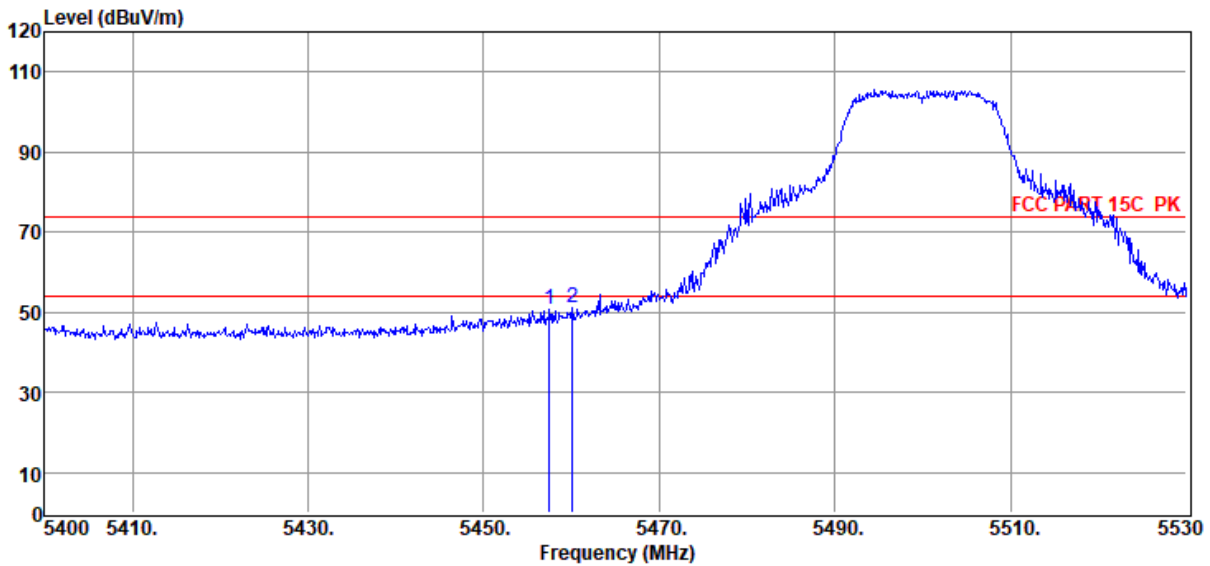

Item (Mark)	Freq. (MHz)	Read Level (dBuV)	Antenna Factor (dB/m)	PRM Factor dB	Cable Loss dB	Filter Factor dB	Result Level (dBuV/m)	Limit Line (dBuV/m)	Over Limit (dB)	Detector	Polarization
1	5457.46	54.72	32.83	40.45	2.57	1.02	50.69	74.00	-23.31	Peak	HORIZONTAL
2	5460.06	55.04	32.82	40.45	2.57	1.02	51.00	74.00	-23.00	Peak	HORIZONTAL

Note: 1. Result Level = Read Level + Antenna Factor + Cable loss + Filter Factor - PRM Factor.
 2. If Peak Result complies with AV limit, AV Result is deemed to comply with AV limit.
 3. Test setup: RBW: 1 MHz, VBW: 3 MHz, Sweep time: auto.

TR-4-E-009 Radiated Emission Test Result

Test Site : DDT 3m Chamber 3# D:\E3 6.111\2022 Report Data\Q22062203-2E UCS15\FCC ABOVE 1G 5G.EM6
Test Date : 2022-08-24 **Tested By** : Bairong
EUT : Integrated video conference terminal **Model Number** : UC S15
Power Supply : AC 120V/60Hz **Test Mode** : Tx Mode
Condition : Temp:23.1°C,Humi:51.5%,Press:100.3kPa **Antenna/Distance** : 2021 BBHA 9120D 3#/3m/VERTICAL
Memo : 11N20 5500 Power:默认

Data: 86

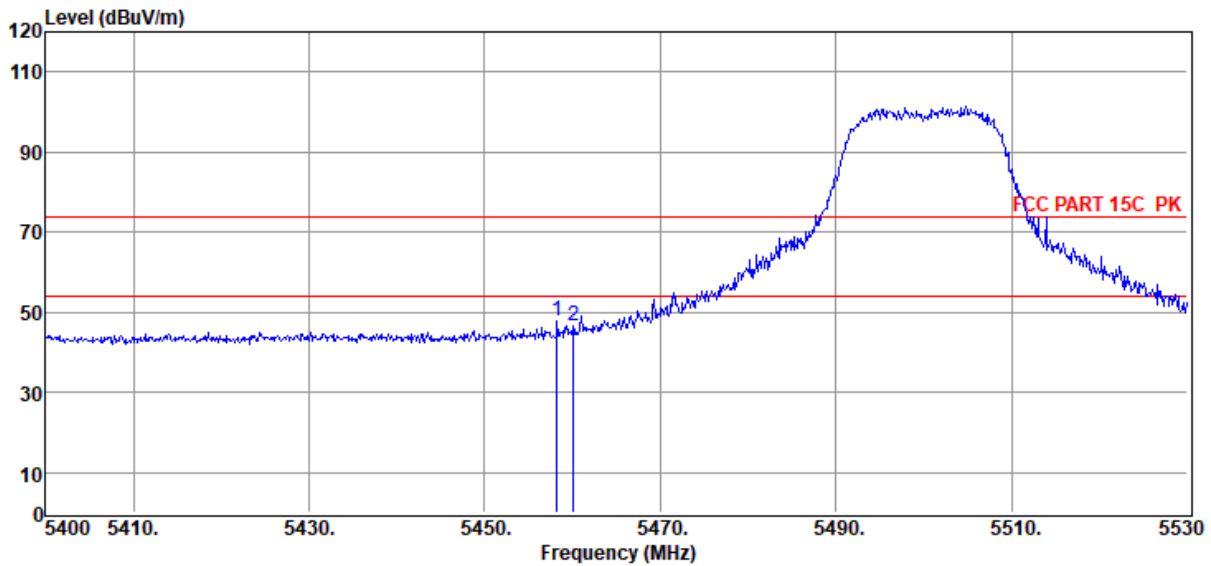

Item (Mark)	Freq. (MHz)	Read Level (dBuV)	Antenna Factor (dB/m)	PRM Factor dB	Cable Loss dB	Filter Factor dB	Result Level (dBuV/m)	Limit Line (dBuV/m)	Over Limit (dB)	Detector	Polarization
1	5458.24	52.02	32.83	40.45	2.57	1.02	47.99	74.00	-26.01	Peak	VERTICAL
2	5460.06	50.59	32.82	40.45	2.57	1.02	46.55	74.00	-27.45	Peak	VERTICAL

Note: 1. Result Level = Read Level + Antenna Factor + Cable loss + Filter Factor - PRM Factor.
 2. If Peak Result complies with AV limit, AV Result is deemed to comply with AV limit.
 3. Test setup: RBW: 1 MHz, VBW: 3 MHz, Sweep time: auto.

TR-4-E-009 Radiated Emission Test Result

Test Site : DDT 3m Chamber 3# D:\E3 6.111\2022 Report Data\Q22062203-2E UCS15\FCC ABOVE 1G 5G.EM6
Test Date : 2022-08-24 **Tested By** : Bairong
EUT : Integrated video conference terminal **Model Number** : UC S15
Power Supply : AC 120V/60Hz **Test Mode** : Tx Mode
Condition : Temp:23.1°C,Humi:51.5%,Press:100.3kPa **Antenna/Distance** : 2021 BBHA 9120D
3#/3m/HORIZONTAL
Memo : 11AX20 5500 Power:默认

Data: 89

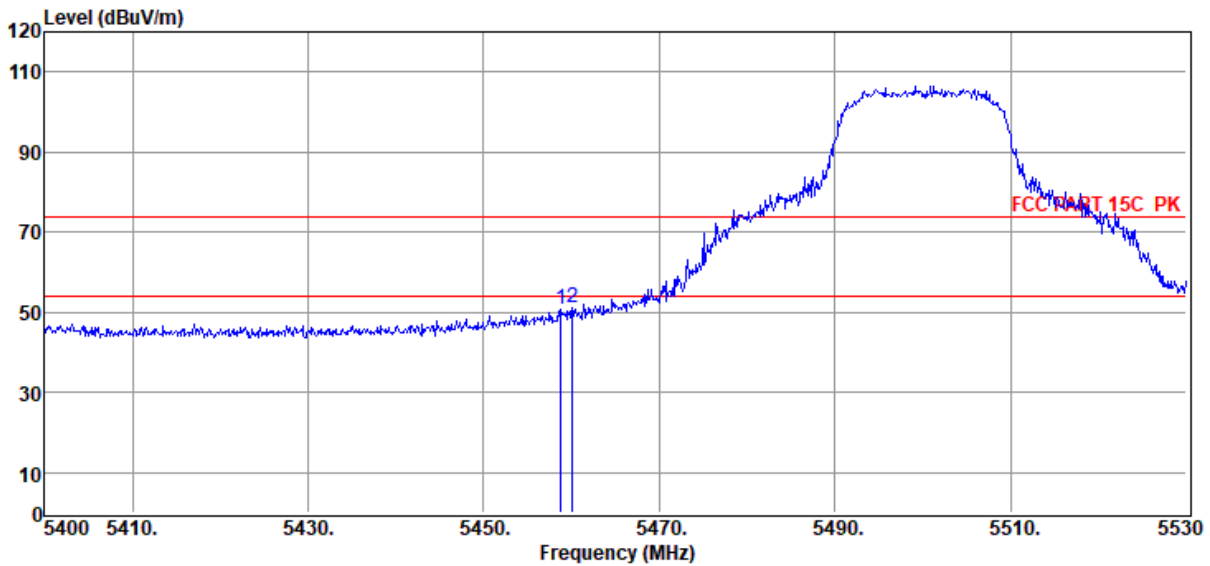

Item (Mark)	Freq. (MHz)	Read Level (dBuV)	Antenna Factor (dB/m)	PRM Factor dB	Cable Loss dB	Filter Factor dB	Result Level (dBuV/m)	Limit Line (dBuV/m)	Over Limit (dB)	Detector	Polarization
1	5458.76	54.75	32.82	40.45	2.57	1.02	50.71	74.00	-23.29	Peak	HORIZONTAL
2	5460.06	55.01	32.82	40.45	2.57	1.02	50.97	74.00	-23.03	Peak	HORIZONTAL

Note: 1. Result Level = Read Level + Antenna Factor + Cable loss + Filter Factor - PRM Factor.
 2. If Peak Result complies with AV limit, AV Result is deemed to comply with AV limit.
 3. Test setup: RBW: 1 MHz, VBW: 3 MHz, Sweep time: auto.

TR-4-E-009 Radiated Emission Test Result

Test Site : DDT 3m Chamber 3# D:\E3 6.111\2022 Report Data\Q22062203-2E UCS15\FCC ABOVE 1G 5G.EM6
Test Date : 2022-08-24 **Tested By** : Bairong
EUT : Integrated video conference terminal **Model Number** : UC S15
Power Supply : AC 120V/60Hz **Test Mode** : Tx Mode
Condition : Temp:23.1°C,Humi:51.5%,Press:100.3kPa **Antenna/Distance** : 2021 BBHA 9120D 3#/3m/VERTICAL
Memo : 11AX20 5500 Power:默认

Data: 90

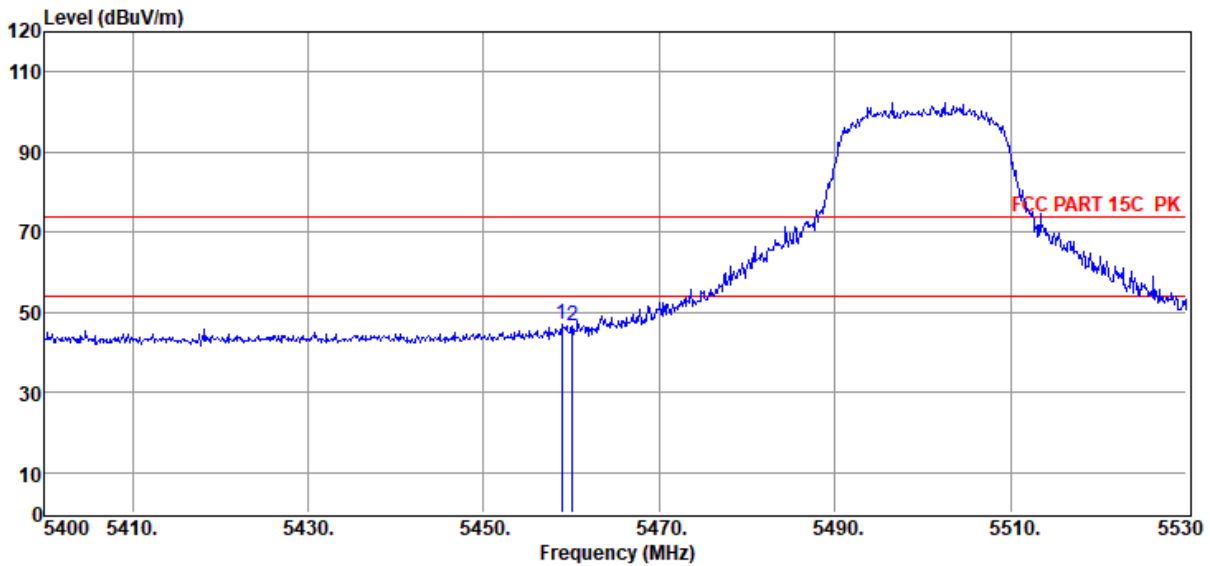

Item (Mark)	Freq. (MHz)	Read Level (dBuV)	Antenna Factor (dB/m)	PRM Factor dB	Cable Loss dB	Filter Factor dB	Result Level (dBuV/m)	Limit Line (dBuV/m)	Over Limit (dB)	Detector	Polarization
1	5458.89	51.06	32.82	40.45	2.57	1.02	47.02	74.00	-26.98	Peak	VERTICAL
2	5460.06	50.48	32.82	40.45	2.57	1.02	46.44	74.00	-27.56	Peak	VERTICAL

- Note: 1. Result Level = Read Level + Antenna Factor + Cable loss + Filter Factor - PRM Factor.
 2. If Peak Result complies with AV limit, AV Result is deemed to comply with AV limit.
 3. Test setup: RBW: 1 MHz, VBW: 3 MHz, Sweep time: auto.

TR-4-E-009 Radiated Emission Test Result

Test Site : DDT 3m Chamber 3# D:\E3 6.111\2022 Report Data\Q22062203-2E UCS15\FCC ABOVE 1G 5G.EM6
Test Date : 2022-08-24 **Tested By** : Bairong
EUT : Integrated video conference terminal **Model Number** : UC S15
Power Supply : AC 120V/60Hz **Test Mode** : Tx Mode
Condition : Temp:23.1°C,Humi:51.5%,Press:100.3kPa **Antenna/Distance** : 2021 BBHA 9120D
3#/3m/HORIZONTAL
Memo : 11A 5700 Power:默认

Data: 91

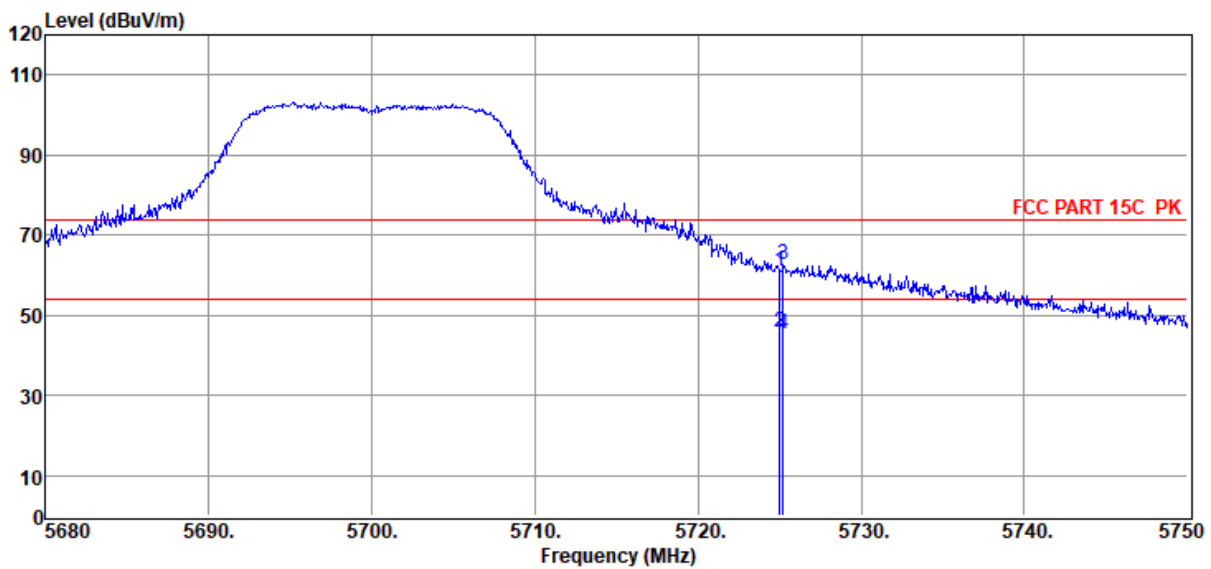

Item (Mark)	Freq. (MHz)	Read Level (dBuV)	Antenna Factor (dB/m)	PRM Factor dB	Cable Loss dB	Filter Factor dB	Result Level (dBuV/m)	Limit Line (dBuV/m)	Over Limit (dB)	Detector	Polarization
1	5725.01	64.28	33.34	40.47	2.78	1.08	61.01	74.00	-12.99	Peak	HORIZONTAL
2	5725.01	48.94	33.34	40.47	2.78	1.08	45.67	54.00	-8.33	Average	HORIZONTAL
3	5725.22	65.76	33.34	40.47	2.78	1.08	62.49	74.00	-11.51	Peak	HORIZONTAL
4	5725.22	48.78	33.34	40.47	2.78	1.08	45.51	54.00	-8.49	Average	HORIZONTAL

Note: 1. Result Level = Read Level + Antenna Factor + Cable loss + Filter Factor - PRM Factor.
 2. If Peak Result complies with AV limit, AV Result is deemed to comply with AV limit.
 3. Test setup: RBW: 1 MHz, VBW: 3 MHz, Sweep time: auto.

TR-4-E-009 Radiated Emission Test Result

Test Site : DDT 3m Chamber 3# D:\E3 6.111\2022 Report Data\Q22062203-2E UCS15\FCC ABOVE 1G 5G.EM6
Test Date : 2022-08-24 **Tested By** : Bairong
EUT : Integrated video conference terminal **Model Number** : UC S15
Power Supply : AC 120V/60Hz **Test Mode** : Tx Mode
Condition : Temp:23.1°C,Humi:51.5%,Press:100.3kPa **Antenna/Distance** : 2021 BBHA 9120D 3#/3m/VERTICAL
Memo : 11A 5700 Power:默认

Data: 92

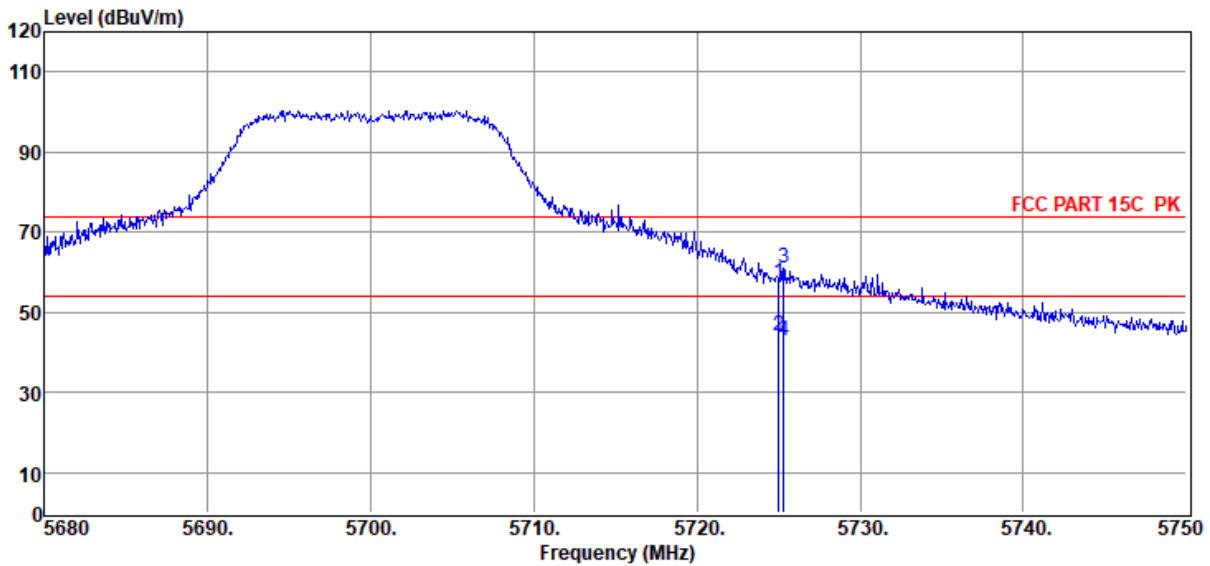

Item (Mark)	Freq. (MHz)	Read Level (dBuV)	Antenna Factor (dB/m)	PRM Factor (dB)	Cable Loss (dB)	Filter Factor (dB)	Result Level (dBuV/m)	Limit Line (dBuV/m)	Over Limit (dB)	Detector	Polarization
1	5725.01	60.54	33.34	40.47	2.78	1.08	57.27	74.00	-16.73	Peak	VERTICAL
2	5725.01	47.57	33.34	40.47	2.78	1.08	44.30	54.00	-9.70	Average	VERTICAL
3	5725.29	64.50	33.34	40.47	2.78	1.08	61.23	74.00	-12.77	Peak	VERTICAL
4	5725.29	46.04	33.34	40.47	2.78	1.08	42.77	54.00	-11.23	Average	VERTICAL

Note: 1. Result Level = Read Level + Antenna Factor + Cable loss + Filter Factor - PRM Factor.
 2. If Peak Result complies with AV limit, AV Result is deemed to comply with AV limit.
 3. Test setup: RBW: 1 MHz, VBW: 3 MHz, Sweep time: auto.

TR-4-E-009 Radiated Emission Test Result

Test Site : DDT 3m Chamber 3# D:\E3 6.111\2022 Report Data\Q22062203-2E UCS15\FCC ABOVE 1G 5G.EM6
Test Date : 2022-08-24 **Tested By** : Bairong
EUT : Integrated video conference terminal **Model Number** : UC S15
Power Supply : AC 120V/60Hz **Test Mode** : Tx Mode
Condition : Temp:23.1°C,Humi:51.5%,Press:100.3kPa **Antenna/Distance** : 2021 BBHA 9120D
3#/3m/HORIZONTAL
Memo : 11N20 5700 Power:默认

Data: 93

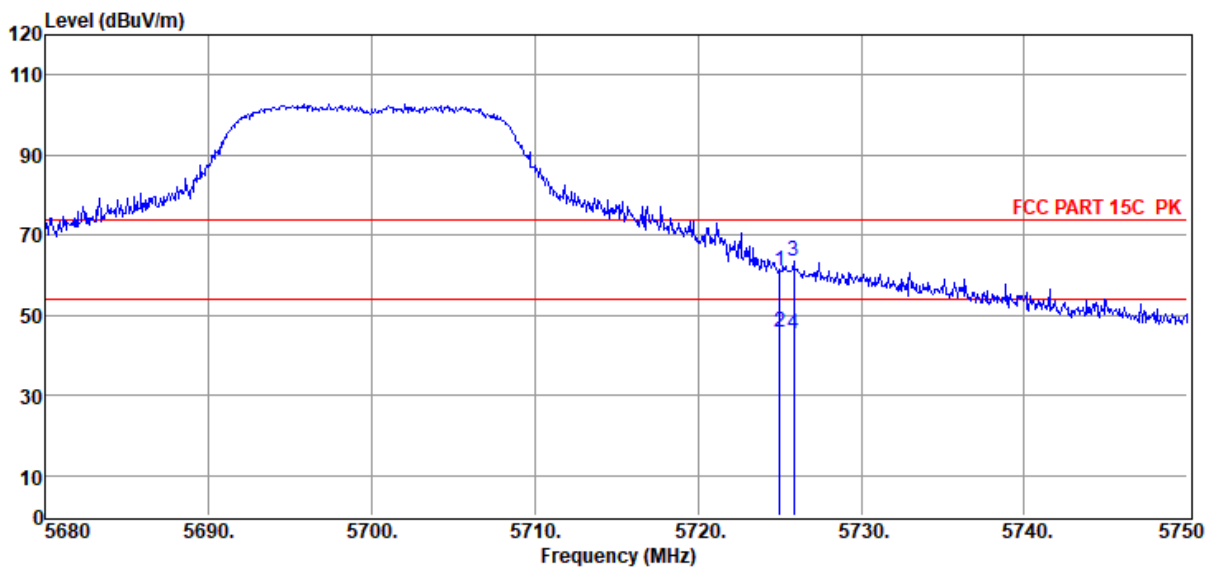

Item (Mark)	Freq. (MHz)	Read Level (dBuV)	Antenna Factor (dB/m)	PRM Factor (dB)	Cable Loss (dB)	Filter Factor (dB)	Result Level (dBuV/m)	Limit Line (dBuV/m)	Over Limit (dB)	Detector	Polarization
1	5725.01	64.33	33.34	40.47	2.78	1.08	61.06	74.00	-12.94	Peak	HORIZONTAL
2	5725.01	49.02	33.34	40.47	2.78	1.08	45.75	54.00	-8.25	Average	HORIZONTAL
3	5725.85	66.59	33.34	40.47	2.78	1.08	63.32	74.00	-10.68	Peak	HORIZONTAL
4	5725.85	48.50	33.34	40.47	2.78	1.08	45.23	54.00	-8.77	Average	HORIZONTAL

Note: 1. Result Level = Read Level + Antenna Factor + Cable loss + Filter Factor - PRM Factor.
 2. If Peak Result complies with AV limit, AV Result is deemed to comply with AV limit.
 3. Test setup: RBW: 1 MHz, VBW: 3 MHz, Sweep time: auto.

TR-4-E-009 Radiated Emission Test Result

Test Site : DDT 3m Chamber 3# D:\E3 6.111\2022 Report Data\Q22062203-2E UCS15\FCC ABOVE 1G 5G.EM6
Test Date : 2022-08-24 **Tested By** : Bairong
EUT : Integrated video conference terminal **Model Number** : UC S15
Power Supply : AC 120V/60Hz **Test Mode** : Tx Mode
Condition : Temp:23.1°C,Humi:51.5%,Press:100.3kPa **Antenna/Distance** : 2021 BBHA 9120D 3#/3m/VERTICAL
Memo : 11N20 5700 Power:默认

Data: 94

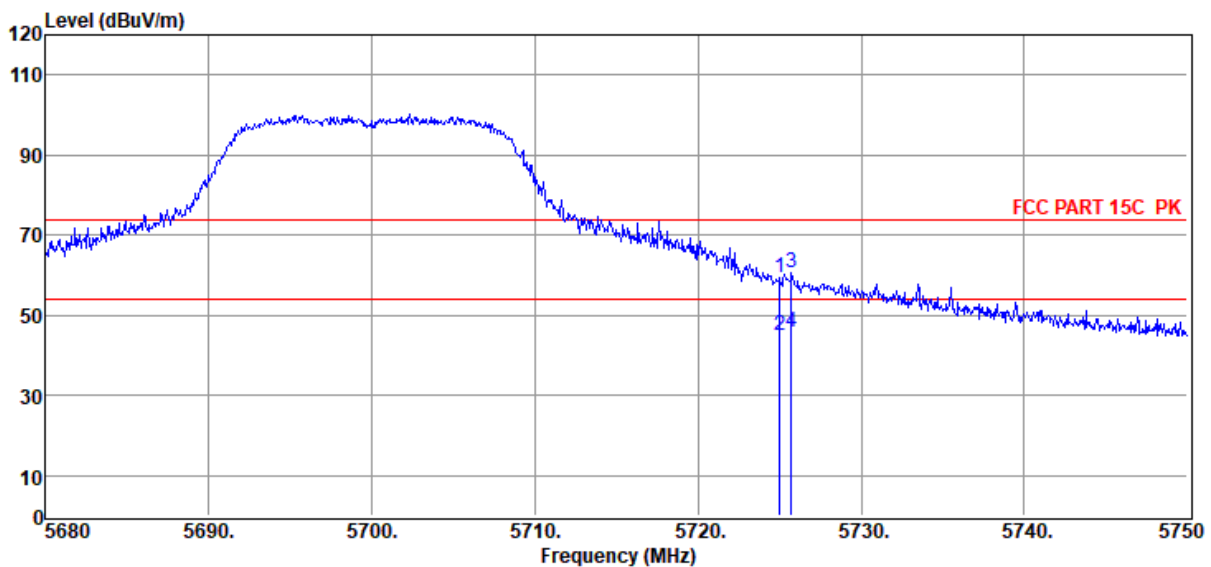

Item (Mark)	Freq. (MHz)	Read Level (dBuV)	Antenna Factor (dB/m)	PRM Factor (dB)	Cable Loss (dB)	Filter Factor (dB)	Result Level (dBuV/m)	Limit Line (dBuV/m)	Over Limit (dB)	Detector	Polarization
1	5725.01	62.49	33.34	40.47	2.78	1.08	59.22	74.00	-14.78	Peak	VERTICAL
2	5725.01	48.42	33.34	40.47	2.78	1.08	45.15	54.00	-8.85	Average	VERTICAL
3	5725.71	63.89	33.34	40.47	2.78	1.08	60.62	74.00	-13.38	Peak	VERTICAL
4	5725.71	48.87	33.34	40.47	2.78	1.08	45.60	54.00	-8.40	Average	VERTICAL

Note: 1. Result Level = Read Level + Antenna Factor + Cable loss + Filter Factor - PRM Factor.
 2. If Peak Result complies with AV limit, AV Result is deemed to comply with AV limit.
 3. Test setup: RBW: 1 MHz, VBW: 3 MHz, Sweep time: auto.

TR-4-E-009 Radiated Emission Test Result

Test Site : DDT 3m Chamber 3# D:\E3 6.111\2022 Report Data\Q22062203-2E UCS15\FCC ABOVE 1G 5G.EM6
Test Date : 2022-08-24 **Tested By** : Bairong
EUT : Integrated video conference terminal **Model Number** : UC S15
Power Supply : AC 120V/60Hz **Test Mode** : Tx Mode
Condition : Temp:23.1°C,Humi:51.5%,Press:100.3kPa **Antenna/Distance** : 2021 BBHA 9120D
3#/3m/HORIZONTAL
Memo : 11AX20 5700 Power:默认

Data: 97

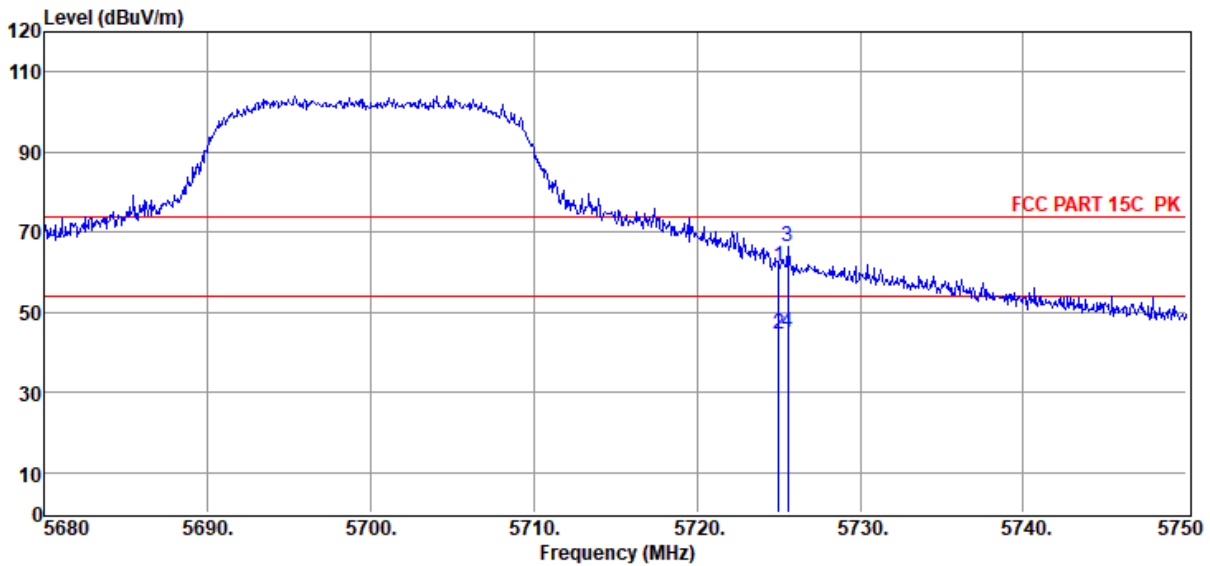

Item (Mark)	Freq. (MHz)	Read Level (dBuV)	Antenna Factor (dB/m)	PRM Factor dB	Cable Loss dB	Filter Factor dB	Result Level (dBuV/m)	Limit Line (dBuV/m)	Over Limit (dB)	Detector	Polarization
1	5725.01	64.66	33.34	40.47	2.78	1.08	61.39	74.00	-12.61	Peak	HORIZONTAL
2	5725.01	47.74	33.34	40.47	2.78	1.08	44.47	54.00	-9.53	Average	HORIZONTAL
3	5725.57	69.70	33.34	40.47	2.78	1.08	66.43	74.00	-7.57	Peak	HORIZONTAL
4	5725.57	48.16	33.34	40.47	2.78	1.08	44.89	54.00	-9.11	Average	HORIZONTAL

Note: 1. Result Level = Read Level + Antenna Factor + Cable loss + Filter Factor - PRM Factor.
 2. If Peak Result complies with AV limit, AV Result is deemed to comply with AV limit.
 3. Test setup: RBW: 1 MHz, VBW: 3 MHz, Sweep time: auto.

TR-4-E-009 Radiated Emission Test Result

Test Site : DDT 3m Chamber 3# D:\E3 6.111\2022 Report Data\Q22062203-2E UCS15\FCC ABOVE 1G 5G.EM6
Test Date : 2022-08-24 **Tested By** : Bairong
EUT : Integrated video conference terminal **Model Number** : UC S15
Power Supply : AC 120V/60Hz **Test Mode** : Tx Mode
Condition : Temp:23.1°C,Humi:51.5%,Press:100.3kPa **Antenna/Distance** : 2021 BBHA 9120D 3#/3m/VERTICAL
Memo : 11AX20 5700 Power:默认

Data: 98

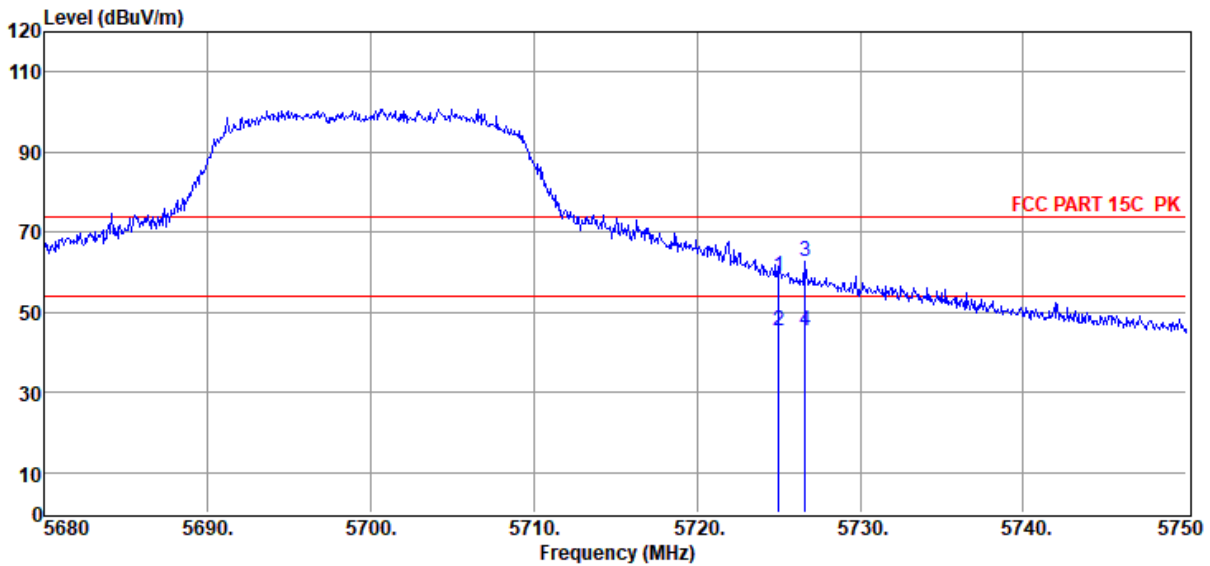

Item (Mark)	Freq. (MHz)	Read Level (dBuV)	Antenna Factor (dB/m)	PRM Factor (dB)	Cable Loss (dB)	Filter Factor (dB)	Result Level (dBuV/m)	Limit Line (dBuV/m)	Over Limit (dB)	Detector	Polarization
1	5725.01	62.12	33.34	40.47	2.78	1.08	58.85	74.00	-15.15	Peak	VERTICAL
2	5725.01	48.67	33.34	40.47	2.78	1.08	45.40	54.00	-8.60	Average	VERTICAL
3	5726.62	65.80	33.34	40.47	2.78	1.08	62.53	74.00	-11.47	Peak	VERTICAL
4	5726.62	48.75	33.34	40.47	2.78	1.08	45.48	54.00	-8.52	Average	VERTICAL

Note: 1. Result Level = Read Level + Antenna Factor + Cable loss + Filter Factor - PRM Factor.
 2. If Peak Result complies with AV limit, AV Result is deemed to comply with AV limit.
 3. Test setup: RBW: 1 MHz, VBW: 3 MHz, Sweep time: auto.

TR-4-E-009 Radiated Emission Test Result

Test Site : DDT 3m Chamber 3# D:\E3 6.111\2022 Report Data\Q22062203-2E UCS15\FCC ABOVE 1G 5G.EM6
Test Date : 2022-08-24 **Tested By** : Bairong
EUT : Integrated video conference terminal **Model Number** : UC S15
Power Supply : AC 120V/60Hz **Test Mode** : Tx Mode
Condition : Temp:23.1°C,Humi:51.5%,Press:100.3kPa **Antenna/Distance** : 2021 BBHA 9120D
3#/3m/HORIZONTAL
Memo : 11N40 5190 Power:默认

Data: 99

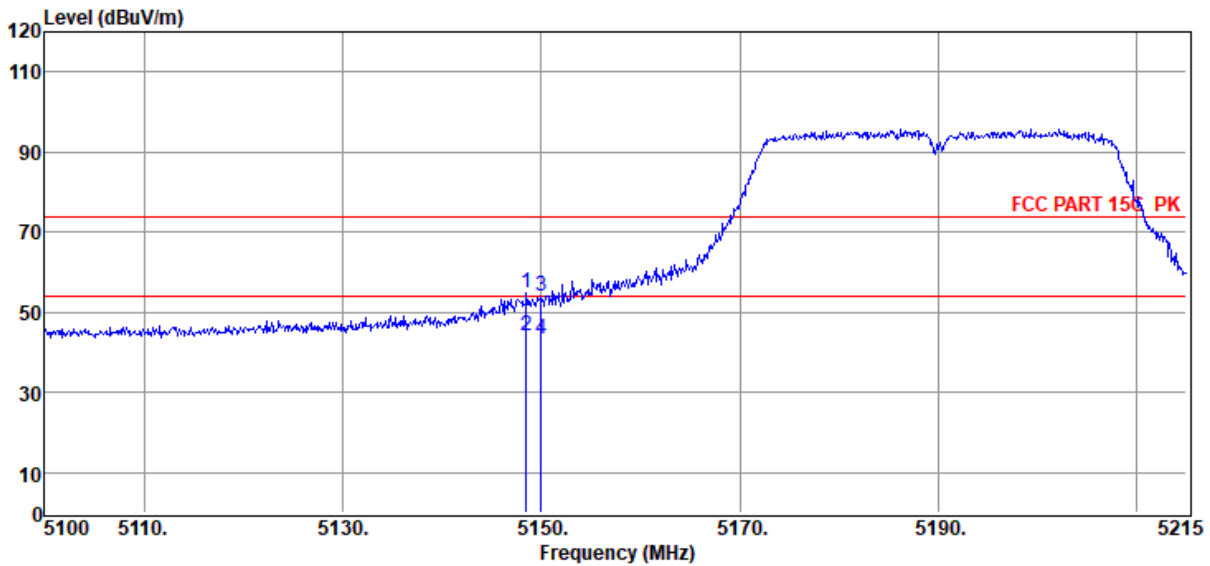

Item (Mark)	Freq. (MHz)	Read Level (dBuV)	Antenna Factor (dB/m)	PRM Factor dB	Cable Loss dB	Filter Factor dB	Result Level (dBuV/m)	Limit Line (dBuV/m)	Over Limit (dB)	Detector	Polarization
1	5148.53	58.91	33.01	40.41	2.55	0.94	55.00	74.00	-19.00	Peak	HORIZONTAL
2	5148.53	47.93	33.01	40.41	2.55	0.94	44.02	54.00	-9.98	Average	HORIZONTAL
3	5150.03	58.13	33.01	40.42	2.55	0.94	54.21	74.00	-19.79	Peak	HORIZONTAL
4	5150.03	47.16	33.01	40.42	2.55	0.94	43.24	54.00	-10.76	Average	HORIZONTAL

Note: 1. Result Level = Read Level + Antenna Factor + Cable loss + Filter Factor - PRM Factor.
 2. If Peak Result complies with AV limit, AV Result is deemed to comply with AV limit.
 3. Test setup: RBW: 1 MHz, VBW: 3 MHz, Sweep time: auto.

TR-4-E-009 Radiated Emission Test Result

Test Site : DDT 3m Chamber 3# D:\E3 6.111\2022 Report Data\Q22062203-2E UCS15\FCC ABOVE 1G 5G.EM6
Test Date : 2022-08-24 **Tested By** : Bairong
EUT : Integrated video conference terminal **Model Number** : UC S15
Power Supply : AC 120V/60Hz **Test Mode** : Tx Mode
Condition : Temp:23.1°C,Humi:51.5%,Press:100.3kPa **Antenna/Distance** : 2021 BBHA 9120D 3#/3m/VERTICAL
Memo : 11N40 5190 Power:默认

Data: 100

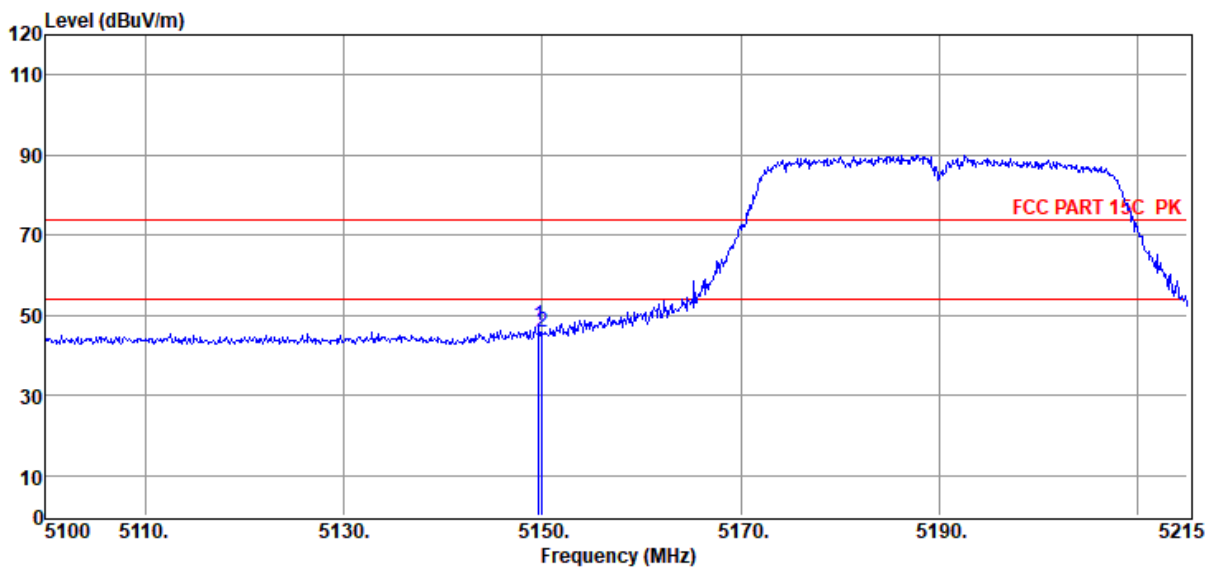

Item (Mark)	Freq. (MHz)	Read Level (dBuV)	Antenna Factor (dB/m)	PRM Factor dB	Cable Loss dB	Filter Factor dB	Result Level (dBuV/m)	Limit Line (dBuV/m)	Over Limit (dB)	Detector	Polarization
1	5149.68	51.28	33.01	40.41	2.55	0.94	47.37	74.00	-26.63	Peak	VERTICAL
2	5150.03	49.76	33.01	40.42	2.55	0.94	45.84	74.00	-28.16	Peak	VERTICAL

Note: 1. Result Level = Read Level + Antenna Factor + Cable loss + Filter Factor - PRM Factor.
 2. If Peak Result complies with AV limit, AV Result is deemed to comply with AV limit.
 3. Test setup: RBW: 1 MHz, VBW: 3 MHz, Sweep time: auto.

TR-4-E-009 Radiated Emission Test Result

Test Site : DDT 3m Chamber 3# D:\E3 6.111\2022 Report Data\Q22062203-2E UCS15\FCC ABOVE 1G 5G.EM6
Test Date : 2022-08-25 **Tested By** : Bairong
EUT : Integrated video conference terminal **Model Number** : UC S15
Power Supply : AC 120V/60Hz **Test Mode** : Tx Mode
Condition : Temp:23.1°C,Humi:51.5%,Press:100.3kPa **Antenna/Distance** : 2021 BBHA 9120D
3#/3m/HORIZONTAL
Memo : 11AX40 5190 Power:默认

Data: 103

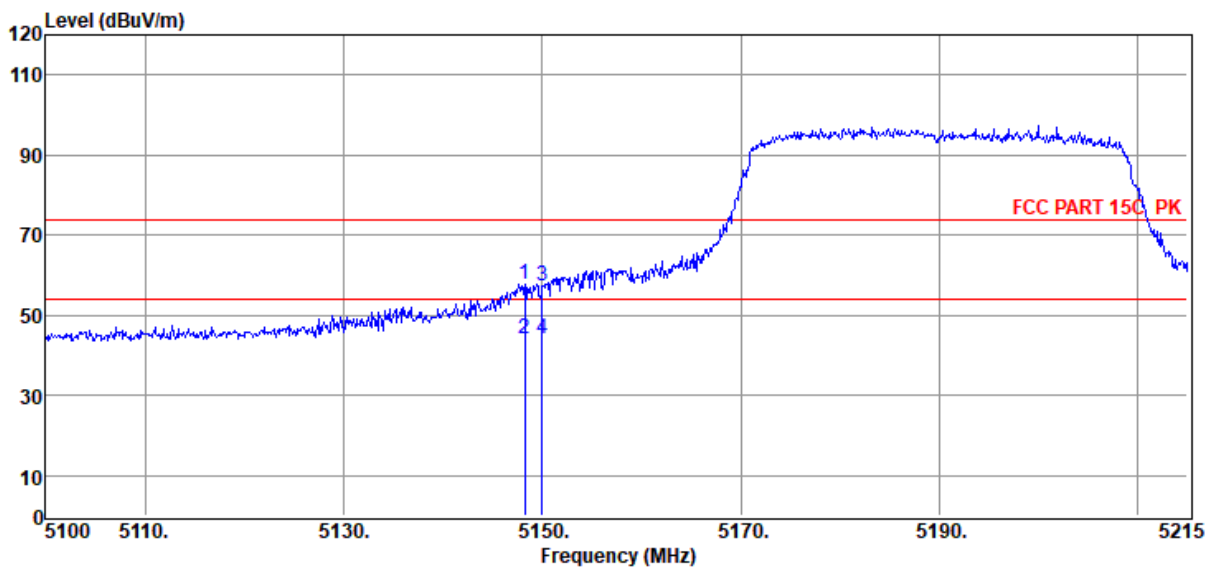

Item (Mark)	Freq. (MHz)	Read Level (dBuV)	Antenna Factor (dB/m)	PRM Factor dB	Cable Loss dB	Filter Factor dB	Result Level (dBuV/m)	Limit Line (dBuV/m)	Over Limit (dB)	Detector	Polarization
1	5148.30	61.68	33.01	40.41	2.55	0.94	57.77	74.00	-16.23	Peak	HORIZONTAL
2	5148.30	47.91	33.01	40.41	2.55	0.94	44.00	54.00	-10.00	Average	HORIZONTAL
3	5150.03	61.29	33.01	40.42	2.55	0.94	57.37	74.00	-16.63	Peak	HORIZONTAL
4	5150.03	48.03	33.01	40.42	2.55	0.94	44.11	54.00	-9.89	Average	HORIZONTAL

Note: 1. Result Level = Read Level + Antenna Factor + Cable loss + Filter Factor - PRM Factor.
 2. If Peak Result complies with AV limit, AV Result is deemed to comply with AV limit.
 3. Test setup: RBW: 1 MHz, VBW: 3 MHz, Sweep time: auto.

TR-4-E-009 Radiated Emission Test Result

Test Site : DDT 3m Chamber 3# D:\E3 6.111\2022 Report Data\Q22062203-2E UCS15\FCC ABOVE 1G 5G.EM6
Test Date : 2022-08-25 **Tested By** : Bairong
EUT : Integrated video conference terminal **Model Number** : UC S15
Power Supply : AC 120V/60Hz **Test Mode** : Tx Mode
Condition : Temp:23.1°C,Humi:51.5%,Press:100.3kPa **Antenna/Distance** : 2021 BBHA 9120D 3#/3m/VERTICAL
Memo : 11AX40 5190 Power:默认

Data: 104

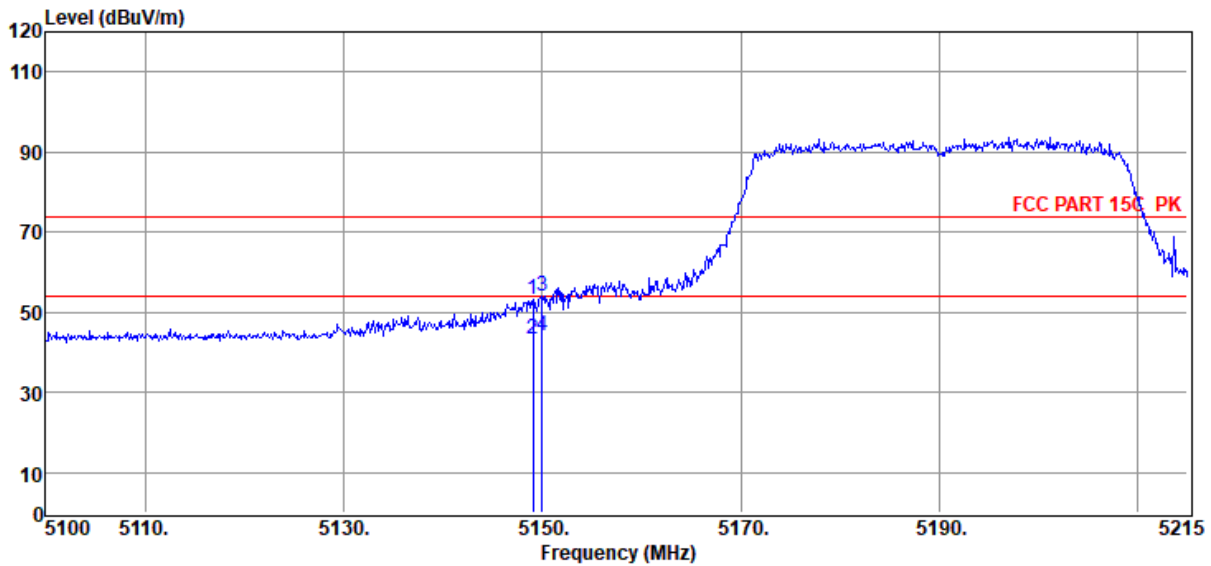

Item (Mark)	Freq. (MHz)	Read Level (dBuV)	Antenna Factor (dB/m)	PRM Factor dB	Cable Loss dB	Filter Factor dB	Result Level (dBuV/m)	Limit Line (dBuV/m)	Over Limit (dB)	Detector	Polarization
1	5149.11	57.23	33.01	40.41	2.55	0.94	53.32	74.00	-20.68	Peak	VERTICAL
2	5149.11	47.17	33.01	40.41	2.55	0.94	43.26	54.00	-10.74	Average	VERTICAL
3	5150.03	58.06	33.01	40.42	2.55	0.94	54.14	74.00	-19.86	Peak	VERTICAL
4	5150.03	47.91	33.01	40.42	2.55	0.94	43.99	54.00	-10.01	Average	VERTICAL

Note: 1. Result Level = Read Level + Antenna Factor + Cable loss + Filter Factor - PRM Factor.
 2. If Peak Result complies with AV limit, AV Result is deemed to comply with AV limit.
 3. Test setup: RBW: 1 MHz, VBW: 3 MHz, Sweep time: auto.

TR-4-E-009 Radiated Emission Test Result

Test Site : DDT 3m Chamber 3# D:\E3 6.111\2022 Report Data\Q22062203-2E UCS15\FCC ABOVE 1G 5G.EM6
Test Date : 2022-08-25 **Tested By** : Bairong
EUT : Integrated video conference terminal **Model Number** : UC S15
Power Supply : AC 120V/60Hz **Test Mode** : Tx Mode
Condition : Temp:23.1°C,Humi:51.5%,Press:100.3kPa **Antenna/Distance** : 2021 BBHA 9120D
3#/3m/HORIZONTAL
Memo : 11N40 5310 Power:默认

Data: 105

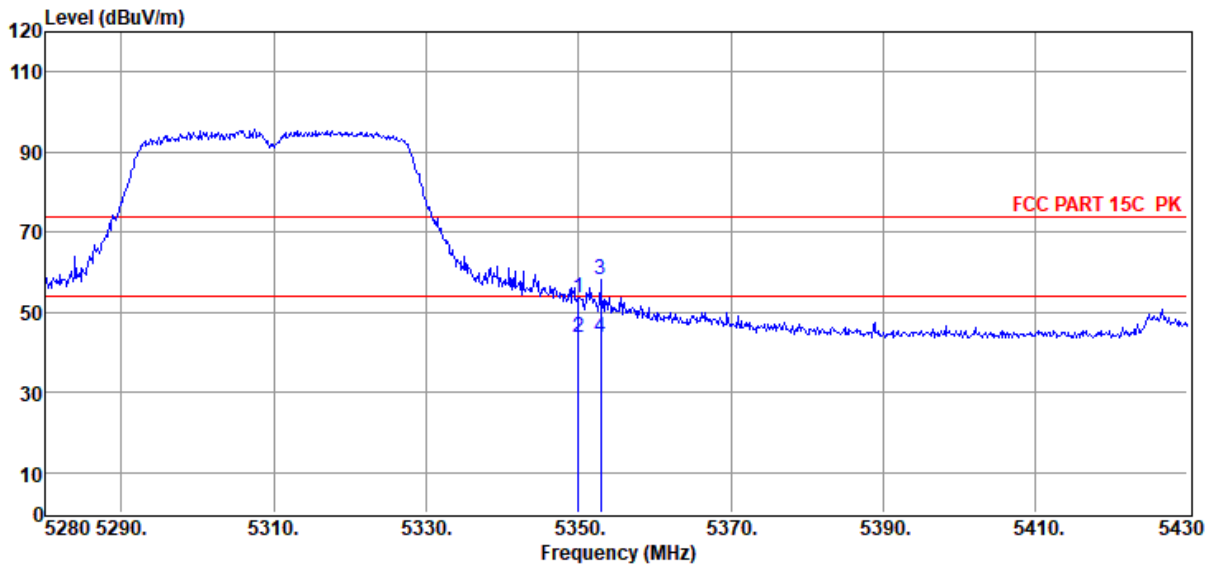

Item (Mark)	Freq. (MHz)	Read Level (dBuV)	Antenna Factor (dB/m)	PRM Factor dB	Cable Loss dB	Filter Factor dB	Result Level (dBuV/m)	Limit Line (dBuV/m)	Over Limit (dB)	Detector	Polarization
1	5350.05	57.51	32.89	40.44	2.56	0.99	53.51	74.00	-20.49	Peak	HORIZONTAL
2	5350.05	47.54	32.89	40.44	2.56	0.99	43.54	54.00	-10.46	Average	HORIZONTAL
3	5352.90	62.04	32.89	40.44	2.56	0.99	58.04	74.00	-15.96	Peak	HORIZONTAL
4	5352.90	47.65	32.89	40.44	2.56	0.99	43.65	54.00	-10.35	Average	HORIZONTAL

Note: 1. Result Level = Read Level + Antenna Factor + Cable loss + Filter Factor - PRM Factor.
 2. If Peak Result complies with AV limit, AV Result is deemed to comply with AV limit.
 3. Test setup: RBW: 1 MHz, VBW: 3 MHz, Sweep time: auto.

TR-4-E-009 Radiated Emission Test Result

Test Site : DDT 3m Chamber 3# D:\E3 6.111\2022 Report Data\Q22062203-2E UCS15\FCC ABOVE 1G 5G.EM6
Test Date : 2022-08-25 **Tested By** : Bairong
EUT : Integrated video conference terminal **Model Number** : UC S15
Power Supply : AC 120V/60Hz **Test Mode** : Tx Mode
Condition : Temp:23.1°C,Humi:51.5%,Press:100.3kPa **Antenna/Distance** : 2021 BBHA 9120D 3#/3m/VERTICAL
Memo : 11N40 5310 Power:默认

Data: 106

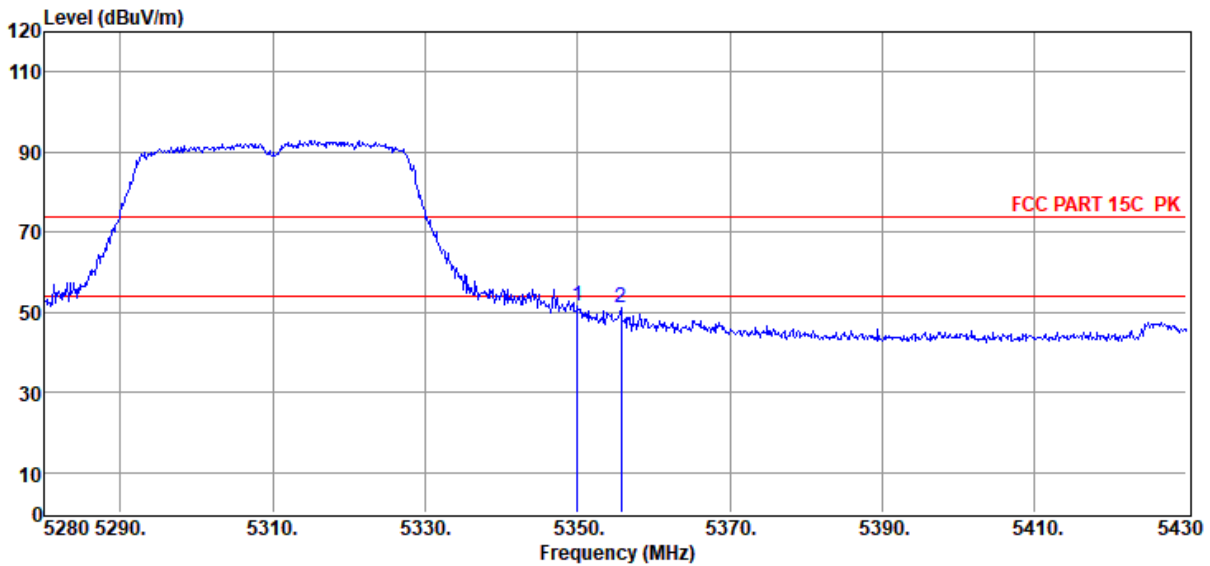

Item (Mark)	Freq. (MHz)	Read Level (dBuV)	Antenna Factor (dB/m)	PRM Factor dB	Cable Loss dB	Filter Factor dB	Result Level (dBuV/m)	Limit Line (dBuV/m)	Over Limit (dB)	Detector	Polarization
1	5350.05	55.36	32.89	40.44	2.56	0.99	51.36	74.00	-22.64	Peak	VERTICAL
2	5355.75	55.08	32.89	40.44	2.56	0.99	51.08	74.00	-22.92	Peak	VERTICAL

Note: 1. Result Level = Read Level + Antenna Factor + Cable loss + Filter Factor - PRM Factor.
 2. If Peak Result complies with AV limit, AV Result is deemed to comply with AV limit.
 3. Test setup: RBW: 1 MHz, VBW: 3 MHz, Sweep time: auto.

TR-4-E-009 Radiated Emission Test Result

Test Site : DDT 3m Chamber 3# D:\E3 6.111\2022 Report Data\Q22062203-2E UCS15\FCC ABOVE 1G 5G.EM6
Test Date : 2022-08-25 **Tested By** : Bairong
EUT : Integrated video conference terminal **Model Number** : UC S15
Power Supply : AC 120V/60Hz **Test Mode** : Tx Mode
Condition : Temp:23.1°C,Humi:51.5%,Press:100.3kPa **Antenna/Distance** : 2021 BBHA 9120D
3#/3m/HORIZONTAL
Memo : 11AX40 5310 Power:默认

Data: 109

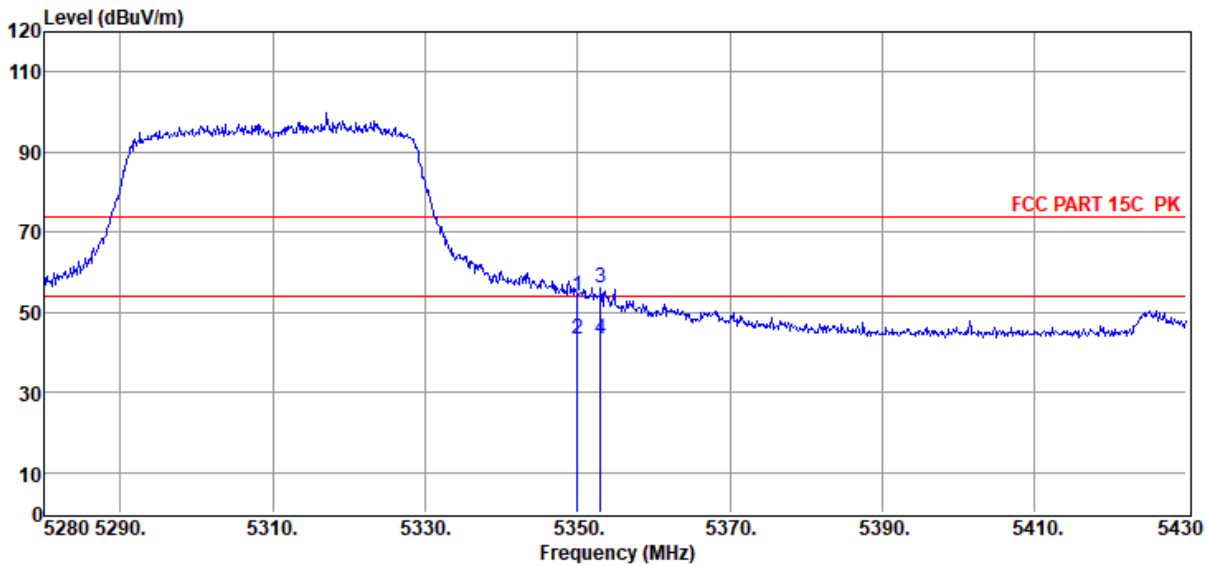

Item (Mark)	Freq. (MHz)	Read Level (dBuV)	Antenna Factor (dB/m)	PRM Factor dB	Cable Loss dB	Filter Factor dB	Result Level (dBuV/m)	Limit Line (dBuV/m)	Over Limit (dB)	Detector	Polarization
1	5350.05	58.19	32.89	40.44	2.56	0.99	54.19	74.00	-19.81	Peak	HORIZONTAL
2	5350.05	47.31	32.89	40.44	2.56	0.99	43.31	54.00	-10.69	Average	HORIZONTAL
3	5353.05	60.07	32.89	40.44	2.56	0.99	56.07	74.00	-17.93	Peak	HORIZONTAL
4	5353.05	47.10	32.89	40.44	2.56	0.99	43.10	54.00	-10.90	Average	HORIZONTAL

Note: 1. Result Level = Read Level + Antenna Factor + Cable loss + Filter Factor - PRM Factor.
 2. If Peak Result complies with AV limit, AV Result is deemed to comply with AV limit.
 3. Test setup: RBW: 1 MHz, VBW: 3 MHz, Sweep time: auto.

TR-4-E-009 Radiated Emission Test Result

Test Site : DDT 3m Chamber 3# D:\E3 6.111\2022 Report Data\Q22062203-2E UCS15\FCC ABOVE 1G 5G.EM6
Test Date : 2022-08-25 **Tested By** : Bairong
EUT : Integrated video conference terminal **Model Number** : UC S15
Power Supply : AC 120V/60Hz **Test Mode** : Tx Mode
Condition : Temp:23.1°C,Humi:51.5%,Press:100.3kPa **Antenna/Distance** : 2021 BBHA 9120D 3#/3m/VERTICAL
Memo : 11AX40 5310 Power:默认

Data: 110

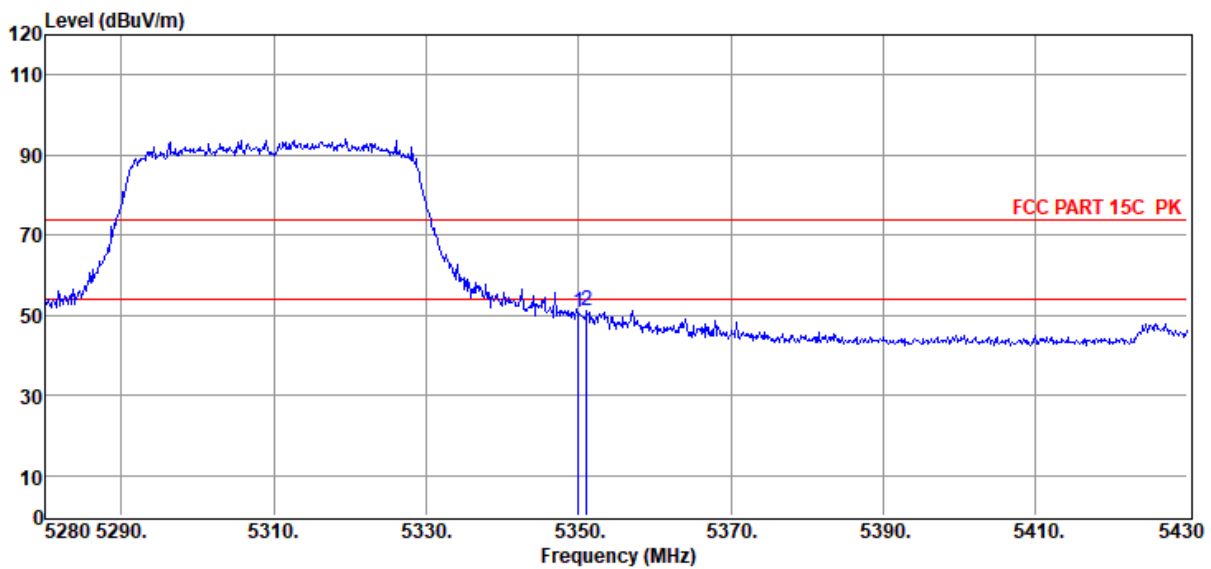

Item (Mark)	Freq. (MHz)	Read Level (dBuV)	Antenna Factor (dB/m)	PRM Factor dB	Cable Loss dB	Filter Factor dB	Result Level (dBuV/m)	Limit Line (dBuV/m)	Over Limit (dB)	Detector	Polarization
1	5350.05	54.91	32.89	40.44	2.56	0.99	50.91	74.00	-23.09	Peak	VERTICAL
2	5351.10	55.33	32.89	40.44	2.56	0.99	51.33	74.00	-22.67	Peak	VERTICAL

Note: 1. Result Level = Read Level + Antenna Factor + Cable loss + Filter Factor - PRM Factor.
 2. If Peak Result complies with AV limit, AV Result is deemed to comply with AV limit.
 3. Test setup: RBW: 1 MHz, VBW: 3 MHz, Sweep time: auto.

TR-4-E-009 Radiated Emission Test Result

Test Site : DDT 3m Chamber 3# D:\E3 6.111\2022 Report Data\Q22062203-2E UCS15\FCC ABOVE 1G 5G.EM6
Test Date : 2022-08-25 **Tested By** : Bairong
EUT : Integrated video conference terminal **Model Number** : UC S15
Power Supply : AC 120V/60Hz **Test Mode** : Tx Mode
Condition : Temp:23.1°C,Humi:51.5%,Press:100.3kPa **Antenna/Distance** : 2021 BBHA 9120D
3#/3m/HORIZONTAL
Memo : 11N40 5510 Power:默认

Data: 111

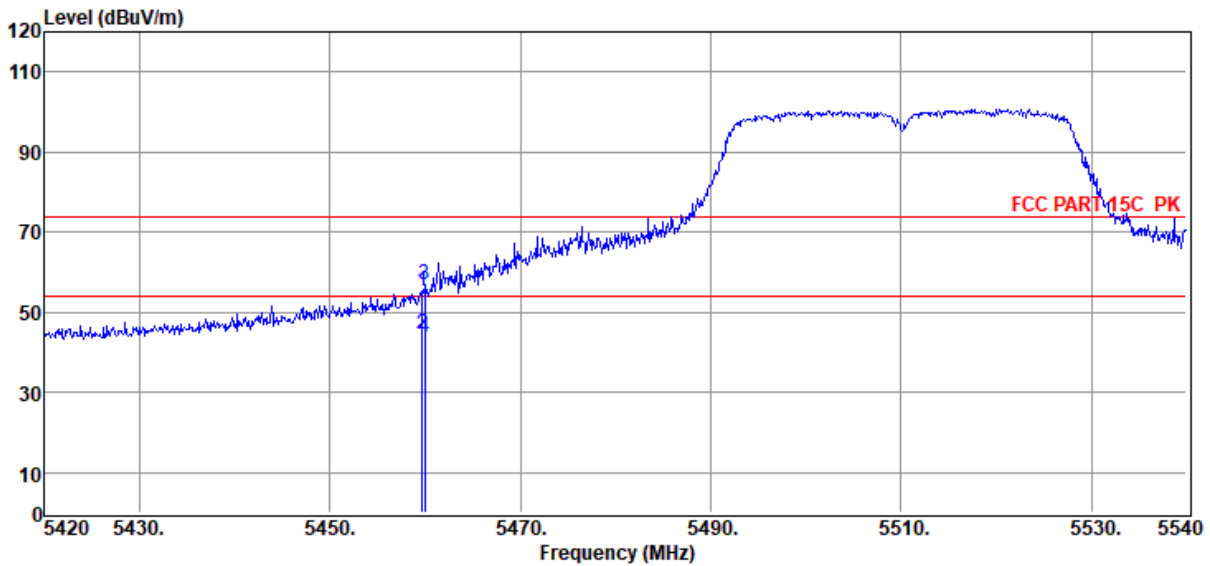

Item (Mark)	Freq. (MHz)	Read Level (dBuV)	Antenna Factor (dB/m)	PRM Factor (dB)	Cable Loss (dB)	Filter Factor (dB)	Result Level (dBuV/m)	Limit Line (dBuV/m)	Over Limit (dB)	Detector	Polarization
1	5459.72	59.42	32.82	40.45	2.57	1.02	55.38	74.00	-18.62	Peak	HORIZONTAL
2	5459.72	48.72	32.82	40.45	2.57	1.02	44.68	54.00	-9.32	Average	HORIZONTAL
3	5459.96	60.78	32.82	40.45	2.57	1.02	56.74	74.00	-17.26	Peak	HORIZONTAL
4	5459.96	47.70	32.82	40.45	2.57	1.02	43.66	54.00	-10.34	Average	HORIZONTAL

Note: 1. Result Level = Read Level + Antenna Factor + Cable loss + Filter Factor - PRM Factor.
 2. If Peak Result complies with AV limit, AV Result is deemed to comply with AV limit.
 3. Test setup: RBW: 1 MHz, VBW: 3 MHz, Sweep time: auto.

TR-4-E-009 Radiated Emission Test Result

Test Site : DDT 3m Chamber 3# D:\E3 6.111\2022 Report Data\Q22062203-2E UCS15\FCC ABOVE 1G 5G.EM6
Test Date : 2022-08-25 **Tested By** : Bairong
EUT : Integrated video conference terminal **Model Number** : UC S15
Power Supply : AC 120V/60Hz **Test Mode** : Tx Mode
Condition : Temp:23.1°C,Humi:51.5%,Press:100.3kPa **Antenna/Distance** : 2021 BBHA 9120D 3#/3m/VERTICAL
Memo : 11N40 5510 Power:默认

Data: 112

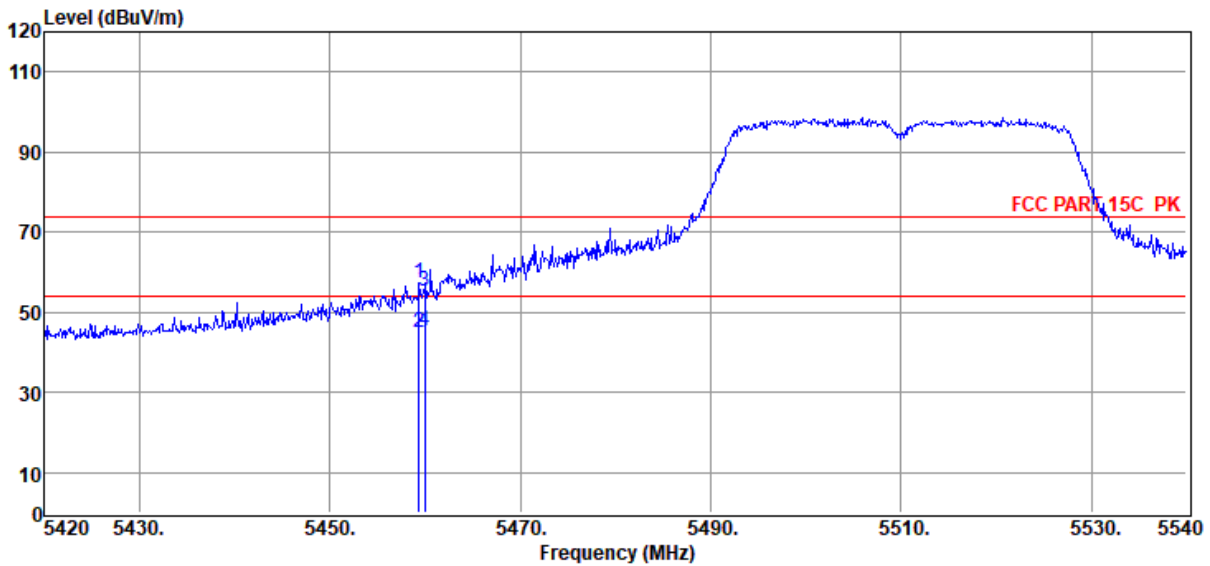

Item (Mark)	Freq. (MHz)	Read Level (dBuV)	Antenna Factor (dB/m)	PRM Factor (dB)	Cable Loss (dB)	Filter Factor (dB)	Result Level (dBuV/m)	Limit Line (dBuV/m)	Over Limit (dB)	Detector	Polarization
1	5459.36	61.19	32.82	40.45	2.57	1.02	57.15	74.00	-16.85	Peak	VERTICAL
2	5459.36	48.87	32.82	40.45	2.57	1.02	44.83	54.00	-9.17	Average	VERTICAL
3	5459.96	59.20	32.82	40.45	2.57	1.02	55.16	74.00	-18.84	Peak	VERTICAL
4	5459.96	49.48	32.82	40.45	2.57	1.02	45.44	54.00	-8.56	Average	VERTICAL

Note: 1. Result Level = Read Level + Antenna Factor + Cable loss + Filter Factor - PRM Factor.
 2. If Peak Result complies with AV limit, AV Result is deemed to comply with AV limit.
 3. Test setup: RBW: 1 MHz, VBW: 3 MHz, Sweep time: auto.

TR-4-E-009 Radiated Emission Test Result

Test Site : DDT 3m Chamber 3# D:\E3 6.111\2022 Report Data\Q22062203-2E UCS15\FCC ABOVE 1G 5G.EM6
Test Date : 2022-08-26 **Tested By** : Bairong
EUT : Integrated video conference terminal **Model Number** : UC S15
Power Supply : AC 120V/60Hz **Test Mode** : Tx Mode
Condition : Temp:23.1°C,Humi:51.5%,Press:100.3kPa **Antenna/Distance** : 2021 BBHA 9120D
3#/3m/HORIZONTAL
Memo : 11AX40 5510 Power:默认

Data: 115

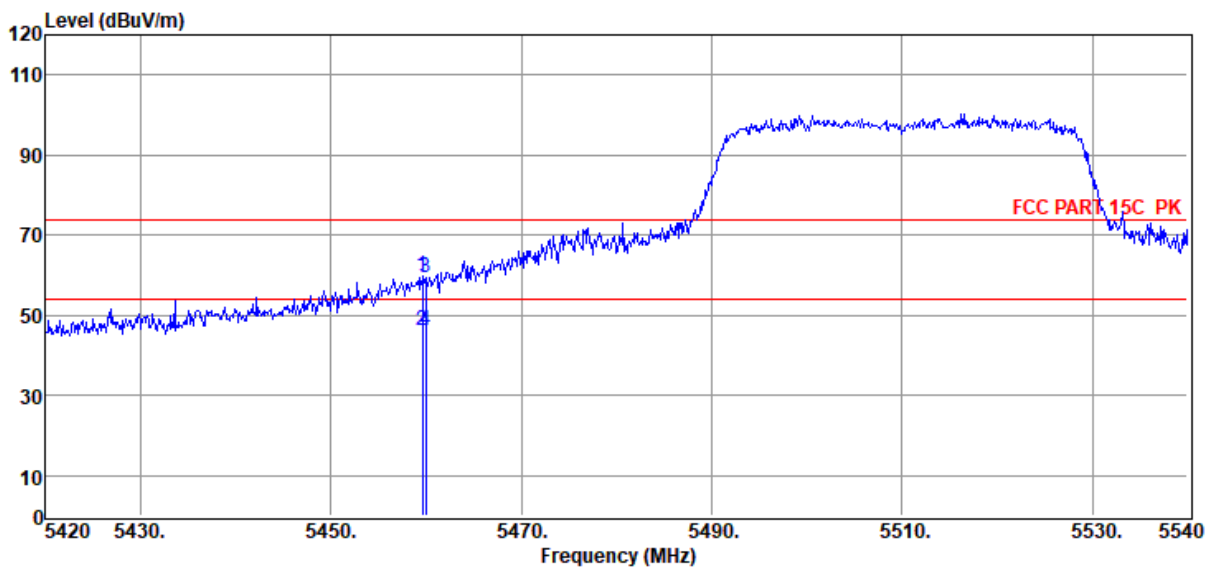

Item (Mark)	Freq. (MHz)	Read Level (dBuV)	Antenna Factor (dB/m)	PRM Factor (dB)	Cable Loss (dB)	Filter Factor (dB)	Result Level (dBuV/m)	Limit Line (dBuV/m)	Over Limit (dB)	Detector	Polarization
1	5459.60	63.64	32.82	40.45	2.57	1.02	59.60	74.00	-14.40	Peak	HORIZONTAL
2	5459.60	50.28	32.82	40.45	2.57	1.02	46.24	54.00	-7.76	Average	HORIZONTAL
3	5459.96	63.23	32.82	40.45	2.57	1.02	59.19	74.00	-14.81	Peak	HORIZONTAL
4	5459.96	50.31	32.82	40.45	2.57	1.02	46.27	54.00	-7.73	Average	HORIZONTAL

Note: 1. Result Level = Read Level + Antenna Factor + Cable loss + Filter Factor - PRM Factor.
 2. If Peak Result complies with AV limit, AV Result is deemed to comply with AV limit.
 3. Test setup: RBW: 1 MHz, VBW: 3 MHz, Sweep time: auto.

TR-4-E-009 Radiated Emission Test Result

Test Site : DDT 3m Chamber 3# D:\E3 6.111\2022 Report Data\Q22062203-2E UCS15\FCC ABOVE 1G 5G.EM6
Test Date : 2022-08-26 **Tested By** : Bairong
EUT : Integrated video conference terminal **Model Number** : UC S15
Power Supply : AC 120V/60Hz **Test Mode** : Tx Mode
Condition : Temp:23.1°C,Humi:51.5%,Press:100.3kPa **Antenna/Distance** : 2021 BBHA 9120D 3#/3m/VERTICAL
Memo : 11AX40 5510 Power:默认

Data: 116

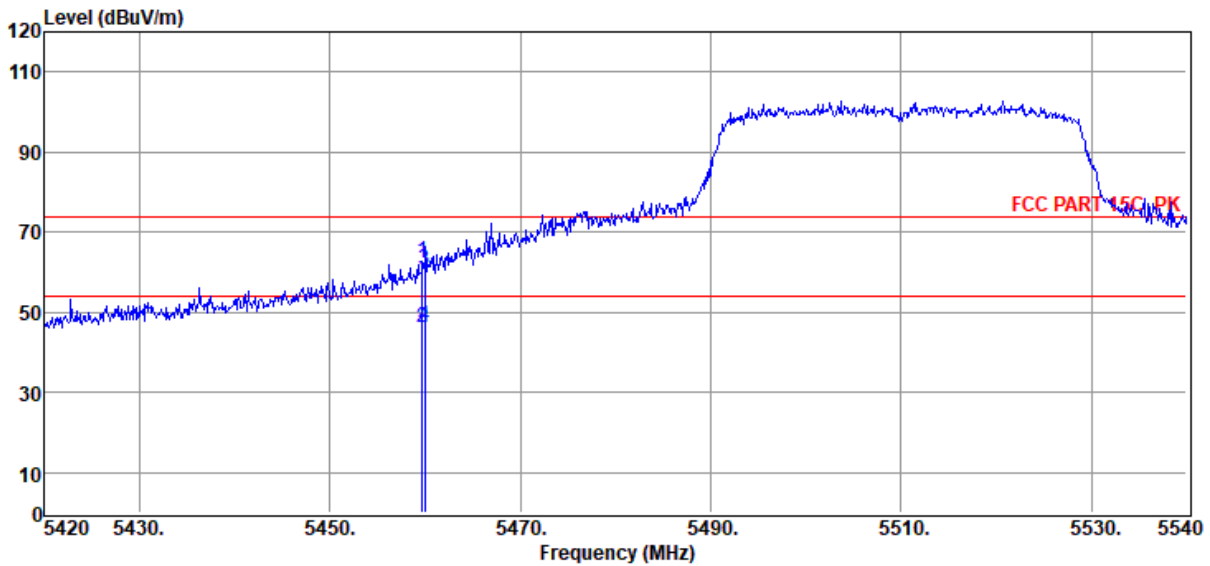

Item (Mark)	Freq. (MHz)	Read Level (dBuV)	Antenna Factor (dB/m)	PRM Factor (dB)	Cable Loss (dB)	Filter Factor (dB)	Result Level (dBuV/m)	Limit Line (dBuV/m)	Over Limit (dB)	Detector	Polarization
1	5459.72	66.89	32.82	40.45	2.57	1.02	62.85	74.00	-11.15	Peak	VERTICAL
2	5459.72	50.42	32.82	40.45	2.57	1.02	46.38	54.00	-7.62	Average	VERTICAL
3	5459.96	64.64	32.82	40.45	2.57	1.02	60.60	74.00	-13.40	Peak	VERTICAL
4	5459.96	50.68	32.82	40.45	2.57	1.02	46.64	54.00	-7.36	Average	VERTICAL

Note: 1. Result Level = Read Level + Antenna Factor + Cable loss + Filter Factor - PRM Factor.
 2. If Peak Result complies with AV limit, AV Result is deemed to comply with AV limit.
 3. Test setup: RBW: 1 MHz, VBW: 3 MHz, Sweep time: auto.

TR-4-E-009 Radiated Emission Test Result

Test Site : DDT 3m Chamber 3# D:\E3 6.111\2022 Report Data\Q22062203-2E UCS15\FCC ABOVE 1G 5G.EM6
Test Date : 2022-08-26 **Tested By** : Bairong
EUT : Integrated video conference terminal **Model Number** : UC S15
Power Supply : AC 120V/60Hz **Test Mode** : Tx Mode
Condition : Temp:23.1°C,Humi:51.5%,Press:100.3kPa **Antenna/Distance** : 2021 BBHA 9120D
3#/3m/HORIZONTAL
Memo : 11N40 5670 Power:默认

Data: 117

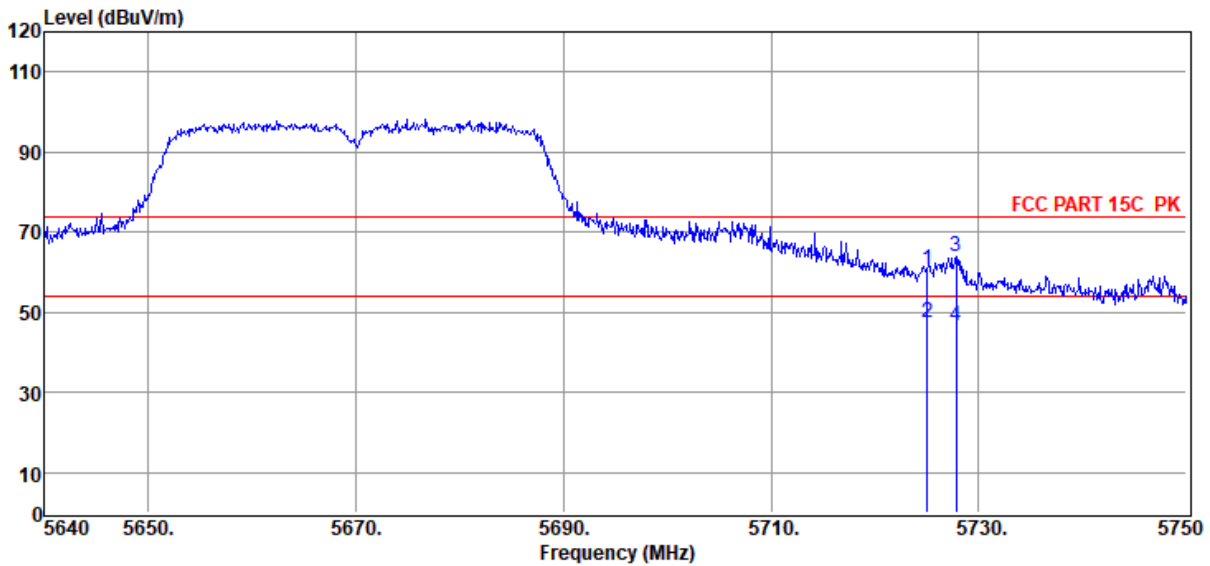

Item (Mark)	Freq. (MHz)	Read Level (dBuV)	Antenna Factor (dB/m)	PRM Factor dB	Cable Loss dB	Filter Factor dB	Result Level (dBuV/m)	Limit Line (dBuV/m)	Over Limit (dB)	Detector	Polarization
1	5725.03	63.79	33.34	40.47	2.78	1.08	60.52	74.00	-13.48	Peak	HORIZONTAL
2	5725.03	50.75	33.34	40.47	2.78	1.08	47.48	54.00	-6.52	Average	HORIZONTAL
3	5727.78	67.08	33.35	40.47	2.78	1.08	63.82	74.00	-10.18	Peak	HORIZONTAL
4	5727.78	49.93	33.35	40.47	2.78	1.08	46.67	54.00	-7.33	Average	HORIZONTAL

Note: 1. Result Level = Read Level + Antenna Factor + Cable loss + Filter Factor - PRM Factor.
 2. If Peak Result complies with AV limit, AV Result is deemed to comply with AV limit.
 3. Test setup: RBW: 1 MHz, VBW: 3 MHz, Sweep time: auto.

TR-4-E-009 Radiated Emission Test Result

Test Site : DDT 3m Chamber 3# D:\E3 6.111\2022 Report Data\Q22062203-2E UCS15\FCC ABOVE 1G 5G.EM6
Test Date : 2022-08-26 **Tested By** : Bairong
EUT : Integrated video conference terminal **Model Number** : UC S15
Power Supply : AC 120V/60Hz **Test Mode** : Tx Mode
Condition : Temp:23.1°C,Humi:51.5%,Press:100.3kPa **Antenna/Distance** : 2021 BBHA 9120D 3#/3m/VERTICAL
Memo : 11N40 5670 Power:默认

Data: 118

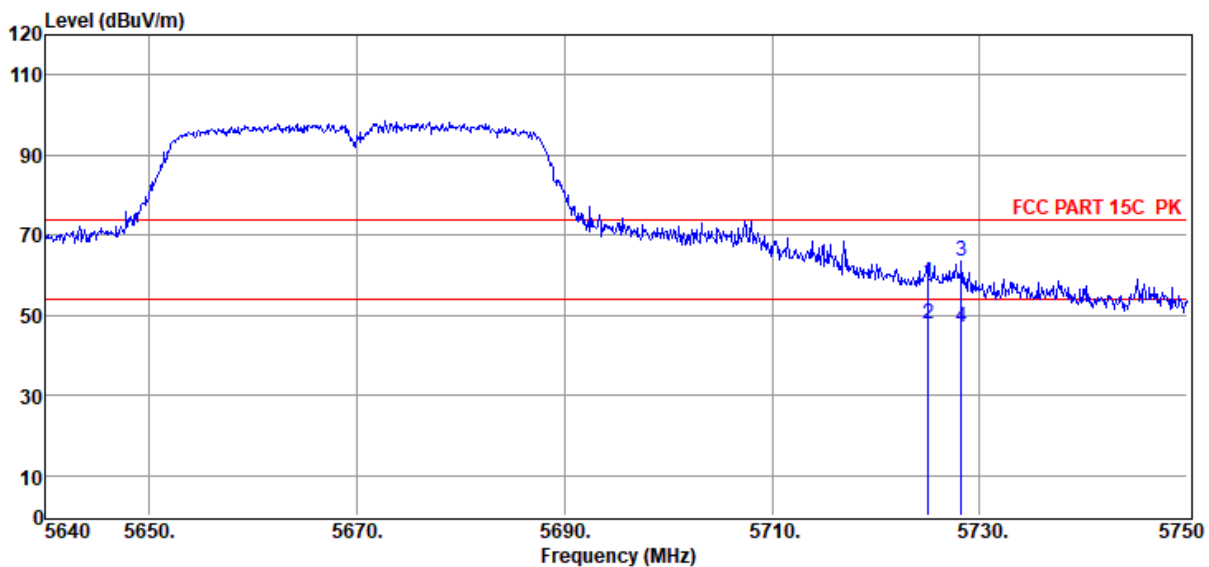

Item (Mark)	Freq. (MHz)	Read Level (dBuV)	Antenna Factor (dB/m)	PRM Factor dB	Cable Loss dB	Filter Factor dB	Result Level (dBuV/m)	Limit Line (dBuV/m)	Over Limit (dB)	Detector	Polarization
1	5725.03	61.45	33.34	40.47	2.78	1.08	58.18	74.00	-15.82	Peak	VERTICAL
2	5725.03	50.94	33.34	40.47	2.78	1.08	47.67	54.00	-6.33	Average	VERTICAL
3	5728.22	66.74	33.35	40.47	2.78	1.08	63.48	74.00	-10.52	Peak	VERTICAL
4	5728.22	50.44	33.35	40.47	2.78	1.08	47.18	54.00	-6.82	Average	VERTICAL

Note: 1. Result Level = Read Level + Antenna Factor + Cable loss + Filter Factor - PRM Factor.
 2. If Peak Result complies with AV limit, AV Result is deemed to comply with AV limit.
 3. Test setup: RBW: 1 MHz, VBW: 3 MHz, Sweep time: auto.

TR-4-E-009 Radiated Emission Test Result

Test Site : DDT 3m Chamber 3# D:\E3 6.111\2022 Report Data\Q22062203-2E UCS15\FCC ABOVE 1G 5G.EM6
Test Date : 2022-08-26 **Tested By** : Bairong
EUT : Integrated video conference terminal **Model Number** : UC S15
Power Supply : AC 120V/60Hz **Test Mode** : Tx Mode
Condition : Temp:23.1°C,Humi:51.5%,Press:100.3kPa **Antenna/Distance** : 2021 BBHA 9120D
3#/3m/HORIZONTAL
Memo : 11AX40 5670 Power:默认

Data: 121

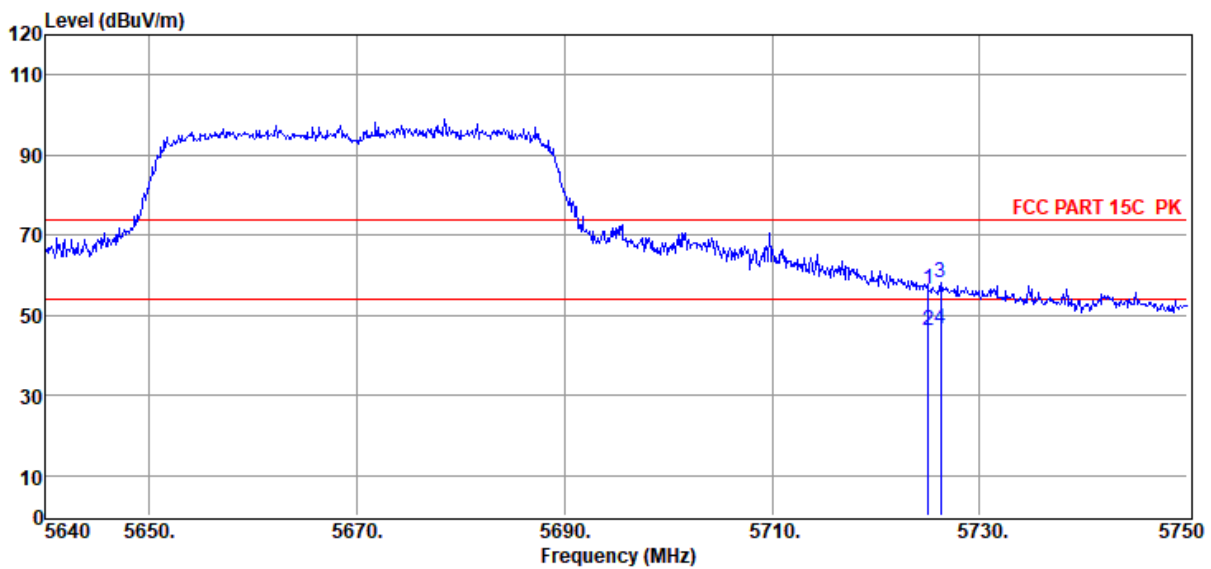

Item (Mark)	Freq. (MHz)	Read Level (dBuV)	Antenna Factor (dB/m)	PRM Factor dB	Cable Loss dB	Filter Factor dB	Result Level (dBuV/m)	Limit Line (dBuV/m)	Over Limit (dB)	Detector	Polarization
1	5725.03	59.59	33.34	40.47	2.78	1.08	56.32	74.00	-17.68	Peak	HORIZONTAL
2	5725.03	49.53	33.34	40.47	2.78	1.08	46.26	54.00	-7.74	Average	HORIZONTAL
3	5726.24	61.61	33.34	40.47	2.78	1.08	58.34	74.00	-15.66	Peak	HORIZONTAL
4	5726.24	49.69	33.34	40.47	2.78	1.08	46.42	54.00	-7.58	Average	HORIZONTAL

Note: 1. Result Level = Read Level + Antenna Factor + Cable loss + Filter Factor - PRM Factor.
 2. If Peak Result complies with AV limit, AV Result is deemed to comply with AV limit.
 3. Test setup: RBW: 1 MHz, VBW: 3 MHz, Sweep time: auto.

TR-4-E-009 Radiated Emission Test Result

Test Site : DDT 3m Chamber 3# D:\E3 6.111\2022 Report Data\Q22062203-2E UCS15\FCC ABOVE 1G 5G.EM6
Test Date : 2022-08-26 **Tested By** : Bairong
EUT : Integrated video conference terminal **Model Number** : UC S15
Power Supply : AC 120V/60Hz **Test Mode** : Tx Mode
Condition : Temp:23.1°C,Humi:51.5%,Press:100.3kPa **Antenna/Distance** : 2021 BBHA 9120D 3#/3m/VERTICAL
Memo : 11AX40 5670 Power:默认

Data: 122

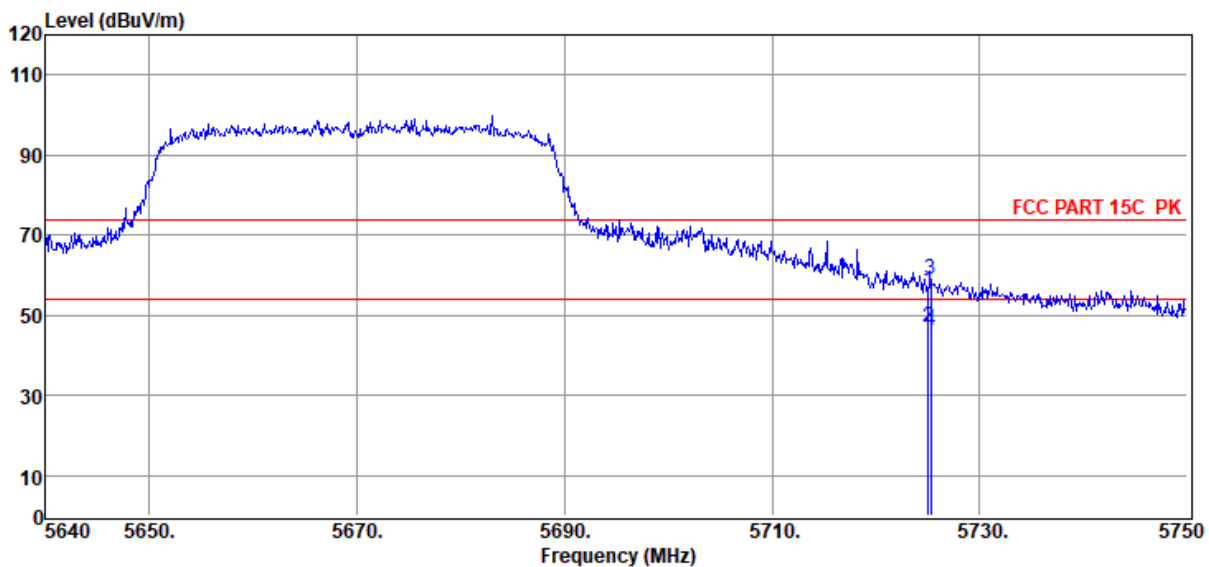

Item (Mark)	Freq. (MHz)	Read Level (dBuV)	Antenna Factor (dB/m)	PRM Factor dB	Cable Loss dB	Filter Factor dB	Result Level (dBuV/m)	Limit Line (dBuV/m)	Over Limit (dB)	Detector	Polarization
1	5725.03	59.17	33.34	40.47	2.78	1.08	55.90	74.00	-18.10	Peak	VERTICAL
2	5725.03	50.17	33.34	40.47	2.78	1.08	46.90	54.00	-7.10	Average	VERTICAL
3	5725.25	62.05	33.34	40.47	2.78	1.08	58.78	74.00	-15.22	Peak	VERTICAL
4	5725.25	49.44	33.34	40.47	2.78	1.08	46.17	54.00	-7.83	Average	VERTICAL

Note: 1. Result Level = Read Level + Antenna Factor + Cable loss + Filter Factor - PRM Factor.
 2. If Peak Result complies with AV limit, AV Result is deemed to comply with AV limit.
 3. Test setup: RBW: 1 MHz, VBW: 3 MHz, Sweep time: auto.

11A_Ant1_Low_5745

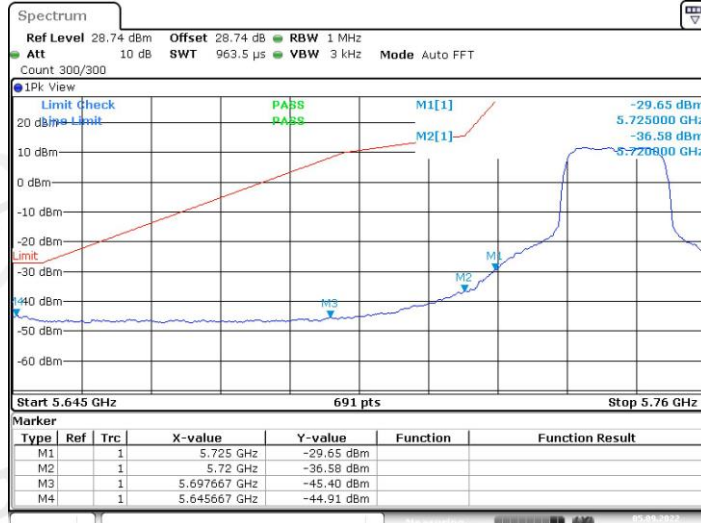

Date: 5 SEP.2022 11:28:29

11A_Ant1_High_5825

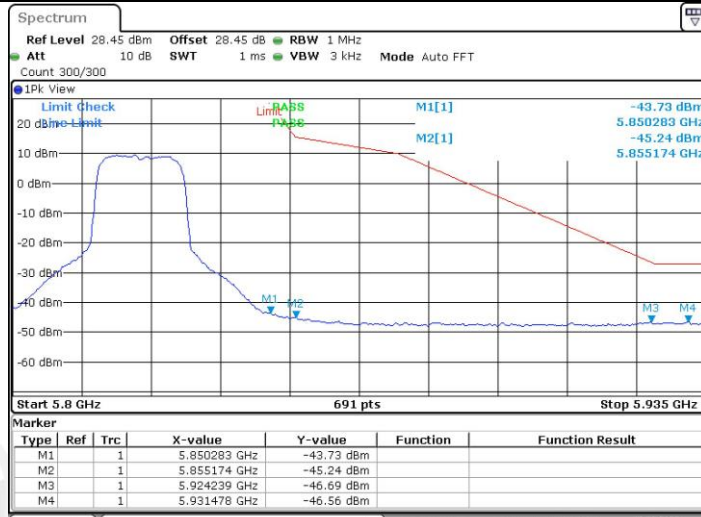

Date: 5 SEP.2022 11:29:12

11N20SISO_Ant1_Low_5745

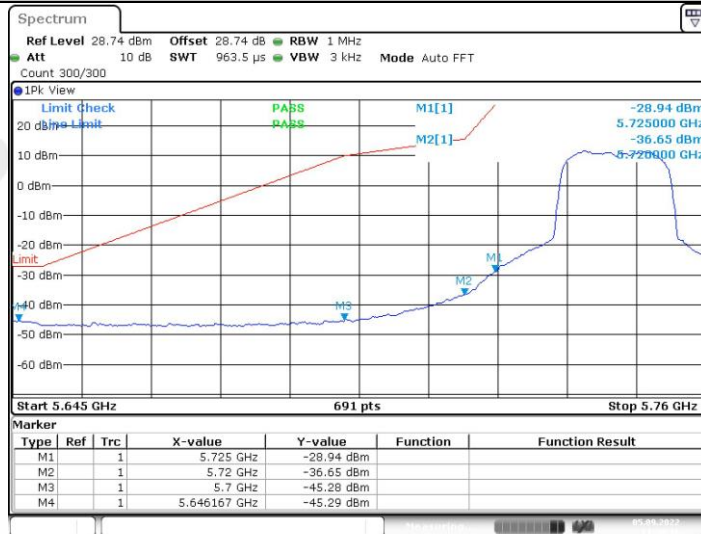

Date: 5 SEP.2022 11:30:17

11N20SISO_Ant1_High_5825

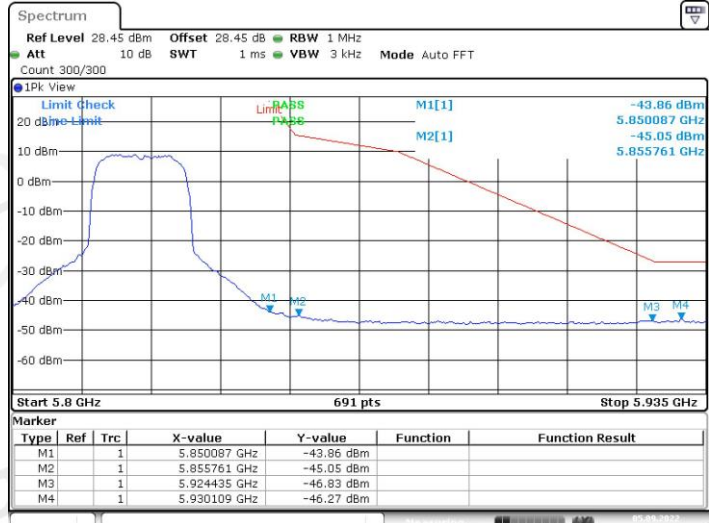

Date: 5.SEP.2022 11:30:52

11N40SISO_Ant1_Low_5755

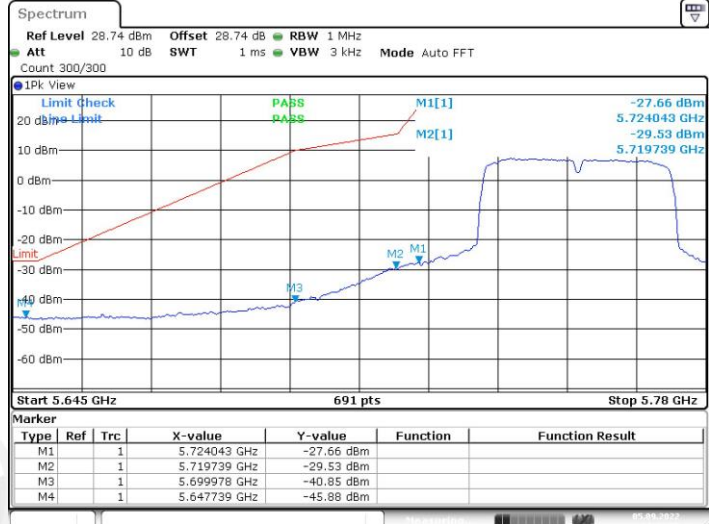

Date: 5.SEP.2022 11:31:55

11N40SISO_Ant1_High_5795

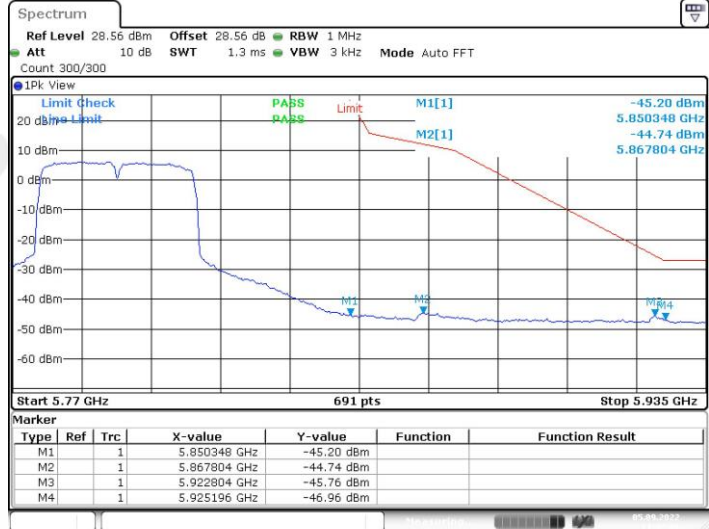

Date: 5.SEP.2022 11:32:28

11AX20SISO_Ant1_Low_5745

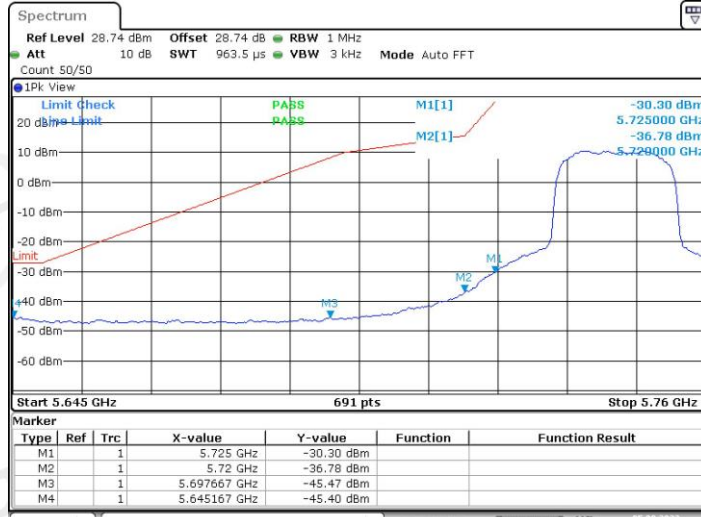

Date: 5.SEP.2022 11:33:22

11AX20SISO_Ant1_High_5825

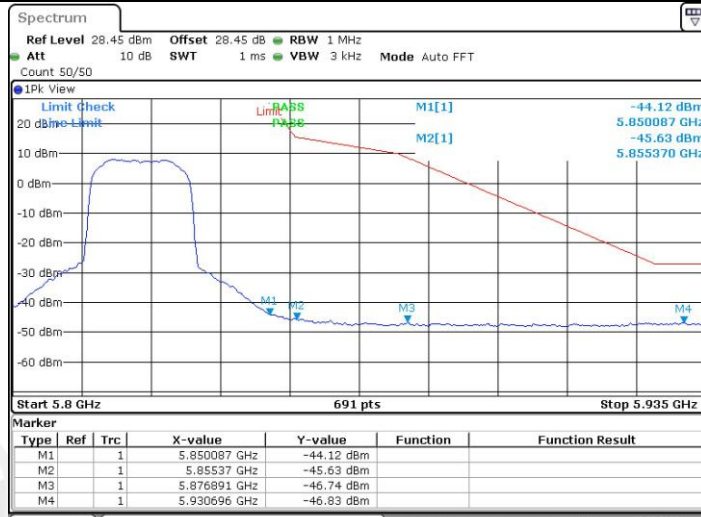

Date: 5.SEP.2022 11:34:07

11AX40SISO_Ant1_Low_5755

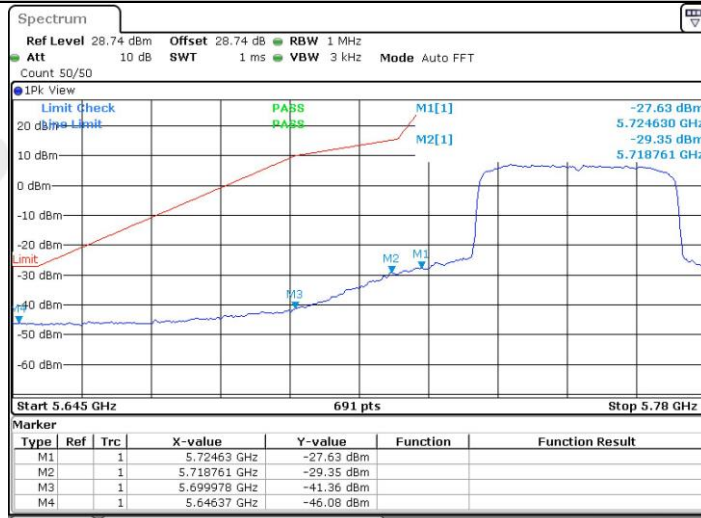

Date: 5.SEP.2022 11:34:44

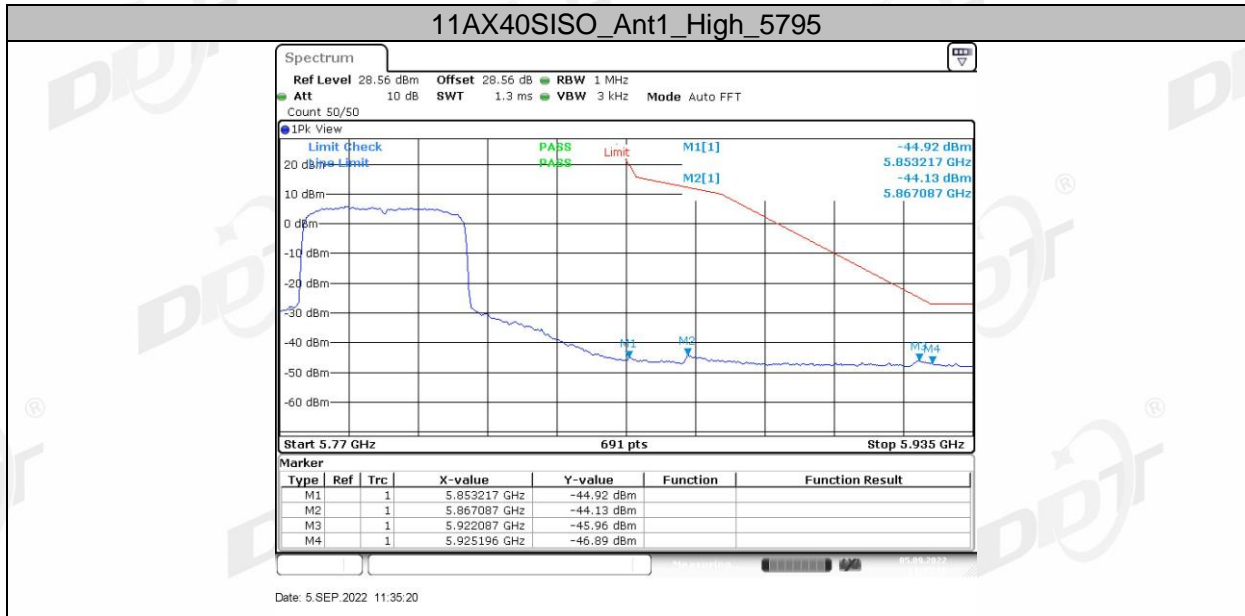

10. Power Line Conducted Emission

10.1. Block diagram of test setup

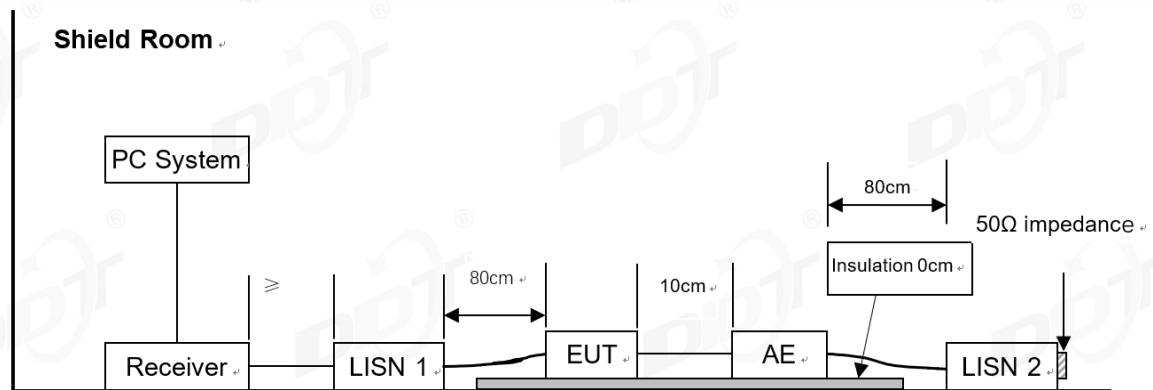

10.2. Power Line Conducted Emission Limits (Class B)

Frequency	Quasi-Peak Level dB(μ V)	Average Level dB(μ V)
150 kHz ~ 500 kHz	66 ~ 56*	56 ~ 46*
500 kHz ~ 5 MHz	56	46
5 MHz ~ 30 MHz	60	50

Note 1: * Decreasing linearly with logarithm of frequency.

Note 2: The lower limit shall apply at the transition frequencies.

10.3. Test Procedure

The EUT and Support equipment, if needed, were put placed on a non-metallic table, 80cm above the ground plane.

Configuration EUT to simulate typical usage as described in clause 2.3 and test equipment as described in clause 10.2 of this report.

All I/O cables were positioned to simulate typical actual usage as per ANSI C63.4.

All support equipment power received from a second LISN.

Emissions were measured on each current carrying line of the EUT using an EMI Test Receiver connected to the LISN powering the EUT.

The Receiver scanned from 150 kHz to 30MHz for emissions in each of the test modes.

During the above scans, the emissions were maximized by cable manipulation.

The test mode(s) described in clause 2.3 were scanned during the preliminary test.

After the preliminary scan, we found the test mode producing the highest emission level.

The EUT configuration and worse cable configuration of the above highest emission levels were recorded for reference of the final test.

EUT and support equipment were set up on the test bench as per the configuration with highest

emission level in the preliminary test.

A scan was taken on both power lines, Neutral and Line, recording at least the six highest emissions.

Emission frequency and amplitude were recorded into a computer in which correction factors were used to calculate the emission level and compare reading to the applicable limit.

The test data of the worst-case condition(s) was recorded.

The bandwidth of test receiver is set at 9 kHz.

10.4. Test Result

Pass. (See below detailed test result)

Note1: All emissions not reported below are too low against the prescribed limits.

Note2: "----" means peak detection; "----" means average detection

Note3: Pre-test AC conducted emission at both voltage AC 120V/60Hz and AC 240V/50Hz, recorded worse case (AC 120V/60Hz).

TR-4-E-010 Conducted Emission Test Result

Test Site : DDT 1# Shield Room D:\2022 CE report date\Q22062203-2E UCS15\FCC.EM6
Test Date : 2022-08-16 **Tested By** : Bairong
EUT : Integrated video conference terminal **Model Number** : UC S15
Power Supply : AC 120V/60Hz **Test Mode** : TX mode
Condition : TEMP:23.8°C, RH:62.0%, BP:101.2kPa **LISN** : 2021 1# ENV216/NEUTRAL
Memo : 5GWIFI

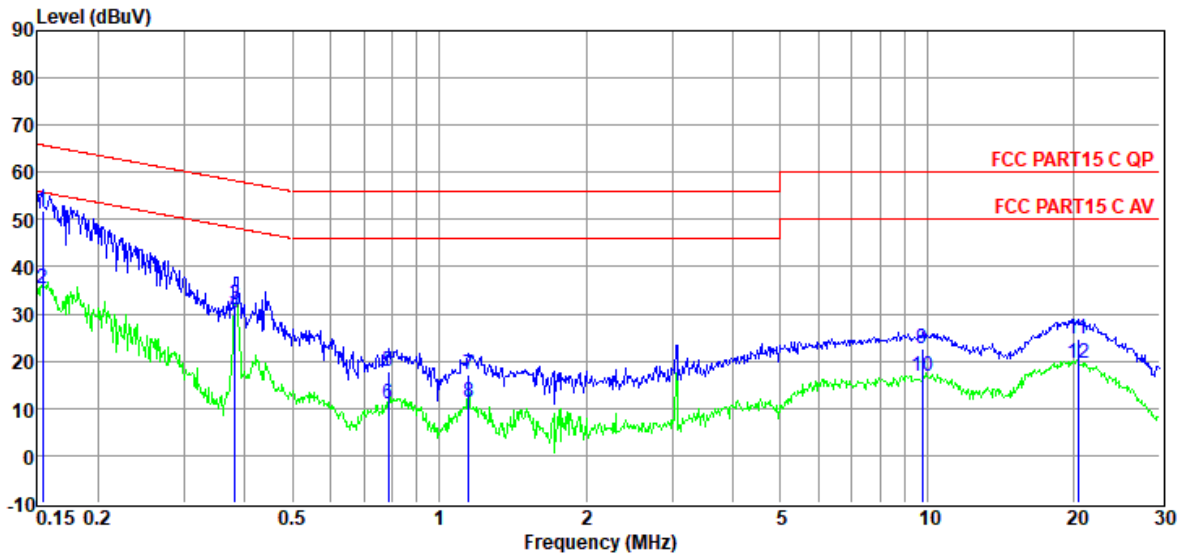

Item (Mark)	Freq. (MHz)	Read Level (dBuV)	LISN Factor (dB)	Cable Loss (dB)	Pulse Limiter Factor (dB)	Result Level (dBuV)	Limit Line (dBuV)	Over Limit (dB)	Detector	Phase
1	0.15	31.98	9.80	0.01	9.92	51.71	65.78	-14.07	QP	NEUTRAL
2	0.15	15.48	9.80	0.01	9.92	35.21	55.78	-20.57	Average	NEUTRAL
3	0.38	12.53	9.59	0.02	9.91	32.05	58.25	-26.20	QP	NEUTRAL
4	0.38	10.77	9.59	0.02	9.91	30.29	48.25	-17.96	Average	NEUTRAL
5	0.79	-1.71	9.77	0.03	9.90	17.99	56.00	-38.01	QP	NEUTRAL
6	0.79	-8.67	9.77	0.03	9.90	11.03	46.00	-34.97	Average	NEUTRAL
7	1.15	-2.55	9.68	0.03	9.89	17.05	56.00	-38.95	QP	NEUTRAL
8	1.15	-8.38	9.68	0.03	9.89	11.22	46.00	-34.78	Average	NEUTRAL
9	9.76	2.77	9.79	0.11	9.94	22.61	60.00	-37.39	QP	NEUTRAL
10	9.76	-3.12	9.79	0.11	9.94	16.72	50.00	-33.28	Average	NEUTRAL
11	20.38	4.94	9.80	0.17	9.96	24.87	60.00	-35.13	QP	NEUTRAL
12	20.38	-0.40	9.80	0.17	9.96	19.53	50.00	-30.47	Average	NEUTRAL

Note:

1. Result Level = Read Level + LISN Factor + Pulse Limiter Factor + Cable loss.
2. If QP Result complies with AV limit, AV Result is deemed to comply with AV limit.
3. Test setup: RBW: 200 Hz (9 kHz—150 kHz), 9 kHz (150 kHz—30 MHz).
4. Step size: 80Hz (0.009MHz-0.15MHz), 4 kHz (0.15MHz-30MHz), Scan time: auto.

TR-4-E-010 Conducted Emission Test Result

Test Site : DDT 1# Shield Room D:\2022 CE report date\Q22062203-2E UCS15\FCC.EM6
Test Date : 2022-08-16 **Tested By** : Bairong
EUT : Integrated video conference terminal **Model Number** : UC S15
Power Supply : AC 120V/60Hz **Test Mode** : TX mode
Condition : TEMP:23.8°C, RH:62.0%, BP:101.2kPa **LISN** : 2021 1# ENV216/LINE
Memo : 5GWIFI

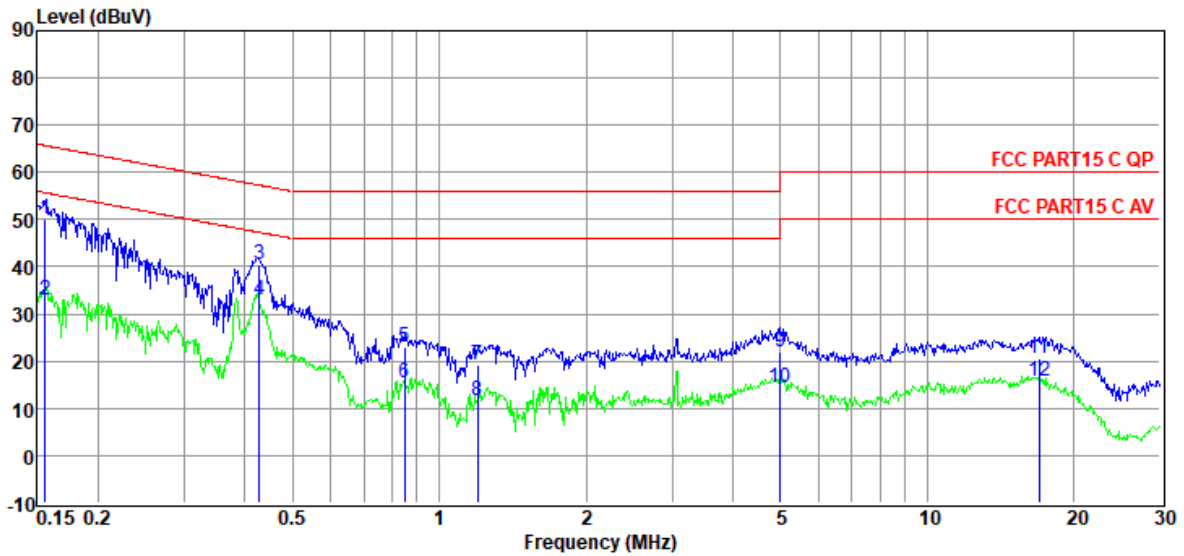

Item (Mark)	Freq. (MHz)	Read Level (dBμV)	LISN Factor (dB)	Cable Loss (dB)	Pulse Limiter Factor (dB)	Result Level (dBμV)	Limit Line (dBμV)	Over Limit (dB)	Detector	Phase
1	0.16	30.53	9.63	0.01	9.92	50.09	65.69	-15.60	QP	LINE
2	0.16	13.42	9.63	0.01	9.92	32.98	55.69	-22.71	Average	LINE
3	0.43	21.10	9.63	0.02	9.91	40.66	57.29	-16.63	QP	LINE
4	0.43	13.28	9.63	0.02	9.91	32.84	47.29	-14.45	Average	LINE
5	0.85	3.41	9.55	0.03	9.90	22.89	56.00	-33.11	QP	LINE
6	0.85	-3.99	9.55	0.03	9.90	15.49	46.00	-30.51	Average	LINE
7	1.20	-0.13	9.57	0.03	9.89	19.36	56.00	-36.64	QP	LINE
8	1.20	-7.83	9.57	0.03	9.89	11.66	46.00	-34.34	Average	LINE
9	5.01	2.36	9.56	0.06	9.93	21.91	60.00	-38.09	QP	LINE
10	5.01	-5.21	9.56	0.06	9.93	14.34	50.00	-35.66	Average	LINE
11	16.93	0.65	9.72	0.16	9.94	20.47	60.00	-39.53	QP	LINE
12	16.93	-3.99	9.72	0.16	9.94	15.83	50.00	-34.17	Average	LINE

Note:

1. Result Level = Read Level + LISN Factor + Pulse Limiter Factor + Cable loss.
2. If QP Result complies with AV limit, AV Result is deemed to comply with AV limit.
3. Test setup: RBW: 200 Hz (9 kHz—150 kHz), 9 kHz (150 kHz—30 MHz).
4. Step size: 80Hz (0.009MHz-0.15MHz), 4 kHz (0.15MHz-30MHz), Scan time: auto.

11. Antenna Requirements

11.1. Limit

For intentional device, according to FCC 47 CFR Section 15.203, an intentional radiator shall be designed to ensure that no antenna other than that furnished by the responsible party shall be used with the device. And according to FCC 47 CFR Section 15.247 (b), if transmitting antennas of directional gain greater than 6dBi are used, the power shall be reduced by the amount in dB that the directional gain of the antenna exceeds 6dBi.

11.2. Result

The product is that no antenna other than that furnished by the responsible party shall be used with the device, the maximum peak gain of the transmit antenna is 5.17 dBi.

12. Dynamic Frequency Selection

12.1. Applicability of DFS requirements

Table 1: Applicability of DFS Requirements Prior to Use of a Channel

Requirement	Operational Mode		
	<input type="checkbox"/> Master	<input checked="" type="checkbox"/> Client Without Radar Detection	<input type="checkbox"/> Client with Radar Detection
Non-Occupancy Period	Yes	Not required	Yes
DFS Detection Threshold	Yes	Not required	Yes
Channel Availability Check Time	Yes	Not required	Not required
U-NII Detection Bandwidth	Yes	Not required	Yes

Table 2: Applicability of DFS requirements during normal operation

Requirement	Operational Mode	
	<input type="checkbox"/> Master Device or Client with Radar Detection	<input checked="" type="checkbox"/> Client Without Radar Detection
DFS Detection Threshold	Yes	Not required
Channel Closing Transmission Time	Yes	Yes
Channel Move Time	Yes	Yes
U-NII Detection Bandwidth	Yes	Not required

Additional requirements for devices with multiple bandwidth modes	<input type="checkbox"/> Master Device or Client with Radar Detection	<input checked="" type="checkbox"/> Client Without Radar Detection
U-NII Detection Bandwidth and Statistical Performance Check	All BW modes must be tested	Not required
Channel Move Time and Channel Closing Transmission Time	Test using widest BW mode available	Test using the widest BW mode available for the link
All other tests	Any single BW mode	Not required

Note: Frequencies selected for statistical performance check should include several frequencies within the radar detection bandwidth and frequencies near the edge of the radar detection bandwidth. For 802.11 devices it is suggested to select frequencies in each of the bonded 20 MHz channels and the channel center frequency.

12.2. Limit

(1) DFS Detection Thresholds

Table 3: DFS Detection Thresholds for Master Devices and Client Devices with Radar Detection

Maximum Transmit Power	Value (See Notes 1, 2, and 3)
EIRP \geq 200 milliwatt	-64 dBm
EIRP < 200 milliwatt and power spectral density < 10 dBm/MHz	-62 dBm
EIRP < 200 milliwatt that do not meet the power spectral density requirement	-64 dBm

Note 1: This is the level at the input of the receiver assuming a 0 dBi receive antenna.

Note 2: Throughout these test procedures an additional 1 dB has been added to the amplitude of the test transmission waveforms to account for variations in measurement equipment. This will ensure that the test signal is at or above the detection threshold level to trigger a DFS response.

Note3: EIRP is based on the highest antenna gain. For MIMO devices refer to KDB Publication 662911 D01.

(2) DFS Response Requirements

Table 4: DFS Response Requirement Values

Parameter	Value
Non-occupancy period	Minimum 30 minutes
Channel Availability Check Time	60 seconds
Channel Move Time	10 seconds See Note 1.
Channel Closing Transmission Time	200 milliseconds + an aggregate of 60 milliseconds over remaining 10 second period. See Notes 1 and 2.
U-NII Detection Bandwidth	Minimum 100% of the U-NII 99% transmission power bandwidth. See Note 3.

Note 1: Channel Move Time and the Channel Closing Transmission Time should be performed with Radar Type 0. The measurement timing begins at the end of the Radar Type 0 burst.

Note 2: The Channel Closing Transmission Time is comprised of 200 milliseconds starting at the beginning of the Channel Move Time plus any additional intermittent control signals required facilitating a Channel move (an aggregate of 60 milliseconds) during the remainder of the 10 second period. The aggregate duration of control signals will not count quiet periods in between transmissions.

Note 3: During the U-NII Detection Bandwidth detection test, radar type 0 should be used. For each frequency step the minimum percentage of detection is 90 percent. Measurements are performed with no data traffic.

12.3. Parameters of radar test waveforms

This section provides the parameters for required test waveforms, minimum percentage of successful detections, and the minimum number of trials that must be used for determining DFS conformance. Step intervals of 0.1 microsecond for Pulse Width, 1 microsecond for PRI, 1 MHz for chirp width and 1 for the number of pulses will be utilized for the random determination of specific test waveforms.

Table 5 Short Pulse Radar Test Waveforms

Radar Type	Pulse Width (μsec)	PRI (μsec)	Number of Pulses	Minimum Percentage of Successful Detection	Minimum Number of Trials
0	1	1428	18	See Note 1	See Note 1
1	1	Test A	Roundup $\left\{ \left(\frac{1}{360} \right) \cdot \left(\frac{19 \cdot 10^6}{\text{PRI}_{\mu\text{sec}}} \right) \right\}$	60%	30
		Test B			
2	1-5	150-230	23-29	60%	30
3	6-10	200-500	16-18	60%	30
4	11-20	200-500	12-16	60%	30
Aggregate (Radar Types 1-4)				80%	120
Note 1: Short Pulse Radar Type 0 should be used for the detection bandwidth test, channel move time, and channel closing time tests.					
Test A: 15 unique PRI values randomly selected from the list of 23 PRI values in Table 5a					
Test B: 15 unique PRI values randomly selected within the range of 518-3066 μsec, with a minimum increment of 1 μsec, excluding PRI values selected in Test A					

A minimum of 30 unique waveforms are required for each of the Short Pulse Radar Types 2 through 4. If more than 30 waveforms are used for Short Pulse Radar Types 2 through 4, then each additional waveform must also be unique and not repeated from the previous waveforms. If more than 30 waveforms are used for Short Pulse Radar Type 1, then each additional waveform is generated with Test B and must also be unique and not repeated from the previous waveforms in Tests A or B. Test aggregate is average of the percentage of successful detections of short pulse radar types 1-4

12.4. Calibration of radar waveform

Radar Waveform Calibration Procedure:

- (1) A 50 ohm load is connected in place of the spectrum analyzer, and the spectrum analyzer is connected to place of the master
- (2) The interference Radar Detection Threshold Level is $-62\text{dBm} + 0\text{dBi} + 1\text{dB} = -61\text{dBm}$ that had been taken into account the output power range and antenna gain.
- (3) The following equipment setup was used to calibrate the conducted radar waveform. A vector signal generator was utilized to establish the test signal level for radar type 0. During this process there were no transmissions by either the master or client device. The spectrum analyzer was switched to the zero spans (time domain) at the frequency of the radar waveform generator. Peak detection was used. The spectrum analyzer resolution bandwidth (RBW) and video bandwidth (VBW) were set to 3 MHz. The spectrum analyzer had offset -1.0dB to compensate RF cable loss 1.0dB.
- (4) The vector signal generator amplitude was set so that the power level measured at the spectrum analyzer was $-62\text{dBm} + 0\text{dBi} + 1\text{dB} = -61\text{dBm}$. Capture the spectrum analyzer plots on short pulse radar waveform.

Conducted Calibration Setup:

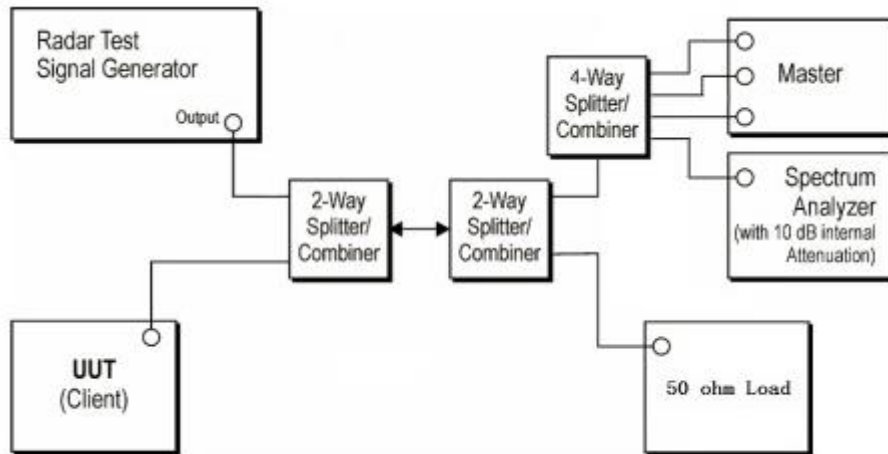

Note: 1. Use the software "Web" to set the frequency channel.

2. EUT is not support TPC and not with Radar detection.

Radar Waveform Calibration Result:

Radar Type 0

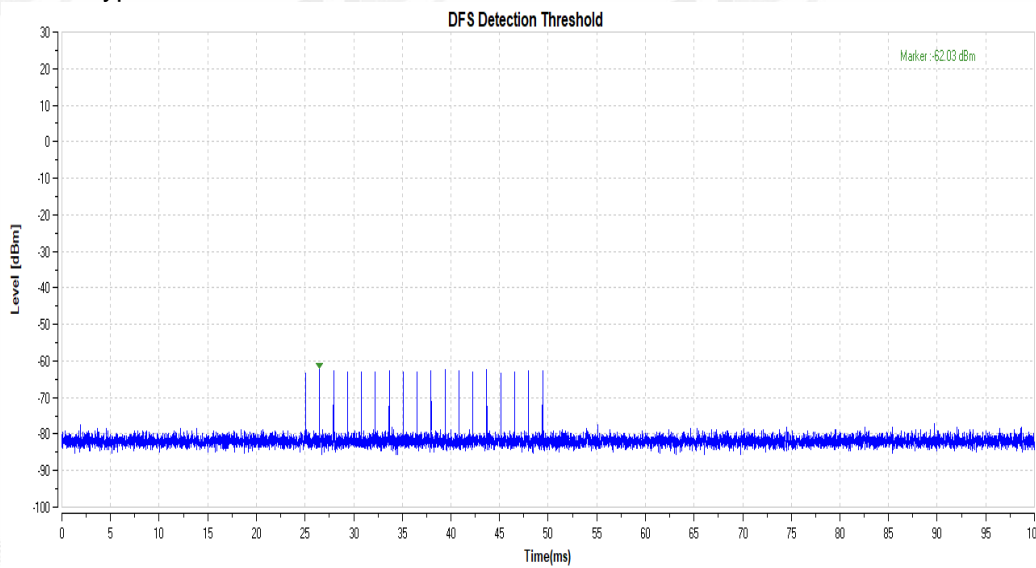

12.5. Channel closing transmission time, channel move time and non-occupancy period

Block diagram of test setup Test Procedure:

- (1) The radar pulse generator is setup to provide a pulse at frequency that the master and client are operating. A type 0 radar pulse with a 1us pulse width and a 1428us PRI is used for the testing.
- (2) The vector signal generator is adjusted to provide the radar burst (18 pulses) at the level of approximately -61dBm at the antenna port of the master device.
- (3) A trigger is provided from the pulse generator to the DFS monitoring system in order to capture the traffic and the occurrence of the radar pulse.
- (4) EUT will associate with the master at channel. The file "iperf.exe" specified by the FCC is streamed from the PC 2 through the master and the client device to the PC 1 and played in full motion video using Test Software in order to properly load the network for the entire period of the test.
- (5) When radar burst with a level equal to the DFS Detection Threshold +1dB is generated on the operating channel of the U-NII device. At time T0 the radar waveform generator sends a burst of pulse of the radar waveform at Detection Threshold +1dB.
- (6) Observe the transmissions of the EUT at the end of the radar Burst on the Operating Channel. Measure and record the transmissions from the UUT during the observation time (Channel Move Time). One 15 seconds plot is reported for the Short Pulse Radar Type 0. The plot for the Short Pulse Radar Types start at the end of the radar burst. The Channel Move Time will be calculated based on the zoom in 600ms plot of the Short Pulse Radar Type.
- (7) Measurement of the aggregate duration of the Channel Closed Transmission Time method. With the
- (8) spectrum analyzer set to zero span tuned to the center frequency of the EUT operating channel at the radar simulated frequency, peak detection, and max hold, the dwell time per bin is given by: $Dwell (0.3ms) = S (12000ms) / B (4000)$; where Dwell is the dwell time per spectrum analyzer sampling bin, S is sweep time and B is the number of spectrum analyzer sampling bins. An upper bound of the aggregate duration of the intermittent control signals of Channel Closing Transmission Time is calculated by: $C (ms) = N \times Dwell (0.3ms)$; where C is the Closing Time, N is the number of spectrum analyzer sampling bins (intermittent control signals) showing a U-NII transmission and Dwell is the dwell time per bin.

Measurement the EUT for more than 30 minutes following the channel move time to verify that no transmission or beacons occur on this channel.

12.6. Test setup

Setup for Client with injection at the Master

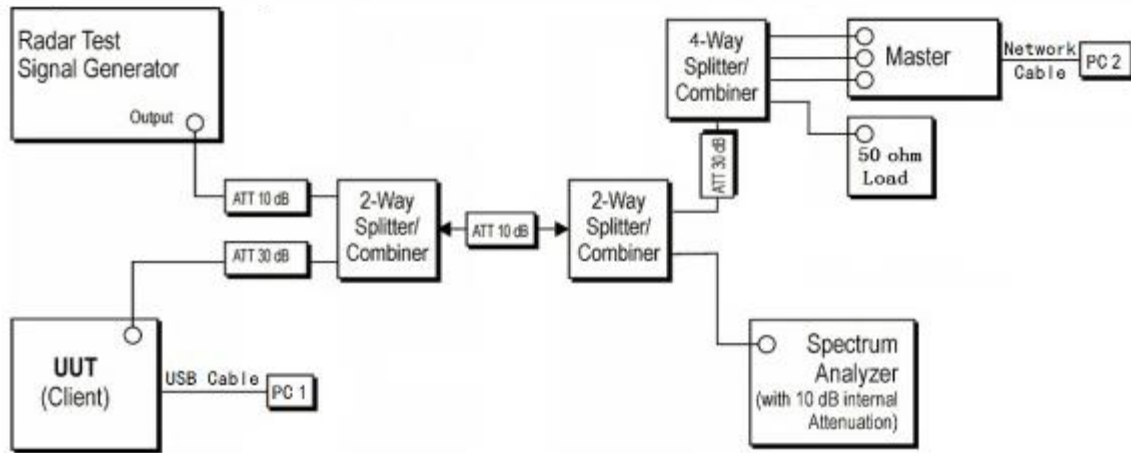

12.7. Test result

BW/Channel	Test Item	Test Result	Limit	Results
1140M/5510MHz	Channel Move Time	0.63s	< 10s	pass
	Channel Closing Transmission Time	0.0078s	< 0.26s	pass

Note: All the modes had been tested, but only the worst data were recorded in the report.

Test plots as follows:



BW/Channel	Test Item	Test Result	Limit	Results
1140M/5510MHz	Non-Occupancy Period	>30min	30min	pass

