

802.11ax-HE160 Power Spectral Density - Ant 0

Channel 50 (5250MHz)

Channel 114 (5570MHz)

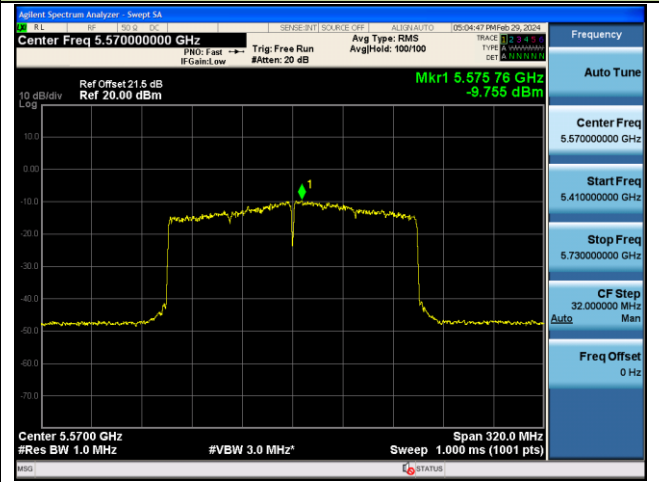
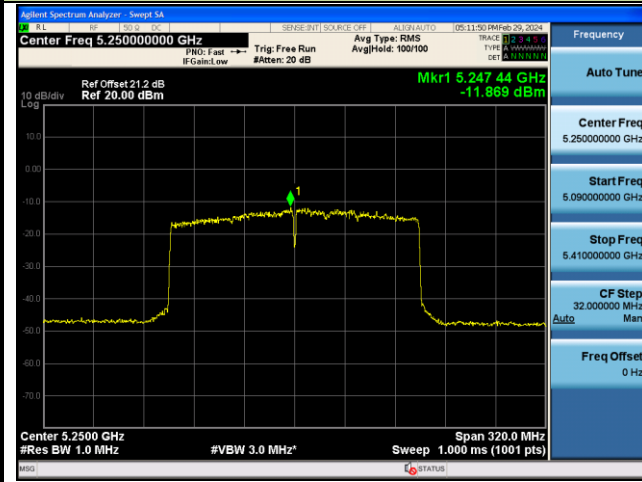

7.7. Frequency Stability Measurement

7.7.1. Test Limit

Manufactures of U-NII devices are responsible for ensuring frequency stability such that an emission is maintained within the band of operation under all conditions of normal operation as specified in the user's manual.

7.7.2. Test Limit

Frequency Stability Under Temperature Variations:

The equipment under test was connected to an external AC or DC power supply and input rated voltage. RF output was connected to a frequency counter or spectrum analyzer via feed through attenuators. The EUT was placed inside the temperature chamber. Set the spectrum analyzer RBW low enough to obtain the desired frequency resolution and measure EUT 20°C operating frequency as reference frequency. Turn EUT off and set the chamber temperature to highest. After the temperature stabilized for approximately 30 minutes recorded the frequency. Repeat step measure with 10°C decreased per stage until the lowest temperature reached.

Frequency Stability Under Voltage Variations:

Set chamber temperature to 20°C. Use a variable AC power supply / DC power source to power the EUT and set the voltage to rated voltage. Set the spectrum analyzer RBW low enough to obtain the desired frequency resolution and recorded the frequency.

Reduce the input voltage to specify extreme voltage variation ($\pm 15\%$) and endpoint, record the maximum frequency change.

7.7.3. Test Setup

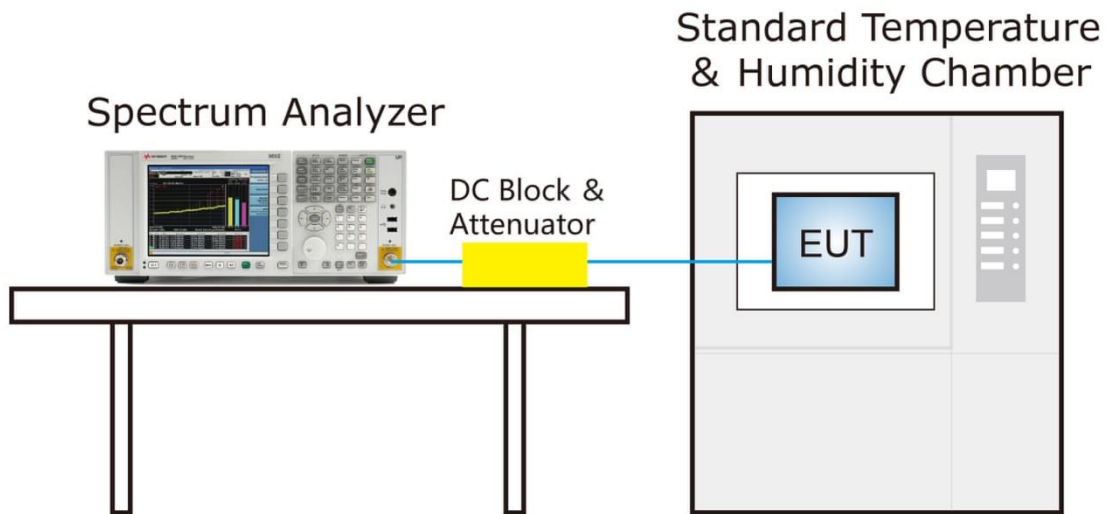

7.7.4. Test Result

Grantee ensure that the product meets e-CFR Title 47 section 15.407(g) and KDB 789033 D02v02r01 frequency stability such that the emissions are maintained within the band of operation under all conditions of normal operation as specified in the user's manual.

7.8. Radiated Spurious Emission Measurement

7.8.1. Test Limit

All out of band emissions appearing in a restricted band as specified in Section 15.205 of the Title 47CFR must not exceed the limits shown in Table per Section 15.209.

FCC Part 15 Subpart C Paragraph 15.209		
Frequency [MHz]	Field Strength [uV/m]	Measured Distance [Meters]
0.009 - 0.490	2400/F (kHz)	300
0.490 - 1.705	24000/F (kHz)	30
1.705 - 30	30	30
30 - 88	100	3
88 - 216	150	3
216 - 960	200	3
Above 960	500	3

7.8.2. Test Procedure Used

KDB 789033 D02v02r01- Section G

7.8.3. Test Setting

Table 1 - RBW as a function of frequency

Frequency	RBW
9 ~ 150 kHz	200 ~ 300 Hz
0.15 ~ 30 MHz	9 ~ 10 kHz
30 ~ 1000 MHz	100 ~ 120 kHz
>1000 MHz	1 MHz

Quasi-Peak Measurements below 1GHz

1. Analyzer center frequency was set to the frequency of the radiated spurious emission of interest
2. Span was set greater than 1MHz
3. RBW = as specified in Table 1
4. Detector = CISPR quasi-peak
5. Sweep time = auto couple
6. Trace was allowed to stabilize

Peak Measurements above 1GHz

1. Analyzer center frequency was set to the frequency of the radiated spurious emission of interest
2. RBW = 1MHz
3. VBW = 3MHz
4. Detector = peak
5. Sweep time = auto couple
6. Trace mode = max hold
7. Trace was allowed to stabilize

Average Measurements above 1GHz (Method VB)

1. Analyzer center frequency was set to the frequency of the radiated spurious emission of interest
2. RBW = 1MHz
3. VBW; If the EUT is configured to transmit with duty cycle $\geq 98\%$, set VBW = 10 Hz.
If the EUT duty cycle is $< 98\%$, set VBW $\geq 1/T$. T is the minimum transmission duration.
4. Detector = Peak
5. Sweep time = auto
6. Trace mode = max hold
7. Trace was allowed to stabilize

7.8.4. Test Setup

Below 1GHz Test Setup:

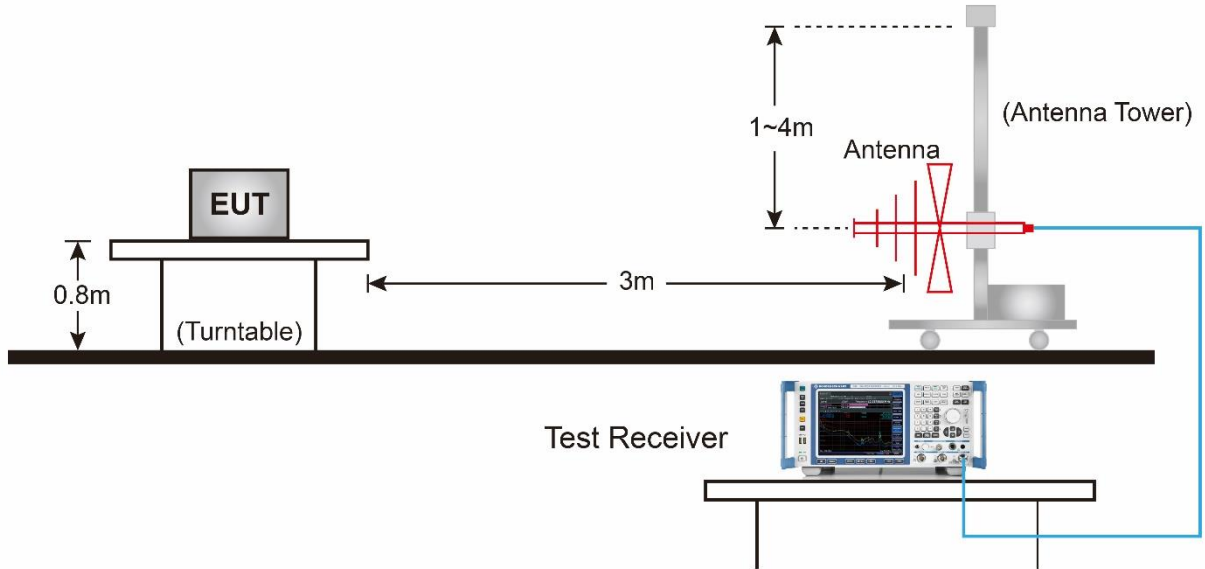

Above 1GHz Test Setup:

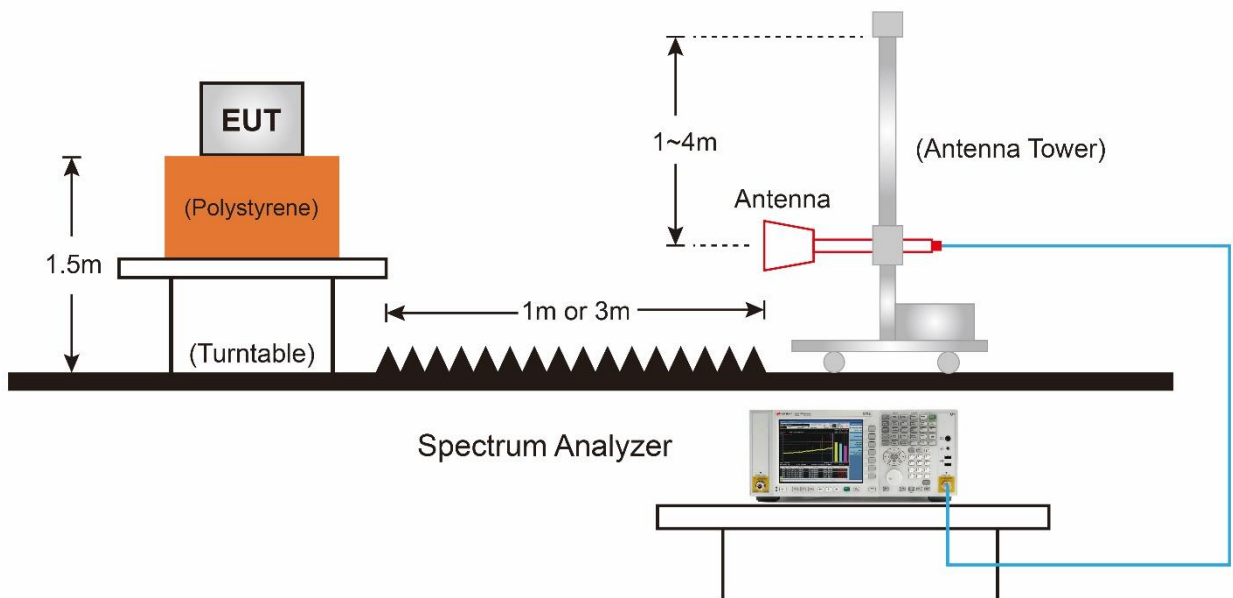

7.8.5. Test Result

EUT	WiFi Module	Date of Test	2024-03-05
Factor	VULB 9162	Temp. / Humidity	23°C /61%
Polarity	Horizontal	Site / Test Engineer	AC2 / Xuan
Test Mode	802.11ac-20MHz_TX_Band1_CH 44_ANT 0	Test Voltage	By Notebook PC

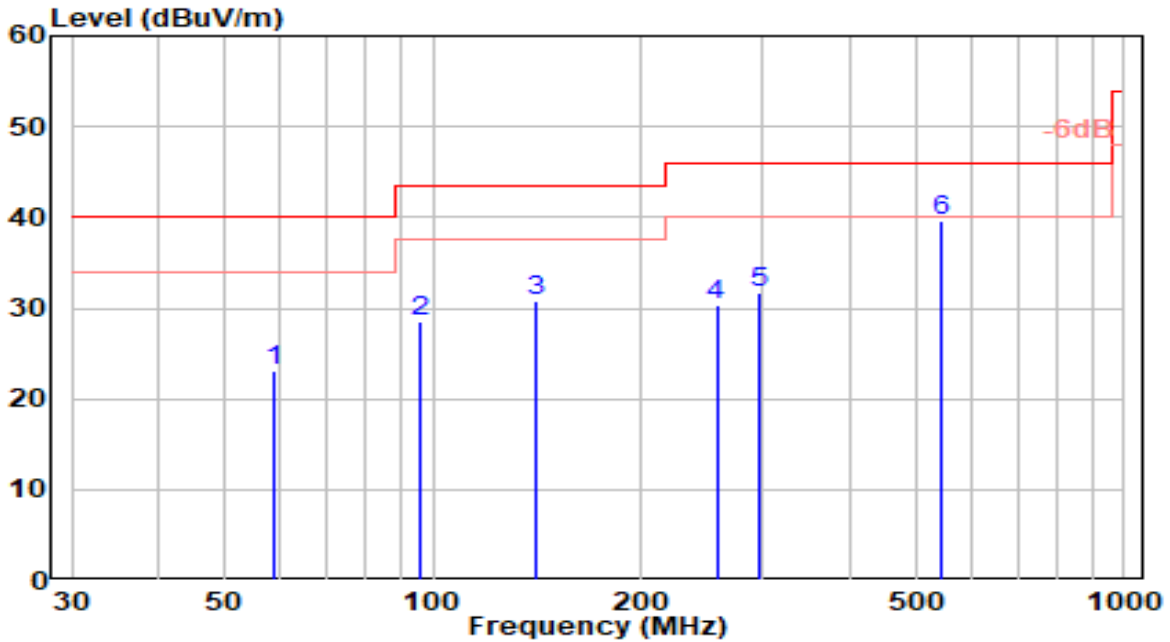

No	Frequency (MHz)	Reading (dBuV)	C.F (dB/m)	Measurement (dBuV/m)	Margin (dB)	Limit (dBuV/m)	Height (cm)	Angle (deg)	Remark (QP/PK/AV)
1	58.840	3.81	19.38	23.19	-16.81	40.00	150	360	QP
2	95.788	10.90	17.69	28.59	-14.91	43.50	150	265	QP
3	140.558	15.92	14.76	30.68	-12.82	43.50	150	185	QP
4	257.186	10.24	19.99	30.23	-15.77	46.00	100	305	QP
5	296.900	11.23	20.57	31.80	-14.20	46.00	100	165	QP
6	* 544.293	13.84	25.67	39.51	-6.49	46.00	150	260	QP

Note:

1. " *", means this data is the worst emission level.
2. C.F (Correction Factor) = Antenna Factor (dB/m) + Cable Loss (dB).
3. Measurement (dBuV/m) = Reading(dBuV) + C.F (Correction Factor).
4. The emission levels of other frequencies are very lower than the limit and not show in test report.
5. The amplitude of radiated emissions (frequency range from 9kHz to 30MHz) is that proximity to ambient noise, which also are attenuated more than 20dB below the permissible value. Therefore, the data is not presented in the report.

EUT	WiFi Module	Date of Test	2024-03-05
Factor	VULB 9162	Temp. / Humidity	23°C /61%
Polarity	Vertical	Site / Test Engineer	AC2 / Xuan
Test Mode	802.11ac-20MHz_TX_Band1_CH 44_ANT 0	Test Voltage	By Notebook PC

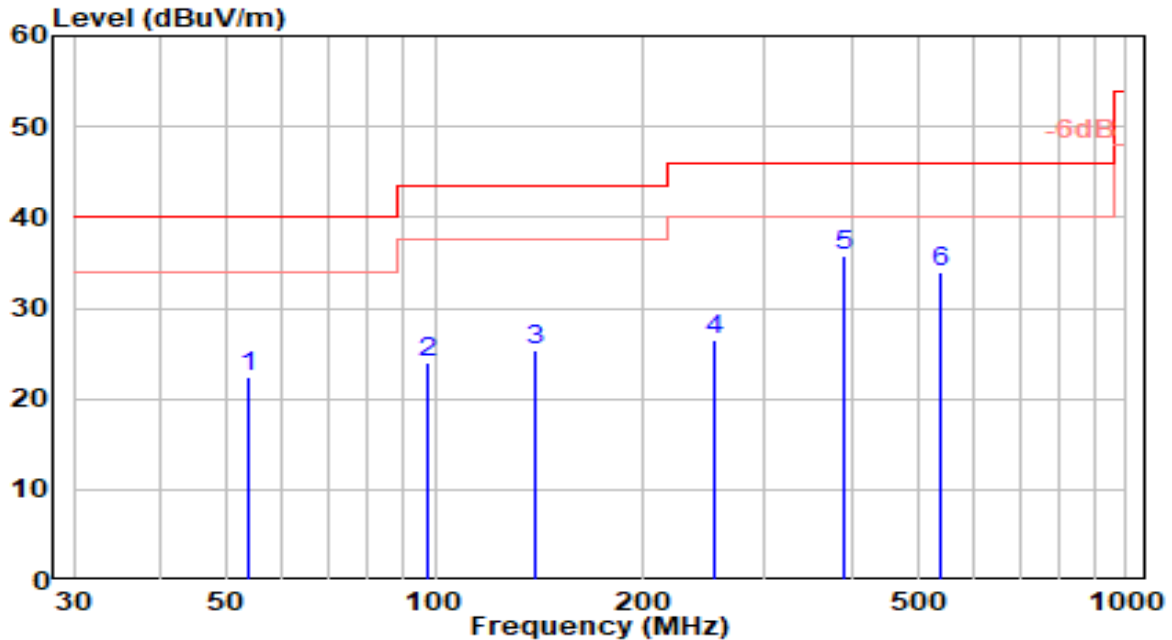

No	Frequency (MHz)	Reading (dBUV)	C.F (dB/m)	Measurement (dBUV/m)	Margin (dB)	Limit (dBUV/m)	Height (cm)	Angle (deg)	Remark (QP/PK/AV)
1	53.817	2.46	19.98	22.44	-17.56	40.00	100	290	QP
2	97.773	6.07	17.98	24.05	-19.45	43.50	150	325	QP
3	139.352	10.63	14.78	25.41	-18.09	43.50	100	290	QP
4	254.347	6.45	19.95	26.40	-19.60	46.00	150	305	QP
5 *	389.829	12.63	23.15	35.78	-10.22	46.00	100	310	QP
6	539.680	8.29	25.61	33.90	-12.10	46.00	100	75	QP

Note:

1. " *", means this data is the worst emission level.
2. C.F (Correction Factor) = Antenna Factor (dB/m) + Cable Loss (dB).
3. Measurement (dBUV/m) = Reading(dBUV) + C.F (Correction Factor).
4. The emission levels of other frequencies are very lower than the limit and not show in test report.
5. The amplitude of radiated emissions (frequency range from 9kHz to 30MHz) is that proximity to ambient noise, which also are attenuated more than 20dB below the permissible value. Therefore, the data is not presented in the report.

EUT	WiFi Module	Date of Test	2024-03-06
Factor	DRH18-E & BBHA 9170	Temp. / Humidity	23°C /61%
Polarity	Horizontal	Site / Test Engineer	AC2 / Marvin
Test Mode	802.11a_TX_Band1_CH 36_ANT 0	Test Voltage	By Notebook PC

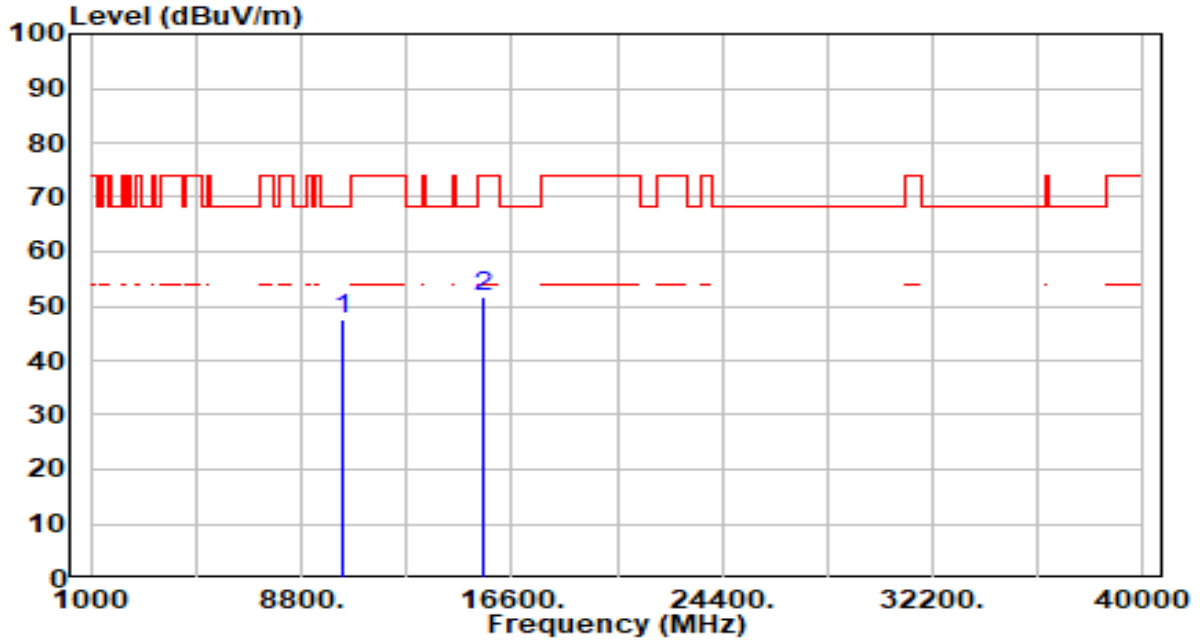

No	Frequency (MHz)	Reading (dBUV)	C.F (dB/m)	Measurement (dBUV/m)	Margin (dB)	Limit (dBUV/m)	Height (cm)	Angle (deg)	Remark (QP/PK/AV)
1	* 10360.000	42.85	4.87	47.72	-20.48	68.20	100	170	Peak
2	15540.000	45.42	6.21	51.63	-22.37	74.00	100	119	Peak

Note:

1. " *", means this data is the worst emission level.
2. C.F (Correction Factor) = Antenna Factor (dB/m)+ Cable Loss (dB) – Preamplifier(dB).
3. Measurement (dBUV/m) = Reading(dBUV) + C.F (Correction Factor).
4. The emission levels of other frequencies are very lower than the limit and not show in test report.

EUT	WiFi Module	Date of Test	2024-03-06
Factor	DRH18-E & BBHA 9170	Temp. / Humidity	23°C /61%
Polarity	Vertical	Site / Test Engineer	AC2 / Marvin
Test Mode	802.11a_TX_Band1_CH 36_ANT 0	Test Voltage	By Notebook PC

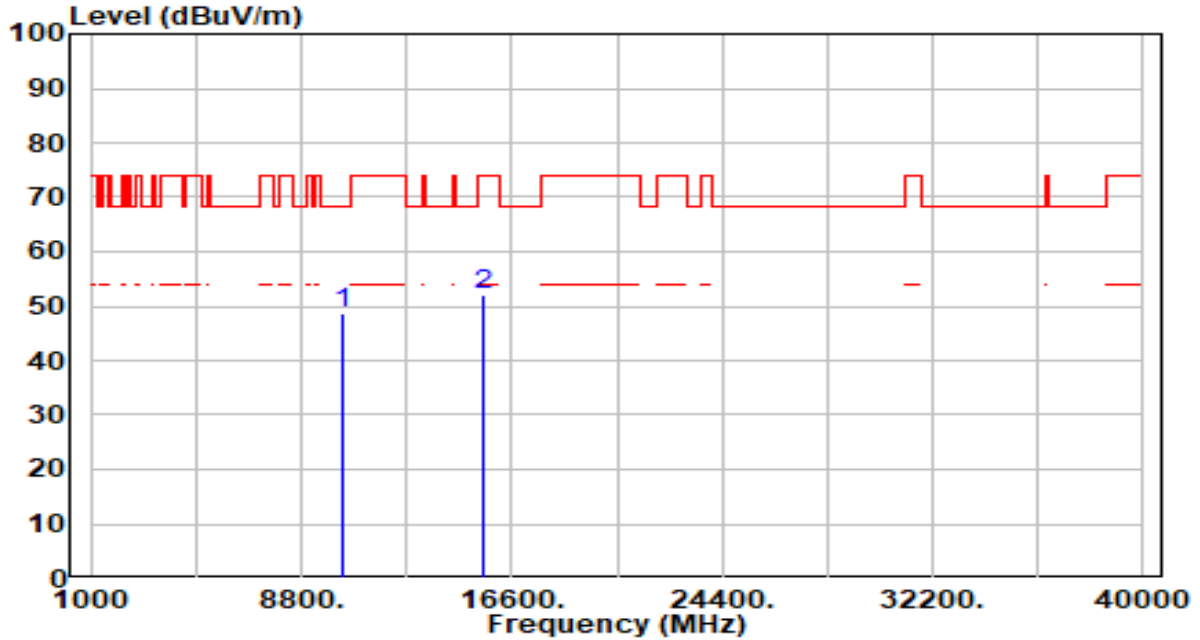

No	Frequency (MHz)	Reading (dBUV)	C.F (dB/m)	Measurement (dBUV/m)	Margin (dB)	Limit (dBUV/m)	Height (cm)	Angle (deg)	Remark (QP/PK/AV)
1	* 10360.000	43.73	4.87	48.60	-19.60	68.20	100	7	Peak
2	15540.000	45.71	6.21	51.91	-22.09	74.00	200	113	Peak

Note:

1. " *", means this data is the worst emission level.
2. C.F (Correction Factor) = Antenna Factor (dB/m)+ Cable Loss (dB) – Preamplifier(dB).
3. Measurement (dBUV/m) = Reading(dBUV) + C.F (Correction Factor).
4. The emission levels of other frequencies are very lower than the limit and not show in test report.

EUT	WiFi Module	Date of Test	2024-03-06
Factor	DRH18-E & BBHA 9170	Temp. / Humidity	23°C /61%
Polarity	Horizontal	Site / Test Engineer	AC2 / Marvin
Test Mode	802.11a_TX_Band1_CH 44_ANT 0	Test Voltage	By Notebook PC

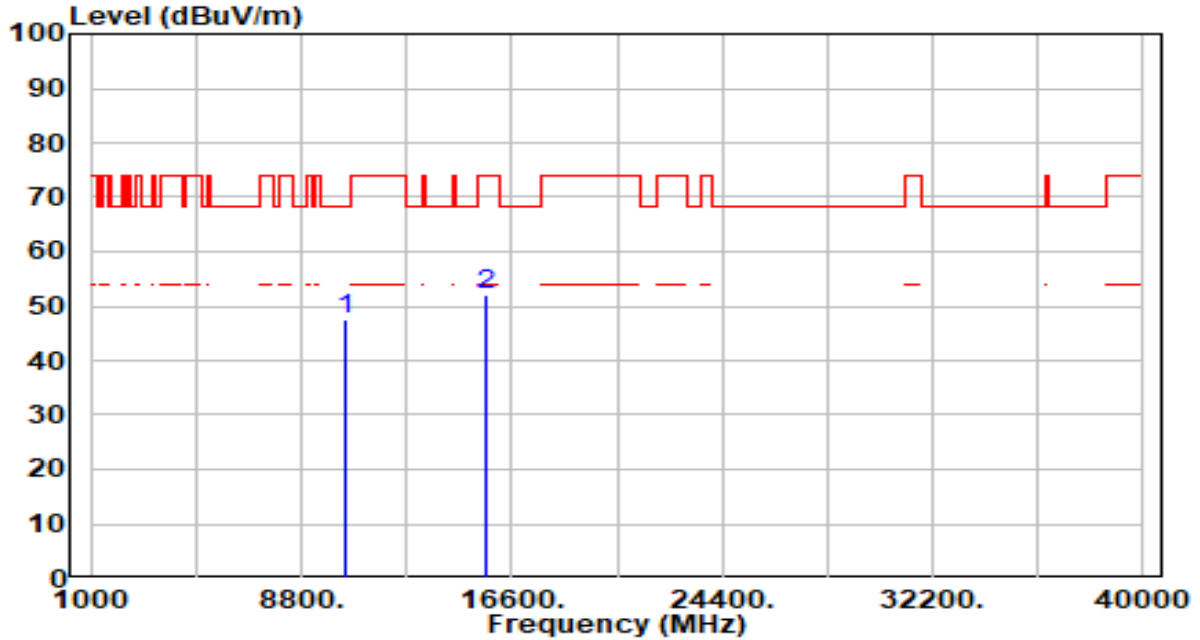

No	Frequency (MHz)	Reading (dBuV)	C.F (dB/m)	Measurement (dBuV/m)	Margin (dB)	Limit (dBuV/m)	Height (cm)	Angle (deg)	Remark (QP/PK/AV)
1	* 10440.000	42.79	4.76	47.56	-20.64	68.20	100	151	Peak
2	15660.000	45.90	6.27	52.17	-21.83	74.00	100	3	Peak

Note:

1. " *", means this data is the worst emission level.
2. C.F (Correction Factor) = Antenna Factor (dB/m)+ Cable Loss (dB) – Preamplifier(dB).
3. Measurement (dBuV/m) = Reading(dBuV) + C.F (Correction Factor).
4. The emission levels of other frequencies are very lower than the limit and not show in test report.

EUT	WiFi Module	Date of Test	2024-03-06
Factor	DRH18-E & BBHA 9170	Temp. / Humidity	23°C /61%
Polarity	Vertical	Site / Test Engineer	AC2 / Marvin
Test Mode	802.11a_TX_Band1_CH 44_ANT 0	Test Voltage	By Notebook PC

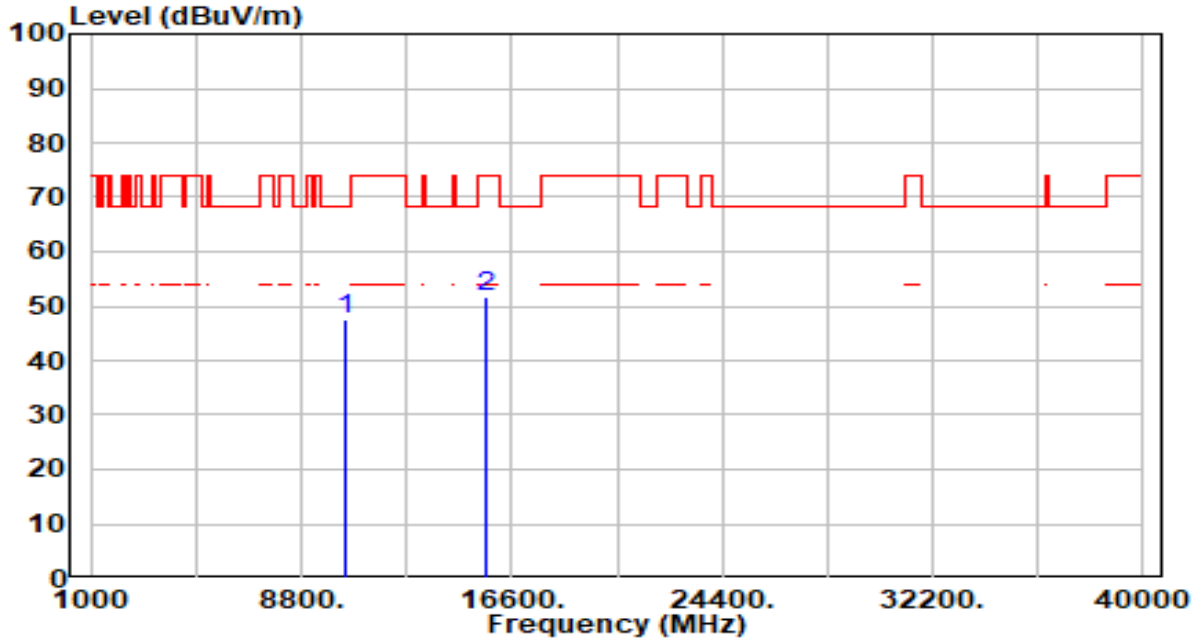

No	Frequency (MHz)	Reading (dBuV)	C.F (dB/m)	Measurement (dBuV/m)	Margin (dB)	Limit (dBuV/m)	Height (cm)	Angle (deg)	Remark (QP/PK/AV)
1	* 10440.000	42.66	4.76	47.42	-20.78	68.20	100	360	Peak
2	15660.000	45.28	6.27	51.54	-22.46	74.00	100	346	Peak

Note:

1. " *", means this data is the worst emission level.
2. C.F (Correction Factor) = Antenna Factor (dB/m)+ Cable Loss (dB) – Preamplifier(dB).
3. Measurement (dBuV/m) = Reading(dBuV) + C.F (Correction Factor).
4. The emission levels of other frequencies are very lower than the limit and not show in test report.

EUT	WiFi Module	Date of Test	2024-03-06
Factor	DRH18-E & BBHA 9170	Temp. / Humidity	23°C /61%
Polarity	Horizontal	Site / Test Engineer	AC2 / Marvin
Test Mode	802.11a_TX_Band1_CH 48_ANT 0	Test Voltage	By Notebook PC

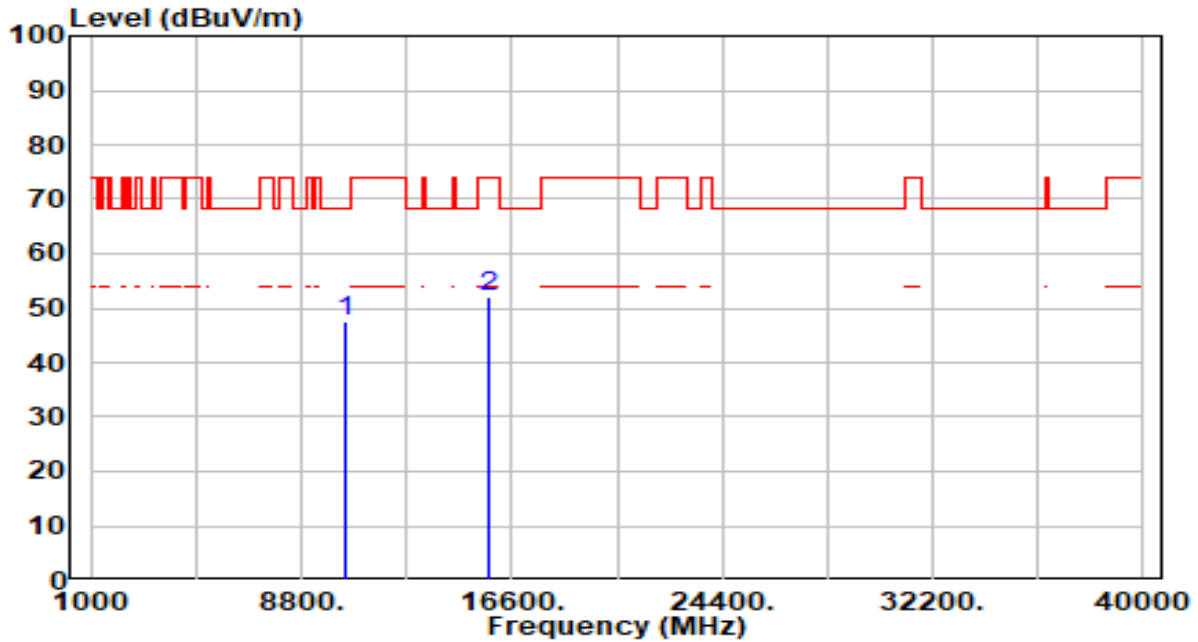

No	Frequency (MHz)	Reading (dBuV)	C.F (dB/m)	Measurement (dBuV/m)	Margin (dB)	Limit (dBuV/m)	Height (cm)	Angle (deg)	Remark (QP/PK/AV)
1	* 10480.000	42.80	4.71	47.51	-20.69	68.20	100	267	Peak
2	15720.000	45.66	6.39	52.05	-21.95	74.00	100	100	Peak

Note:

1. " *", means this data is the worst emission level.
2. C.F (Correction Factor) = Antenna Factor (dB/m)+ Cable Loss (dB) – Preamplifier(dB).
3. Measurement (dBuV/m) = Reading(dBuV) + C.F (Correction Factor).
4. The emission levels of other frequencies are very lower than the limit and not show in test report.

EUT	WiFi Module	Date of Test	2024-03-06
Factor	DRH18-E & BBHA 9170	Temp. / Humidity	23°C /61%
Polarity	Vertical	Site / Test Engineer	AC2 / Marvin
Test Mode	802.11a_TX_Band1_CH 48_ANT 0	Test Voltage	By Notebook PC

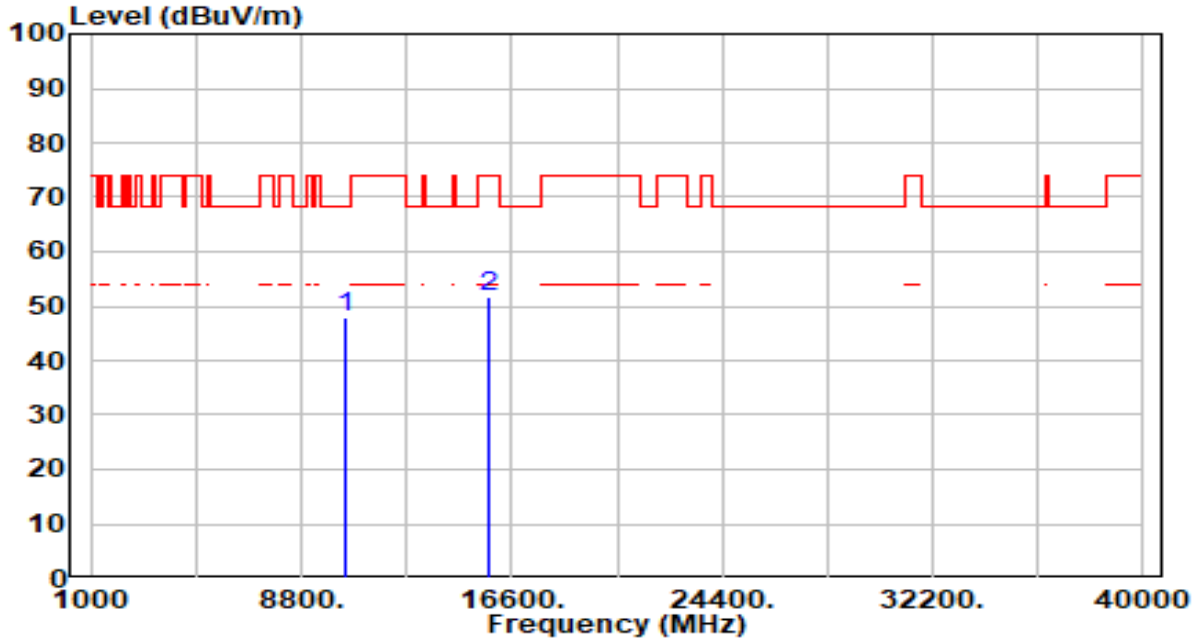

No	Frequency (MHz)	Reading (dBuV)	C.F (dB/m)	Measurement (dBuV/m)	Margin (dB)	Limit (dBuV/m)	Height (cm)	Angle (deg)	Remark (QP/PK/AV)
1	* 10480.000	43.23	4.71	47.94	-20.26	68.20	100	136	Peak
2	15720.000	45.46	6.39	51.85	-22.15	74.00	100	1	Peak

Note:

1. "*" , means this data is the worst emission level.
2. C.F (Correction Factor) = Antenna Factor (dB/m)+ Cable Loss (dB) – Preamplifier(dB).
3. Measurement (dBuV/m) = Reading(dBuV) + C.F (Correction Factor).
4. The emission levels of other frequencies are very lower than the limit and not show in test report.

EUT	WiFi Module	Date of Test	2024-03-06
Factor	DRH18-E & BBHA 9170	Temp. / Humidity	23°C /61%
Polarity	Horizontal	Site / Test Engineer	AC2 / Marvin
Test Mode	802.11a_TX_Band2_CH 52_ANT 0	Test Voltage	By Notebook PC

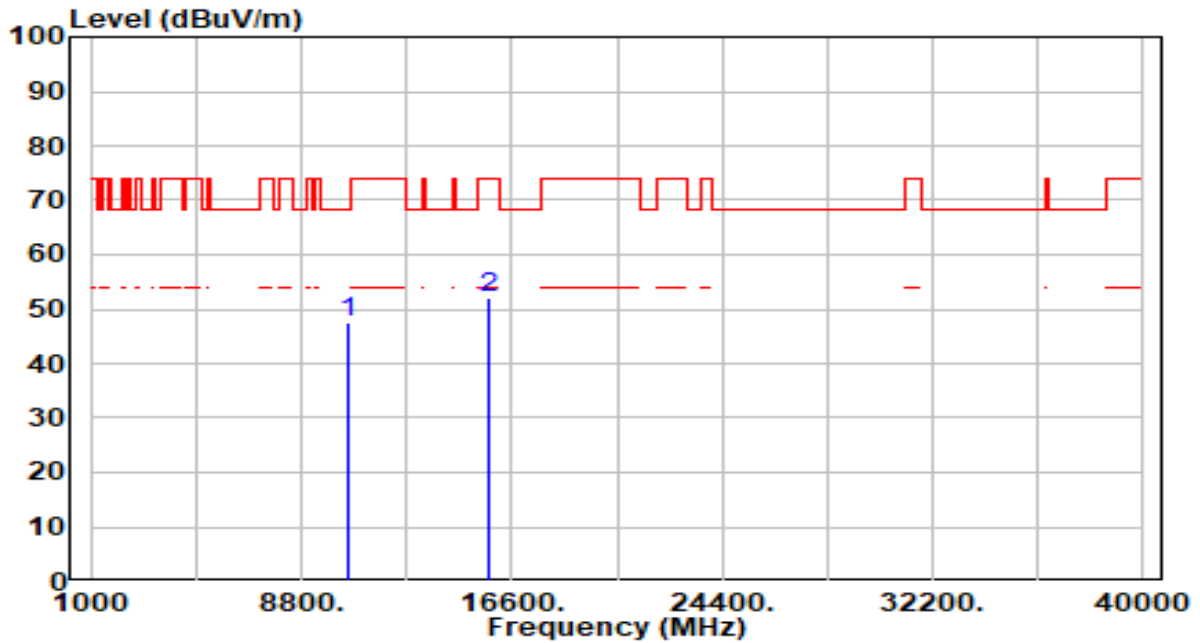

No	Frequency (MHz)	Reading (dBuV)	C.F (dB/m)	Measurement (dBuV/m)	Margin (dB)	Limit (dBuV/m)	Height (cm)	Angle (deg)	Remark (QP/PK/AV)
1	* 10520.000	43.03	4.67	47.70	-20.50	68.20	100	355	Peak
2	15780.000	45.71	6.51	52.22	-21.78	74.00	100	0	Peak

Note:

1. " *", means this data is the worst emission level.
2. C.F (Correction Factor) = Antenna Factor (dB/m)+ Cable Loss (dB) – Pre-amplifier(dB).
3. Measurement (dBuV/m) = Reading(dBuV) + C.F (Correction Factor).
4. The emission levels of other frequencies are very lower than the limit and not show in test report.

EUT	WiFi Module	Date of Test	2024-03-06
Factor	DRH18-E & BBHA 9170	Temp. / Humidity	23°C /61%
Polarity	Vertical	Site / Test Engineer	AC2 / Marvin
Test Mode	802.11a_TX_Band2_CH 52_ANT 0	Test Voltage	By Notebook PC

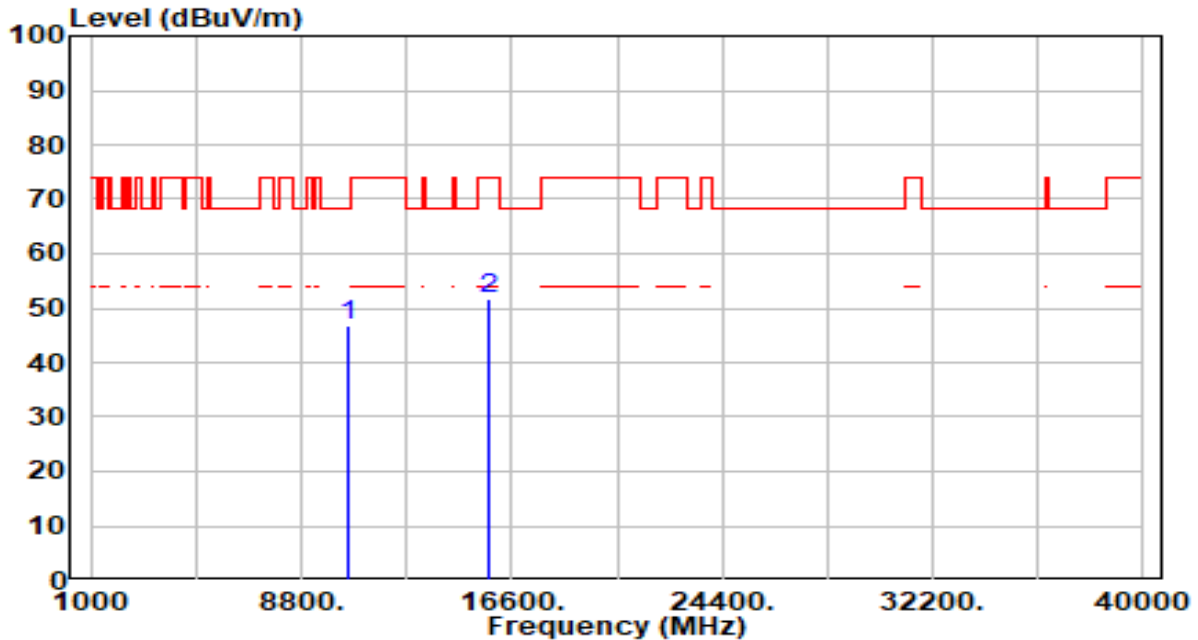

No	Frequency (MHz)	Reading (dBuV)	C.F (dB/m)	Measurement (dBuV/m)	Margin (dB)	Limit (dBuV/m)	Height (cm)	Angle (deg)	Remark (QP/PK/AV)
1	* 10520.000	42.23	4.67	46.90	-21.30	68.20	100	179	Peak
2	15780.000	45.34	6.51	51.85	-22.15	74.00	100	111	Peak

Note:

1. " *", means this data is the worst emission level.
2. C.F (Correction Factor) = Antenna Factor (dB/m)+ Cable Loss (dB) – Preamplifier(dB).
3. Measurement (dBuV/m) = Reading(dBuV) + C.F (Correction Factor).
4. The emission levels of other frequencies are very lower than the limit and not show in test report.

EUT	WiFi Module	Date of Test	2024-03-06
Factor	DRH18-E & BBHA 9170	Temp. / Humidity	23°C /61%
Polarity	Horizontal	Site / Test Engineer	AC2 / Marvin
Test Mode	802.11a_TX_Band2_CH 60_ANT 0	Test Voltage	By Notebook PC

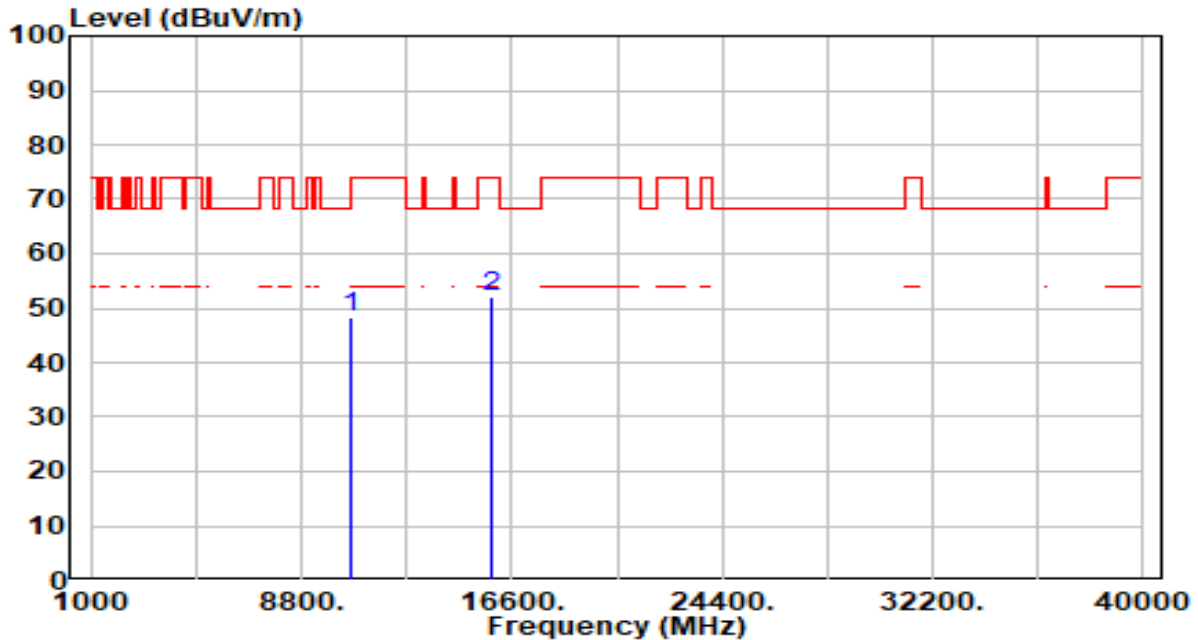

No	Frequency (MHz)	Reading (dBUV)	C.F (dB/m)	Measurement (dBUV/m)	Margin (dB)	Limit (dBUV/m)	Height (cm)	Angle (deg)	Remark (QP/PK/AV)
1	* 10600.000	43.79	4.61	48.40	-19.80	68.20	100	50	Peak
2	15900.000	45.49	6.55	52.04	-21.96	74.00	100	169	Peak

Note:

1. " *", means this data is the worst emission level.
2. C.F (Correction Factor) = Antenna Factor (dB/m)+ Cable Loss (dB) – Preamplifier(dB).
3. Measurement (dBUV/m) = Reading(dBUV) + C.F (Correction Factor).
4. The emission levels of other frequencies are very lower than the limit and not show in test report.

EUT	WiFi Module	Date of Test	2024-03-06
Factor	DRH18-E & BBHA 9170	Temp. / Humidity	23°C /61%
Polarity	Vertical	Site / Test Engineer	AC2 / Marvin
Test Mode	802.11a_TX_Band2_CH 60_ANT 0	Test Voltage	By Notebook PC

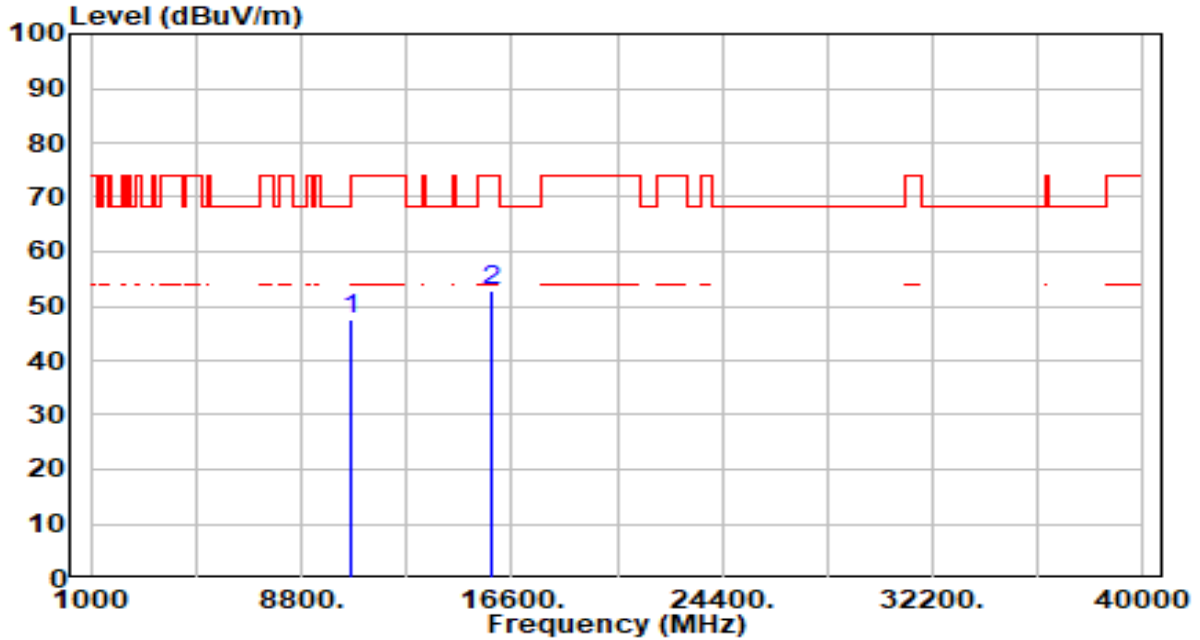

No	Frequency (MHz)	Reading (dBuV)	C.F (dB/m)	Measurement (dBuV/m)	Margin (dB)	Limit (dBuV/m)	Height (cm)	Angle (deg)	Remark (QP/PK/AV)
1	* 10600.000	42.87	4.61	47.48	-20.72	68.20	100	301	Peak
2	15900.000	46.25	6.55	52.80	-21.20	74.00	100	318	Peak

Note:

1. " *", means this data is the worst emission level.
2. C.F (Correction Factor) = Antenna Factor (dB/m)+ Cable Loss (dB) – Preamplifier(dB).
3. Measurement (dBuV/m) = Reading(dBuV) + C.F (Correction Factor).
4. The emission levels of other frequencies are very lower than the limit and not show in test report.

EUT	WiFi Module	Date of Test	2024-03-06
Factor	DRH18-E & BBHA 9170	Temp. / Humidity	23°C /61%
Polarity	Horizontal	Site / Test Engineer	AC2 / Marvin
Test Mode	802.11a_TX_Band2_CH 64_ANT 0	Test Voltage	By Notebook PC

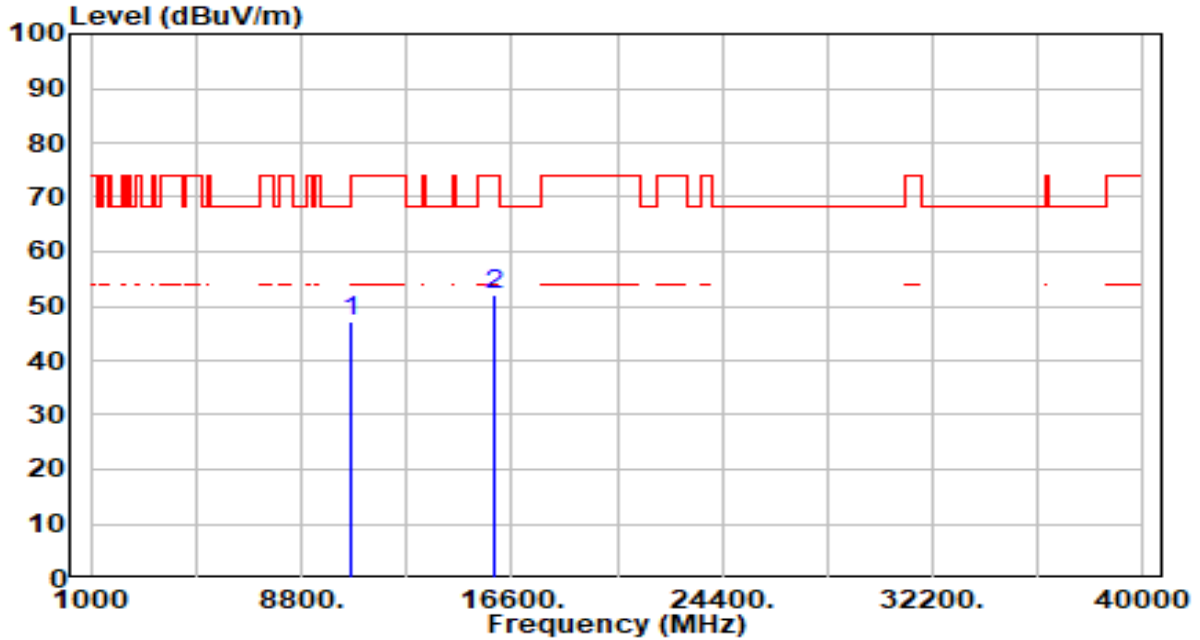

No	Frequency (MHz)	Reading (dBuV)	C.F (dB/m)	Measurement (dBuV/m)	Margin (dB)	Limit (dBuV/m)	Height (cm)	Angle (deg)	Remark (QP/PK/AV)
1	10640.000	42.47	4.62	47.09	-26.91	74.00	100	166	Peak
2	* 15960.000	45.42	6.55	51.97	-22.03	74.00	100	163	Peak

Note:

- "*" , means this data is the worst emission level.
- C.F (Correction Factor) = Antenna Factor (dB/m)+ Cable Loss (dB) – Preamplifier(dB).
- Measurement (dBuV/m) = Reading(dBuV) + C.F (Correction Factor).
- The emission levels of other frequencies are very lower than the limit and not show in test report.

EUT	WiFi Module	Date of Test	2024-03-06
Factor	DRH18-E & BBHA 9170	Temp. / Humidity	23°C /61%
Polarity	Vertical	Site / Test Engineer	AC2 / Marvin
Test Mode	802.11a_TX_Band2_CH 64_ANT 0	Test Voltage	By Notebook PC

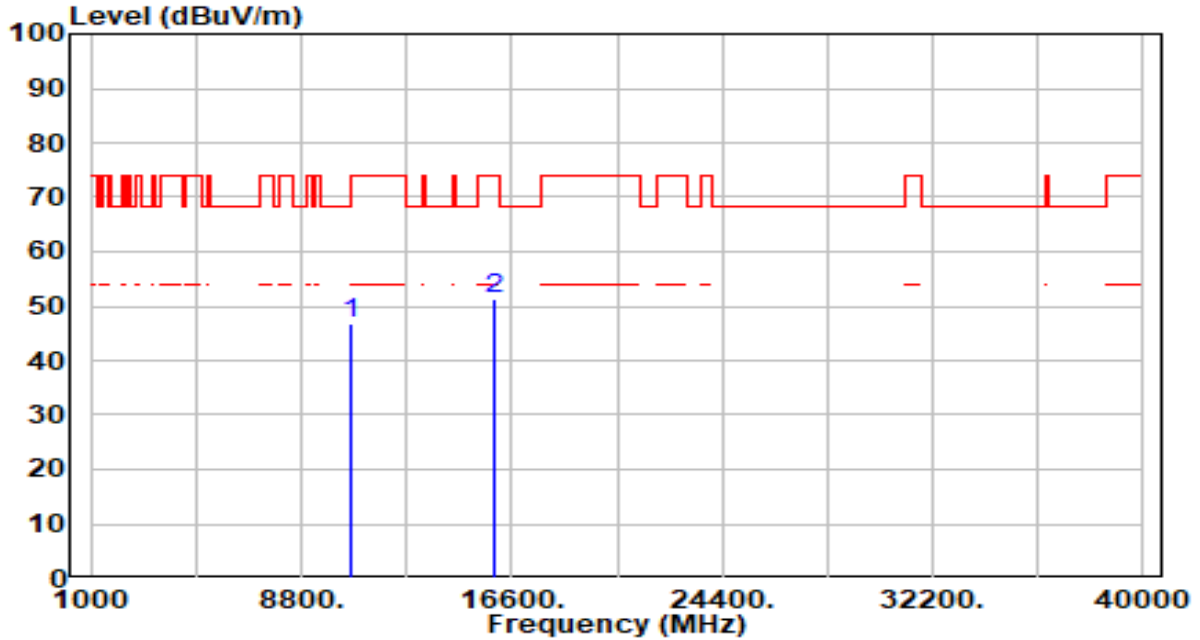

No	Frequency (MHz)	Reading (dBuV)	C.F (dB/m)	Measurement (dBuV/m)	Margin (dB)	Limit (dBuV/m)	Height (cm)	Angle (deg)	Remark (QP/PK/AV)
1	10640.000	42.35	4.62	46.97	-27.03	74.00	100	360	Peak
2	* 15960.000	44.59	6.55	51.14	-22.86	74.00	100	260	Peak

Note:

1. " *", means this data is the worst emission level.
2. C.F (Correction Factor) = Antenna Factor (dB/m)+ Cable Loss (dB) – Preamplifier(dB).
3. Measurement (dBuV/m) = Reading(dBuV) + C.F (Correction Factor).
4. The emission levels of other frequencies are very lower than the limit and not show in test report.

EUT	WiFi Module	Date of Test	2024-03-06
Factor	DRH18-E & BBHA 9170	Temp. / Humidity	23°C /61%
Polarity	Horizontal	Site / Test Engineer	AC2 / Marvin
Test Mode	802.11a_TX_Band3_CH 100_ANT 0	Test Voltage	By Notebook PC

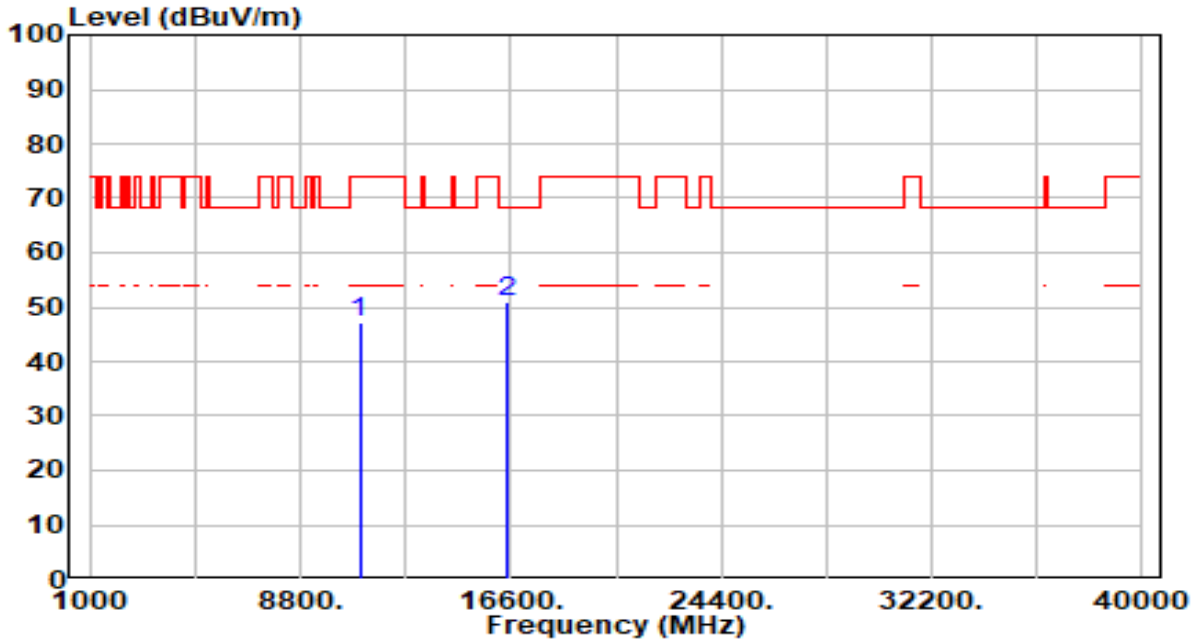

No	Frequency (MHz)	Reading (dBuV)	C.F (dB/m)	Measurement (dBuV/m)	Margin (dB)	Limit (dBuV/m)	Height (cm)	Angle (deg)	Remark (QP/PK/AV)
1	11000.000	42.81	4.52	47.33	-26.67	74.00	100	25	Peak
2	* 16500.000	44.96	6.10	51.06	-17.14	68.20	100	325	Peak

Note:

1. " *", means this data is the worst emission level.
2. C.F (Correction Factor) = Antenna Factor (dB/m)+ Cable Loss (dB) – Pre-amplifier(dB).
3. Measurement (dBuV/m) = Reading(dBuV) + C.F (Correction Factor).
4. The emission levels of other frequencies are very lower than the limit and not show in test report.

EUT	WiFi Module	Date of Test	2024-03-06
Factor	DRH18-E & BBHA 9170	Temp. / Humidity	23°C /61%
Polarity	Vertical	Site / Test Engineer	AC2 / Marvin
Test Mode	802.11a_TX_Band3_CH 100_ANT 0	Test Voltage	By Notebook PC

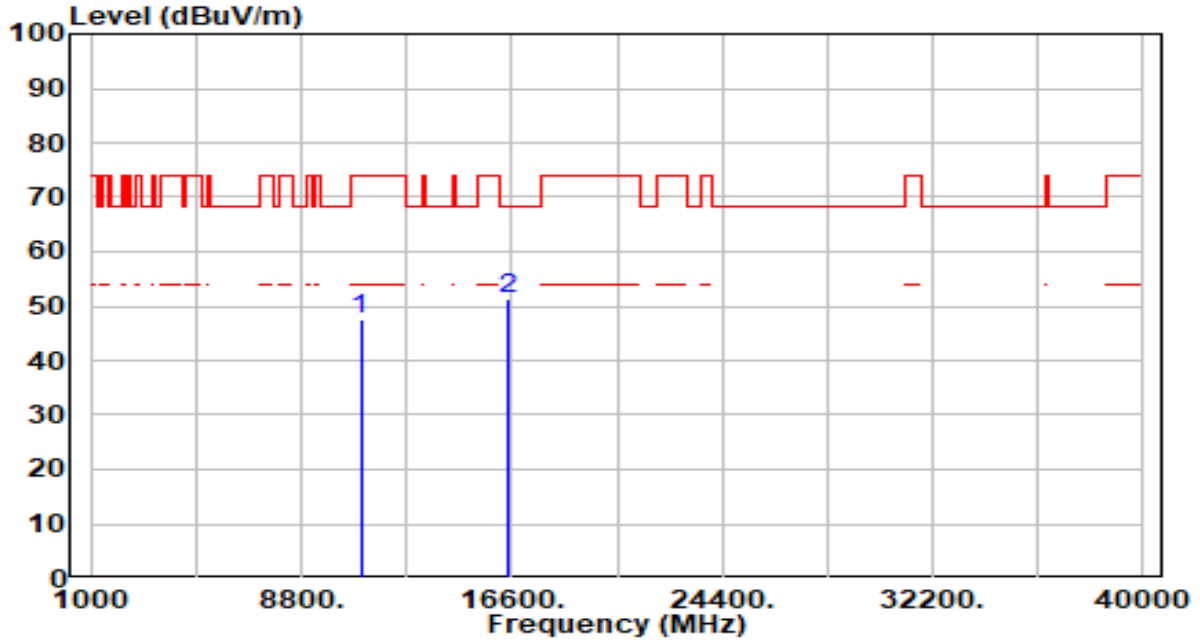

No	Frequency (MHz)	Reading (dBUV)	C.F (dB/m)	Measurement (dBUV/m)	Margin (dB)	Limit (dBUV/m)	Height (cm)	Angle (deg)	Remark (QP/PK/AV)
1	11000.000	43.20	4.52	47.72	-26.28	74.00	100	84	Peak
2	* 16500.000	45.31	6.10	51.41	-16.79	68.20	100	184	Peak

Note:

1. " *", means this data is the worst emission level.
2. C.F (Correction Factor) = Antenna Factor (dB/m)+ Cable Loss (dB) – Preamplifier(dB).
3. Measurement (dBUV/m) = Reading(dBUV) + C.F (Correction Factor).
4. The emission levels of other frequencies are very lower than the limit and not show in test report.

EUT	WiFi Module	Date of Test	2024-03-06
Factor	DRH18-E & BBHA 9170	Temp. / Humidity	23°C /61%
Polarity	Horizontal	Site / Test Engineer	AC2 / Marvin
Test Mode	802.11a_TX_Band3_CH 116_ANT 0	Test Voltage	By Notebook PC

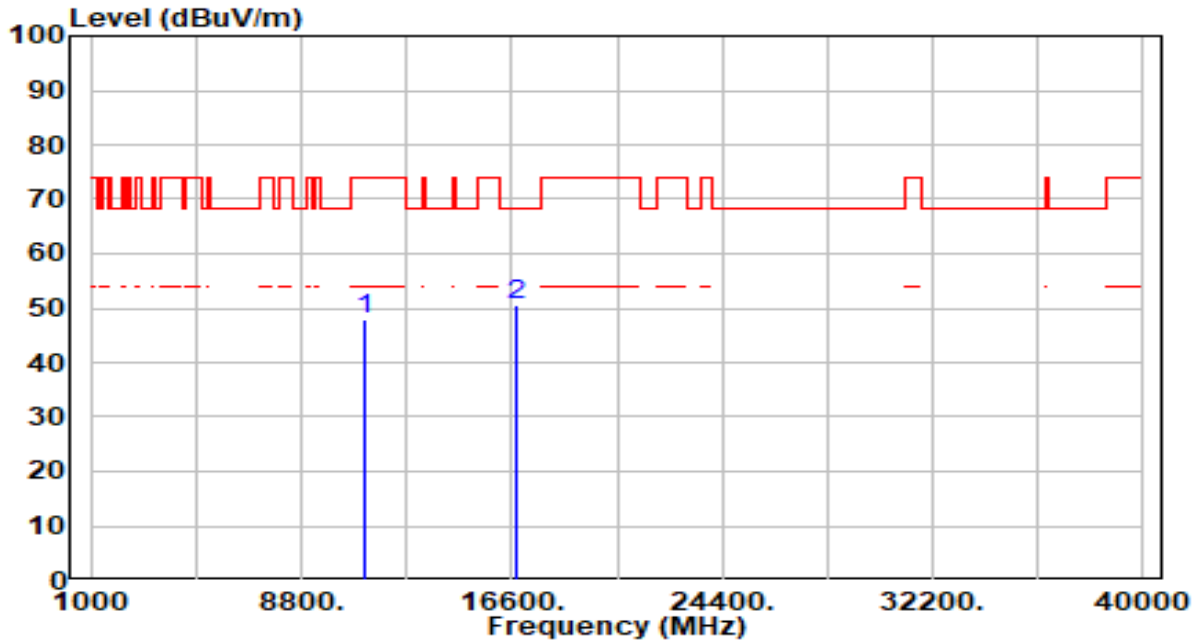

No	Frequency (MHz)	Reading (dBUV)	C.F (dB/m)	Measurement (dBUV/m)	Margin (dB)	Limit (dBUV/m)	Height (cm)	Angle (deg)	Remark (QP/PK/AV)
1	11160.000	43.07	4.94	48.01	-25.99	74.00	100	360	Peak
2	* 16740.000	44.48	6.19	50.67	-17.53	68.20	100	71	Peak

Note:

1. " *", means this data is the worst emission level.
2. C.F (Correction Factor) = Antenna Factor (dB/m)+ Cable Loss (dB) – Preamplifier(dB).
3. Measurement (dBUV/m) = Reading(dBUV) + C.F (Correction Factor).
4. The emission levels of other frequencies are very lower than the limit and not show in test report.

EUT	WiFi Module	Date of Test	2024-03-06
Factor	DRH18-E & BBHA 9170	Temp. / Humidity	23°C /61%
Polarity	Vertical	Site / Test Engineer	AC2 / Marvin
Test Mode	802.11a_TX_Band3_CH 116_ANT 0	Test Voltage	By Notebook PC

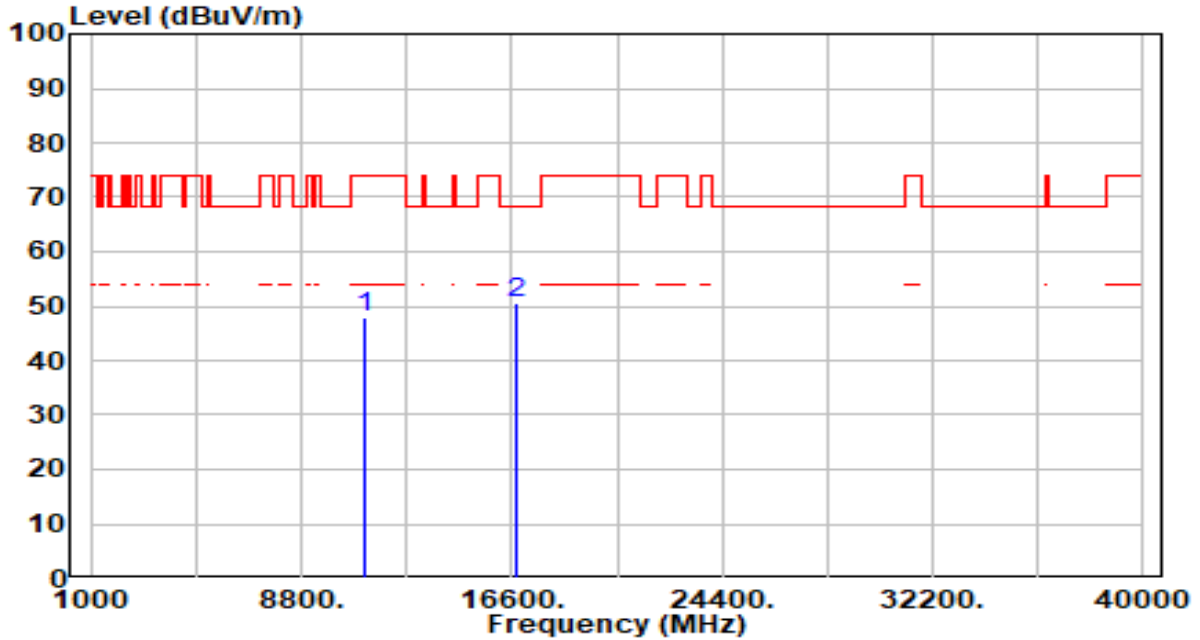

No	Frequency (MHz)	Reading (dBUV)	C.F (dB/m)	Measurement (dBUV/m)	Margin (dB)	Limit (dBUV/m)	Height (cm)	Angle (deg)	Remark (QP/PK/AV)
1	11160.000	42.85	4.94	47.79	-26.21	74.00	100	145	Peak
2	* 16740.000	44.44	6.19	50.63	-17.57	68.20	100	181	Peak

Note:

1. " *", means this data is the worst emission level.
2. C.F (Correction Factor) = Antenna Factor (dB/m)+ Cable Loss (dB) – Preamplifier(dB).
3. Measurement (dBUV/m) = Reading(dBUV) + C.F (Correction Factor).
4. The emission levels of other frequencies are very lower than the limit and not show in test report.

EUT	WiFi Module	Date of Test	2024-03-06
Factor	DRH18-E & BBHA 9170	Temp. / Humidity	23°C /61%
Polarity	Horizontal	Site / Test Engineer	AC2 / Marvin
Test Mode	802.11a_TX_Band3_CH 140_ANT 0	Test Voltage	By Notebook PC

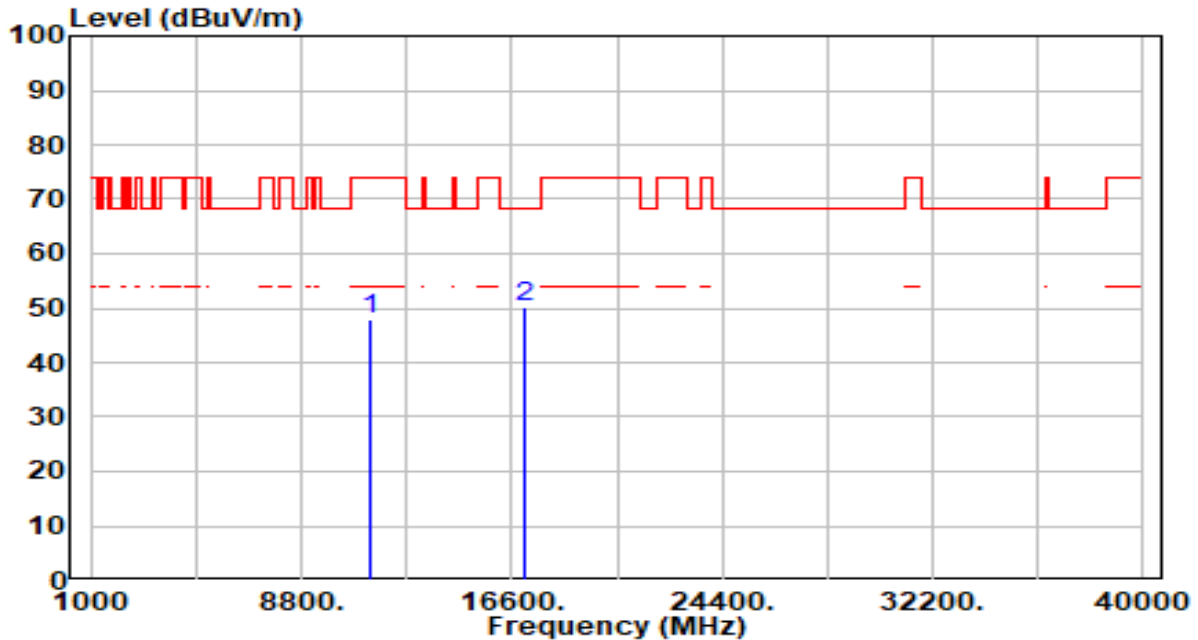

No	Frequency (MHz)	Reading (dBUV)	C.F (dB/m)	Measurement (dBUV/m)	Margin (dB)	Limit (dBUV/m)	Height (cm)	Angle (deg)	Remark (QP/PK/AV)
1	11400.000	42.63	5.26	47.90	-26.10	74.00	100	188	Peak
2	* 17100.000	44.08	5.97	50.05	-18.15	68.20	100	304	Peak

Note:

1. " *", means this data is the worst emission level.
2. C.F (Correction Factor) = Antenna Factor (dB/m)+ Cable Loss (dB) – Preamplifier(dB).
3. Measurement (dBUV/m) = Reading(dBUV) + C.F (Correction Factor).
4. The emission levels of other frequencies are very lower than the limit and not show in test report.

EUT	WiFi Module	Date of Test	2024-03-06
Factor	DRH18-E & BBHA 9170	Temp. / Humidity	23°C /61%
Polarity	Vertical	Site / Test Engineer	AC2 / Marvin
Test Mode	802.11a_TX_Band3_CH 140_ANT 0	Test Voltage	By Notebook PC

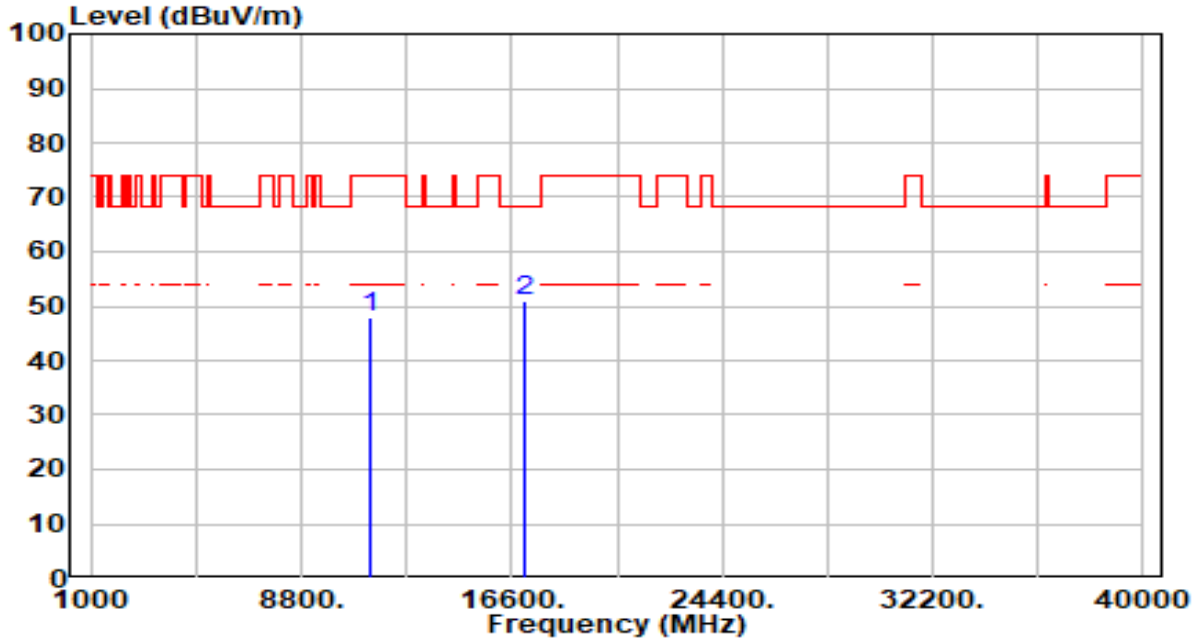

No	Frequency (MHz)	Reading (dBUV)	C.F (dB/m)	Measurement (dBUV/m)	Margin (dB)	Limit (dBUV/m)	Height (cm)	Angle (deg)	Remark (QP/PK/AV)
1	11400.000	42.58	5.26	47.84	-26.16	74.00	100	152	Peak
2	* 17100.000	44.90	5.97	50.88	-17.32	68.20	100	110	Peak

Note:

1. " *", means this data is the worst emission level.
2. C.F (Correction Factor) = Antenna Factor (dB/m)+ Cable Loss (dB) – Preamplifier(dB).
3. Measurement (dBUV/m) = Reading(dBUV) + C.F (Correction Factor).
4. The emission levels of other frequencies are very lower than the limit and not show in test report.

EUT	WiFi Module	Date of Test	2024-03-06
Factor	DRH18-E & BBHA 9170	Temp. / Humidity	23°C /61%
Polarity	Horizontal	Site / Test Engineer	AC2 / Marvin
Test Mode	802.11a_TX_Band3_CH 144_ANT 0	Test Voltage	By Notebook PC

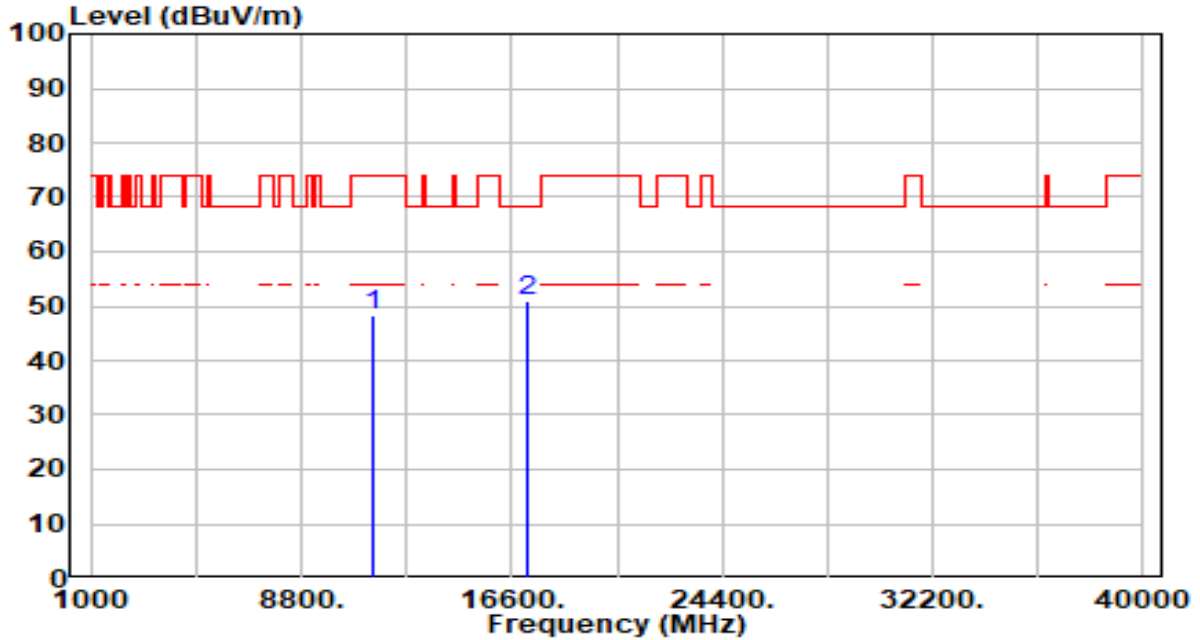

No	Frequency (MHz)	Reading (dBUV)	C.F (dB/m)	Measurement (dBUV/m)	Margin (dB)	Limit (dBUV/m)	Height (cm)	Angle (deg)	Remark (QP/PK/AV)
1	11440.000	43.17	5.29	48.45	-25.55	74.00	100	292	Peak
2	* 17160.000	45.26	5.87	51.13	-17.07	68.20	100	102	Peak

Note:

1. " *", means this data is the worst emission level.
2. C.F (Correction Factor) = Antenna Factor (dB/m)+ Cable Loss (dB) – Preamplifier(dB).
3. Measurement (dBUV/m) = Reading(dBUV) + C.F (Correction Factor).
4. The emission levels of other frequencies are very lower than the limit and not show in test report.

EUT	WiFi Module	Date of Test	2024-03-06
Factor	DRH18-E & BBHA 9170	Temp. / Humidity	23°C /61%
Polarity	Vertical	Site / Test Engineer	AC2 / Marvin
Test Mode	802.11a_TX_Band3_CH 144_ANT 0	Test Voltage	By Notebook PC

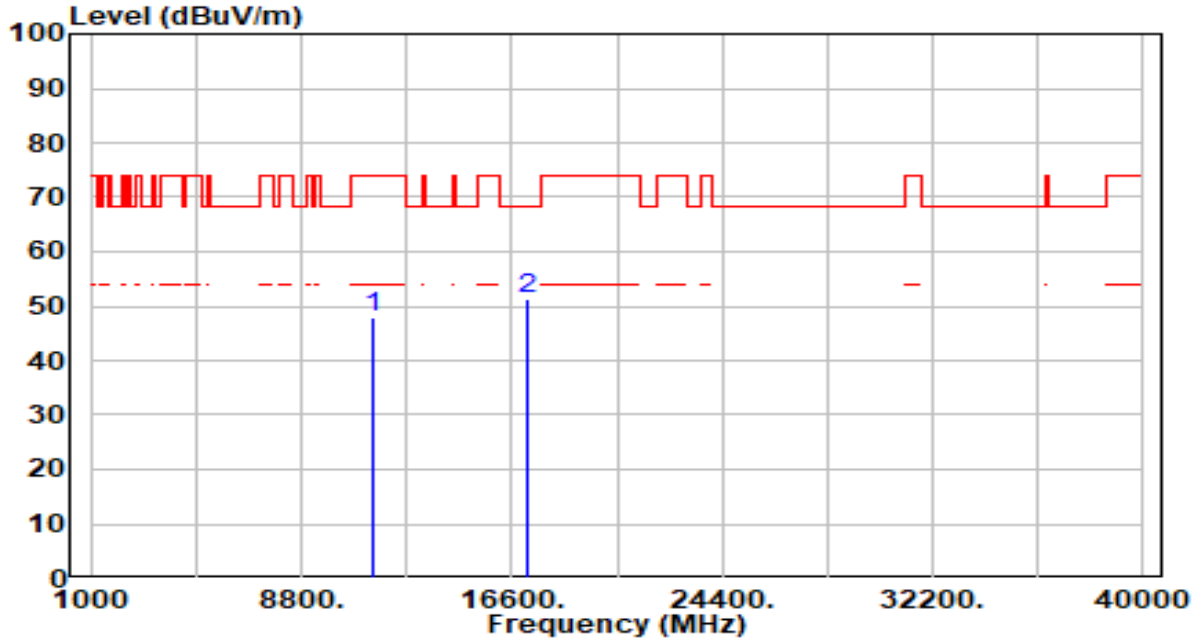

No	Frequency (MHz)	Reading (dBUV)	C.F (dB/m)	Measurement (dBUV/m)	Margin (dB)	Limit (dBUV/m)	Height (cm)	Angle (deg)	Remark (QP/PK/AV)
1	11440.000	42.67	5.29	47.96	-26.04	74.00	100	198	Peak
2	* 17160.000	45.36	5.87	51.23	-16.97	68.20	100	0	Peak

Note:

1. " *", means this data is the worst emission level.
2. C.F (Correction Factor) = Antenna Factor (dB/m)+ Cable Loss (dB) – Preamplifier(dB).
3. Measurement (dBUV/m) = Reading(dBUV) + C.F (Correction Factor).
4. The emission levels of other frequencies are very lower than the limit and not show in test report.

EUT	WiFi Module	Date of Test	2024-03-06
Factor	DRH18-E & BBHA 9170	Temp. / Humidity	23°C /61%
Polarity	Horizontal	Site / Test Engineer	AC2 / Marvin
Test Mode	802.11a_TX_Band4_CH 149_ANT 0	Test Voltage	By Notebook PC

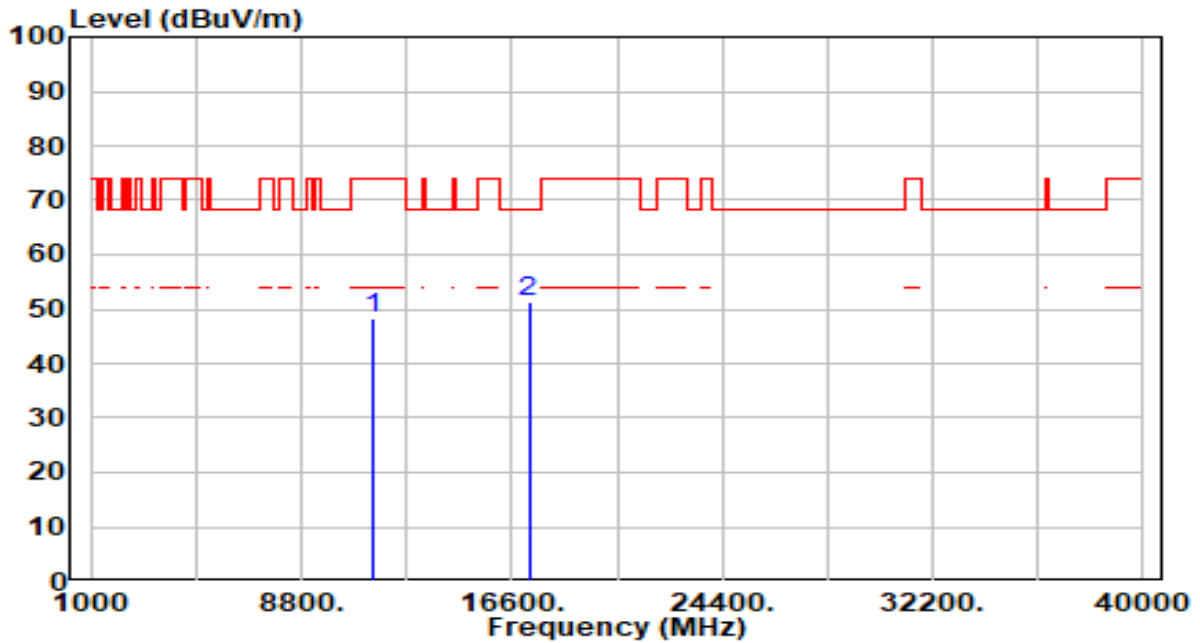

No	Frequency (MHz)	Reading (dBuV)	C.F (dB/m)	Measurement (dBuV/m)	Margin (dB)	Limit (dBuV/m)	Height (cm)	Angle (deg)	Remark (QP/PK/AV)
1	11490.000	42.83	5.32	48.15	-25.85	74.00	100	207	Peak
2	* 17235.000	45.59	5.71	51.30	-16.90	68.20	100	68	Peak

Note:

1. " *", means this data is the worst emission level.
2. C.F (Correction Factor) = Antenna Factor (dB/m)+ Cable Loss (dB) – Pre-amplifier(dB).
3. Measurement (dBuV/m) = Reading(dBuV) + C.F (Correction Factor).
4. The emission levels of other frequencies are very lower than the limit and not show in test report.

EUT	WiFi Module	Date of Test	2024-03-06
Factor	DRH18-E & BBHA 9170	Temp. / Humidity	23°C /61%
Polarity	Vertical	Site / Test Engineer	AC2 / Marvin
Test Mode	802.11a_TX_Band4_CH 149_ANT 0	Test Voltage	By Notebook PC

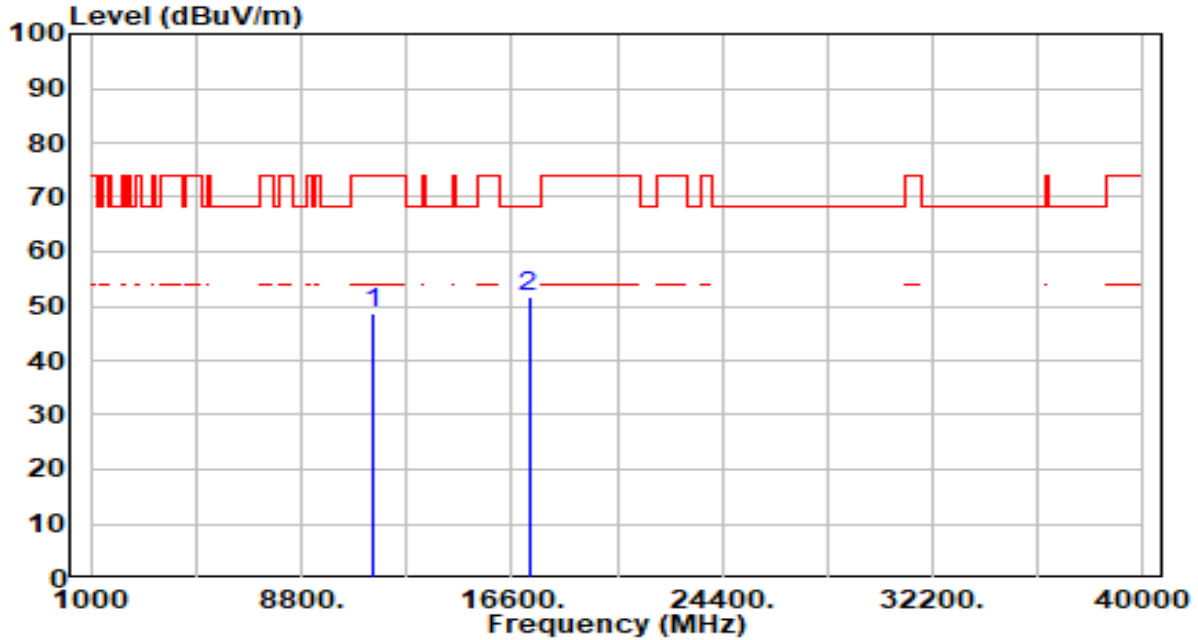

No	Frequency (MHz)	Reading (dBUV)	C.F (dB/m)	Measurement (dBUV/m)	Margin (dB)	Limit (dBUV/m)	Height (cm)	Angle (deg)	Remark (QP/PK/AV)
1	11490.000	43.55	5.32	48.86	-25.14	74.00	300	91	Peak
2	* 17235.000	46.03	5.71	51.74	-16.46	68.20	100	259	Peak

Note:

1. " *", means this data is the worst emission level.
2. C.F (Correction Factor) = Antenna Factor (dB/m)+ Cable Loss (dB) – Preamplifier(dB).
3. Measurement (dBUV/m) = Reading(dBUV) + C.F (Correction Factor).
4. The emission levels of other frequencies are very lower than the limit and not show in test report.

EUT	WiFi Module	Date of Test	2024-03-06
Factor	DRH18-E & BBHA 9170	Temp. / Humidity	23°C /61%
Polarity	Horizontal	Site / Test Engineer	AC2 / Marvin
Test Mode	802.11a_TX_Band4_CH 157_ANT 0	Test Voltage	By Notebook PC

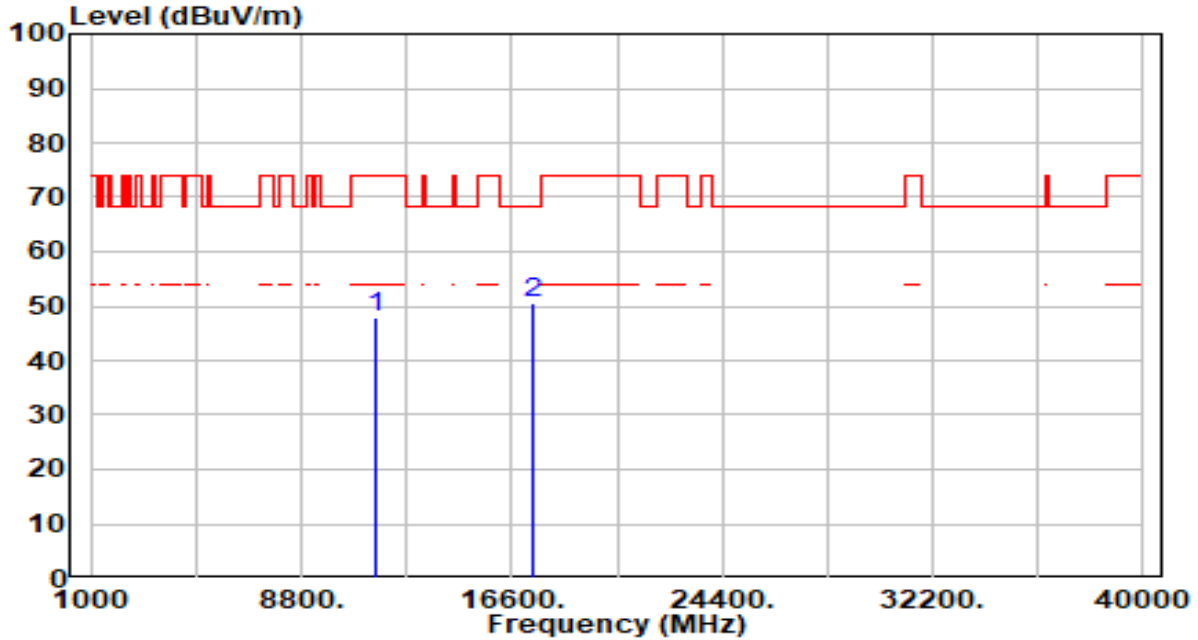

No	Frequency (MHz)	Reading (dBUV)	C.F (dB/m)	Measurement (dBUV/m)	Margin (dB)	Limit (dBUV/m)	Height (cm)	Angle (deg)	Remark (QP/PK/AV)
1	11570.000	42.55	5.38	47.93	-26.07	74.00	100	179	Peak
2	* 17355.000	45.34	5.39	50.73	-17.47	68.20	100	224	Peak

Note:

1. " *", means this data is the worst emission level.
2. C.F (Correction Factor) = Antenna Factor (dB/m)+ Cable Loss (dB) – Preamplifier(dB).
3. Measurement (dBUV/m) = Reading(dBUV) + C.F (Correction Factor).
4. The emission levels of other frequencies are very lower than the limit and not show in test report.

EUT	WiFi Module	Date of Test	2024-03-06
Factor	DRH18-E & BBHA 9170	Temp. / Humidity	23°C /61%
Polarity	Vertical	Site / Test Engineer	AC2 / Marvin
Test Mode	802.11a_TX_Band4_CH 157_ANT 0	Test Voltage	By Notebook PC

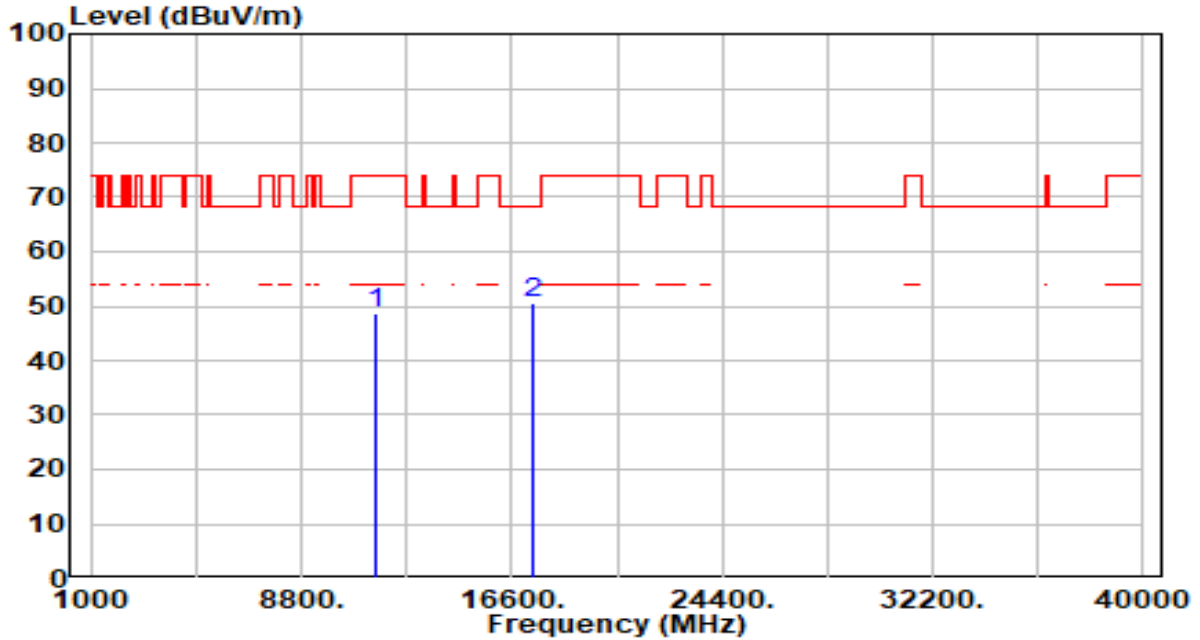

No	Frequency (MHz)	Reading (dBUV)	C.F (dB/m)	Measurement (dBUV/m)	Margin (dB)	Limit (dBUV/m)	Height (cm)	Angle (deg)	Remark (QP/PK/AV)
1	11570.000	43.34	5.38	48.72	-25.28	74.00	100	48	Peak
2	* 17355.000	45.15	5.39	50.54	-17.66	68.20	100	360	Peak

Note:

1. " *", means this data is the worst emission level.
2. C.F (Correction Factor) = Antenna Factor (dB/m)+ Cable Loss (dB) – Preamplifier(dB).
3. Measurement (dBUV/m) = Reading(dBUV) + C.F (Correction Factor).
4. The emission levels of other frequencies are very lower than the limit and not show in test report.

EUT	WiFi Module	Date of Test	2024-03-06
Factor	DRH18-E & BBHA 9170	Temp. / Humidity	23°C /61%
Polarity	Horizontal	Site / Test Engineer	AC2 / Marvin
Test Mode	802.11a_TX_Band4_CH 165_ANT 0	Test Voltage	By Notebook PC

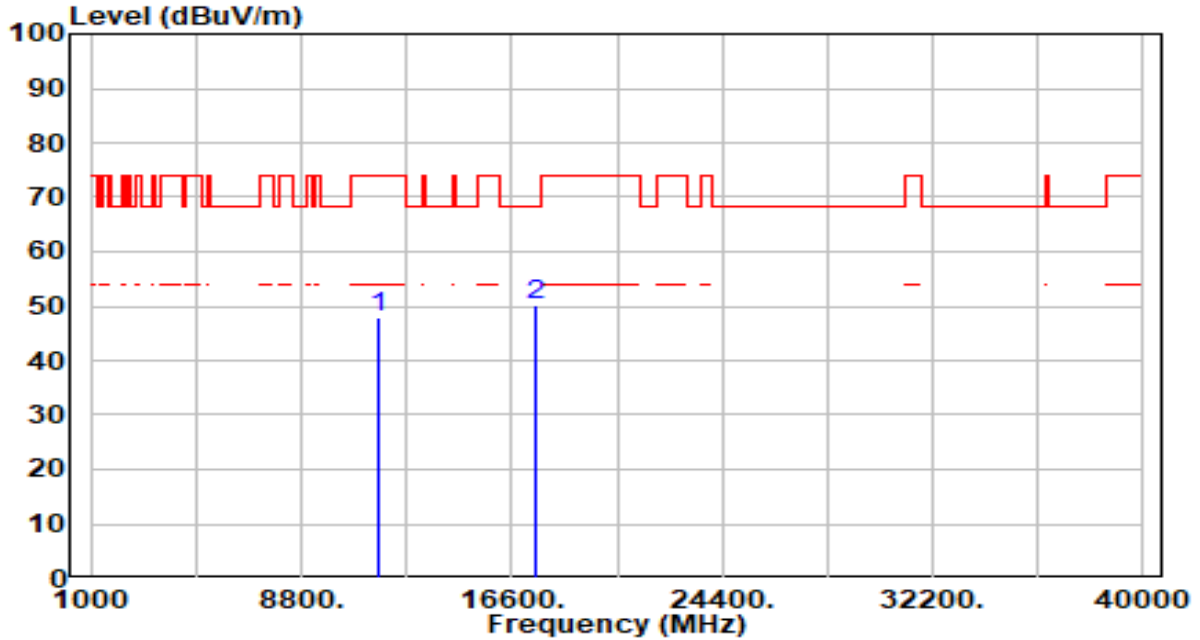

No	Frequency (MHz)	Reading (dBUV)	C.F (dB/m)	Measurement (dBUV/m)	Margin (dB)	Limit (dBUV/m)	Height (cm)	Angle (deg)	Remark (QP/PK/AV)
1	11650.000	42.42	5.36	47.78	-26.22	74.00	100	284	Peak
2	* 17475.000	45.08	5.29	50.38	-17.82	68.20	100	0	Peak

Note:

1. " *", means this data is the worst emission level.
2. C.F (Correction Factor) = Antenna Factor (dB/m)+ Cable Loss (dB) – Preamplifier(dB).
3. Measurement (dBUV/m) = Reading(dBUV) + C.F (Correction Factor).
4. The emission levels of other frequencies are very lower than the limit and not show in test report.

EUT	WiFi Module	Date of Test	2024-03-06
Factor	DRH18-E & BBHA 9170	Temp. / Humidity	23°C /61%
Polarity	Vertical	Site / Test Engineer	AC2 / Marvin
Test Mode	802.11a_TX_Band4_CH 165_ANT 0	Test Voltage	By Notebook PC

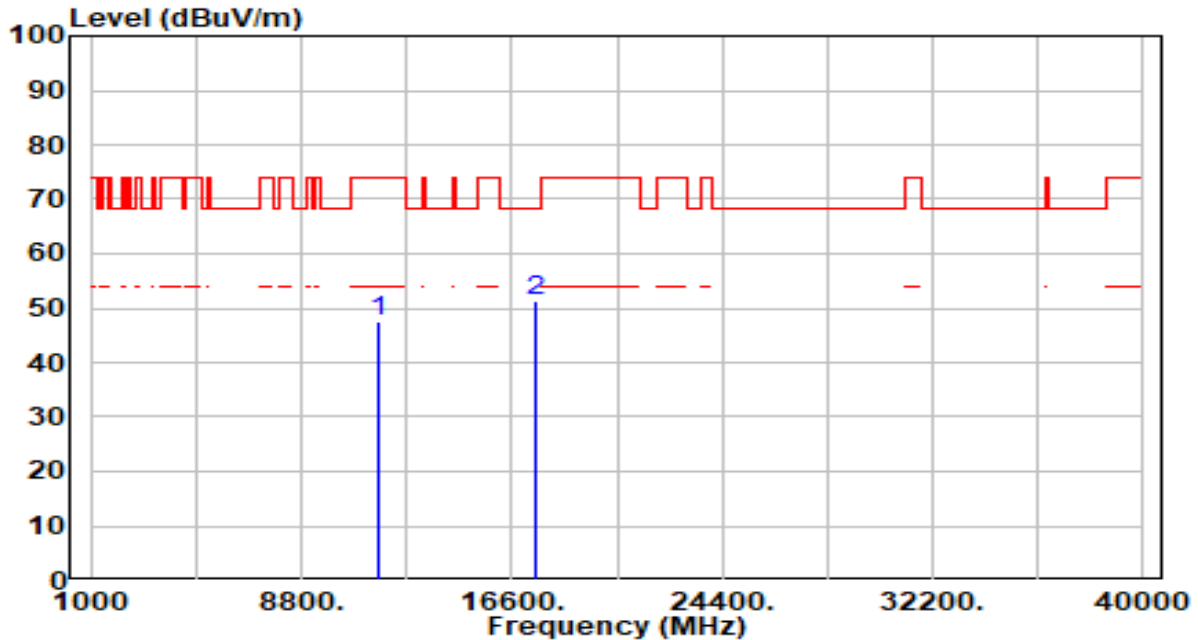

No	Frequency (MHz)	Reading (dBUV)	C.F (dB/m)	Measurement (dBUV/m)	Margin (dB)	Limit (dBUV/m)	Height (cm)	Angle (deg)	Remark (QP/PK/AV)
1	11650.000	42.01	5.36	47.37	-26.63	74.00	100	85	Peak
2	* 17475.000	46.02	5.29	51.32	-16.88	68.20	100	88	Peak

Note:

1. " *", means this data is the worst emission level.
2. C.F (Correction Factor) = Antenna Factor (dB/m)+ Cable Loss (dB) – Preamplifier(dB).
3. Measurement (dBUV/m) = Reading(dBUV) + C.F (Correction Factor).
4. The emission levels of other frequencies are very lower than the limit and not show in test report.

EUT	WiFi Module	Date of Test	2024-03-06
Factor	DRH18-E & BBHA 9170	Temp. / Humidity	23°C /61%
Polarity	Horizontal	Site / Test Engineer	AC2 / Marvin
Test Mode	802.11ac-20MHz_TX_Band1_CH 36_ANT 0	Test Voltage	By Notebook PC

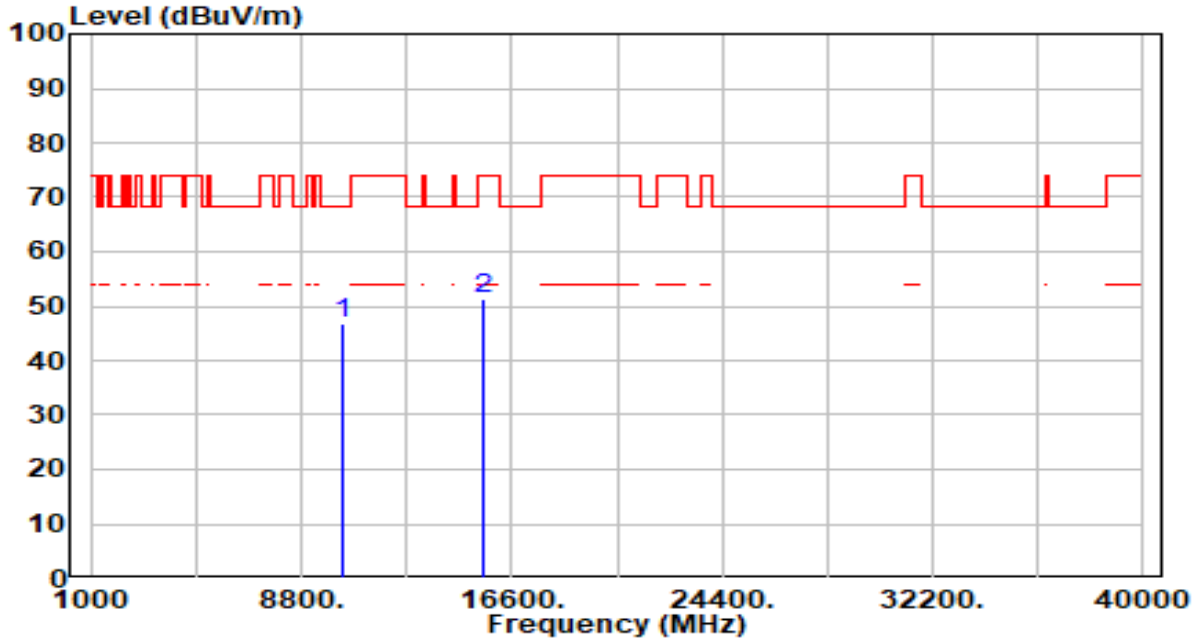

No	Frequency (MHz)	Reading (dBUV)	C.F (dB/m)	Measurement (dBUV/m)	Margin (dB)	Limit (dBUV/m)	Height (cm)	Angle (deg)	Remark (QP/PK/AV)
1	* 10360.000	41.97	4.87	46.84	-21.36	68.20	100	64	Peak
2	15540.000	45.22	6.21	51.42	-22.58	74.00	100	70	Peak

Note:

1. " *", means this data is the worst emission level.
2. C.F (Correction Factor) = Antenna Factor (dB/m)+ Cable Loss (dB) – Preamplifier(dB).
3. Measurement (dBUV/m) = Reading(dBUV) + C.F (Correction Factor).
4. The emission levels of other frequencies are very lower than the limit and not show in test report.

EUT	WiFi Module	Date of Test	2024-03-06
Factor	DRH18-E & BBHA 9170	Temp. / Humidity	23°C /61%
Polarity	Vertical	Site / Test Engineer	AC2 / Marvin
Test Mode	802.11ac-20MHz_TX_Band1_CH 36_ANT 0	Test Voltage	By Notebook PC

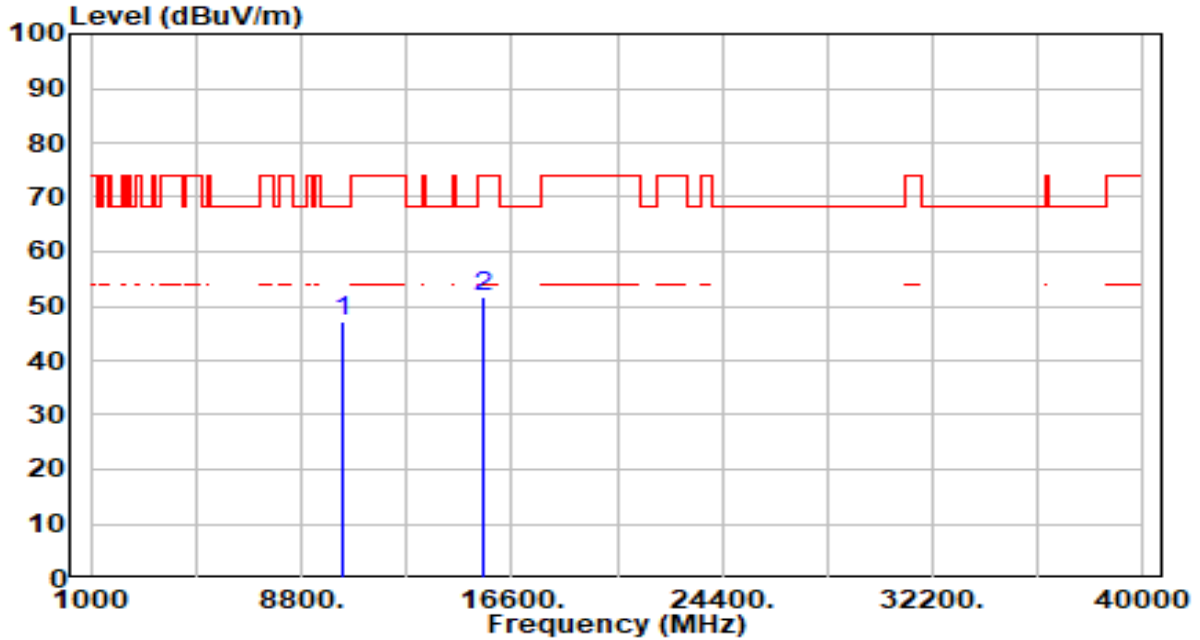

No	Frequency (MHz)	Reading (dBUV)	C.F (dB/m)	Measurement (dBUV/m)	Margin (dB)	Limit (dBUV/m)	Height (cm)	Angle (deg)	Remark (QP/PK/AV)
1	* 10360.000	42.34	4.87	47.21	-20.99	68.20	100	286	Peak
2	15540.000	45.60	6.21	51.80	-22.20	74.00	100	173	Peak

Note:

1. " *", means this data is the worst emission level.
2. C.F (Correction Factor) = Antenna Factor (dB/m)+ Cable Loss (dB) – Preamplifier(dB).
3. Measurement (dBUV/m) = Reading(dBUV) + C.F (Correction Factor).
4. The emission levels of other frequencies are very lower than the limit and not show in test report.

EUT	WiFi Module	Date of Test	2024-03-06
Factor	DRH18-E & BBHA 9170	Temp. / Humidity	23°C /61%
Polarity	Horizontal	Site / Test Engineer	AC2 / Marvin
Test Mode	802.11ac-20MHz_TX_Band1_CH 44_ANT 0	Test Voltage	By Notebook PC

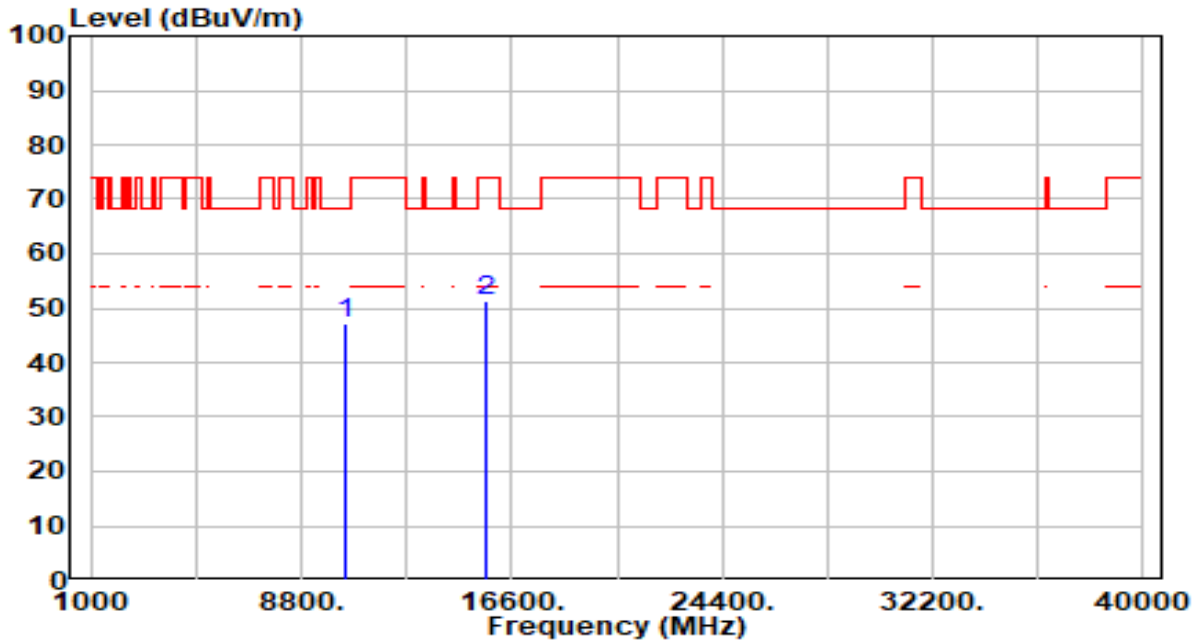

No	Frequency (MHz)	Reading (dBuV)	C.F (dB/m)	Measurement (dBuV/m)	Margin (dB)	Limit (dBuV/m)	Height (cm)	Angle (deg)	Remark (QP/PK/AV)
1	* 10440.000	42.55	4.76	47.32	-20.88	68.20	100	336	Peak
2	15660.000	45.19	6.27	51.46	-22.54	74.00	100	245	Peak

Note:

1. " *", means this data is the worst emission level.
2. C.F (Correction Factor) = Antenna Factor (dB/m)+ Cable Loss (dB) – Preamplifier(dB).
3. Measurement (dBuV/m) = Reading(dBuV) + C.F (Correction Factor).
4. The emission levels of other frequencies are very lower than the limit and not show in test report.

EUT	WiFi Module	Date of Test	2024-03-06
Factor	DRH18-E & BBHA 9170	Temp. / Humidity	23°C /61%
Polarity	Vertical	Site / Test Engineer	AC2 / Marvin
Test Mode	802.11ac-20MHz_TX_Band1_CH 44_ANT 0	Test Voltage	By Notebook PC

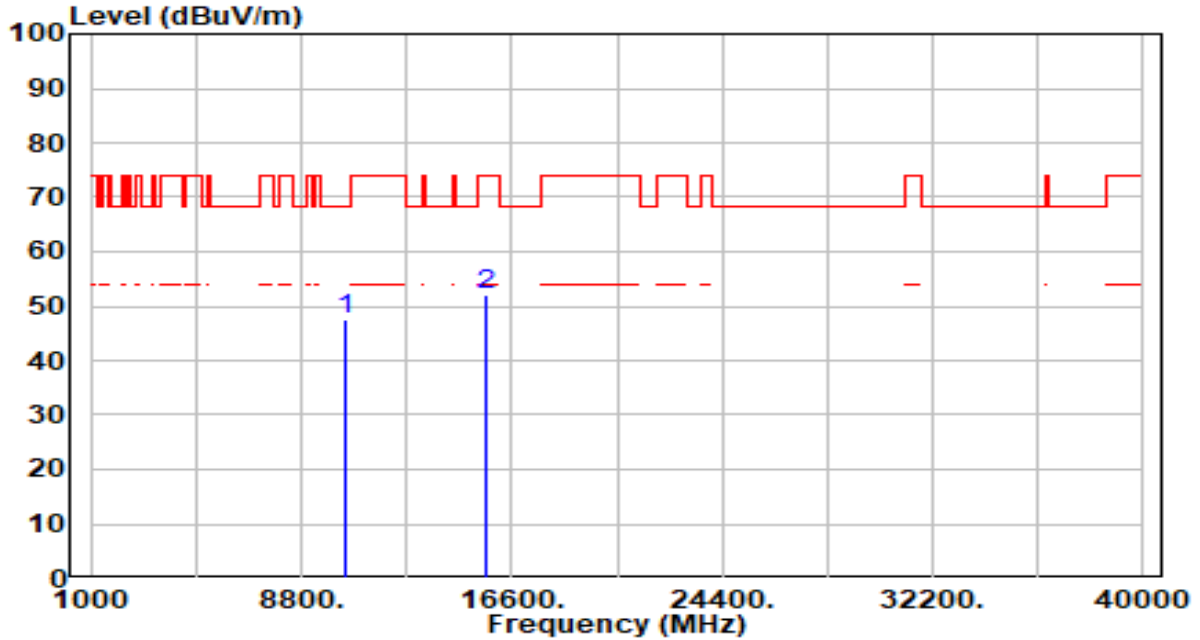

No	Frequency (MHz)	Reading (dBuV)	C.F (dB/m)	Measurement (dBuV/m)	Margin (dB)	Limit (dBuV/m)	Height (cm)	Angle (deg)	Remark (QP/PK/AV)
1	* 10440.000	42.87	4.76	47.63	-20.57	68.20	100	357	Peak
2	15660.000	45.84	6.27	52.11	-21.89	74.00	100	134	Peak

Note:

1. " *", means this data is the worst emission level.
2. C.F (Correction Factor) = Antenna Factor (dB/m)+ Cable Loss (dB) – Preamplifier(dB).
3. Measurement (dBuV/m) = Reading(dBuV) + C.F (Correction Factor).
4. The emission levels of other frequencies are very lower than the limit and not show in test report.

EUT	WiFi Module	Date of Test	2024-03-06
Factor	DRH18-E & BBHA 9170	Temp. / Humidity	23°C /61%
Polarity	Horizontal	Site / Test Engineer	AC2 / Marvin
Test Mode	802.11ac-20MHz_TX_Band1_CH 48_ANT 0	Test Voltage	By Notebook PC

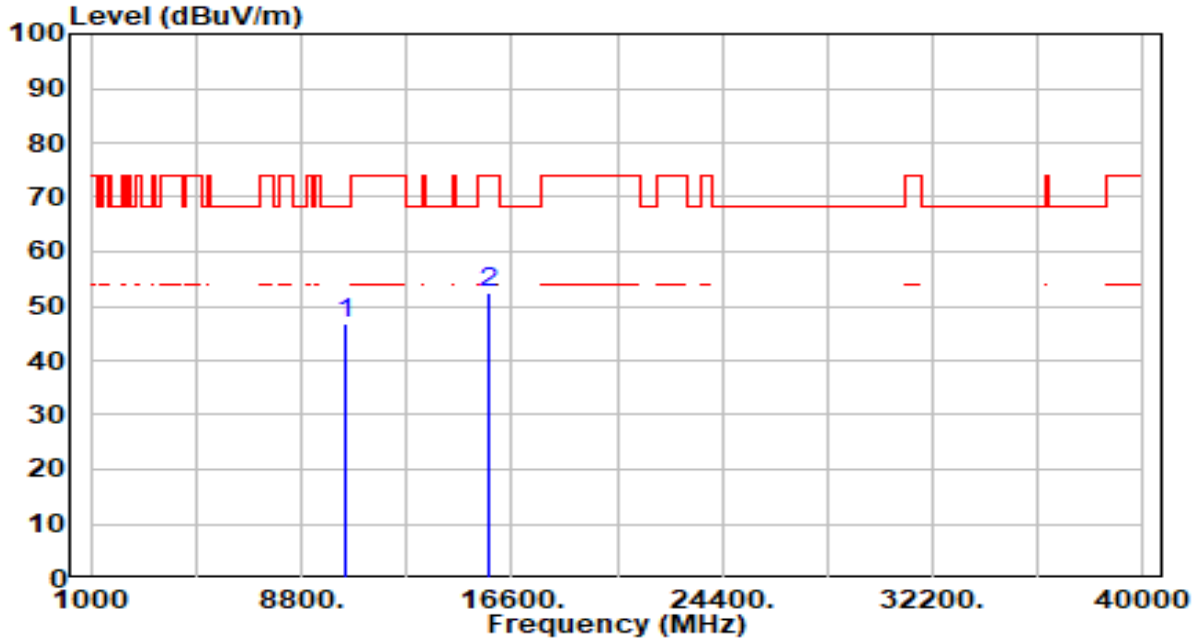

No	Frequency (MHz)	Reading (dBuV)	C.F (dB/m)	Measurement (dBuV/m)	Margin (dB)	Limit (dBuV/m)	Height (cm)	Angle (deg)	Remark (QP/PK/AV)
1	* 10480.000	42.13	4.71	46.85	-21.35	68.20	100	263	Peak
2	15720.000	46.02	6.39	52.41	-21.59	74.00	100	318	Peak

Note:

1. " *", means this data is the worst emission level.
2. C.F (Correction Factor) = Antenna Factor (dB/m)+ Cable Loss (dB) – Preamplifier(dB).
3. Measurement (dBuV/m) = Reading(dBuV) + C.F (Correction Factor).
4. The emission levels of other frequencies are very lower than the limit and not show in test report.

EUT	WiFi Module	Date of Test	2024-03-06
Factor	DRH18-E & BBHA 9170	Temp. / Humidity	23°C /61%
Polarity	Vertical	Site / Test Engineer	AC2 / Marvin
Test Mode	802.11ac-20MHz_TX_Band1_CH 48_ANT 0	Test Voltage	By Notebook PC

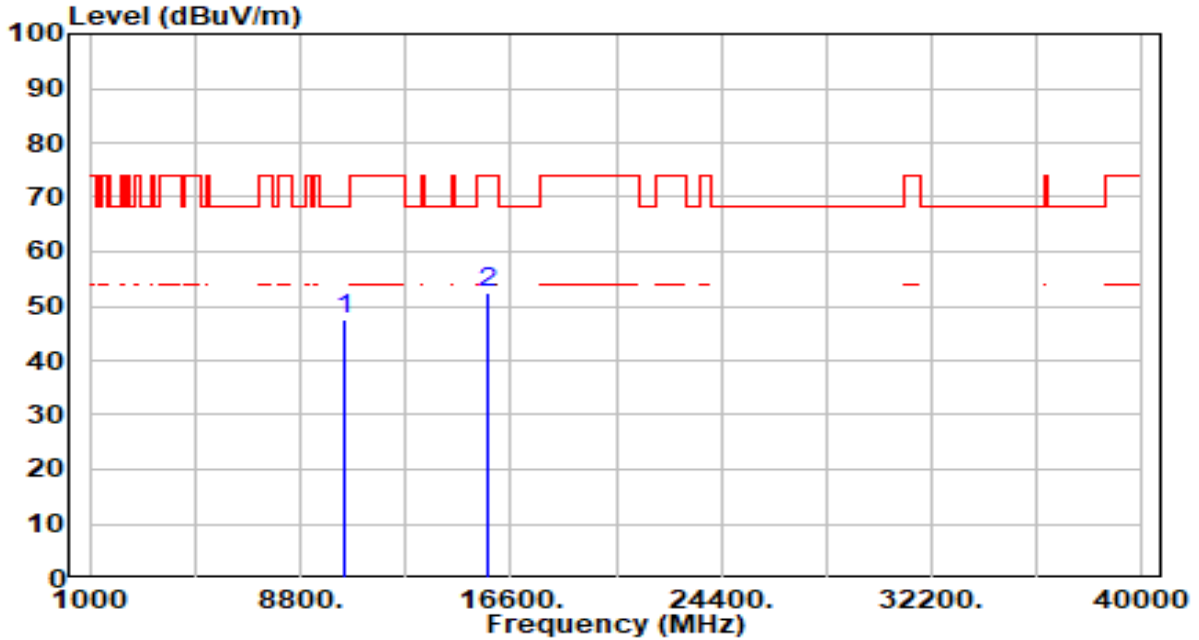

No	Frequency (MHz)	Reading (dBuV)	C.F (dB/m)	Measurement (dBuV/m)	Margin (dB)	Limit (dBuV/m)	Height (cm)	Angle (deg)	Remark (QP/PK/AV)
1	* 10480.000	42.79	4.71	47.50	-20.70	68.20	100	26	Peak
2	15720.000	46.03	6.39	52.41	-21.59	74.00	100	200	Peak

Note:

1. " *", means this data is the worst emission level.
2. C.F (Correction Factor) = Antenna Factor (dB/m)+ Cable Loss (dB) – Preamplifier(dB).
3. Measurement (dBuV/m) = Reading(dBuV) + C.F (Correction Factor).
4. The emission levels of other frequencies are very lower than the limit and not show in test report.

EUT	WiFi Module	Date of Test	2024-03-06
Factor	DRH18-E & BBHA 9170	Temp. / Humidity	23°C /61%
Polarity	Horizontal	Site / Test Engineer	AC2 / Marvin
Test Mode	802.11ac-20MHz_TX_Band2_CH 52_ANT 0	Test Voltage	By Notebook PC

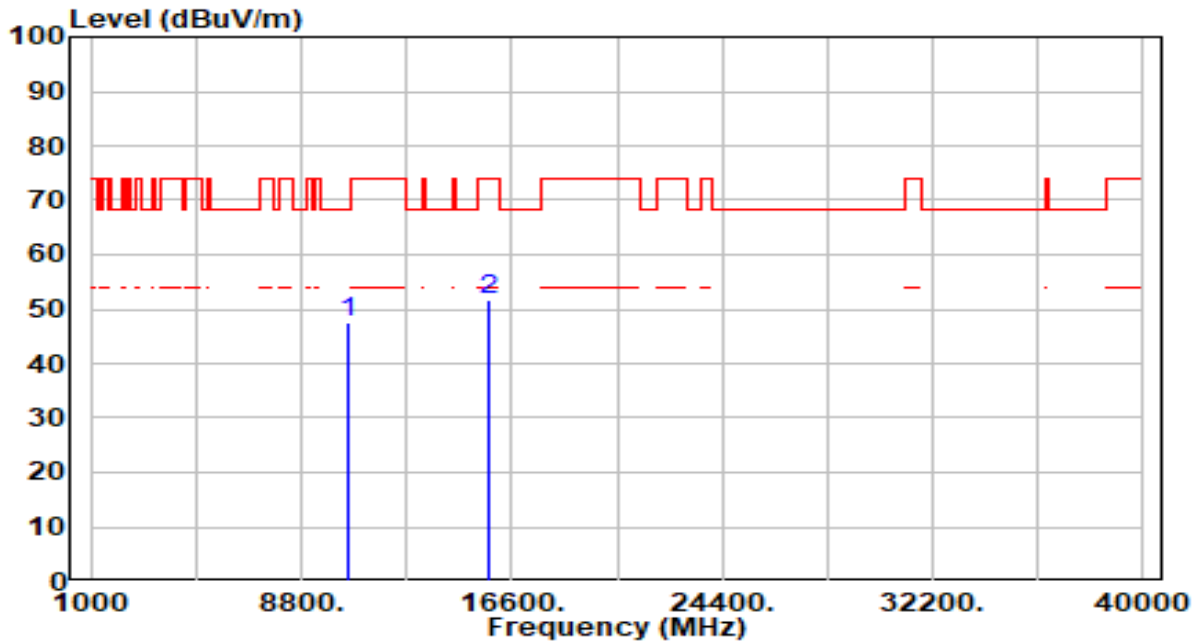

No	Frequency (MHz)	Reading (dBuV)	C.F (dB/m)	Measurement (dBuV/m)	Margin (dB)	Limit (dBuV/m)	Height (cm)	Angle (deg)	Remark (QP/PK/AV)
1	* 10520.000	42.85	4.67	47.52	-20.68	68.20	100	47	Peak
2	15780.000	45.21	6.51	51.72	-22.28	74.00	100	109	Peak

Note:

1. " *", means this data is the worst emission level.
2. C.F (Correction Factor) = Antenna Factor (dB/m)+ Cable Loss (dB) – Preamplifier(dB).
3. Measurement (dBuV/m) = Reading(dBuV) + C.F (Correction Factor).
4. The emission levels of other frequencies are very lower than the limit and not show in test report.

EUT	WiFi Module	Date of Test	2024-03-06
Factor	DRH18-E & BBHA 9170	Temp. / Humidity	23°C /61%
Polarity	Vertical	Site / Test Engineer	AC2 / Marvin
Test Mode	802.11ac-20MHz_TX_Band2_CH 52_ANT 0	Test Voltage	By Notebook PC

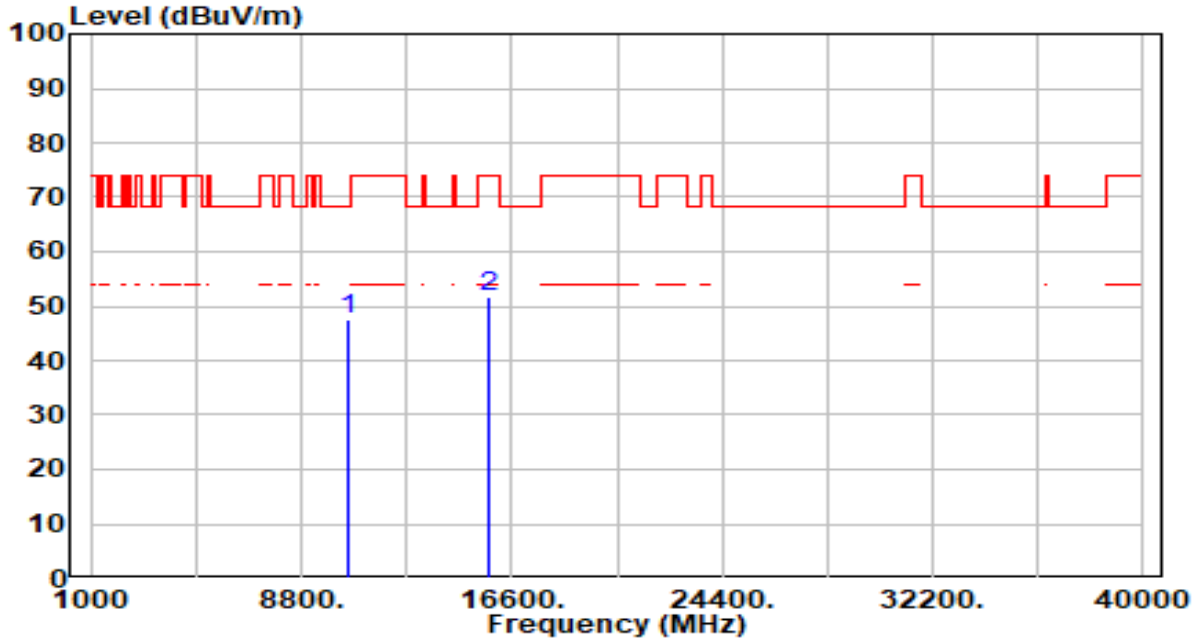

No	Frequency (MHz)	Reading (dBuV)	C.F (dB/m)	Measurement (dBuV/m)	Margin (dB)	Limit (dBuV/m)	Height (cm)	Angle (deg)	Remark (QP/PK/AV)
1	* 10520.000	43.05	4.67	47.72	-20.48	68.20	100	19	Peak
2	15780.000	45.08	6.51	51.59	-22.41	74.00	100	251	Peak

Note:

1. " *", means this data is the worst emission level.
2. C.F (Correction Factor) = Antenna Factor (dB/m)+ Cable Loss (dB) – Preamplifier(dB).
3. Measurement (dBuV/m) = Reading(dBuV) + C.F (Correction Factor).
4. The emission levels of other frequencies are very lower than the limit and not show in test report.

EUT	WiFi Module	Date of Test	2024-03-06
Factor	DRH18-E & BBHA 9170	Temp. / Humidity	23°C /61%
Polarity	Horizontal	Site / Test Engineer	AC2 / Marvin
Test Mode	802.11ac-20MHz_TX_Band2_CH 60_ANT 0	Test Voltage	By Notebook PC

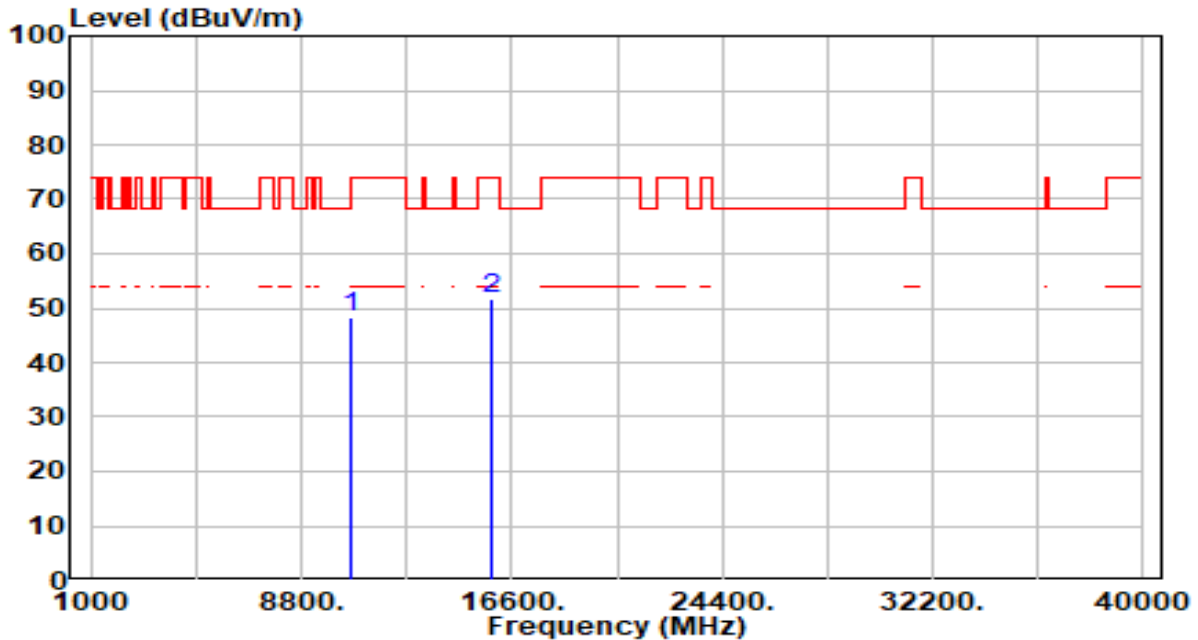

No	Frequency (MHz)	Reading (dBUV)	C.F (dB/m)	Measurement (dBUV/m)	Margin (dB)	Limit (dBUV/m)	Height (cm)	Angle (deg)	Remark (QP/PK/AV)
1	*	43.60	4.61	48.22	-19.98	68.20	100	194	Peak
2		45.01	6.55	51.56	-22.44	74.00	100	242	Peak

Note:

1. " *", means this data is the worst emission level.
2. C.F (Correction Factor) = Antenna Factor (dB/m)+ Cable Loss (dB) – Preamplifier(dB).
3. Measurement (dBUV/m) = Reading(dBUV) + C.F (Correction Factor).
4. The emission levels of other frequencies are very lower than the limit and not show in test report.

EUT	WiFi Module	Date of Test	2024-03-06
Factor	DRH18-E & BBHA 9170	Temp. / Humidity	23°C /61%
Polarity	Vertical	Site / Test Engineer	AC2 / Marvin
Test Mode	802.11ac-20MHz_TX_Band2_CH 60_ANT 0	Test Voltage	By Notebook PC

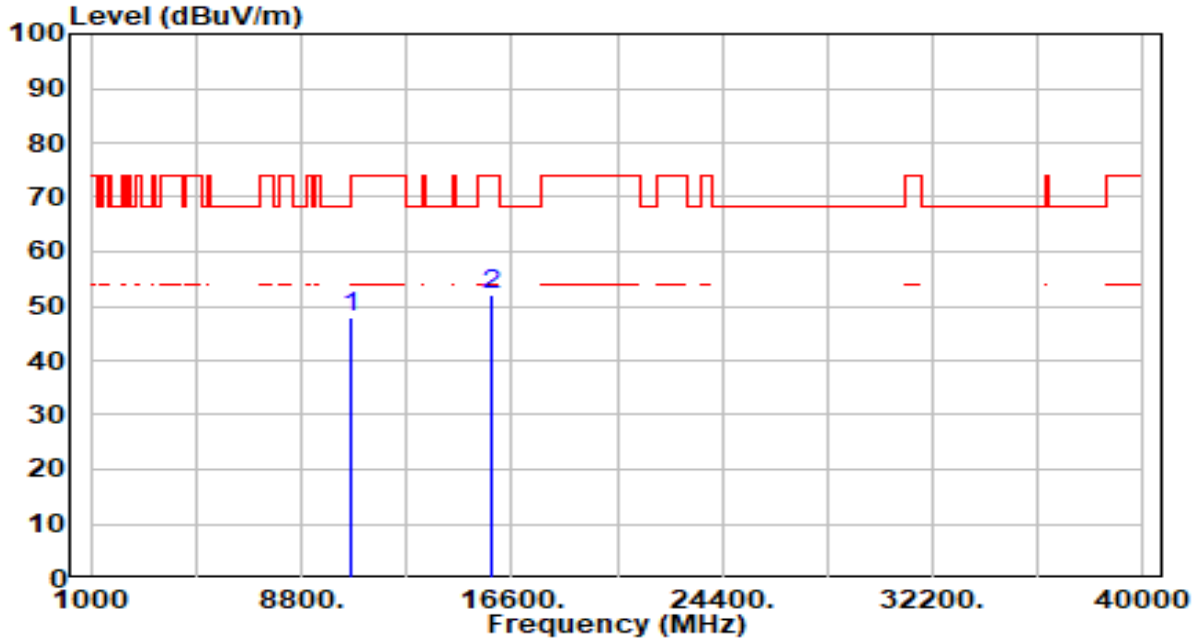

No	Frequency (MHz)	Reading (dBUV)	C.F (dB/m)	Measurement (dBUV/m)	Margin (dB)	Limit (dBUV/m)	Height (cm)	Angle (deg)	Remark (QP/PK/AV)
1	* 10600.000	43.15	4.61	47.76	-20.44	68.20	100	0	Peak
2	15900.000	45.46	6.55	52.00	-22.00	74.00	100	107	Peak

Note:

1. " *", means this data is the worst emission level.
2. C.F (Correction Factor) = Antenna Factor (dB/m)+ Cable Loss (dB) – Preamplifier(dB).
3. Measurement (dBUV/m) = Reading(dBUV) + C.F (Correction Factor).
4. The emission levels of other frequencies are very lower than the limit and not show in test report.

EUT	WiFi Module	Date of Test	2024-03-06
Factor	DRH18-E & BBHA 9170	Temp. / Humidity	23°C /61%
Polarity	Horizontal	Site / Test Engineer	AC2 / Marvin
Test Mode	802.11ac-20MHz_TX_Band2_CH 64_ANT 0	Test Voltage	By Notebook PC

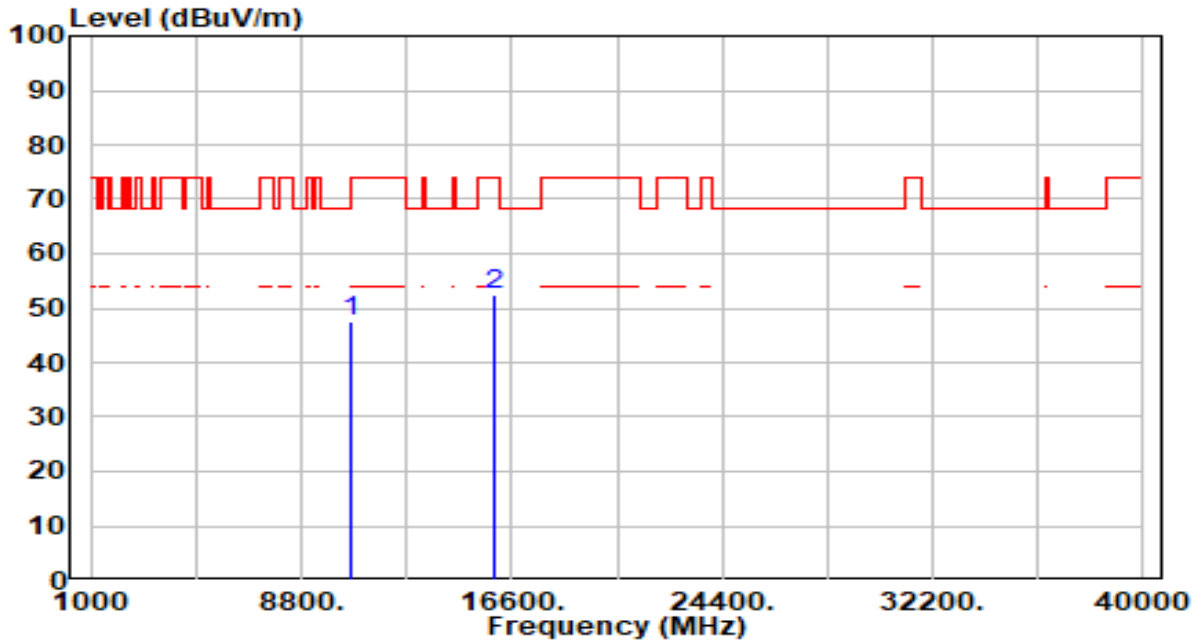

No	Frequency (MHz)	Reading (dBUV)	C.F (dB/m)	Measurement (dBUV/m)	Margin (dB)	Limit (dBUV/m)	Height (cm)	Angle (deg)	Remark (QP/PK/AV)
1	10640.000	42.91	4.62	47.54	-26.46	74.00	100	0	Peak
2	* 15960.000	45.85	6.55	52.40	-21.60	74.00	100	188	Peak

Note:

1. " *", means this data is the worst emission level.
2. C.F (Correction Factor) = Antenna Factor (dB/m)+ Cable Loss (dB) – Preamplifier(dB).
3. Measurement (dBUV/m) = Reading(dBUV) + C.F (Correction Factor).
4. The emission levels of other frequencies are very lower than the limit and not show in test report.

EUT	WiFi Module	Date of Test	2024-03-06
Factor	DRH18-E & BBHA 9170	Temp. / Humidity	23°C /61%
Polarity	Vertical	Site / Test Engineer	AC2 / Marvin
Test Mode	802.11ac-20MHz_TX_Band2_CH 64_ANT 0	Test Voltage	By Notebook PC

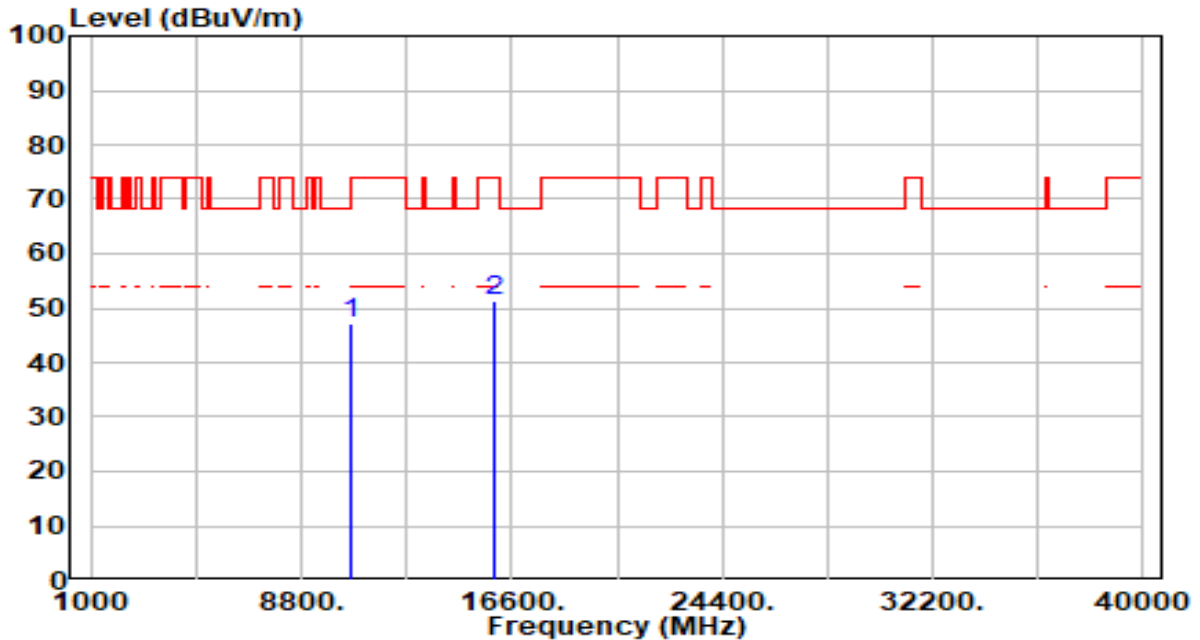

No	Frequency (MHz)	Reading (dBUV)	C.F (dB/m)	Measurement (dBUV/m)	Margin (dB)	Limit (dBUV/m)	Height (cm)	Angle (deg)	Remark (QP/PK/AV)
1	10640.000	42.54	4.62	47.17	-26.83	74.00	100	94	Peak
2	* 15960.000	44.72	6.55	51.27	-22.73	74.00	100	360	Peak

Note:

1. " *", means this data is the worst emission level.
2. C.F (Correction Factor) = Antenna Factor (dB/m)+ Cable Loss (dB) – Preamplifier(dB).
3. Measurement (dBUV/m) = Reading(dBUV) + C.F (Correction Factor).
4. The emission levels of other frequencies are very lower than the limit and not show in test report.

EUT	WiFi Module	Date of Test	2024-03-06
Factor	DRH18-E & BBHA 9170	Temp. / Humidity	23°C /61%
Polarity	Horizontal	Site / Test Engineer	AC2 / Marvin
Test Mode	802.11ac-20MHz_TX_Band3_CH 100_ANT 0	Test Voltage	By Notebook PC

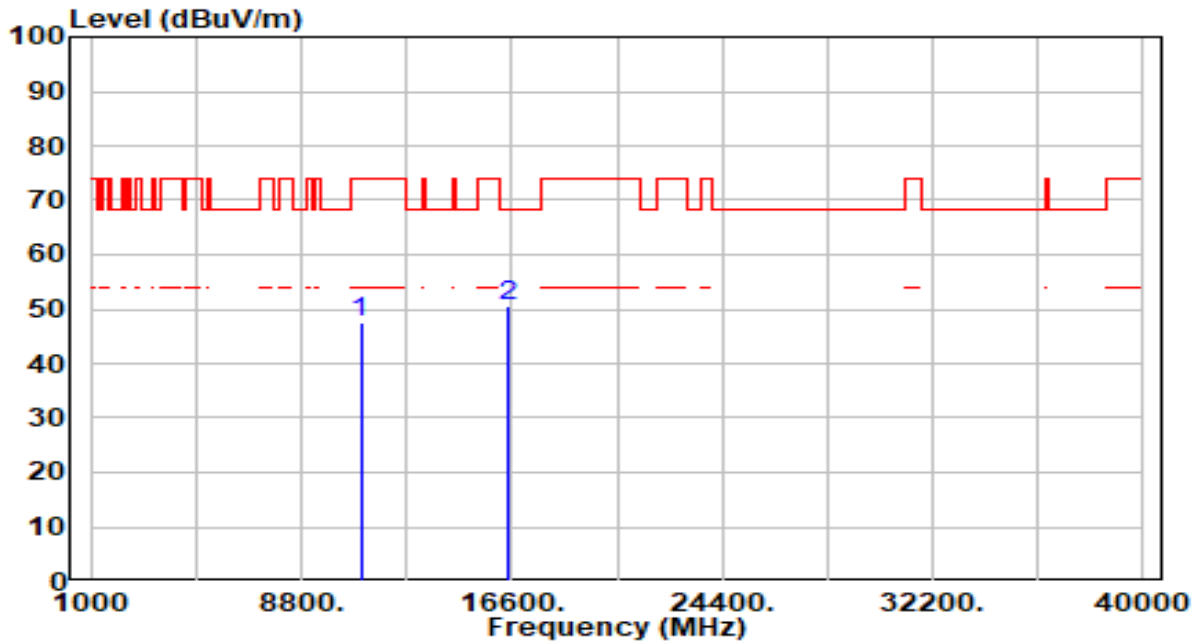

No	Frequency (MHz)	Reading (dBuV)	C.F (dB/m)	Measurement (dBuV/m)	Margin (dB)	Limit (dBuV/m)	Height (cm)	Angle (deg)	Remark (QP/PK/AV)
1	11000.000	42.89	4.52	47.41	-26.59	74.00	100	0	Peak
2	* 16500.000	44.50	6.10	50.60	-17.60	68.20	100	197	Peak

Note:

1. " *", means this data is the worst emission level.
2. C.F (Correction Factor) = Antenna Factor (dB/m)+ Cable Loss (dB) – Pre-amplifier(dB).
3. Measurement (dBuV/m) = Reading(dBuV) + C.F (Correction Factor).
4. The emission levels of other frequencies are very lower than the limit and not show in test report.

EUT	WiFi Module	Date of Test	2024-03-06
Factor	DRH18-E & BBHA 9170	Temp. / Humidity	23°C /61%
Polarity	Vertical	Site / Test Engineer	AC2 / Marvin
Test Mode	802.11ac-20MHz_TX_Band3_CH 100_ANT 0	Test Voltage	By Notebook PC

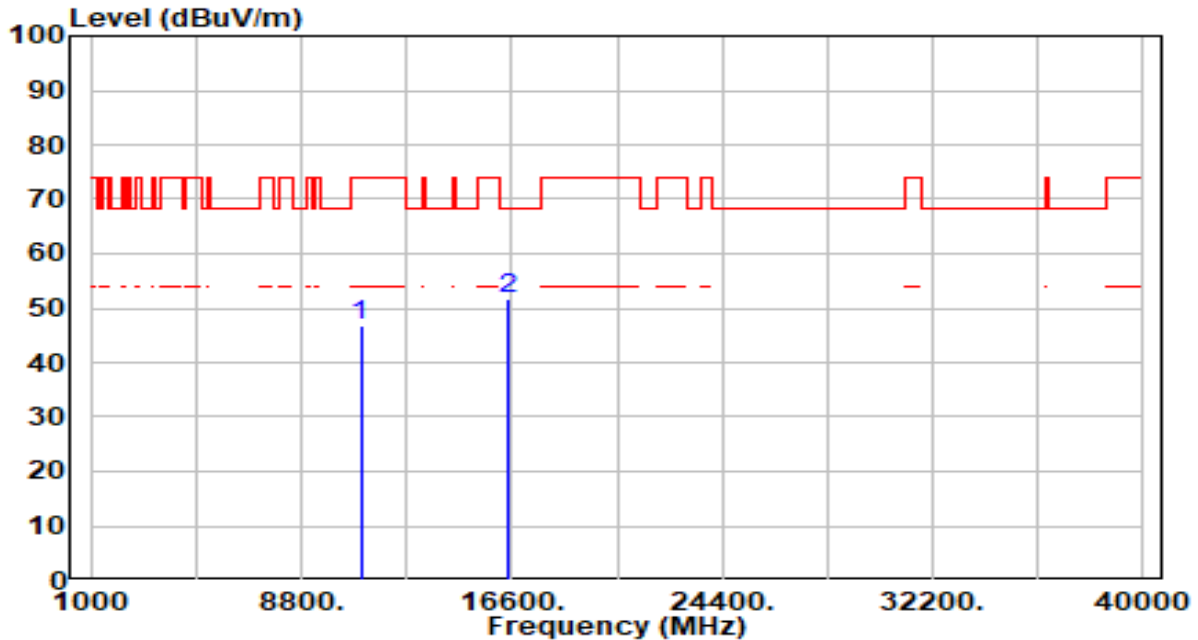

No	Frequency (MHz)	Reading (dBUV)	C.F (dB/m)	Measurement (dBUV/m)	Margin (dB)	Limit (dBUV/m)	Height (cm)	Angle (deg)	Remark (QP/PK/AV)
1	11000.000	42.44	4.52	46.96	-27.04	74.00	100	152	Peak
2	* 16500.000	45.49	6.10	51.59	-16.62	68.20	100	93	Peak

Note:

1. " *", means this data is the worst emission level.
2. C.F (Correction Factor) = Antenna Factor (dB/m)+ Cable Loss (dB) – Preamplifier(dB).
3. Measurement (dBUV/m) = Reading(dBUV) + C.F (Correction Factor).
4. The emission levels of other frequencies are very lower than the limit and not show in test report.

EUT	WiFi Module	Date of Test	2024-03-06
Factor	DRH18-E & BBHA 9170	Temp. / Humidity	23°C /61%
Polarity	Horizontal	Site / Test Engineer	AC2 / Marvin
Test Mode	802.11ac-20MHz_TX_Band3_CH 116_ANT 0	Test Voltage	By Notebook PC

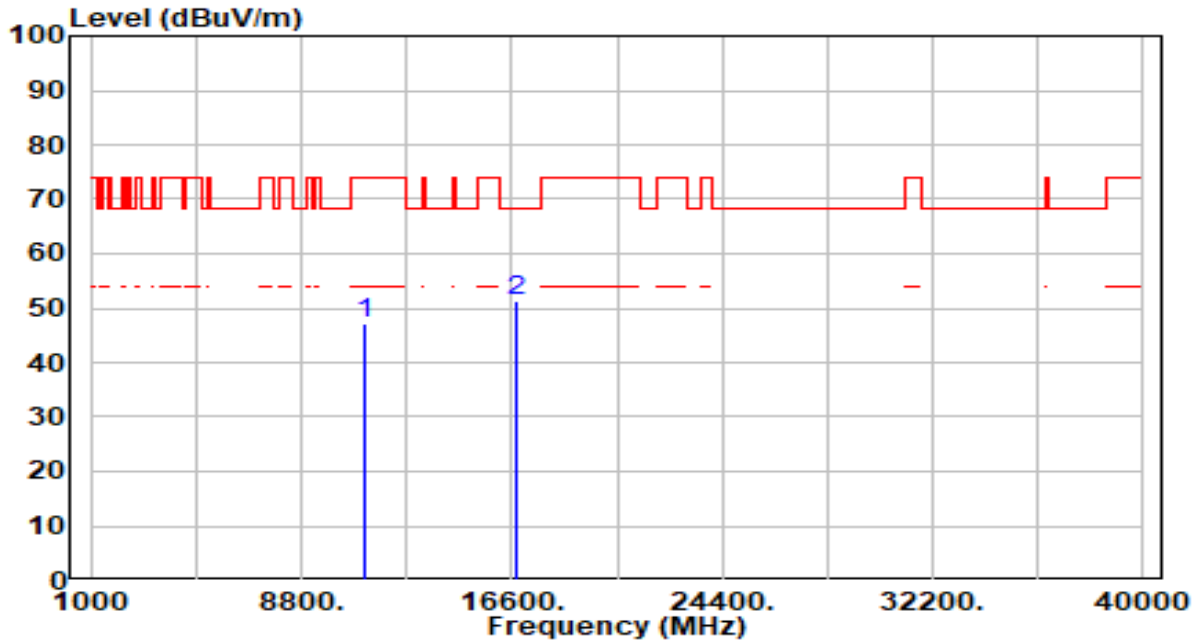

No	Frequency (MHz)	Reading (dBUV)	C.F (dB/m)	Measurement (dBUV/m)	Margin (dB)	Limit (dBUV/m)	Height (cm)	Angle (deg)	Remark (QP/PK/AV)
1	11160.000	42.41	4.94	47.34	-26.66	74.00	100	253	Peak
2	* 16740.000	45.03	6.19	51.22	-16.98	68.20	100	267	Peak

Note:

1. " *", means this data is the worst emission level.
2. C.F (Correction Factor) = Antenna Factor (dB/m)+ Cable Loss (dB) – Preamplifier(dB).
3. Measurement (dBUV/m) = Reading(dBUV) + C.F (Correction Factor).
4. The emission levels of other frequencies are very lower than the limit and not show in test report.

EUT	WiFi Module	Date of Test	2024-03-06
Factor	DRH18-E & BBHA 9170	Temp. / Humidity	23°C /61%
Polarity	Vertical	Site / Test Engineer	AC2 / Marvin
Test Mode	802.11ac-20MHz_TX_Band3_CH 116_ANT 0	Test Voltage	By Notebook PC

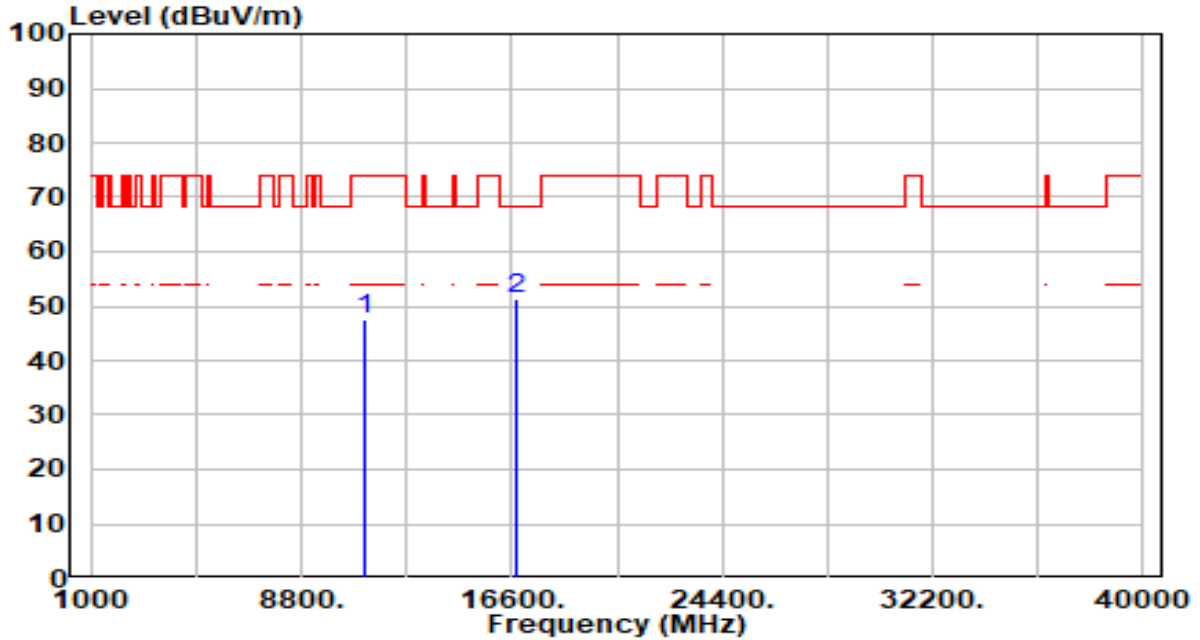

No	Frequency (MHz)	Reading (dBUV)	C.F (dB/m)	Measurement (dBUV/m)	Margin (dB)	Limit (dBUV/m)	Height (cm)	Angle (deg)	Remark (QP/PK/AV)
1	11160.000	42.61	4.94	47.55	-26.45	74.00	100	178	Peak
2	* 16740.000	45.24	6.19	51.43	-16.77	68.20	100	360	Peak

Note:

1. " *", means this data is the worst emission level.
2. C.F (Correction Factor) = Antenna Factor (dB/m)+ Cable Loss (dB) – Preamplifier(dB).
3. Measurement (dBUV/m) = Reading(dBUV) + C.F (Correction Factor).
4. The emission levels of other frequencies are very lower than the limit and not show in test report.

EUT	WiFi Module	Date of Test	2024-03-06
Factor	DRH18-E & BBHA 9170	Temp. / Humidity	23°C /61%
Polarity	Horizontal	Site / Test Engineer	AC2 / Marvin
Test Mode	802.11ac-20MHz_TX_Band3_CH 140_ANT 0	Test Voltage	By Notebook PC

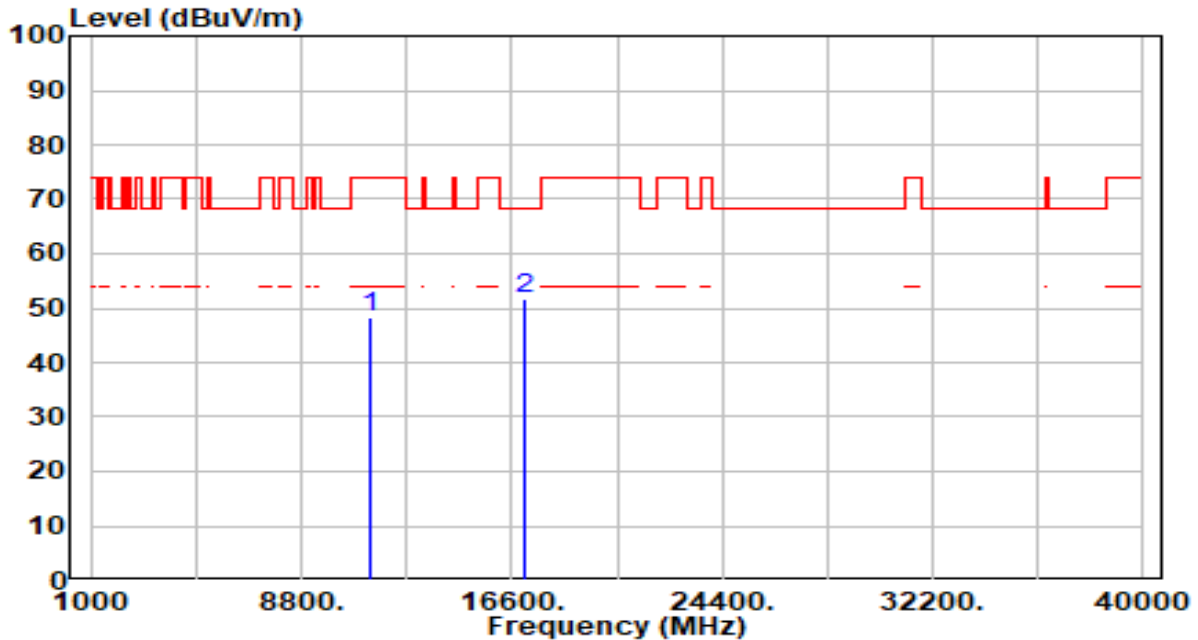

No	Frequency (MHz)	Reading (dBUV)	C.F (dB/m)	Measurement (dBUV/m)	Margin (dB)	Limit (dBUV/m)	Height (cm)	Angle (deg)	Remark (QP/PK/AV)
1	11400.000	42.88	5.26	48.14	-25.86	74.00	100	78	Peak
2	* 17100.000	45.88	5.97	51.85	-16.35	68.20	100	274	Peak

Note:

1. " *", means this data is the worst emission level.
2. C.F (Correction Factor) = Antenna Factor (dB/m)+ Cable Loss (dB) – Preamplifier(dB).
3. Measurement (dBUV/m) = Reading(dBUV) + C.F (Correction Factor).
4. The emission levels of other frequencies are very lower than the limit and not show in test report.

EUT	WiFi Module	Date of Test	2024-03-06
Factor	DRH18-E & BBHA 9170	Temp. / Humidity	23°C /61%
Polarity	Vertical	Site / Test Engineer	AC2 / Marvin
Test Mode	802.11ac-20MHz_TX_Band3_CH 140_ANT 0	Test Voltage	By Notebook PC

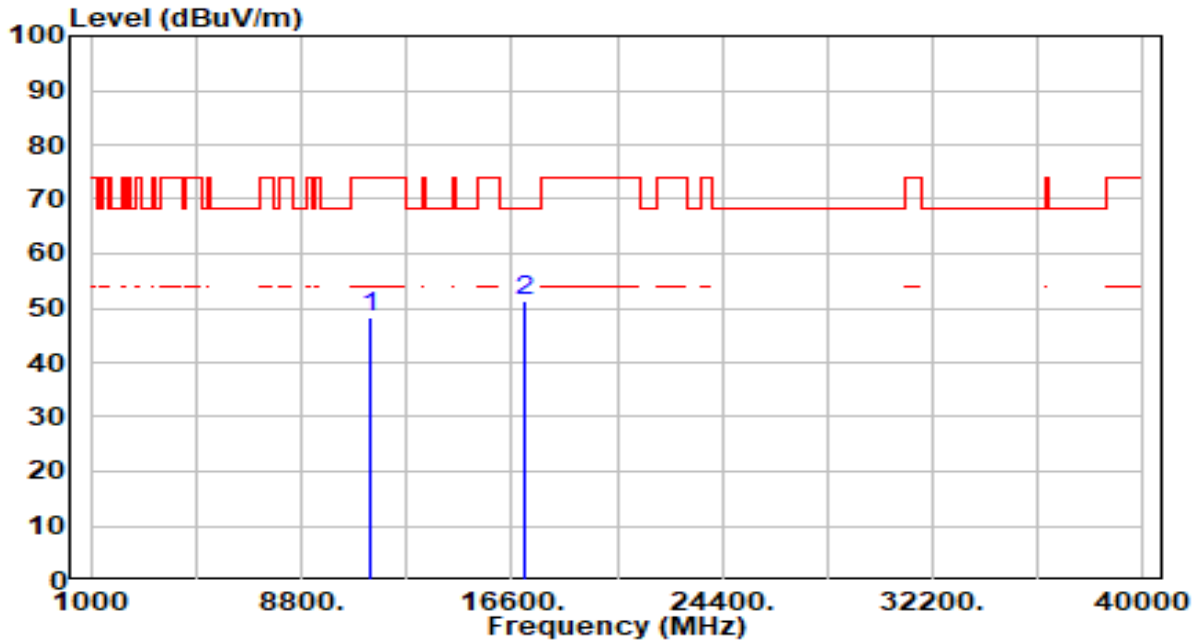

No	Frequency (MHz)	Reading (dBUV)	C.F (dB/m)	Measurement (dBUV/m)	Margin (dB)	Limit (dBUV/m)	Height (cm)	Angle (deg)	Remark (QP/PK/AV)
1	11400.000	43.04	5.26	48.31	-25.69	74.00	100	307	Peak
2	* 17100.000	45.42	5.97	51.39	-16.81	68.20	100	76	Peak

Note:

1. " *", means this data is the worst emission level.
2. C.F (Correction Factor) = Antenna Factor (dB/m)+ Cable Loss (dB) – Preamplifier(dB).
3. Measurement (dBUV/m) = Reading(dBUV) + C.F (Correction Factor).
4. The emission levels of other frequencies are very lower than the limit and not show in test report.

EUT	WiFi Module	Date of Test	2024-03-06
Factor	DRH18-E & BBHA 9170	Temp. / Humidity	23°C /61%
Polarity	Horizontal	Site / Test Engineer	AC2 / Marvin
Test Mode	802.11ac-20MHz_TX_Band3_CH 144_ANT 0	Test Voltage	By Notebook PC

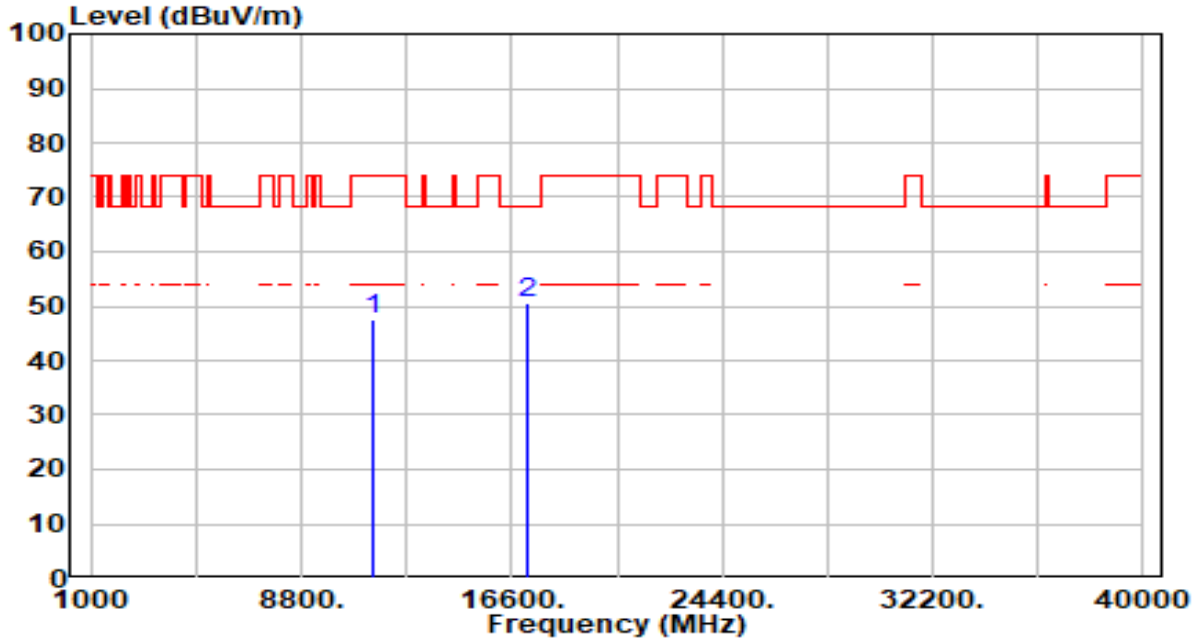

No	Frequency (MHz)	Reading (dBUV)	C.F (dB/m)	Measurement (dBUV/m)	Margin (dB)	Limit (dBUV/m)	Height (cm)	Angle (deg)	Remark (QP/PK/AV)
1	11440.000	42.11	5.29	47.40	-26.60	74.00	100	50	Peak
2	* 17160.000	44.79	5.87	50.66	-17.54	68.20	100	25	Peak

Note:

1. " *", means this data is the worst emission level.
2. C.F (Correction Factor) = Antenna Factor (dB/m)+ Cable Loss (dB) – Preamplifier(dB).
3. Measurement (dBUV/m) = Reading(dBUV) + C.F (Correction Factor).
4. The emission levels of other frequencies are very lower than the limit and not show in test report.

EUT	WiFi Module	Date of Test	2024-03-06
Factor	DRH18-E & BBHA 9170	Temp. / Humidity	23°C /61%
Polarity	Vertical	Site / Test Engineer	AC2 / Marvin
Test Mode	802.11ac-20MHz_TX_Band3_CH 144_ANT 0	Test Voltage	By Notebook PC

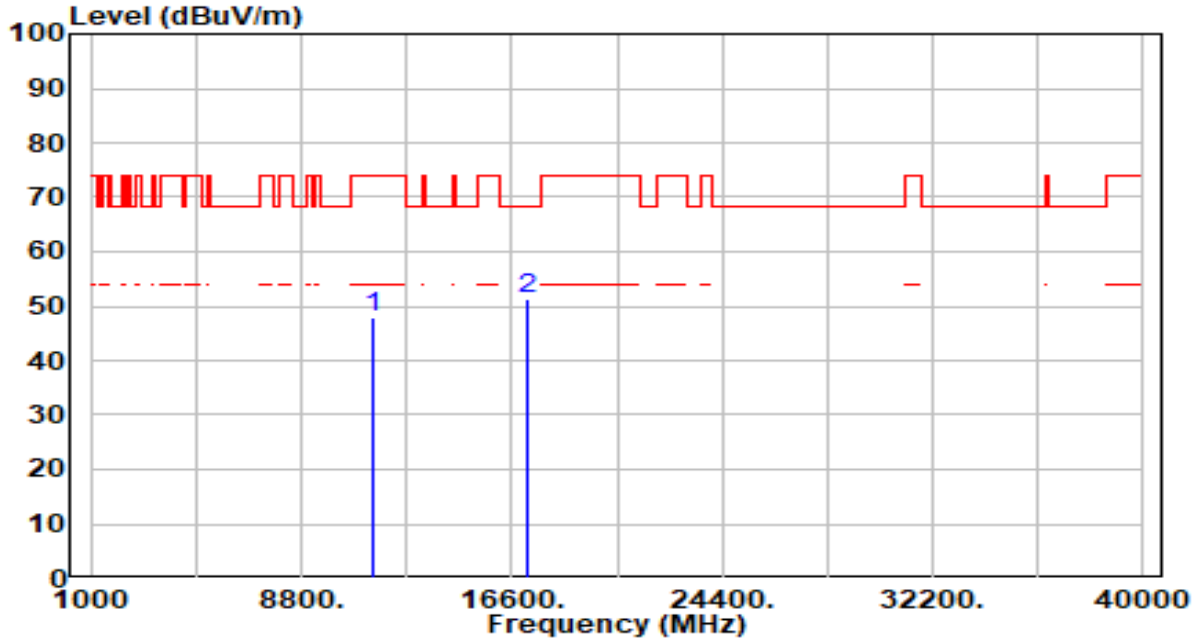

No	Frequency (MHz)	Reading (dBUV)	C.F (dB/m)	Measurement (dBUV/m)	Margin (dB)	Limit (dBUV/m)	Height (cm)	Angle (deg)	Remark (QP/PK/AV)
1	11440.000	42.45	5.29	47.74	-26.26	74.00	100	316	Peak
2	* 17160.000	45.58	5.87	51.45	-16.75	68.20	100	232	Peak

Note:

1. " *", means this data is the worst emission level.
2. C.F (Correction Factor) = Antenna Factor (dB/m)+ Cable Loss (dB) – Preamplifier(dB).
3. Measurement (dBUV/m) = Reading(dBUV) + C.F (Correction Factor).
4. The emission levels of other frequencies are very lower than the limit and not show in test report.

EUT	WiFi Module	Date of Test	2024-03-06
Factor	DRH18-E & BBHA 9170	Temp. / Humidity	23°C /61%
Polarity	Horizontal	Site / Test Engineer	AC2 / Marvin
Test Mode	802.11ac-20MHz_TX_Band4_CH 149_ANT 0	Test Voltage	By Notebook PC

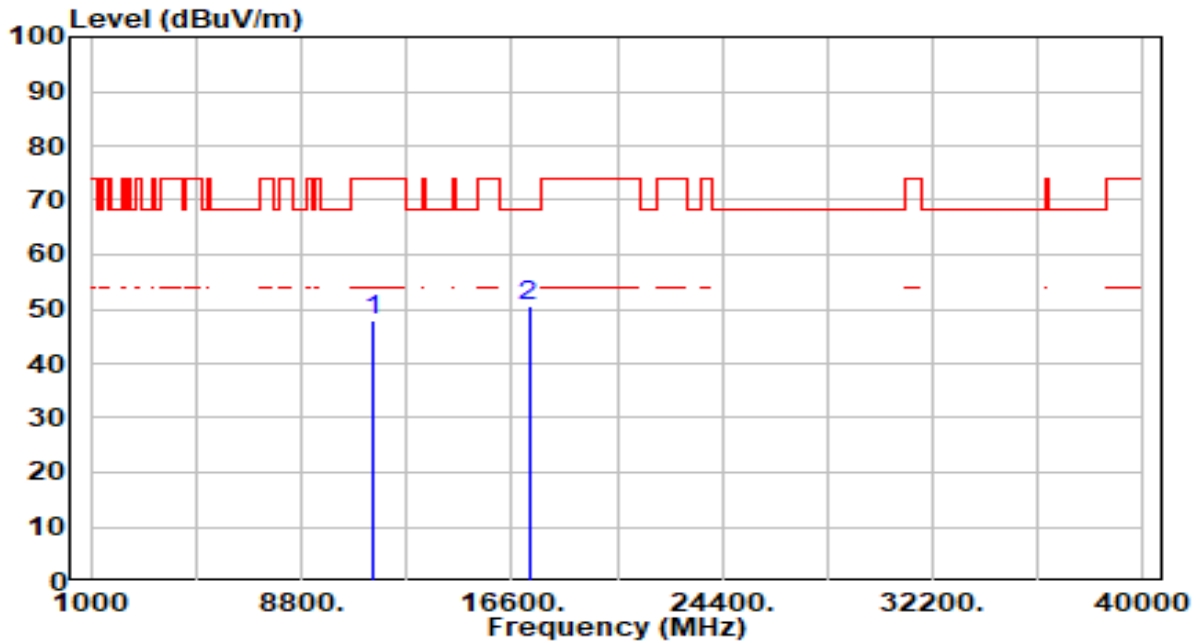

No	Frequency (MHz)	Reading (dBuV)	C.F (dB/m)	Measurement (dBuV/m)	Margin (dB)	Limit (dBuV/m)	Height (cm)	Angle (deg)	Remark (QP/PK/AV)
1	11490.000	42.71	5.32	48.02	-25.98	74.00	100	329	Peak
2	* 17235.000	44.71	5.71	50.42	-17.78	68.20	100	208	Peak

Note:

1. " *", means this data is the worst emission level.
2. C.F (Correction Factor) = Antenna Factor (dB/m)+ Cable Loss (dB) – Pre-amplifier(dB).
3. Measurement (dBuV/m) = Reading(dBuV) + C.F (Correction Factor).
4. The emission levels of other frequencies are very lower than the limit and not show in test report.

EUT	WiFi Module	Date of Test	2024-03-06
Factor	DRH18-E & BBHA 9170	Temp. / Humidity	23°C /61%
Polarity	Vertical	Site / Test Engineer	AC2 / Marvin
Test Mode	802.11ac-20MHz_TX_Band4_CH 149_ANT 0	Test Voltage	By Notebook PC

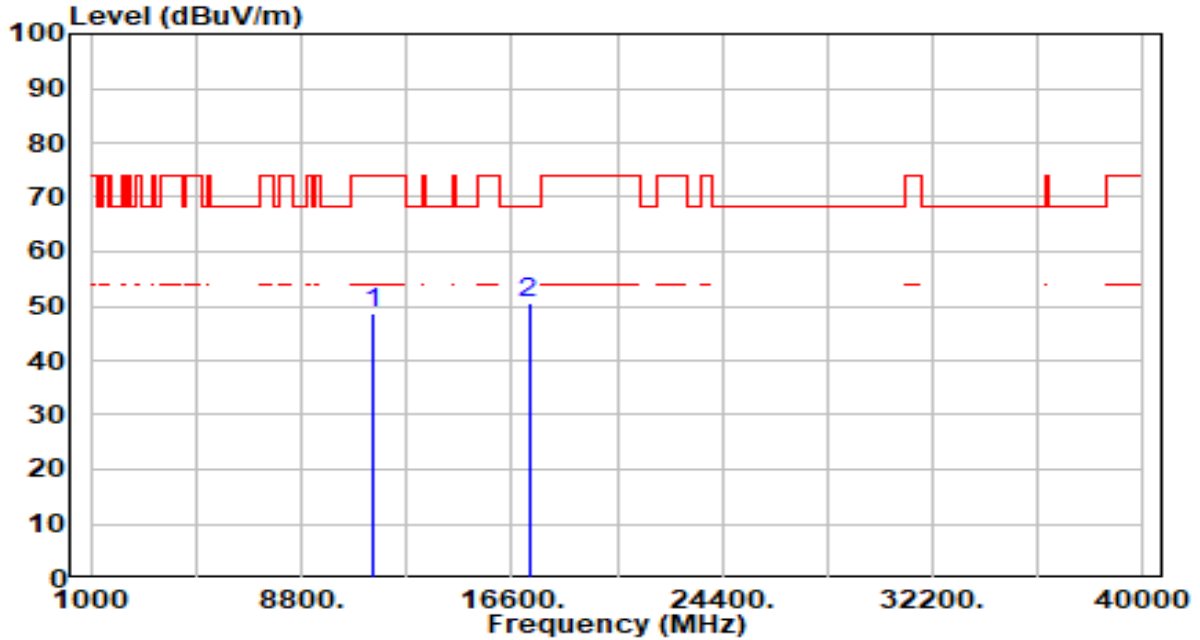

No	Frequency (MHz)	Reading (dBUV)	C.F (dB/m)	Measurement (dBUV/m)	Margin (dB)	Limit (dBUV/m)	Height (cm)	Angle (deg)	Remark (QP/PK/AV)
1	11490.000	43.27	5.32	48.59	-25.41	74.00	100	299	Peak
2	* 17235.000	44.91	5.71	50.62	-17.58	68.20	100	19	Peak

Note:

1. " *", means this data is the worst emission level.
2. C.F (Correction Factor) = Antenna Factor (dB/m)+ Cable Loss (dB) – Preamplifier(dB).
3. Measurement (dBUV/m) = Reading(dBUV) + C.F (Correction Factor).
4. The emission levels of other frequencies are very lower than the limit and not show in test report.

EUT	WiFi Module	Date of Test	2024-03-06
Factor	DRH18-E & BBHA 9170	Temp. / Humidity	23°C /61%
Polarity	Horizontal	Site / Test Engineer	AC2 / Marvin
Test Mode	802.11ac-20MHz_TX_Band4_CH 157_ANT 0	Test Voltage	By Notebook PC

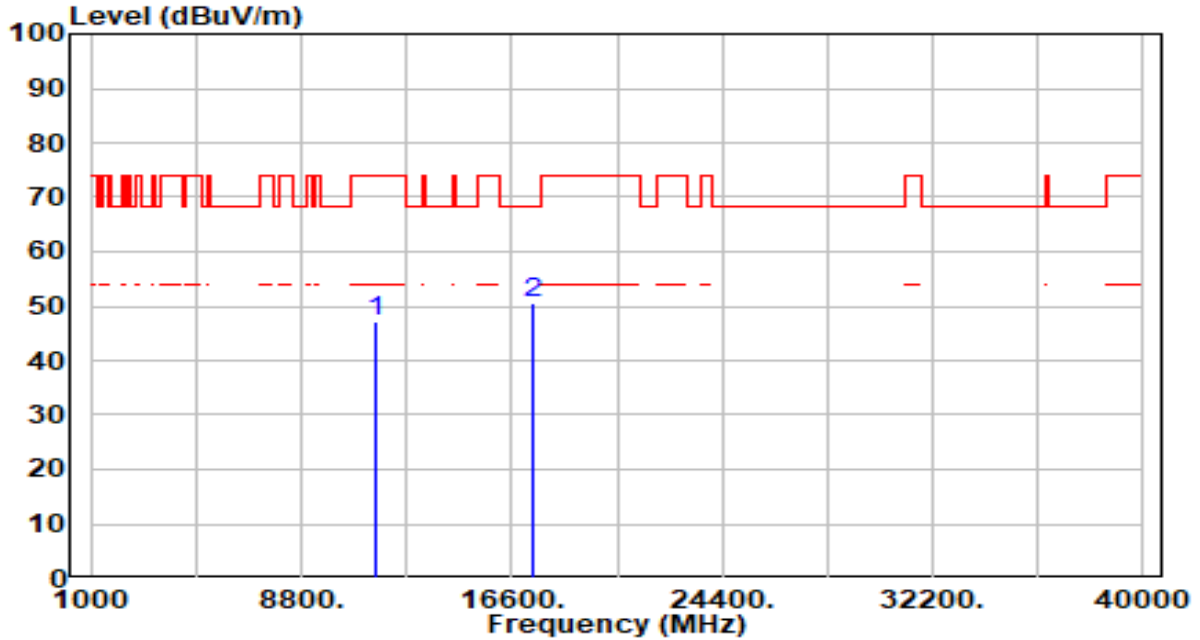

No	Frequency (MHz)	Reading (dBUV)	C.F (dB/m)	Measurement (dBUV/m)	Margin (dB)	Limit (dBUV/m)	Height (cm)	Angle (deg)	Remark (QP/PK/AV)
1	11570.000	41.88	5.38	47.25	-26.75	74.00	100	360	Peak
2	* 17355.000	45.14	5.39	50.52	-17.68	68.20	100	258	Peak

Note:

1. " *", means this data is the worst emission level.
2. C.F (Correction Factor) = Antenna Factor (dB/m)+ Cable Loss (dB) – Preamplifier(dB).
3. Measurement (dBUV/m) = Reading(dBUV) + C.F (Correction Factor).
4. The emission levels of other frequencies are very lower than the limit and not show in test report.

EUT	WiFi Module	Date of Test	2024-03-06
Factor	DRH18-E & BBHA 9170	Temp. / Humidity	23°C /61%
Polarity	Vertical	Site / Test Engineer	AC2 / Marvin
Test Mode	802.11ac-20MHz_TX_Band4_CH 157_ANT 0	Test Voltage	By Notebook PC

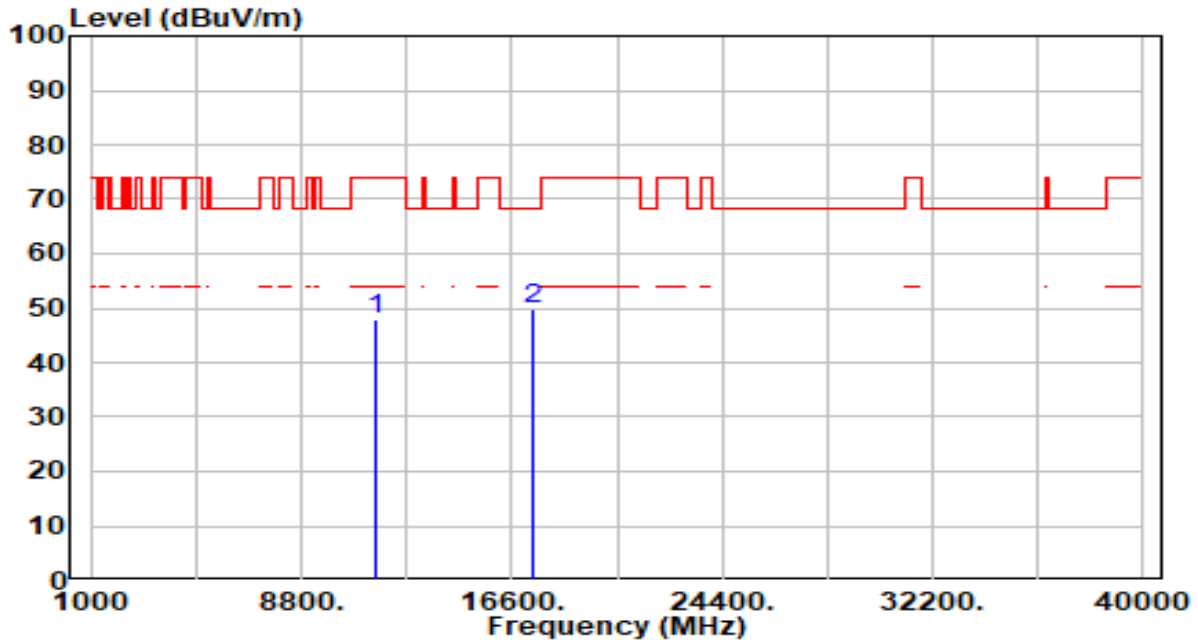

No	Frequency (MHz)	Reading (dBUV)	C.F (dB/m)	Measurement (dBUV/m)	Margin (dB)	Limit (dBUV/m)	Height (cm)	Angle (deg)	Remark (QP/PK/AV)
1	11570.000	42.55	5.38	47.92	-26.08	74.00	100	176	Peak
2	* 17355.000	44.53	5.39	49.91	-18.29	68.20	100	269	Peak

Note:

1. " *", means this data is the worst emission level.
2. C.F (Correction Factor) = Antenna Factor (dB/m)+ Cable Loss (dB) – Preamplifier(dB).
3. Measurement (dBUV/m) = Reading(dBUV) + C.F (Correction Factor).
4. The emission levels of other frequencies are very lower than the limit and not show in test report.

EUT	WiFi Module	Date of Test	2024-03-06
Factor	DRH18-E & BBHA 9170	Temp. / Humidity	23°C /61%
Polarity	Horizontal	Site / Test Engineer	AC2 / Marvin
Test Mode	802.11ac-20MHz_TX_Band4_CH 165_ANT 0	Test Voltage	By Notebook PC

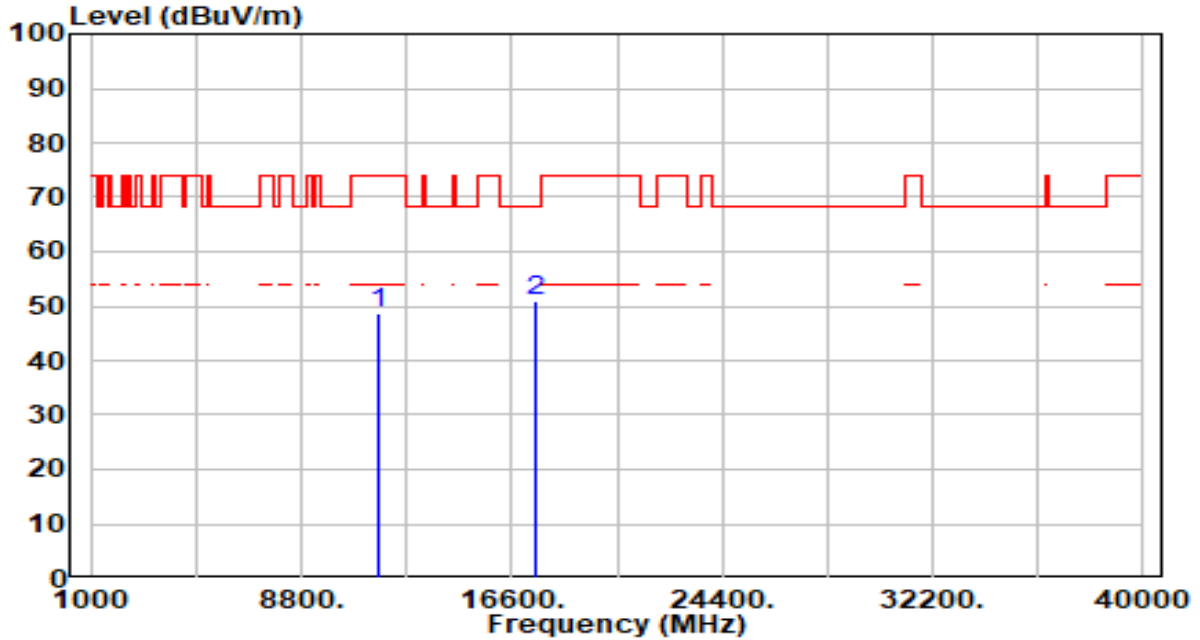

No	Frequency (MHz)	Reading (dBUV)	C.F (dB/m)	Measurement (dBUV/m)	Margin (dB)	Limit (dBUV/m)	Height (cm)	Angle (deg)	Remark (QP/PK/AV)
1	11650.000	43.22	5.36	48.58	-25.42	74.00	100	0	Peak
2	* 17475.000	45.61	5.29	50.91	-17.29	68.20	100	263	Peak

Note:

- "*" means this data is the worst emission level.
- C.F (Correction Factor) = Antenna Factor (dB/m)+ Cable Loss (dB) – Preamplifier(dB).
- Measurement (dBUV/m) = Reading(dBUV) + C.F (Correction Factor).
- The emission levels of other frequencies are very lower than the limit and not show in test report.

EUT	WiFi Module	Date of Test	2024-03-06
Factor	DRH18-E & BBHA 9170	Temp. / Humidity	23°C /61%
Polarity	Vertical	Site / Test Engineer	AC2 / Marvin
Test Mode	802.11ac-20MHz_TX_Band4_CH 165_ANT 0	Test Voltage	By Notebook PC

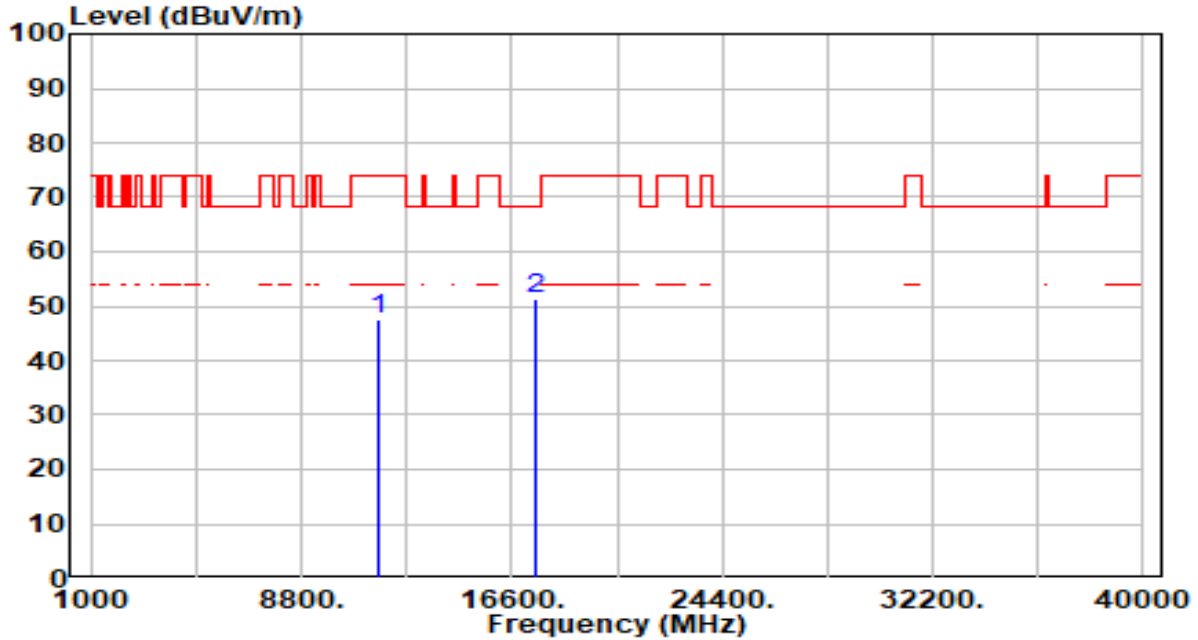

No	Frequency (MHz)	Reading (dBUV)	C.F (dB/m)	Measurement (dBUV/m)	Margin (dB)	Limit (dBUV/m)	Height (cm)	Angle (deg)	Remark (QP/PK/AV)
1	11650.000	42.30	5.36	47.66	-26.34	74.00	100	153	Peak
2	* 17475.000	45.90	5.29	51.19	-17.01	68.20	100	286	Peak

Note:

1. " *", means this data is the worst emission level.
2. C.F (Correction Factor) = Antenna Factor (dB/m)+ Cable Loss (dB) – Preamplifier(dB).
3. Measurement (dBUV/m) = Reading(dBUV) + C.F (Correction Factor).
4. The emission levels of other frequencies are very lower than the limit and not show in test report.

EUT	WiFi Module	Date of Test	2024-03-06
Factor	DRH18-E & BBHA 9170	Temp. / Humidity	23°C /61%
Polarity	Horizontal	Site / Test Engineer	AC2 / Marvin
Test Mode	802.11ac-40MHz_TX_Band1_CH 38_ANT 0	Test Voltage	By Notebook PC

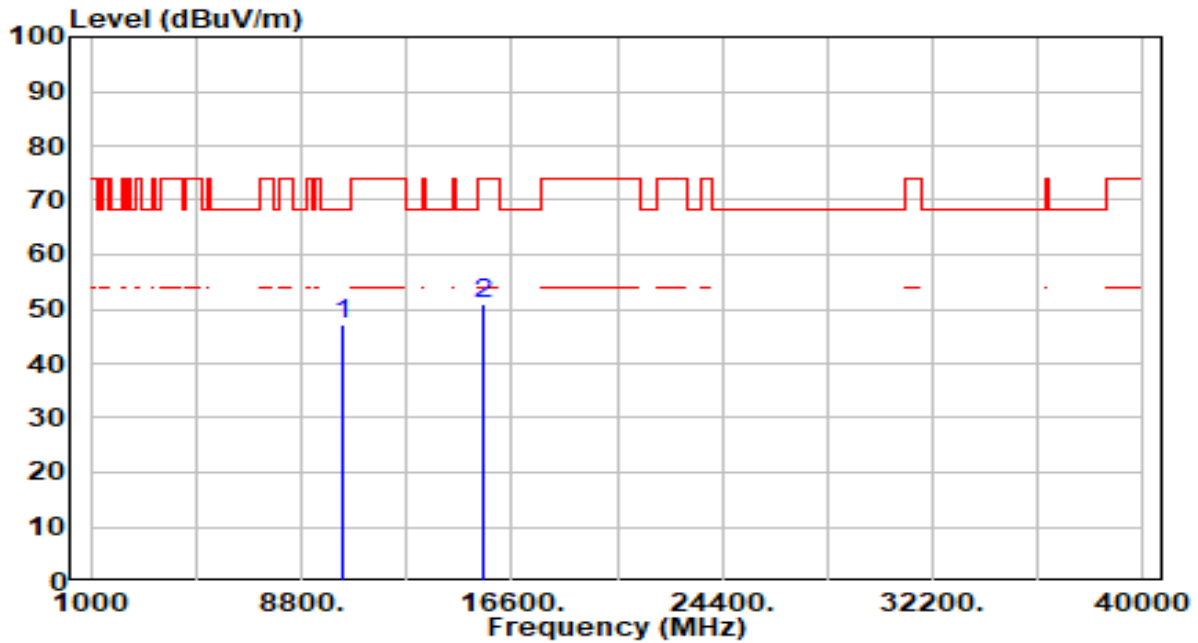

No	Frequency (MHz)	Reading (dBuV)	C.F (dB/m)	Measurement (dBuV/m)	Margin (dB)	Limit (dBuV/m)	Height (cm)	Angle (deg)	Remark (QP/PK/AV)
1	* 10380.000	42.33	4.84	47.18	-21.02	68.20	100	65	Peak
2	15570.000	44.59	6.18	50.77	-23.23	74.00	100	104	Peak

Note:

1. " *", means this data is the worst emission level.
2. C.F (Correction Factor) = Antenna Factor (dB/m)+ Cable Loss (dB) – Pre-amplifier(dB).
3. Measurement (dBuV/m) = Reading(dBuV) + C.F (Correction Factor).
4. The emission levels of other frequencies are very lower than the limit and not show in test report.

EUT	WiFi Module	Date of Test	2024-03-06
Factor	DRH18-E & BBHA 9170	Temp. / Humidity	23°C /61%
Polarity	Vertical	Site / Test Engineer	AC2 / Marvin
Test Mode	802.11ac-40MHz_TX_Band1_CH 38_ANT 0	Test Voltage	By Notebook PC

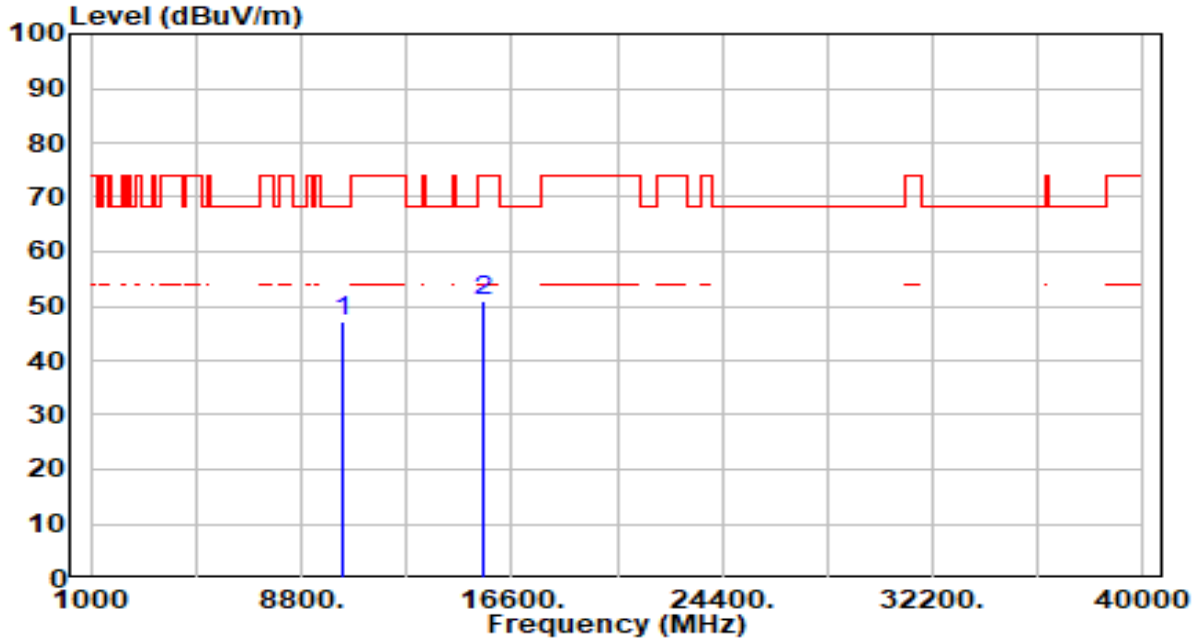

No	Frequency (MHz)	Reading (dBUV)	C.F (dB/m)	Measurement (dBUV/m)	Margin (dB)	Limit (dBUV/m)	Height (cm)	Angle (deg)	Remark (QP/PK/AV)
1	* 10380.000	42.24	4.84	47.08	-21.12	68.20	100	66	Peak
2	15570.000	44.74	6.18	50.92	-23.08	74.00	100	134	Peak

Note:

1. " *", means this data is the worst emission level.
2. C.F (Correction Factor) = Antenna Factor (dB/m)+ Cable Loss (dB) – Preamplifier(dB).
3. Measurement (dBUV/m) = Reading(dBUV) + C.F (Correction Factor).
4. The emission levels of other frequencies are very lower than the limit and not show in test report.

EUT	WiFi Module	Date of Test	2024-03-06
Factor	DRH18-E & BBHA 9170	Temp. / Humidity	23°C /61%
Polarity	Horizontal	Site / Test Engineer	AC2 / Marvin
Test Mode	802.11ac-40MHz_TX_Band1_CH 46_ANT 0	Test Voltage	By Notebook PC

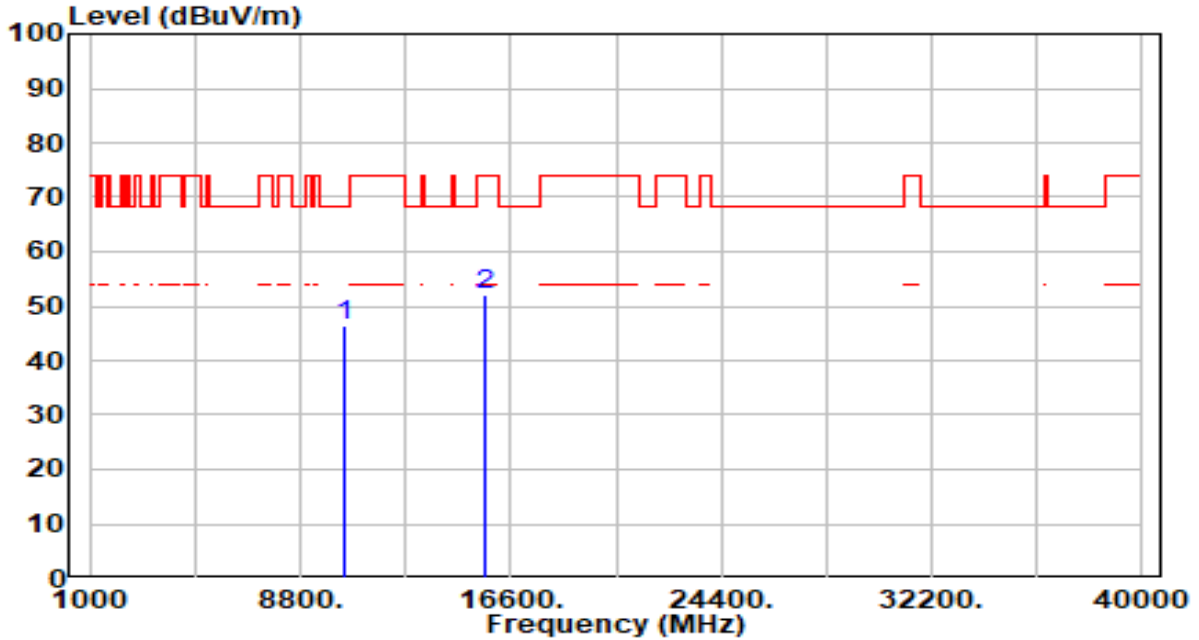

No	Frequency (MHz)	Reading (dBuV)	C.F (dB/m)	Measurement (dBuV/m)	Margin (dB)	Limit (dBuV/m)	Height (cm)	Angle (deg)	Remark (QP/PK/AV)
1	* 10460.000	41.83	4.74	46.56	-21.64	68.20	100	142	Peak
2	15690.000	45.61	6.33	51.93	-22.07	74.00	100	178	Peak

Note:

1. " *", means this data is the worst emission level.
2. C.F (Correction Factor) = Antenna Factor (dB/m)+ Cable Loss (dB) – Preamplifier(dB).
3. Measurement (dBuV/m) = Reading(dBuV) + C.F (Correction Factor).
4. The emission levels of other frequencies are very lower than the limit and not show in test report.

EUT	WiFi Module	Date of Test	2024-03-06
Factor	DRH18-E & BBHA 9170	Temp. / Humidity	23°C /61%
Polarity	Vertical	Site / Test Engineer	AC2 / Marvin
Test Mode	802.11ac-40MHz_TX_Band1_CH 46_ANT 0	Test Voltage	By Notebook PC

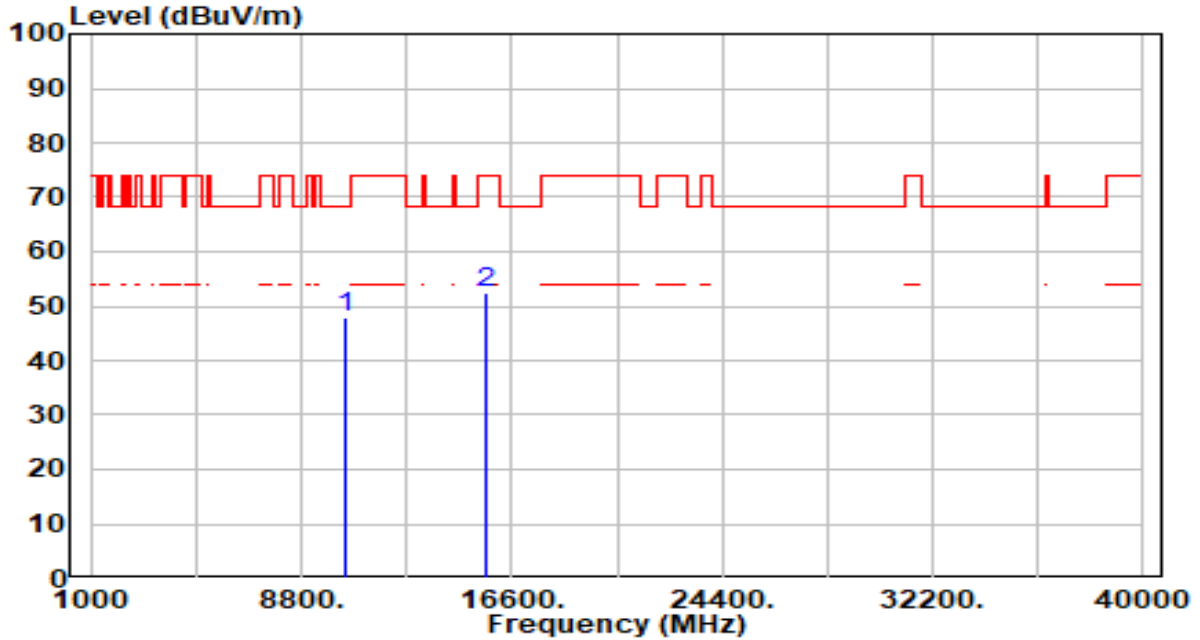

No	Frequency (MHz)	Reading (dBuV)	C.F (dB/m)	Measurement (dBuV/m)	Margin (dB)	Limit (dBuV/m)	Height (cm)	Angle (deg)	Remark (QP/PK/AV)
1	* 10460.000	43.09	4.74	47.83	-20.37	68.20	100	244	Peak
2	15690.000	45.96	6.33	52.29	-21.71	74.00	100	173	Peak

Note:

1. " *", means this data is the worst emission level.
2. C.F (Correction Factor) = Antenna Factor (dB/m)+ Cable Loss (dB) – Preamplifier(dB).
3. Measurement (dBuV/m) = Reading(dBuV) + C.F (Correction Factor).
4. The emission levels of other frequencies are very lower than the limit and not show in test report.

EUT	WiFi Module	Date of Test	2024-03-06
Factor	DRH18-E & BBHA 9170	Temp. / Humidity	23°C /61%
Polarity	Horizontal	Site / Test Engineer	AC2 / Marvin
Test Mode	802.11ac-40MHz_TX_Band2_CH 54_ANT 0	Test Voltage	By Notebook PC

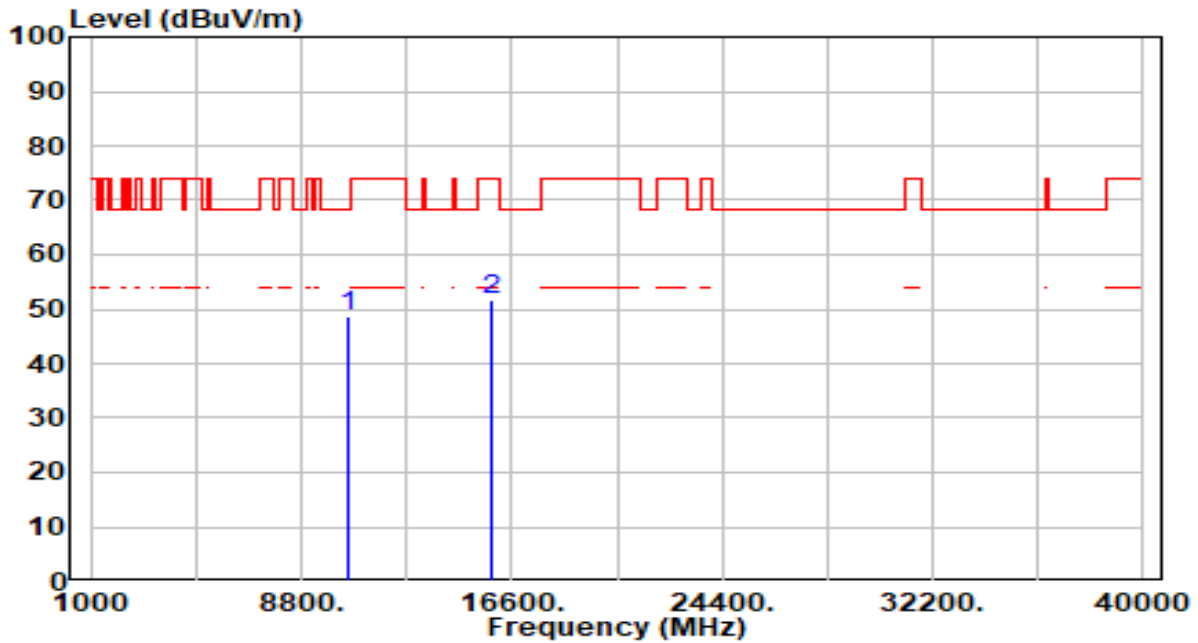

No	Frequency (MHz)	Reading (dBuV)	C.F (dB/m)	Measurement (dBuV/m)	Margin (dB)	Limit (dBuV/m)	Height (cm)	Angle (deg)	Remark (QP/PK/AV)
1	* 10540.000	43.94	4.66	48.59	-19.61	68.20	100	136	Peak
2	15810.000	45.03	6.55	51.58	-22.42	74.00	100	60	Peak

Note:

1. " *", means this data is the worst emission level.
2. C.F (Correction Factor) = Antenna Factor (dB/m)+ Cable Loss (dB) – Pre-amplifier(dB).
3. Measurement (dBuV/m) = Reading(dBuV) + C.F (Correction Factor).
4. The emission levels of other frequencies are very lower than the limit and not show in test report.

EUT	WiFi Module	Date of Test	2024-03-06
Factor	DRH18-E & BBHA 9170	Temp. / Humidity	23°C /61%
Polarity	Vertical	Site / Test Engineer	AC2 / Marvin
Test Mode	802.11ac-40MHz_TX_Band2_CH 54_ANT 0	Test Voltage	By Notebook PC

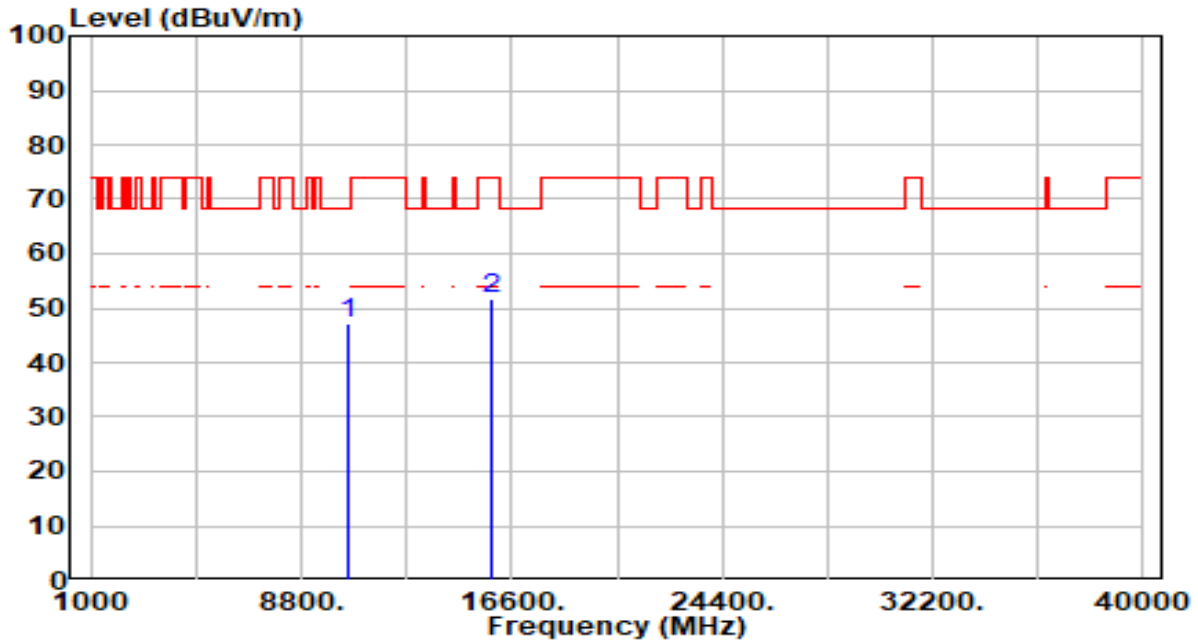

No	Frequency (MHz)	Reading (dBuV)	C.F (dB/m)	Measurement (dBuV/m)	Margin (dB)	Limit (dBuV/m)	Height (cm)	Angle (deg)	Remark (QP/PK/AV)
1	* 10540.000	42.70	4.66	47.36	-20.84	68.20	100	295	Peak
2	15810.000	45.07	6.55	51.62	-22.38	74.00	100	80	Peak

Note:

1. " *", means this data is the worst emission level.
2. C.F (Correction Factor) = Antenna Factor (dB/m)+ Cable Loss (dB) – Preamplifier(dB).
3. Measurement (dBuV/m) = Reading(dBuV) + C.F (Correction Factor).
4. The emission levels of other frequencies are very lower than the limit and not show in test report.

EUT	WiFi Module	Date of Test	2024-03-06
Factor	DRH18-E & BBHA 9170	Temp. / Humidity	23°C /61%
Polarity	Horizontal	Site / Test Engineer	AC2 / Marvin
Test Mode	802.11ac-40MHz_TX_Band2_CH 62_ANT 0	Test Voltage	By Notebook PC

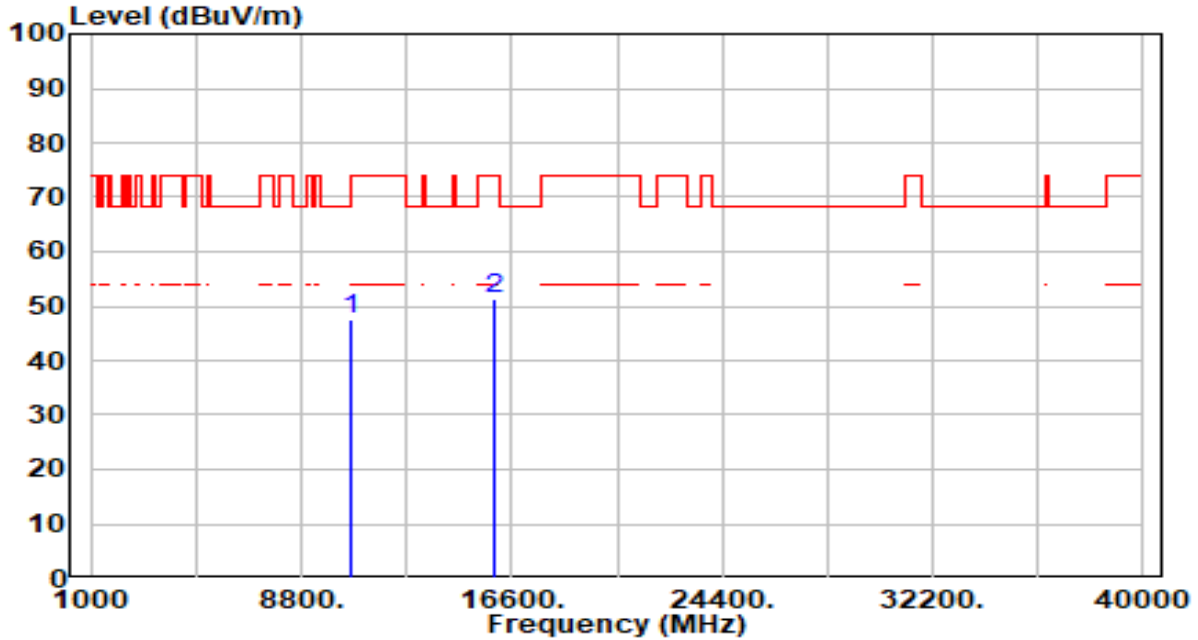

No	Frequency (MHz)	Reading (dBUV)	C.F (dB/m)	Measurement (dBUV/m)	Margin (dB)	Limit (dBUV/m)	Height (cm)	Angle (deg)	Remark (QP/PK/AV)
1	10620.000	42.97	4.62	47.59	-26.41	74.00	100	331	Peak
2	* 15930.000	44.85	6.55	51.40	-22.60	74.00	100	204	Peak

Note:

1. " *", means this data is the worst emission level.
2. C.F (Correction Factor) = Antenna Factor (dB/m)+ Cable Loss (dB) – Preamplifier(dB).
3. Measurement (dBUV/m) = Reading(dBUV) + C.F (Correction Factor).
4. The emission levels of other frequencies are very lower than the limit and not show in test report.

EUT	WiFi Module	Date of Test	2024-03-06
Factor	DRH18-E & BBHA 9170	Temp. / Humidity	23°C /61%
Polarity	Vertical	Site / Test Engineer	AC2 / Marvin
Test Mode	802.11ac-40MHz_TX_Band2_CH 62_ANT 0	Test Voltage	By Notebook PC

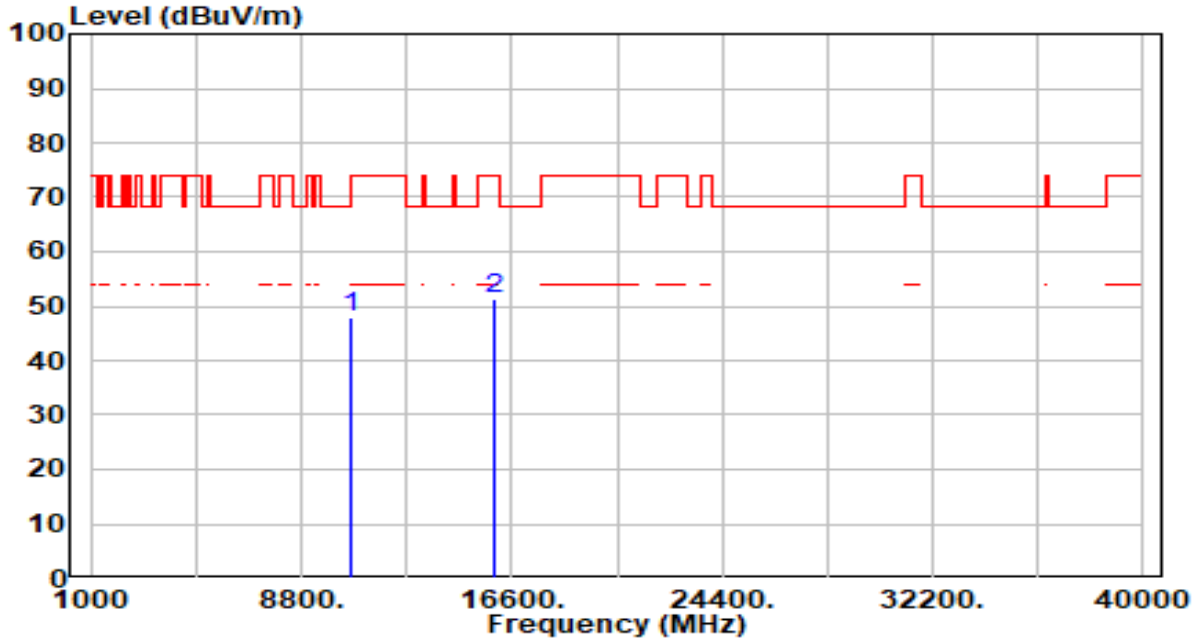

No	Frequency (MHz)	Reading (dBUV)	C.F (dB/m)	Measurement (dBUV/m)	Margin (dB)	Limit (dBUV/m)	Height (cm)	Angle (deg)	Remark (QP/PK/AV)
1	10620.000	43.40	4.62	48.02	-25.98	74.00	100	244	Peak
2	* 15930.000	44.78	6.55	51.33	-22.67	74.00	100	77	Peak

Note:

1. " *", means this data is the worst emission level.
2. C.F (Correction Factor) = Antenna Factor (dB/m)+ Cable Loss (dB) – Preamplifier(dB).
3. Measurement (dBUV/m) = Reading(dBUV) + C.F (Correction Factor).
4. The emission levels of other frequencies are very lower than the limit and not show in test report.

EUT	WiFi Module	Date of Test	2024-03-06
Factor	DRH18-E & BBHA 9170	Temp. / Humidity	23°C /61%
Polarity	Horizontal	Site / Test Engineer	AC2 / Marvin
Test Mode	802.11ac-40MHz_TX_Band3_CH 102_ANT 0	Test Voltage	By Notebook PC

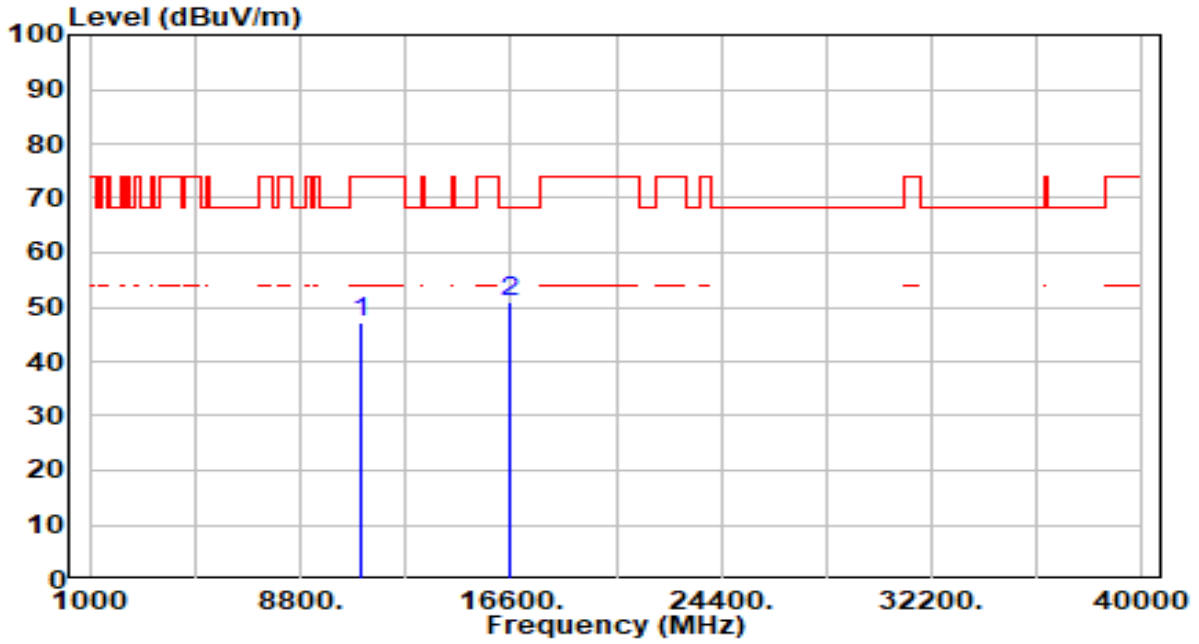

No	Frequency (MHz)	Reading (dBuV)	C.F (dB/m)	Measurement (dBuV/m)	Margin (dB)	Limit (dBuV/m)	Height (cm)	Angle (deg)	Remark (QP/PK/AV)
1	11020.000	42.55	4.57	47.12	-26.88	74.00	100	294	Peak
2	* 16530.000	44.90	6.10	51.00	-17.20	68.20	100	260	Peak

Note:

1. " *", means this data is the worst emission level.
2. C.F (Correction Factor) = Antenna Factor (dB/m)+ Cable Loss (dB) – Pre-amplifier(dB).
3. Measurement (dBuV/m) = Reading(dBuV) + C.F (Correction Factor).
4. The emission levels of other frequencies are very lower than the limit and not show in test report.

EUT	WiFi Module	Date of Test	2024-03-06
Factor	DRH18-E & BBHA 9170	Temp. / Humidity	23°C /61%
Polarity	Vertical	Site / Test Engineer	AC2 / Marvin
Test Mode	802.11ac-40MHz_TX_Band3_CH 102_ANT 0	Test Voltage	By Notebook PC

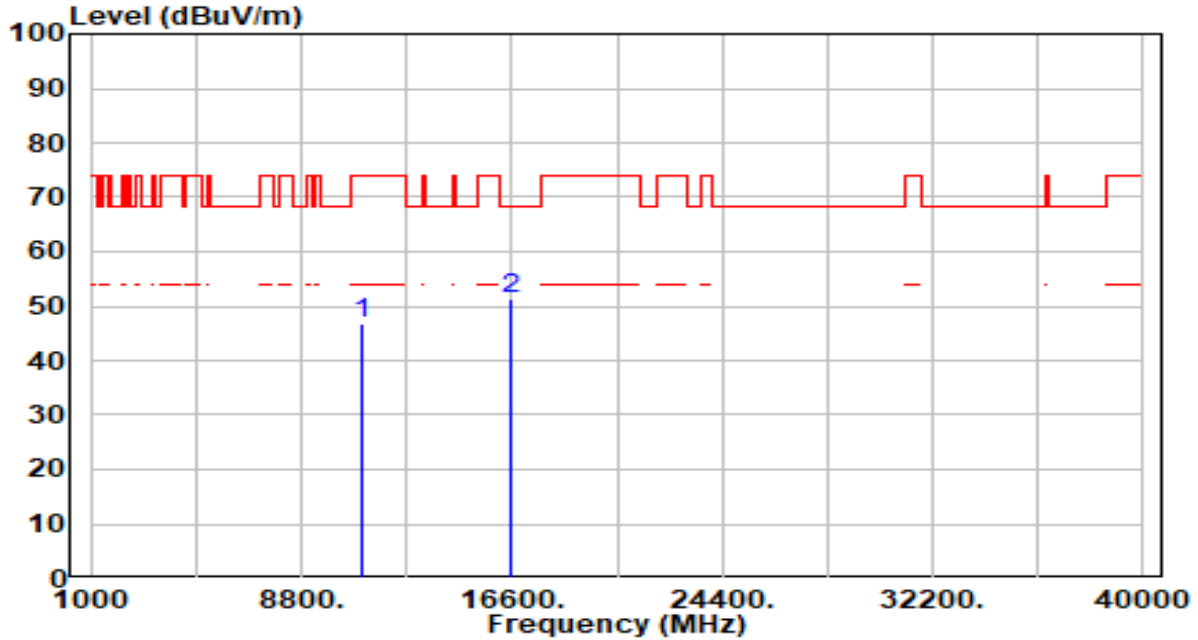

No	Frequency (MHz)	Reading (dBUV)	C.F (dB/m)	Measurement (dBUV/m)	Margin (dB)	Limit (dBUV/m)	Height (cm)	Angle (deg)	Remark (QP/PK/AV)
1	11020.000	42.41	4.57	46.98	-27.02	74.00	100	258	Peak
2	* 16530.000	45.06	6.10	51.16	-17.04	68.20	100	360	Peak

Note:

1. " *", means this data is the worst emission level.
2. C.F (Correction Factor) = Antenna Factor (dB/m)+ Cable Loss (dB) – Preamplifier(dB).
3. Measurement (dBUV/m) = Reading(dBUV) + C.F (Correction Factor).
4. The emission levels of other frequencies are very lower than the limit and not show in test report.

EUT	WiFi Module	Date of Test	2024-03-06
Factor	DRH18-E & BBHA 9170	Temp. / Humidity	23°C /61%
Polarity	Horizontal	Site / Test Engineer	AC2 / Marvin
Test Mode	802.11ac-40MHz_TX_Band3_CH 110_ANT 0	Test Voltage	By Notebook PC

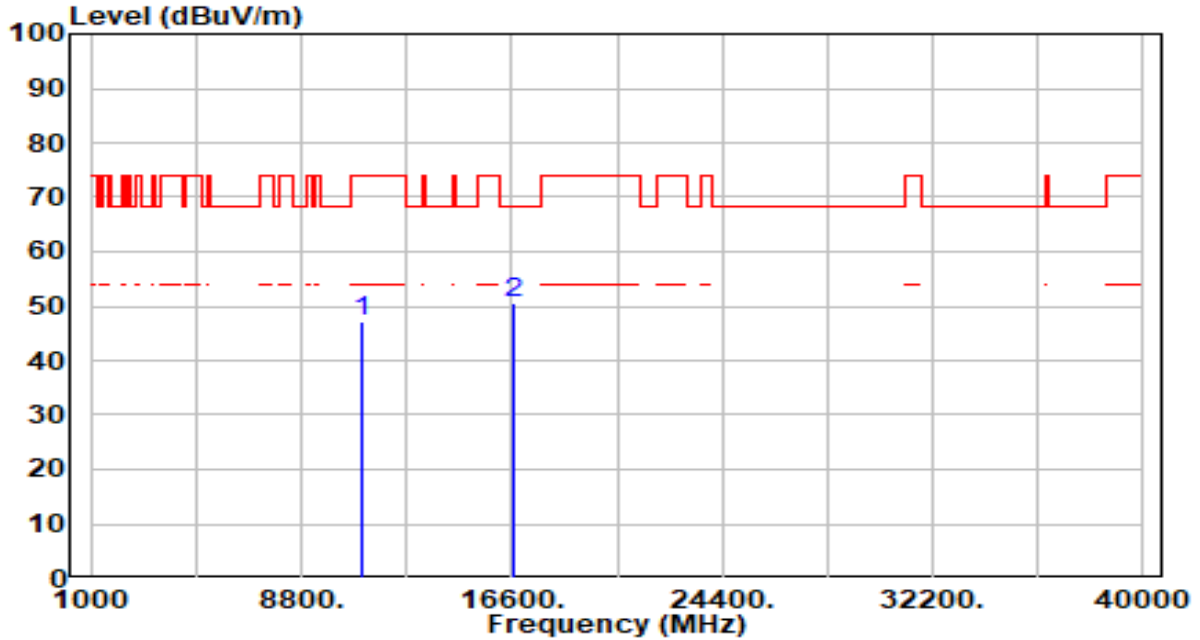

No	Frequency (MHz)	Reading (dBuV)	C.F (dB/m)	Measurement (dBuV/m)	Margin (dB)	Limit (dBuV/m)	Height (cm)	Angle (deg)	Remark (QP/PK/AV)
1	11100.000	42.34	4.78	47.12	-26.88	74.00	100	248	Peak
2	* 16650.000	44.32	6.14	50.46	-17.74	68.20	100	212	Peak

Note:

1. " *", means this data is the worst emission level.
2. C.F (Correction Factor) = Antenna Factor (dB/m)+ Cable Loss (dB) – Preamplifier(dB).
3. Measurement (dBuV/m) = Reading(dBuV) + C.F (Correction Factor).
4. The emission levels of other frequencies are very lower than the limit and not show in test report.

EUT	WiFi Module	Date of Test	2024-03-06
Factor	DRH18-E & BBHA 9170	Temp. / Humidity	23°C /61%
Polarity	Vertical	Site / Test Engineer	AC2 / Marvin
Test Mode	802.11ac-40MHz_TX_Band3_CH 110_ANT 0	Test Voltage	By Notebook PC

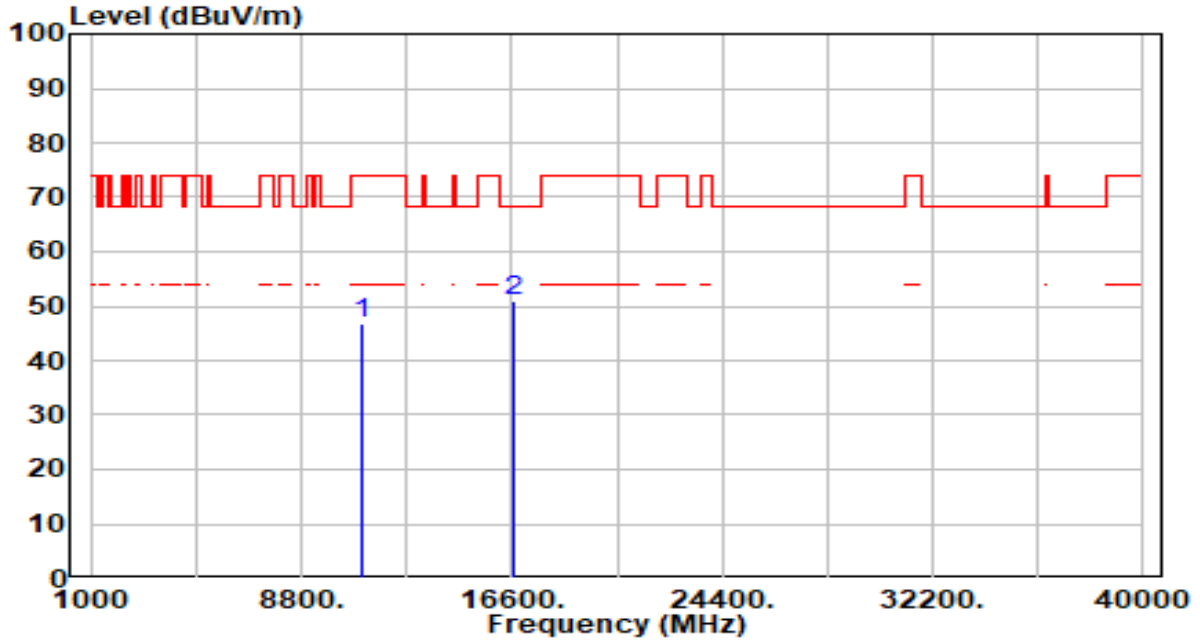

No	Frequency (MHz)	Reading (dBUV)	C.F (dB/m)	Measurement (dBUV/m)	Margin (dB)	Limit (dBUV/m)	Height (cm)	Angle (deg)	Remark (QP/PK/AV)
1	11100.000	42.16	4.78	46.94	-27.06	74.00	100	222	Peak
2	* 16650.000	44.85	6.14	50.99	-17.21	68.20	100	233	Peak

Note:

1. " *", means this data is the worst emission level.
2. C.F (Correction Factor) = Antenna Factor (dB/m)+ Cable Loss (dB) – Preamplifier(dB).
3. Measurement (dBUV/m) = Reading(dBUV) + C.F (Correction Factor).
4. The emission levels of other frequencies are very lower than the limit and not show in test report.

EUT	WiFi Module	Date of Test	2024-03-06
Factor	DRH18-E & BBHA 9170	Temp. / Humidity	23°C /61%
Polarity	Horizontal	Site / Test Engineer	AC2 / Marvin
Test Mode	802.11ac-40MHz_TX_Band3_CH 134_ANT 0	Test Voltage	By Notebook PC

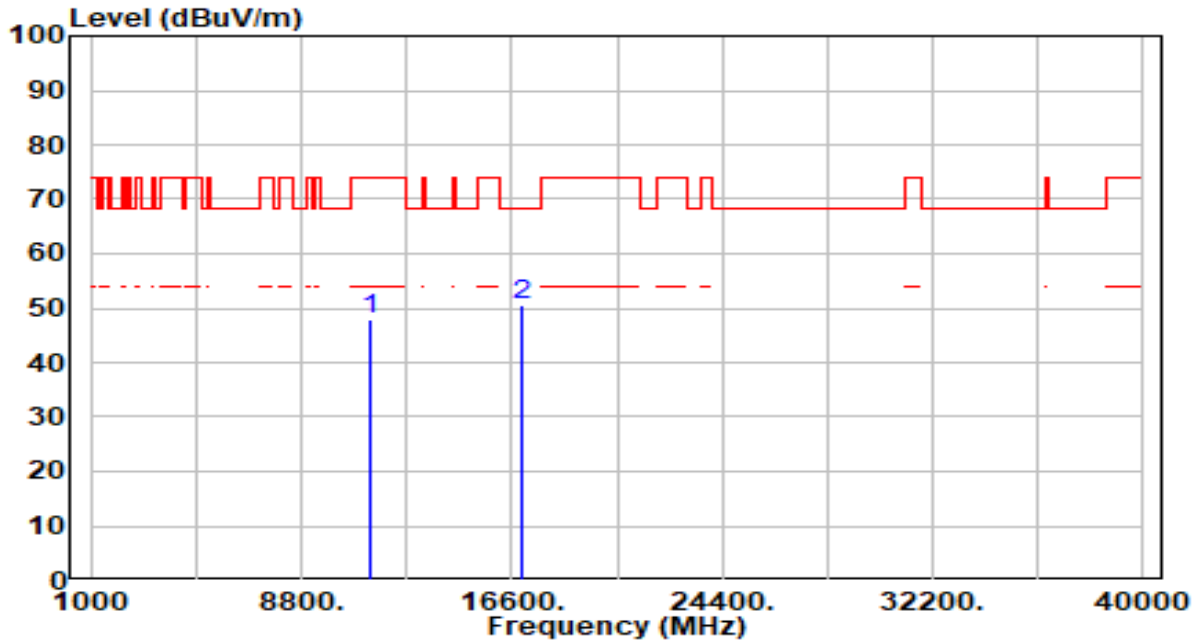

No	Frequency (MHz)	Reading (dBUV)	C.F (dB/m)	Measurement (dBUV/m)	Margin (dB)	Limit (dBUV/m)	Height (cm)	Angle (deg)	Remark (QP/PK/AV)
1	11340.000	42.88	5.20	48.08	-25.92	74.00	100	87	Peak
2	* 17010.000	44.52	6.12	50.65	-17.55	68.20	100	212	Peak

Note:

1. " *", means this data is the worst emission level.
2. C.F (Correction Factor) = Antenna Factor (dB/m)+ Cable Loss (dB) – Preamplifier(dB).
3. Measurement (dBUV/m) = Reading(dBUV) + C.F (Correction Factor).
4. The emission levels of other frequencies are very lower than the limit and not show in test report.

EUT	WiFi Module	Date of Test	2024-03-06
Factor	DRH18-E & BBHA 9170	Temp. / Humidity	23°C /61%
Polarity	Vertical	Site / Test Engineer	AC2 / Marvin
Test Mode	802.11ac-40MHz_TX_Band3_CH 134_ANT 0	Test Voltage	By Notebook PC

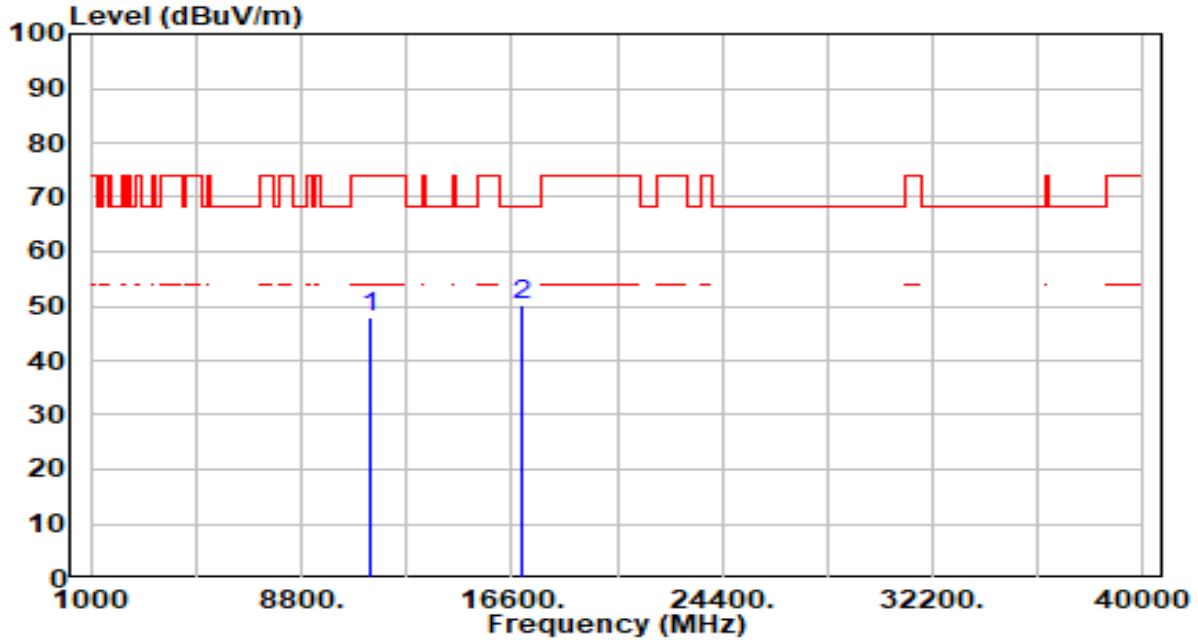

No	Frequency (MHz)	Reading (dBUV)	C.F (dB/m)	Measurement (dBUV/m)	Margin (dB)	Limit (dBUV/m)	Height (cm)	Angle (deg)	Remark (QP/PK/AV)
1	11340.000	42.90	5.20	48.10	-25.90	74.00	100	171	Peak
2	* 17010.000	43.94	6.12	50.06	-18.14	68.20	100	355	Peak

Note:

1. " *", means this data is the worst emission level.
2. C.F (Correction Factor) = Antenna Factor (dB/m)+ Cable Loss (dB) – Preamplifier(dB).
3. Measurement (dBUV/m) = Reading(dBUV) + C.F (Correction Factor).
4. The emission levels of other frequencies are very lower than the limit and not show in test report.

EUT	WiFi Module	Date of Test	2024-03-06
Factor	DRH18-E & BBHA 9170	Temp. / Humidity	23°C /61%
Polarity	Horizontal	Site / Test Engineer	AC2 / Marvin
Test Mode	802.11ac-40MHz_TX_Band3_CH 142_ANT 0	Test Voltage	By Notebook PC

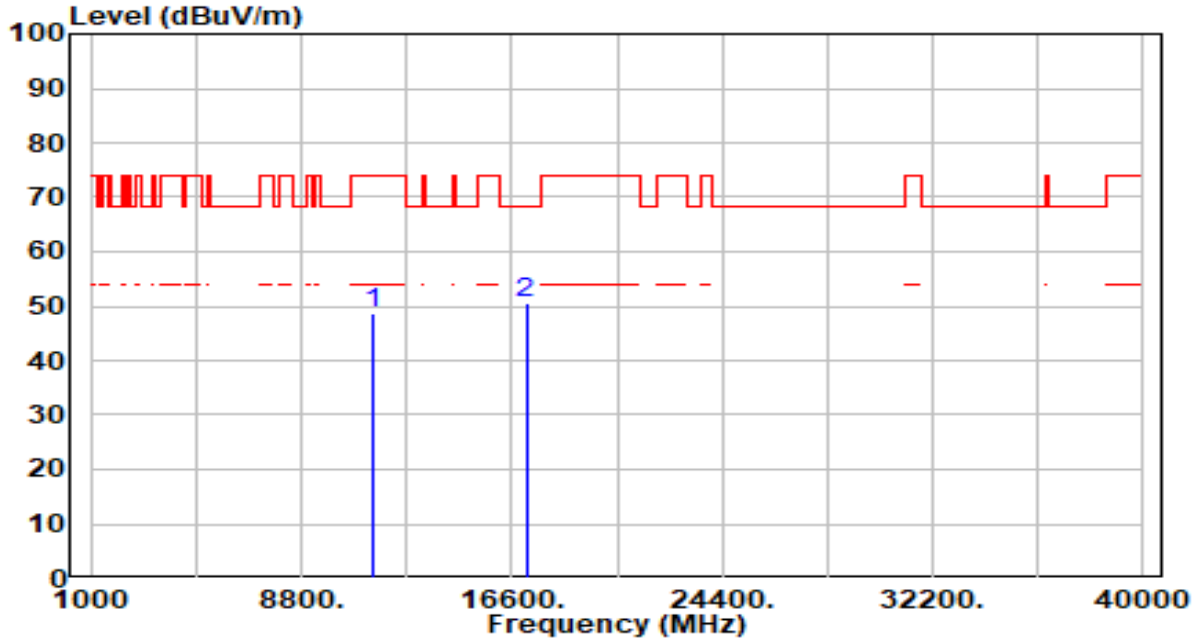

No	Frequency (MHz)	Reading (dBUV)	C.F (dB/m)	Measurement (dBUV/m)	Margin (dB)	Limit (dBUV/m)	Height (cm)	Angle (deg)	Remark (QP/PK/AV)
1	11420.000	43.23	5.28	48.51	-25.49	74.00	100	319	Peak
2	* 17130.000	44.57	5.92	50.49	-17.71	68.20	100	177	Peak

Note:

1. " *", means this data is the worst emission level.
2. C.F (Correction Factor) = Antenna Factor (dB/m)+ Cable Loss (dB) – Preamplifier(dB).
3. Measurement (dBUV/m) = Reading(dBUV) + C.F (Correction Factor).
4. The emission levels of other frequencies are very lower than the limit and not show in test report.

EUT	WiFi Module	Date of Test	2024-03-06
Factor	DRH18-E & BBHA 9170	Temp. / Humidity	23°C /61%
Polarity	Vertical	Site / Test Engineer	AC2 / Marvin
Test Mode	802.11ac-40MHz_TX_Band3_CH 142_ANT 0	Test Voltage	By Notebook PC

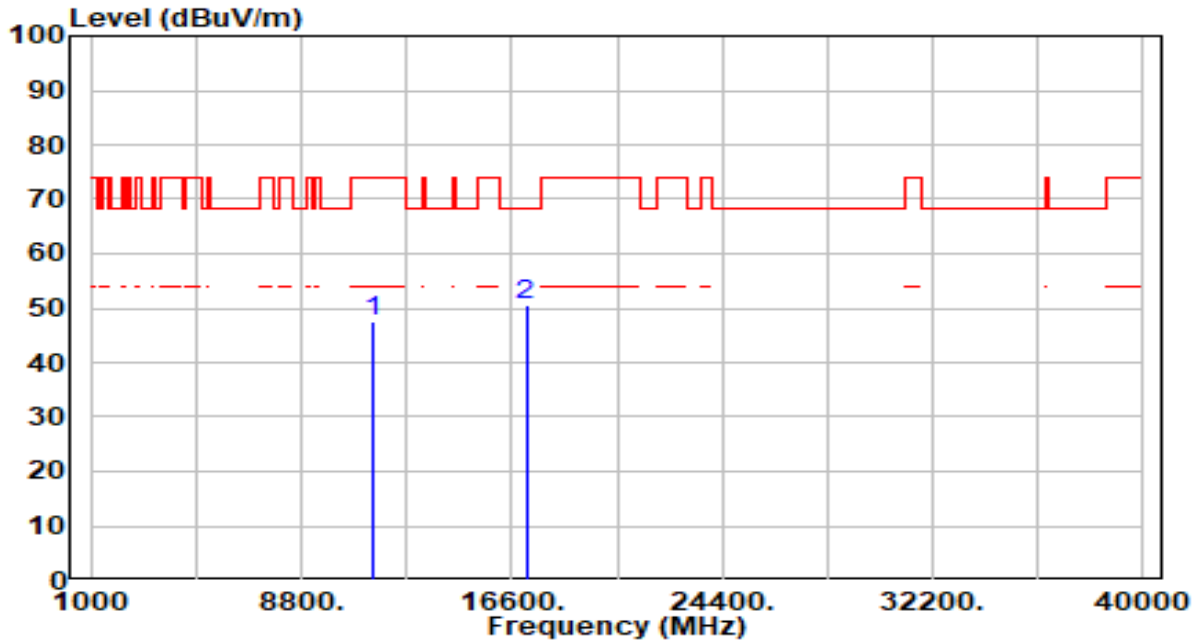

No	Frequency (MHz)	Reading (dBUV)	C.F (dB/m)	Measurement (dBUV/m)	Margin (dB)	Limit (dBUV/m)	Height (cm)	Angle (deg)	Remark (QP/PK/AV)
1	11420.000	42.32	5.28	47.60	-26.40	74.00	100	5	Peak
2	* 17130.000	44.60	5.92	50.52	-17.68	68.20	100	293	Peak

Note:

1. " *", means this data is the worst emission level.
2. C.F (Correction Factor) = Antenna Factor (dB/m)+ Cable Loss (dB) – Preamplifier(dB).
3. Measurement (dBUV/m) = Reading(dBUV) + C.F (Correction Factor).
4. The emission levels of other frequencies are very lower than the limit and not show in test report.

EUT	WiFi Module	Date of Test	2024-03-07
Factor	DRH18-E & BBHA 9170	Temp. / Humidity	23°C /61%
Polarity	Horizontal	Site / Test Engineer	AC2 / Marvin
Test Mode	802.11ac-40MHz_TX_Band4_CH 151_ANT 0	Test Voltage	By Notebook PC

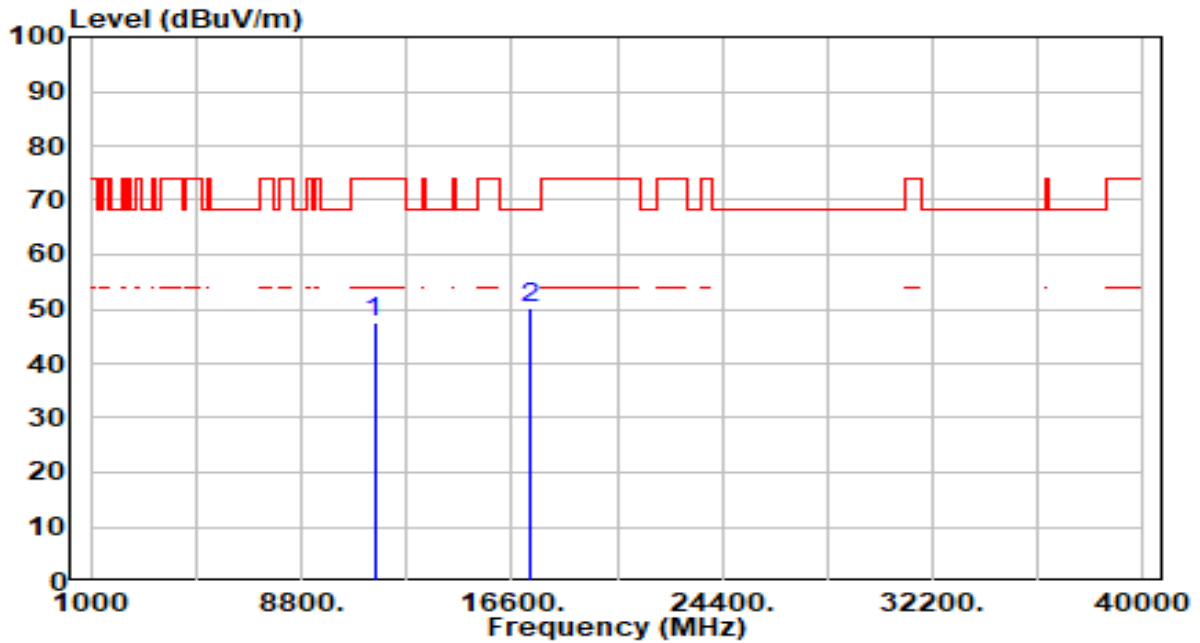

No	Frequency (MHz)	Reading (dBuV)	C.F (dB/m)	Measurement (dBuV/m)	Margin (dB)	Limit (dBuV/m)	Height (cm)	Angle (deg)	Remark (QP/PK/AV)
1	11510.000	42.26	5.33	47.59	-26.41	74.00	100	225	Peak
2	* 17265.000	44.61	5.63	50.24	-17.96	68.20	100	36	Peak

Note:

1. " *", means this data is the worst emission level.
2. C.F (Correction Factor) = Antenna Factor (dB/m)+ Cable Loss (dB) – Pre-amplifier(dB).
3. Measurement (dBuV/m) = Reading(dBuV) + C.F (Correction Factor).
4. The emission levels of other frequencies are very lower than the limit and not show in test report.

EUT	WiFi Module	Date of Test	2024-03-07
Factor	DRH18-E & BBHA 9170	Temp. / Humidity	23°C /61%
Polarity	Vertical	Site / Test Engineer	AC2 / Marvin
Test Mode	802.11ac-40MHz_TX_Band4_CH 151_ANT 0	Test Voltage	By Notebook PC

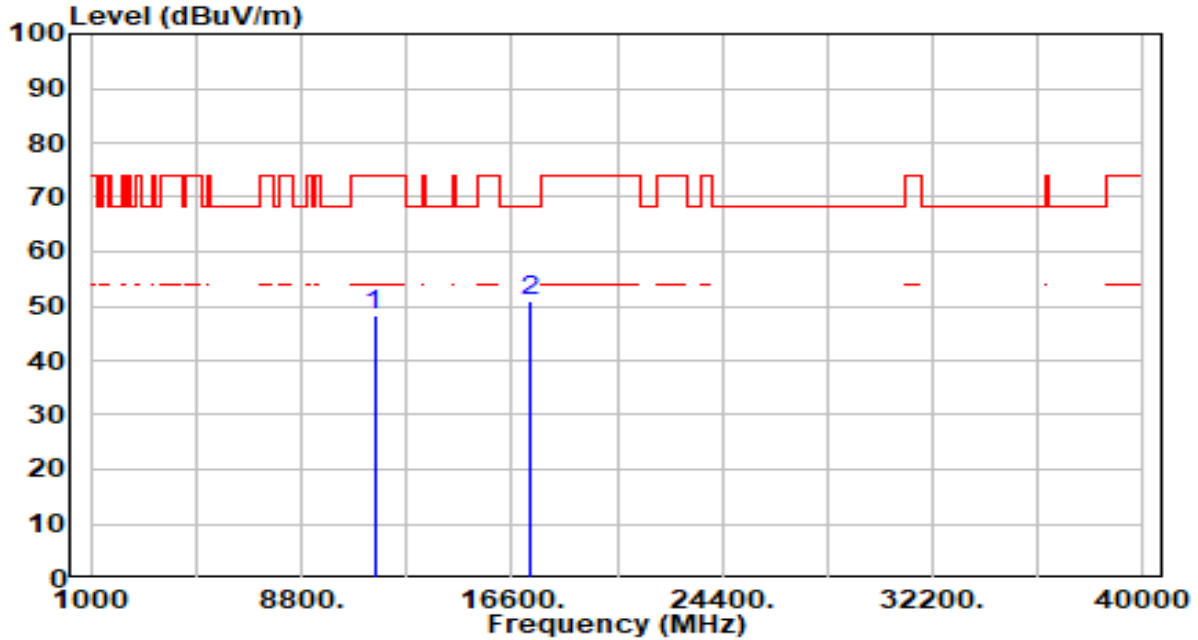

No	Frequency (MHz)	Reading (dBUV)	C.F (dB/m)	Measurement (dBUV/m)	Margin (dB)	Limit (dBUV/m)	Height (cm)	Angle (deg)	Remark (QP/PK/AV)
1	11510.000	42.86	5.33	48.19	-25.81	74.00	100	256	Peak
2	* 17265.000	45.42	5.63	51.05	-17.15	68.20	100	239	Peak

Note:

1. " *", means this data is the worst emission level.
2. C.F (Correction Factor) = Antenna Factor (dB/m)+ Cable Loss (dB) – Preamplifier(dB).
3. Measurement (dBUV/m) = Reading(dBUV) + C.F (Correction Factor).
4. The emission levels of other frequencies are very lower than the limit and not show in test report.

EUT	WiFi Module	Date of Test	2024-03-07
Factor	DRH18-E & BBHA 9170	Temp. / Humidity	23°C /61%
Polarity	Horizontal	Site / Test Engineer	AC2 / Marvin
Test Mode	802.11ac-40MHz_TX_Band4_CH 159_ANT 0	Test Voltage	By Notebook PC

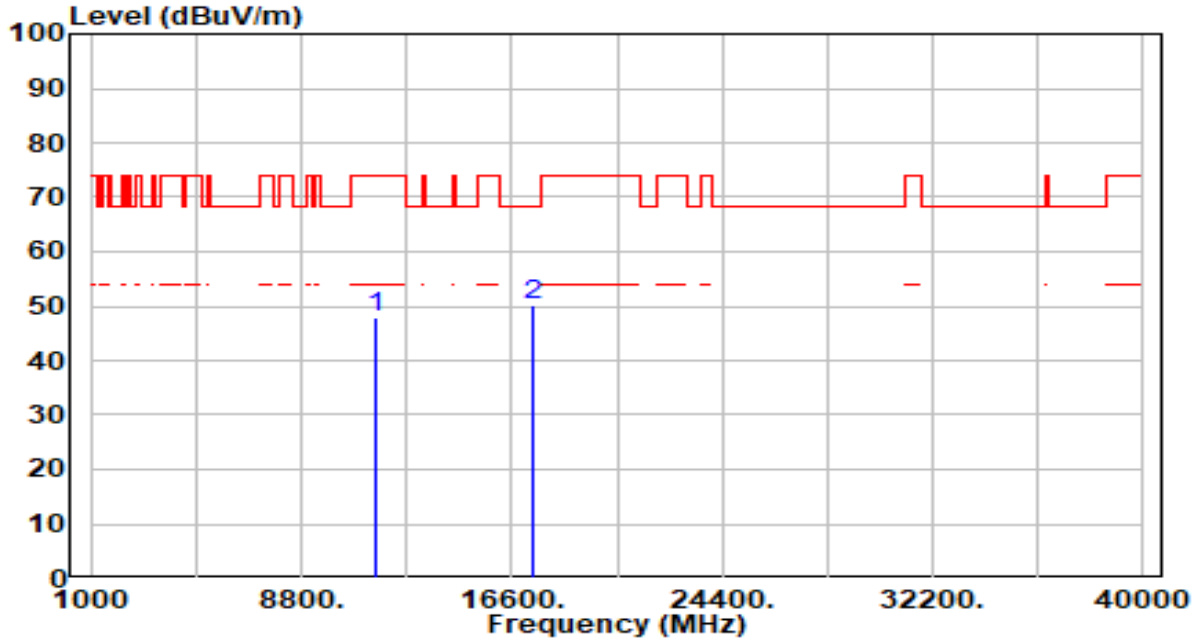

No	Frequency (MHz)	Reading (dBUV)	C.F (dB/m)	Measurement (dBUV/m)	Margin (dB)	Limit (dBUV/m)	Height (cm)	Angle (deg)	Remark (QP/PK/AV)
1	11590.000	42.63	5.39	48.03	-25.97	74.00	100	62	Peak
2	* 17385.000	44.82	5.31	50.13	-18.07	68.20	100	0	Peak

Note:

1. " *", means this data is the worst emission level.
2. C.F (Correction Factor) = Antenna Factor (dB/m)+ Cable Loss (dB) – Preamplifier(dB).
3. Measurement (dBUV/m) = Reading(dBUV) + C.F (Correction Factor).
4. The emission levels of other frequencies are very lower than the limit and not show in test report.

EUT	WiFi Module	Date of Test	2024-03-07
Factor	DRH18-E & BBHA 9170	Temp. / Humidity	23°C /61%
Polarity	Vertical	Site / Test Engineer	AC2 / Marvin
Test Mode	802.11ac-40MHz_TX_Band4_CH 159_ANT 0	Test Voltage	By Notebook PC

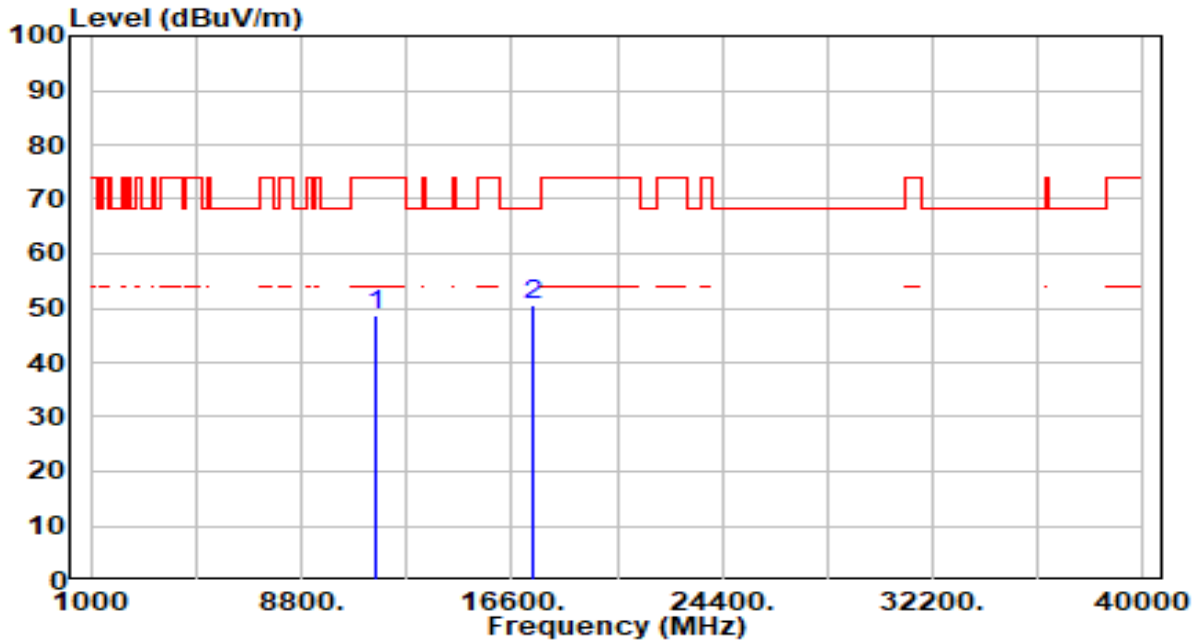

No	Frequency (MHz)	Reading (dBUV)	C.F (dB/m)	Measurement (dBUV/m)	Margin (dB)	Limit (dBUV/m)	Height (cm)	Angle (deg)	Remark (QP/PK/AV)
1	11590.000	43.42	5.39	48.81	-25.19	74.00	100	360	Peak
2	* 17385.000	45.18	5.31	50.49	-17.71	68.20	100	182	Peak

Note:

1. " *", means this data is the worst emission level.
2. C.F (Correction Factor) = Antenna Factor (dB/m)+ Cable Loss (dB) – Preamplifier(dB).
3. Measurement (dBUV/m) = Reading(dBUV) + C.F (Correction Factor).
4. The emission levels of other frequencies are very lower than the limit and not show in test report.

EUT	WiFi Module	Date of Test	2024-03-07
Factor	DRH18-E & BBHA 9170	Temp. / Humidity	23°C /61%
Polarity	Horizontal	Site / Test Engineer	AC2 / Marvin
Test Mode	802.11ac-80MHz_TX_Band1_CH 42_ANT 0	Test Voltage	By Notebook PC

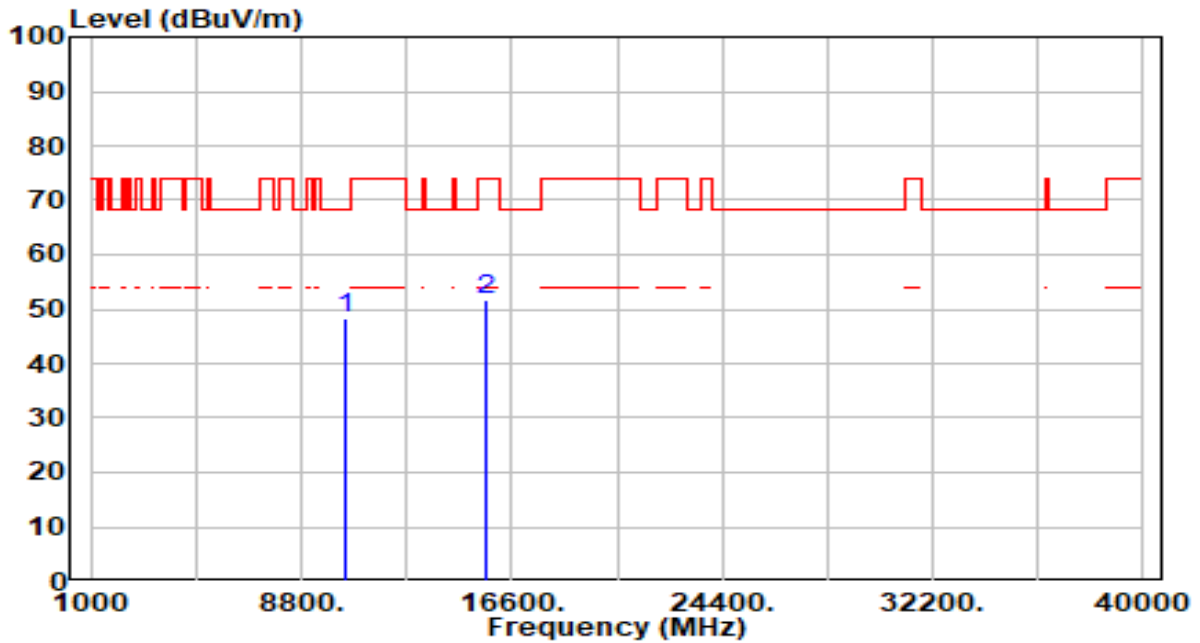

No	Frequency (MHz)	Reading (dBuV)	C.F (dB/m)	Measurement (dBuV/m)	Margin (dB)	Limit (dBuV/m)	Height (cm)	Angle (deg)	Remark (QP/PK/AV)
1	* 10420.000	43.37	4.79	48.16	-20.04	68.20	100	170	Peak
2	15630.000	45.35	6.21	51.56	-22.44	74.00	100	164	Peak

Note:

1. " *", means this data is the worst emission level.
2. C.F (Correction Factor) = Antenna Factor (dB/m)+ Cable Loss (dB) – Pre-amplifier(dB).
3. Measurement (dBuV/m) = Reading(dBuV) + C.F (Correction Factor).
4. The emission levels of other frequencies are very lower than the limit and not show in test report.

EUT	WiFi Module	Date of Test	2024-03-07
Factor	DRH18-E & BBHA 9170	Temp. / Humidity	23°C /61%
Polarity	Vertical	Site / Test Engineer	AC2 / Marvin
Test Mode	802.11ac-80MHz_TX_Band1_CH 42_ANT 0	Test Voltage	By Notebook PC

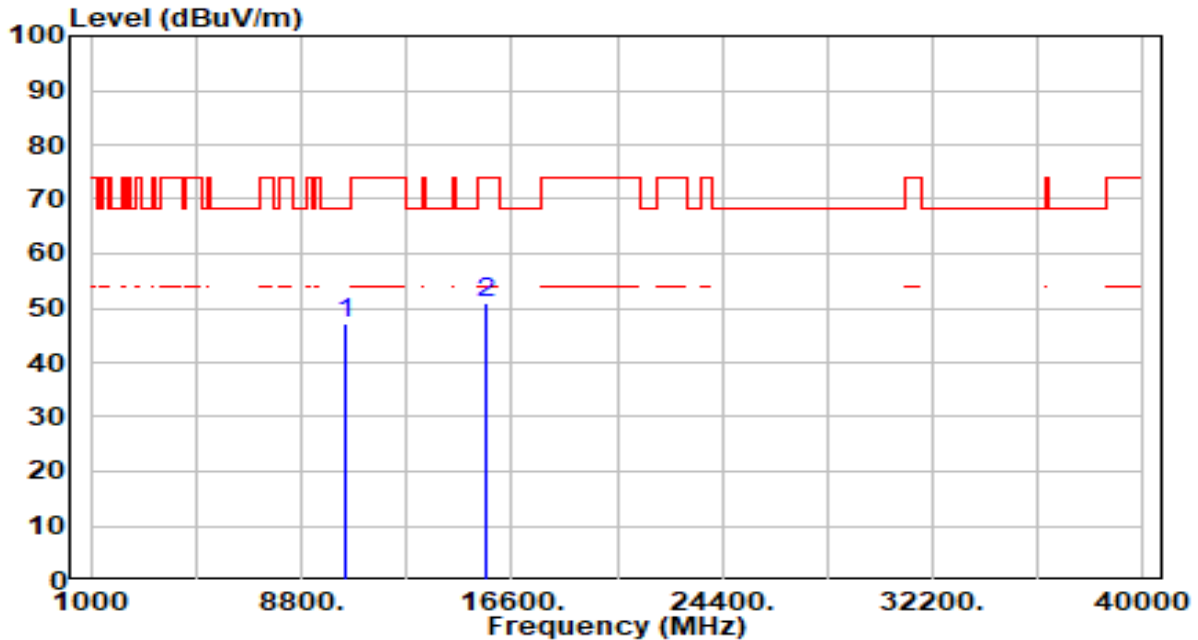

No	Frequency (MHz)	Reading (dBuV)	C.F (dB/m)	Measurement (dBuV/m)	Margin (dB)	Limit (dBuV/m)	Height (cm)	Angle (deg)	Remark (QP/PK/AV)
1	* 10420.000	42.36	4.79	47.16	-21.04	68.20	100	80	Peak
2	15630.000	44.89	6.21	51.09	-22.91	74.00	100	105	Peak

Note:

1. " *", means this data is the worst emission level.
2. C.F (Correction Factor) = Antenna Factor (dB/m)+ Cable Loss (dB) – Preamplifier(dB).
3. Measurement (dBuV/m) = Reading(dBuV) + C.F (Correction Factor).
4. The emission levels of other frequencies are very lower than the limit and not show in test report.

EUT	WiFi Module	Date of Test	2024-03-07
Factor	DRH18-E & BBHA 9170	Temp. / Humidity	23°C /61%
Polarity	Horizontal	Site / Test Engineer	AC2 / Marvin
Test Mode	802.11ac-80MHz_TX_Band2_CH 58_ANT 0	Test Voltage	By Notebook PC

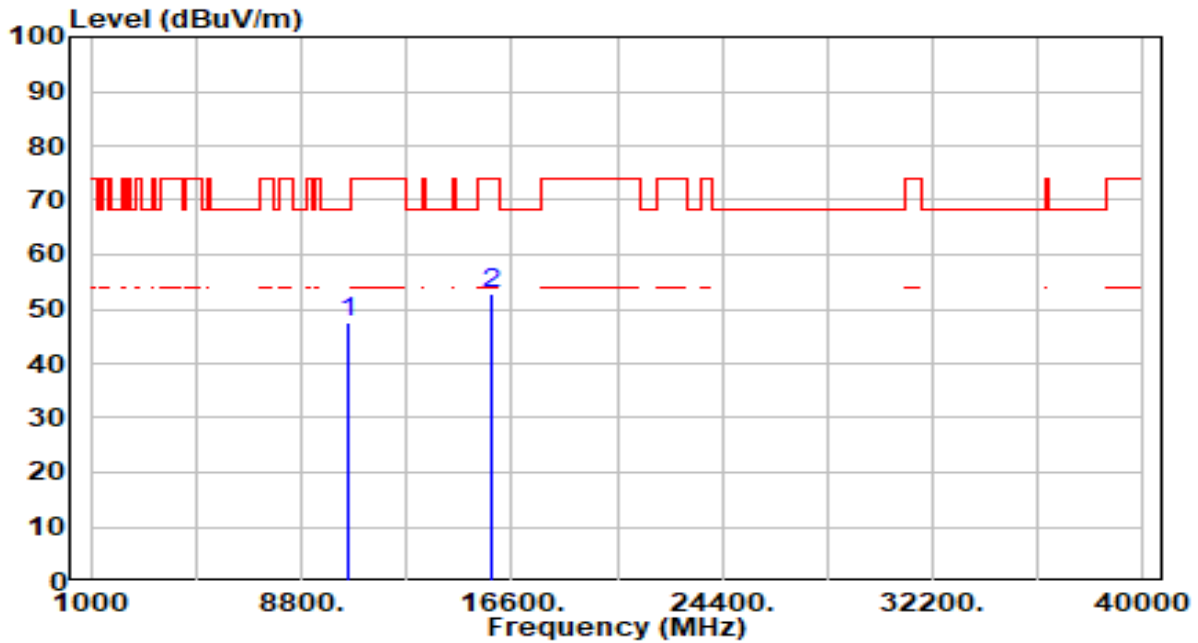

No	Frequency (MHz)	Reading (dBuV)	C.F (dB/m)	Measurement (dBuV/m)	Margin (dB)	Limit (dBuV/m)	Height (cm)	Angle (deg)	Remark (QP/PK/AV)
1	* 10580.000	42.90	4.63	47.52	-20.68	68.20	100	245	Peak
2	15870.000	46.37	6.55	52.92	-21.08	74.00	100	288	Peak

Note:

1. " *", means this data is the worst emission level.
2. C.F (Correction Factor) = Antenna Factor (dB/m)+ Cable Loss (dB) – Pre-amplifier(dB).
3. Measurement (dBuV/m) = Reading(dBuV) + C.F (Correction Factor).
4. The emission levels of other frequencies are very lower than the limit and not show in test report.

EUT	WiFi Module	Date of Test	2024-03-07
Factor	DRH18-E & BBHA 9170	Temp. / Humidity	23°C /61%
Polarity	Vertical	Site / Test Engineer	AC2 / Marvin
Test Mode	802.11ac-80MHz_TX_Band2_CH 58_ANT 0	Test Voltage	By Notebook PC

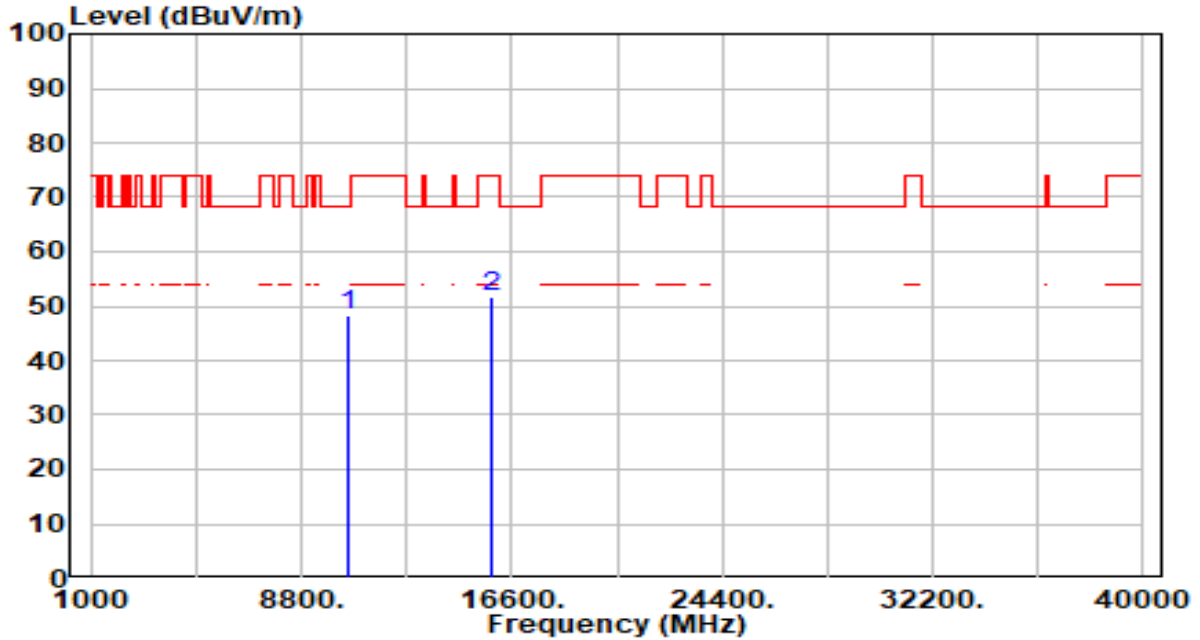

No	Frequency (MHz)	Reading (dBuV)	C.F (dB/m)	Measurement (dBuV/m)	Margin (dB)	Limit (dBuV/m)	Height (cm)	Angle (deg)	Remark (QP/PK/AV)
1	* 10580.000	43.57	4.63	48.20	-20.00	68.20	100	103	Peak
2	15870.000	45.07	6.55	51.61	-22.39	74.00	100	239	Peak

Note:

1. " *", means this data is the worst emission level.
2. C.F (Correction Factor) = Antenna Factor (dB/m)+ Cable Loss (dB) – Preamplifier(dB).
3. Measurement (dBuV/m) = Reading(dBuV) + C.F (Correction Factor).
4. The emission levels of other frequencies are very lower than the limit and not show in test report.

EUT	WiFi Module	Date of Test	2024-03-07
Factor	DRH18-E & BBHA 9170	Temp. / Humidity	23°C /61%
Polarity	Horizontal	Site / Test Engineer	AC2 / Marvin
Test Mode	802.11ac-80MHz_TX_Band3_CH 106_ANT 0	Test Voltage	By Notebook PC

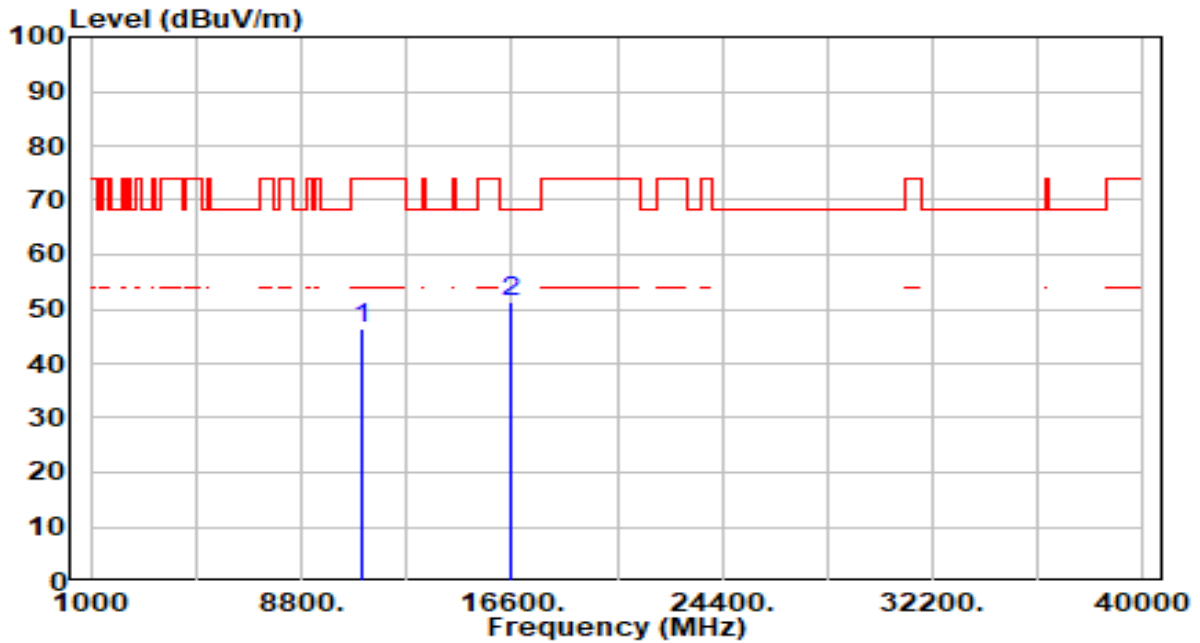

No	Frequency (MHz)	Reading (dBuV)	C.F (dB/m)	Measurement (dBuV/m)	Margin (dB)	Limit (dBuV/m)	Height (cm)	Angle (deg)	Remark (QP/PK/AV)
1	11060.000	41.78	4.68	46.45	-27.55	74.00	100	226	Peak
2	* 16590.000	45.09	6.11	51.19	-17.01	68.20	100	350	Peak

Note:

1. " *", means this data is the worst emission level.
2. C.F (Correction Factor) = Antenna Factor (dB/m)+ Cable Loss (dB) – Pre-amplifier(dB).
3. Measurement (dBuV/m) = Reading(dBuV) + C.F (Correction Factor).
4. The emission levels of other frequencies are very lower than the limit and not show in test report.

EUT	WiFi Module	Date of Test	2024-03-07
Factor	DRH18-E & BBHA 9170	Temp. / Humidity	23°C /61%
Polarity	Vertical	Site / Test Engineer	AC2 / Marvin
Test Mode	802.11ac-80MHz_TX_Band3_CH 106_ANT 0	Test Voltage	By Notebook PC

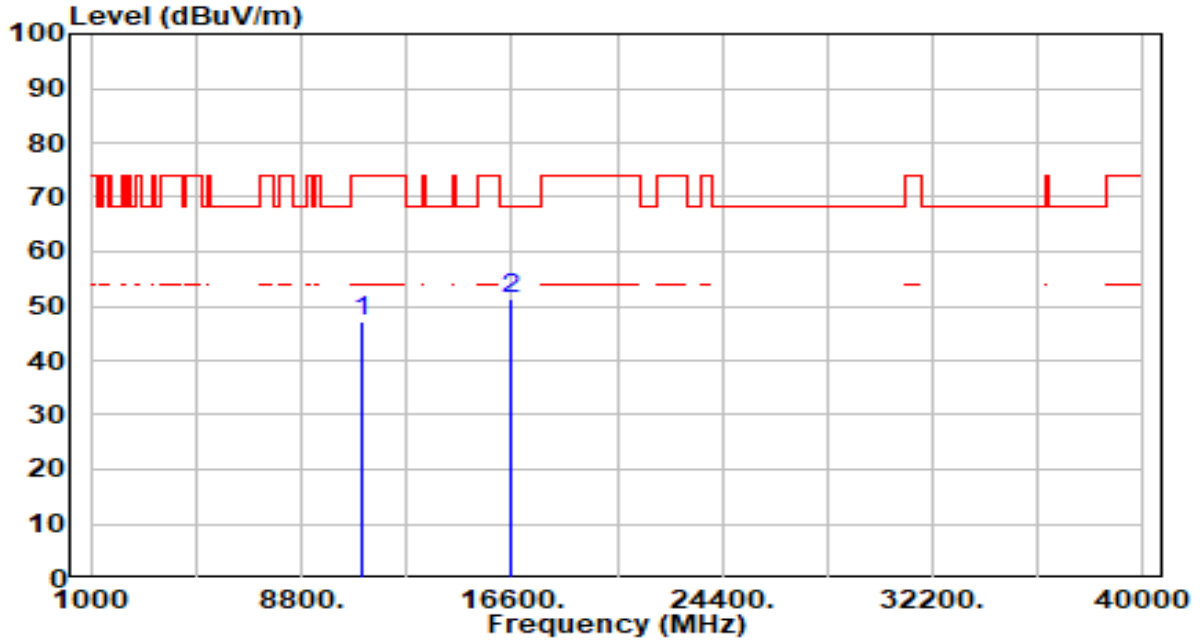

No	Frequency (MHz)	Reading (dBUV)	C.F (dB/m)	Measurement (dBUV/m)	Margin (dB)	Limit (dBUV/m)	Height (cm)	Angle (deg)	Remark (QP/PK/AV)
1	11060.000	42.66	4.68	47.34	-26.66	74.00	100	17	Peak
2	* 16590.000	45.18	6.11	51.29	-16.91	68.20	100	0	Peak

Note:

1. " *", means this data is the worst emission level.
2. C.F (Correction Factor) = Antenna Factor (dB/m)+ Cable Loss (dB) – Preamplifier(dB).
3. Measurement (dBUV/m) = Reading(dBUV) + C.F (Correction Factor).
4. The emission levels of other frequencies are very lower than the limit and not show in test report.

EUT	WiFi Module	Date of Test	2024-03-07
Factor	DRH18-E & BBHA 9170	Temp. / Humidity	23°C /61%
Polarity	Horizontal	Site / Test Engineer	AC2 / Marvin
Test Mode	802.11ac-80MHz_TX_Band3_CH 122_ANT 0	Test Voltage	By Notebook PC

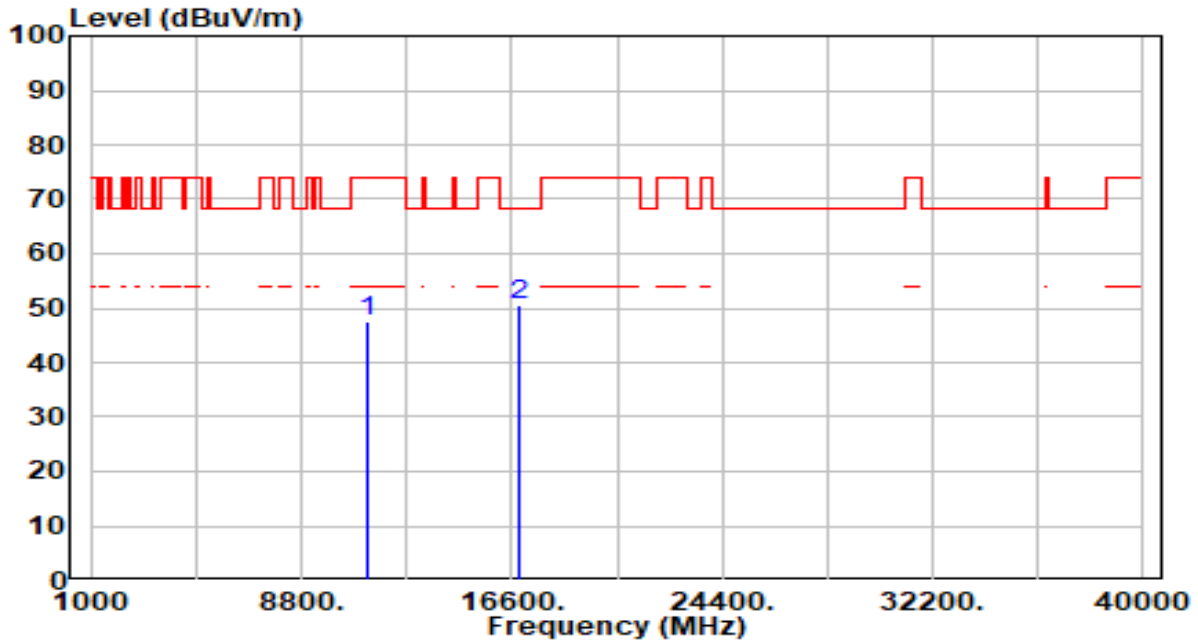

No	Frequency (MHz)	Reading (dBUV)	C.F (dB/m)	Measurement (dBUV/m)	Margin (dB)	Limit (dBUV/m)	Height (cm)	Angle (deg)	Remark (QP/PK/AV)
1	11220.000	42.36	5.06	47.43	-26.57	74.00	100	0	Peak
2	* 16830.000	44.31	6.21	50.52	-17.68	68.20	100	113	Peak

Note:

1. " *", means this data is the worst emission level.
2. C.F (Correction Factor) = Antenna Factor (dB/m)+ Cable Loss (dB) – Preamplifier(dB).
3. Measurement (dBUV/m) = Reading(dBUV) + C.F (Correction Factor).
4. The emission levels of other frequencies are very lower than the limit and not show in test report.

EUT	WiFi Module	Date of Test	2024-03-07
Factor	DRH18-E & BBHA 9170	Temp. / Humidity	23°C /61%
Polarity	Vertical	Site / Test Engineer	AC2 / Marvin
Test Mode	802.11ac-80MHz_TX_Band3_CH 122_ANT 0	Test Voltage	By Notebook PC

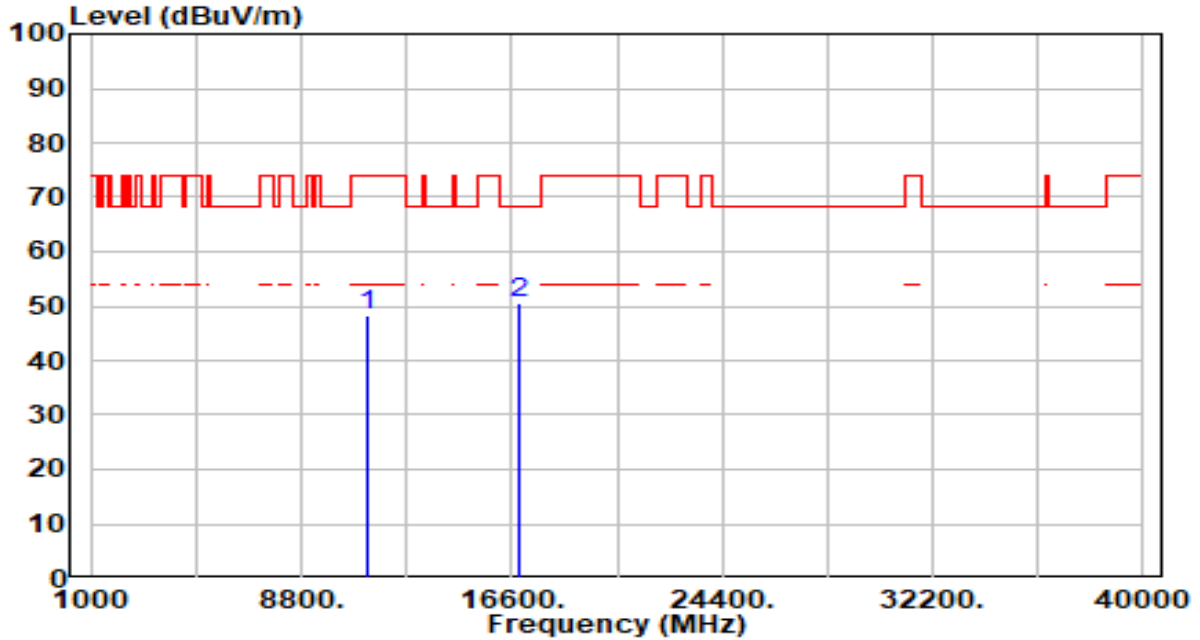

No	Frequency (MHz)	Reading (dBUV)	C.F (dB/m)	Measurement (dBUV/m)	Margin (dB)	Limit (dBUV/m)	Height (cm)	Angle (deg)	Remark (QP/PK/AV)
1	11220.000	43.34	5.06	48.40	-25.60	74.00	100	103	Peak
2	* 16830.000	44.26	6.21	50.47	-17.73	68.20	100	259	Peak

Note:

1. " *", means this data is the worst emission level.
2. C.F (Correction Factor) = Antenna Factor (dB/m)+ Cable Loss (dB) – Preamplifier(dB).
3. Measurement (dBUV/m) = Reading(dBUV) + C.F (Correction Factor).
4. The emission levels of other frequencies are very lower than the limit and not show in test report.

EUT	WiFi Module	Date of Test	2024-03-07
Factor	DRH18-E & BBHA 9170	Temp. / Humidity	23°C /61%
Polarity	Horizontal	Site / Test Engineer	AC2 / Marvin
Test Mode	802.11ac-80MHz_TX_Band3_CH 138_ANT 0	Test Voltage	By Notebook PC

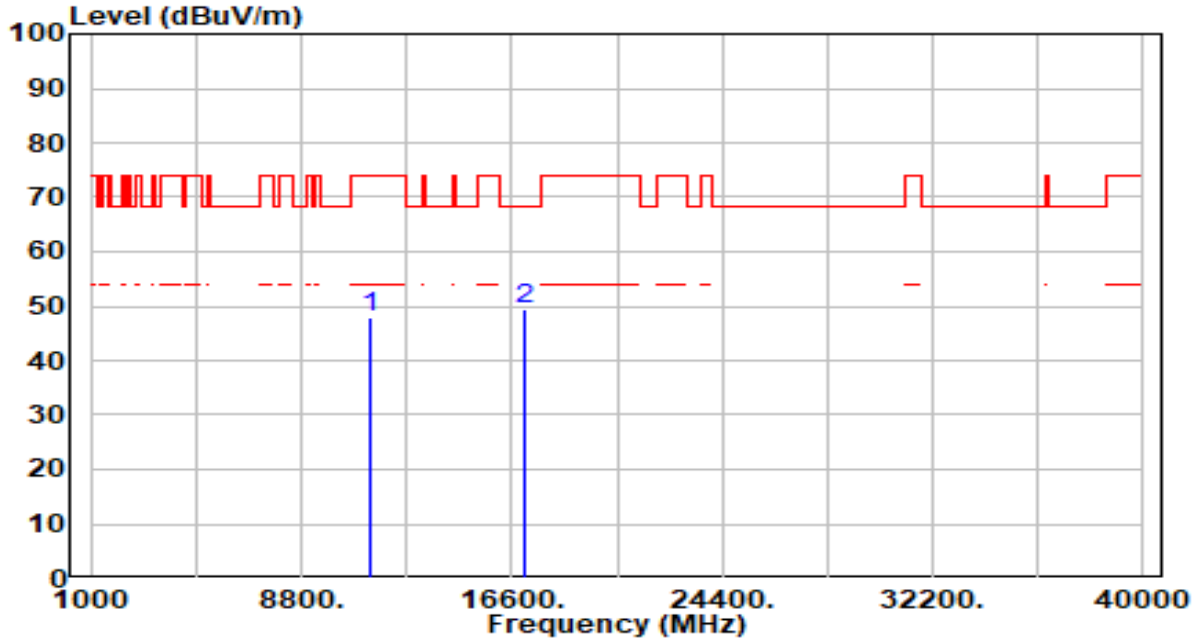

No	Frequency (MHz)	Reading (dBUV)	C.F (dB/m)	Measurement (dBUV/m)	Margin (dB)	Limit (dBUV/m)	Height (cm)	Angle (deg)	Remark (QP/PK/AV)
1	11380.000	42.56	5.24	47.80	-26.20	74.00	100	108	Peak
2	* 17070.000	43.41	6.02	49.43	-18.77	68.20	100	360	Peak

Note:

1. " *", means this data is the worst emission level.
2. C.F (Correction Factor) = Antenna Factor (dB/m)+ Cable Loss (dB) – Preamplifier(dB).
3. Measurement (dBUV/m) = Reading(dBUV) + C.F (Correction Factor).
4. The emission levels of other frequencies are very lower than the limit and not show in test report.

EUT	WiFi Module	Date of Test	2024-03-07
Factor	DRH18-E & BBHA 9170	Temp. / Humidity	23°C /61%
Polarity	Vertical	Site / Test Engineer	AC2 / Marvin
Test Mode	802.11ac-80MHz_TX_Band3_CH 138_ANT 0	Test Voltage	By Notebook PC

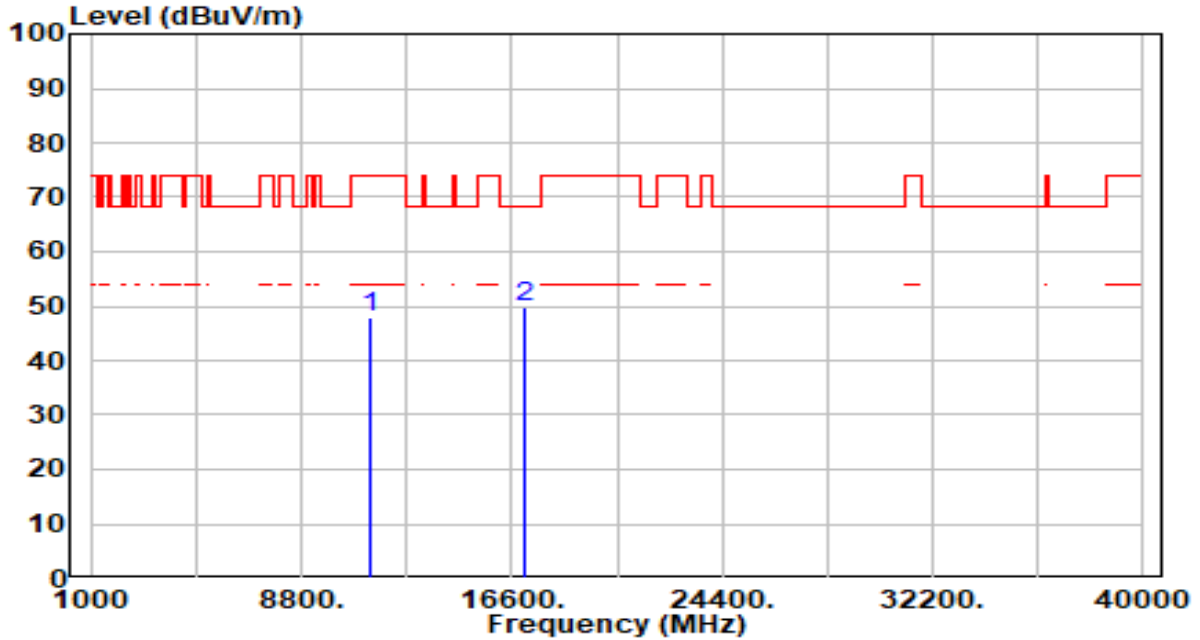

No	Frequency (MHz)	Reading (dBUV)	C.F (dB/m)	Measurement (dBUV/m)	Margin (dB)	Limit (dBUV/m)	Height (cm)	Angle (deg)	Remark (QP/PK/AV)
1	11380.000	42.83	5.24	48.07	-25.93	74.00	100	0	Peak
2	* 17070.000	43.64	6.02	49.66	-18.54	68.20	100	130	Peak

Note:

1. " *", means this data is the worst emission level.
2. C.F (Correction Factor) = Antenna Factor (dB/m)+ Cable Loss (dB) – Preamplifier(dB).
3. Measurement (dBUV/m) = Reading(dBUV) + C.F (Correction Factor).
4. The emission levels of other frequencies are very lower than the limit and not show in test report.

EUT	WiFi Module	Date of Test	2024-03-07
Factor	DRH18-E & BBHA 9170	Temp. / Humidity	23°C /61%
Polarity	Horizontal	Site / Test Engineer	AC2 / Marvin
Test Mode	802.11ac-80MHz_TX_Band4_CH 155_ANT 0	Test Voltage	By Notebook PC

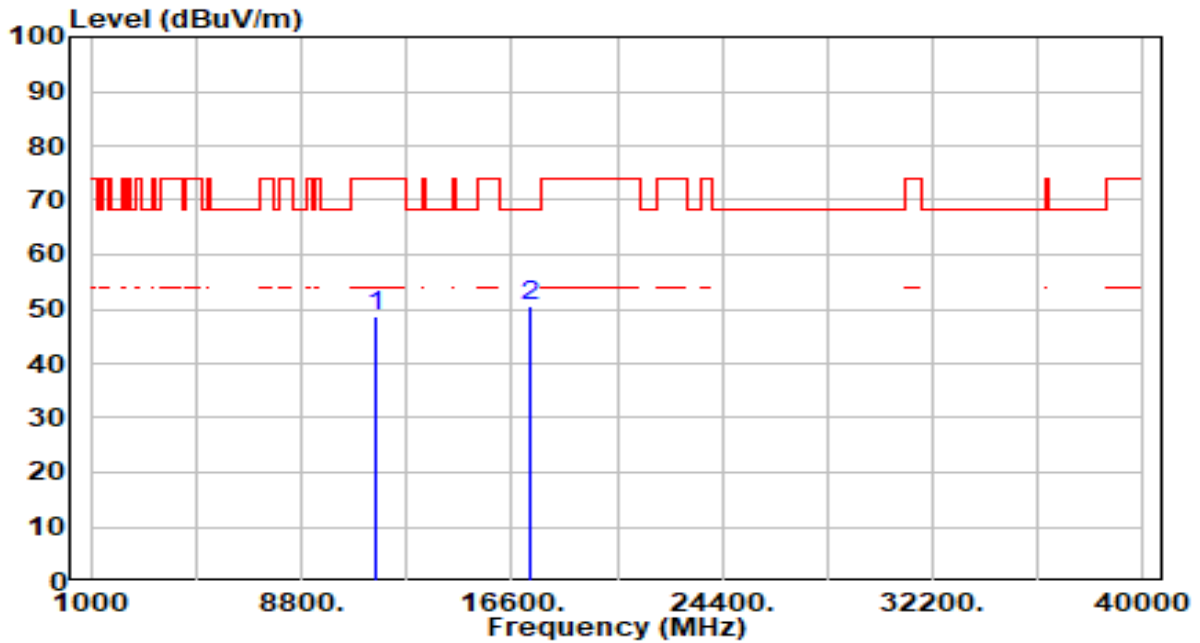

No	Frequency (MHz)	Reading (dBuV)	C.F (dB/m)	Measurement (dBuV/m)	Margin (dB)	Limit (dBuV/m)	Height (cm)	Angle (deg)	Remark (QP/PK/AV)
1	11550.000	43.26	5.36	48.62	-25.38	74.00	100	152	Peak
2	* 17325.000	45.27	5.47	50.74	-17.46	68.20	100	0	Peak

Note:

1. " *", means this data is the worst emission level.
2. C.F (Correction Factor) = Antenna Factor (dB/m)+ Cable Loss (dB) – Pre-amplifier(dB).
3. Measurement (dBuV/m) = Reading(dBuV) + C.F (Correction Factor).
4. The emission levels of other frequencies are very lower than the limit and not show in test report.

EUT	WiFi Module	Date of Test	2024-03-07
Factor	DRH18-E & BBHA 9170	Temp. / Humidity	23°C /61%
Polarity	Vertical	Site / Test Engineer	AC2 / Marvin
Test Mode	802.11ac-80MHz_TX_Band4_CH 155_ANT 0	Test Voltage	By Notebook PC

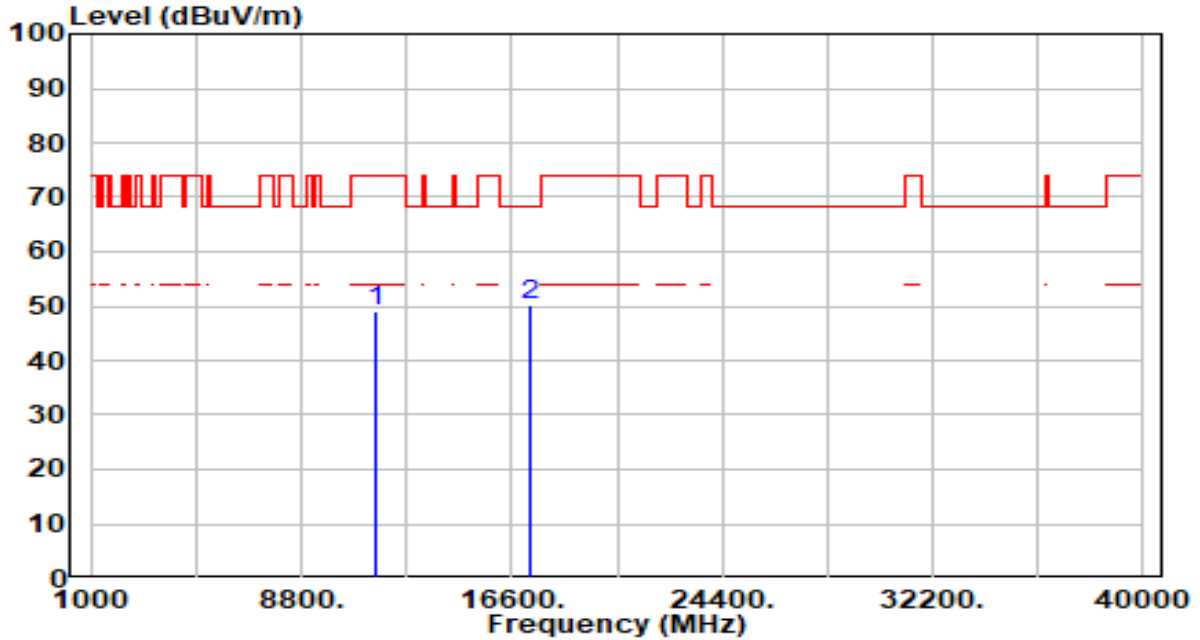

No	Frequency (MHz)	Reading (dBUV)	C.F (dB/m)	Measurement (dBUV/m)	Margin (dB)	Limit (dBUV/m)	Height (cm)	Angle (deg)	Remark (QP/PK/AV)
1	11550.000	43.81	5.36	49.18	-24.82	74.00	100	360	Peak
2	* 17325.000	44.85	5.47	50.31	-17.89	68.20	100	236	Peak

Note:

1. " *", means this data is the worst emission level.
2. C.F (Correction Factor) = Antenna Factor (dB/m)+ Cable Loss (dB) – Preamplifier(dB).
3. Measurement (dBUV/m) = Reading(dBUV) + C.F (Correction Factor).
4. The emission levels of other frequencies are very lower than the limit and not show in test report.

EUT	WiFi Module	Date of Test	2024-03-07
Factor	DRH18-E & BBHA 9170	Temp. / Humidity	23°C /61%
Polarity	Horizontal	Site / Test Engineer	AC2 / Marvin
Test Mode	802.11ax-20MHz_TX_Band1_CH 36_ANT 0	Test Voltage	By Notebook PC

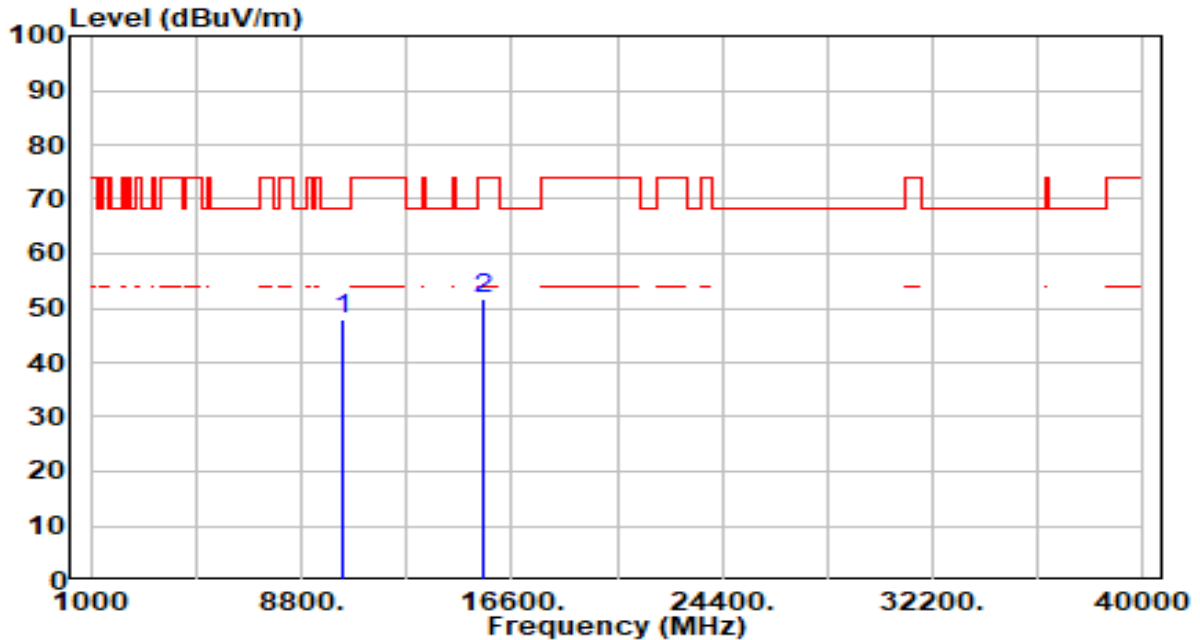

No	Frequency (MHz)	Reading (dBUV)	C.F (dB/m)	Measurement (dBUV/m)	Margin (dB)	Limit (dBUV/m)	Height (cm)	Angle (deg)	Remark (QP/PK/AV)
1	* 10360.000	42.96	4.87	47.83	-20.37	68.20	100	334	Peak
2	15540.000	45.53	6.21	51.73	-22.27	74.00	100	360	Peak

Note:

1. " *", means this data is the worst emission level.
2. C.F (Correction Factor) = Antenna Factor (dB/m)+ Cable Loss (dB) – Preamplifier(dB).
3. Measurement (dBUV/m) = Reading(dBUV) + C.F (Correction Factor).
4. The emission levels of other frequencies are very lower than the limit and not show in test report.

EUT	WiFi Module	Date of Test	2024-03-07
Factor	DRH18-E & BBHA 9170	Temp. / Humidity	23°C /61%
Polarity	Vertical	Site / Test Engineer	AC2 / Marvin
Test Mode	802.11ax-20MHz_TX_Band1_CH 36_ANT 0	Test Voltage	By Notebook PC

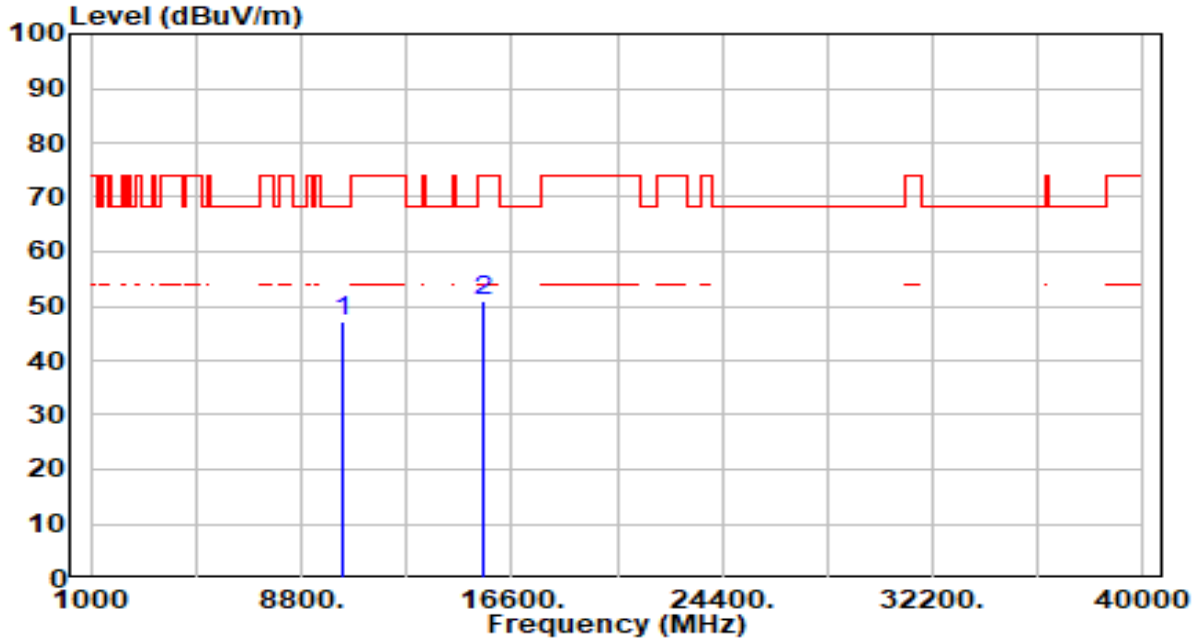

No	Frequency (MHz)	Reading (dBUV)	C.F (dB/m)	Measurement (dBUV/m)	Margin (dB)	Limit (dBUV/m)	Height (cm)	Angle (deg)	Remark (QP/PK/AV)
1	* 10360.000	42.32	4.87	47.19	-21.01	68.20	100	360	Peak
2	15540.000	44.92	6.21	51.13	-22.87	74.00	100	352	Peak

Note:

1. " *", means this data is the worst emission level.
2. C.F (Correction Factor) = Antenna Factor (dB/m)+ Cable Loss (dB) – Preamplifier(dB).
3. Measurement (dBUV/m) = Reading(dBUV) + C.F (Correction Factor).
4. The emission levels of other frequencies are very lower than the limit and not show in test report.

EUT	WiFi Module	Date of Test	2024-03-07
Factor	DRH18-E & BBHA 9170	Temp. / Humidity	23°C /61%
Polarity	Horizontal	Site / Test Engineer	AC2 / Marvin
Test Mode	802.11ax-20MHz_TX_Band1_CH 44_ANT 0	Test Voltage	By Notebook PC

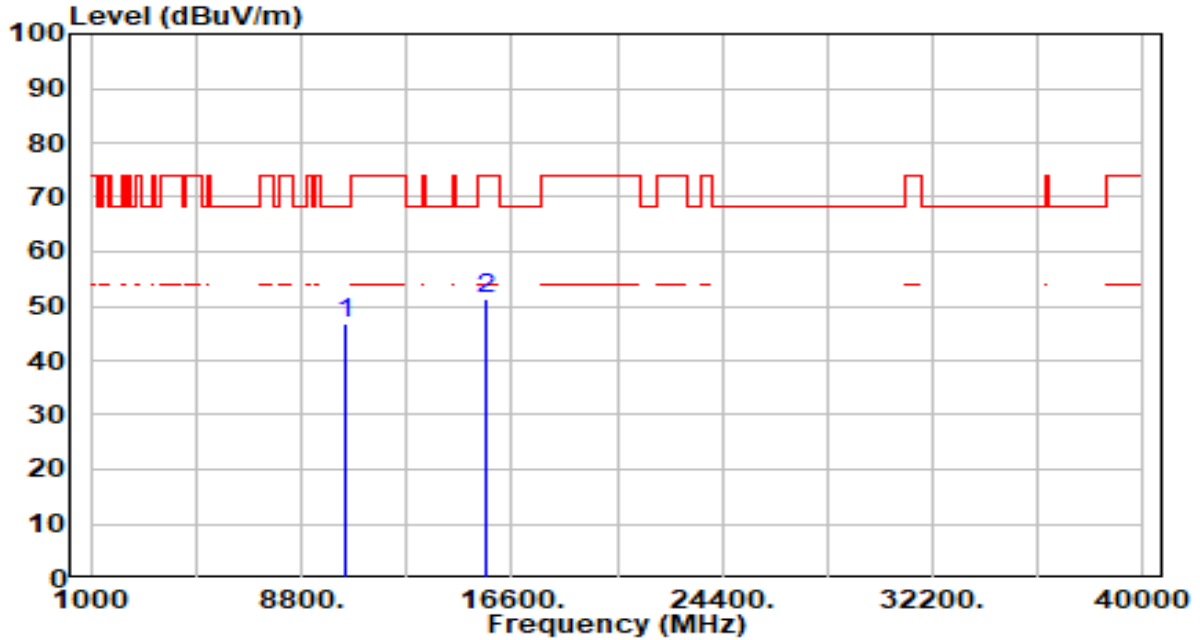

No	Frequency (MHz)	Reading (dBuV)	C.F (dB/m)	Measurement (dBuV/m)	Margin (dB)	Limit (dBuV/m)	Height (cm)	Angle (deg)	Remark (QP/PK/AV)
1	* 10440.000	42.16	4.76	46.93	-21.27	68.20	100	360	Peak
2	15660.000	45.23	6.27	51.50	-22.50	74.00	100	326	Peak

Note:

1. " *", means this data is the worst emission level.
2. C.F (Correction Factor) = Antenna Factor (dB/m)+ Cable Loss (dB) – Preamplifier(dB).
3. Measurement (dBuV/m) = Reading(dBuV) + C.F (Correction Factor).
4. The emission levels of other frequencies are very lower than the limit and not show in test report.

EUT	WiFi Module	Date of Test	2024-03-07
Factor	DRH18-E & BBHA 9170	Temp. / Humidity	23°C /61%
Polarity	Vertical	Site / Test Engineer	AC2 / Marvin
Test Mode	802.11ax-20MHz_TX_Band1_CH 44_ANT 0	Test Voltage	By Notebook PC

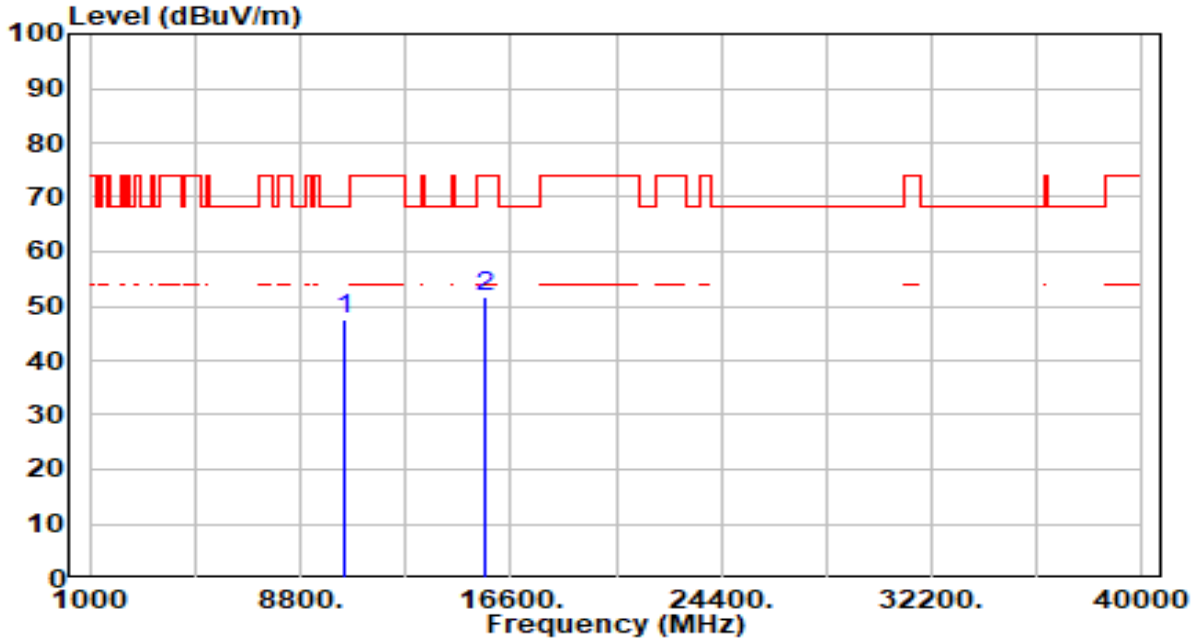

No	Frequency (MHz)	Reading (dBuV)	C.F (dB/m)	Measurement (dBuV/m)	Margin (dB)	Limit (dBuV/m)	Height (cm)	Angle (deg)	Remark (QP/PK/AV)
1	* 10440.000	42.85	4.76	47.61	-20.59	68.20	100	181	Peak
2	15660.000	45.39	6.27	51.66	-22.34	74.00	100	275	Peak

Note:

1. " *", means this data is the worst emission level.
2. C.F (Correction Factor) = Antenna Factor (dB/m)+ Cable Loss (dB) – Preamplifier(dB).
3. Measurement (dBuV/m) = Reading(dBuV) + C.F (Correction Factor).
4. The emission levels of other frequencies are very lower than the limit and not show in test report.

EUT	WiFi Module	Date of Test	2024-03-07
Factor	DRH18-E & BBHA 9170	Temp. / Humidity	23°C /61%
Polarity	Horizontal	Site / Test Engineer	AC2 / Marvin
Test Mode	802.11ax-20MHz_TX_Band1_CH 48_ANT 0	Test Voltage	By Notebook PC

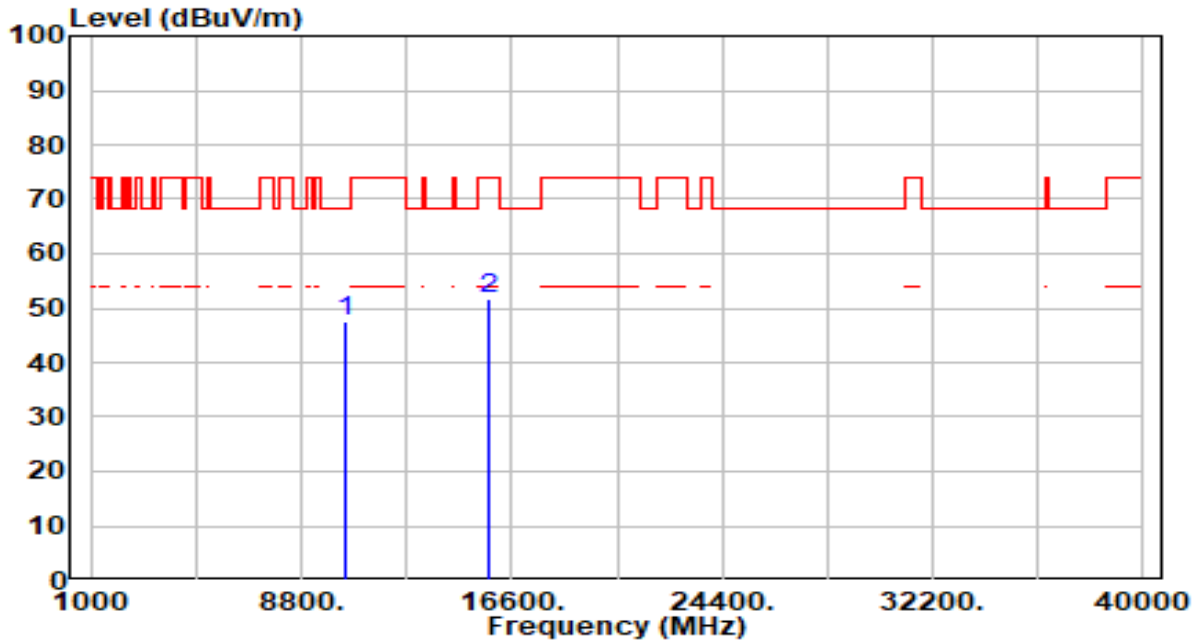

No	Frequency (MHz)	Reading (dBuV)	C.F (dB/m)	Measurement (dBuV/m)	Margin (dB)	Limit (dBuV/m)	Height (cm)	Angle (deg)	Remark (QP/PK/AV)
1	* 10480.000	42.93	4.71	47.64	-20.56	68.20	100	308	Peak
2	15720.000	45.41	6.39	51.80	-22.20	74.00	100	34	Peak

Note:

1. " *", means this data is the worst emission level.
2. C.F (Correction Factor) = Antenna Factor (dB/m)+ Cable Loss (dB) – Preamplifier(dB).
3. Measurement (dBuV/m) = Reading(dBuV) + C.F (Correction Factor).
4. The emission levels of other frequencies are very lower than the limit and not show in test report.

EUT	WiFi Module	Date of Test	2024-03-07
Factor	DRH18-E & BBHA 9170	Temp. / Humidity	23°C /61%
Polarity	Vertical	Site / Test Engineer	AC2 / Marvin
Test Mode	802.11ax-20MHz_TX_Band1_CH 48_ANT 0	Test Voltage	By Notebook PC

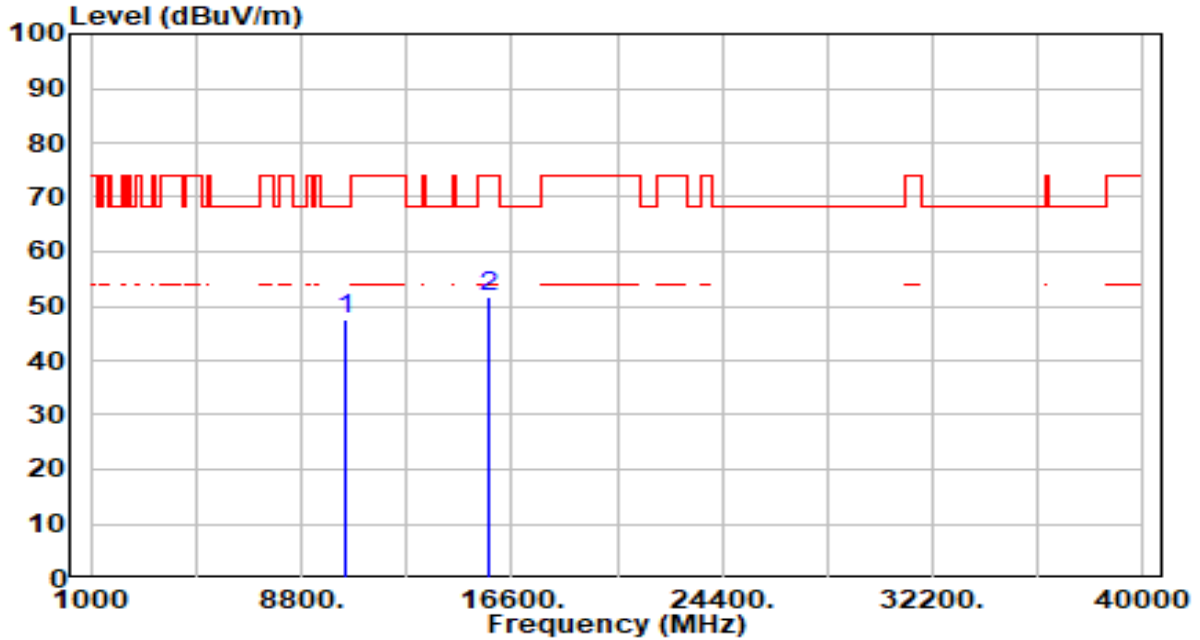

No	Frequency (MHz)	Reading (dBUV)	C.F (dB/m)	Measurement (dBUV/m)	Margin (dB)	Limit (dBUV/m)	Height (cm)	Angle (deg)	Remark (QP/PK/AV)
1	* 10480.000	42.70	4.71	47.41	-20.79	68.20	100	329	Peak
2	15720.000	45.32	6.39	51.71	-22.29	74.00	100	284	Peak

Note:

1. " *", means this data is the worst emission level.
2. C.F (Correction Factor) = Antenna Factor (dB/m)+ Cable Loss (dB) – Preamplifier(dB).
3. Measurement (dBUV/m) = Reading(dBUV) + C.F (Correction Factor).
4. The emission levels of other frequencies are very lower than the limit and not show in test report.

EUT	WiFi Module	Date of Test	2024-03-07
Factor	DRH18-E & BBHA 9170	Temp. / Humidity	23°C /61%
Polarity	Horizontal	Site / Test Engineer	AC2 / Marvin
Test Mode	802.11ax-20MHz_TX_Band2_CH 52_ANT 0	Test Voltage	By Notebook PC

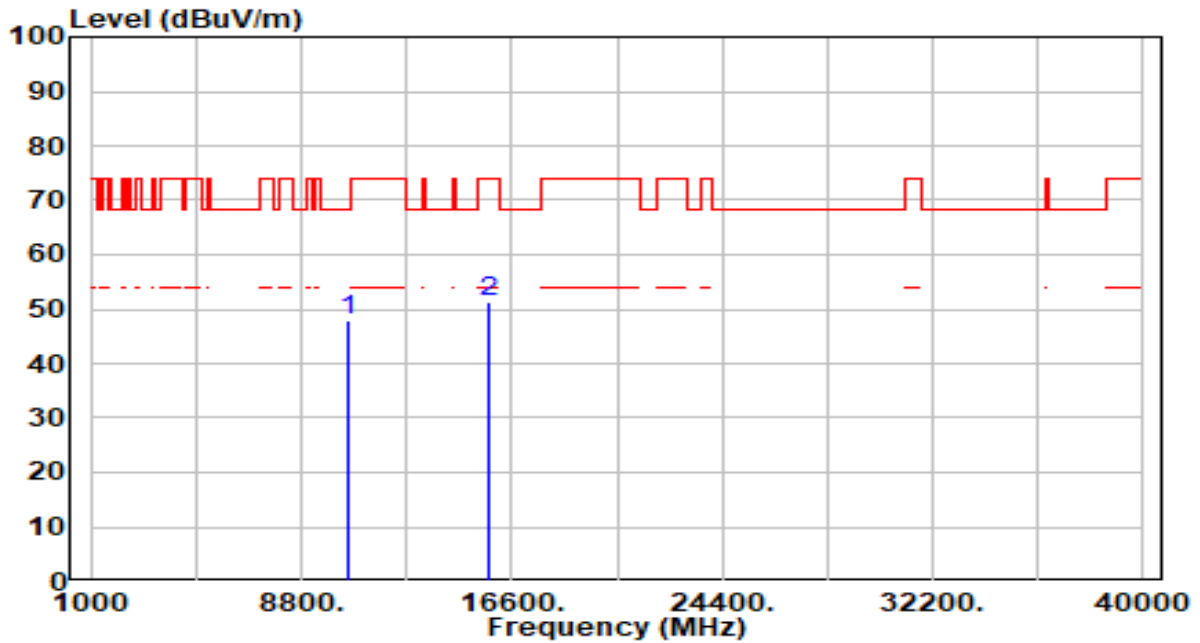

No	Frequency (MHz)	Reading (dBuV)	C.F (dB/m)	Measurement (dBuV/m)	Margin (dB)	Limit (dBuV/m)	Height (cm)	Angle (deg)	Remark (QP/PK/AV)
1	* 10520.000	43.09	4.67	47.76	-20.44	68.20	100	28	Peak
2	15780.000	44.90	6.51	51.41	-22.59	74.00	100	316	Peak

Note:

1. " *", means this data is the worst emission level.
2. C.F (Correction Factor) = Antenna Factor (dB/m)+ Cable Loss (dB) – Pre-amplifier(dB).
3. Measurement (dBuV/m) = Reading(dBuV) + C.F (Correction Factor).
4. The emission levels of other frequencies are very lower than the limit and not show in test report.

EUT	WiFi Module	Date of Test	2024-03-07
Factor	DRH18-E & BBHA 9170	Temp. / Humidity	23°C /61%
Polarity	Vertical	Site / Test Engineer	AC2 / Marvin
Test Mode	802.11ax-20MHz_TX_Band2_CH 52_ANT 0	Test Voltage	By Notebook PC

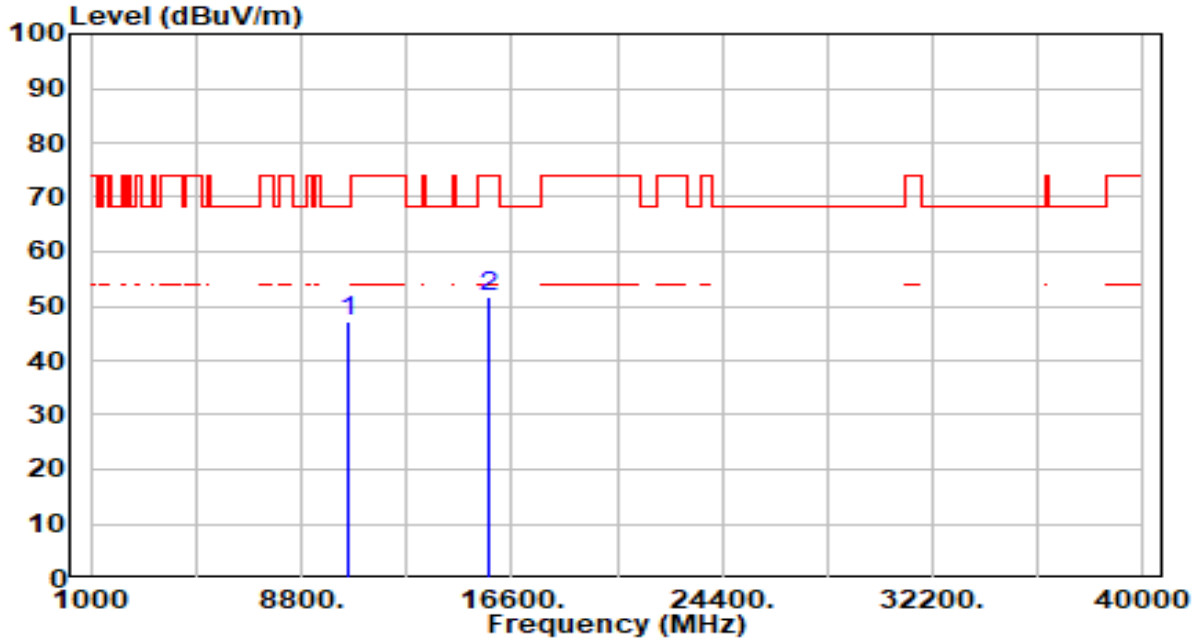

No	Frequency (MHz)	Reading (dBuV)	C.F (dB/m)	Measurement (dBuV/m)	Margin (dB)	Limit (dBuV/m)	Height (cm)	Angle (deg)	Remark (QP/PK/AV)
1	* 10520.000	42.55	4.67	47.22	-20.98	68.20	100	50	Peak
2	15780.000	45.16	6.51	51.67	-22.33	74.00	100	70	Peak

Note:

1. " *", means this data is the worst emission level.
2. C.F (Correction Factor) = Antenna Factor (dB/m)+ Cable Loss (dB) – Preamplifier(dB).
3. Measurement (dBuV/m) = Reading(dBuV) + C.F (Correction Factor).
4. The emission levels of other frequencies are very lower than the limit and not show in test report.

EUT	WiFi Module	Date of Test	2024-03-07
Factor	DRH18-E & BBHA 9170	Temp. / Humidity	23°C /61%
Polarity	Horizontal	Site / Test Engineer	AC2 / Marvin
Test Mode	802.11ax-20MHz_TX_Band2_CH 60_ANT 0	Test Voltage	By Notebook PC

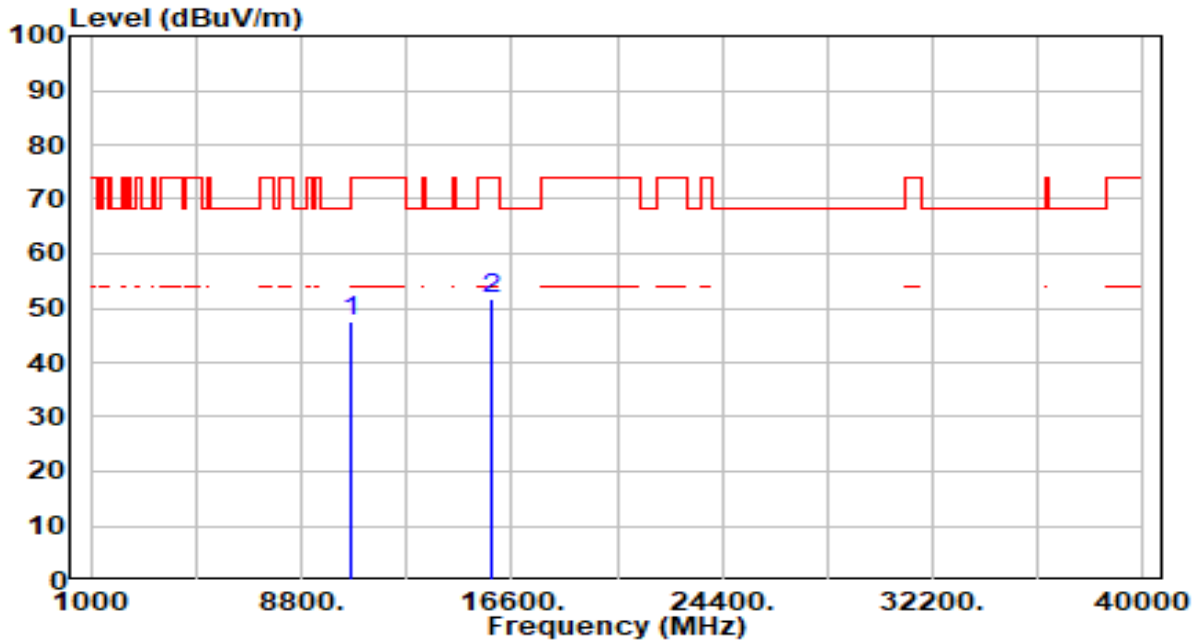

No	Frequency (MHz)	Reading (dBUV)	C.F (dB/m)	Measurement (dBUV/m)	Margin (dB)	Limit (dBUV/m)	Height (cm)	Angle (deg)	Remark (QP/PK/AV)
1	* 10600.000	42.84	4.61	47.45	-20.75	68.20	100	99	Peak
2	15900.000	45.29	6.55	51.84	-22.16	74.00	100	190	Peak

Note:

1. " *", means this data is the worst emission level.
2. C.F (Correction Factor) = Antenna Factor (dB/m)+ Cable Loss (dB) – Preamplifier(dB).
3. Measurement (dBUV/m) = Reading(dBUV) + C.F (Correction Factor).
4. The emission levels of other frequencies are very lower than the limit and not show in test report.

EUT	WiFi Module	Date of Test	2024-03-07
Factor	DRH18-E & BBHA 9170	Temp. / Humidity	23°C /61%
Polarity	Vertical	Site / Test Engineer	AC2 / Marvin
Test Mode	802.11ax-20MHz_TX_Band2_CH 60_ANT 0	Test Voltage	By Notebook PC

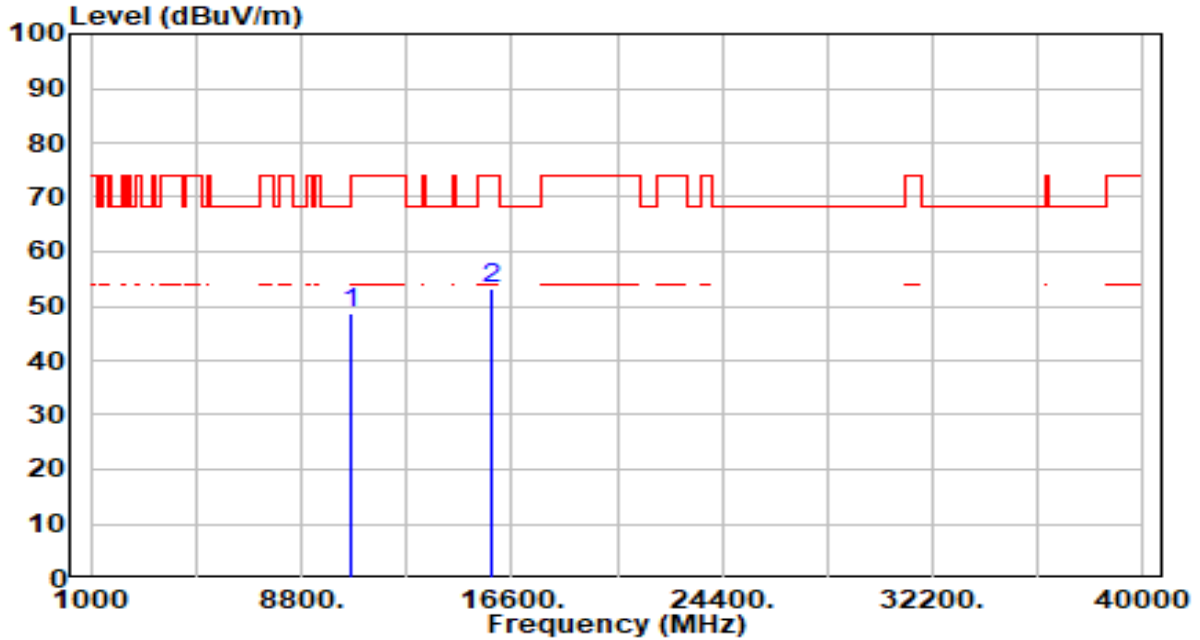

No	Frequency (MHz)	Reading (dBUV)	C.F (dB/m)	Measurement (dBUV/m)	Margin (dB)	Limit (dBUV/m)	Height (cm)	Angle (deg)	Remark (QP/PK/AV)
1	* 10600.000	44.06	4.61	48.67	-19.53	68.20	100	100	Peak
2	15900.000	46.49	6.55	53.04	-20.96	74.00	100	52	Peak

Note:

1. " *", means this data is the worst emission level.
2. C.F (Correction Factor) = Antenna Factor (dB/m)+ Cable Loss (dB) – Preamplifier(dB).
3. Measurement (dBUV/m) = Reading(dBUV) + C.F (Correction Factor).
4. The emission levels of other frequencies are very lower than the limit and not show in test report.

EUT	WiFi Module	Date of Test	2024-03-07
Factor	DRH18-E & BBHA 9170	Temp. / Humidity	23°C /61%
Polarity	Horizontal	Site / Test Engineer	AC2 / Marvin
Test Mode	802.11ax-20MHz_TX_Band2_CH 64_ANT 0	Test Voltage	By Notebook PC

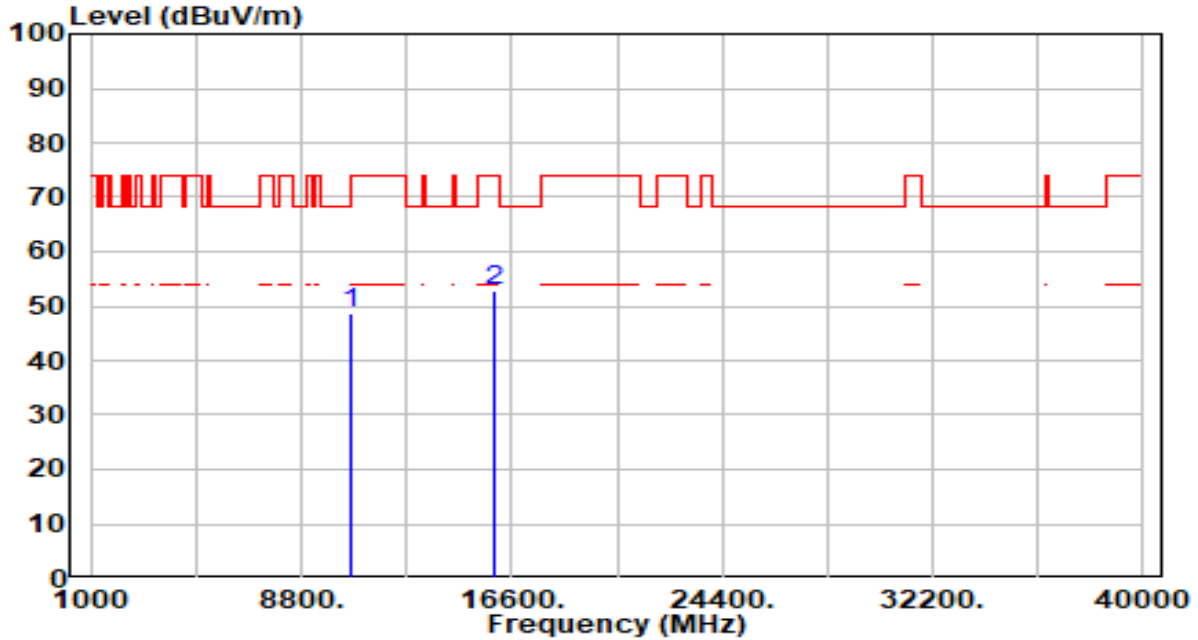

No	Frequency (MHz)	Reading (dBUV)	C.F (dB/m)	Measurement (dBUV/m)	Margin (dB)	Limit (dBUV/m)	Height (cm)	Angle (deg)	Remark (QP/PK/AV)
1	10640.000	43.98	4.62	48.61	-25.39	74.00	100	328	Peak
2	* 15960.000	46.18	6.55	52.73	-21.27	74.00	100	356	Peak

Note:

1. " *", means this data is the worst emission level.
2. C.F (Correction Factor) = Antenna Factor (dB/m)+ Cable Loss (dB) – Preamplifier(dB).
3. Measurement (dBUV/m) = Reading(dBUV) + C.F (Correction Factor).
4. The emission levels of other frequencies are very lower than the limit and not show in test report.

EUT	WiFi Module	Date of Test	2024-03-07
Factor	DRH18-E & BBHA 9170	Temp. / Humidity	23°C /61%
Polarity	Vertical	Site / Test Engineer	AC2 / Marvin
Test Mode	802.11ax-20MHz_TX_Band2_CH 64_ANT 0	Test Voltage	By Notebook PC

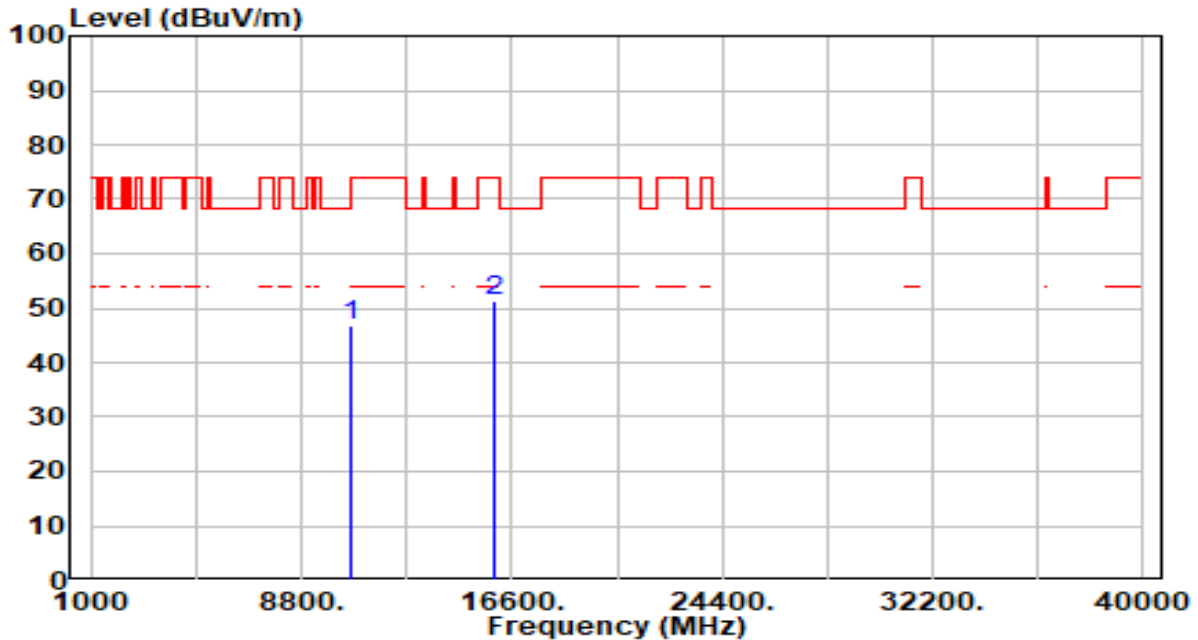

No	Frequency (MHz)	Reading (dBuV)	C.F (dB/m)	Measurement (dBuV/m)	Margin (dB)	Limit (dBuV/m)	Height (cm)	Angle (deg)	Remark (QP/PK/AV)
1	10640.000	42.35	4.62	46.97	-27.03	74.00	100	360	Peak
2	* 15960.000	44.65	6.55	51.20	-22.80	74.00	100	26	Peak

Note:

1. " *", means this data is the worst emission level.
2. C.F (Correction Factor) = Antenna Factor (dB/m)+ Cable Loss (dB) – Preamplifier(dB).
3. Measurement (dBuV/m) = Reading(dBuV) + C.F (Correction Factor).
4. The emission levels of other frequencies are very lower than the limit and not show in test report.

EUT	WiFi Module	Date of Test	2024-03-07
Factor	DRH18-E & BBHA 9170	Temp. / Humidity	23°C /61%
Polarity	Horizontal	Site / Test Engineer	AC2 / Marvin
Test Mode	802.11ax-20MHz_TX_Band3_CH 100_ANT 0	Test Voltage	By Notebook PC

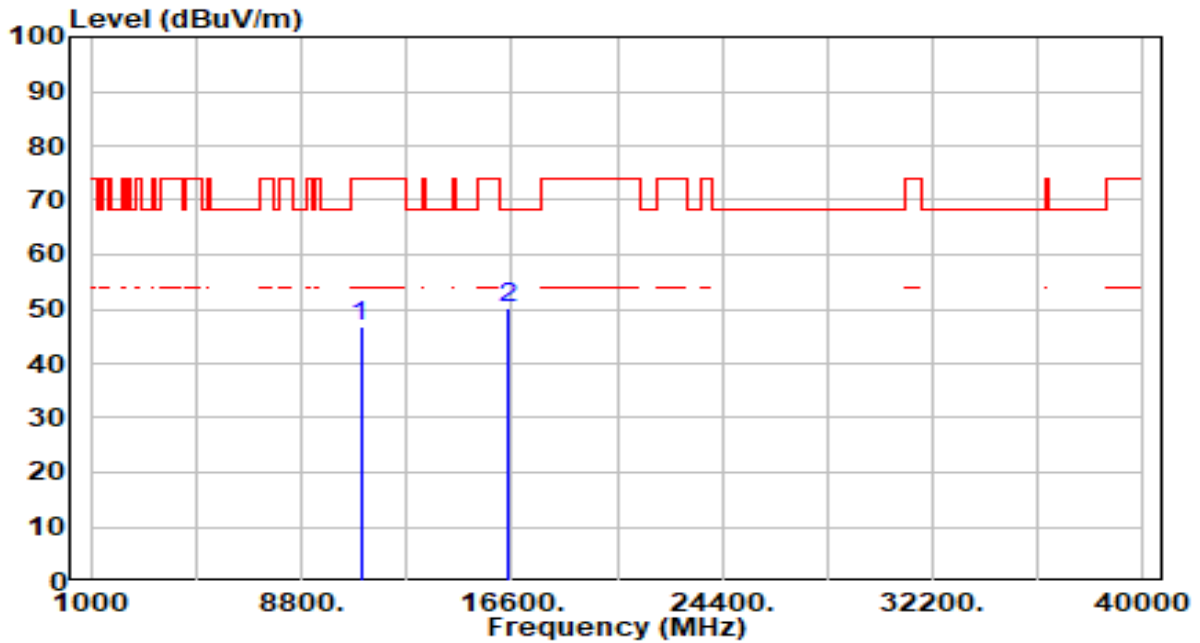

No	Frequency (MHz)	Reading (dBuV)	C.F (dB/m)	Measurement (dBuV/m)	Margin (dB)	Limit (dBuV/m)	Height (cm)	Angle (deg)	Remark (QP/PK/AV)
1	11000.000	42.21	4.52	46.73	-27.27	74.00	100	228	Peak
2	* 16500.000	43.91	6.10	50.01	-18.19	68.20	100	324	Peak

Note:

1. " *", means this data is the worst emission level.
2. C.F (Correction Factor) = Antenna Factor (dB/m)+ Cable Loss (dB) – Pre-amplifier(dB).
3. Measurement (dBuV/m) = Reading(dBuV) + C.F (Correction Factor).
4. The emission levels of other frequencies are very lower than the limit and not show in test report.

EUT	WiFi Module	Date of Test	2024-03-07
Factor	DRH18-E & BBHA 9170	Temp. / Humidity	23°C /61%
Polarity	Vertical	Site / Test Engineer	AC2 / Marvin
Test Mode	802.11ax-20MHz_TX_Band3_CH 100_ANT 0	Test Voltage	By Notebook PC

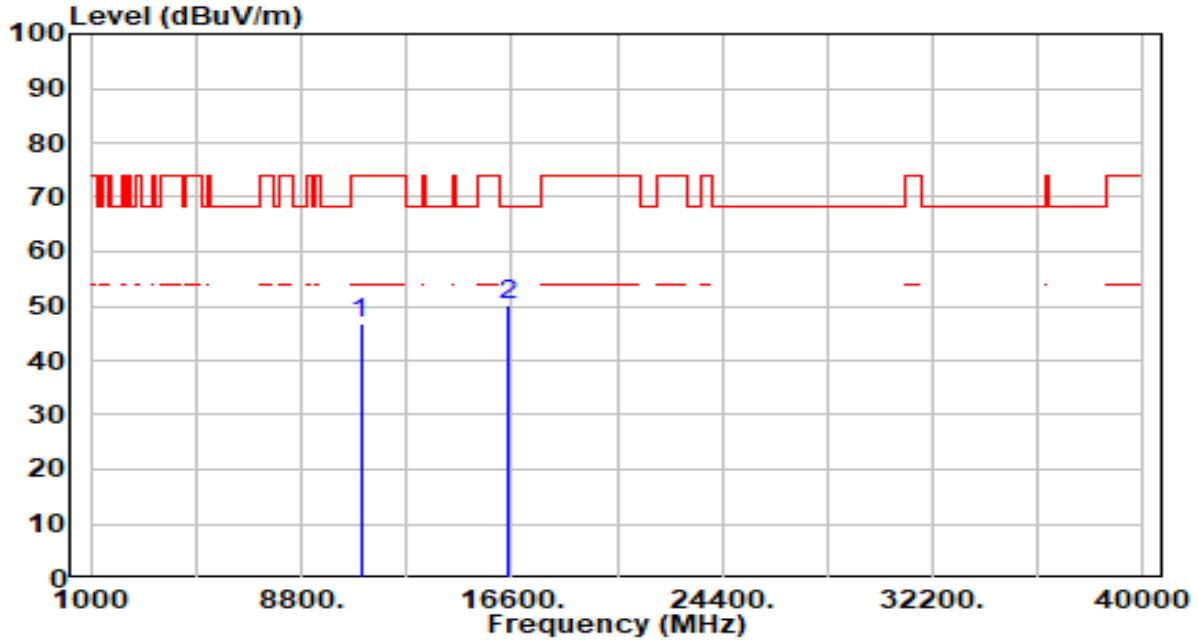

No	Frequency (MHz)	Reading (dBUV)	C.F (dB/m)	Measurement (dBUV/m)	Margin (dB)	Limit (dBUV/m)	Height (cm)	Angle (deg)	Remark (QP/PK/AV)
1	11000.000	42.18	4.52	46.70	-27.30	74.00	100	71	Peak
2	* 16500.000	44.12	6.10	50.22	-17.98	68.20	100	102	Peak

Note:

1. " *", means this data is the worst emission level.
2. C.F (Correction Factor) = Antenna Factor (dB/m)+ Cable Loss (dB) – Preamplifier(dB).
3. Measurement (dBUV/m) = Reading(dBUV) + C.F (Correction Factor).
4. The emission levels of other frequencies are very lower than the limit and not show in test report.

EUT	WiFi Module	Date of Test	2024-03-07
Factor	DRH18-E & BBHA 9170	Temp. / Humidity	23°C /61%
Polarity	Horizontal	Site / Test Engineer	AC2 / Marvin
Test Mode	802.11ax-20MHz_TX_Band3_CH 116_ANT 0	Test Voltage	By Notebook PC

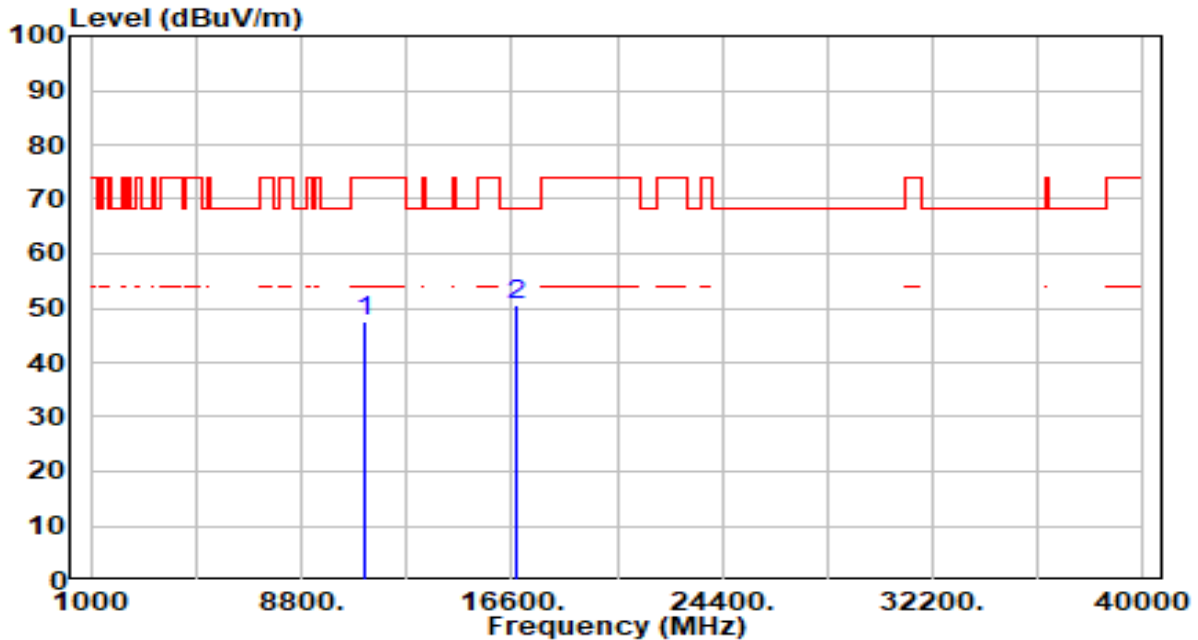

No	Frequency (MHz)	Reading (dBUV)	C.F (dB/m)	Measurement (dBUV/m)	Margin (dB)	Limit (dBUV/m)	Height (cm)	Angle (deg)	Remark (QP/PK/AV)
1	11160.000	42.50	4.94	47.44	-26.56	74.00	100	0	Peak
2	* 16740.000	44.40	6.19	50.59	-17.61	68.20	100	122	Peak

Note:

1. " *", means this data is the worst emission level.
2. C.F (Correction Factor) = Antenna Factor (dB/m)+ Cable Loss (dB) – Preamplifier(dB).
3. Measurement (dBUV/m) = Reading(dBUV) + C.F (Correction Factor).
4. The emission levels of other frequencies are very lower than the limit and not show in test report.

EUT	WiFi Module	Date of Test	2024-03-07
Factor	DRH18-E & BBHA 9170	Temp. / Humidity	23°C /61%
Polarity	Vertical	Site / Test Engineer	AC2 / Marvin
Test Mode	802.11ax-20MHz_TX_Band3_CH 116_ANT 0	Test Voltage	By Notebook PC

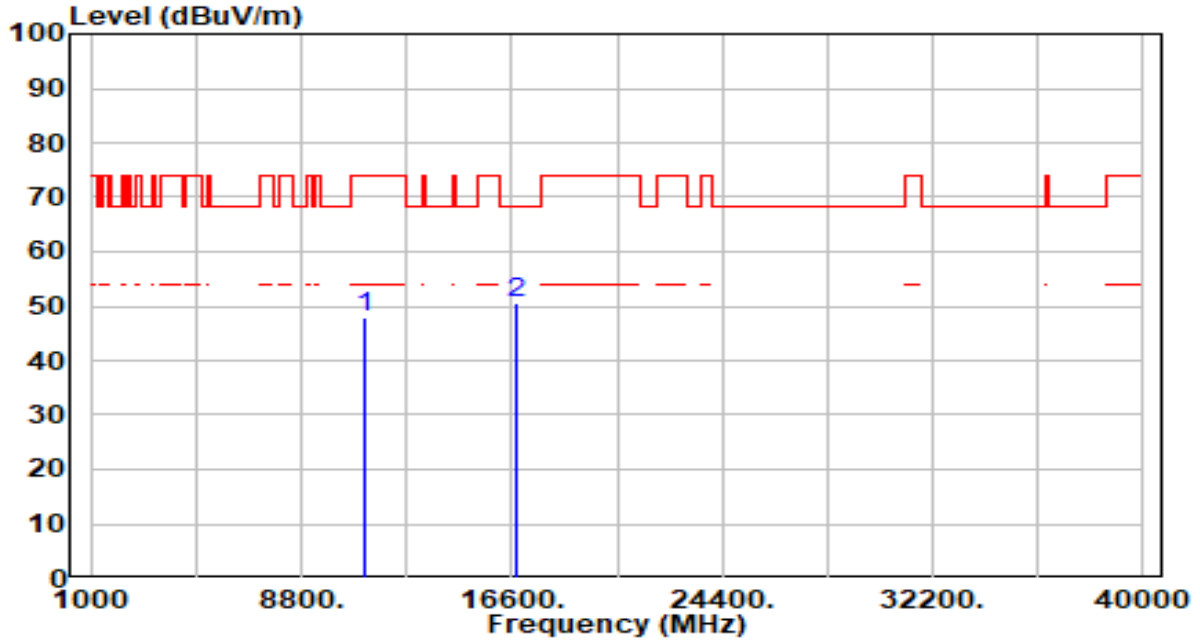

No	Frequency (MHz)	Reading (dBUV)	C.F (dB/m)	Measurement (dBUV/m)	Margin (dB)	Limit (dBUV/m)	Height (cm)	Angle (deg)	Remark (QP/PK/AV)
1	11160.000	42.98	4.94	47.92	-26.08	74.00	100	335	Peak
2	* 16740.000	44.36	6.19	50.55	-17.65	68.20	100	360	Peak

Note:

1. " *", means this data is the worst emission level.
2. C.F (Correction Factor) = Antenna Factor (dB/m)+ Cable Loss (dB) – Preamplifier(dB).
3. Measurement (dBUV/m) = Reading(dBUV) + C.F (Correction Factor).
4. The emission levels of other frequencies are very lower than the limit and not show in test report.

EUT	WiFi Module	Date of Test	2024-03-07
Factor	DRH18-E & BBHA 9170	Temp. / Humidity	23°C /61%
Polarity	Horizontal	Site / Test Engineer	AC2 / Marvin
Test Mode	802.11ax-20MHz_TX_Band3_CH 140_ANT 0	Test Voltage	By Notebook PC

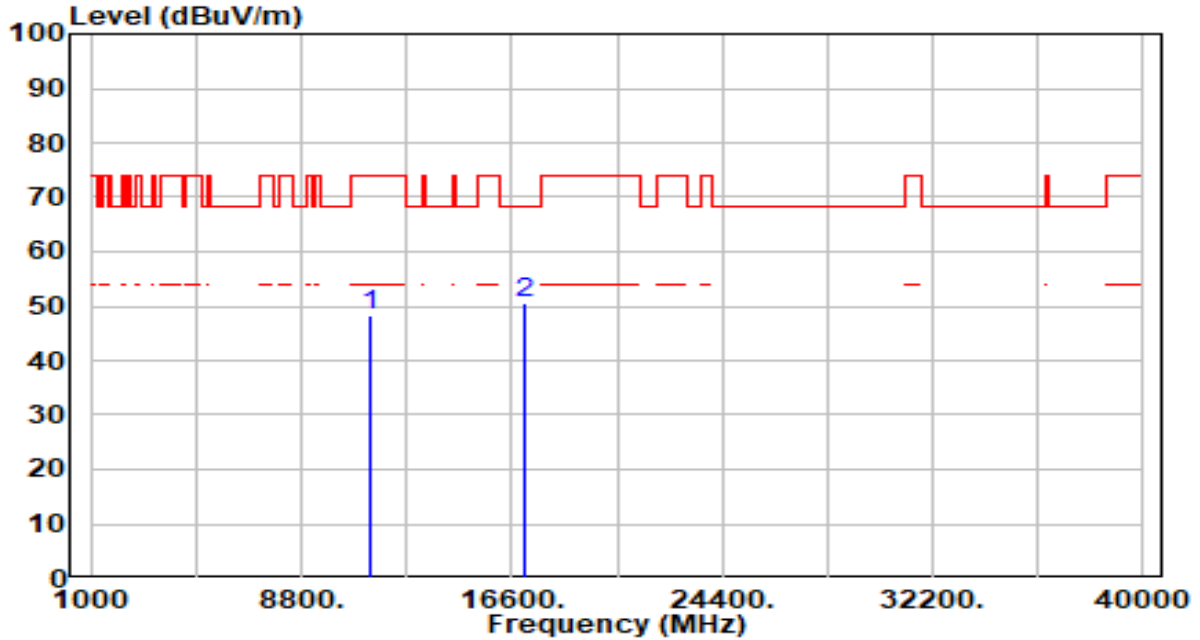

No	Frequency (MHz)	Reading (dBUV)	C.F (dB/m)	Measurement (dBUV/m)	Margin (dB)	Limit (dBUV/m)	Height (cm)	Angle (deg)	Remark (QP/PK/AV)
1	11400.000	42.98	5.26	48.25	-25.75	74.00	100	0	Peak
2	* 17100.000	44.67	5.97	50.65	-17.55	68.20	100	347	Peak

Note:

1. " *", means this data is the worst emission level.
2. C.F (Correction Factor) = Antenna Factor (dB/m)+ Cable Loss (dB) – Preamplifier(dB).
3. Measurement (dBUV/m) = Reading(dBUV) + C.F (Correction Factor).
4. The emission levels of other frequencies are very lower than the limit and not show in test report.

EUT	WiFi Module	Date of Test	2024-03-07
Factor	DRH18-E & BBHA 9170	Temp. / Humidity	23°C /61%
Polarity	Vertical	Site / Test Engineer	AC2 / Marvin
Test Mode	802.11ax-20MHz_TX_Band3_CH 140_ANT 0	Test Voltage	By Notebook PC

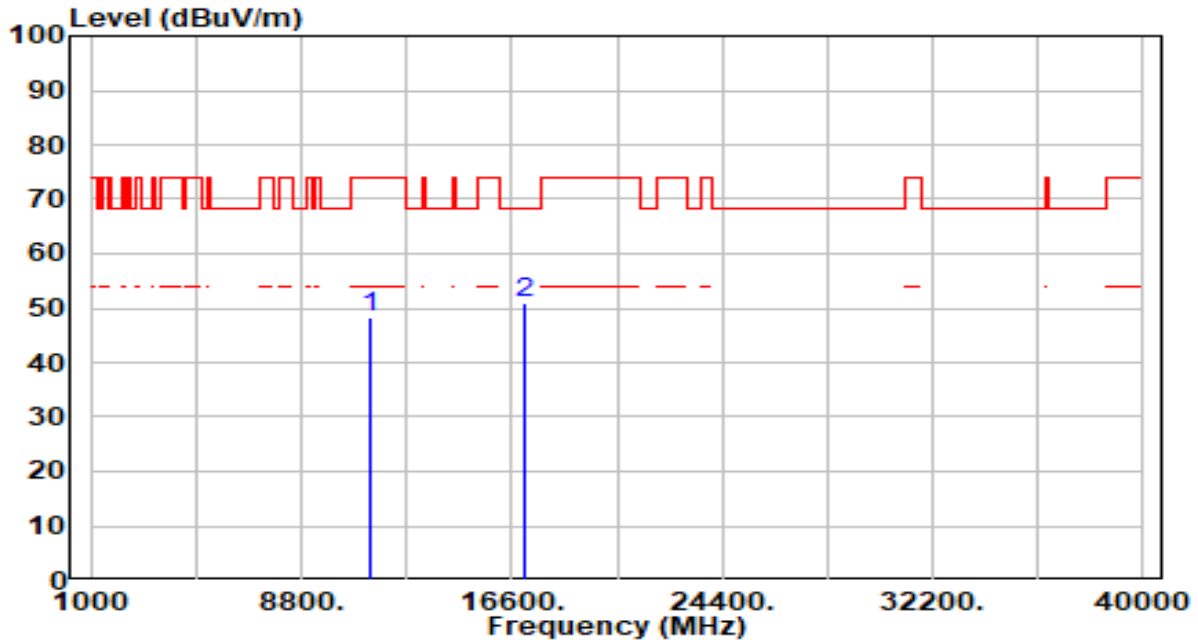

No	Frequency (MHz)	Reading (dBUV)	C.F (dB/m)	Measurement (dBUV/m)	Margin (dB)	Limit (dBUV/m)	Height (cm)	Angle (deg)	Remark (QP/PK/AV)
1	11400.000	42.92	5.26	48.18	-25.82	74.00	100	72	Peak
2	* 17100.000	44.85	5.97	50.82	-17.38	68.20	100	292	Peak

Note:

1. " *", means this data is the worst emission level.
2. C.F (Correction Factor) = Antenna Factor (dB/m)+ Cable Loss (dB) – Preamplifier(dB).
3. Measurement (dBUV/m) = Reading(dBUV) + C.F (Correction Factor).
4. The emission levels of other frequencies are very lower than the limit and not show in test report.

EUT	WiFi Module	Date of Test	2024-03-07
Factor	DRH18-E & BBHA 9170	Temp. / Humidity	23°C /61%
Polarity	Horizontal	Site / Test Engineer	AC2 / Marvin
Test Mode	802.11ax-20MHz_TX_Band3_CH 144_ANT 0	Test Voltage	By Notebook PC

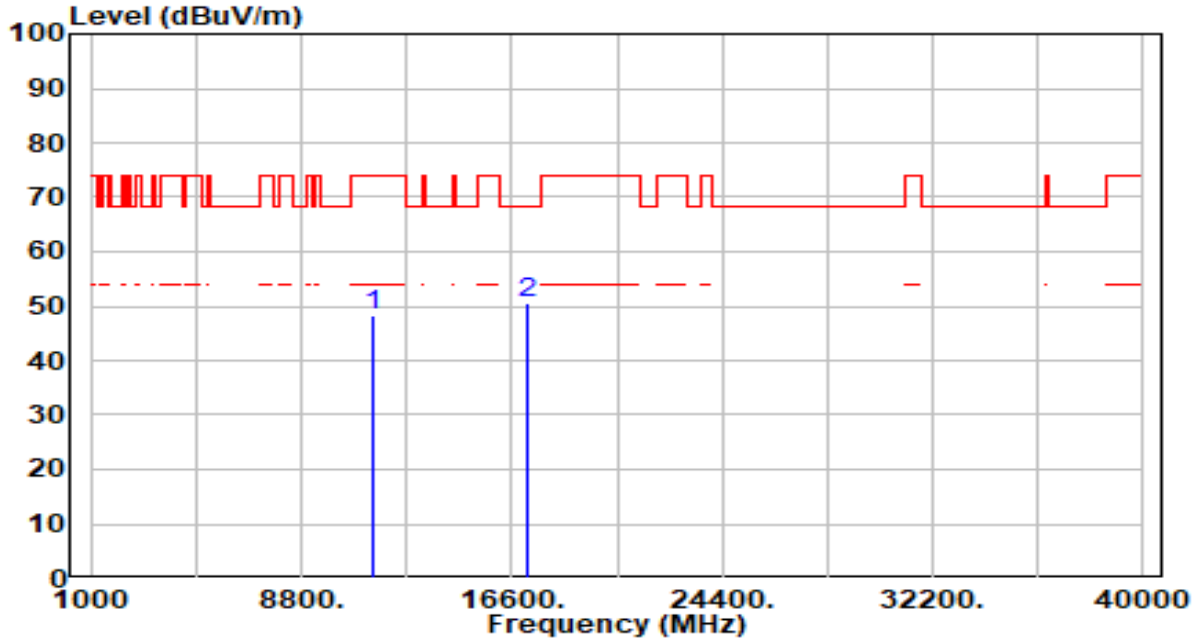

No	Frequency (MHz)	Reading (dBUV)	C.F (dB/m)	Measurement (dBUV/m)	Margin (dB)	Limit (dBUV/m)	Height (cm)	Angle (deg)	Remark (QP/PK/AV)
1	11440.000	42.84	5.29	48.12	-25.88	74.00	100	139	Peak
2	* 17160.000	44.57	5.87	50.44	-17.76	68.20	100	256	Peak

Note:

1. " *", means this data is the worst emission level.
2. C.F (Correction Factor) = Antenna Factor (dB/m)+ Cable Loss (dB) – Preamplifier(dB).
3. Measurement (dBUV/m) = Reading(dBUV) + C.F (Correction Factor).
4. The emission levels of other frequencies are very lower than the limit and not show in test report.

EUT	WiFi Module	Date of Test	2024-03-07
Factor	DRH18-E & BBHA 9170	Temp. / Humidity	23°C /61%
Polarity	Vertical	Site / Test Engineer	AC2 / Marvin
Test Mode	802.11ax-20MHz_TX_Band3_CH 144_ANT 0	Test Voltage	By Notebook PC

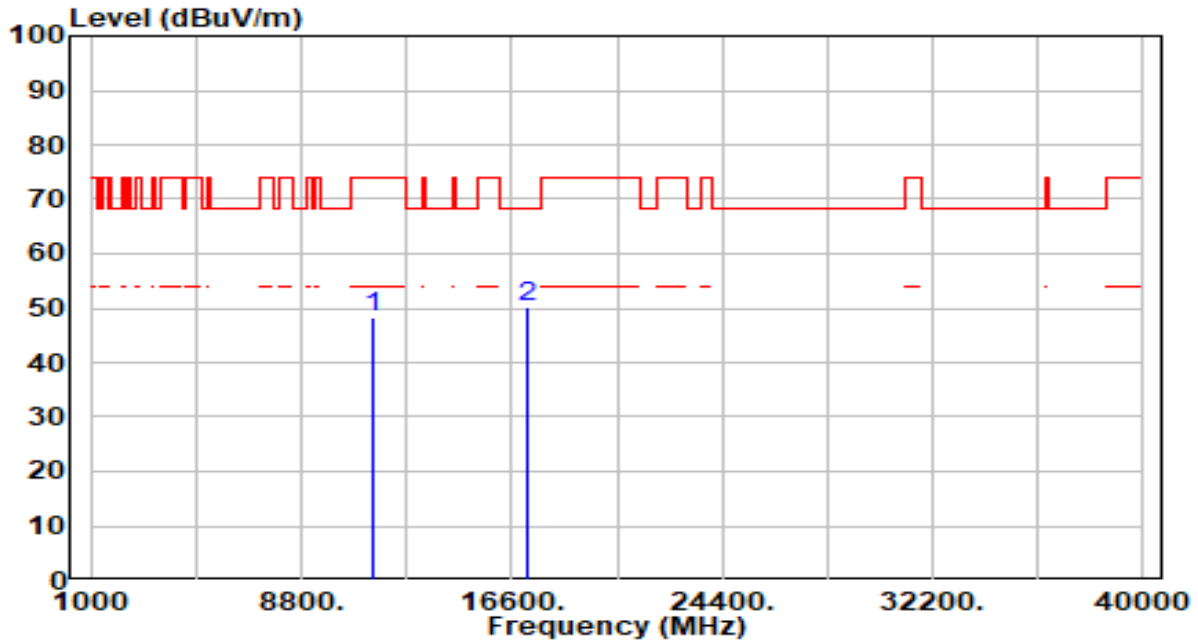

No	Frequency (MHz)	Reading (dBuV)	C.F (dB/m)	Measurement (dBuV/m)	Margin (dB)	Limit (dBuV/m)	Height (cm)	Angle (deg)	Remark (QP/PK/AV)
1	11440.000	42.94	5.29	48.23	-25.77	74.00	100	150	Peak
2	* 17160.000	44.50	5.87	50.37	-17.83	68.20	100	360	Peak

Note:

1. " *", means this data is the worst emission level.
2. C.F (Correction Factor) = Antenna Factor (dB/m)+ Cable Loss (dB) – Preamplifier(dB).
3. Measurement (dBuV/m) = Reading(dBuV) + C.F (Correction Factor).
4. The emission levels of other frequencies are very lower than the limit and not show in test report.

EUT	WiFi Module	Date of Test	2024-03-07
Factor	DRH18-E & BBHA 9170	Temp. / Humidity	23°C /61%
Polarity	Horizontal	Site / Test Engineer	AC2 / Marvin
Test Mode	802.11ax-20MHz_TX_Band4_CH 149_ANT 0	Test Voltage	By Notebook PC

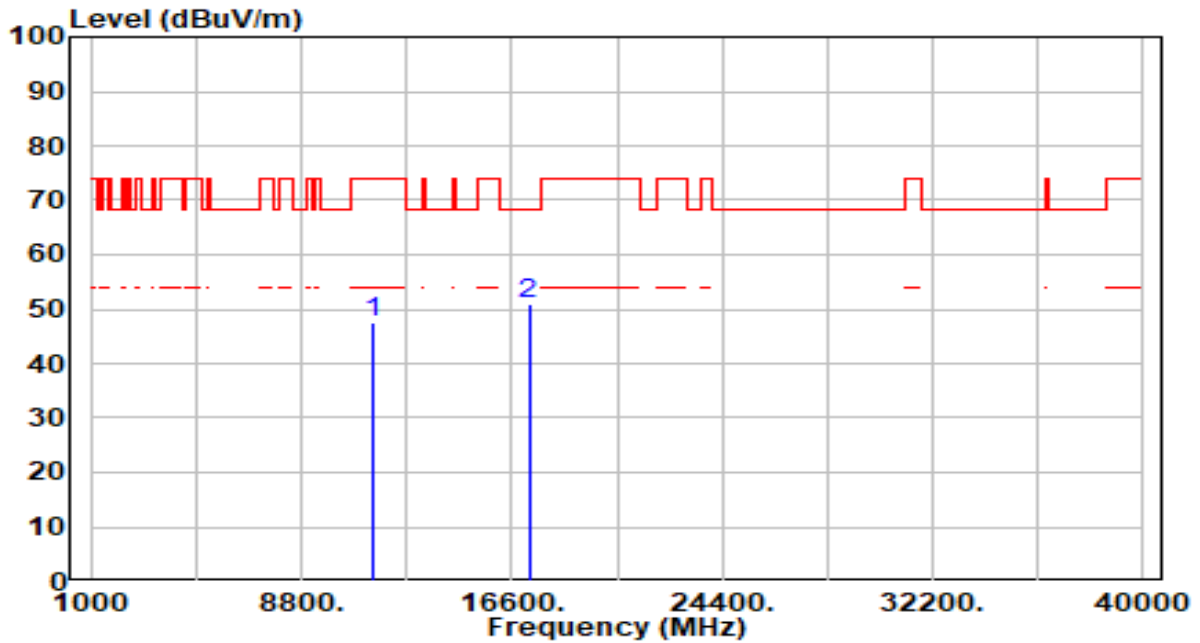

No	Frequency (MHz)	Reading (dBuV)	C.F (dB/m)	Measurement (dBuV/m)	Margin (dB)	Limit (dBuV/m)	Height (cm)	Angle (deg)	Remark (QP/PK/AV)
1	11490.000	42.36	5.32	47.68	-26.32	74.00	100	323	Peak
2	* 17235.000	45.16	5.71	50.87	-17.33	68.20	100	189	Peak

Note:

1. " *", means this data is the worst emission level.
2. C.F (Correction Factor) = Antenna Factor (dB/m)+ Cable Loss (dB) – Pre-amplifier(dB).
3. Measurement (dBuV/m) = Reading(dBuV) + C.F (Correction Factor).
4. The emission levels of other frequencies are very lower than the limit and not show in test report.

EUT	WiFi Module	Date of Test	2024-03-07
Factor	DRH18-E & BBHA 9170	Temp. / Humidity	23°C /61%
Polarity	Vertical	Site / Test Engineer	AC2 / Marvin
Test Mode	802.11ax-20MHz_TX_Band4_CH 149_ANT 0	Test Voltage	By Notebook PC

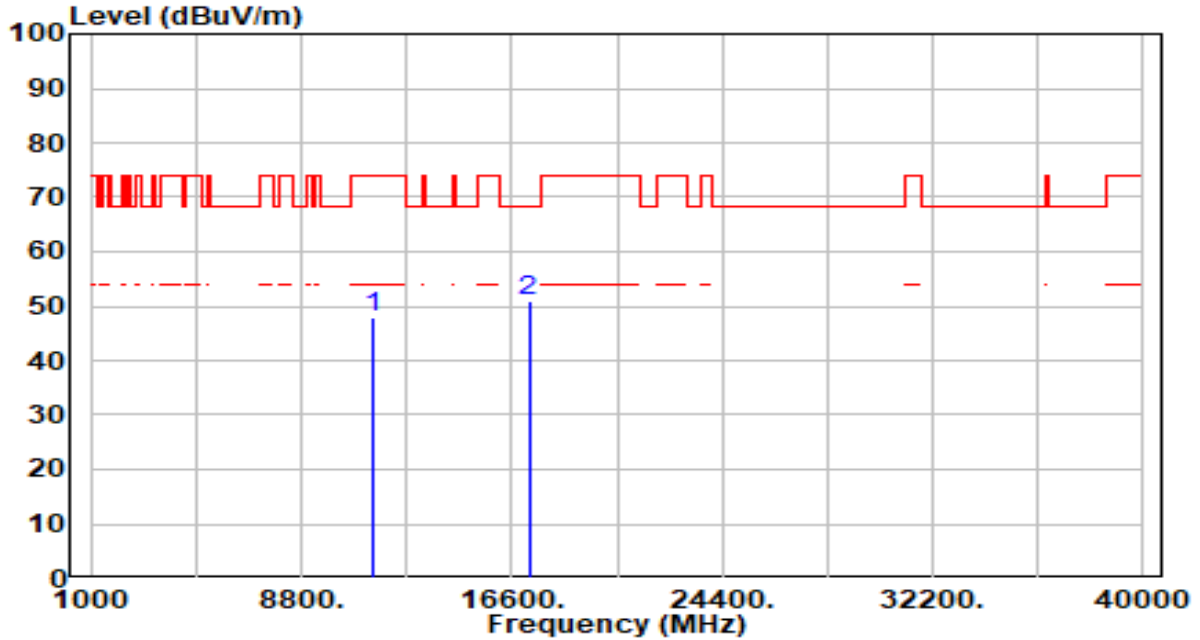

No	Frequency (MHz)	Reading (dBUV)	C.F (dB/m)	Measurement (dBUV/m)	Margin (dB)	Limit (dBUV/m)	Height (cm)	Angle (deg)	Remark (QP/PK/AV)
1	11490.000	42.63	5.32	47.95	-26.05	74.00	100	70	Peak
2	* 17235.000	45.27	5.71	50.98	-17.22	68.20	100	213	Peak

Note:

1. " *", means this data is the worst emission level.
2. C.F (Correction Factor) = Antenna Factor (dB/m)+ Cable Loss (dB) – Preamplifier(dB).
3. Measurement (dBUV/m) = Reading(dBUV) + C.F (Correction Factor).
4. The emission levels of other frequencies are very lower than the limit and not show in test report.

EUT	WiFi Module	Date of Test	2024-03-07
Factor	DRH18-E & BBHA 9170	Temp. / Humidity	23°C /61%
Polarity	Horizontal	Site / Test Engineer	AC2 / Marvin
Test Mode	802.11ax-20MHz_TX_Band4_CH 157_ANT 0	Test Voltage	By Notebook PC

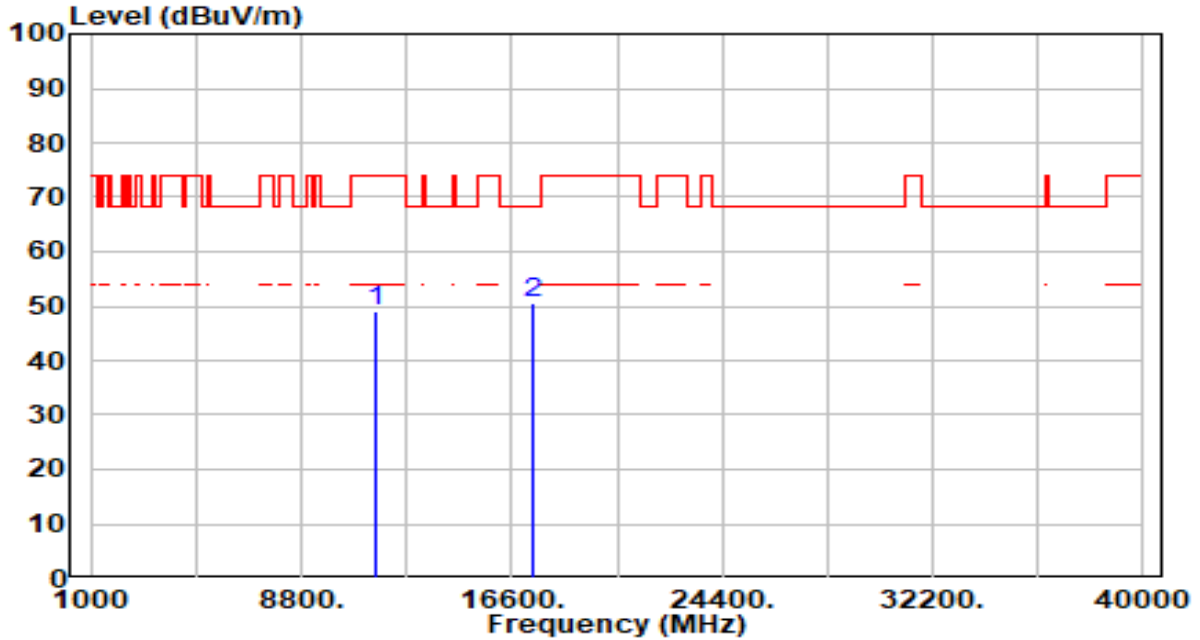

No	Frequency (MHz)	Reading (dBUV)	C.F (dB/m)	Measurement (dBUV/m)	Margin (dB)	Limit (dBUV/m)	Height (cm)	Angle (deg)	Remark (QP/PK/AV)
1	11570.000	43.56	5.38	48.94	-25.06	74.00	100	337	Peak
2	* 17355.000	45.06	5.39	50.45	-17.75	68.20	100	252	Peak

Note:

1. " *", means this data is the worst emission level.
2. C.F (Correction Factor) = Antenna Factor (dB/m)+ Cable Loss (dB) – Preamplifier(dB).
3. Measurement (dBUV/m) = Reading(dBUV) + C.F (Correction Factor).
4. The emission levels of other frequencies are very lower than the limit and not show in test report.

EUT	WiFi Module	Date of Test	2024-03-07
Factor	DRH18-E & BBHA 9170	Temp. / Humidity	23°C /61%
Polarity	Vertical	Site / Test Engineer	AC2 / Marvin
Test Mode	802.11ax-20MHz_TX_Band4_CH 157_ANT 0	Test Voltage	By Notebook PC

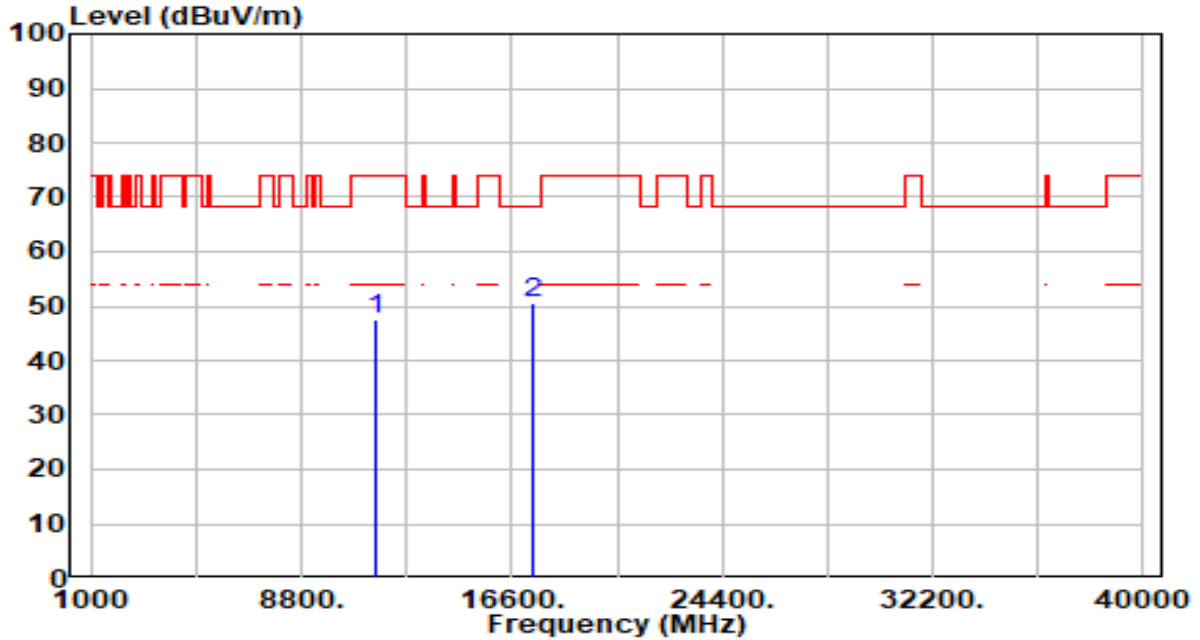

No	Frequency (MHz)	Reading (dBUV)	C.F (dB/m)	Measurement (dBUV/m)	Margin (dB)	Limit (dBUV/m)	Height (cm)	Angle (deg)	Remark (QP/PK/AV)
1	11570.000	42.08	5.38	47.46	-26.54	74.00	100	112	Peak
2	* 17355.000	45.23	5.39	50.62	-17.58	68.20	100	352	Peak

Note:

1. " *", means this data is the worst emission level.
2. C.F (Correction Factor) = Antenna Factor (dB/m)+ Cable Loss (dB) – Preamplifier(dB).
3. Measurement (dBUV/m) = Reading(dBUV) + C.F (Correction Factor).
4. The emission levels of other frequencies are very lower than the limit and not show in test report.

EUT	WiFi Module	Date of Test	2024-03-07
Factor	DRH18-E & BBHA 9170	Temp. / Humidity	23°C /61%
Polarity	Horizontal	Site / Test Engineer	AC2 / Marvin
Test Mode	802.11ax-20MHz_TX_Band4_CH 165_ANT 0	Test Voltage	By Notebook PC

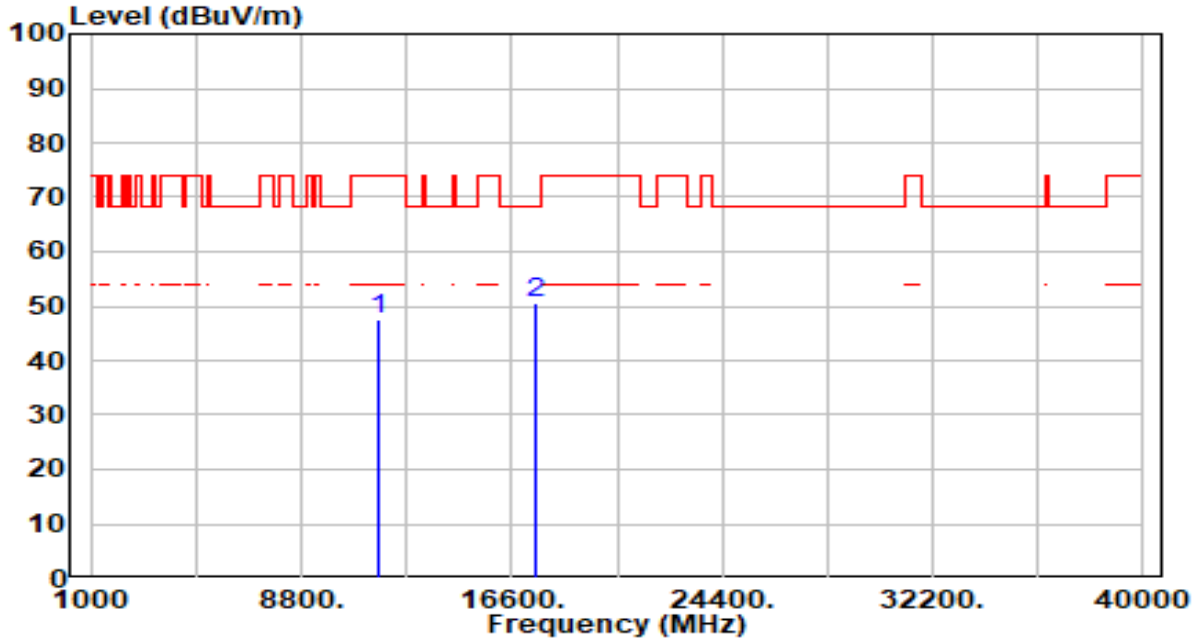

No	Frequency (MHz)	Reading (dBUV)	C.F (dB/m)	Measurement (dBUV/m)	Margin (dB)	Limit (dBUV/m)	Height (cm)	Angle (deg)	Remark (QP/PK/AV)
1	11650.000	42.24	5.36	47.61	-26.39	74.00	100	340	Peak
2	* 17475.000	45.40	5.29	50.69	-17.51	68.20	100	359	Peak

Note:

1. " *", means this data is the worst emission level.
2. C.F (Correction Factor) = Antenna Factor (dB/m)+ Cable Loss (dB) – Preamplifier(dB).
3. Measurement (dBUV/m) = Reading(dBUV) + C.F (Correction Factor).
4. The emission levels of other frequencies are very lower than the limit and not show in test report.

EUT	WiFi Module	Date of Test	2024-03-07
Factor	DRH18-E & BBHA 9170	Temp. / Humidity	23°C /61%
Polarity	Vertical	Site / Test Engineer	AC2 / Marvin
Test Mode	802.11ax-20MHz_TX_Band4_CH 165_ANT 0	Test Voltage	By Notebook PC

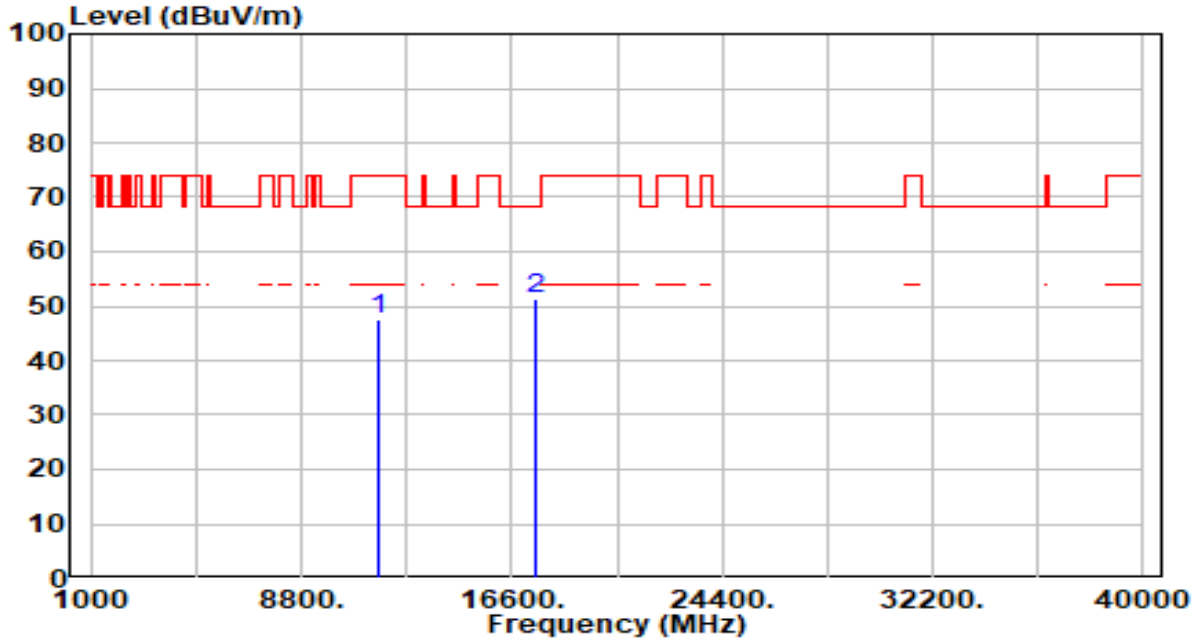

No	Frequency (MHz)	Reading (dBUV)	C.F (dB/m)	Measurement (dBUV/m)	Margin (dB)	Limit (dBUV/m)	Height (cm)	Angle (deg)	Remark (QP/PK/AV)
1	11650.000	42.16	5.36	47.53	-26.47	74.00	100	187	Peak
2	* 17475.000	46.21	5.29	51.50	-16.70	68.20	100	360	Peak

Note:

1. " *", means this data is the worst emission level.
2. C.F (Correction Factor) = Antenna Factor (dB/m)+ Cable Loss (dB) – Preamplifier(dB).
3. Measurement (dBUV/m) = Reading(dBUV) + C.F (Correction Factor).
4. The emission levels of other frequencies are very lower than the limit and not show in test report.

EUT	WiFi Module	Date of Test	2024-03-07
Factor	DRH18-E & BBHA 9170	Temp. / Humidity	23°C /61%
Polarity	Horizontal	Site / Test Engineer	AC2 / Marvin
Test Mode	802.11ax-40MHz_TX_Band1_CH 38_ANT 0	Test Voltage	By Notebook PC

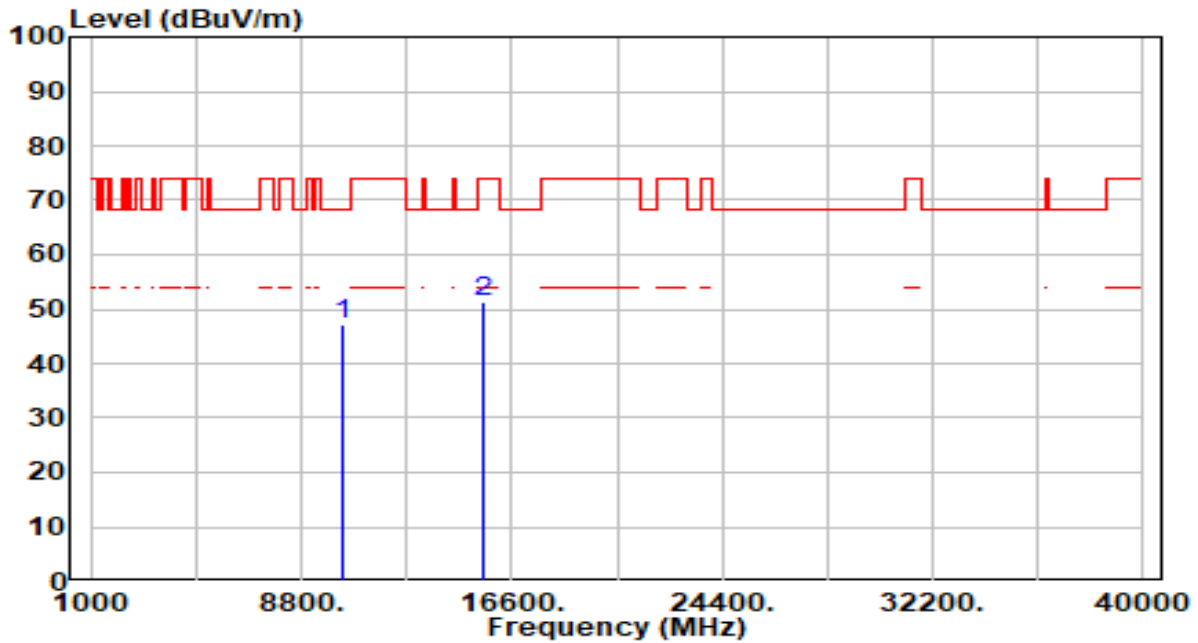

No	Frequency (MHz)	Reading (dBuV)	C.F (dB/m)	Measurement (dBuV/m)	Margin (dB)	Limit (dBuV/m)	Height (cm)	Angle (deg)	Remark (QP/PK/AV)
1	* 10380.000	42.39	4.84	47.23	-20.97	68.20	100	25	Peak
2	15570.000	45.22	6.18	51.40	-22.60	74.00	100	332	Peak

Note:

1. " *", means this data is the worst emission level.
2. C.F (Correction Factor) = Antenna Factor (dB/m)+ Cable Loss (dB) – Pre-amplifier(dB).
3. Measurement (dBuV/m) = Reading(dBuV) + C.F (Correction Factor).
4. The emission levels of other frequencies are very lower than the limit and not show in test report.

EUT	WiFi Module	Date of Test	2024-03-07
Factor	DRH18-E & BBHA 9170	Temp. / Humidity	23°C /61%
Polarity	Vertical	Site / Test Engineer	AC2 / Marvin
Test Mode	802.11ax-40MHz_TX_Band1_CH 38_ANT 0	Test Voltage	By Notebook PC

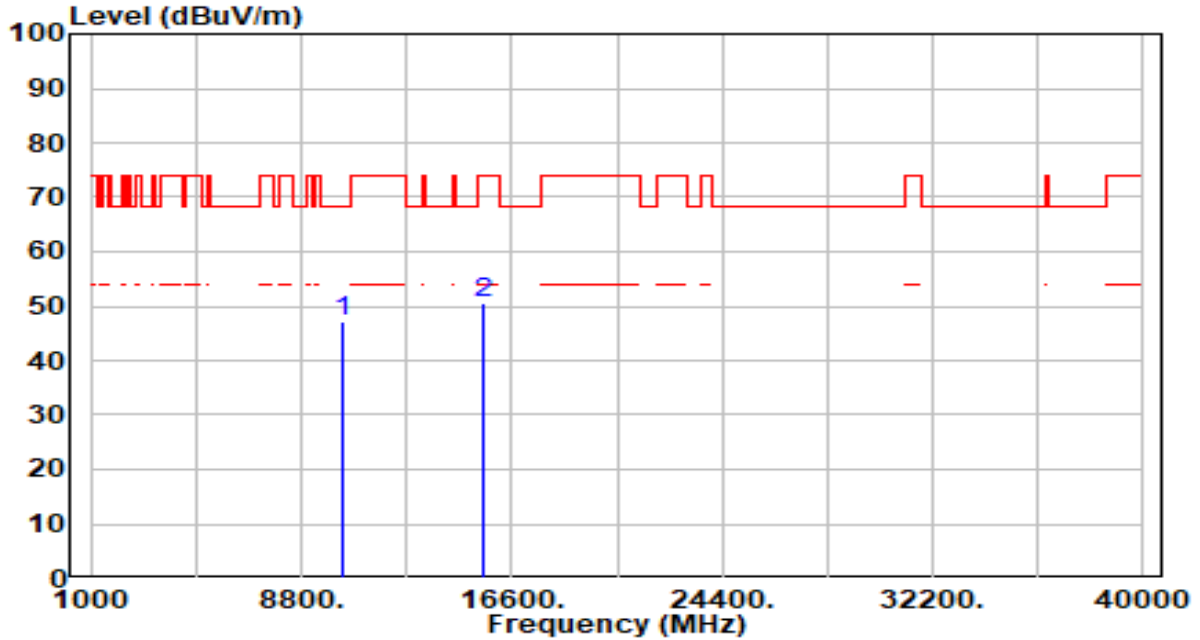

No	Frequency (MHz)	Reading (dBUV)	C.F (dB/m)	Measurement (dBUV/m)	Margin (dB)	Limit (dBUV/m)	Height (cm)	Angle (deg)	Remark (QP/PK/AV)
1	* 10380.000	42.17	4.84	47.02	-21.18	68.20	100	349	Peak
2	15570.000	44.41	6.18	50.58	-23.42	74.00	100	360	Peak

Note:

1. " *", means this data is the worst emission level.
2. C.F (Correction Factor) = Antenna Factor (dB/m)+ Cable Loss (dB) – Preamplifier(dB).
3. Measurement (dBUV/m) = Reading(dBUV) + C.F (Correction Factor).
4. The emission levels of other frequencies are very lower than the limit and not show in test report.

EUT	WiFi Module	Date of Test	2024-03-07
Factor	DRH18-E & BBHA 9170	Temp. / Humidity	23°C /61%
Polarity	Horizontal	Site / Test Engineer	AC2 / Marvin
Test Mode	802.11ax-40MHz_TX_Band1_CH 46_ANT 0	Test Voltage	By Notebook PC

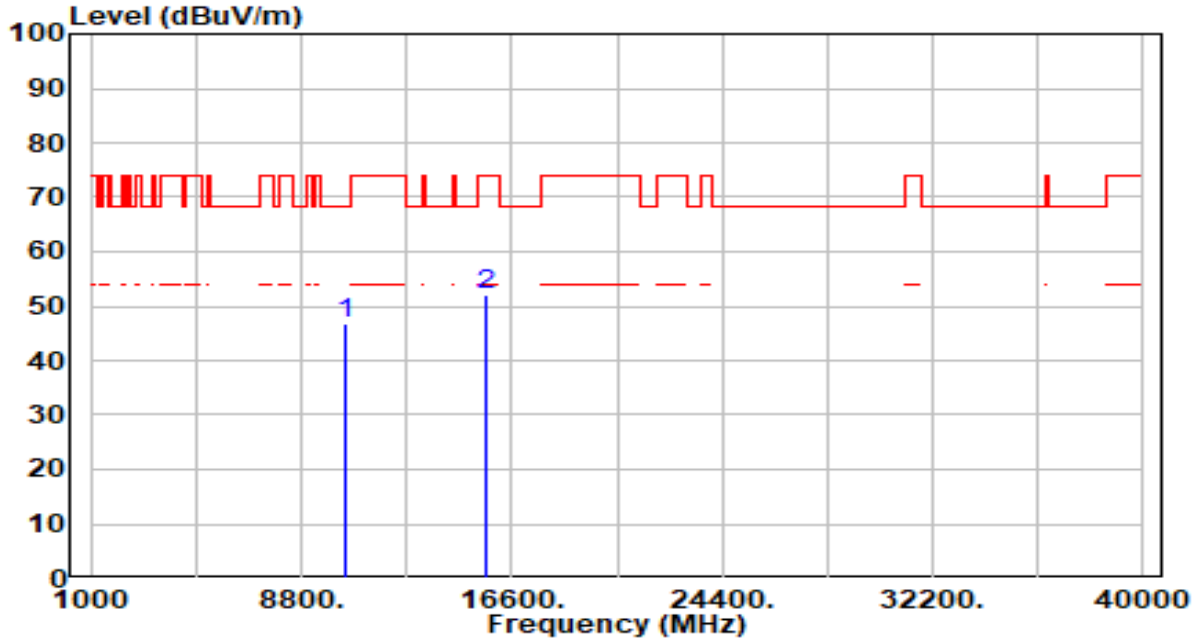

No	Frequency (MHz)	Reading (dBuV)	C.F (dB/m)	Measurement (dBuV/m)	Margin (dB)	Limit (dBuV/m)	Height (cm)	Angle (deg)	Remark (QP/PK/AV)	
1	*	10460.000	41.95	4.74	46.68	-21.52	68.20	100	131	Peak
2		15690.000	45.65	6.33	51.98	-22.02	74.00	100	330	Peak

Note:

1. "*" , means this data is the worst emission level.
2. C.F (Correction Factor) = Antenna Factor (dB/m)+ Cable Loss (dB) – Preamplifier(dB).
3. Measurement (dBuV/m) = Reading(dBuV) + C.F (Correction Factor).
4. The emission levels of other frequencies are very lower than the limit and not show in test report.

EUT	WiFi Module	Date of Test	2024-03-07
Factor	DRH18-E & BBHA 9170	Temp. / Humidity	23°C /61%
Polarity	Vertical	Site / Test Engineer	AC2 / Marvin
Test Mode	802.11ax-40MHz_TX_Band1_CH 46_ANT 0	Test Voltage	By Notebook PC

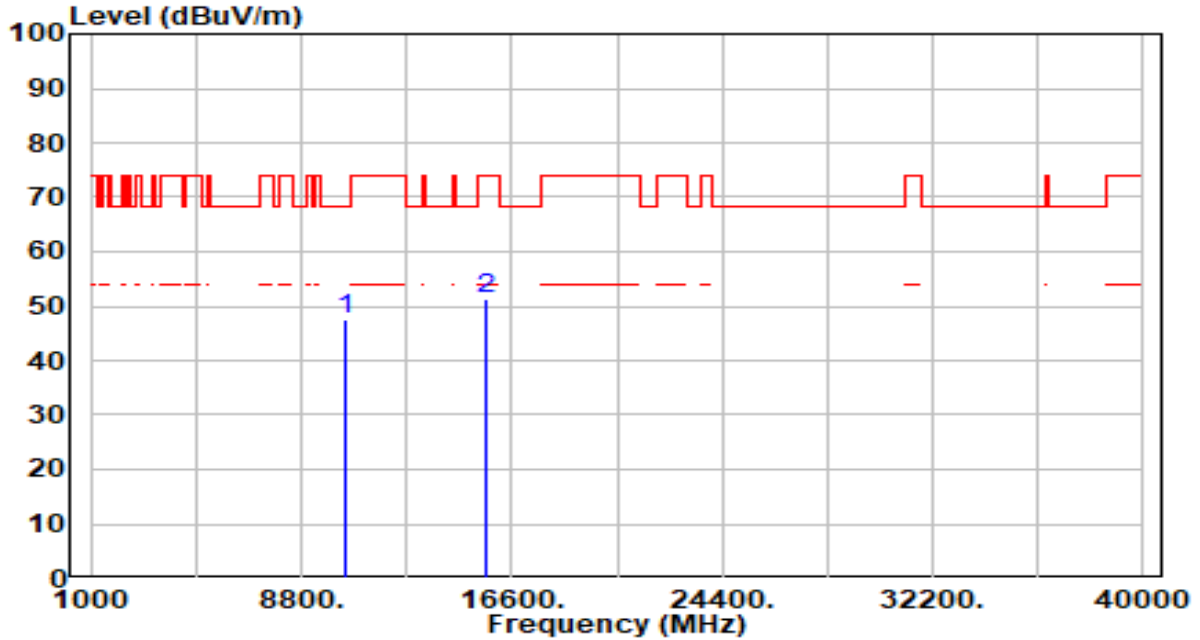

No	Frequency (MHz)	Reading (dBuV)	C.F (dB/m)	Measurement (dBuV/m)	Margin (dB)	Limit (dBuV/m)	Height (cm)	Angle (deg)	Remark (QP/PK/AV)
1	* 10460.000	42.65	4.74	47.39	-20.81	68.20	100	8	Peak
2	15690.000	45.18	6.33	51.51	-22.49	74.00	100	284	Peak

Note:

1. " *", means this data is the worst emission level.
2. C.F (Correction Factor) = Antenna Factor (dB/m)+ Cable Loss (dB) – Preamplifier(dB).
3. Measurement (dBuV/m) = Reading(dBuV) + C.F (Correction Factor).
4. The emission levels of other frequencies are very lower than the limit and not show in test report.

EUT	WiFi Module	Date of Test	2024-03-07
Factor	DRH18-E & BBHA 9170	Temp. / Humidity	23°C /61%
Polarity	Horizontal	Site / Test Engineer	AC2 / Marvin
Test Mode	802.11ax-40MHz_TX_Band2_CH 54_ANT 0	Test Voltage	By Notebook PC

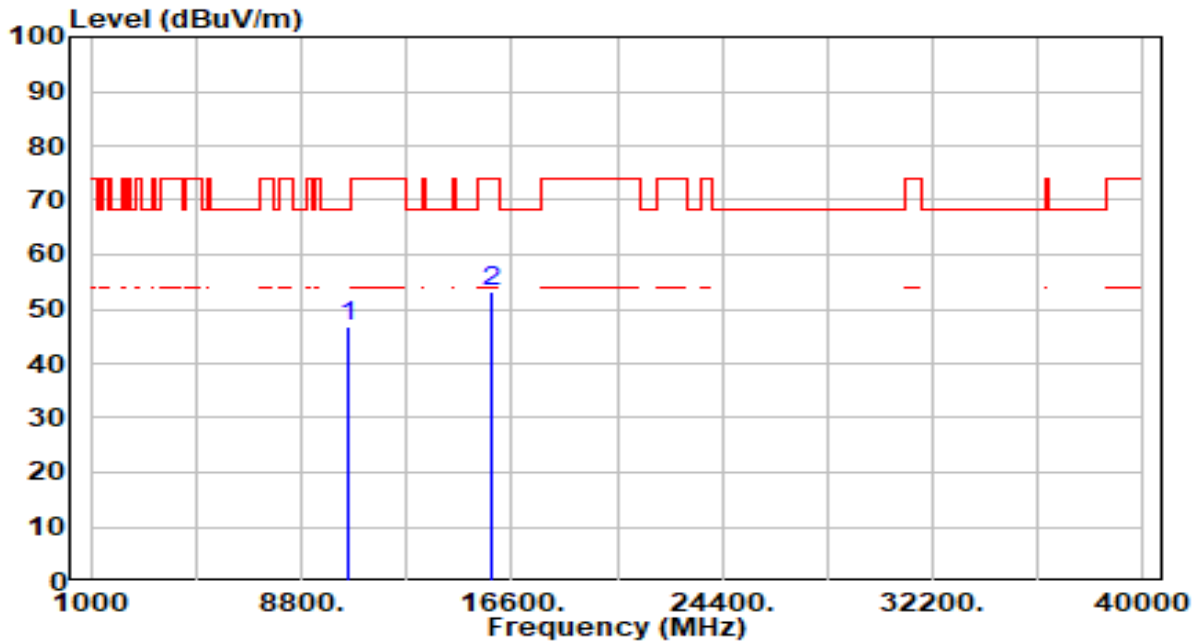

No	Frequency (MHz)	Reading (dBuV)	C.F (dB/m)	Measurement (dBuV/m)	Margin (dB)	Limit (dBuV/m)	Height (cm)	Angle (deg)	Remark (QP/PK/AV)
1	10540.000	42.20	4.66	46.86	-21.34	68.20	100	278	Peak
2	* 15810.000	46.67	6.55	53.22	-20.78	74.00	100	70	Peak

Note:

1. " *", means this data is the worst emission level.
2. C.F (Correction Factor) = Antenna Factor (dB/m)+ Cable Loss (dB) – Pre-amplifier(dB).
3. Measurement (dBuV/m) = Reading(dBuV) + C.F (Correction Factor).
4. The emission levels of other frequencies are very lower than the limit and not show in test report.

EUT	WiFi Module	Date of Test	2024-03-07
Factor	DRH18-E & BBHA 9170	Temp. / Humidity	23°C /61%
Polarity	Vertical	Site / Test Engineer	AC2 / Marvin
Test Mode	802.11ax-40MHz_TX_Band2_CH 54_ANT 0	Test Voltage	By Notebook PC

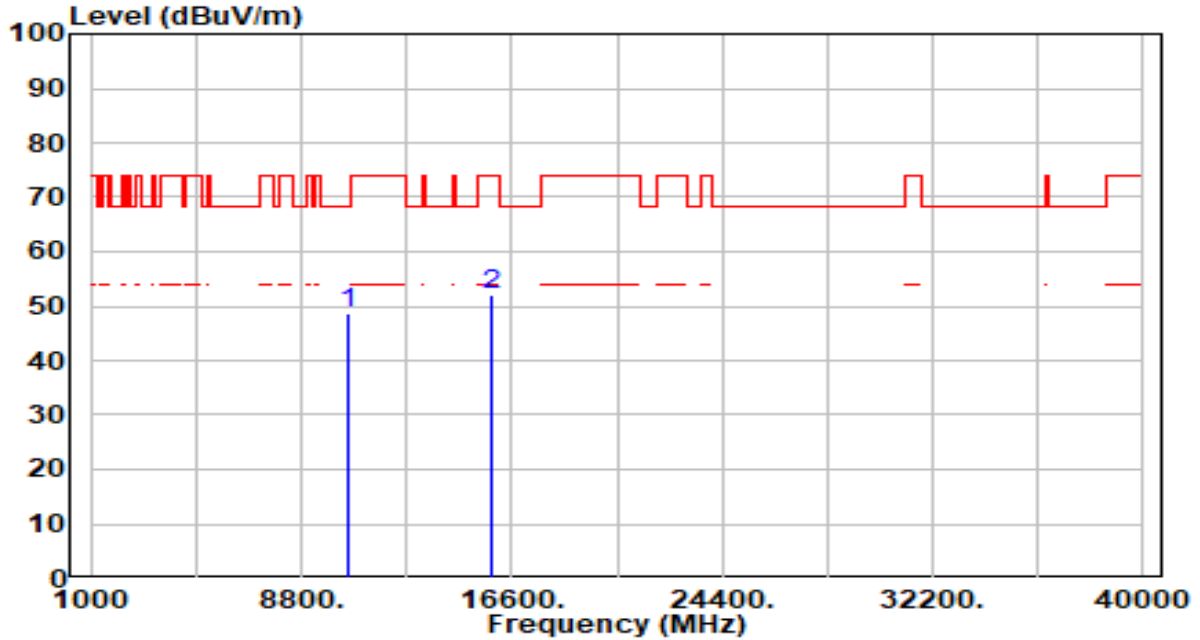

No	Frequency (MHz)	Reading (dBuV)	C.F (dB/m)	Measurement (dBuV/m)	Margin (dB)	Limit (dBuV/m)	Height (cm)	Angle (deg)	Remark (QP/PK/AV)
1	* 10540.000	43.92	4.66	48.57	-19.63	68.20	100	213	Peak
2	15810.000	45.71	6.55	52.26	-21.74	74.00	100	247	Peak

Note:

1. " *", means this data is the worst emission level.
2. C.F (Correction Factor) = Antenna Factor (dB/m)+ Cable Loss (dB) – Preamplifier(dB).
3. Measurement (dBuV/m) = Reading(dBuV) + C.F (Correction Factor).
4. The emission levels of other frequencies are very lower than the limit and not show in test report.

EUT	WiFi Module	Date of Test	2024-03-07
Factor	DRH18-E & BBHA 9170	Temp. / Humidity	23°C /61%
Polarity	Horizontal	Site / Test Engineer	AC2 / Marvin
Test Mode	802.11ax-40MHz_TX_Band2_CH 62_ANT 0	Test Voltage	By Notebook PC

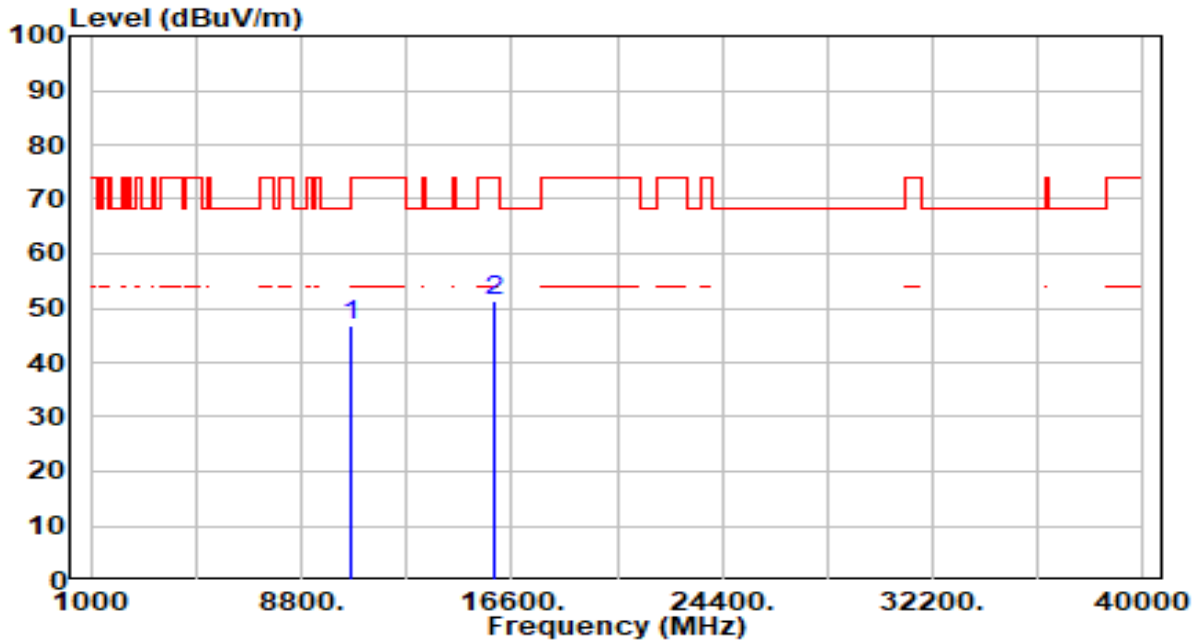

No	Frequency (MHz)	Reading (dBUV)	C.F (dB/m)	Measurement (dBUV/m)	Margin (dB)	Limit (dBUV/m)	Height (cm)	Angle (deg)	Remark (QP/PK/AV)
1	10620.000	42.36	4.62	46.98	-27.02	74.00	100	290	Peak
2	* 15930.000	44.94	6.55	51.49	-22.51	74.00	100	179	Peak

Note:

1. " *", means this data is the worst emission level.
2. C.F (Correction Factor) = Antenna Factor (dB/m)+ Cable Loss (dB) – Preamplifier(dB).
3. Measurement (dBUV/m) = Reading(dBUV) + C.F (Correction Factor).
4. The emission levels of other frequencies are very lower than the limit and not show in test report.

EUT	WiFi Module	Date of Test	2024-03-07
Factor	DRH18-E & BBHA 9170	Temp. / Humidity	23°C /61%
Polarity	Vertical	Site / Test Engineer	AC2 / Marvin
Test Mode	802.11ax-40MHz_TX_Band2_CH 62_ANT 0	Test Voltage	By Notebook PC

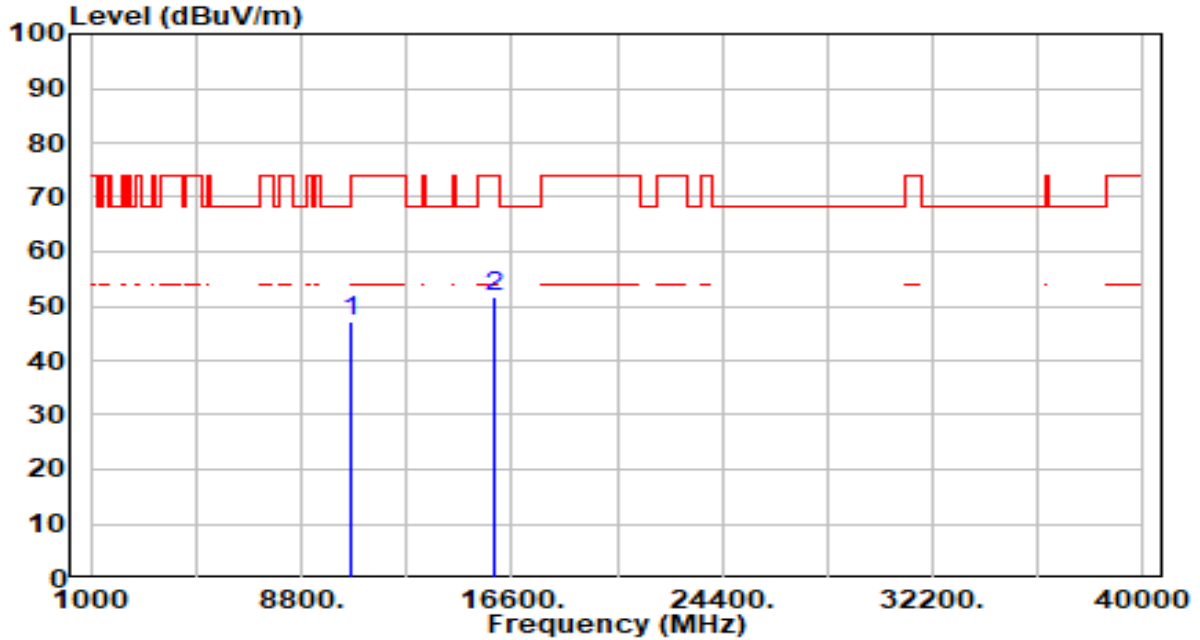

No	Frequency (MHz)	Reading (dBUV)	C.F (dB/m)	Measurement (dBUV/m)	Margin (dB)	Limit (dBUV/m)	Height (cm)	Angle (deg)	Remark (QP/PK/AV)
1	10620.000	42.73	4.62	47.35	-26.65	74.00	100	18	Peak
2	* 15930.000	45.32	6.55	51.87	-22.13	74.00	100	38	Peak

Note:

1. " *", means this data is the worst emission level.
2. C.F (Correction Factor) = Antenna Factor (dB/m)+ Cable Loss (dB) – Preamplifier(dB).
3. Measurement (dBUV/m) = Reading(dBUV) + C.F (Correction Factor).
4. The emission levels of other frequencies are very lower than the limit and not show in test report.

EUT	WiFi Module	Date of Test	2024-03-07
Factor	DRH18-E & BBHA 9170	Temp. / Humidity	23°C /61%
Polarity	Horizontal	Site / Test Engineer	AC2 / Marvin
Test Mode	802.11ax-40MHz_TX_Band3_CH 102_ANT 0	Test Voltage	By Notebook PC

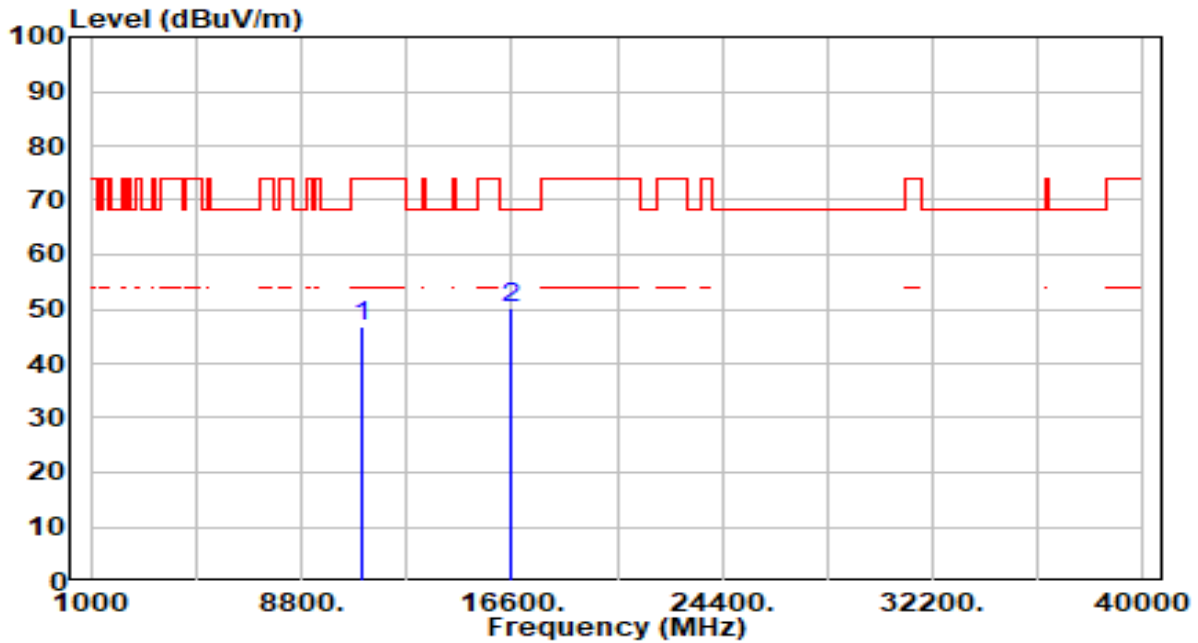

No	Frequency (MHz)	Reading (dBuV)	C.F (dB/m)	Measurement (dBuV/m)	Margin (dB)	Limit (dBuV/m)	Height (cm)	Angle (deg)	Remark (QP/PK/AV)
1	11020.000	42.18	4.57	46.75	-27.25	74.00	100	214	Peak
2	* 16530.000	44.24	6.10	50.34	-17.86	68.20	100	316	Peak

Note:

1. " *", means this data is the worst emission level.
2. C.F (Correction Factor) = Antenna Factor (dB/m)+ Cable Loss (dB) – Pre-amplifier(dB).
3. Measurement (dBuV/m) = Reading(dBuV) + C.F (Correction Factor).
4. The emission levels of other frequencies are very lower than the limit and not show in test report.

EUT	WiFi Module	Date of Test	2024-03-07
Factor	DRH18-E & BBHA 9170	Temp. / Humidity	23°C /61%
Polarity	Vertical	Site / Test Engineer	AC2 / Marvin
Test Mode	802.11ax-40MHz_TX_Band3_CH 102_ANT 0	Test Voltage	By Notebook PC

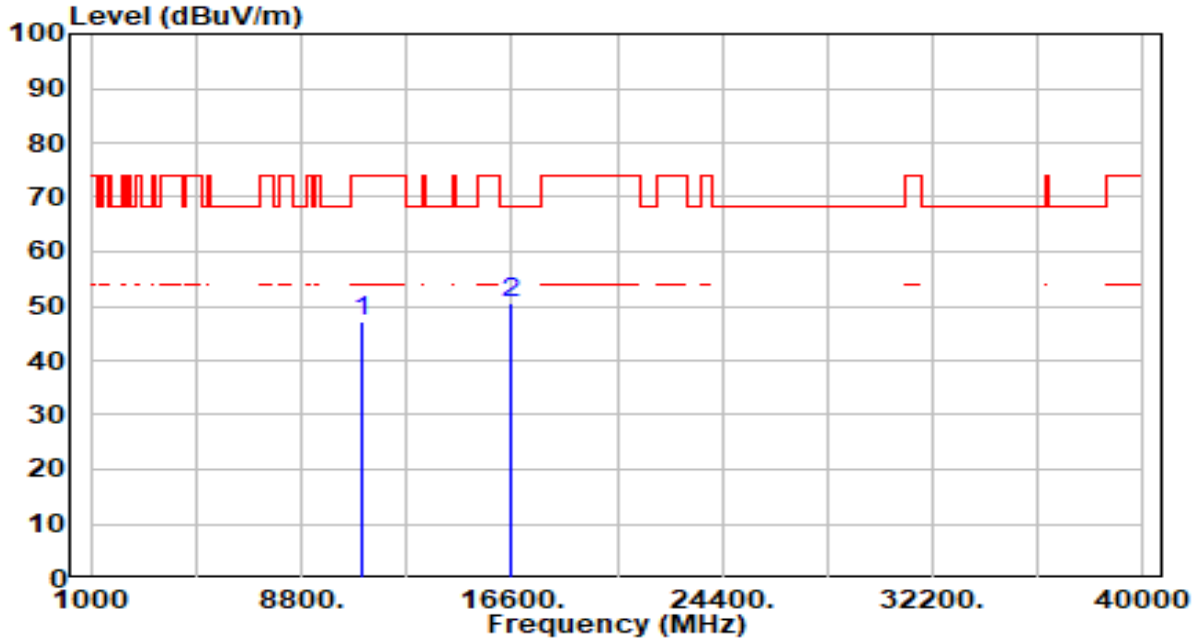

No	Frequency (MHz)	Reading (dBUV)	C.F (dB/m)	Measurement (dBUV/m)	Margin (dB)	Limit (dBUV/m)	Height (cm)	Angle (deg)	Remark (QP/PK/AV)
1	11020.000	42.50	4.57	47.07	-26.93	74.00	100	103	Peak
2	* 16530.000	44.33	6.10	50.44	-17.76	68.20	100	340	Peak

Note:

1. " *", means this data is the worst emission level.
2. C.F (Correction Factor) = Antenna Factor (dB/m)+ Cable Loss (dB) – Preamplifier(dB).
3. Measurement (dBUV/m) = Reading(dBUV) + C.F (Correction Factor).
4. The emission levels of other frequencies are very lower than the limit and not show in test report.

EUT	WiFi Module	Date of Test	2024-03-07
Factor	DRH18-E & BBHA 9170	Temp. / Humidity	23°C /61%
Polarity	Horizontal	Site / Test Engineer	AC2 / Marvin
Test Mode	802.11ax-40MHz_TX_Band3_CH 110_ANT 0	Test Voltage	By Notebook PC

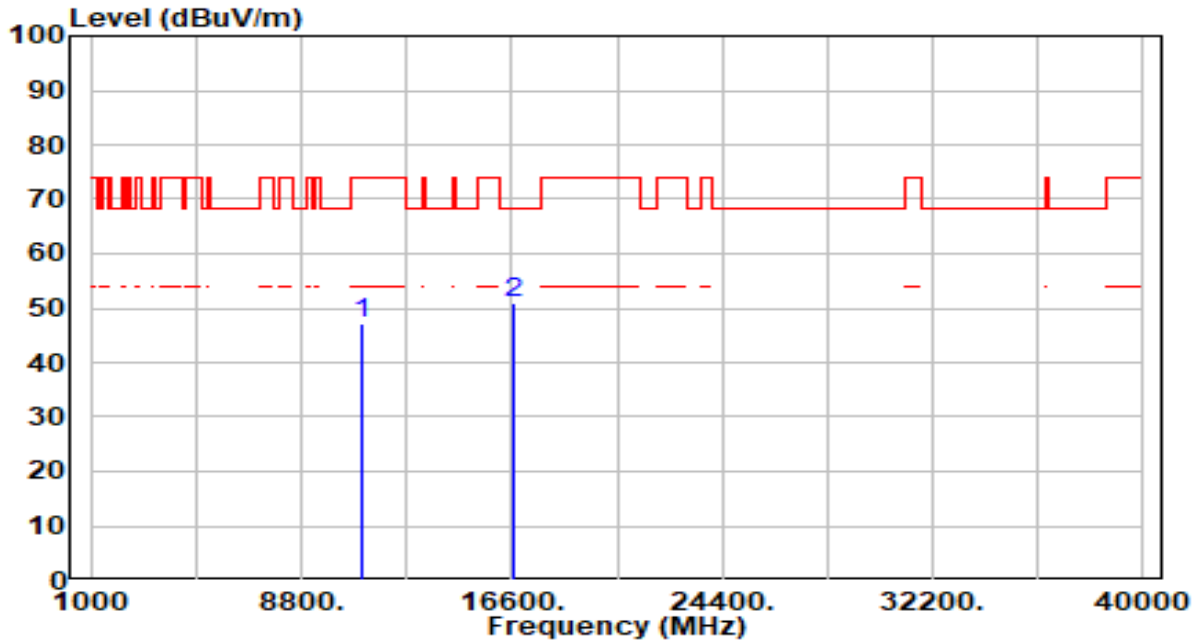

No	Frequency (MHz)	Reading (dBUV)	C.F (dB/m)	Measurement (dBUV/m)	Margin (dB)	Limit (dBUV/m)	Height (cm)	Angle (deg)	Remark (QP/PK/AV)
1	11100.000	42.55	4.78	47.33	-26.67	74.00	100	248	Peak
2	* 16650.000	44.68	6.14	50.82	-17.38	68.20	100	185	Peak

Note:

1. " *", means this data is the worst emission level.
2. C.F (Correction Factor) = Antenna Factor (dB/m)+ Cable Loss (dB) – Preamplifier(dB).
3. Measurement (dBUV/m) = Reading(dBUV) + C.F (Correction Factor).
4. The emission levels of other frequencies are very lower than the limit and not show in test report.

EUT	WiFi Module	Date of Test	2024-03-07
Factor	DRH18-E & BBHA 9170	Temp. / Humidity	23°C /61%
Polarity	Vertical	Site / Test Engineer	AC2 / Marvin
Test Mode	802.11ax-40MHz_TX_Band3_CH 110_ANT 0	Test Voltage	By Notebook PC

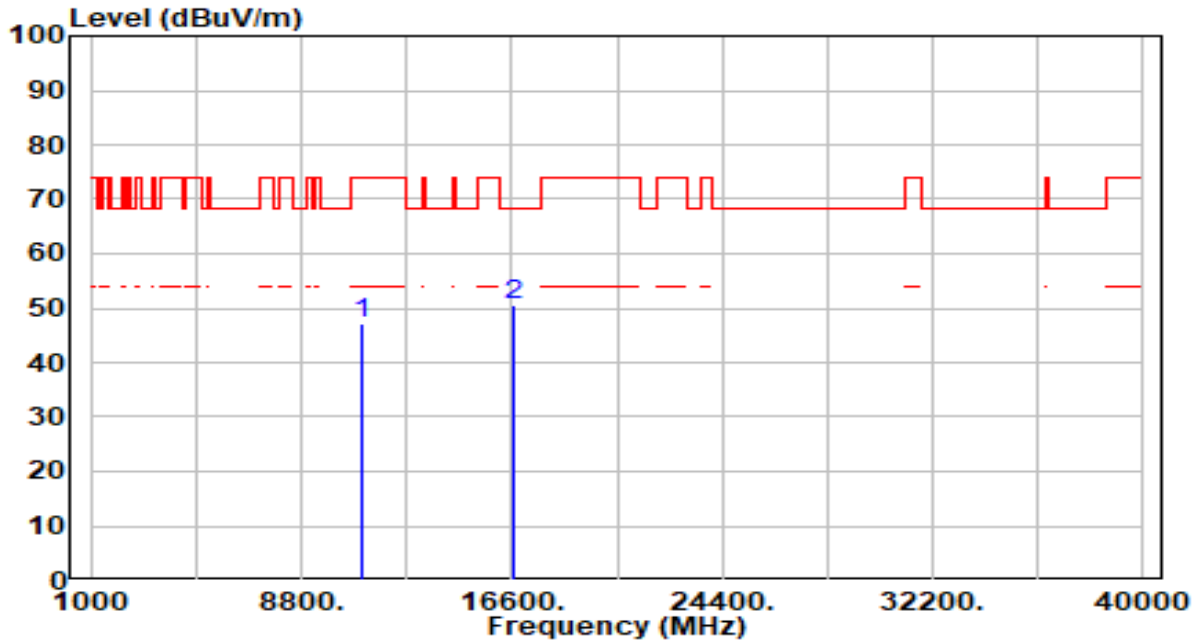

No	Frequency (MHz)	Reading (dBUV)	C.F (dB/m)	Measurement (dBUV/m)	Margin (dB)	Limit (dBUV/m)	Height (cm)	Angle (deg)	Remark (QP/PK/AV)
1	11100.000	42.21	4.78	46.99	-27.01	74.00	100	62	Peak
2	* 16650.000	44.35	6.14	50.49	-17.71	68.20	100	360	Peak

Note:

1. " *", means this data is the worst emission level.
2. C.F (Correction Factor) = Antenna Factor (dB/m)+ Cable Loss (dB) – Preamplifier(dB).
3. Measurement (dBUV/m) = Reading(dBUV) + C.F (Correction Factor).
4. The emission levels of other frequencies are very lower than the limit and not show in test report.

EUT	WiFi Module	Date of Test	2024-03-07
Factor	DRH18-E & BBHA 9170	Temp. / Humidity	23°C /61%
Polarity	Horizontal	Site / Test Engineer	AC2 / Marvin
Test Mode	802.11ax-40MHz_TX_Band3_CH 134_ANT 0	Test Voltage	By Notebook PC

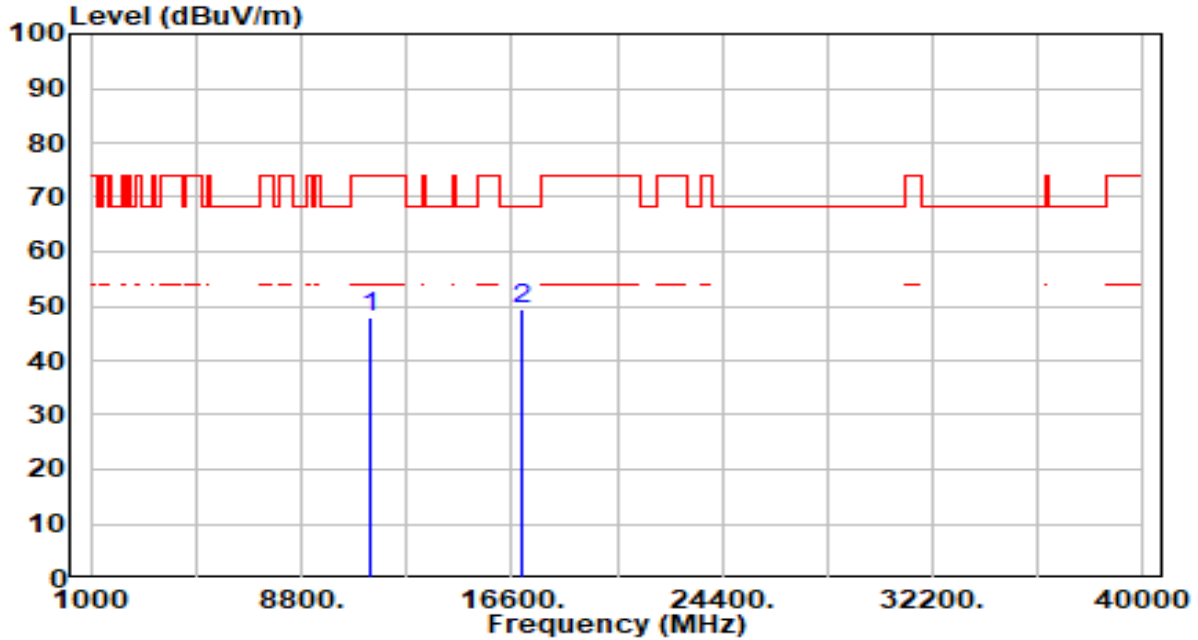

No	Frequency (MHz)	Reading (dBUV)	C.F (dB/m)	Measurement (dBUV/m)	Margin (dB)	Limit (dBUV/m)	Height (cm)	Angle (deg)	Remark (QP/PK/AV)
1	11340.000	42.72	5.20	47.92	-26.08	74.00	100	252	Peak
2	* 17010.000	43.45	6.12	49.57	-18.63	68.20	100	0	Peak

Note:

1. " *", means this data is the worst emission level.
2. C.F (Correction Factor) = Antenna Factor (dB/m)+ Cable Loss (dB) – Preamplifier(dB).
3. Measurement (dBUV/m) = Reading(dBUV) + C.F (Correction Factor).
4. The emission levels of other frequencies are very lower than the limit and not show in test report.

EUT	WiFi Module	Date of Test	2024-03-07
Factor	DRH18-E & BBHA 9170	Temp. / Humidity	23°C /61%
Polarity	Vertical	Site / Test Engineer	AC2 / Marvin
Test Mode	802.11ax-40MHz_TX_Band3_CH 134_ANT 0	Test Voltage	By Notebook PC

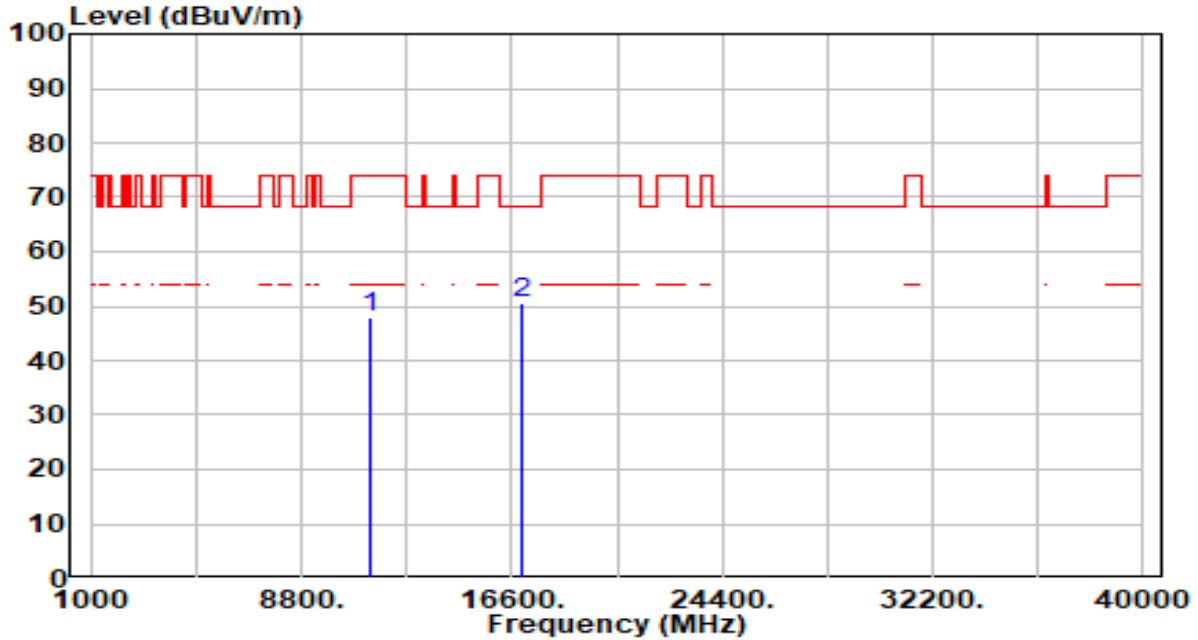

No	Frequency (MHz)	Reading (dBUV)	C.F (dB/m)	Measurement (dBUV/m)	Margin (dB)	Limit (dBUV/m)	Height (cm)	Angle (deg)	Remark (QP/PK/AV)
1	11340.000	42.84	5.20	48.04	-25.96	74.00	100	212	Peak
2	* 17010.000	44.31	6.12	50.43	-17.77	68.20	100	70	Peak

Note:

1. " *", means this data is the worst emission level.
2. C.F (Correction Factor) = Antenna Factor (dB/m)+ Cable Loss (dB) – Preamplifier(dB).
3. Measurement (dBUV/m) = Reading(dBUV) + C.F (Correction Factor).
4. The emission levels of other frequencies are very lower than the limit and not show in test report.

EUT	WiFi Module	Date of Test	2024-03-07
Factor	DRH18-E & BBHA 9170	Temp. / Humidity	23°C /61%
Polarity	Horizontal	Site / Test Engineer	AC2 / Marvin
Test Mode	802.11ax-40MHz_TX_Band3_CH 142_ANT 0	Test Voltage	By Notebook PC

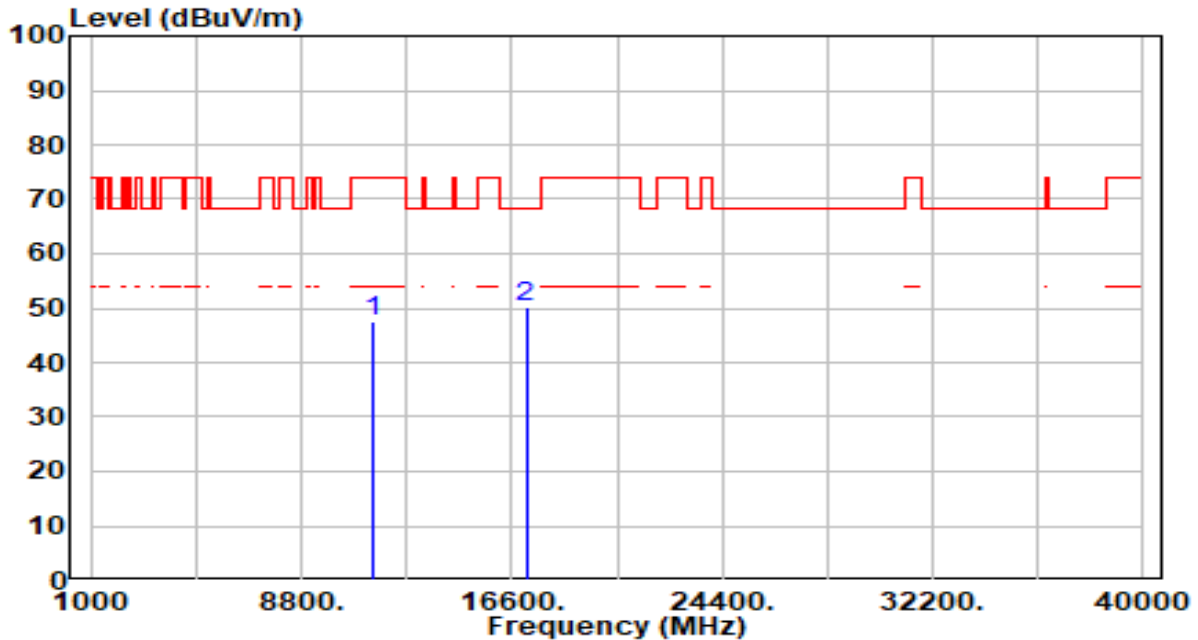

No	Frequency (MHz)	Reading (dBUV)	C.F (dB/m)	Measurement (dBUV/m)	Margin (dB)	Limit (dBUV/m)	Height (cm)	Angle (deg)	Remark (QP/PK/AV)
1	11420.000	42.36	5.28	47.64	-26.36	74.00	100	273	Peak
2	* 17130.000	44.40	5.92	50.32	-17.88	68.20	100	165	Peak

Note:

1. " *", means this data is the worst emission level.
2. C.F (Correction Factor) = Antenna Factor (dB/m)+ Cable Loss (dB) – Preamplifier(dB).
3. Measurement (dBUV/m) = Reading(dBUV) + C.F (Correction Factor).
4. The emission levels of other frequencies are very lower than the limit and not show in test report.

EUT	WiFi Module	Date of Test	2024-03-07
Factor	DRH18-E & BBHA 9170	Temp. / Humidity	23°C /61%
Polarity	Vertical	Site / Test Engineer	AC2 / Marvin
Test Mode	802.11ax-40MHz_TX_Band3_CH 142_ANT 0	Test Voltage	By Notebook PC

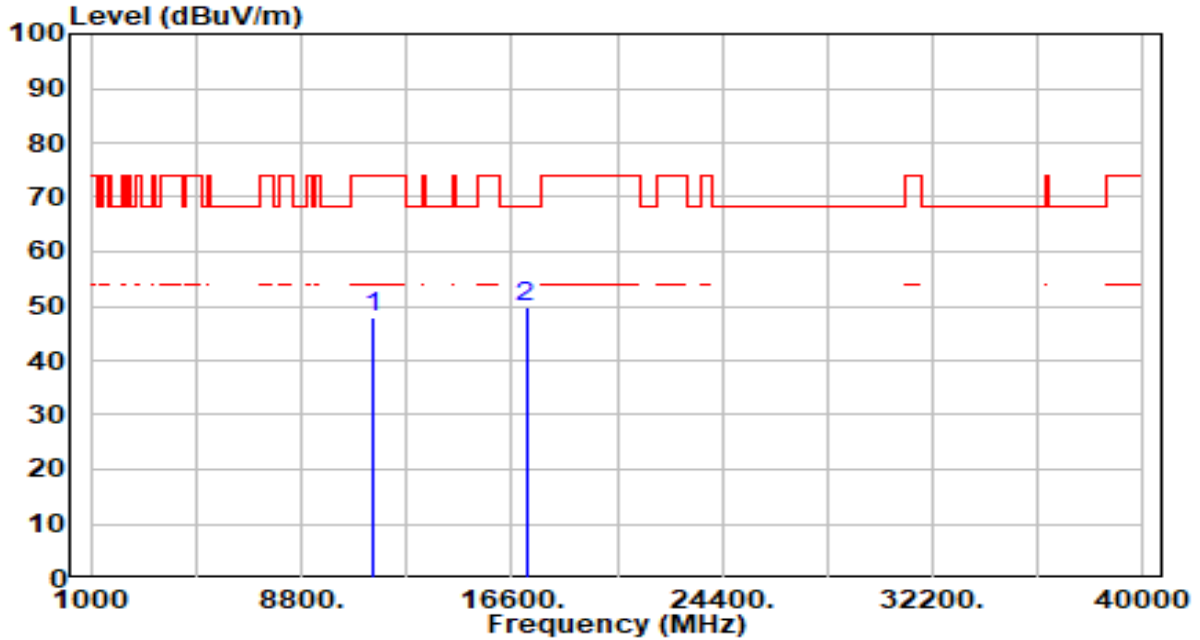

No	Frequency (MHz)	Reading (dBUV)	C.F (dB/m)	Measurement (dBUV/m)	Margin (dB)	Limit (dBUV/m)	Height (cm)	Angle (deg)	Remark (QP/PK/AV)
1	11420.000	42.73	5.28	48.01	-25.99	74.00	100	282	Peak
2	* 17130.000	44.03	5.92	49.95	-18.25	68.20	100	248	Peak

Note:

1. " *", means this data is the worst emission level.
2. C.F (Correction Factor) = Antenna Factor (dB/m)+ Cable Loss (dB) – Preamplifier(dB).
3. Measurement (dBUV/m) = Reading(dBUV) + C.F (Correction Factor).
4. The emission levels of other frequencies are very lower than the limit and not show in test report.

EUT	WiFi Module	Date of Test	2024-03-07
Factor	DRH18-E & BBHA 9170	Temp. / Humidity	23°C /61%
Polarity	Horizontal	Site / Test Engineer	AC2 / Marvin
Test Mode	802.11ax-40MHz_TX_Band4_CH 151_ANT 0	Test Voltage	By Notebook PC

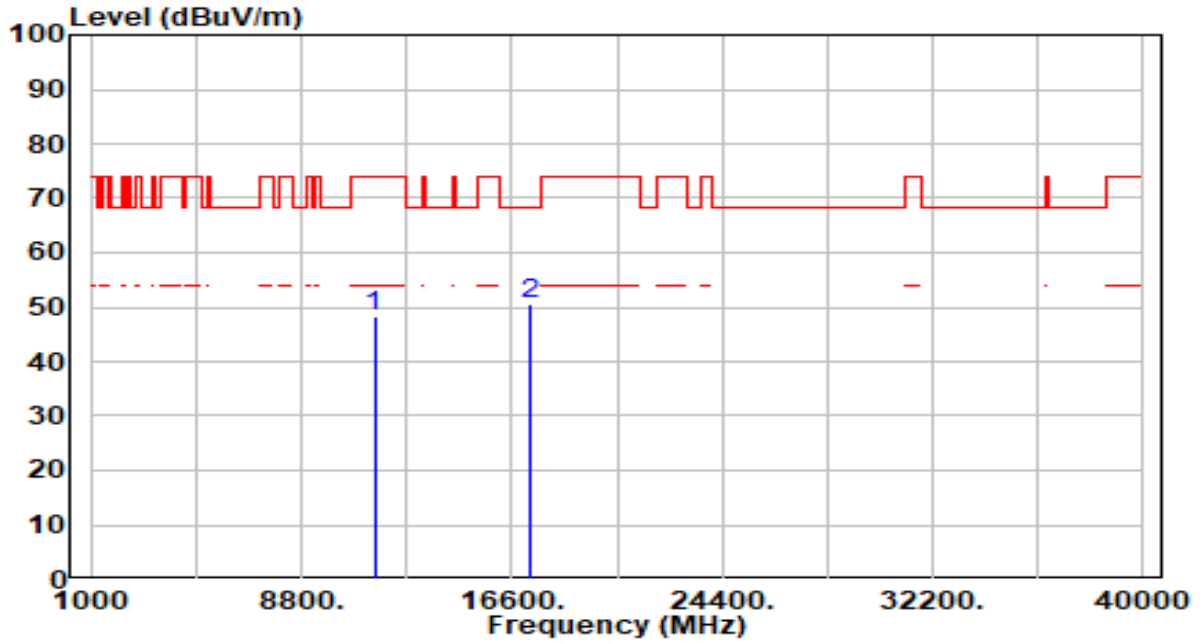

No	Frequency (MHz)	Reading (dBuV)	C.F (dB/m)	Measurement (dBuV/m)	Margin (dB)	Limit (dBuV/m)	Height (cm)	Angle (deg)	Remark (QP/PK/AV)
1	11510.000	42.97	5.33	48.31	-25.69	74.00	100	240	Peak
2	* 17265.000	44.91	5.63	50.54	-17.66	68.20	100	205	Peak

Note:

1. " *", means this data is the worst emission level.
2. C.F (Correction Factor) = Antenna Factor (dB/m)+ Cable Loss (dB) – Pre-amplifier(dB).
3. Measurement (dBuV/m) = Reading(dBuV) + C.F (Correction Factor).
4. The emission levels of other frequencies are very lower than the limit and not show in test report.

EUT	WiFi Module	Date of Test	2024-03-07
Factor	DRH18-E & BBHA 9170	Temp. / Humidity	23°C /61%
Polarity	Vertical	Site / Test Engineer	AC2 / Marvin
Test Mode	802.11ax-40MHz_TX_Band4_CH 151_ANT 0	Test Voltage	By Notebook PC

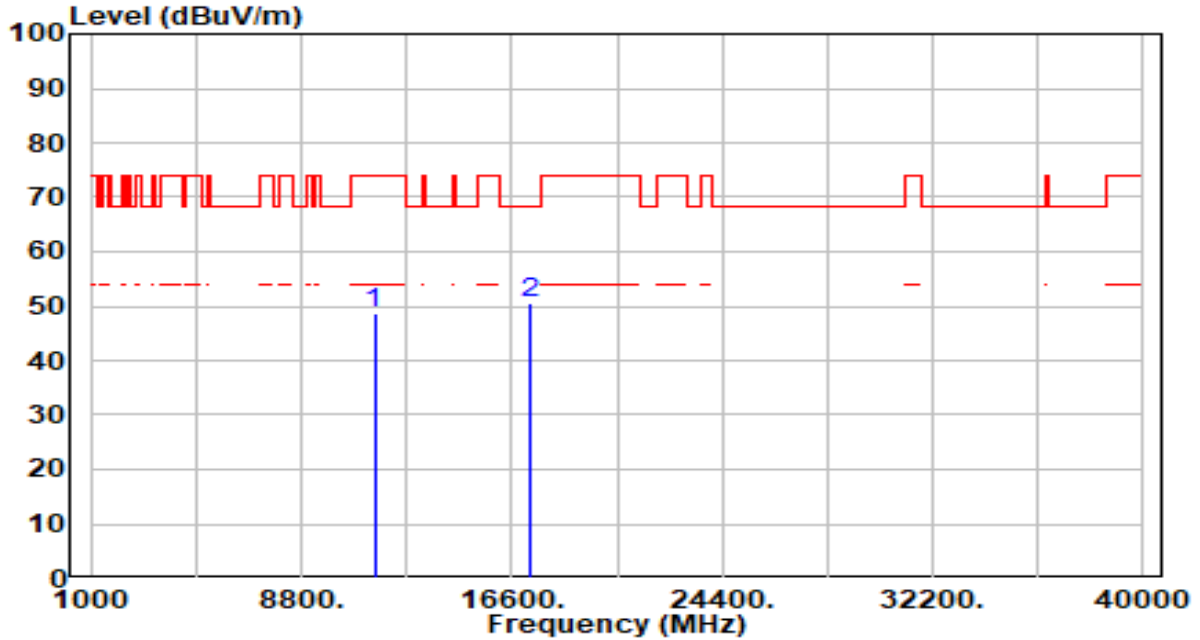

No	Frequency (MHz)	Reading (dBUV)	C.F (dB/m)	Measurement (dBUV/m)	Margin (dB)	Limit (dBUV/m)	Height (cm)	Angle (deg)	Remark (QP/PK/AV)
1	11510.000	43.44	5.33	48.77	-25.23	74.00	100	83	Peak
2	* 17265.000	45.00	5.63	50.63	-17.57	68.20	100	0	Peak

Note:

1. " *", means this data is the worst emission level.
2. C.F (Correction Factor) = Antenna Factor (dB/m)+ Cable Loss (dB) – Preamplifier(dB).
3. Measurement (dBUV/m) = Reading(dBUV) + C.F (Correction Factor).
4. The emission levels of other frequencies are very lower than the limit and not show in test report.

EUT	WiFi Module	Date of Test	2024-03-07
Factor	DRH18-E & BBHA 9170	Temp. / Humidity	23°C /61%
Polarity	Horizontal	Site / Test Engineer	AC2 / Marvin
Test Mode	802.11ax-40MHz_TX_Band4_CH 159_ANT 0	Test Voltage	By Notebook PC

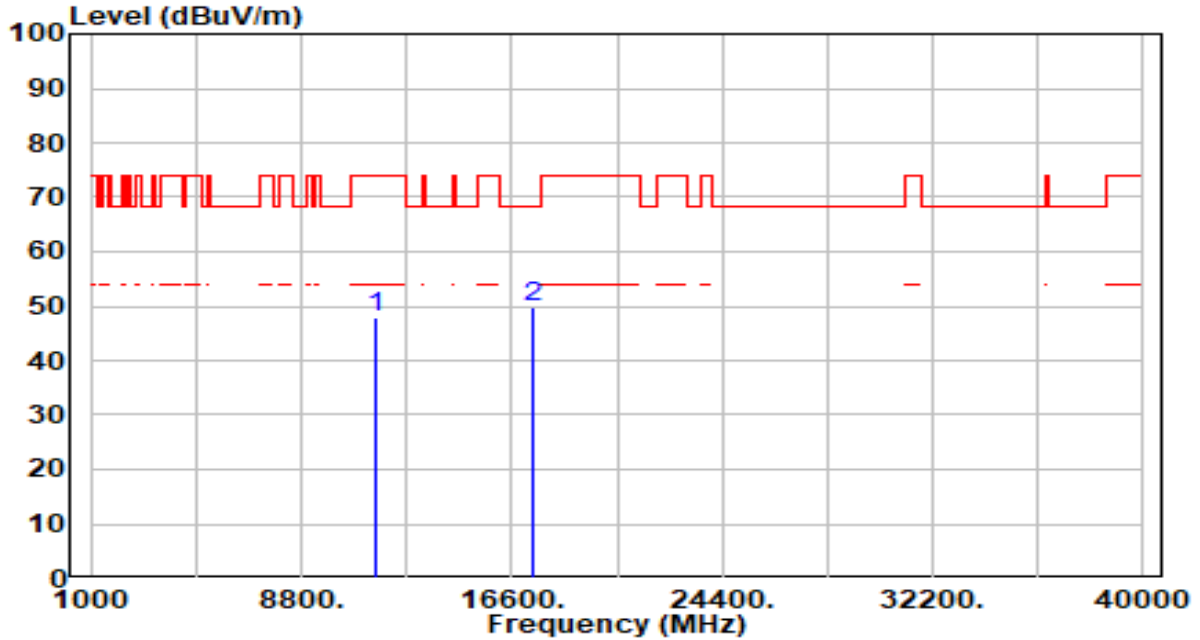

No	Frequency (MHz)	Reading (dBUV)	C.F (dB/m)	Measurement (dBUV/m)	Margin (dB)	Limit (dBUV/m)	Height (cm)	Angle (deg)	Remark (QP/PK/AV)
1	11590.000	42.68	5.39	48.08	-25.92	74.00	100	295	Peak
2	* 17385.000	44.64	5.31	49.95	-18.25	68.20	100	8	Peak

Note:

1. " *", means this data is the worst emission level.
2. C.F (Correction Factor) = Antenna Factor (dB/m)+ Cable Loss (dB) – Preamplifier(dB).
3. Measurement (dBUV/m) = Reading(dBUV) + C.F (Correction Factor).
4. The emission levels of other frequencies are very lower than the limit and not show in test report.

EUT	WiFi Module	Date of Test	2024-03-07
Factor	DRH18-E & BBHA 9170	Temp. / Humidity	23°C /61%
Polarity	Vertical	Site / Test Engineer	AC2 / Marvin
Test Mode	802.11ax-40MHz_TX_Band4_CH 159_ANT 0	Test Voltage	By Notebook PC

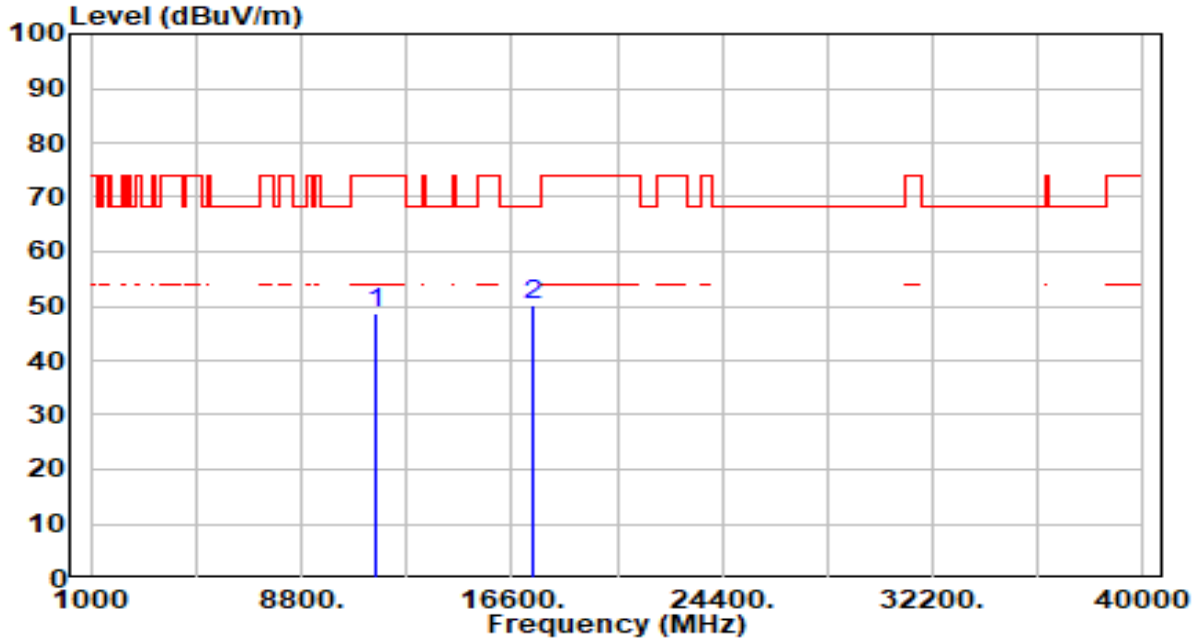

No	Frequency (MHz)	Reading (dBUV)	C.F (dB/m)	Measurement (dBUV/m)	Margin (dB)	Limit (dBUV/m)	Height (cm)	Angle (deg)	Remark (QP/PK/AV)
1	11590.000	43.26	5.39	48.65	-25.35	74.00	100	349	Peak
2	* 17385.000	45.07	5.31	50.38	-17.82	68.20	100	128	Peak

Note:

1. " *", means this data is the worst emission level.
2. C.F (Correction Factor) = Antenna Factor (dB/m)+ Cable Loss (dB) – Preamplifier(dB).
3. Measurement (dBUV/m) = Reading(dBUV) + C.F (Correction Factor).
4. The emission levels of other frequencies are very lower than the limit and not show in test report.

EUT	WiFi Module	Date of Test	2024-03-07
Factor	DRH18-E & BBHA 9170	Temp. / Humidity	23°C /61%
Polarity	Horizontal	Site / Test Engineer	AC2 / Marvin
Test Mode	802.11ax-80MHz_TX_Band1_CH 42_ANT 0	Test Voltage	By Notebook PC

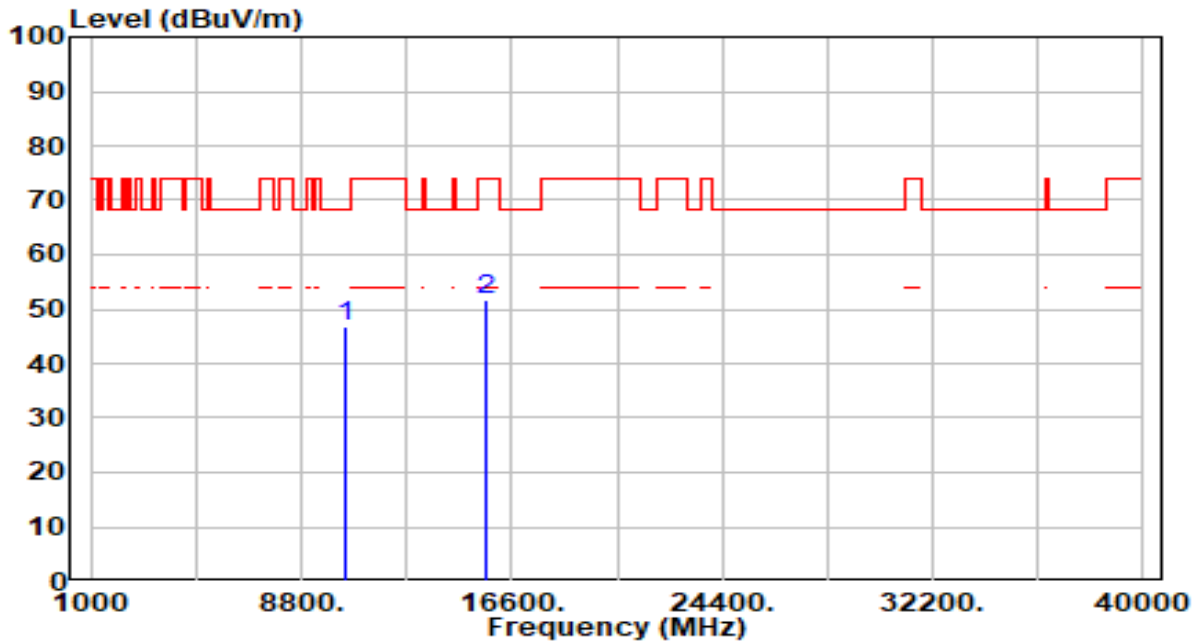

No	Frequency (MHz)	Reading (dBuV)	C.F (dB/m)	Measurement (dBuV/m)	Margin (dB)	Limit (dBuV/m)	Height (cm)	Angle (deg)	Remark (QP/PK/AV)
1	* 10420.000	42.11	4.79	46.90	-21.30	68.20	100	236	Peak
2	15630.000	45.35	6.21	51.55	-22.45	74.00	100	145	Peak

Note:

1. " *", means this data is the worst emission level.
2. C.F (Correction Factor) = Antenna Factor (dB/m)+ Cable Loss (dB) – Preamplifier(dB).
3. Measurement (dBuV/m) = Reading(dBuV) + C.F (Correction Factor).
4. The emission levels of other frequencies are very lower than the limit and not show in test report.

EUT	WiFi Module	Date of Test	2024-03-07
Factor	DRH18-E & BBHA 9170	Temp. / Humidity	23°C /61%
Polarity	Vertical	Site / Test Engineer	AC2 / Marvin
Test Mode	802.11ax-80MHz_TX_Band1_CH 42_ANT 0	Test Voltage	By Notebook PC

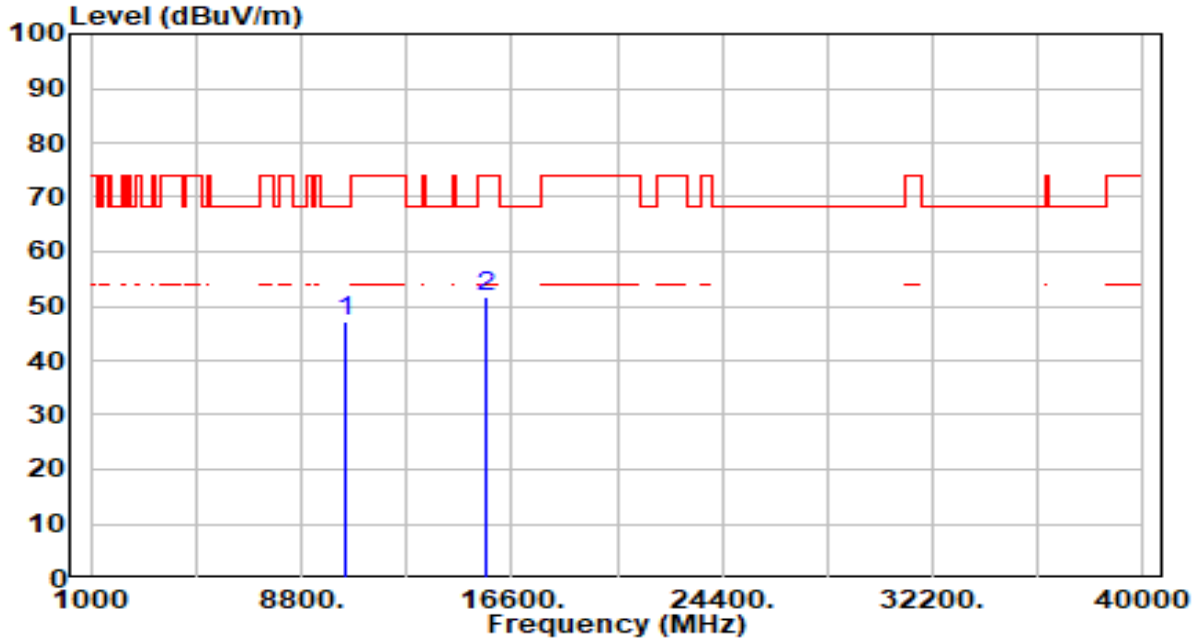

No	Frequency (MHz)	Reading (dBUV)	C.F (dB/m)	Measurement (dBUV/m)	Margin (dB)	Limit (dBUV/m)	Height (cm)	Angle (deg)	Remark (QP/PK/AV)
1	* 10420.000	42.47	4.79	47.26	-20.94	68.20	100	7	Peak
2	15630.000	45.47	6.21	51.68	-22.32	74.00	100	360	Peak

Note:

1. " *", means this data is the worst emission level.
2. C.F (Correction Factor) = Antenna Factor (dB/m)+ Cable Loss (dB) – Preamplifier(dB).
3. Measurement (dBUV/m) = Reading(dBUV) + C.F (Correction Factor).
4. The emission levels of other frequencies are very lower than the limit and not show in test report.

EUT	WiFi Module	Date of Test	2024-03-07
Factor	DRH18-E & BBHA 9170	Temp. / Humidity	23°C /61%
Polarity	Horizontal	Site / Test Engineer	AC2 / Marvin
Test Mode	802.11ax-80MHz_TX_Band2_CH 58_ANT 0	Test Voltage	By Notebook PC

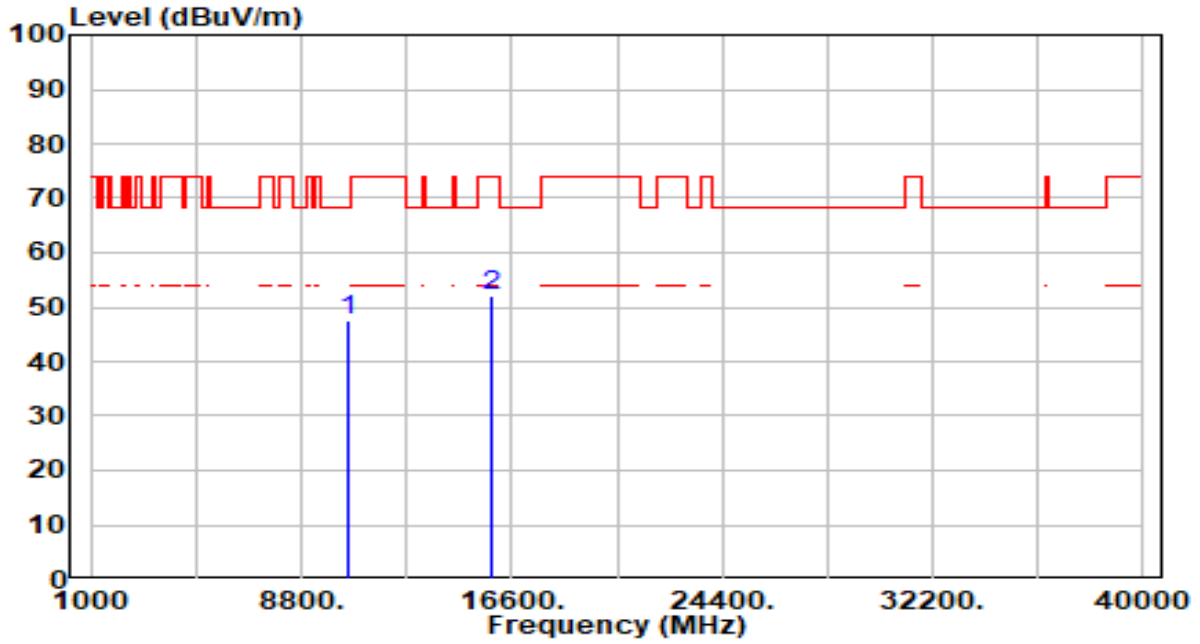

No	Frequency (MHz)	Reading (dBuV)	C.F (dB/m)	Measurement (dBuV/m)	Margin (dB)	Limit (dBuV/m)	Height (cm)	Angle (deg)	Remark (QP/PK/AV)
1	* 10580.000	42.73	4.63	47.36	-20.84	68.20	100	53	Peak
2	15870.000	45.66	6.55	52.21	-21.79	74.00	100	56	Peak

Note:

1. " *", means this data is the worst emission level.
2. C.F (Correction Factor) = Antenna Factor (dB/m)+ Cable Loss (dB) – Pre-amplifier(dB).
3. Measurement (dBuV/m) = Reading(dBuV) + C.F (Correction Factor).
4. The emission levels of other frequencies are very lower than the limit and not show in test report.

EUT	WiFi Module	Date of Test	2024-03-07
Factor	DRH18-E & BBHA 9170	Temp. / Humidity	23°C /61%
Polarity	Vertical	Site / Test Engineer	AC2 / Marvin
Test Mode	802.11ax-80MHz_TX_Band2_CH 58_ANT 0	Test Voltage	By Notebook PC

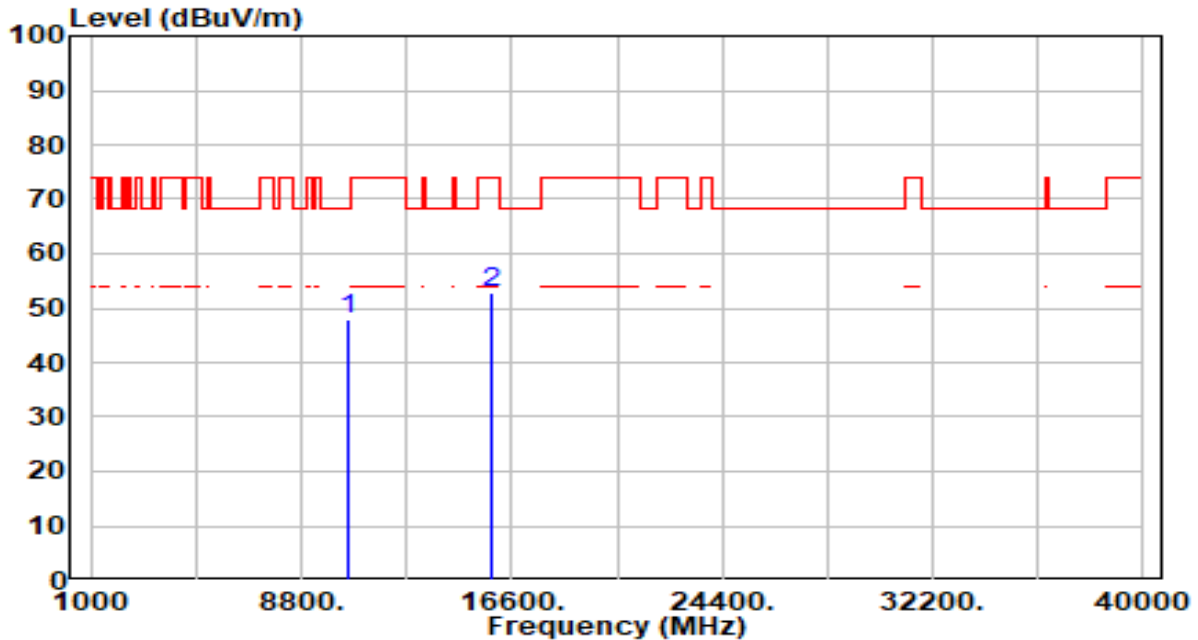

No	Frequency (MHz)	Reading (dBuV)	C.F (dB/m)	Measurement (dBuV/m)	Margin (dB)	Limit (dBuV/m)	Height (cm)	Angle (deg)	Remark (QP/PK/AV)
1	* 10580.000	43.11	4.63	47.74	-20.46	68.20	100	343	Peak
2	15870.000	46.23	6.55	52.77	-21.23	74.00	100	179	Peak

Note:

1. " *", means this data is the worst emission level.
2. C.F (Correction Factor) = Antenna Factor (dB/m)+ Cable Loss (dB) – Preamplifier(dB).
3. Measurement (dBuV/m) = Reading(dBuV) + C.F (Correction Factor).
4. The emission levels of other frequencies are very lower than the limit and not show in test report.

EUT	WiFi Module	Date of Test	2024-03-07
Factor	DRH18-E & BBHA 9170	Temp. / Humidity	23°C /61%
Polarity	Horizontal	Site / Test Engineer	AC2 / Marvin
Test Mode	802.11ax-80MHz_TX_Band3_CH 106_ANT 0	Test Voltage	By Notebook PC

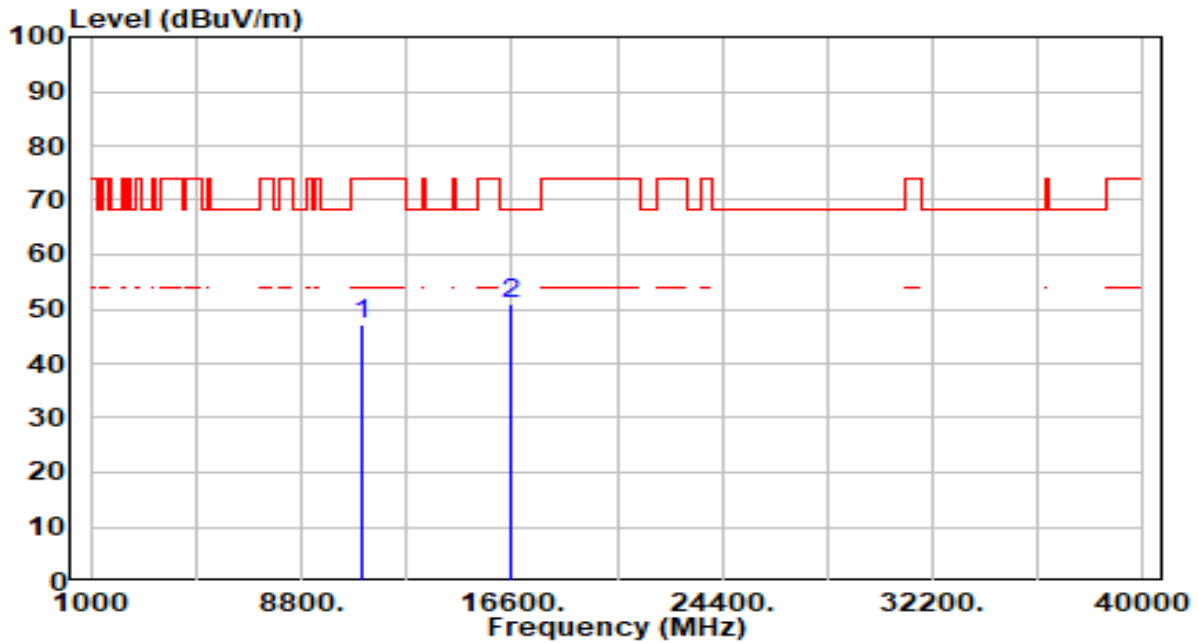

No	Frequency (MHz)	Reading (dBuV)	C.F (dB/m)	Measurement (dBuV/m)	Margin (dB)	Limit (dBuV/m)	Height (cm)	Angle (deg)	Remark (QP/PK/AV)
1	11060.000	42.61	4.68	47.29	-26.71	74.00	100	360	Peak
2	* 16590.000	44.68	6.11	50.79	-17.41	68.20	100	317	Peak

Note:

1. " *", means this data is the worst emission level.
2. C.F (Correction Factor) = Antenna Factor (dB/m)+ Cable Loss (dB) – Pre-amplifier(dB).
3. Measurement (dBuV/m) = Reading(dBuV) + C.F (Correction Factor).
4. The emission levels of other frequencies are very lower than the limit and not show in test report.

EUT	WiFi Module	Date of Test	2024-03-07
Factor	DRH18-E & BBHA 9170	Temp. / Humidity	23°C /61%
Polarity	Vertical	Site / Test Engineer	AC2 / Marvin
Test Mode	802.11ax-80MHz_TX_Band3_CH 106_ANT 0	Test Voltage	By Notebook PC

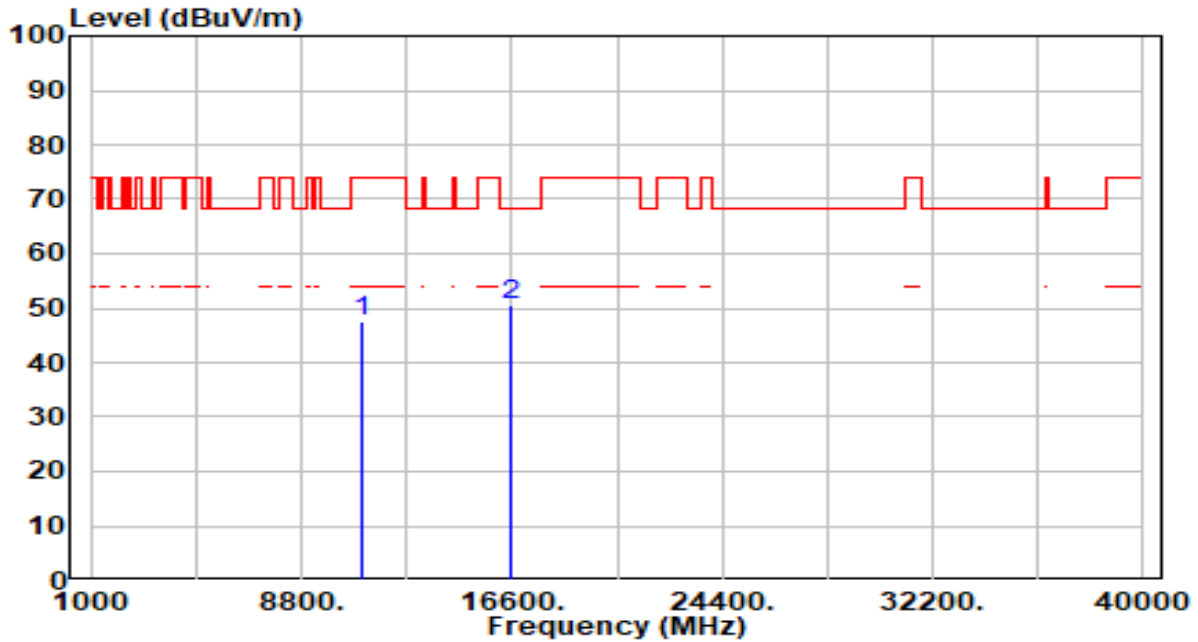

No	Frequency (MHz)	Reading (dBUV)	C.F (dB/m)	Measurement (dBUV/m)	Margin (dB)	Limit (dBUV/m)	Height (cm)	Angle (deg)	Remark (QP/PK/AV)
1	11060.000	42.82	4.68	47.49	-26.51	74.00	100	221	Peak
2	* 16590.000	44.60	6.11	50.71	-17.49	68.20	100	64	Peak

Note:

1. " *", means this data is the worst emission level.
2. C.F (Correction Factor) = Antenna Factor (dB/m)+ Cable Loss (dB) – Preamplifier(dB).
3. Measurement (dBUV/m) = Reading(dBUV) + C.F (Correction Factor).
4. The emission levels of other frequencies are very lower than the limit and not show in test report.

EUT	WiFi Module	Date of Test	2024-03-07
Factor	DRH18-E & BBHA 9170	Temp. / Humidity	23°C /61%
Polarity	Horizontal	Site / Test Engineer	AC2 / Marvin
Test Mode	802.11ax-80MHz_TX_Band3_CH 122_ANT 0	Test Voltage	By Notebook PC

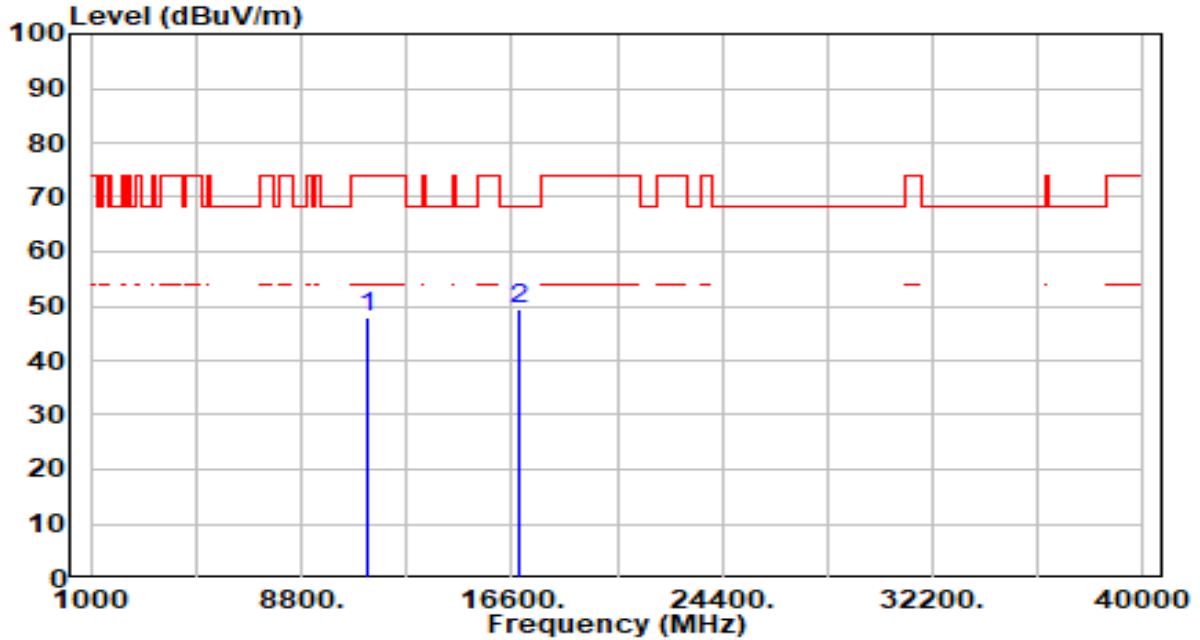

No	Frequency (MHz)	Reading (dBUV)	C.F (dB/m)	Measurement (dBUV/m)	Margin (dB)	Limit (dBUV/m)	Height (cm)	Angle (deg)	Remark (QP/PK/AV)
1	11220.000	42.80	5.06	47.87	-26.13	74.00	100	119	Peak
2	* 16830.000	43.39	6.21	49.60	-18.60	68.20	100	332	Peak

Note:

1. " *", means this data is the worst emission level.
2. C.F (Correction Factor) = Antenna Factor (dB/m)+ Cable Loss (dB) – Preamplifier(dB).
3. Measurement (dBUV/m) = Reading(dBUV) + C.F (Correction Factor).
4. The emission levels of other frequencies are very lower than the limit and not show in test report.

EUT	WiFi Module	Date of Test	2024-03-07
Factor	DRH18-E & BBHA 9170	Temp. / Humidity	23°C /61%
Polarity	Vertical	Site / Test Engineer	AC2 / Marvin
Test Mode	802.11ax-80MHz_TX_Band3_CH 122_ANT 0	Test Voltage	By Notebook PC

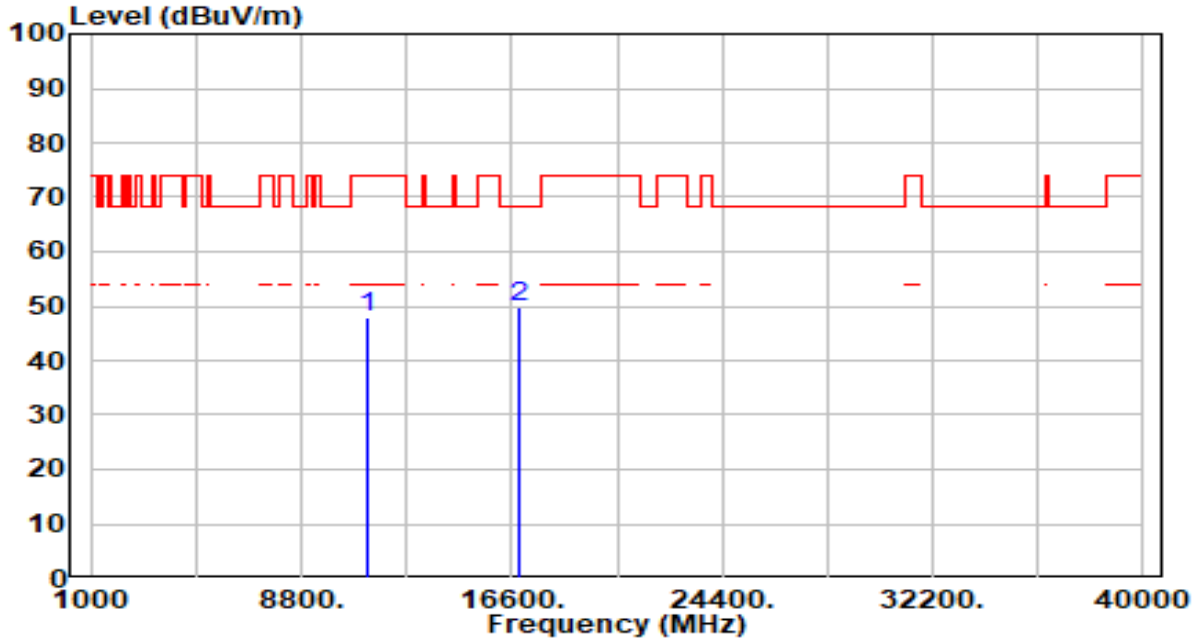

No	Frequency (MHz)	Reading (dBUV)	C.F (dB/m)	Measurement (dBUV/m)	Margin (dB)	Limit (dBUV/m)	Height (cm)	Angle (deg)	Remark (QP/PK/AV)
1	11220.000	42.93	5.06	48.00	-26.00	74.00	100	143	Peak
2	* 16830.000	43.68	6.21	49.89	-18.31	68.20	100	212	Peak

Note:

1. " *", means this data is the worst emission level.
2. C.F (Correction Factor) = Antenna Factor (dB/m)+ Cable Loss (dB) – Preamplifier(dB).
3. Measurement (dBUV/m) = Reading(dBUV) + C.F (Correction Factor).
4. The emission levels of other frequencies are very lower than the limit and not show in test report.

EUT	WiFi Module	Date of Test	2024-03-07
Factor	DRH18-E & BBHA 9170	Temp. / Humidity	23°C /61%
Polarity	Horizontal	Site / Test Engineer	AC2 / Marvin
Test Mode	802.11ax-80MHz_TX_Band3_CH 138_ANT 0	Test Voltage	By Notebook PC

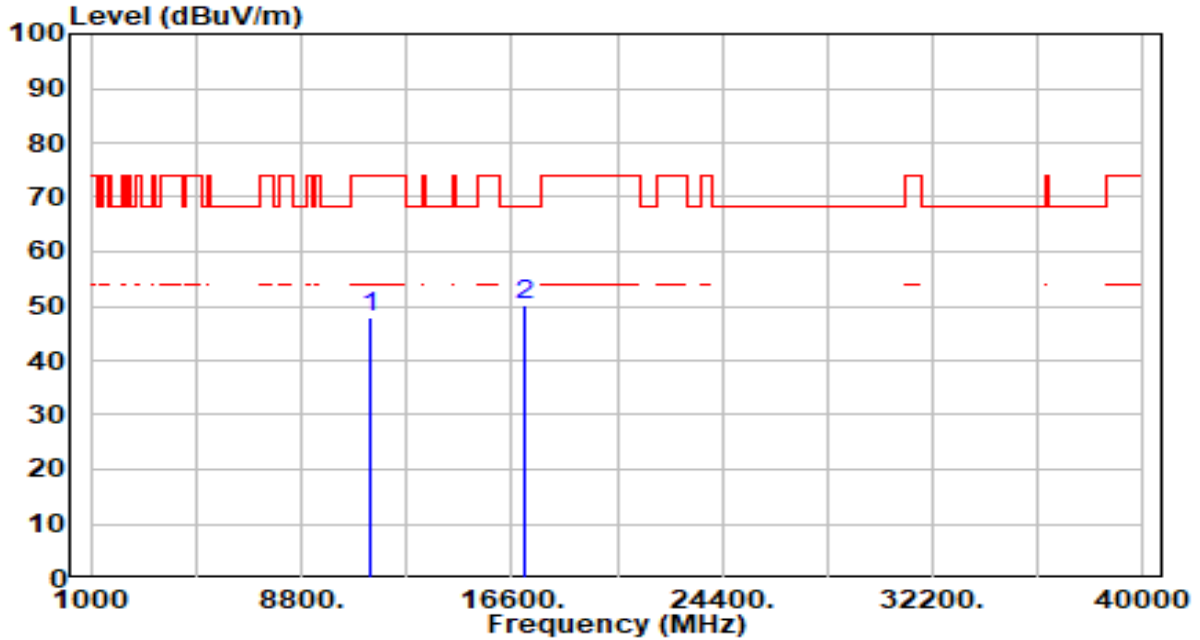

No	Frequency (MHz)	Reading (dBUV)	C.F (dB/m)	Measurement (dBUV/m)	Margin (dB)	Limit (dBUV/m)	Height (cm)	Angle (deg)	Remark (QP/PK/AV)
1	11380.000	42.87	5.24	48.11	-25.89	74.00	100	48	Peak
2	* 17070.000	44.30	6.02	50.32	-17.88	68.20	100	360	Peak

Note:

1. " *", means this data is the worst emission level.
2. C.F (Correction Factor) = Antenna Factor (dB/m)+ Cable Loss (dB) – Preamplifier(dB).
3. Measurement (dBUV/m) = Reading(dBUV) + C.F (Correction Factor).
4. The emission levels of other frequencies are very lower than the limit and not show in test report.

EUT	WiFi Module	Date of Test	2024-03-07
Factor	DRH18-E & BBHA 9170	Temp. / Humidity	23°C /61%
Polarity	Vertical	Site / Test Engineer	AC2 / Marvin
Test Mode	802.11ax-80MHz_TX_Band3_CH 138_ANT 0	Test Voltage	By Notebook PC

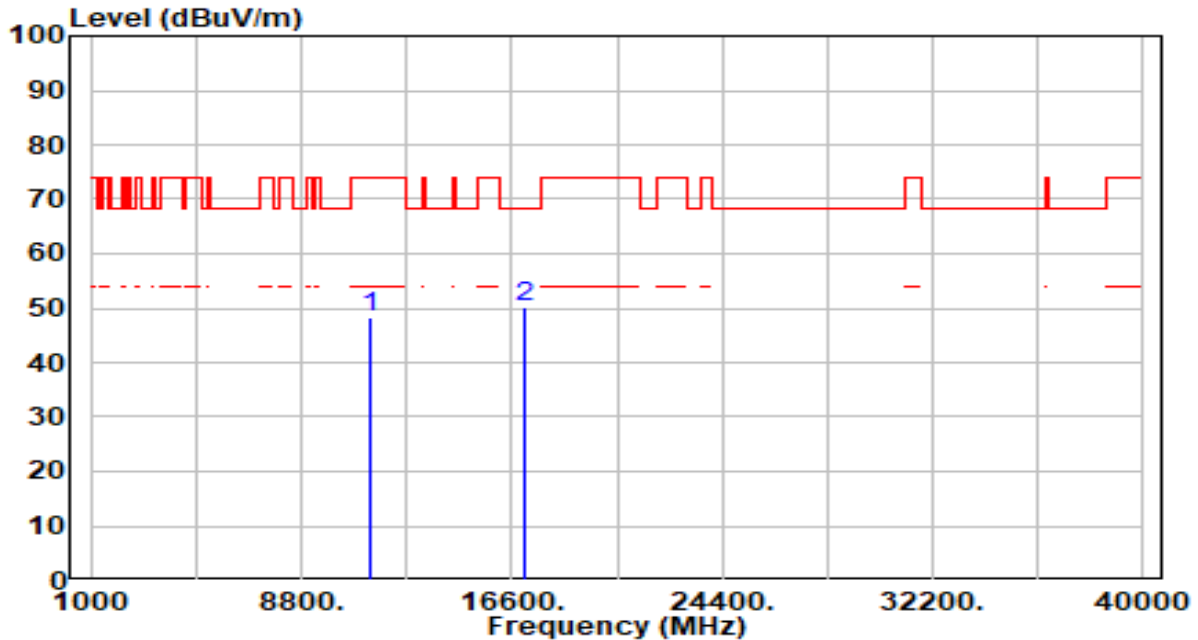

No	Frequency (MHz)	Reading (dBUV)	C.F (dB/m)	Measurement (dBUV/m)	Margin (dB)	Limit (dBUV/m)	Height (cm)	Angle (deg)	Remark (QP/PK/AV)
1	11380.000	43.23	5.24	48.47	-25.53	74.00	100	281	Peak
2	* 17070.000	44.32	6.02	50.34	-17.86	68.20	100	108	Peak

Note:

1. " *", means this data is the worst emission level.
2. C.F (Correction Factor) = Antenna Factor (dB/m)+ Cable Loss (dB) – Preamplifier(dB).
3. Measurement (dBUV/m) = Reading(dBUV) + C.F (Correction Factor).
4. The emission levels of other frequencies are very lower than the limit and not show in test report.