

**HARMONICS AND SPURIOUS EMISSIONS (LOW CHANNEL, VERTICAL)**

No.	Frequency (MHz)	Reading (dBuV)	Correct (dB/m)	Result (dBuV/m)	Limit (dBuV/m)	Margin (dB)	Remark
1	8936.000	38.14	11.10	49.24	74.00	-24.76	peak
2	10564.000	35.92	13.33	49.25	74.00	-24.75	peak
3	11488.000	37.13	15.58	52.71	74.00	-21.29	peak
4	14799.000	32.84	17.82	50.66	74.00	-23.34	peak
5	17241.000	30.12	22.34	52.46	74.00	-21.54	peak
6	17670.000	29.09	23.04	52.13	74.00	-21.87	peak

- Note:
1. Measurement = Reading Level + Correct Factor.
  2. If Peak Result complies with AV limit, AV Result is deemed to comply with AV limit.
  3. Peak: Peak detector.
  4. AVG:  $VBW=1/Ton$ , where: Ton is the transmitting duration.
  5. For the transmitting duration, please refer to clause 7.1.
  6. Filter losses were only considered in the spurious frequency bands and the authorized band was not corrected for High Pass Filter losses.
  7. Proper operation of the transmitter prior to adding the filter to the measurement chain.
  8. Since non-restricted band peak emissions are less than the average limit, they also comply with the  $-27dBm/MHz$  ( $68.2dBuV/m$ ) limit.

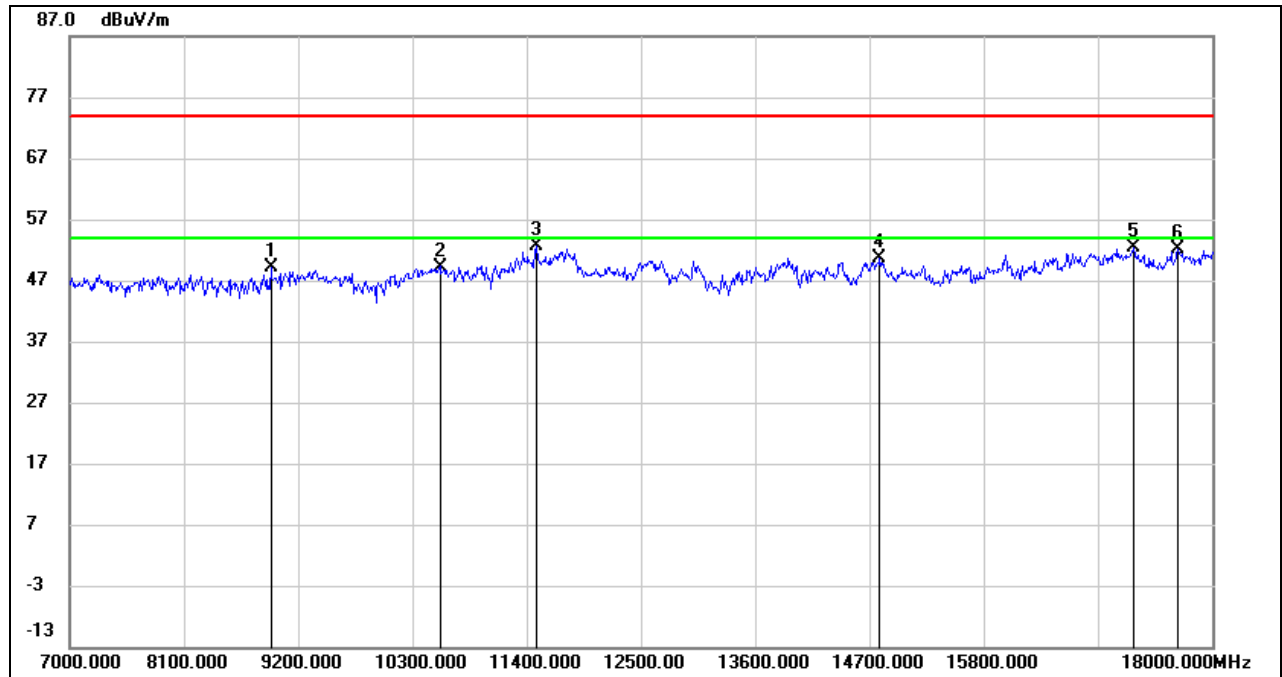

**HARMONICS AND SPURIOUS EMISSIONS (MID CHANNEL, HORIZONTAL)**

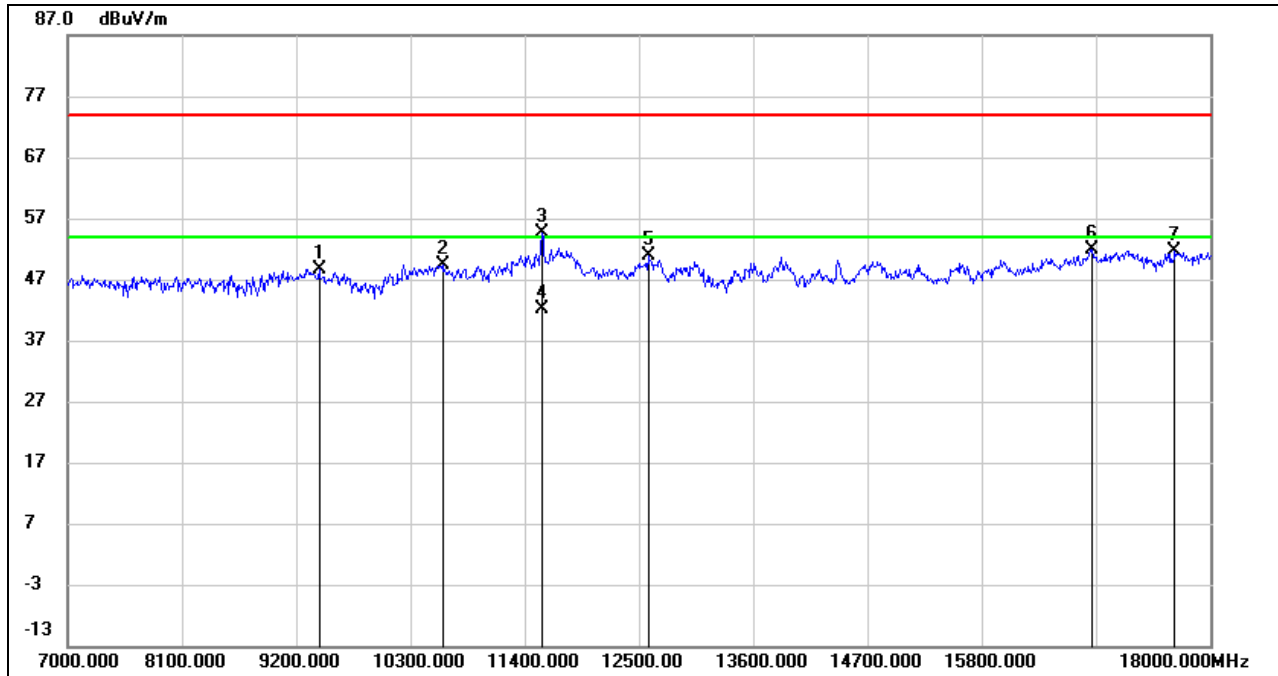

No.	Frequency (MHz)	Reading (dBuV)	Correct (dB/m)	Result (dBuV/m)	Limit (dBuV/m)	Margin (dB)	Remark
1	9420.000	37.23	11.50	48.73	74.00	-25.27	peak
2	10608.000	35.89	13.47	49.36	74.00	-24.64	peak
3	11565.000	38.85	15.72	54.57	74.00	-19.43	peak
4	11565.000	26.40	15.72	42.12	54.00	-11.88	AVG
5	12588.000	34.11	16.81	50.92	74.00	-23.08	peak
6	16867.000	30.75	21.12	51.87	74.00	-22.13	peak
7	17659.000	28.62	22.97	51.59	74.00	-22.41	peak

- Note: 1. Measurement = Reading Level + Correct Factor.  
 2. If Peak Result complies with AV limit, AV Result is deemed to comply with AV limit.  
 3. Peak: Peak detector.  
 4. AVG: VBW=1/Ton, where: Ton is the transmitting duration.  
 5. For the transmitting duration, please refer to clause 7.1.  
 6. Filter losses were only considered in the spurious frequency bands and the authorized band was not corrected for High Pass Filter losses.  
 7. Proper operation of the transmitter prior to adding the filter to the measurement chain.  
 8. Since non-restricted band peak emissions are less than the average limit, they also comply with the -27dBm/MHz (68.2dBuV/m) limit.

### HARMONICS AND SPURIOUS EMISSIONS (MID CHANNEL, VERTICAL)

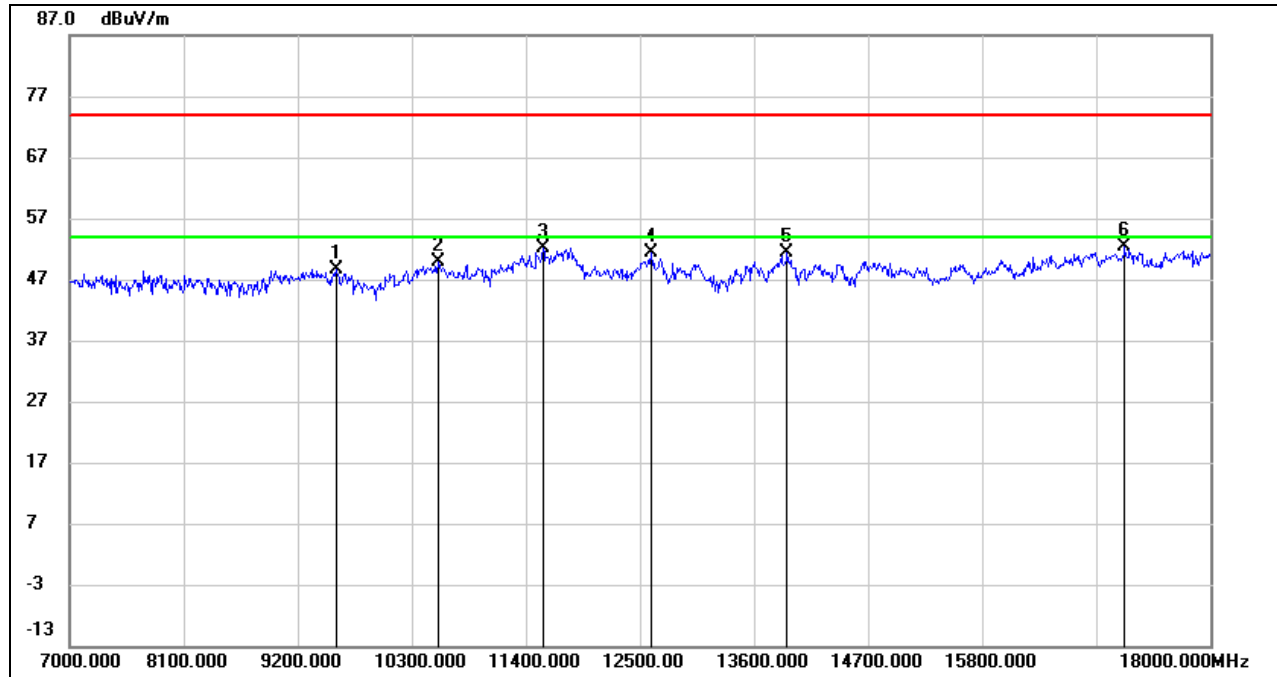

No.	Frequency (MHz)	Reading (dBuV)	Correct (dB/m)	Result (dBuV/m)	Limit (dBuV/m)	Margin (dB)	Remark
1	9574.000	36.74	11.90	48.64	74.00	-25.36	peak
2	10553.000	36.60	13.28	49.88	74.00	-24.12	peak
3	11565.000	36.53	15.72	52.25	74.00	-21.75	peak
4	12610.000	34.63	16.82	51.45	74.00	-22.55	peak
5	13919.000	33.32	17.97	51.29	74.00	-22.71	peak
6	17175.000	30.08	22.33	52.41	74.00	-21.59	peak

- Note:
1. Measurement = Reading Level + Correct Factor.
  2. If Peak Result complies with AV limit, AV Result is deemed to comply with AV limit.
  3. Peak: Peak detector.
  4. AVG:  $VBW=1/Ton$ , where: Ton is the transmitting duration.
  5. For the transmitting duration, please refer to clause 7.1.
  6. Filter losses were only considered in the spurious frequency bands and the authorized band was not corrected for High Pass Filter losses.
  7. Proper operation of the transmitter prior to adding the filter to the measurement chain.
  8. Since non-restricted band peak emissions are less than the average limit, they also comply with the -27dBm/MHz (68.2dBuV/m) limit.

### HARMONICS AND SPURIOUS EMISSIONS (HIGH CHANNEL, HORIZONTAL)

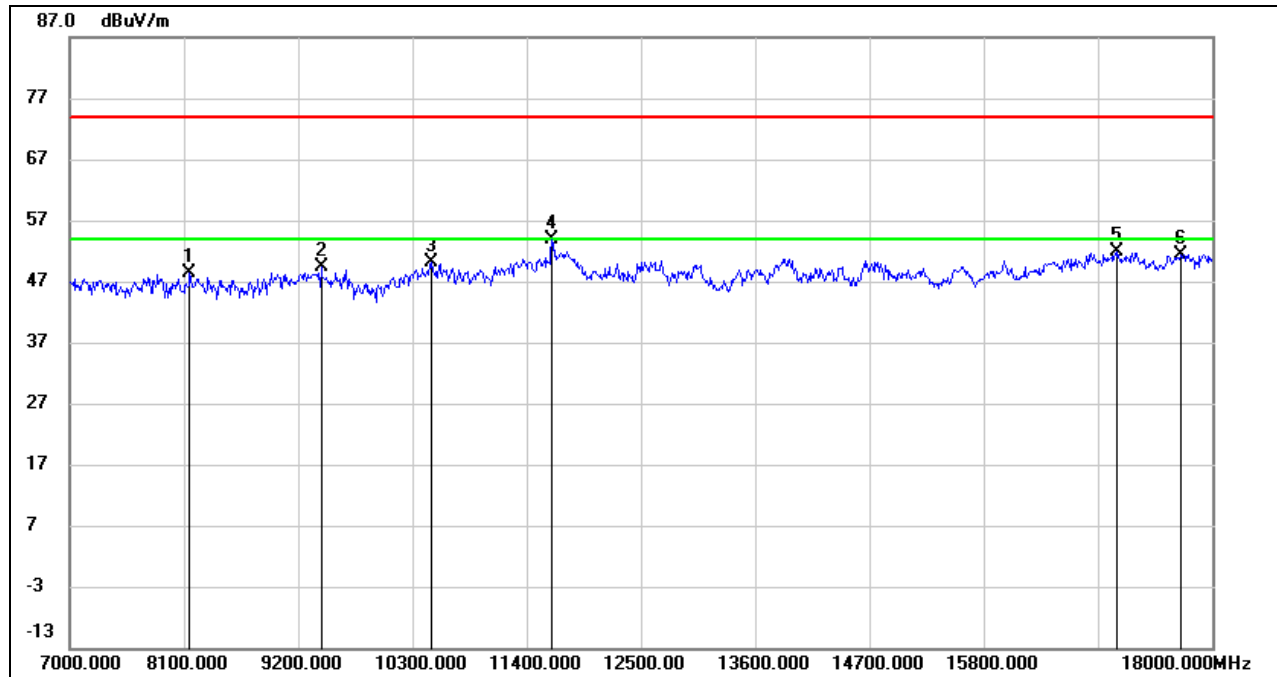

No.	Frequency (MHz)	Reading (dBuV)	Correct (dB/m)	Result (dBuV/m)	Limit (dBuV/m)	Margin (dB)	Remark
1	8155.000	38.24	10.18	48.42	74.00	-25.58	peak
2	9420.000	37.85	11.50	49.35	74.00	-24.65	peak
3	10487.000	37.01	13.03	50.04	74.00	-23.96	peak
4	11642.000	37.85	15.98	53.83	74.00	-20.17	peak
5	17076.000	30.15	21.79	51.94	74.00	-22.06	peak
6	17703.000	28.14	23.27	51.41	74.00	-22.59	peak

Note: 1. Measurement = Reading Level + Correct Factor.

2. If Peak Result complies with AV limit, AV Result is deemed to comply with AV limit.

3. Peak: Peak detector.

4. AVG:  $VBW=1/Ton$ , where: Ton is the transmitting duration.

5. For the transmitting duration, please refer to clause 7.1.

6. Filter losses were only considered in the spurious frequency bands and the authorized band was not corrected for High Pass Filter losses.

7. Proper operation of the transmitter prior to adding the filter to the measurement chain.

8. Since non-restricted band peak emissions are less than the average limit, they also comply with the -27dBm/MHz (68.2dBuV/m) limit.

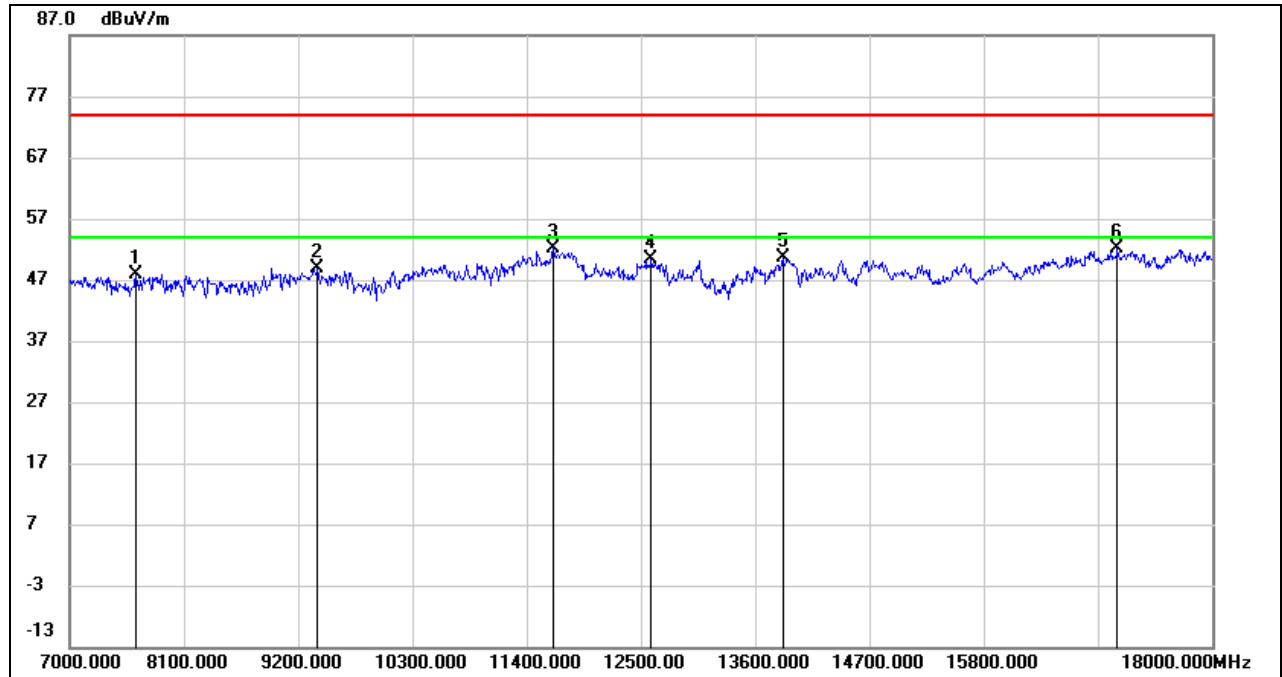
**HARMONICS AND SPURIOUS EMISSIONS (HIGH CHANNEL, VERTICAL)**

No.	Frequency (MHz)	Reading (dBuV)	Correct (dB/m)	Result (dBuV/m)	Limit (dBuV/m)	Margin (dB)	Remark
1	7638.000	39.04	8.91	47.95	74.00	-26.05	peak
2	9387.000	37.61	11.38	48.99	74.00	-25.01	peak
3	11653.000	36.22	16.03	52.25	74.00	-21.75	peak
4	12599.000	33.44	16.83	50.27	74.00	-23.73	peak
5	13864.000	32.62	18.03	50.65	74.00	-23.35	peak
6	17087.000	30.30	21.85	52.15	74.00	-21.85	peak

- Note: 1. Measurement = Reading Level + Correct Factor.  
2. If Peak Result complies with AV limit, AV Result is deemed to comply with AV limit.  
3. Peak: Peak detector.  
4. AVG:  $VBW=1/Ton$ , where: Ton is the transmitting duration.  
5. For the transmitting duration, please refer to clause 7.1.  
6. Filter losses were only considered in the spurious frequency bands and the authorized band was not corrected for High Pass Filter losses.  
7. Proper operation of the transmitter prior to adding the filter to the measurement chain.  
8. Since non-restricted band peak emissions are less than the average limit, they also comply with the  $-27dBm/MHz$  ( $68.2dBuV/m$ ) limit.

8.3.3. 802.11n HT40 SISO MODE

UNII-1 BAND

HARMONICS AND SPURIOUS EMISSIONS (LOW CHANNEL, HORIZONTAL)

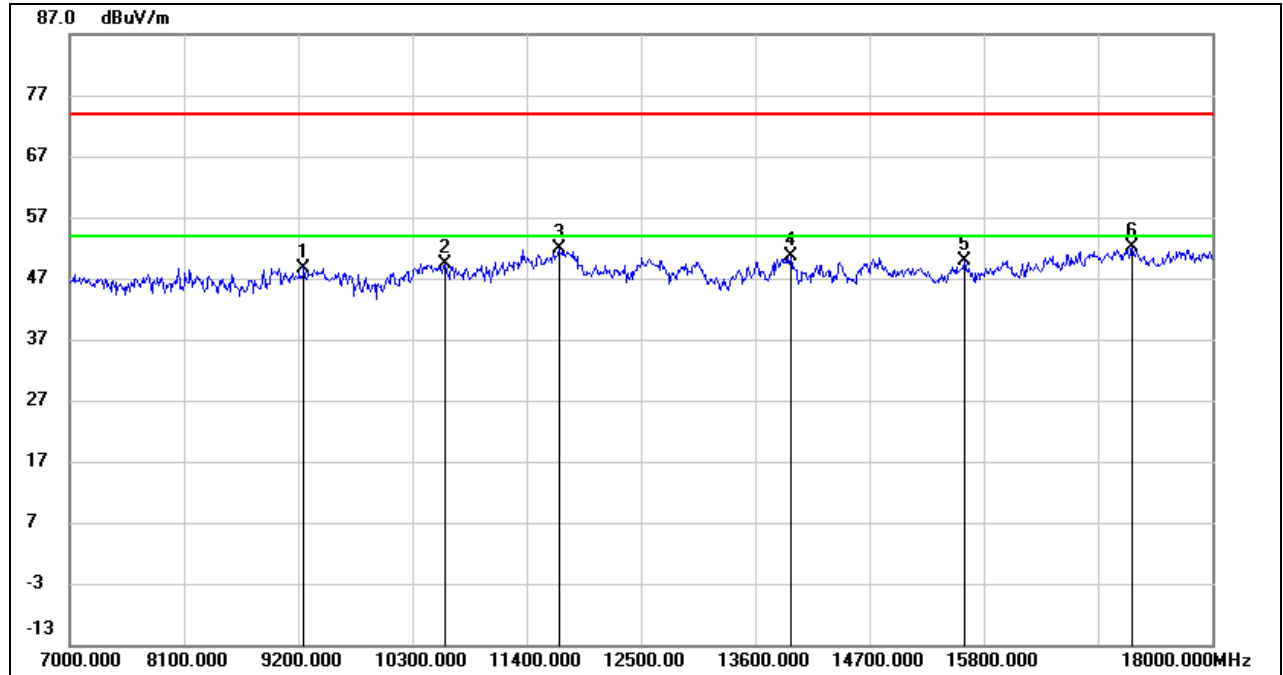

No.	Frequency (MHz)	Reading (dBuV)	Correct (dB/m)	Result (dBuV/m)	Limit (dBuV/m)	Margin (dB)	Remark
1	9255.000	37.95	10.80	48.75	74.00	-25.25	peak
2	10608.000	36.01	13.47	49.48	74.00	-24.52	peak
3	11708.000	35.59	16.28	51.87	74.00	-22.13	peak
4	13941.000	32.65	17.95	50.60	74.00	-23.40	peak
5	15613.000	31.94	17.93	49.87	74.00	-24.13	peak
6	17230.000	29.73	22.37	52.10	74.00	-21.90	peak

- Note: 1. Measurement = Reading Level + Correct Factor.  
 2. If Peak Result complies with AV limit, AV Result is deemed to comply with AV limit.  
 3. Peak: Peak detector.  
 4. AVG:  $VBW=1/Ton$ , where: Ton is the transmitting duration.  
 5. For the transmitting duration, please refer to clause 7.1.  
 6. Filter losses were only considered in the spurious frequency bands and the authorized band was not corrected for High Pass Filter losses.  
 7. Proper operation of the transmitter prior to adding the filter to the measurement chain.  
 8. Since non-restricted band peak emissions are less than the average limit, they also comply with the -27dBm/MHz (68.2dBuV/m) limit.

### HARMONICS AND SPURIOUS EMISSIONS (LOW CHANNEL, VERTICAL)

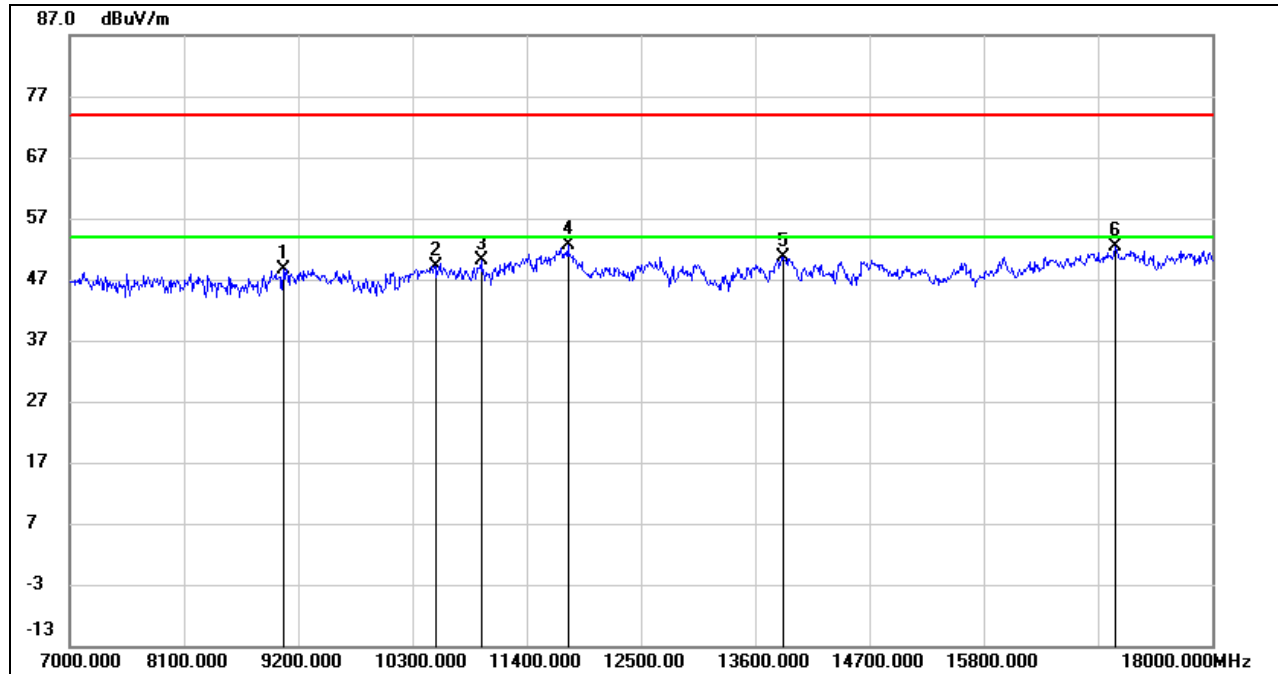

No.	Frequency (MHz)	Reading (dBuV)	Correct (dB/m)	Result (dBuV/m)	Limit (dBuV/m)	Margin (dB)	Remark
1	9057.000	37.35	11.40	48.75	74.00	-25.25	peak
2	10520.000	35.87	13.17	49.04	74.00	-24.96	peak
3	10960.000	35.87	14.31	50.18	74.00	-23.82	peak
4	11796.000	35.97	16.69	52.66	74.00	-21.34	peak
5	13864.000	32.62	18.03	50.65	74.00	-23.35	peak
6	17065.000	30.58	21.73	52.31	74.00	-21.69	peak

- Note:
1. Measurement = Reading Level + Correct Factor.
  2. If Peak Result complies with AV limit, AV Result is deemed to comply with AV limit.
  3. Peak: Peak detector.
  4. AVG:  $VBW=1/Ton$ , where: Ton is the transmitting duration.
  5. For the transmitting duration, please refer to clause 7.1.
  6. Filter losses were only considered in the spurious frequency bands and the authorized band was not corrected for High Pass Filter losses.
  7. Proper operation of the transmitter prior to adding the filter to the measurement chain.
  8. Since non-restricted band peak emissions are less than the average limit, they also comply with the -27dBm/MHz (68.2dBuV/m) limit.

### HARMONICS AND SPURIOUS EMISSIONS (HIGH CHANNEL, HORIZONTAL)

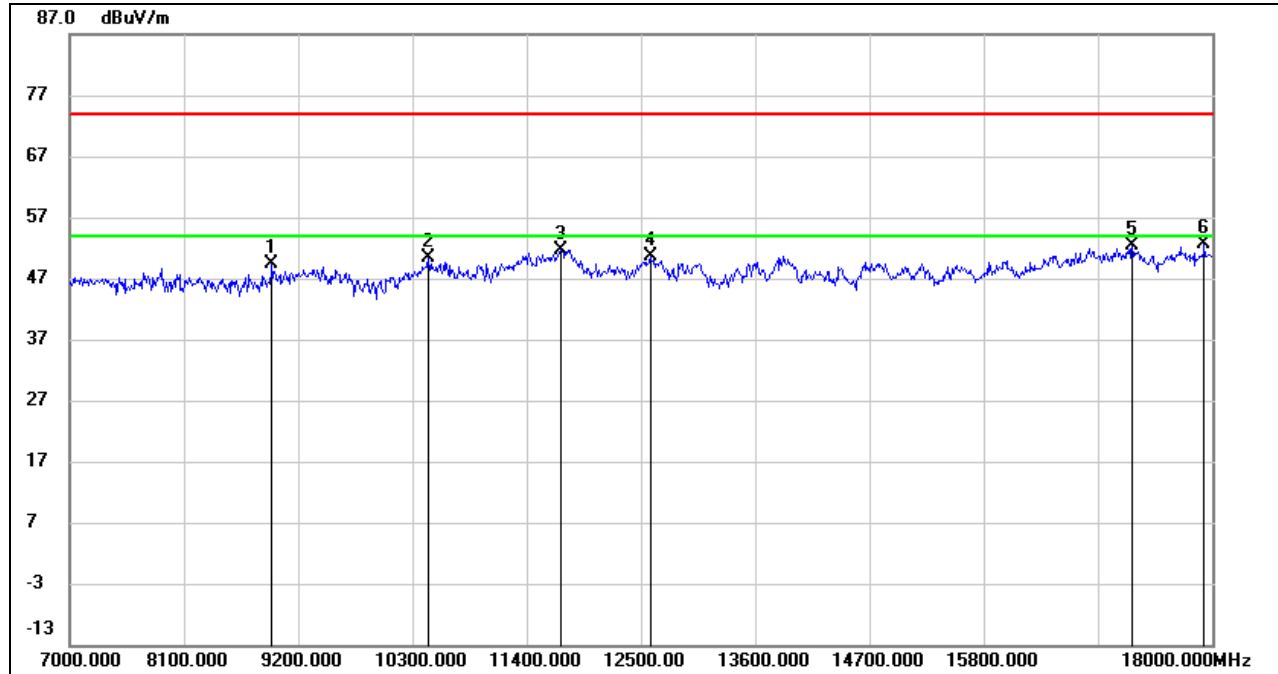

No.	Frequency (MHz)	Reading (dBuV)	Correct (dB/m)	Result (dBuV/m)	Limit (dBuV/m)	Margin (dB)	Remark
1	8947.000	38.28	11.21	49.49	74.00	-24.51	peak
2	10454.000	37.59	12.88	50.47	74.00	-23.53	peak
3	11730.000	35.24	16.39	51.63	74.00	-22.37	peak
4	12588.000	33.82	16.81	50.63	74.00	-23.37	peak
5	17230.000	30.02	22.37	52.39	74.00	-21.61	peak
6	17923.000	28.75	23.99	52.74	74.00	-21.26	peak

- Note:
1. Measurement = Reading Level + Correct Factor.
  2. If Peak Result complies with AV limit, AV Result is deemed to comply with AV limit.
  3. Peak: Peak detector.
  4. AVG:  $VBW=1/Ton$ , where: Ton is the transmitting duration.
  5. For the transmitting duration, please refer to clause 7.1.
  6. Filter losses were only considered in the spurious frequency bands and the authorized band was not corrected for High Pass Filter losses.
  7. Proper operation of the transmitter prior to adding the filter to the measurement chain.
  8. Since non-restricted band peak emissions are less than the average limit, they also comply with the -27dBm/MHz (68.2dBuV/m) limit.

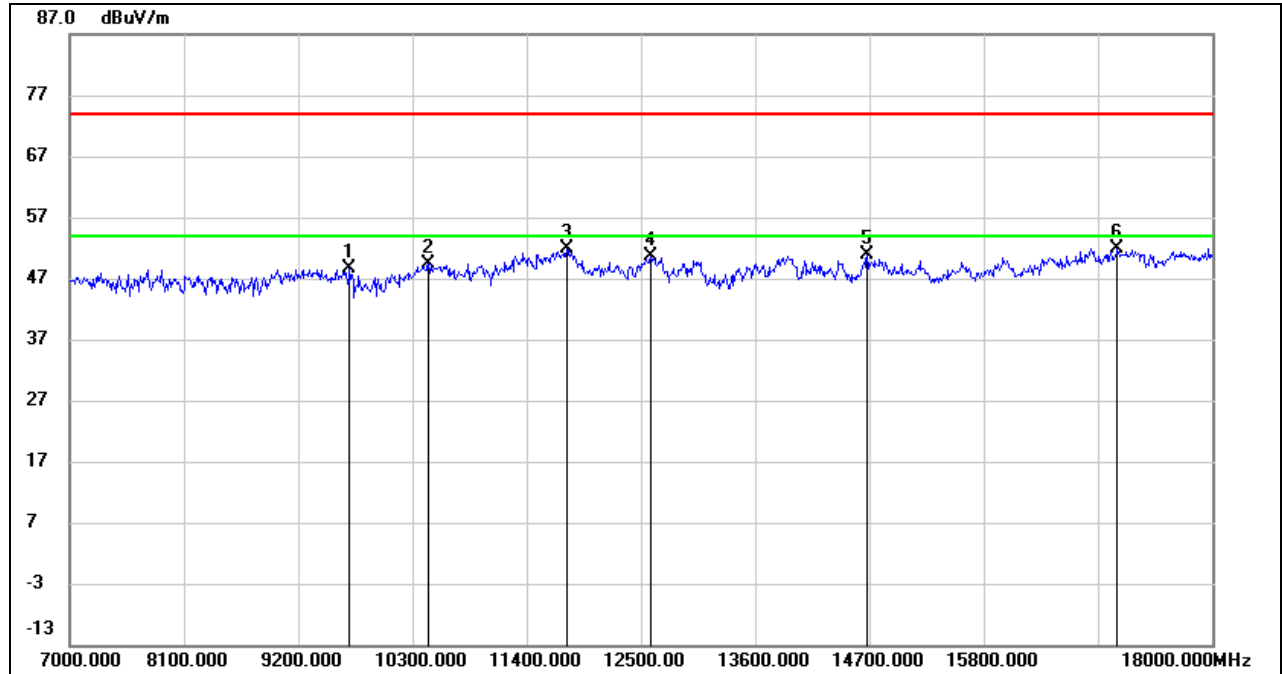

**HARMONICS AND SPURIOUS EMISSIONS (HIGH CHANNEL, VERTICAL)**

No.	Frequency (MHz)	Reading (dBuV)	Correct (dB/m)	Result (dBuV/m)	Limit (dBuV/m)	Margin (dB)	Remark
1	9695.000	37.00	11.59	48.59	74.00	-25.41	peak
2	10454.000	36.54	12.88	49.42	74.00	-24.58	peak
3	11785.000	35.23	16.63	51.86	74.00	-22.14	peak
4	12588.000	33.80	16.81	50.61	74.00	-23.39	peak
5	14678.000	33.09	17.67	50.76	74.00	-23.24	peak
6	17087.000	30.09	21.85	51.94	74.00	-22.06	peak

Note: 1. Measurement = Reading Level + Correct Factor.

2. If Peak Result complies with AV limit, AV Result is deemed to comply with AV limit.

3. Peak: Peak detector.

4. AVG:  $VBW=1/Ton$ , where: Ton is the transmitting duration.

5. For the transmitting duration, please refer to clause 7.1.

6. Filter losses were only considered in the spurious frequency bands and the authorized band was not corrected for High Pass Filter losses.

7. Proper operation of the transmitter prior to adding the filter to the measurement chain.

8. Since non-restricted band peak emissions are less than the average limit, they also comply with the -27dBm/MHz (68.2dBuV/m) limit.

**UNII-2A BAND**

**HARMONICS AND SPURIOUS EMISSIONS (LOW CHANNEL, HORIZONTAL)**

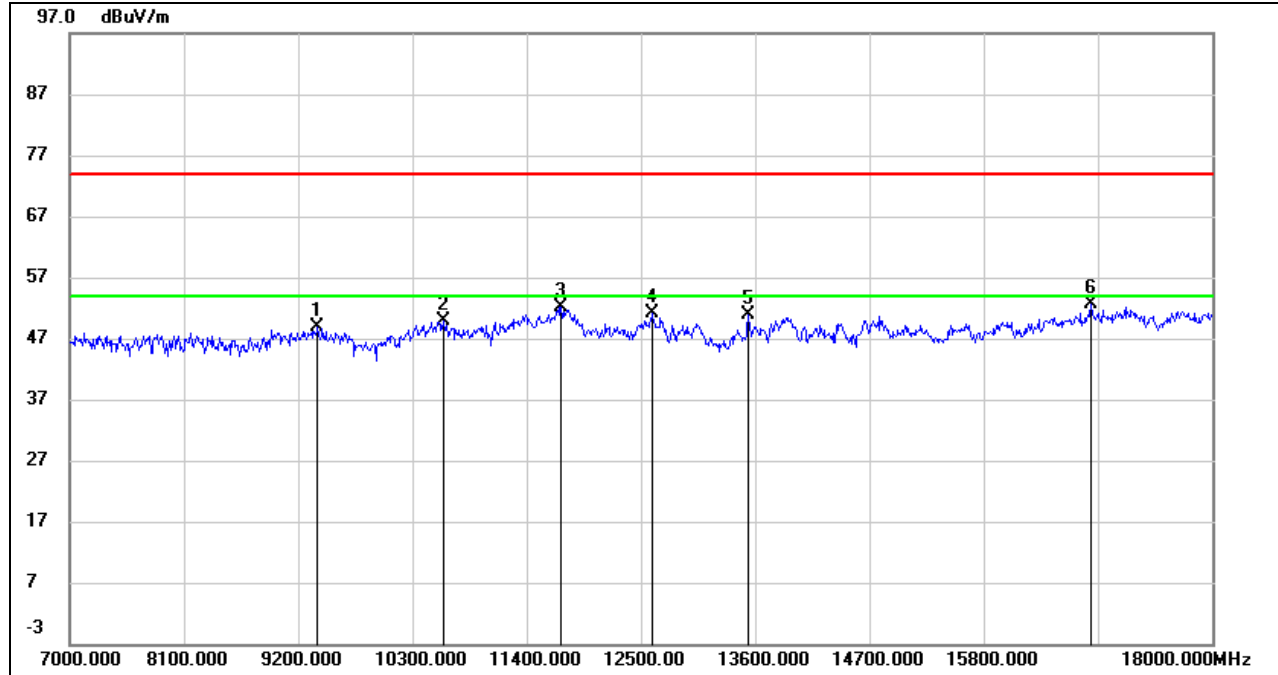

No.	Frequency (MHz)	Reading (dBuV)	Correct (dB/m)	Result (dBuV/m)	Limit (dBuV/m)	Margin (dB)	Remark
1	9387.000	37.39	11.38	48.77	74.00	-25.23	peak
2	10597.000	36.32	13.45	49.77	74.00	-24.23	peak
3	11730.000	35.68	16.39	52.07	74.00	-21.93	peak
4	12610.000	34.27	16.82	51.09	74.00	-22.91	peak
5	13534.000	33.36	17.46	50.82	74.00	-23.18	peak
6	16834.000	31.66	21.06	52.72	74.00	-21.28	peak

- Note:
1. Measurement = Reading Level + Correct Factor.
  2. If Peak Result complies with AV limit, AV Result is deemed to comply with AV limit.
  3. Peak: Peak detector.
  4. AVG:  $VBW=1/Ton$ , where: Ton is the transmitting duration.
  5. For the transmitting duration, please refer to clause 7.1.
  6. Filter losses were only considered in the spurious frequency bands and the authorized band was not corrected for High Pass Filter losses.
  7. Proper operation of the transmitter prior to adding the filter to the measurement chain.
  8. Since non-restricted band peak emissions are less than the average limit, they also comply with the -27dBm/MHz (68.2dBuV/m) limit.



**HARMONICS AND SPURIOUS EMISSIONS (LOW CHANNEL, VERTICAL)**

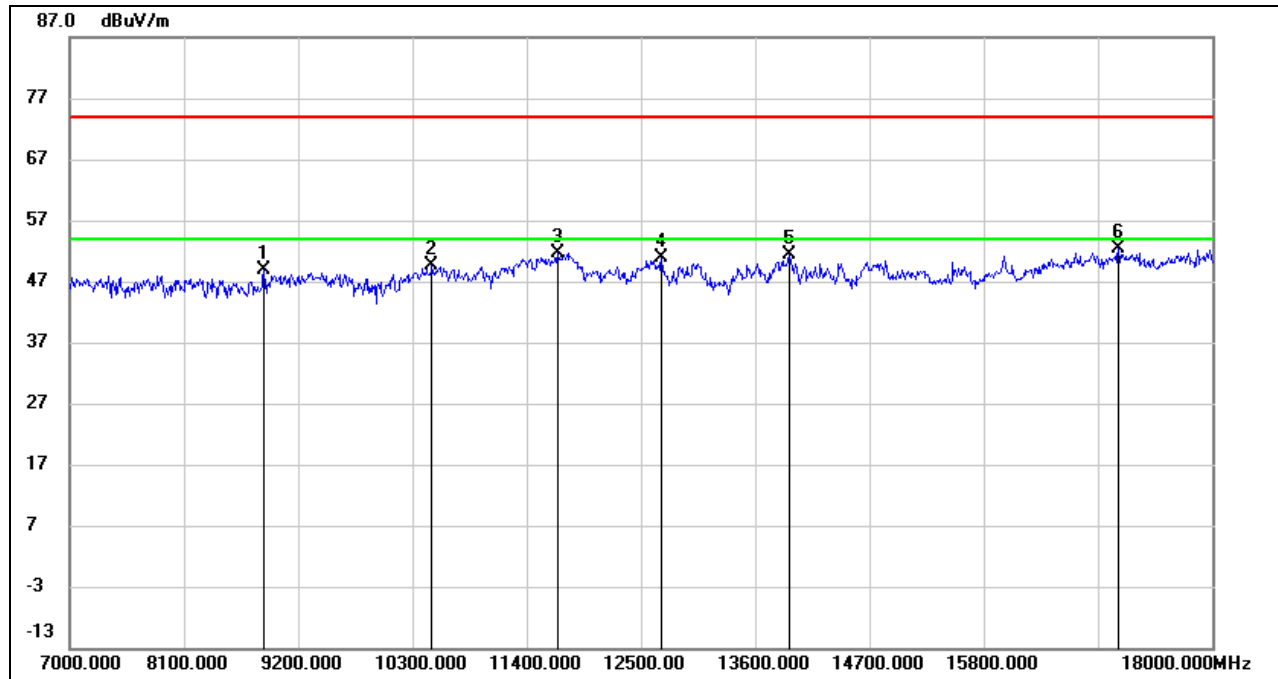

No.	Frequency (MHz)	Reading (dBuV)	Correct (dB/m)	Result (dBuV/m)	Limit (dBuV/m)	Margin (dB)	Remark
1	8870.000	38.45	10.46	48.91	74.00	-25.09	peak
2	10487.000	36.49	13.03	49.52	74.00	-24.48	peak
3	11697.000	35.32	16.24	51.56	74.00	-22.44	peak
4	12698.000	34.09	16.81	50.90	74.00	-23.10	peak
5	13930.000	33.50	17.97	51.47	74.00	-22.53	peak
6	17098.000	30.44	21.91	52.35	74.00	-21.65	peak

- Note:
1. Measurement = Reading Level + Correct Factor.
  2. If Peak Result complies with AV limit, AV Result is deemed to comply with AV limit.
  3. Peak: Peak detector.
  4. AVG:  $VBW=1/Ton$ , where: Ton is the transmitting duration.
  5. For the transmitting duration, please refer to clause 7.1.
  6. Filter losses were only considered in the spurious frequency bands and the authorized band was not corrected for High Pass Filter losses.
  7. Proper operation of the transmitter prior to adding the filter to the measurement chain.
  8. Since non-restricted band peak emissions are less than the average limit, they also comply with the -27dBm/MHz (68.2dBuV/m) limit.



**HARMONICS AND SPURIOUS EMISSIONS (HIGH CHANNEL, HORIZONTAL)**

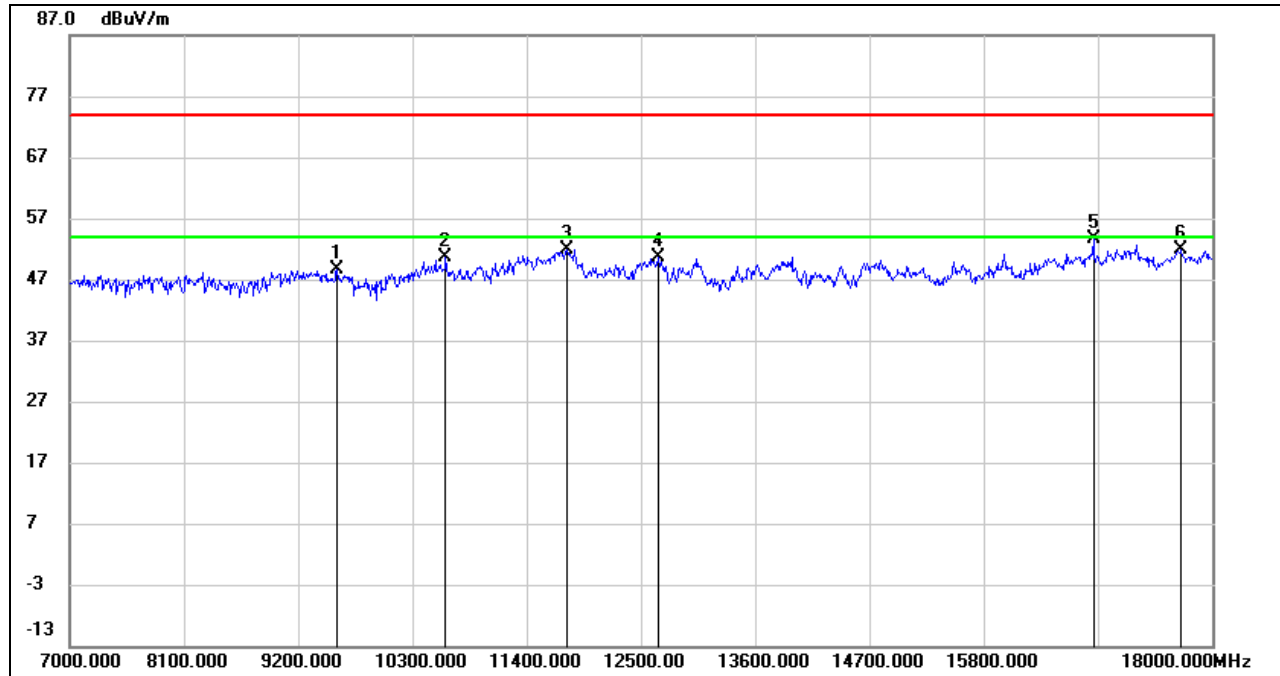

No.	Frequency (MHz)	Reading (dBuV)	Correct (dB/m)	Result (dBuV/m)	Limit (dBuV/m)	Margin (dB)	Remark
1	9574.000	36.73	11.90	48.63	74.00	-25.37	peak
2	10619.000	37.20	13.50	50.70	74.00	-23.30	peak
3	11785.000	35.35	16.63	51.98	74.00	-22.02	peak
4	12665.000	33.87	16.82	50.69	74.00	-23.31	peak
5	16856.000	32.46	21.10	53.56	74.00	-20.44	peak
6	17703.000	28.67	23.27	51.94	74.00	-22.06	peak

- Note: 1. Measurement = Reading Level + Correct Factor.  
 2. If Peak Result complies with AV limit, AV Result is deemed to comply with AV limit.  
 3. Peak: Peak detector.  
 4. AVG:  $VBW=1/Ton$ , where: Ton is the transmitting duration.  
 5. For the transmitting duration, please refer to clause 7.1.  
 6. Filter losses were only considered in the spurious frequency bands and the authorized band was not corrected for High Pass Filter losses.  
 7. Proper operation of the transmitter prior to adding the filter to the measurement chain.  
 8. Since non-restricted band peak emissions are less than the average limit, they also comply with the -27dBm/MHz (68.2dBuV/m) limit.

**HARMONICS AND SPURIOUS EMISSIONS (HIGH CHANNEL, VERTICAL)**

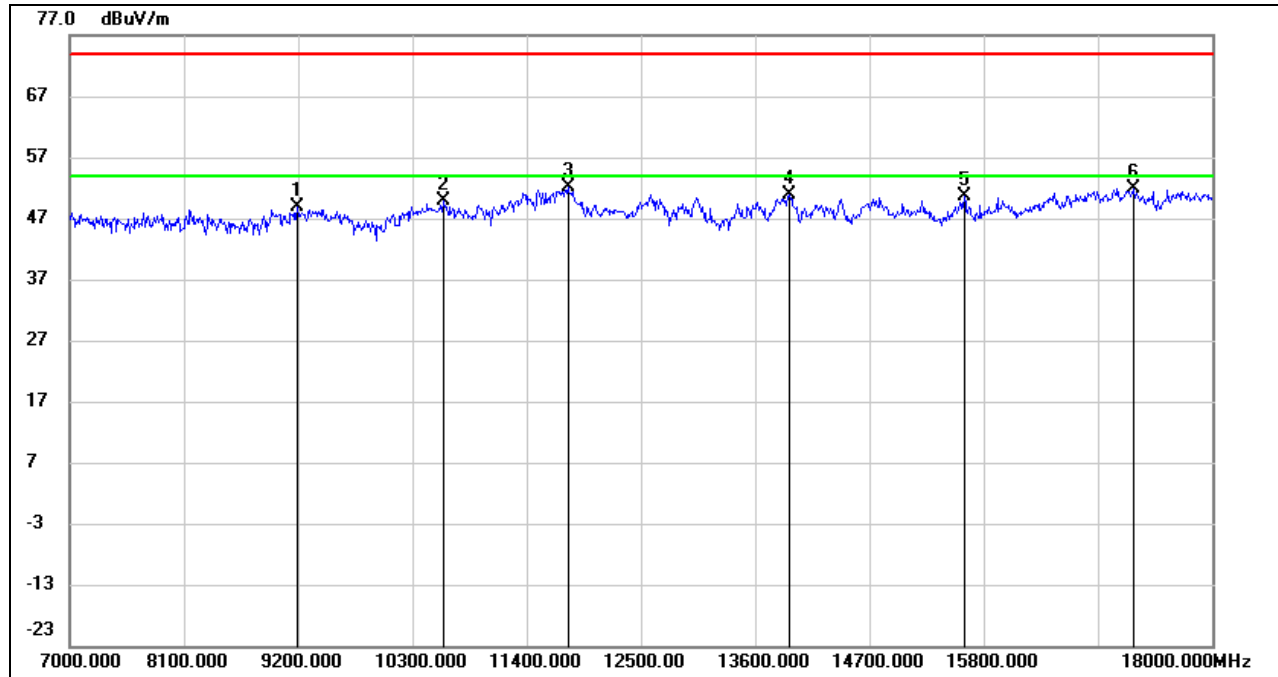

No.	Frequency (MHz)	Reading (dBuV)	Correct (dB/m)	Result (dBuV/m)	Limit (dBuV/m)	Margin (dB)	Remark
1	9189.000	38.13	10.63	48.76	74.00	-25.24	peak
2	10597.000	36.48	13.45	49.93	74.00	-24.07	peak
3	11796.000	35.34	16.69	52.03	74.00	-21.97	peak
4	13930.000	33.01	17.97	50.98	74.00	-23.02	peak
5	15613.000	32.73	17.93	50.66	74.00	-23.34	peak
6	17241.000	29.47	22.34	51.81	74.00	-22.19	peak

Note: 1. Measurement = Reading Level + Correct Factor.  
 2. If Peak Result complies with AV limit, AV Result is deemed to comply with AV limit.  
 3. Peak: Peak detector.  
 4. AVG:  $VBW=1/Ton$ , where: Ton is the transmitting duration.  
 5. For the transmitting duration, please refer to clause 7.1.  
 6. Filter losses were only considered in the spurious frequency bands and the authorized band was not corrected for High Pass Filter losses.  
 7. Proper operation of the transmitter prior to adding the filter to the measurement chain.  
 8. Since non-restricted band peak emissions are less than the average limit, they also comply with the -27dBm/MHz (68.2dBuV/m) limit.



**UNII-2C BAND**

**HARMONICS AND SPURIOUS EMISSIONS (LOW CHANNEL, HORIZONTAL)**

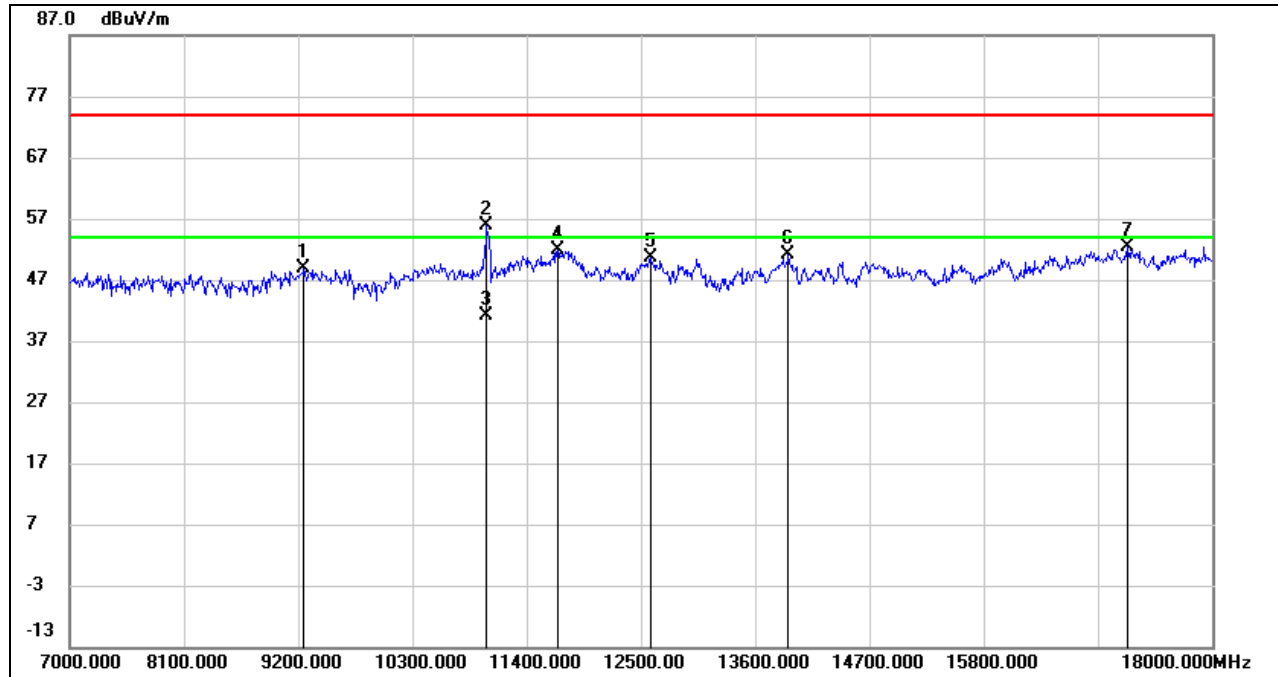

No.	Frequency (MHz)	Reading (dBuV)	Correct (dB/m)	Result (dBuV/m)	Limit (dBuV/m)	Margin (dB)	Remark
1	9255.000	38.00	10.80	48.80	74.00	-25.20	peak
2	11015.000	41.43	14.45	55.88	74.00	-18.12	peak
3	11015.000	26.70	14.45	41.15	54.00	-12.85	AVG
4	11697.000	35.63	16.24	51.87	74.00	-22.13	peak
5	12588.000	33.90	16.81	50.71	74.00	-23.29	peak
6	13919.000	33.04	17.97	51.01	74.00	-22.99	peak
7	17186.000	30.07	22.39	52.46	74.00	-21.54	peak

- Note:
1. Measurement = Reading Level + Correct Factor.
  2. If Peak Result complies with AV limit, AV Result is deemed to comply with AV limit.
  3. Peak: Peak detector.
  4. AVG: VBW=1/Ton, where: Ton is the transmitting duration.
  5. For the transmitting duration, please refer to clause 7.1.
  6. Filter losses were only considered in the spurious frequency bands and the authorized band was not corrected for High Pass Filter losses.
  7. Proper operation of the transmitter prior to adding the filter to the measurement chain.
  8. Since non-restricted band peak emissions are less than the average limit, they also comply with the -27dBm/MHz (68.2dBuV/m) limit.

**HARMONICS AND SPURIOUS EMISSIONS (LOW CHANNEL, VERTICAL)**

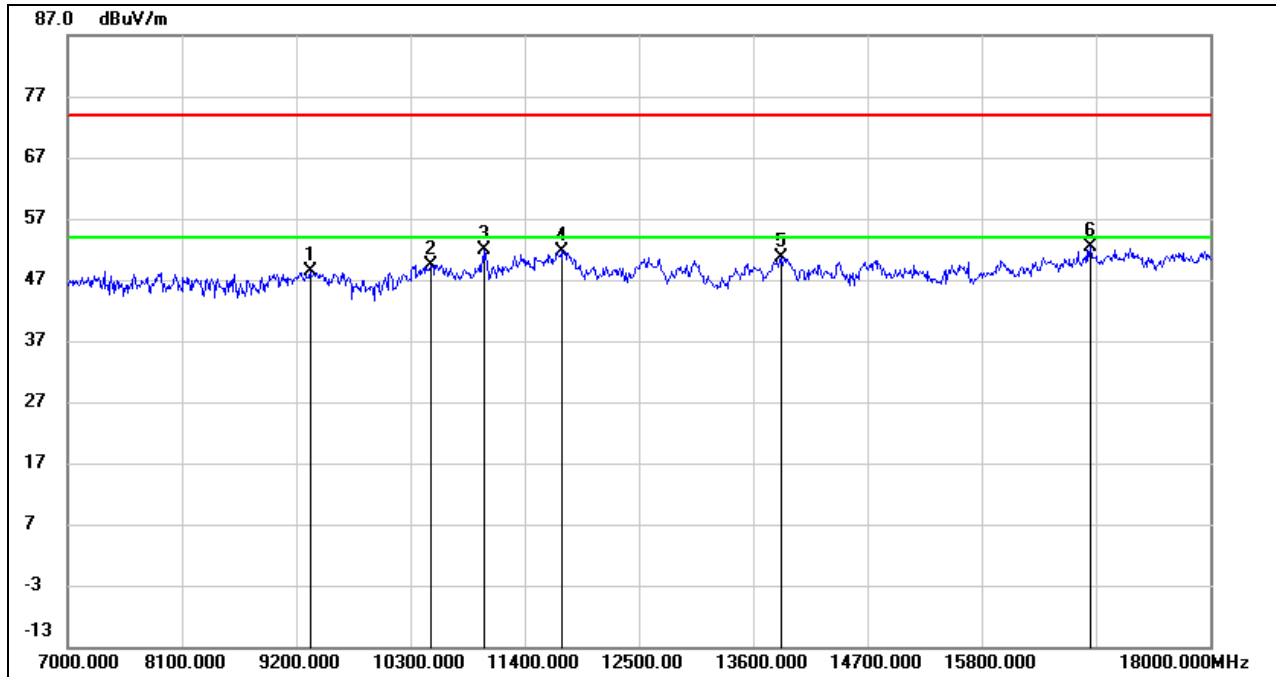

No.	Frequency (MHz)	Reading (dBuV)	Correct (dB/m)	Result (dBuV/m)	Limit (dBuV/m)	Margin (dB)	Remark
1	9332.000	37.18	11.15	48.33	74.00	-25.67	peak
2	10498.000	36.36	13.08	49.44	74.00	-24.56	peak
3	11015.000	37.45	14.45	51.90	74.00	-22.10	peak
4	11763.000	35.22	16.53	51.75	74.00	-22.25	peak
5	13864.000	32.61	18.03	50.64	74.00	-23.36	peak
6	16845.000	31.40	21.09	52.49	74.00	-21.51	peak

- Note:
1. Measurement = Reading Level + Correct Factor.
  2. If Peak Result complies with AV limit, AV Result is deemed to comply with AV limit.
  3. Peak: Peak detector.
  4. AVG:  $VBW=1/Ton$ , where: Ton is the transmitting duration.
  5. For the transmitting duration, please refer to clause 7.1.
  6. Filter losses were only considered in the spurious frequency bands and the authorized band was not corrected for High Pass Filter losses.
  7. Proper operation of the transmitter prior to adding the filter to the measurement chain.
  8. Since non-restricted band peak emissions are less than the average limit, they also comply with the -27dBm/MHz (68.2dBuV/m) limit.



**HARMONICS AND SPURIOUS EMISSIONS (MID CHANNEL, HORIZONTAL)**

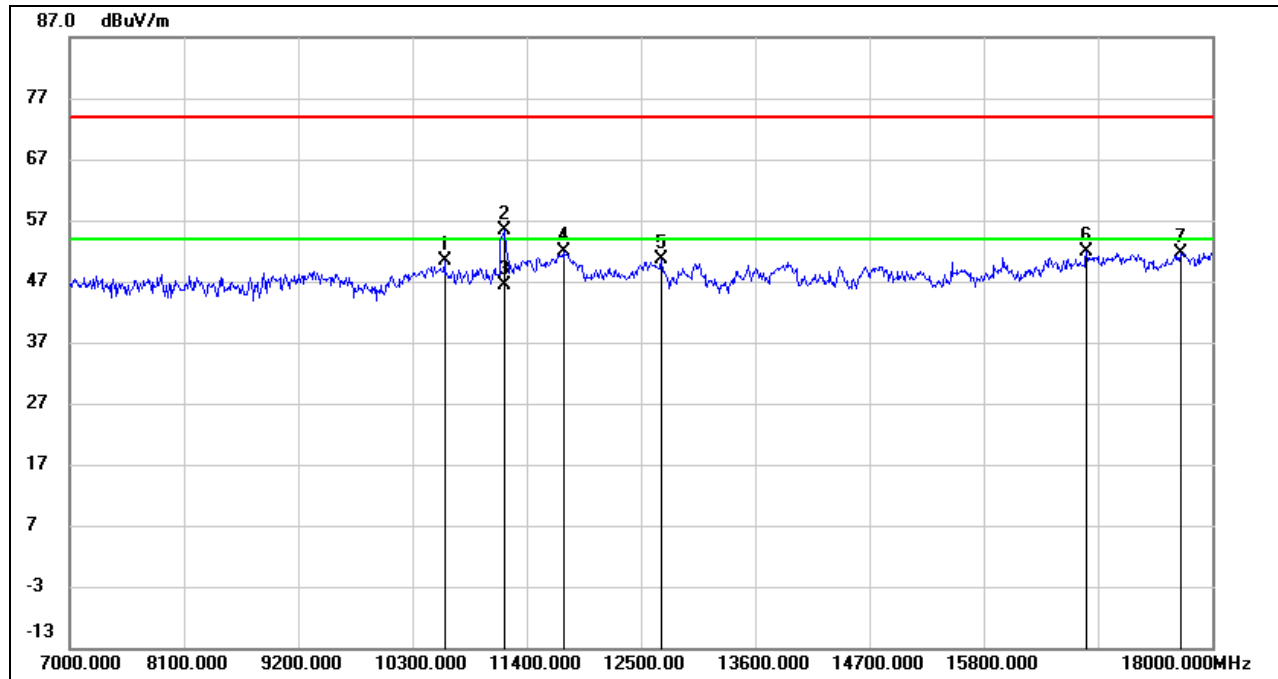

No.	Frequency (MHz)	Reading (dBuV)	Correct (dB/m)	Result (dBuV/m)	Limit (dBuV/m)	Margin (dB)	Remark
1	10608.000	36.89	13.47	50.36	74.00	-23.64	peak
2	11180.000	40.53	14.87	55.40	74.00	-18.60	peak
3	11180.000	31.51	14.87	46.38	54.00	-7.62	AVG
4	11763.000	35.31	16.53	51.84	74.00	-22.16	peak
5	12698.000	33.70	16.81	50.51	74.00	-23.49	peak
6	16790.000	30.80	20.99	51.79	74.00	-22.21	peak
7	17703.000	28.37	23.27	51.64	74.00	-22.36	peak

- Note: 1. Measurement = Reading Level + Correct Factor.  
 2. If Peak Result complies with AV limit, AV Result is deemed to comply with AV limit.  
 3. Peak: Peak detector.  
 4. AVG:  $VBW=1/Ton$ , where: Ton is the transmitting duration.  
 5. For the transmitting duration, please refer to clause 7.1.  
 6. Filter losses were only considered in the spurious frequency bands and the authorized band was not corrected for High Pass Filter losses.  
 7. Proper operation of the transmitter prior to adding the filter to the measurement chain.  
 8. Since non-restricted band peak emissions are less than the average limit, they also comply with the -27dBm/MHz (68.2dBuV/m) limit.



**HARMONICS AND SPURIOUS EMISSIONS (MID CHANNEL, VERTICAL)**

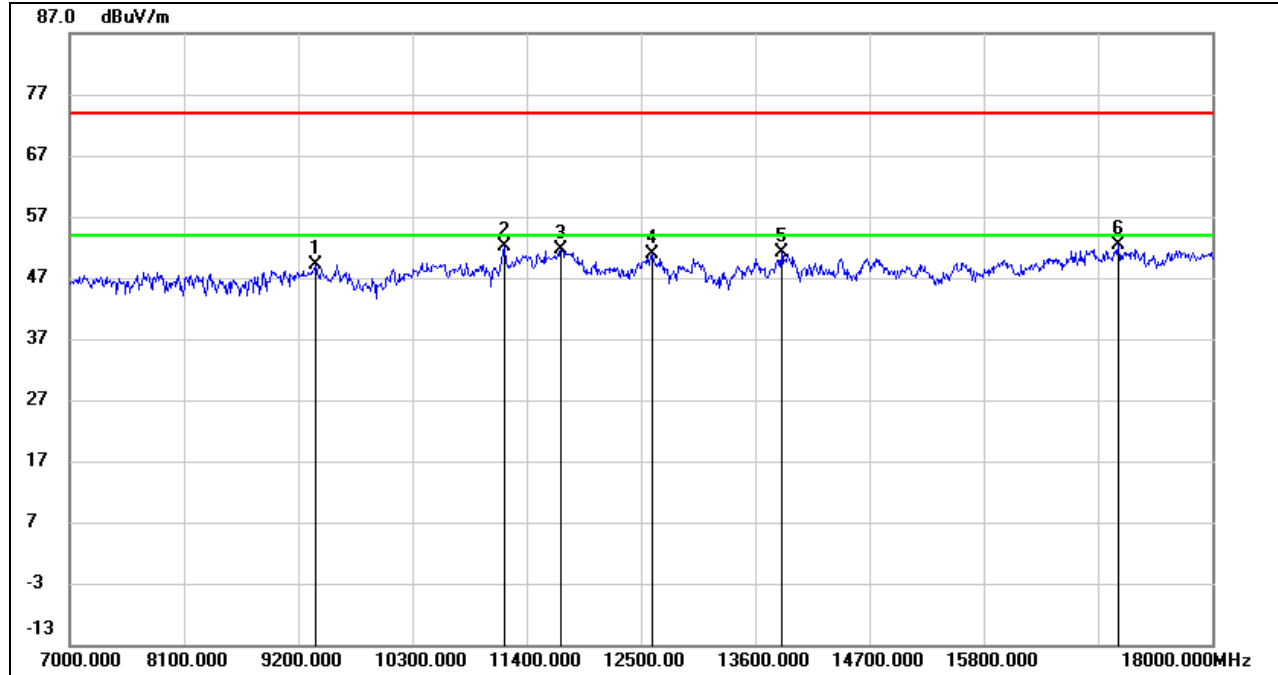

No.	Frequency (MHz)	Reading (dBuV)	Correct (dB/m)	Result (dBuV/m)	Limit (dBuV/m)	Margin (dB)	Remark
1	9365.000	37.76	11.29	49.05	74.00	-24.95	peak
2	11180.000	37.29	14.87	52.16	74.00	-21.84	peak
3	11730.000	35.29	16.39	51.68	74.00	-22.32	peak
4	12610.000	34.17	16.82	50.99	74.00	-23.01	peak
5	13853.000	33.15	18.05	51.20	74.00	-22.80	peak
6	17098.000	30.40	21.91	52.31	74.00	-21.69	peak

- Note:
1. Measurement = Reading Level + Correct Factor.
  2. If Peak Result complies with AV limit, AV Result is deemed to comply with AV limit.
  3. Peak: Peak detector.
  4. AVG:  $VBW=1/Ton$ , where: Ton is the transmitting duration.
  5. For the transmitting duration, please refer to clause 7.1.
  6. Filter losses were only considered in the spurious frequency bands and the authorized band was not corrected for High Pass Filter losses.
  7. Proper operation of the transmitter prior to adding the filter to the measurement chain.
  8. Since non-restricted band peak emissions are less than the average limit, they also comply with the -27dBm/MHz (68.2dBuV/m) limit.



**HARMONICS AND SPURIOUS EMISSIONS (HIGH CHANNEL, HORIZONTAL)**

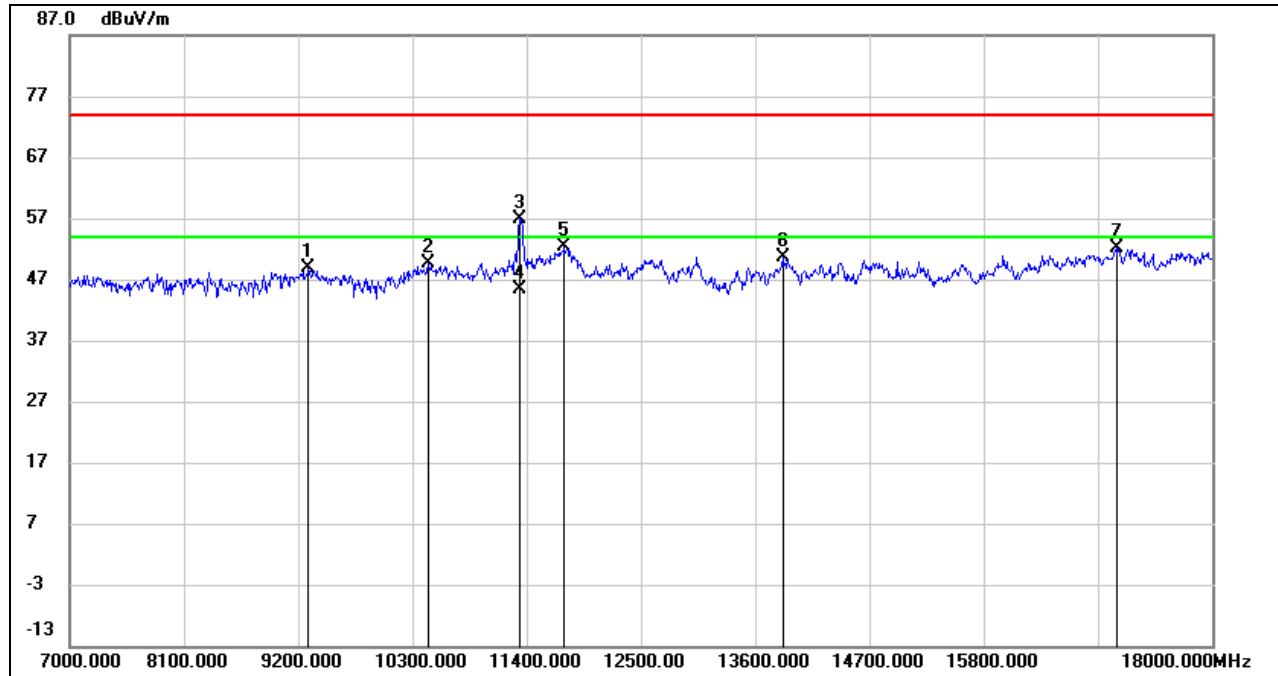

No.	Frequency (MHz)	Reading (dBuV)	Correct (dB/m)	Result (dBuV/m)	Limit (dBuV/m)	Margin (dB)	Remark
1	9299.000	37.97	11.00	48.97	74.00	-25.03	peak
2	10454.000	36.74	12.88	49.62	74.00	-24.38	peak
3	11334.000	41.73	15.26	56.99	74.00	-17.01	peak
4	11334.000	30.02	15.26	45.28	54.00	-8.72	AVG
5	11763.000	35.80	16.53	52.33	74.00	-21.67	peak
6	13864.000	32.49	18.03	50.52	74.00	-23.48	peak
7	17076.000	30.43	21.79	52.22	74.00	-21.78	peak

- Note: 1. Measurement = Reading Level + Correct Factor.  
 2. If Peak Result complies with AV limit, AV Result is deemed to comply with AV limit.  
 3. Peak: Peak detector.  
 4. AVG:  $VBW=1/Ton$ , where: Ton is the transmitting duration.  
 5. For the transmitting duration, please refer to clause 7.1.  
 6. Filter losses were only considered in the spurious frequency bands and the authorized band was not corrected for High Pass Filter losses.  
 7. Proper operation of the transmitter prior to adding the filter to the measurement chain.  
 8. Since non-restricted band peak emissions are less than the average limit, they also comply with the -27dBm/MHz (68.2dBuV/m) limit.

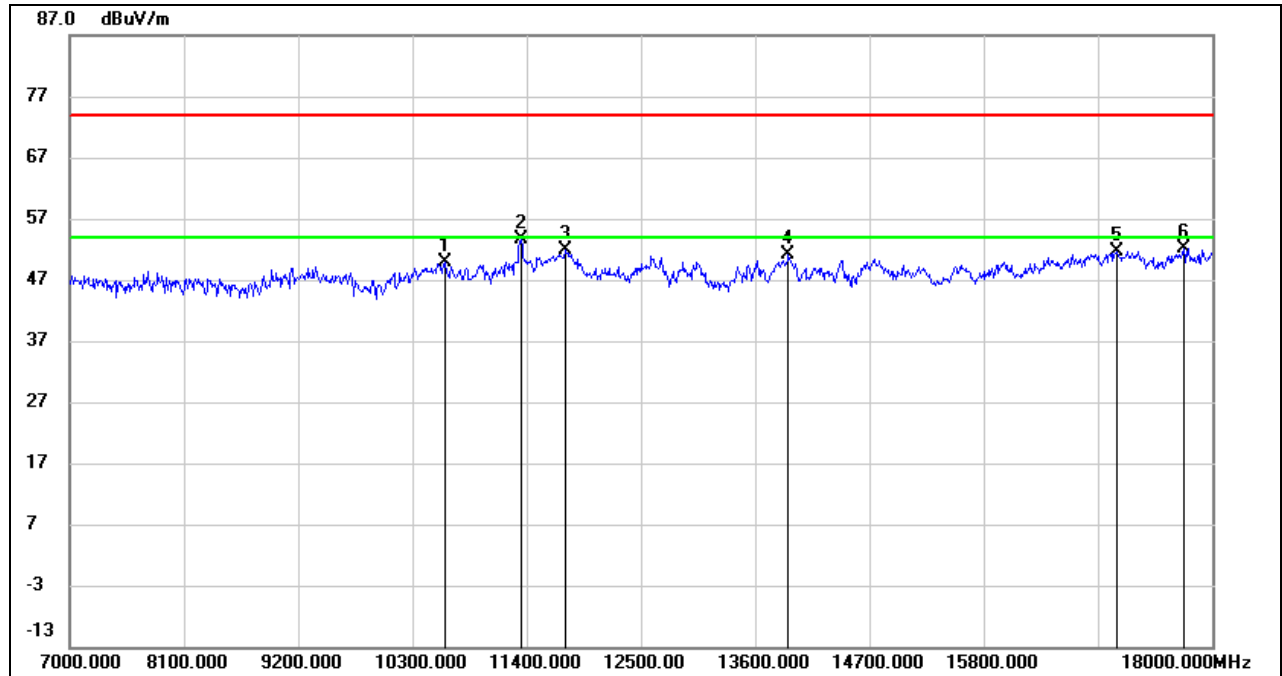
**HARMONICS AND SPURIOUS EMISSIONS (HIGH CHANNEL, VERTICAL)**

No.	Frequency (MHz)	Reading (dBuV)	Correct (dB/m)	Result (dBuV/m)	Limit (dBuV/m)	Margin (dB)	Remark
1	10608.000	36.53	13.47	50.00	74.00	-24.00	peak
2	11345.000	38.37	15.29	53.66	74.00	-20.34	peak
3	11774.000	35.29	16.58	51.87	74.00	-22.13	peak
4	13919.000	33.12	17.97	51.09	74.00	-22.91	peak
5	17087.000	29.74	21.85	51.59	74.00	-22.41	peak
6	17725.000	28.83	23.42	52.25	74.00	-21.75	peak

- Note: 1. Measurement = Reading Level + Correct Factor.  
2. If Peak Result complies with AV limit, AV Result is deemed to comply with AV limit.  
3. Peak: Peak detector.  
4. AVG:  $VBW=1/Ton$ , where: Ton is the transmitting duration.  
5. For the transmitting duration, please refer to clause 7.1.  
6. Filter losses were only considered in the spurious frequency bands and the authorized band was not corrected for High Pass Filter losses.  
7. Proper operation of the transmitter prior to adding the filter to the measurement chain.  
8. Since non-restricted band peak emissions are less than the average limit, they also comply with the -27dBm/MHz (68.2dBuV/m) limit.

**STRADDLE CHANNEL 142**

**HARMONICS AND SPURIOUS EMISSIONS (HORIZONTAL)**

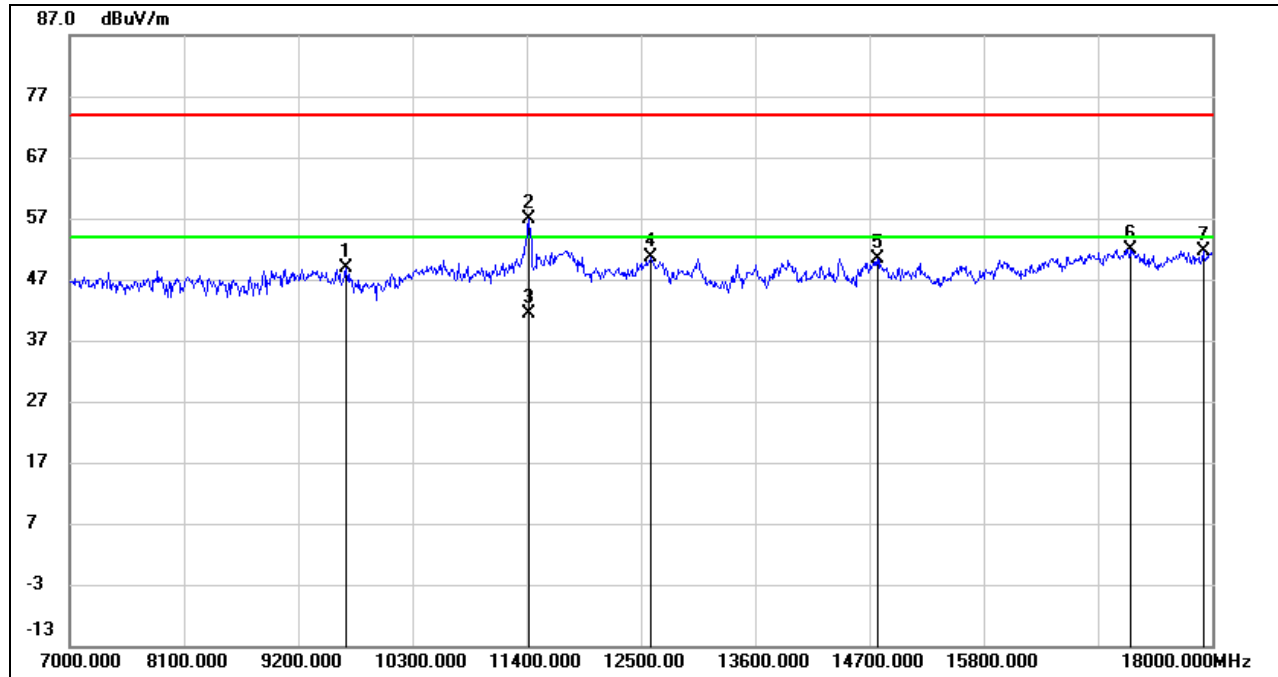

No.	Frequency (MHz)	Reading (dBuV)	Correct (dB/m)	Result (dBuV/m)	Limit (dBuV/m)	Margin (dB)	Remark
1	9662.000	37.12	11.72	48.84	74.00	-25.16	peak
2	11422.000	41.48	15.47	56.95	74.00	-17.05	peak
3	11422.000	25.84	15.47	41.31	54.00	-12.69	AVG
4	12588.000	33.84	16.81	50.65	74.00	-23.35	peak
5	14777.000	32.52	17.79	50.31	74.00	-23.69	peak
6	17208.000	29.46	22.45	51.91	74.00	-22.09	peak
7	17912.000	27.61	23.99	51.60	74.00	-22.40	peak

Note: 1. Measurement = Reading Level + Correct Factor.  
 2. If Peak Result complies with AV limit, AV Result is deemed to comply with AV limit.  
 3. Peak: Peak detector.  
 4. AVG:  $VBW=1/Ton$ , where:  $Ton$  is the transmitting duration.  
 5. For the transmitting duration, please refer to clause 7.1.  
 6. Filter losses were only considered in the spurious frequency bands and the authorized band was not corrected for High Pass Filter losses.  
 7. Proper operation of the transmitter prior to adding the filter to the measurement chain.  
 8. Since non-restricted band peak emissions are less than the average limit, they also comply with the  $-27dBm/MHz$  ( $68.2dBuV/m$ ) limit.

**HARMONICS AND SPURIOUS EMISSIONS (VERTICAL)**

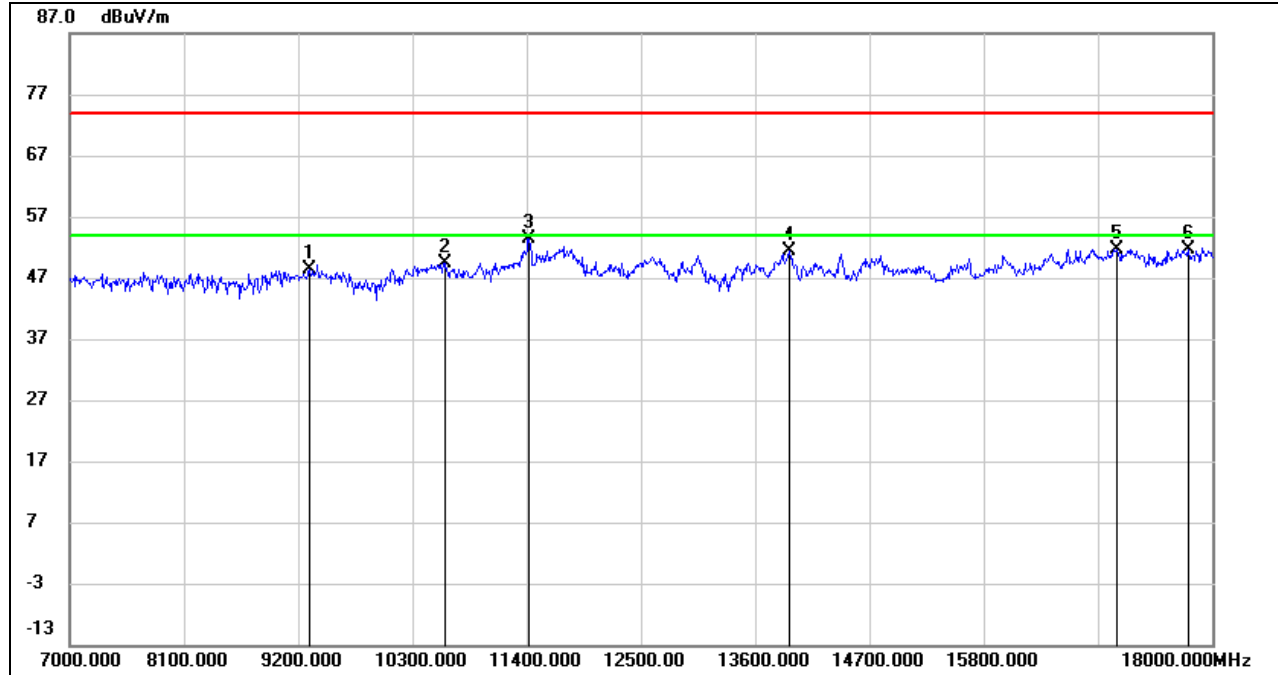

No.	Frequency (MHz)	Reading (dBuV)	Correct (dB/m)	Result (dBuV/m)	Limit (dBuV/m)	Margin (dB)	Remark
1	9310.000	37.33	11.05	48.38	74.00	-25.62	peak
2	10608.000	35.91	13.47	49.38	74.00	-24.62	peak
3	11422.000	37.95	15.47	53.42	74.00	-20.58	peak
4	13930.000	33.29	17.97	51.26	74.00	-22.74	peak
5	17087.000	29.71	21.85	51.56	74.00	-22.44	peak
6	17769.000	28.01	23.73	51.74	74.00	-22.26	peak

- Note: 1. Measurement = Reading Level + Correct Factor.  
 2. If Peak Result complies with AV limit, AV Result is deemed to comply with AV limit.  
 3. Peak: Peak detector.  
 4. AVG:  $VBW=1/Ton$ , where: Ton is the transmitting duration.  
 5. For the transmitting duration, please refer to clause 7.1.  
 6. Filter losses were only considered in the spurious frequency bands and the authorized band was not corrected for High Pass Filter losses.  
 7. Proper operation of the transmitter prior to adding the filter to the measurement chain.  
 8. Since non-restricted band peak emissions are less than the average limit, they also comply with the -27dBm/MHz (68.2dBuV/m) limit.

**UNII-3 BAND**

**HARMONICS AND SPURIOUS EMISSIONS (LOW CHANNEL, HORIZONTAL)**

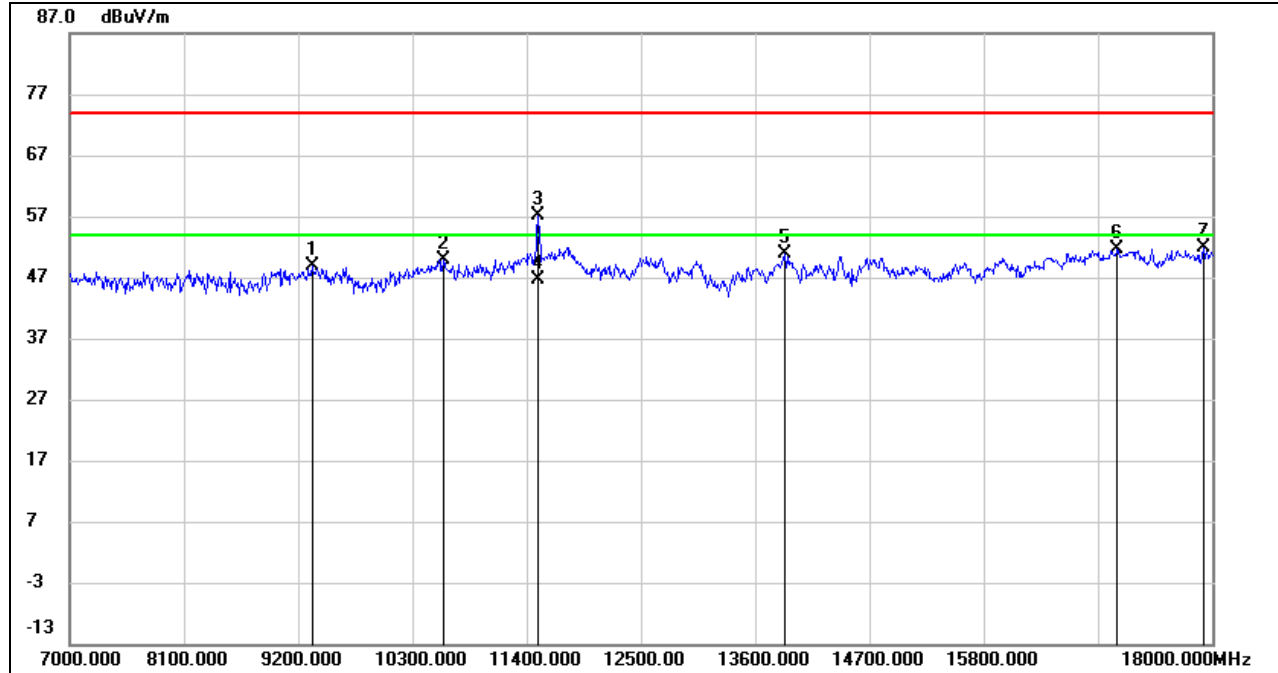

No.	Frequency (MHz)	Reading (dBuV)	Correct (dB/m)	Result (dBuV/m)	Limit (dBuV/m)	Margin (dB)	Remark
1	9332.000	37.79	11.15	48.94	74.00	-25.06	peak
2	10597.000	36.50	13.45	49.95	74.00	-24.05	peak
3	11510.000	41.48	15.62	57.10	74.00	-16.90	peak
4	11510.000	30.89	15.62	46.51	54.00	-7.49	AVG
5	13886.000	32.84	18.02	50.86	74.00	-23.14	peak
6	17087.000	29.78	21.85	51.63	74.00	-22.37	peak
7	17923.000	27.96	23.99	51.95	74.00	-22.05	peak

Note: 1. Measurement = Reading Level + Correct Factor.  
 2. If Peak Result complies with AV limit, AV Result is deemed to comply with AV limit.  
 3. Peak: Peak detector.  
 4. AVG:  $VBW=1/Ton$ , where: Ton is the transmitting duration.  
 5. For the transmitting duration, please refer to clause 7.1.  
 6. Filter losses were only considered in the spurious frequency bands and the authorized band was not corrected for High Pass Filter losses.  
 7. Proper operation of the transmitter prior to adding the filter to the measurement chain.  
 8. Since non-restricted band peak emissions are less than the average limit, they also comply with the -27dBm/MHz (68.2dBuV/m) limit.

**HARMONICS AND SPURIOUS EMISSIONS (LOW CHANNEL, VERTICAL)**

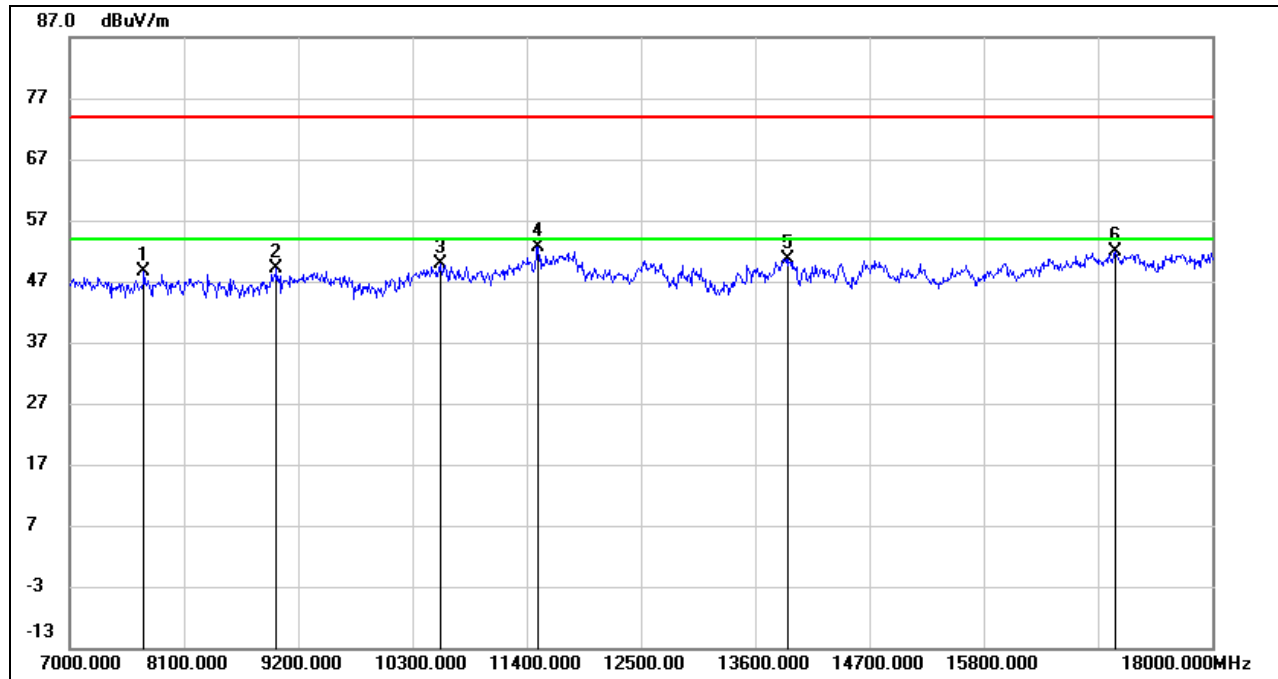

No.	Frequency (MHz)	Reading (dBuV)	Correct (dB/m)	Result (dBuV/m)	Limit (dBuV/m)	Margin (dB)	Remark
1	7715.000	39.45	9.17	48.62	74.00	-25.38	peak
2	8991.000	37.59	11.63	49.22	74.00	-24.78	peak
3	10564.000	36.46	13.33	49.79	74.00	-24.21	peak
4	11510.000	36.94	15.62	52.56	74.00	-21.44	peak
5	13919.000	32.69	17.97	50.66	74.00	-23.34	peak
6	17065.000	30.07	21.73	51.80	74.00	-22.20	peak

- Note: 1. Measurement = Reading Level + Correct Factor.  
 2. If Peak Result complies with AV limit, AV Result is deemed to comply with AV limit.  
 3. Peak: Peak detector.  
 4. AVG:  $VBW=1/Ton$ , where: Ton is the transmitting duration.  
 5. For the transmitting duration, please refer to clause 7.1.  
 6. Filter losses were only considered in the spurious frequency bands and the authorized band was not corrected for High Pass Filter losses.  
 7. Proper operation of the transmitter prior to adding the filter to the measurement chain.  
 8. Since non-restricted band peak emissions are less than the average limit, they also comply with the -27dBm/MHz (68.2dBuV/m) limit.

**HARMONICS AND SPURIOUS EMISSIONS (HIGH CHANNEL, HORIZONTAL)**

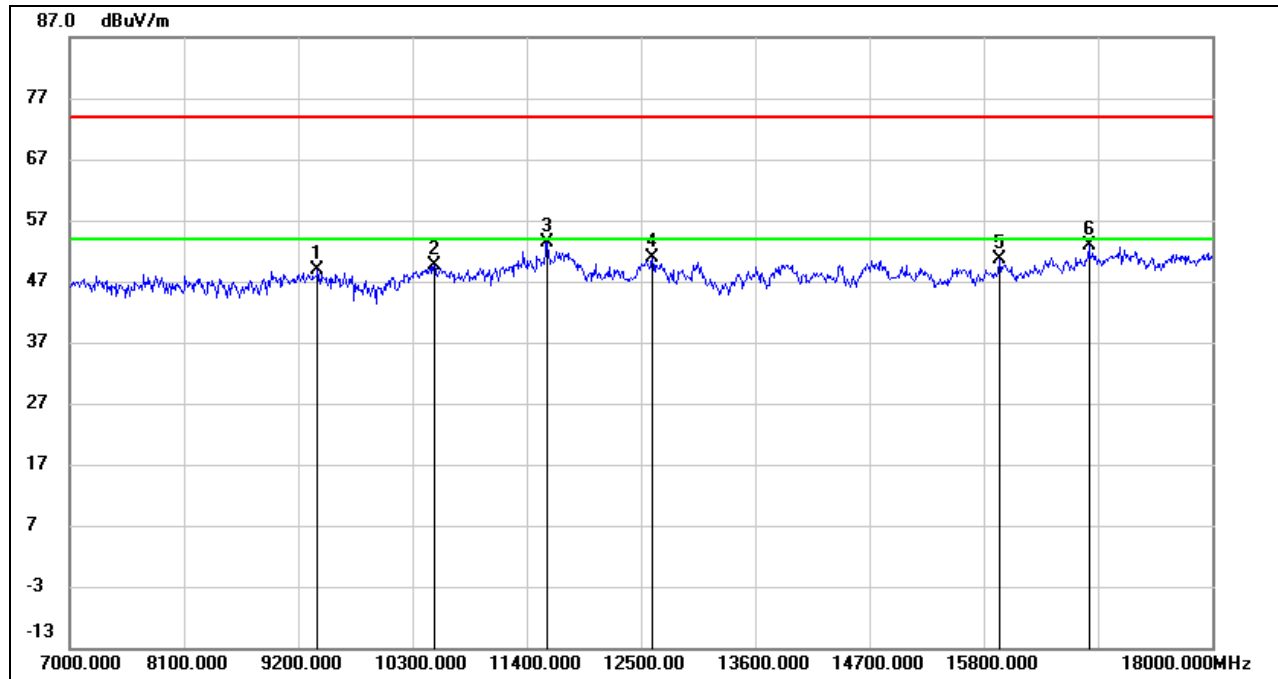

No.	Frequency (MHz)	Reading (dBuV)	Correct (dB/m)	Result (dBuV/m)	Limit (dBuV/m)	Margin (dB)	Remark
1	9387.000	37.51	11.38	48.89	74.00	-25.11	peak
2	10509.000	36.56	13.12	49.68	74.00	-24.32	peak
3	11598.000	37.70	15.79	53.49	74.00	-20.51	peak
4	12610.000	33.97	16.82	50.79	74.00	-23.21	peak
5	15954.000	32.24	18.37	50.61	74.00	-23.39	peak
6	16812.000	31.86	21.02	52.88	74.00	-21.12	peak

Note: 1. Measurement = Reading Level + Correct Factor.  
 2. If Peak Result complies with AV limit, AV Result is deemed to comply with AV limit.  
 3. Peak: Peak detector.  
 4. Filter losses were only considered in the spurious frequency bands and the authorized band was not corrected for High Pass Filter losses.  
 5. Proper operation of the transmitter prior to adding the filter to the measurement chain.  
 6. Since non-restricted band peak emissions are less than the average limit, they also comply with the -27dBm/MHz (68.2dBuV/m) limit.



### HARMONICS AND SPURIOUS EMISSIONS (HIGH CHANNEL, VERTICAL)

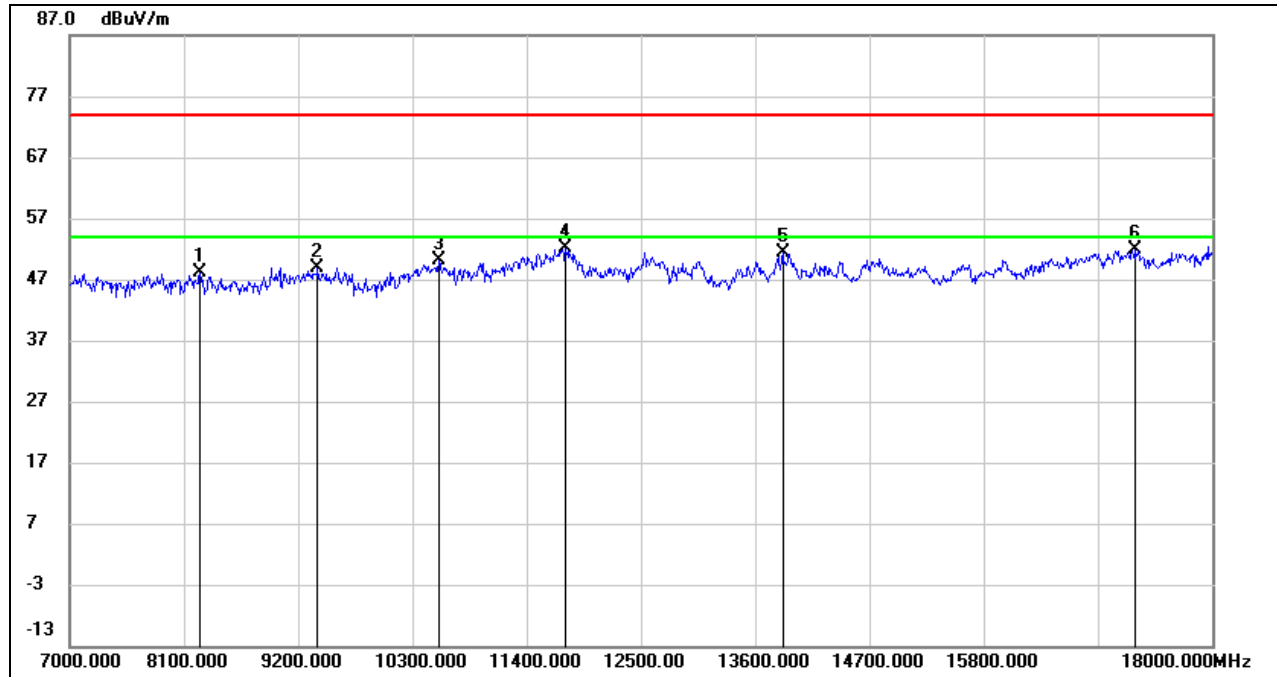

No.	Frequency (MHz)	Reading (dBuV)	Correct (dB/m)	Result (dBuV/m)	Limit (dBuV/m)	Margin (dB)	Remark
1	8254.000	37.82	10.34	48.16	74.00	-25.84	peak
2	9387.000	37.49	11.38	48.87	74.00	-25.13	peak
3	10553.000	36.95	13.28	50.23	74.00	-23.77	peak
4	11774.000	35.62	16.58	52.20	74.00	-21.80	peak
5	13864.000	33.41	18.03	51.44	74.00	-22.56	peak
6	17263.000	29.55	22.28	51.83	74.00	-22.17	peak

- Note:
1. Measurement = Reading Level + Correct Factor.
  2. If Peak Result complies with AV limit, AV Result is deemed to comply with AV limit.
  3. Peak: Peak detector.
  4. AVG:  $VBW=1/Ton$ , where: Ton is the transmitting duration.
  5. For the transmitting duration, please refer to clause 7.1.
  6. Filter losses were only considered in the spurious frequency bands and the authorized band was not corrected for High Pass Filter losses.
  7. Proper operation of the transmitter prior to adding the filter to the measurement chain.
  8. Since non-restricted band peak emissions are less than the average limit, they also comply with the -27dBm/MHz (68.2dBuV/m) limit.

8.3.4. 802.11ax HE20 SISO MODE

UNII-1 BAND

HARMONICS AND SPURIOUS EMISSIONS (LOW CHANNEL, HORIZONTAL)

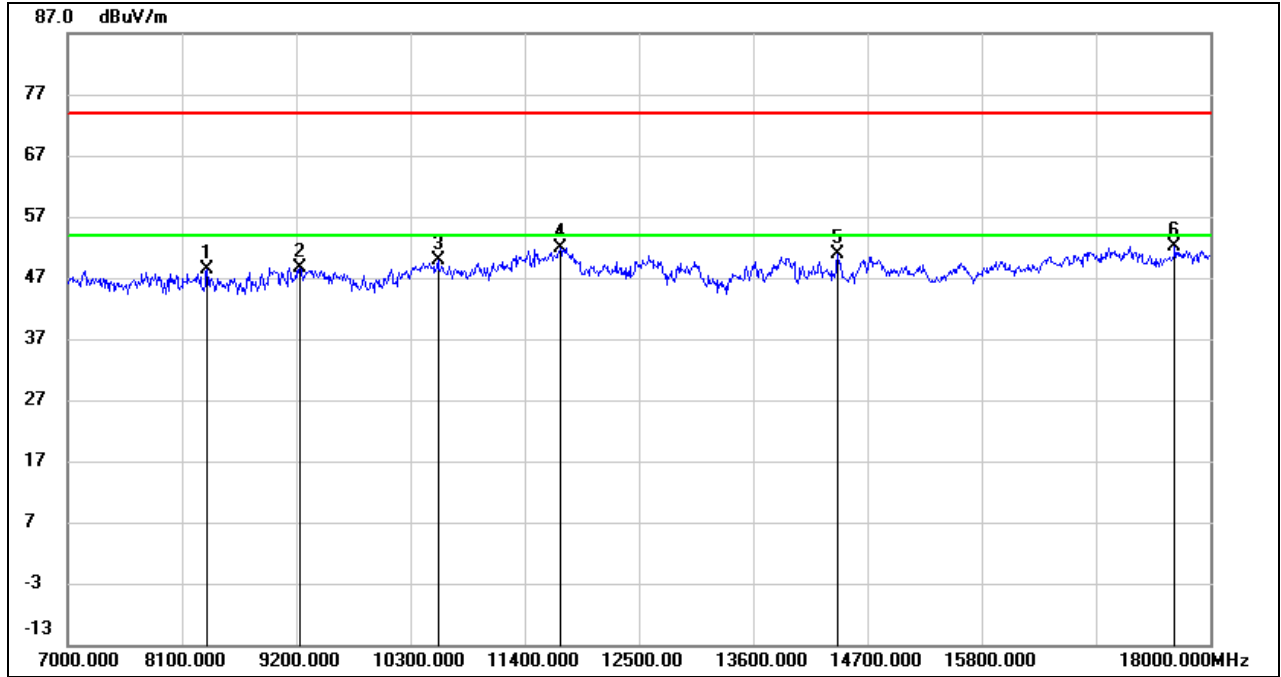

No.	Frequency (MHz)	Reading (dBuV)	Correct (dB/m)	Result (dBuV/m)	Limit (dBuV/m)	Margin (dB)	Remark
1	8342.000	38.45	10.02	48.47	74.00	-25.53	peak
2	9233.000	37.94	10.72	48.66	74.00	-25.34	peak
3	10564.000	36.43	13.33	49.76	74.00	-24.24	peak
4	11741.000	35.43	16.43	51.86	74.00	-22.14	peak
5	14414.000	32.89	17.91	50.80	74.00	-23.20	peak
6	17659.000	29.15	22.97	52.12	74.00	-21.88	peak

- Note: 1. Measurement = Reading Level + Correct Factor.  
 2. If Peak Result complies with AV limit, AV Result is deemed to comply with AV limit.  
 3. Peak: Peak detector.  
 4. AVG:  $VBW=1/Ton$ , where: Ton is the transmitting duration.  
 5. For the transmitting duration, please refer to clause 7.1.  
 6. Filter losses were only considered in the spurious frequency bands and the authorized band was not corrected for High Pass Filter losses.  
 7. Proper operation of the transmitter prior to adding the filter to the measurement chain.  
 8. Since non-restricted band peak emissions are less than the average limit, they also comply with the -27dBm/MHz (68.2dBuV/m) limit.

**HARMONICS AND SPURIOUS EMISSIONS (LOW CHANNEL, VERTICAL)**

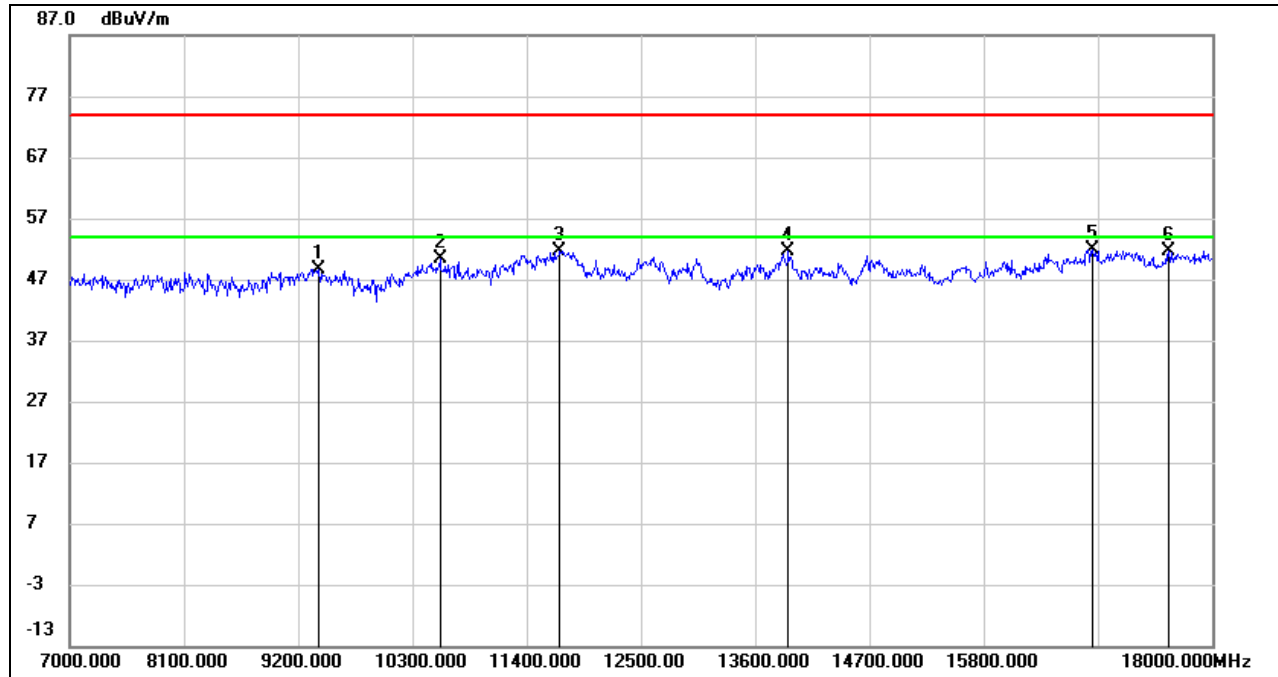

No.	Frequency (MHz)	Reading (dBuV)	Correct (dB/m)	Result (dBuV/m)	Limit (dBuV/m)	Margin (dB)	Remark
1	9398.000	37.22	11.43	48.65	74.00	-25.35	peak
2	10564.000	37.04	13.33	50.37	74.00	-23.63	peak
3	11719.000	35.33	16.34	51.67	74.00	-22.33	peak
4	13919.000	33.63	17.97	51.60	74.00	-22.40	peak
5	16845.000	30.85	21.09	51.94	74.00	-22.06	peak
6	17582.000	29.25	22.48	51.73	74.00	-22.27	peak

- Note: 1. Measurement = Reading Level + Correct Factor.  
 2. If Peak Result complies with AV limit, AV Result is deemed to comply with AV limit.  
 3. Peak: Peak detector.  
 4. AVG:  $VBW=1/Ton$ , where: Ton is the transmitting duration.  
 5. For the transmitting duration, please refer to clause 7.1.  
 6. Filter losses were only considered in the spurious frequency bands and the authorized band was not corrected for High Pass Filter losses.  
 7. Proper operation of the transmitter prior to adding the filter to the measurement chain.  
 8. Since non-restricted band peak emissions are less than the average limit, they also comply with the -27dBm/MHz (68.2dBuV/m) limit.

**HARMONICS AND SPURIOUS EMISSIONS (MID CHANNEL, HORIZONTAL)**

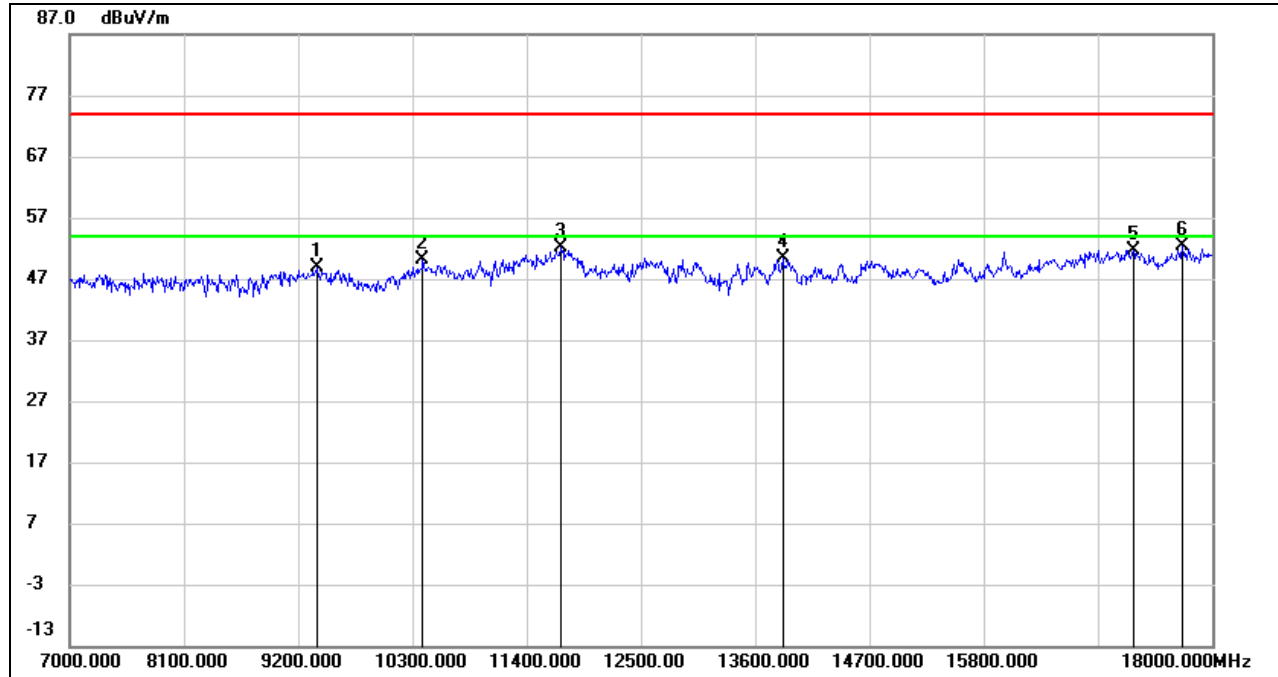

No.	Frequency (MHz)	Reading (dBuV)	Correct (dB/m)	Result (dBuV/m)	Limit (dBuV/m)	Margin (dB)	Remark
1	9376.000	37.45	11.34	48.79	74.00	-25.21	peak
2	10399.000	37.56	12.62	50.18	74.00	-23.82	peak
3	11730.000	35.85	16.39	52.24	74.00	-21.76	peak
4	13864.000	32.31	18.03	50.34	74.00	-23.66	peak
5	17241.000	29.41	22.34	51.75	74.00	-22.25	peak
6	17714.000	28.95	23.34	52.29	74.00	-21.71	peak

Note: 1. Measurement = Reading Level + Correct Factor.  
 2. If Peak Result complies with AV limit, AV Result is deemed to comply with AV limit.  
 3. Peak: Peak detector.  
 4. Filter losses were only considered in the spurious frequency bands and the authorized band was not corrected for High Pass Filter losses.  
 5. Proper operation of the transmitter prior to adding the filter to the measurement chain.  
 6. Since non-restricted band peak emissions are less than the average limit, they also comply with the -27dBm/MHz (68.2dBuV/m) limit.



**HARMONICS AND SPURIOUS EMISSIONS (MID CHANNEL, VERTICAL)**

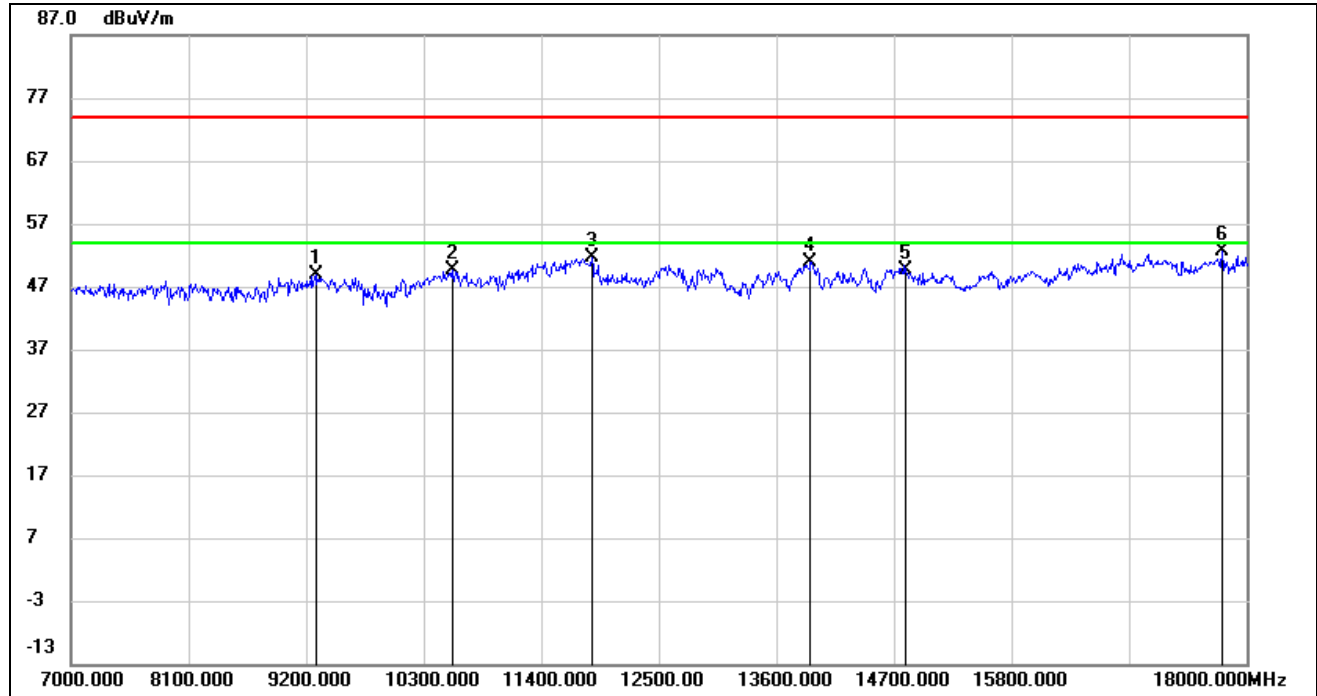

No.	Frequency (MHz)	Reading (dBuV)	Correct (dB/m)	Result (dBuV/m)	Limit (dBuV/m)	Margin (dB)	Remark
1	9299.000	37.89	11.00	48.89	74.00	-25.11	peak
2	10564.000	36.24	13.33	49.57	74.00	-24.43	peak
3	11873.000	35.02	16.63	51.65	74.00	-22.35	peak
4	13919.000	32.96	17.97	50.93	74.00	-23.07	peak
5	14810.000	31.77	17.82	49.59	74.00	-24.41	peak
6	17769.000	28.88	23.73	52.61	74.00	-21.39	peak

- Note:
1. Measurement = Reading Level + Correct Factor.
  2. If Peak Result complies with AV limit, AV Result is deemed to comply with AV limit.
  3. Peak: Peak detector.
  4. AVG:  $VBW=1/Ton$ , where: Ton is the transmitting duration.
  5. For the transmitting duration, please refer to clause 7.1.
  6. Filter losses were only considered in the spurious frequency bands and the authorized band was not corrected for High Pass Filter losses.
  7. Proper operation of the transmitter prior to adding the filter to the measurement chain.
  8. Since non-restricted band peak emissions are less than the average limit, they also comply with the -27dBm/MHz (68.2dBuV/m) limit.

**HARMONICS AND SPURIOUS EMISSIONS (HIGH CHANNEL, HORIZONTAL)**

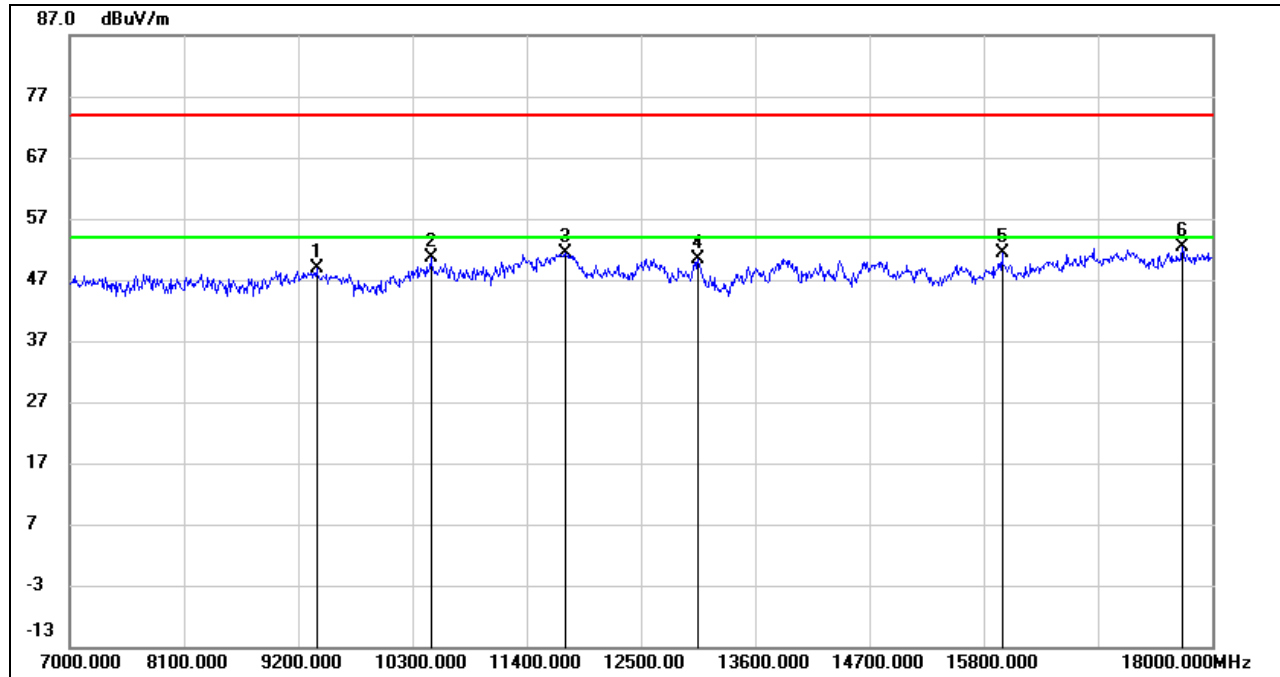

No.	Frequency (MHz)	Reading (dBuV)	Correct (dB/m)	Result (dBuV/m)	Limit (dBuV/m)	Margin (dB)	Remark
1	9376.000	37.46	11.34	48.80	74.00	-25.20	peak
2	10476.000	37.74	12.98	50.72	74.00	-23.28	peak
3	11774.000	34.71	16.58	51.29	74.00	-22.71	peak
4	13050.000	33.49	16.83	50.32	74.00	-23.68	peak
5	15976.000	32.95	18.45	51.40	74.00	-22.60	peak
6	17714.000	29.08	23.34	52.42	74.00	-21.58	peak

- Note:
1. Measurement = Reading Level + Correct Factor.
  2. If Peak Result complies with AV limit, AV Result is deemed to comply with AV limit.
  3. Peak: Peak detector.
  4. AVG:  $VBW=1/Ton$ , where: Ton is the transmitting duration.
  5. For the transmitting duration, please refer to clause 7.1.
  6. Filter losses were only considered in the spurious frequency bands and the authorized band was not corrected for High Pass Filter losses.
  7. Proper operation of the transmitter prior to adding the filter to the measurement chain.
  8. Since non-restricted band peak emissions are less than the average limit, they also comply with the -27dBm/MHz (68.2dBuV/m) limit.

**HARMONICS AND SPURIOUS EMISSIONS (HIGH CHANNEL, VERTICAL)**

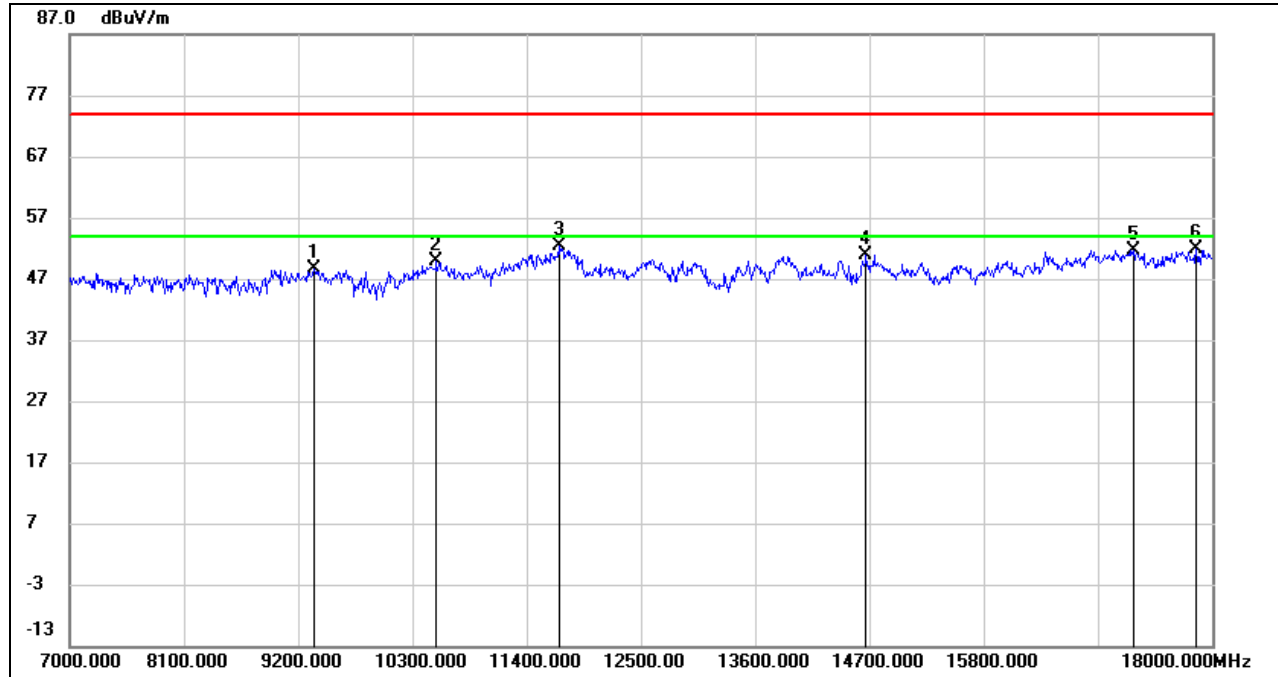

No.	Frequency (MHz)	Reading (dBuV)	Correct (dB/m)	Result (dBuV/m)	Limit (dBuV/m)	Margin (dB)	Remark
1	9354.000	37.45	11.23	48.68	74.00	-25.32	peak
2	10531.000	36.55	13.21	49.76	74.00	-24.24	peak
3	11708.000	36.20	16.28	52.48	74.00	-21.52	peak
4	14667.000	33.32	17.66	50.98	74.00	-23.02	peak
5	17241.000	29.31	22.34	51.65	74.00	-22.35	peak
6	17846.000	28.02	23.96	51.98	74.00	-22.02	peak

- Note: 1. Measurement = Reading Level + Correct Factor.  
 2. If Peak Result complies with AV limit, AV Result is deemed to comply with AV limit.  
 3. Peak: Peak detector.  
 4. AVG:  $VBW=1/Ton$ , where: Ton is the transmitting duration.  
 5. For the transmitting duration, please refer to clause 7.1.  
 6. Filter losses were only considered in the spurious frequency bands and the authorized band was not corrected for High Pass Filter losses.  
 7. Proper operation of the transmitter prior to adding the filter to the measurement chain.  
 8. Since non-restricted band peak emissions are less than the average limit, they also comply with the -27dBm/MHz (68.2dBuV/m) limit.



**UNII-2A BAND**

**HARMONICS AND SPURIOUS EMISSIONS (LOW CHANNEL, HORIZONTAL)**

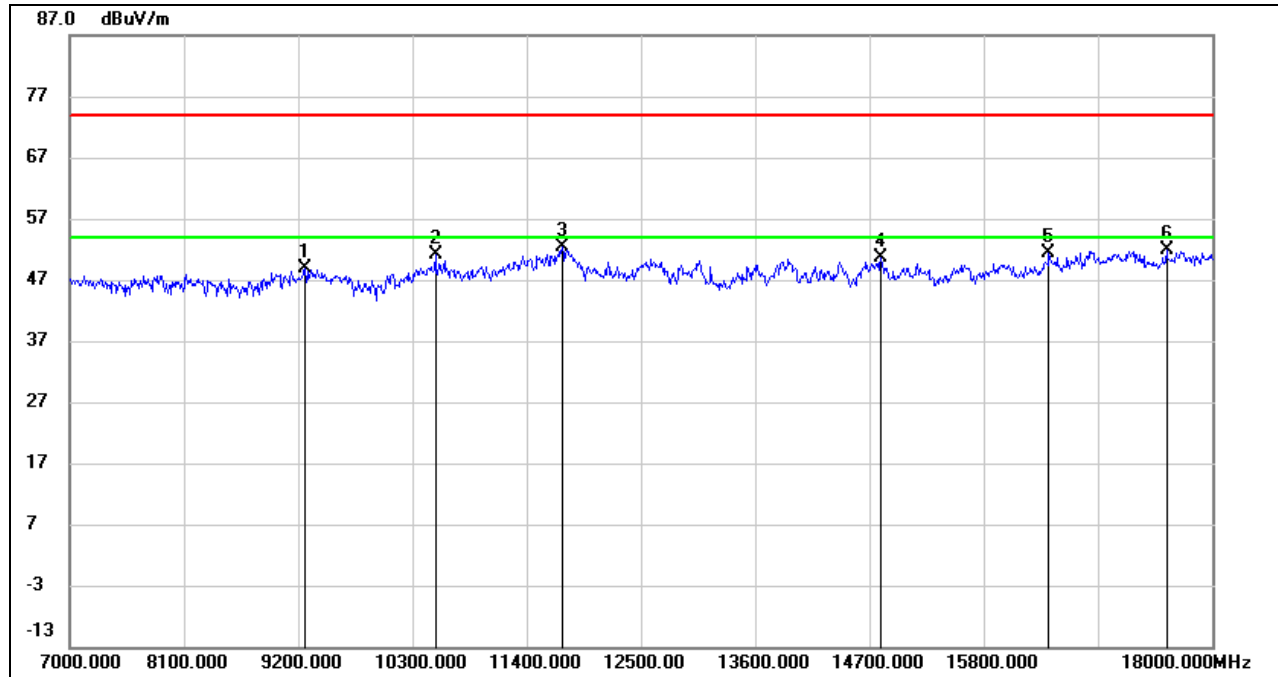

No.	Frequency (MHz)	Reading (dBuV)	Correct (dB/m)	Result (dBuV/m)	Limit (dBuV/m)	Margin (dB)	Remark
1	9266.000	37.95	10.85	48.80	74.00	-25.20	peak
2	10520.000	37.89	13.17	51.06	74.00	-22.94	peak
3	11741.000	35.95	16.43	52.38	74.00	-21.62	peak
4	14810.000	32.69	17.82	50.51	74.00	-23.49	peak
5	16427.000	31.37	19.93	51.30	74.00	-22.70	peak
6	17560.000	29.48	22.37	51.85	74.00	-22.15	peak

- Note:
1. Measurement = Reading Level + Correct Factor.
  2. If Peak Result complies with AV limit, AV Result is deemed to comply with AV limit.
  3. Peak: Peak detector.
  4. AVG:  $VBW=1/Ton$ , where: Ton is the transmitting duration.
  5. For the transmitting duration, please refer to clause 7.1.
  6. Filter losses were only considered in the spurious frequency bands and the authorized band was not corrected for High Pass Filter losses.
  7. Proper operation of the transmitter prior to adding the filter to the measurement chain.
  8. Since non-restricted band peak emissions are less than the average limit, they also comply with the -27dBm/MHz (68.2dBuV/m) limit.





**HARMONICS AND SPURIOUS EMISSIONS (LOW CHANNEL, VERTICAL)**

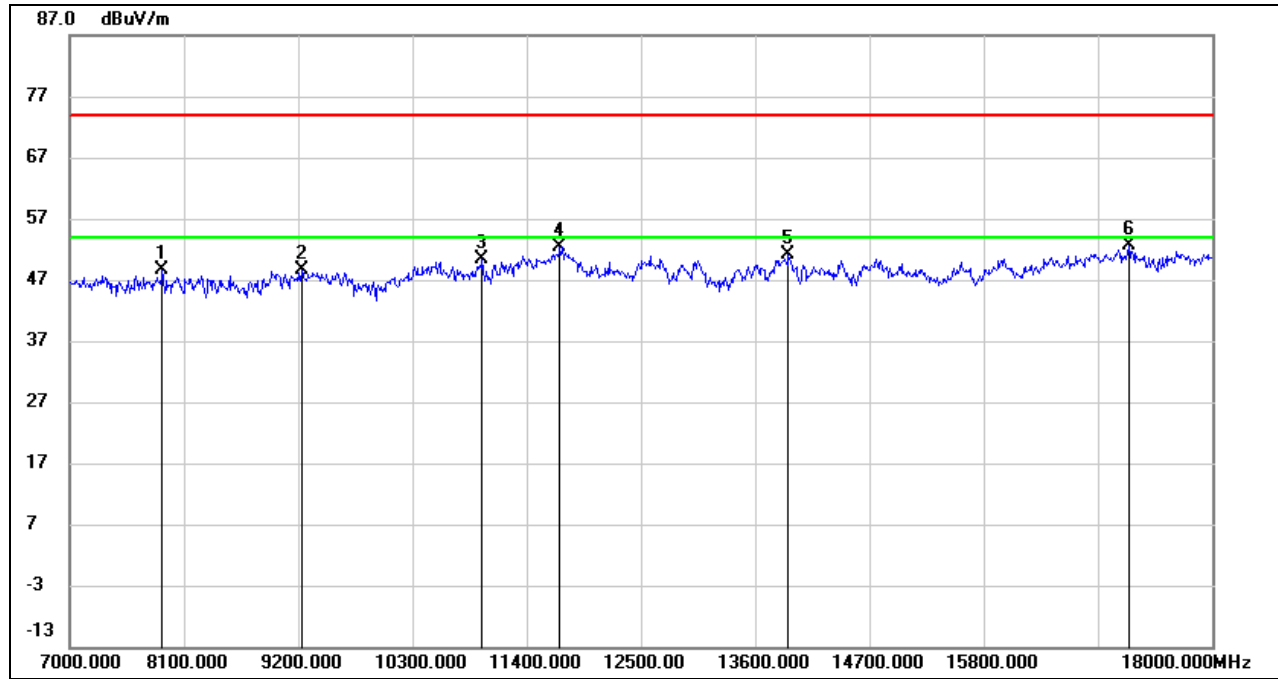

No.	Frequency (MHz)	Reading (dBuV)	Correct (dB/m)	Result (dBuV/m)	Limit (dBuV/m)	Margin (dB)	Remark
1	7891.000	39.50	9.24	48.74	74.00	-25.26	peak
2	9233.000	37.93	10.72	48.65	74.00	-25.35	peak
3	10971.000	36.13	14.33	50.46	74.00	-23.54	peak
4	11719.000	36.13	16.34	52.47	74.00	-21.53	peak
5	13919.000	33.26	17.97	51.23	74.00	-22.77	peak
6	17197.000	30.22	22.46	52.68	74.00	-21.32	peak

- Note:
1. Measurement = Reading Level + Correct Factor.
  2. If Peak Result complies with AV limit, AV Result is deemed to comply with AV limit.
  3. Peak: Peak detector.
  4. AVG: VBW=1/Ton, where: Ton is the transmitting duration.
  5. For the transmitting duration, please refer to clause 7.1.
  6. Filter losses were only considered in the spurious frequency bands and the authorized band was not corrected for High Pass Filter losses.
  7. Proper operation of the transmitter prior to adding the filter to the measurement chain.
  8. Since non-restricted band peak emissions are less than the average limit, they also comply with the -27dBm/MHz (68.2dBuV/m) limit.

**HARMONICS AND SPURIOUS EMISSIONS (MID CHANNEL, HORIZONTAL)**

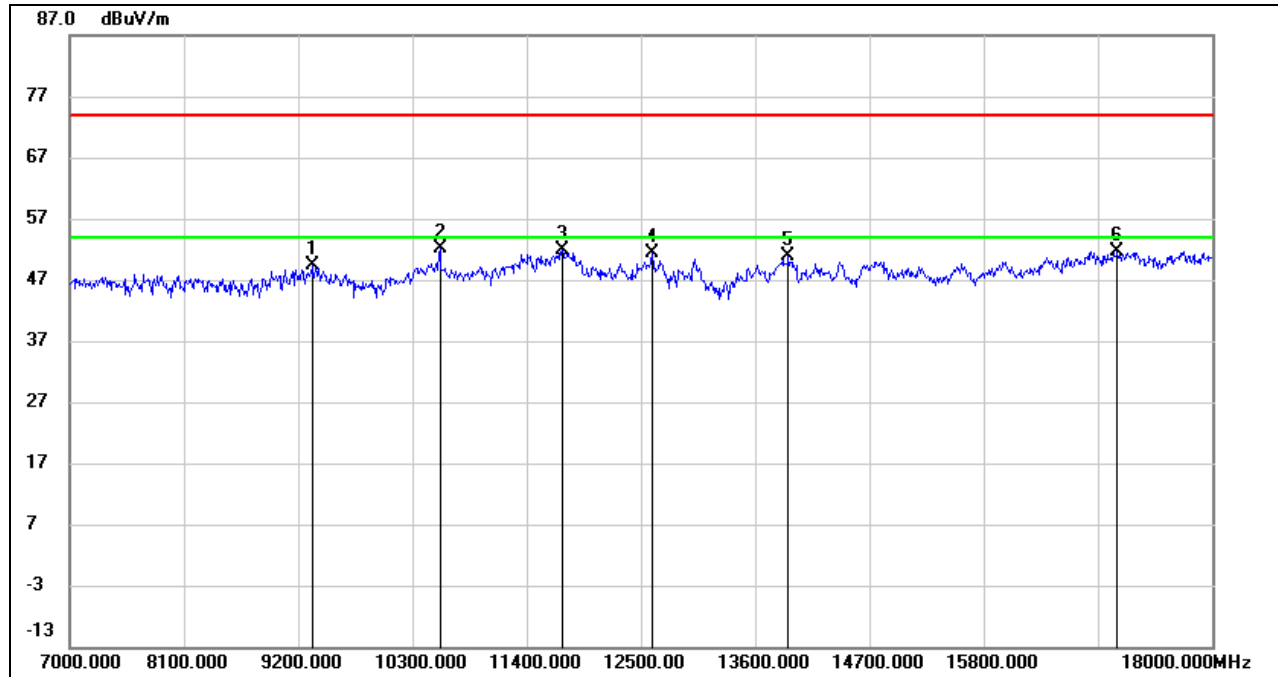

No.	Frequency (MHz)	Reading (dBuV)	Correct (dB/m)	Result (dBuV/m)	Limit (dBuV/m)	Margin (dB)	Remark
1	9332.000	38.24	11.15	49.39	74.00	-24.61	peak
2	10564.000	38.79	13.33	52.12	74.00	-21.88	peak
3	11741.000	35.42	16.43	51.85	74.00	-22.15	peak
4	12610.000	34.53	16.82	51.35	74.00	-22.65	peak
5	13919.000	32.83	17.97	50.80	74.00	-23.20	peak
6	17087.000	29.90	21.85	51.75	74.00	-22.25	peak

- Note:
1. Measurement = Reading Level + Correct Factor.
  2. If Peak Result complies with AV limit, AV Result is deemed to comply with AV limit.
  3. Peak: Peak detector.
  4. AVG:  $VBW=1/Ton$ , where: Ton is the transmitting duration.
  5. For the transmitting duration, please refer to clause 7.1.
  6. Filter losses were only considered in the spurious frequency bands and the authorized band was not corrected for High Pass Filter losses.
  7. Proper operation of the transmitter prior to adding the filter to the measurement chain.
  8. Since non-restricted band peak emissions are less than the average limit, they also comply with the -27dBm/MHz (68.2dBuV/m) limit.

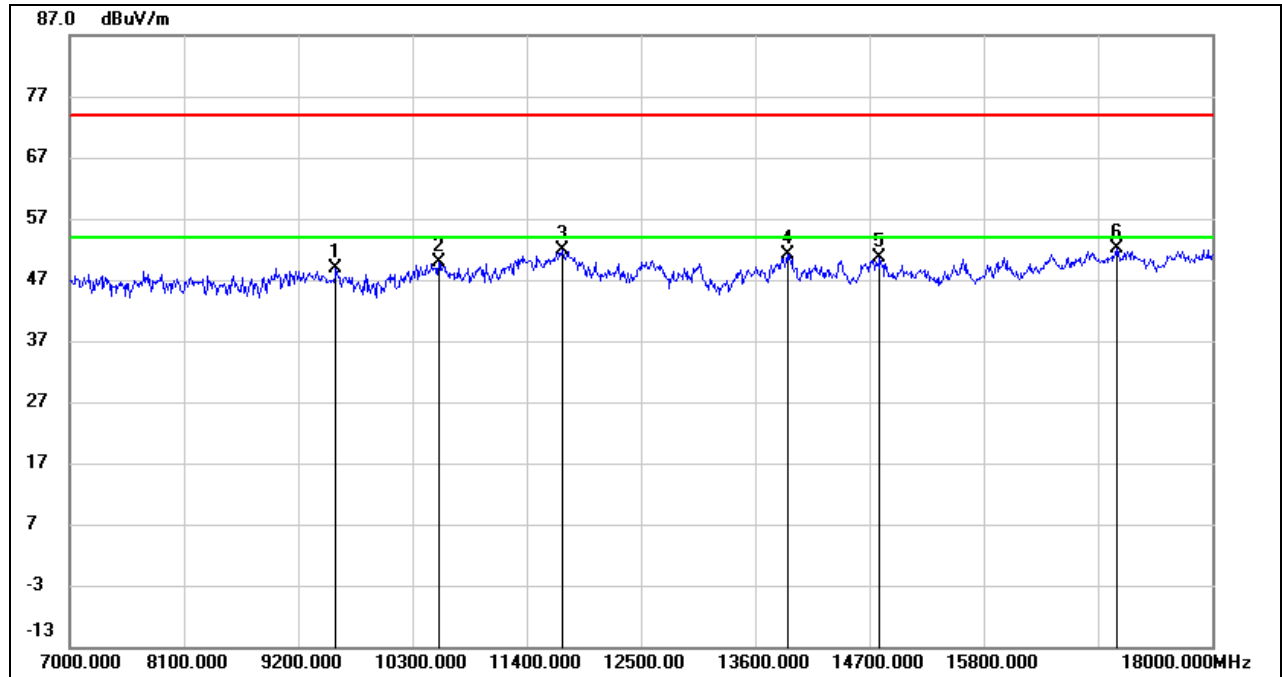
**HARMONICS AND SPURIOUS EMISSIONS (MID CHANNEL, VERTICAL)**

No.	Frequency (MHz)	Reading (dBuV)	Correct (dB/m)	Result (dBuV/m)	Limit (dBuV/m)	Margin (dB)	Remark
1	9563.000	37.05	11.87	48.92	74.00	-25.08	peak
2	10553.000	36.67	13.28	49.95	74.00	-24.05	peak
3	11741.000	35.53	16.43	51.96	74.00	-22.04	peak
4	13908.000	33.26	17.99	51.25	74.00	-22.75	peak
5	14799.000	32.71	17.82	50.53	74.00	-23.47	peak
6	17076.000	30.34	21.79	52.13	74.00	-21.87	peak

- Note:
1. Measurement = Reading Level + Correct Factor.
  2. If Peak Result complies with AV limit, AV Result is deemed to comply with AV limit.
  3. Peak: Peak detector.
  4. AVG:  $VBW=1/Ton$ , where: Ton is the transmitting duration.
  5. For the transmitting duration, please refer to clause 7.1.
  6. Filter losses were only considered in the spurious frequency bands and the authorized band was not corrected for High Pass Filter losses.
  7. Proper operation of the transmitter prior to adding the filter to the measurement chain.
  8. Since non-restricted band peak emissions are less than the average limit, they also comply with the  $-27dBm/MHz$  ( $68.2dBuV/m$ ) limit.



**HARMONICS AND SPURIOUS EMISSIONS (HIGH CHANNEL, HORIZONTAL)**

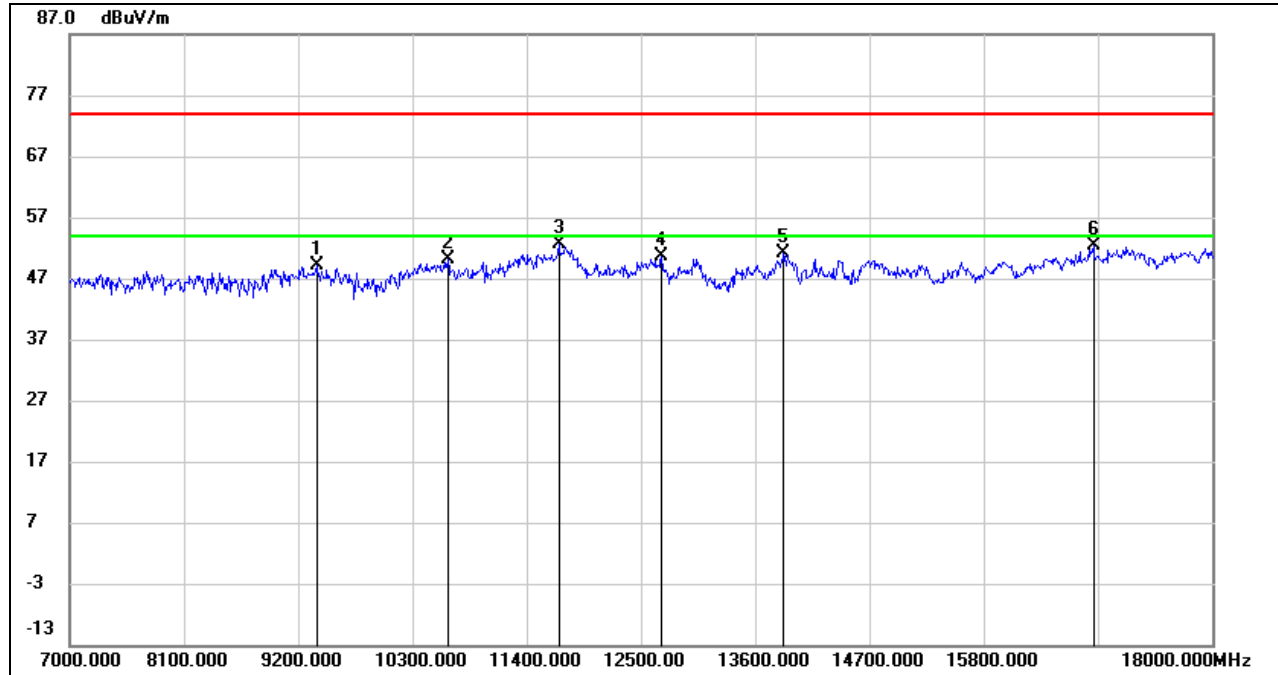

No.	Frequency (MHz)	Reading (dBuV)	Correct (dB/m)	Result (dBuV/m)	Limit (dBuV/m)	Margin (dB)	Remark
1	9376.000	37.79	11.34	49.13	74.00	-24.87	peak
2	10641.000	36.56	13.53	50.09	74.00	-23.91	peak
3	11708.000	36.27	16.28	52.55	74.00	-21.45	peak
4	12698.000	33.75	16.81	50.56	74.00	-23.44	peak
5	13875.000	32.98	18.04	51.02	74.00	-22.98	peak
6	16856.000	31.33	21.10	52.43	74.00	-21.57	peak

- Note: 1. Measurement = Reading Level + Correct Factor.  
 2. If Peak Result complies with AV limit, AV Result is deemed to comply with AV limit.  
 3. Peak: Peak detector.  
 4. AVG:  $VBW=1/Ton$ , where: Ton is the transmitting duration.  
 5. For the transmitting duration, please refer to clause 7.1.  
 6. Filter losses were only considered in the spurious frequency bands and the authorized band was not corrected for High Pass Filter losses.  
 7. Proper operation of the transmitter prior to adding the filter to the measurement chain.  
 8. Since non-restricted band peak emissions are less than the average limit, they also comply with the -27dBm/MHz (68.2dBuV/m) limit.

**HARMONICS AND SPURIOUS EMISSIONS (HIGH CHANNEL, VERTICAL)**

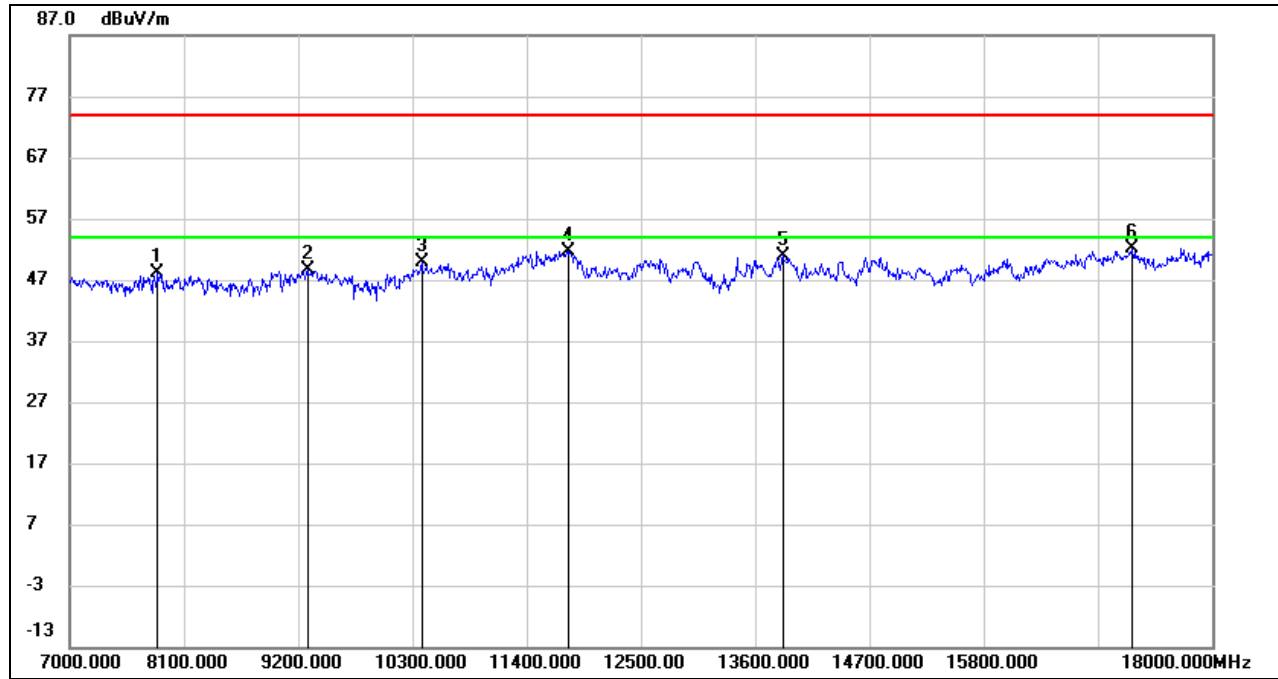

No.	Frequency (MHz)	Reading (dBuV)	Correct (dB/m)	Result (dBuV/m)	Limit (dBuV/m)	Margin (dB)	Remark
1	7847.000	38.77	9.35	48.12	74.00	-25.88	peak
2	9288.000	37.70	10.95	48.65	74.00	-25.35	peak
3	10388.000	37.35	12.57	49.92	74.00	-24.08	peak
4	11796.000	34.98	16.69	51.67	74.00	-22.33	peak
5	13864.000	32.97	18.03	51.00	74.00	-23.00	peak
6	17230.000	29.79	22.37	52.16	74.00	-21.84	peak

Note: 1. Measurement = Reading Level + Correct Factor.  
 2. If Peak Result complies with AV limit, AV Result is deemed to comply with AV limit.  
 3. Peak: Peak detector.  
 4. AVG:  $VBW=1/Ton$ , where: Ton is the transmitting duration.  
 5. For the transmitting duration, please refer to clause 7.1.  
 6. Filter losses were only considered in the spurious frequency bands and the authorized band was not corrected for High Pass Filter losses.  
 7. Proper operation of the transmitter prior to adding the filter to the measurement chain.  
 8. Since non-restricted band peak emissions are less than the average limit, they also comply with the -27dBm/MHz (68.2dBuV/m) limit.

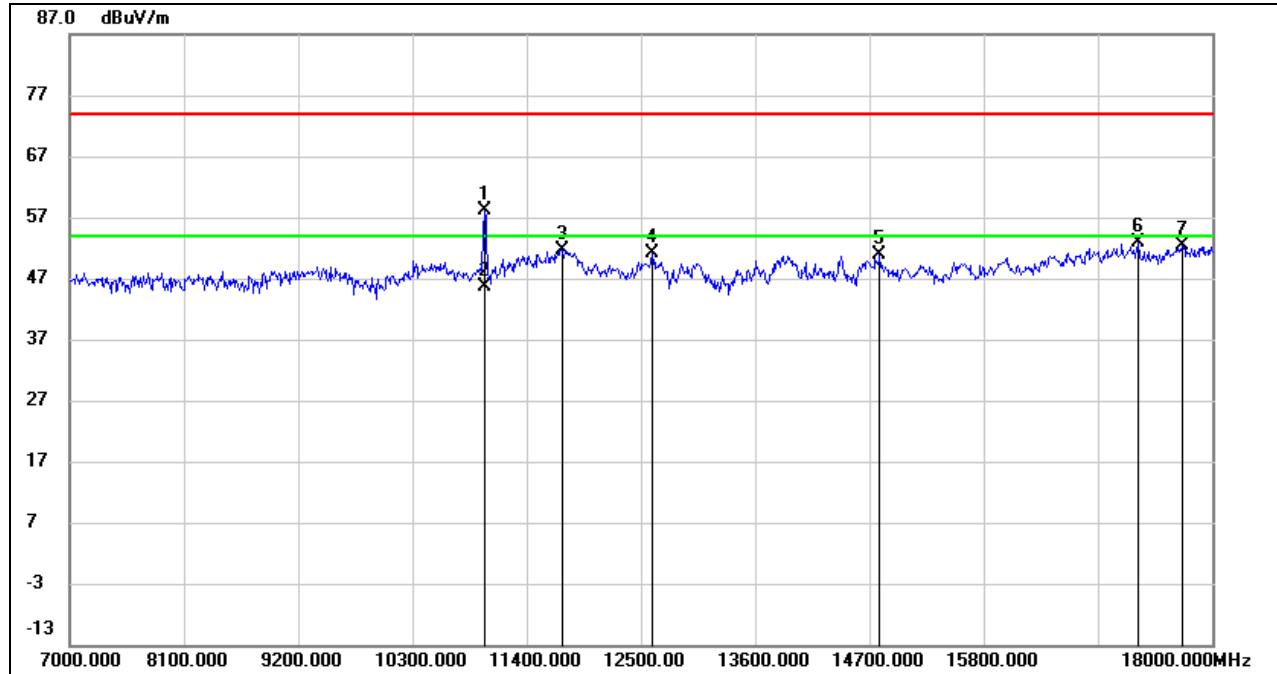
**UNII-2C BAND**
**HARMONICS AND SPURIOUS EMISSIONS (LOW CHANNEL, HORIZONTAL)**

No.	Frequency (MHz)	Reading (dBuV)	Correct (dB/m)	Result (dBuV/m)	Limit (dBuV/m)	Margin (dB)	Remark
1	10993.000	43.77	14.39	58.16	74.00	-15.84	peak
2	10993.000	31.13	14.39	45.52	54.00	-8.48	AVG
3	11741.000	35.19	16.43	51.62	74.00	-22.38	peak
4	12610.000	34.33	16.82	51.15	74.00	-22.85	peak
5	14799.000	33.16	17.82	50.98	74.00	-23.02	peak
6	17285.000	30.69	22.21	52.90	74.00	-21.10	peak
7	17714.000	29.10	23.34	52.44	74.00	-21.56	peak

- Note:
1. Measurement = Reading Level + Correct Factor.
  2. If Peak Result complies with AV limit, AV Result is deemed to comply with AV limit.
  3. Peak: Peak detector.
  4. AVG:  $VBW=1/Ton$ , where: Ton is the transmitting duration.
  5. For the transmitting duration, please refer to clause 7.1.
  6. Filter losses were only considered in the spurious frequency bands and the authorized band was not corrected for High Pass Filter losses.
  7. Proper operation of the transmitter prior to adding the filter to the measurement chain.
  8. Since non-restricted band peak emissions are less than the average limit, they also comply with the -27dBm/MHz (68.2dBuV/m) limit.

**HARMONICS AND SPURIOUS EMISSIONS (LOW CHANNEL, VERTICAL)**

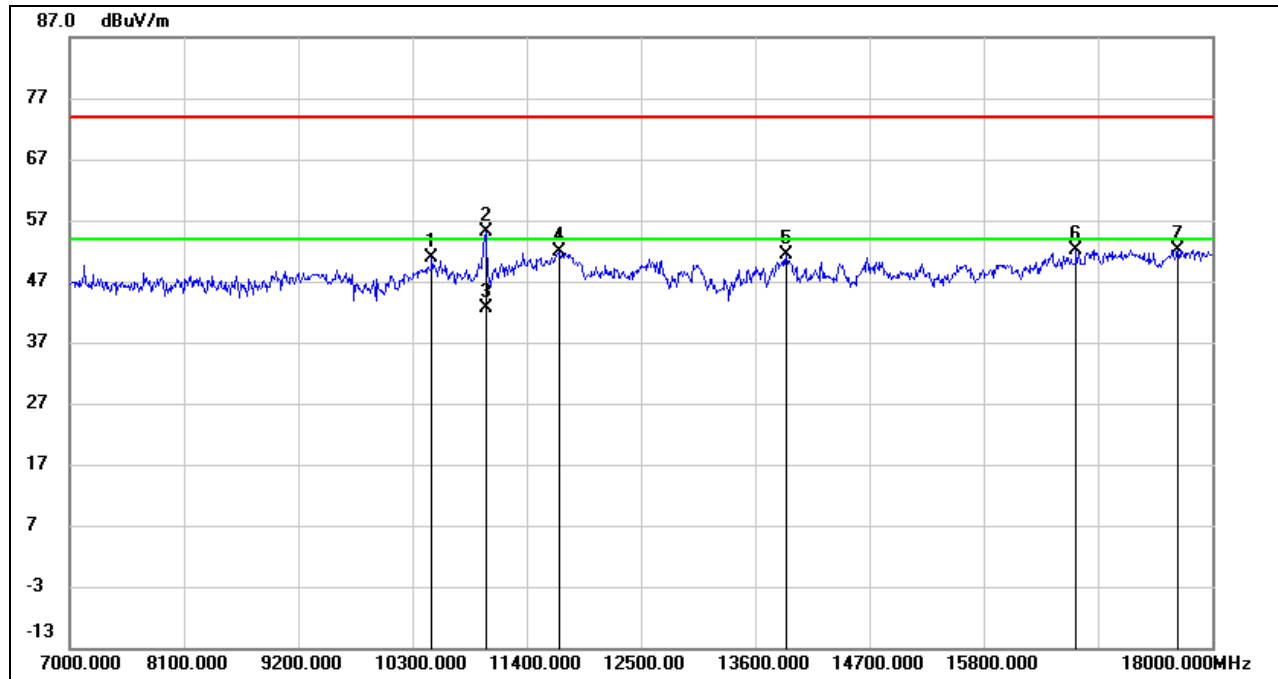

No.	Frequency (MHz)	Reading (dBuV)	Correct (dB/m)	Result (dBuV/m)	Limit (dBuV/m)	Margin (dB)	Remark
1	10487.000	37.87	13.03	50.90	74.00	-23.10	peak
2	11004.000	40.74	14.41	55.15	74.00	-18.85	peak
3	11004.000	28.30	14.41	42.71	54.00	-11.29	AVG
4	11719.000	35.45	16.34	51.79	74.00	-22.21	peak
5	13897.000	33.37	18.00	51.37	74.00	-22.63	peak
6	16691.000	31.22	20.88	52.10	74.00	-21.90	peak
7	17670.000	29.20	23.04	52.24	74.00	-21.76	peak

- Note:
1. Measurement = Reading Level + Correct Factor.
  2. If Peak Result complies with AV limit, AV Result is deemed to comply with AV limit.
  3. Peak: Peak detector.
  4. AVG:  $VBW=1/Ton$ , where: Ton is the transmitting duration.
  5. For the transmitting duration, please refer to clause 7.1.
  6. Filter losses were only considered in the spurious frequency bands and the authorized band was not corrected for High Pass Filter losses.
  7. Proper operation of the transmitter prior to adding the filter to the measurement chain.
  8. Since non-restricted band peak emissions are less than the average limit, they also comply with the -27dBm/MHz (68.2dBuV/m) limit.

**HARMONICS AND SPURIOUS EMISSIONS (MID CHANNEL, HORIZONTAL)**

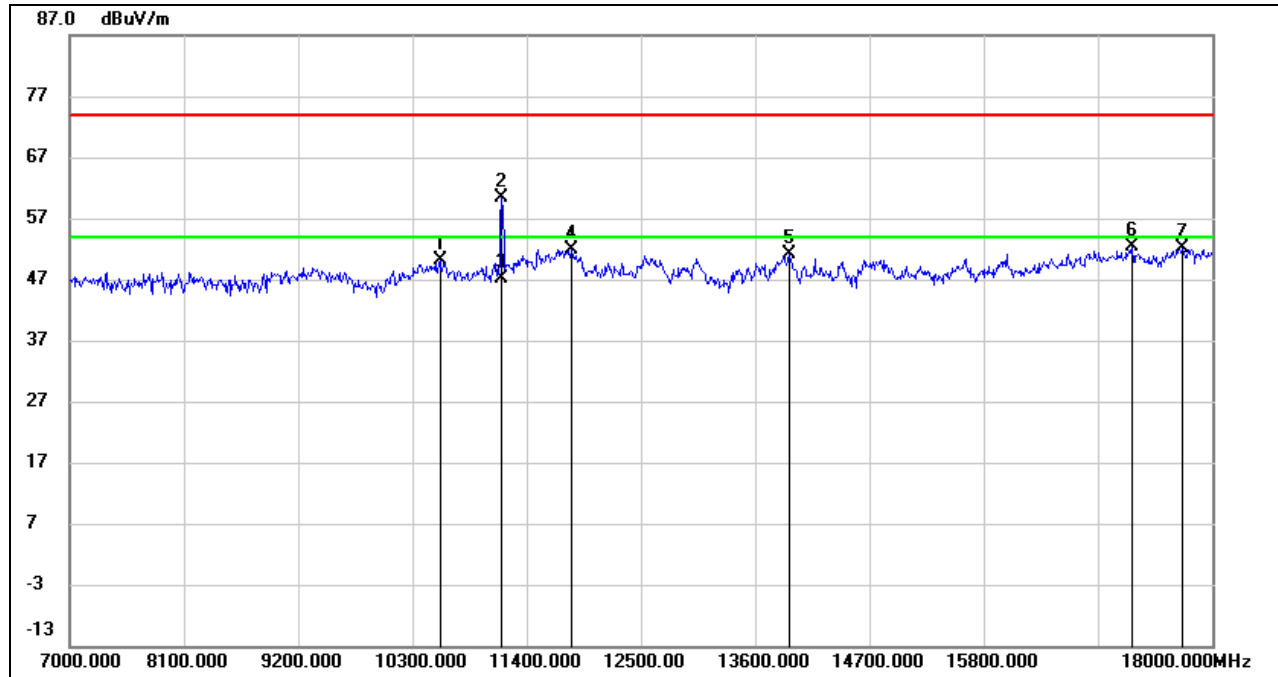

No.	Frequency (MHz)	Reading (dBuV)	Correct (dB/m)	Result (dBuV/m)	Limit (dBuV/m)	Margin (dB)	Remark
1	10564.000	36.72	13.33	50.05	74.00	-23.95	peak
2	11158.000	45.51	14.81	60.32	74.00	-13.68	peak
3	11158.000	32.31	14.81	47.12	54.00	-6.88	AVG
4	11829.000	35.20	16.67	51.87	74.00	-22.13	peak
5	13930.000	33.17	17.97	51.14	74.00	-22.86	peak
6	17230.000	29.90	22.37	52.27	74.00	-21.73	peak
7	17714.000	28.67	23.34	52.01	74.00	-21.99	peak

- Note: 1. Measurement = Reading Level + Correct Factor.  
 2. If Peak Result complies with AV limit, AV Result is deemed to comply with AV limit.  
 3. Peak: Peak detector.  
 4. AVG: VBW=1/Ton, where: Ton is the transmitting duration.  
 5. For the transmitting duration, please refer to clause 7.1.  
 6. Filter losses were only considered in the spurious frequency bands and the authorized band was not corrected for High Pass Filter losses.  
 7. Proper operation of the transmitter prior to adding the filter to the measurement chain.  
 8. Since non-restricted band peak emissions are less than the average limit, they also comply with the -27dBm/MHz (68.2dBuV/m) limit.



### HARMONICS AND SPURIOUS EMISSIONS (MID CHANNEL, VERTICAL)

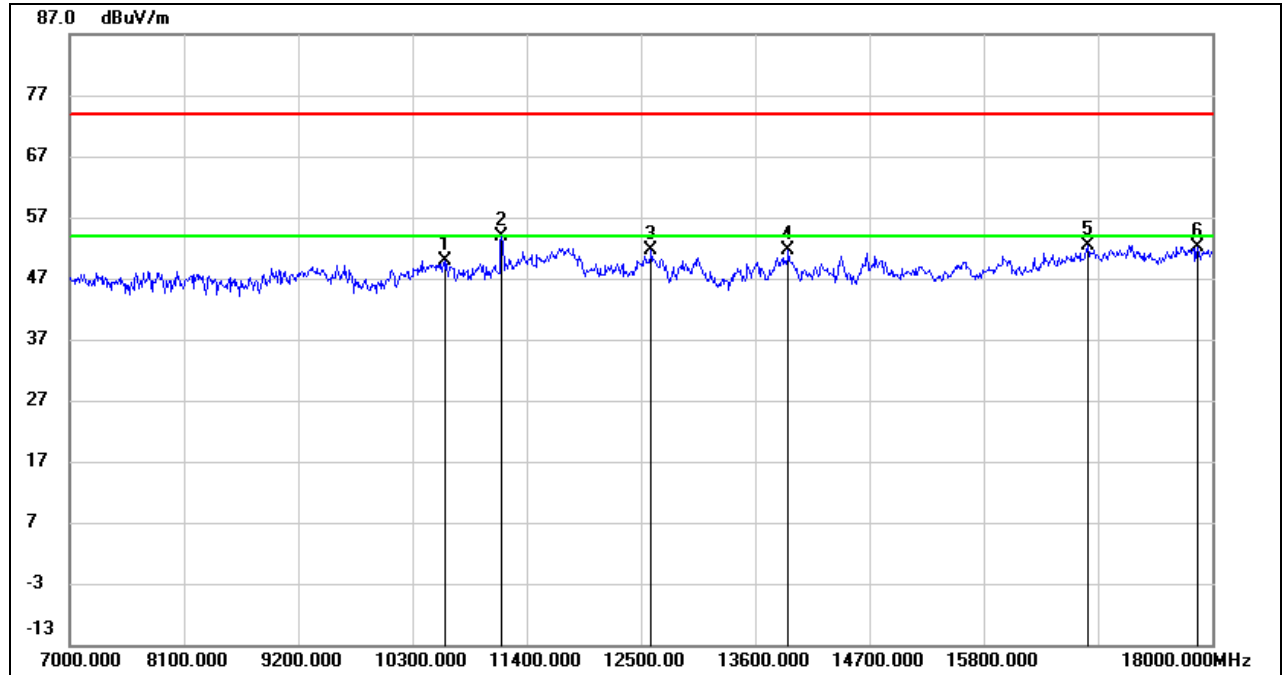

No.	Frequency (MHz)	Reading (dBuV)	Correct (dB/m)	Result (dBuV/m)	Limit (dBuV/m)	Margin (dB)	Remark
1	10619.000	36.35	13.50	49.85	74.00	-24.15	peak
2	11158.000	39.17	14.81	53.98	74.00	-20.02	peak
3	12599.000	34.74	16.83	51.57	74.00	-22.43	peak
4	13919.000	33.56	17.97	51.53	74.00	-22.47	peak
5	16801.000	31.48	21.00	52.48	74.00	-21.52	peak
6	17857.000	28.26	23.96	52.22	74.00	-21.78	peak

- Note:
1. Measurement = Reading Level + Correct Factor.
  2. If Peak Result complies with AV limit, AV Result is deemed to comply with AV limit.
  3. Peak: Peak detector.
  4. AVG:  $VBW=1/Ton$ , where: Ton is the transmitting duration.
  5. For the transmitting duration, please refer to clause 7.1.
  6. Filter losses were only considered in the spurious frequency bands and the authorized band was not corrected for High Pass Filter losses.
  7. Proper operation of the transmitter prior to adding the filter to the measurement chain.
  8. Since non-restricted band peak emissions are less than the average limit, they also comply with the -27dBm/MHz (68.2dBuV/m) limit.

**HARMONICS AND SPURIOUS EMISSIONS (HIGH CHANNEL, HORIZONTAL)**

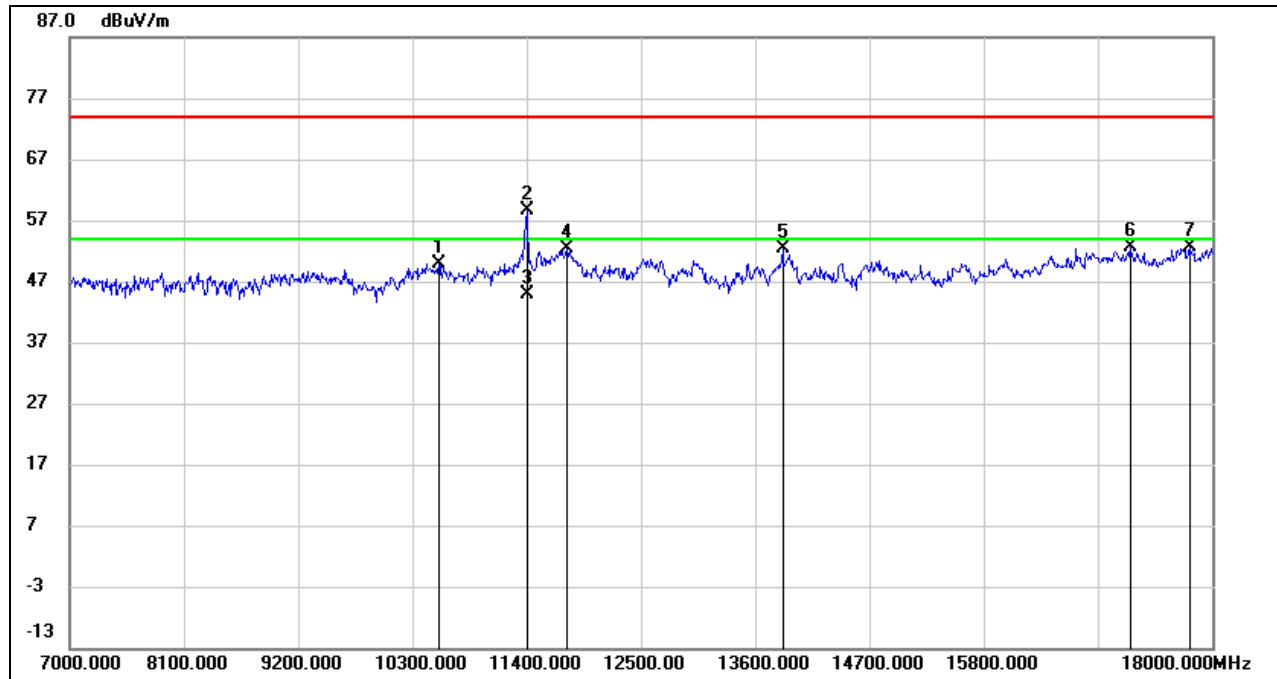

No.	Frequency (MHz)	Reading (dBuV)	Correct (dB/m)	Result (dBuV/m)	Limit (dBuV/m)	Margin (dB)	Remark
1	10553.000	36.71	13.28	49.99	74.00	-24.01	peak
2	11400.000	43.31	15.43	58.74	74.00	-15.26	peak
3	11400.000	29.43	15.43	44.86	54.00	-9.14	AVG
4	11785.000	35.65	16.63	52.28	74.00	-21.72	peak
5	13864.000	34.23	18.03	52.26	74.00	-21.74	peak
6	17208.000	30.19	22.45	52.64	74.00	-21.36	peak
7	17780.000	28.83	23.81	52.64	74.00	-21.36	peak

- Note: 1. Measurement = Reading Level + Correct Factor.  
 2. If Peak Result complies with AV limit, AV Result is deemed to comply with AV limit.  
 3. Peak: Peak detector.  
 4. AVG:  $VBW=1/Ton$ , where: Ton is the transmitting duration.  
 5. For the transmitting duration, please refer to clause 7.1.  
 6. Filter losses were only considered in the spurious frequency bands and the authorized band was not corrected for High Pass Filter losses.  
 7. Proper operation of the transmitter prior to adding the filter to the measurement chain.  
 8. Since non-restricted band peak emissions are less than the average limit, they also comply with the -27dBm/MHz (68.2dBuV/m) limit.



**HARMONICS AND SPURIOUS EMISSIONS (HIGH CHANNEL, VERTICAL)**

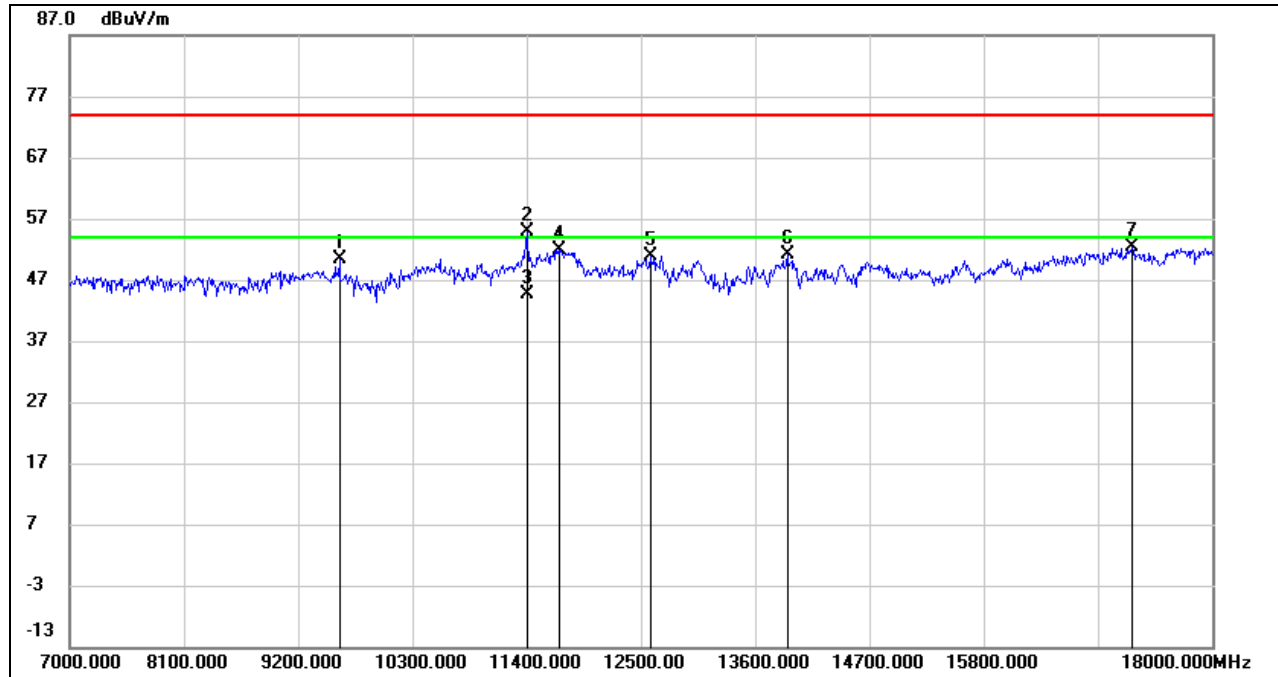

No.	Frequency (MHz)	Reading (dBuV)	Correct (dB/m)	Result (dBuV/m)	Limit (dBuV/m)	Margin (dB)	Remark
1	9596.000	38.45	11.94	50.39	74.00	-23.61	peak
2	11400.000	39.42	15.43	54.85	74.00	-19.15	peak
3	11400.000	29.16	15.43	44.59	54.00	-9.41	AVG
4	11708.000	35.70	16.28	51.98	74.00	-22.02	peak
5	12588.000	34.13	16.81	50.94	74.00	-23.06	peak
6	13908.000	33.07	17.99	51.06	74.00	-22.94	peak
7	17230.000	30.13	22.37	52.50	74.00	-21.50	peak

- Note:
1. Measurement = Reading Level + Correct Factor.
  2. If Peak Result complies with AV limit, AV Result is deemed to comply with AV limit.
  3. Peak: Peak detector.
  4. AVG: VBW=1/Ton, where: Ton is the transmitting duration.
  5. For the transmitting duration, please refer to clause 7.1.
  6. Filter losses were only considered in the spurious frequency bands and the authorized band was not corrected for High Pass Filter losses.
  7. Proper operation of the transmitter prior to adding the filter to the measurement chain.
  8. Since non-restricted band peak emissions are less than the average limit, they also comply with the -27dBm/MHz (68.2dBuV/m) limit.



**STRADDLE CHANNEL 144**

**HARMONICS AND SPURIOUS EMISSIONS (HORIZONTAL)**

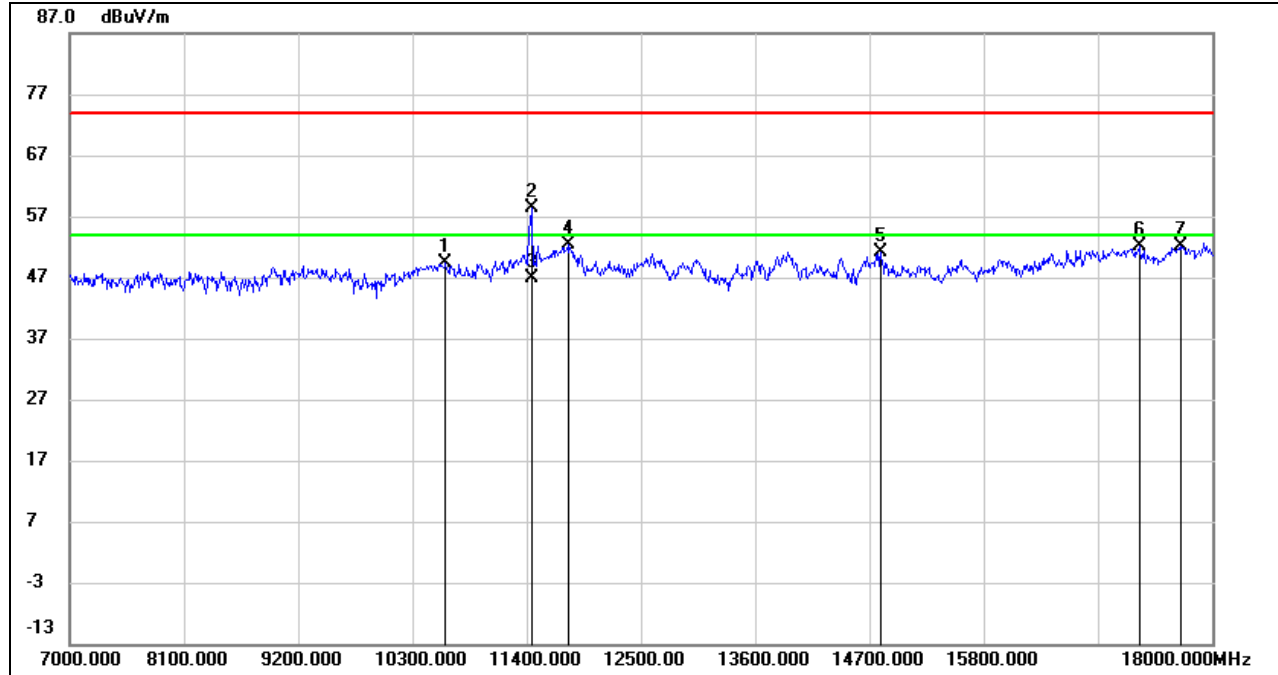

No.	Frequency (MHz)	Reading (dBuV)	Correct (dB/m)	Result (dBuV/m)	Limit (dBuV/m)	Margin (dB)	Remark
1	10619.000	35.97	13.50	49.47	74.00	-24.53	peak
2	11444.000	42.81	15.50	58.31	74.00	-15.69	peak
3	11444.000	31.36	15.50	46.86	54.00	-7.14	AVG
4	11796.000	35.61	16.69	52.30	74.00	-21.70	peak
5	14810.000	33.43	17.82	51.25	74.00	-22.75	peak
6	17296.000	29.94	22.18	52.12	74.00	-21.88	peak
7	17692.000	28.96	23.19	52.15	74.00	-21.85	peak

- Note: 1. Measurement = Reading Level + Correct Factor.  
 2. If Peak Result complies with AV limit, AV Result is deemed to comply with AV limit.  
 3. Peak: Peak detector.  
 4. AVG:  $VBW=1/Ton$ , where:  $Ton$  is the transmitting duration.  
 5. For the transmitting duration, please refer to clause 7.1.  
 6. Filter losses were only considered in the spurious frequency bands and the authorized band was not corrected for High Pass Filter losses.  
 7. Proper operation of the transmitter prior to adding the filter to the measurement chain.  
 8. Since non-restricted band peak emissions are less than the average limit, they also comply with the -27dBm/MHz (68.2dBuV/m) limit.

**HARMONICS AND SPURIOUS EMISSIONS (VERTICAL)**

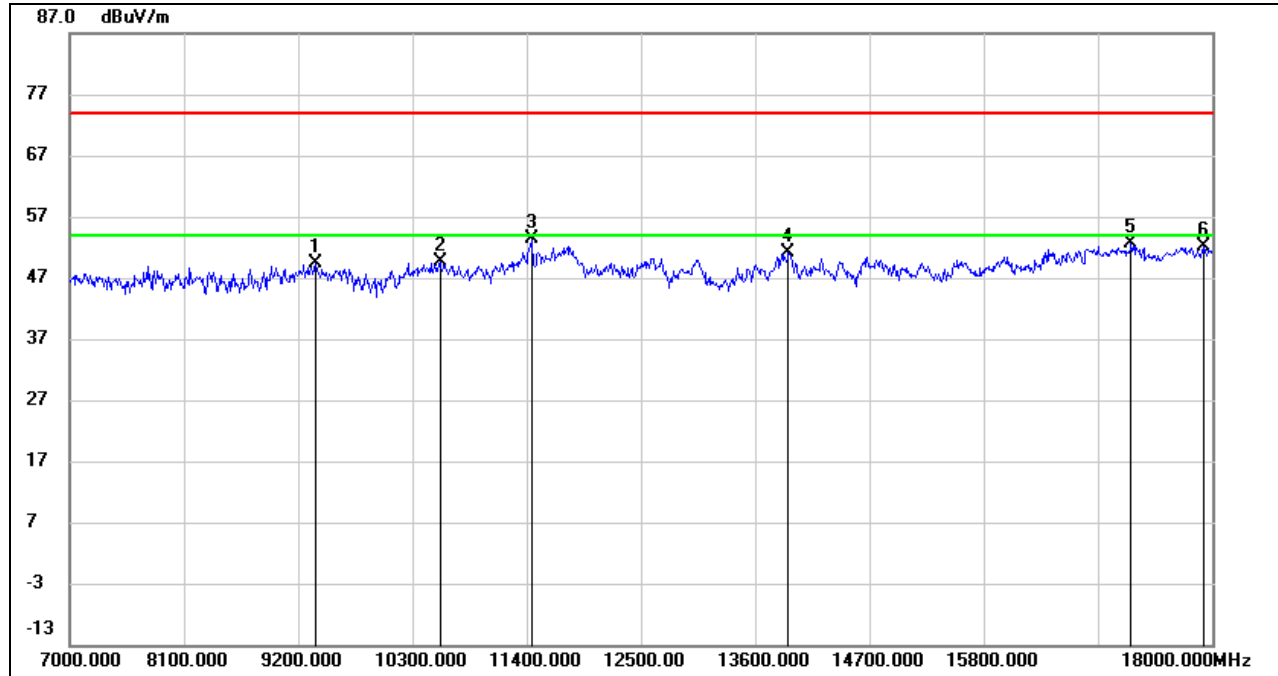

No.	Frequency (MHz)	Reading (dBuV)	Correct (dB/m)	Result (dBuV/m)	Limit (dBuV/m)	Margin (dB)	Remark
1	9365.000	38.09	11.29	49.38	74.00	-24.62	peak
2	10564.000	36.20	13.33	49.53	74.00	-24.47	peak
3	11444.000	37.95	15.50	53.45	74.00	-20.55	peak
4	13919.000	33.13	17.97	51.10	74.00	-22.90	peak
5	17219.000	30.21	22.41	52.62	74.00	-21.38	peak
6	17912.000	28.07	23.99	52.06	74.00	-21.94	peak

- Note:
1. Measurement = Reading Level + Correct Factor.
  2. If Peak Result complies with AV limit, AV Result is deemed to comply with AV limit.
  3. Peak: Peak detector.
  4. AVG:  $VBW=1/Ton$ , where: Ton is the transmitting duration.
  5. For the transmitting duration, please refer to clause 7.1.
  6. Filter losses were only considered in the spurious frequency bands and the authorized band was not corrected for High Pass Filter losses.
  7. Proper operation of the transmitter prior to adding the filter to the measurement chain.
  8. Since non-restricted band peak emissions are less than the average limit, they also comply with the -27dBm/MHz (68.2dBuV/m) limit.

**UNII-3 BAND**

**HARMONICS AND SPURIOUS EMISSIONS (LOW CHANNEL, HORIZONTAL)**

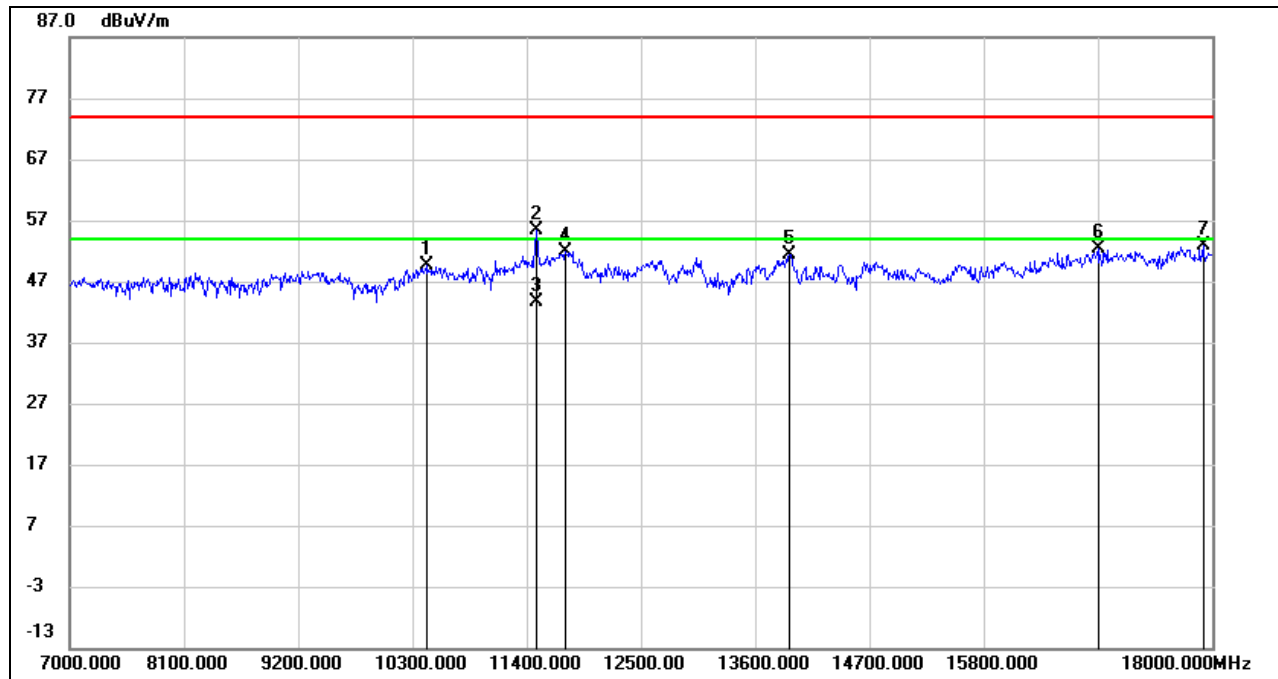

No.	Frequency (MHz)	Reading (dBuV)	Correct (dB/m)	Result (dBuV/m)	Limit (dBuV/m)	Margin (dB)	Remark
1	10443.000	36.78	12.83	49.61	74.00	-24.39	peak
2	11499.000	39.68	15.60	55.28	74.00	-18.72	peak
3	11499.000	27.92	15.60	43.52	54.00	-10.48	AVG
4	11774.000	35.36	16.58	51.94	74.00	-22.06	peak
5	13930.000	33.39	17.97	51.36	74.00	-22.64	peak
6	16900.000	31.30	21.18	52.48	74.00	-21.52	peak
7	17912.000	28.89	23.99	52.88	74.00	-21.12	peak

- Note:
1. Measurement = Reading Level + Correct Factor.
  2. If Peak Result complies with AV limit, AV Result is deemed to comply with AV limit.
  3. Peak: Peak detector.
  4. AVG:  $VBW=1/Ton$ , where: Ton is the transmitting duration.
  5. For the transmitting duration, please refer to clause 7.1.
  6. Filter losses were only considered in the spurious frequency bands and the authorized band was not corrected for High Pass Filter losses.
  7. Proper operation of the transmitter prior to adding the filter to the measurement chain.
  8. Since non-restricted band peak emissions are less than the average limit, they also comply with the -27dBm/MHz (68.2dBuV/m) limit.

### HARMONICS AND SPURIOUS EMISSIONS (LOW CHANNEL, VERTICAL)

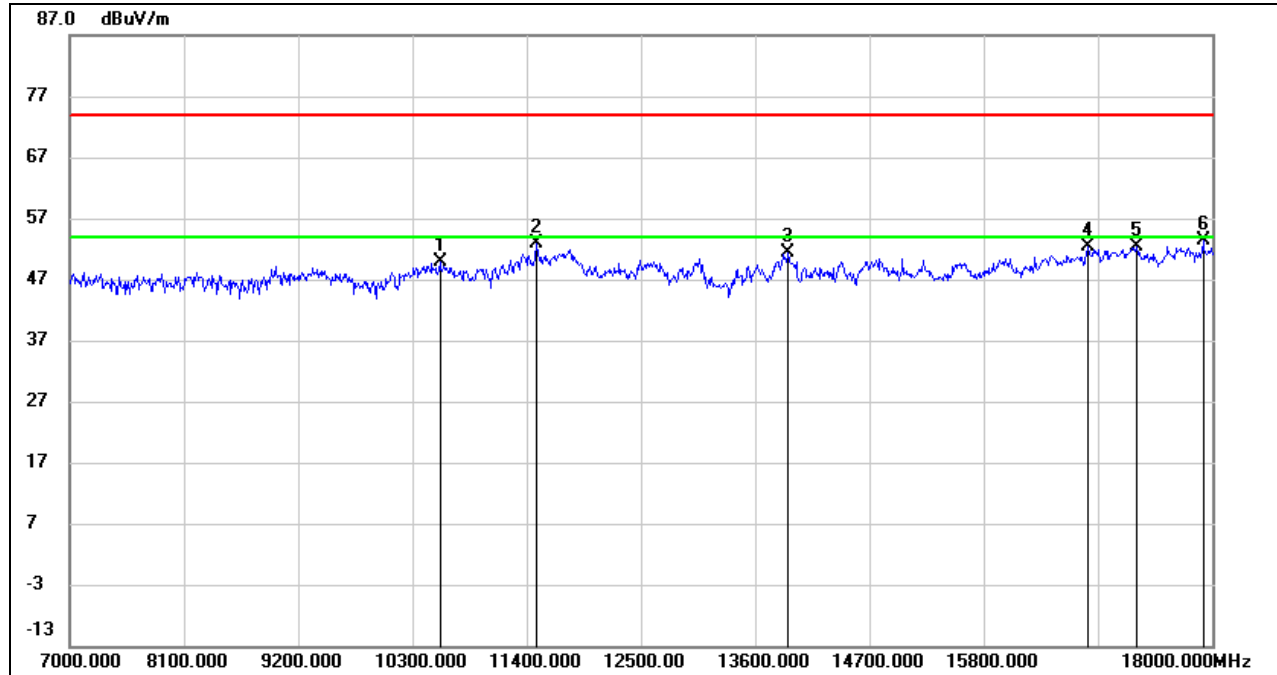

No.	Frequency (MHz)	Reading (dBuV)	Correct (dB/m)	Result (dBuV/m)	Limit (dBuV/m)	Margin (dB)	Remark
1	10564.000	36.52	13.33	49.85	74.00	-24.15	peak
2	11488.000	37.22	15.58	52.80	74.00	-21.20	peak
3	13919.000	33.33	17.97	51.30	74.00	-22.70	peak
4	16801.000	31.34	21.00	52.34	74.00	-21.66	peak
5	17274.000	30.10	22.24	52.34	74.00	-21.66	peak
6	17912.000	29.49	23.99	53.48	74.00	-20.52	peak

- Note:
1. Measurement = Reading Level + Correct Factor.
  2. If Peak Result complies with AV limit, AV Result is deemed to comply with AV limit.
  3. Peak: Peak detector.
  4. AVG:  $VBW=1/Ton$ , where: Ton is the transmitting duration.
  5. For the transmitting duration, please refer to clause 7.1.
  6. Filter losses were only considered in the spurious frequency bands and the authorized band was not corrected for High Pass Filter losses.
  7. Proper operation of the transmitter prior to adding the filter to the measurement chain.
  8. Since non-restricted band peak emissions are less than the average limit, they also comply with the -27dBm/MHz (68.2dBuV/m) limit.

**HARMONICS AND SPURIOUS EMISSIONS (MID CHANNEL, HORIZONTAL)**

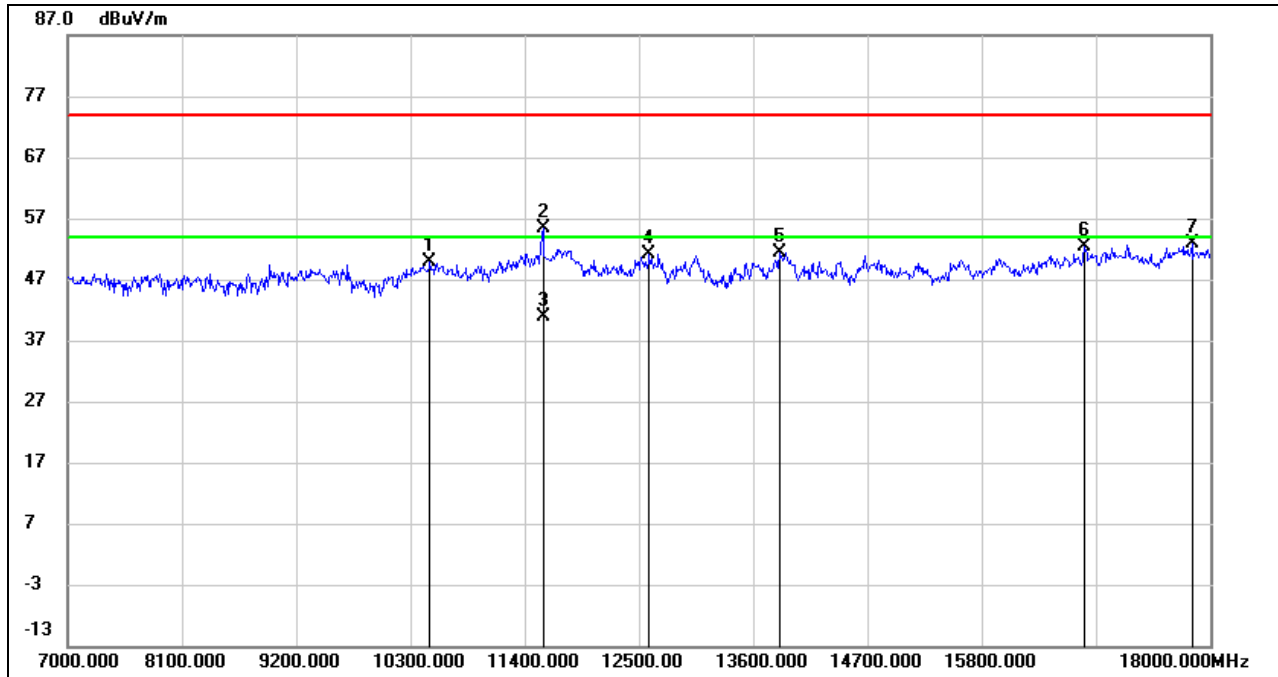

No.	Frequency (MHz)	Reading (dBuV)	Correct (dB/m)	Result (dBuV/m)	Limit (dBuV/m)	Margin (dB)	Remark
1	10487.000	36.78	13.03	49.81	74.00	-24.19	peak
2	11576.000	39.52	15.75	55.27	74.00	-18.73	peak
3	11576.000	25.01	15.75	40.76	54.00	-13.24	AVG
4	12599.000	34.24	16.83	51.07	74.00	-22.93	peak
5	13853.000	33.27	18.05	51.32	74.00	-22.68	peak
6	16790.000	31.33	20.99	52.32	74.00	-21.68	peak
7	17824.000	28.83	23.95	52.78	74.00	-21.22	peak

Note: 1. Measurement = Reading Level + Correct Factor.  
 2. If Peak Result complies with AV limit, AV Result is deemed to comply with AV limit.  
 3. Peak: Peak detector.  
 4. AVG: VBW=1/Ton, where: Ton is the transmitting duration.  
 5. For the transmitting duration, please refer to clause 7.1.  
 6. Filter losses were only considered in the spurious frequency bands and the authorized band was not corrected for High Pass Filter losses.  
 7. Proper operation of the transmitter prior to adding the filter to the measurement chain.  
 8. Since non-restricted band peak emissions are less than the average limit, they also comply with the -27dBm/MHz (68.2dBuV/m) limit.

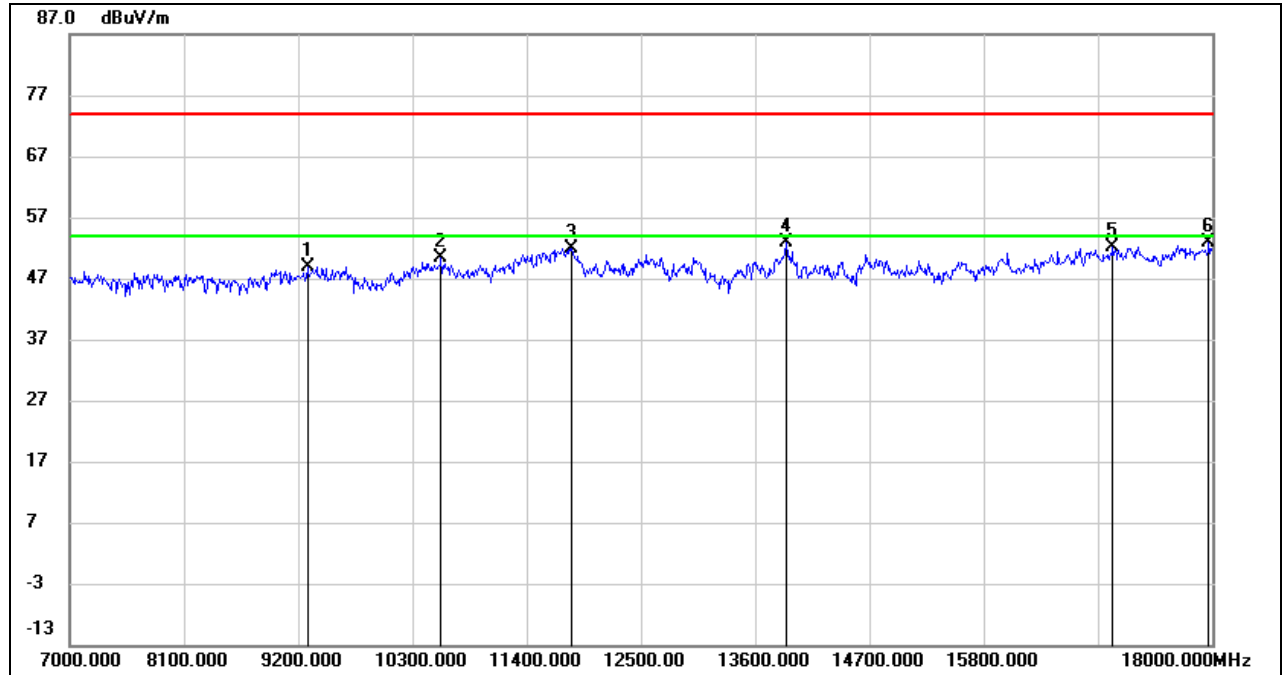

**HARMONICS AND SPURIOUS EMISSIONS (MID CHANNEL, VERTICAL)**

No.	Frequency (MHz)	Reading (dBuV)	Correct (dB/m)	Result (dBuV/m)	Limit (dBuV/m)	Margin (dB)	Remark
1	9288.000	37.88	10.95	48.83	74.00	-25.17	peak
2	10575.000	37.04	13.36	50.40	74.00	-23.60	peak
3	11829.000	35.30	16.67	51.97	74.00	-22.03	peak
4	13897.000	34.78	18.00	52.78	74.00	-21.22	peak
5	17043.000	30.46	21.60	52.06	74.00	-21.94	peak
6	17967.000	28.98	24.00	52.98	74.00	-21.02	peak

Note: 1. Measurement = Reading Level + Correct Factor.

2. If Peak Result complies with AV limit, AV Result is deemed to comply with AV limit.

3. Peak: Peak detector.

4. AVG:  $VBW=1/Ton$ , where: Ton is the transmitting duration.

5. For the transmitting duration, please refer to clause 7.1.

6. Filter losses were only considered in the spurious frequency bands and the authorized band was not corrected for High Pass Filter losses.

7. Proper operation of the transmitter prior to adding the filter to the measurement chain.

8. Since non-restricted band peak emissions are less than the average limit, they also comply with the -27dBm/MHz (68.2dBuV/m) limit.

**HARMONICS AND SPURIOUS EMISSIONS (HIGH CHANNEL, HORIZONTAL)**

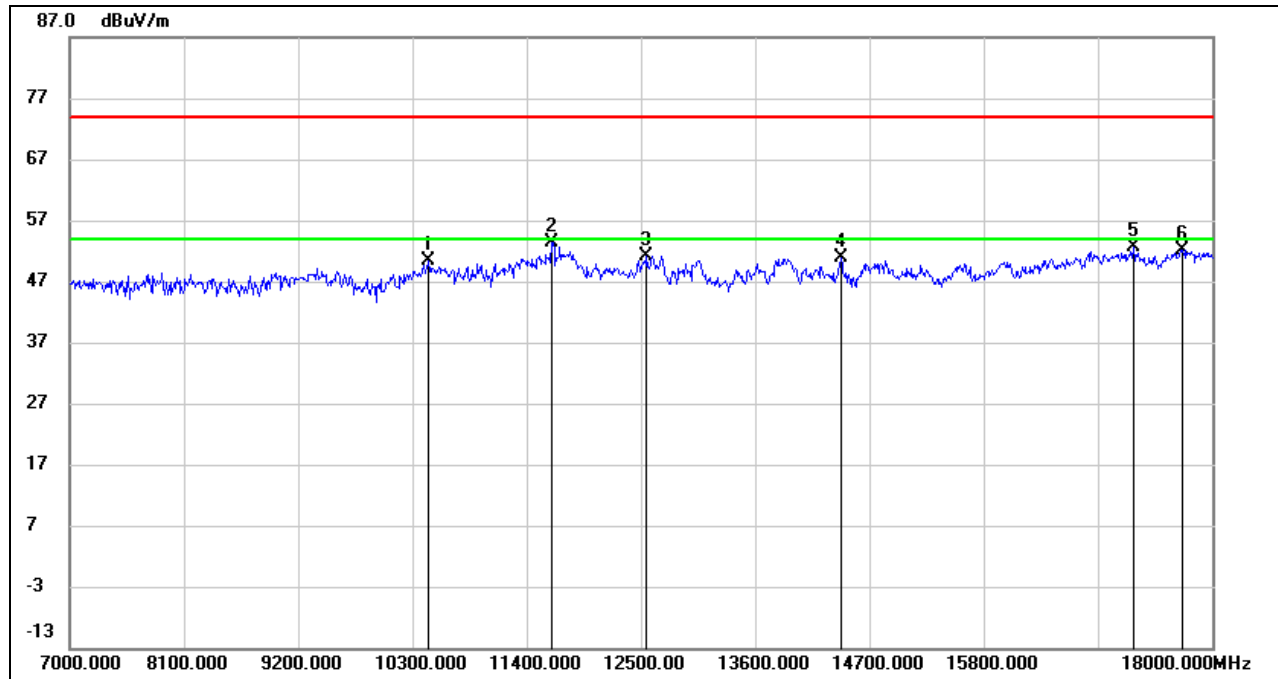

No.	Frequency (MHz)	Reading (dBuV)	Correct (dB/m)	Result (dBuV/m)	Limit (dBuV/m)	Margin (dB)	Remark
1	10454.000	37.43	12.88	50.31	74.00	-23.69	peak
2	11642.000	37.47	15.98	53.45	74.00	-20.55	peak
3	12555.000	34.37	16.78	51.15	74.00	-22.85	peak
4	14425.000	33.05	17.89	50.94	74.00	-23.06	peak
5	17241.000	30.17	22.34	52.51	74.00	-21.49	peak
6	17714.000	28.87	23.34	52.21	74.00	-21.79	peak

- Note:
1. Measurement = Reading Level + Correct Factor.
  2. If Peak Result complies with AV limit, AV Result is deemed to comply with AV limit.
  3. Peak: Peak detector.
  4. AVG:  $VBW=1/Ton$ , where: Ton is the transmitting duration.
  5. For the transmitting duration, please refer to clause 7.1.
  6. Filter losses were only considered in the spurious frequency bands and the authorized band was not corrected for High Pass Filter losses.
  7. Proper operation of the transmitter prior to adding the filter to the measurement chain.
  8. Since non-restricted band peak emissions are less than the average limit, they also comply with the -27dBm/MHz (68.2dBuV/m) limit.

### HARMONICS AND SPURIOUS EMISSIONS (HIGH CHANNEL, VERTICAL)

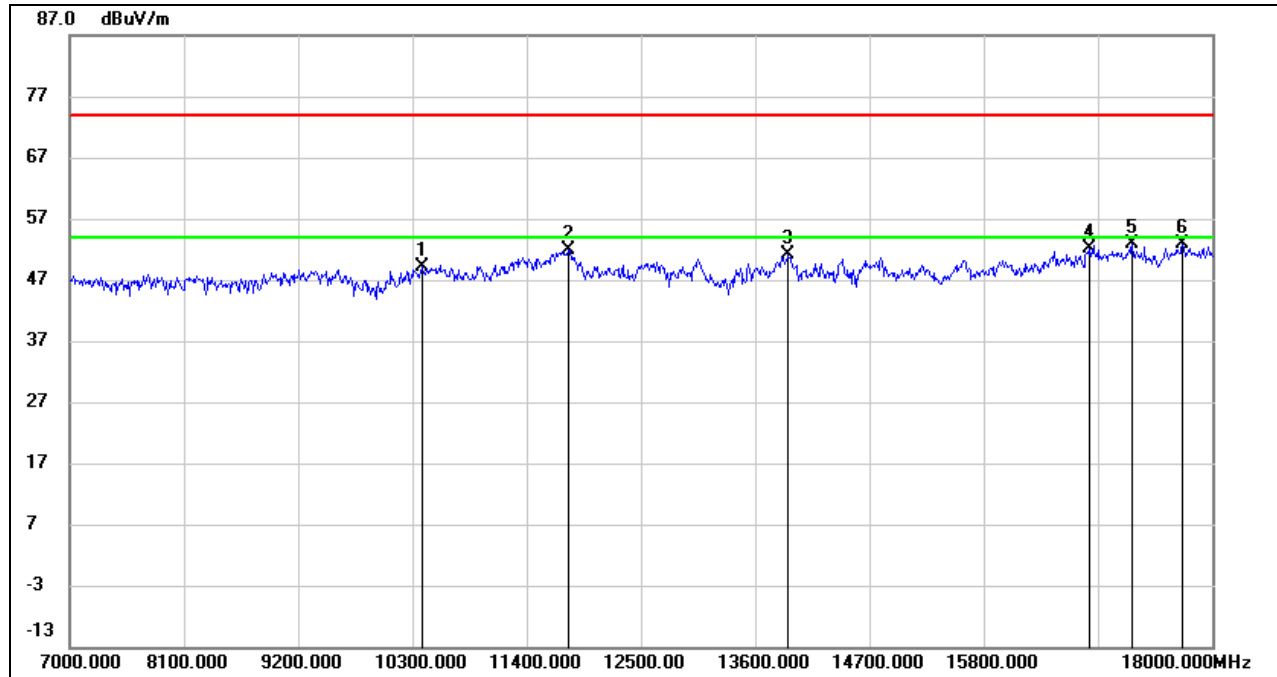

No.	Frequency (MHz)	Reading (dBuV)	Correct (dB/m)	Result (dBuV/m)	Limit (dBuV/m)	Margin (dB)	Remark
1	10388.000	36.45	12.57	49.02	74.00	-24.98	peak
2	11807.000	35.24	16.70	51.94	74.00	-22.06	peak
3	13919.000	33.18	17.97	51.15	74.00	-22.85	peak
4	16823.000	31.10	21.05	52.15	74.00	-21.85	peak
5	17230.000	30.43	22.37	52.80	74.00	-21.20	peak
6	17714.000	29.46	23.34	52.80	74.00	-21.20	peak

- Note:
1. Measurement = Reading Level + Correct Factor.
  2. If Peak Result complies with AV limit, AV Result is deemed to comply with AV limit.
  3. Peak: Peak detector.
  4. AVG:  $VBW=1/Ton$ , where: Ton is the transmitting duration.
  5. For the transmitting duration, please refer to clause 7.1.
  6. Filter losses were only considered in the spurious frequency bands and the authorized band was not corrected for High Pass Filter losses.
  7. Proper operation of the transmitter prior to adding the filter to the measurement chain.
  8. Since non-restricted band peak emissions are less than the average limit, they also comply with the  $-27dBm/MHz$  ( $68.2dBuV/m$ ) limit.

### 8.3.5. 802.11ax HE40 SISO MODE

#### UNII-1 BAND

#### HARMONICS AND SPURIOUS EMISSIONS (LOW CHANNEL, HORIZONTAL)

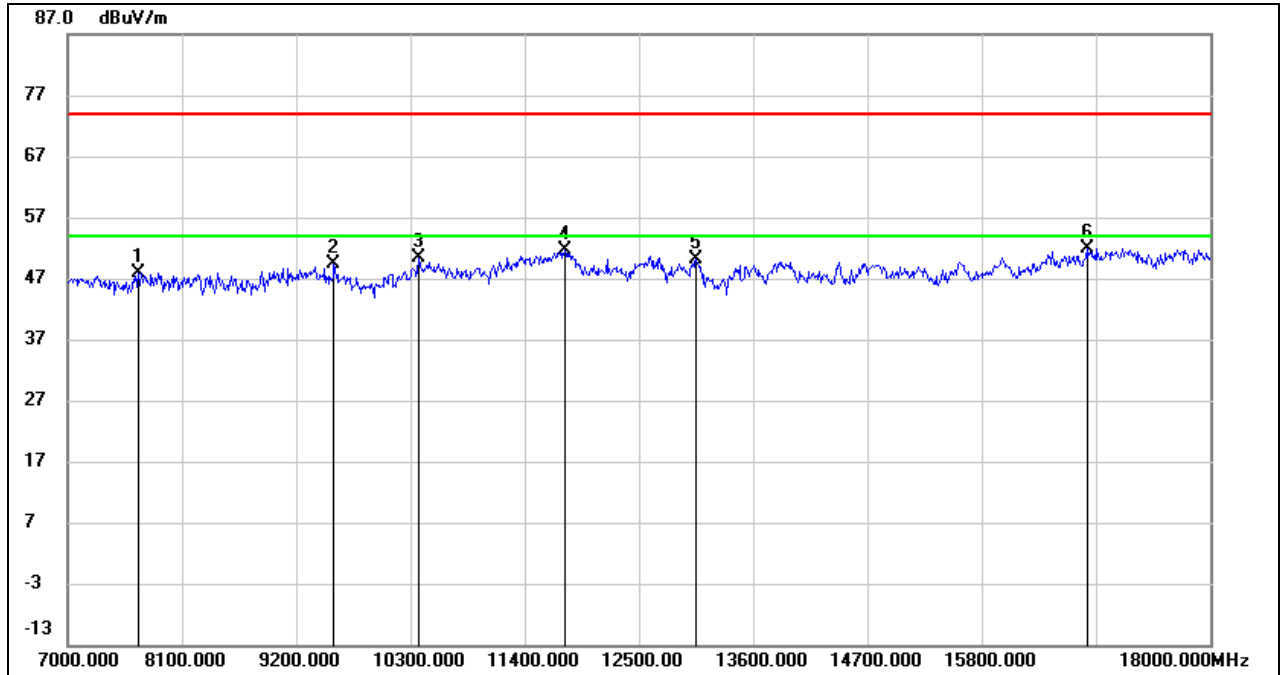

No.	Frequency (MHz)	Reading (dBuV)	Correct (dB/m)	Result (dBuV/m)	Limit (dBuV/m)	Margin (dB)	Remark
1	7682.000	38.85	9.06	47.91	74.00	-26.09	peak
2	9563.000	37.45	11.87	49.32	74.00	-24.68	peak
3	10377.000	37.80	12.52	50.32	74.00	-23.68	peak
4	11785.000	34.94	16.63	51.57	74.00	-22.43	peak
5	13050.000	33.21	16.83	50.04	74.00	-23.96	peak
6	16812.000	30.79	21.02	51.81	74.00	-22.19	peak

- Note: 1. Measurement = Reading Level + Correct Factor.  
 2. If Peak Result complies with AV limit, AV Result is deemed to comply with AV limit.  
 3. Peak: Peak detector.  
 4. AVG:  $VBW=1/Ton$ , where: Ton is the transmitting duration.  
 5. For the transmitting duration, please refer to clause 7.1.  
 6. Filter losses were only considered in the spurious frequency bands and the authorized band was not corrected for High Pass Filter losses.  
 7. Proper operation of the transmitter prior to adding the filter to the measurement chain.  
 8. Since non-restricted band peak emissions are less than the average limit, they also comply with the -27dBm/MHz (68.2dBuV/m) limit.

**HARMONICS AND SPURIOUS EMISSIONS (LOW CHANNEL, VERTICAL)**

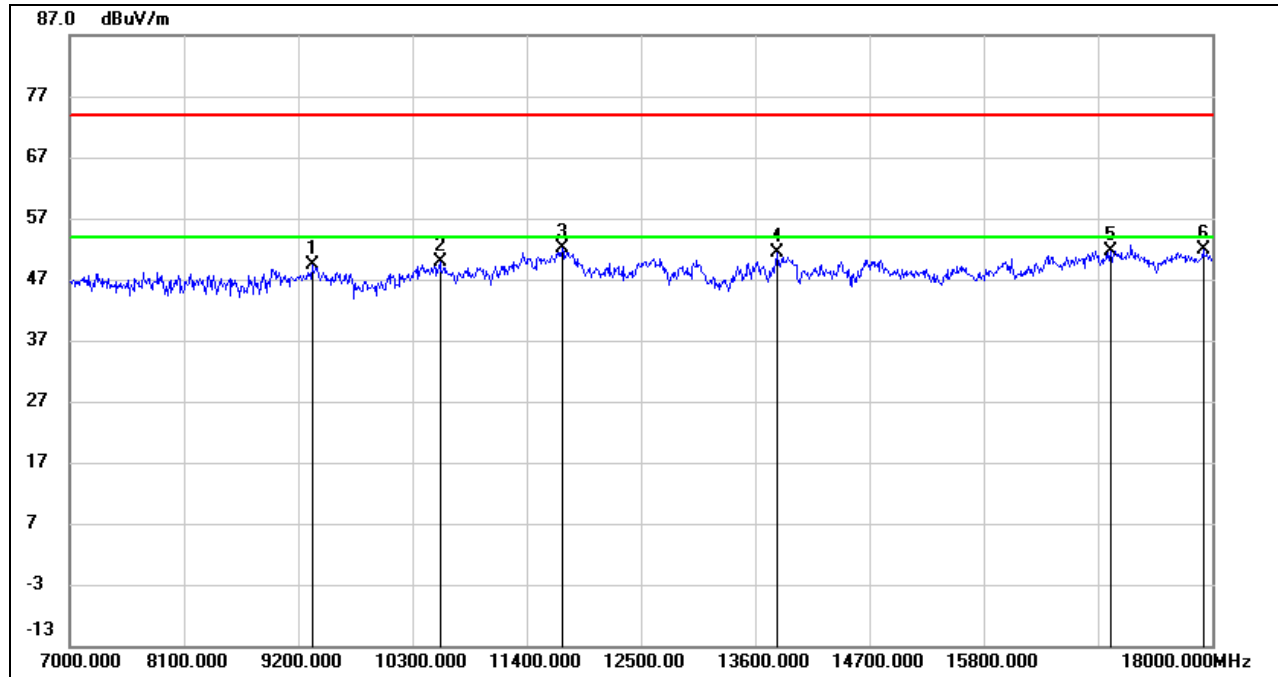

No.	Frequency (MHz)	Reading (dBuV)	Correct (dB/m)	Result (dBuV/m)	Limit (dBuV/m)	Margin (dB)	Remark
1	9332.000	38.32	11.15	49.47	74.00	-24.53	peak
2	10564.000	36.43	13.33	49.76	74.00	-24.24	peak
3	11741.000	35.62	16.43	52.05	74.00	-21.95	peak
4	13809.000	33.21	18.11	51.32	74.00	-22.68	peak
5	17021.000	30.20	21.49	51.69	74.00	-22.31	peak
6	17912.000	27.80	23.99	51.79	74.00	-22.21	peak

- Note: 1. Measurement = Reading Level + Correct Factor.  
 2. If Peak Result complies with AV limit, AV Result is deemed to comply with AV limit.  
 3. Peak: Peak detector.  
 4. AVG:  $VBW=1/Ton$ , where: Ton is the transmitting duration.  
 5. For the transmitting duration, please refer to clause 7.1.  
 6. Filter losses were only considered in the spurious frequency bands and the authorized band was not corrected for High Pass Filter losses.  
 7. Proper operation of the transmitter prior to adding the filter to the measurement chain.  
 8. Since non-restricted band peak emissions are less than the average limit, they also comply with the -27dBm/MHz (68.2dBuV/m) limit.

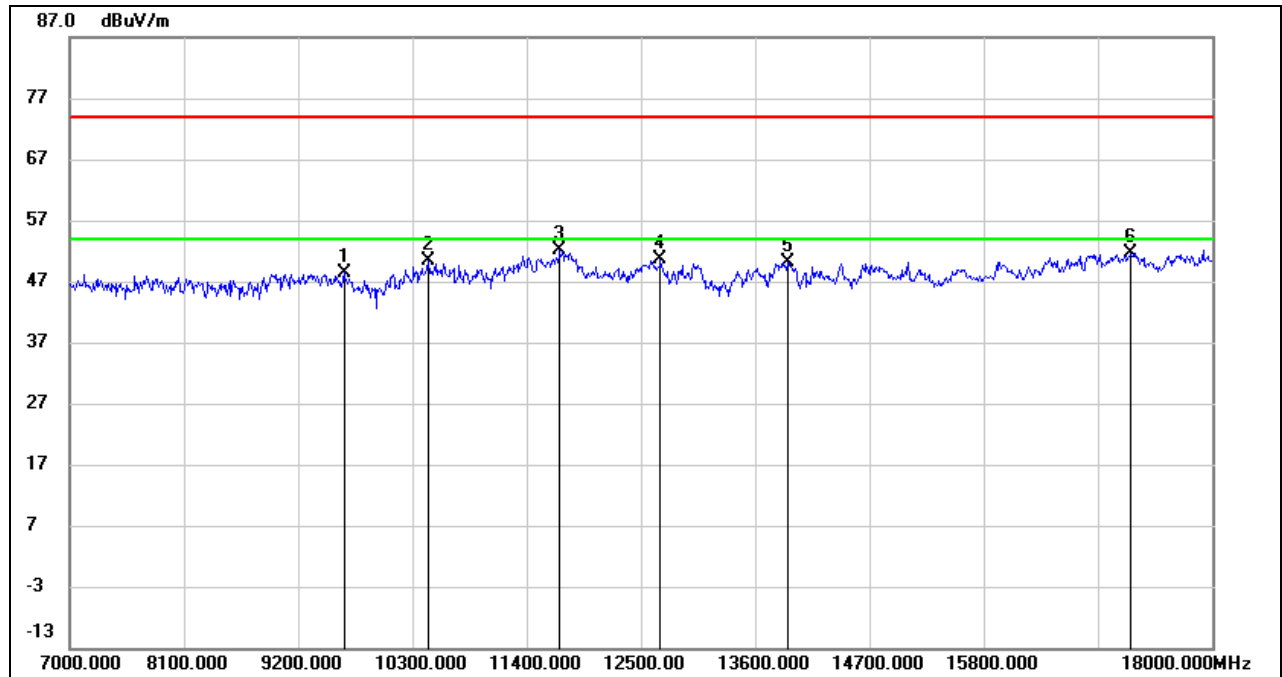
**HARMONICS AND SPURIOUS EMISSIONS (HIGH CHANNEL, HORIZONTAL)**

No.	Frequency (MHz)	Reading (dBuV)	Correct (dB/m)	Result (dBuV/m)	Limit (dBuV/m)	Margin (dB)	Remark
1	9640.000	36.71	11.79	48.50	74.00	-25.50	peak
2	10454.000	37.40	12.88	50.28	74.00	-23.72	peak
3	11719.000	35.73	16.34	52.07	74.00	-21.93	peak
4	12687.000	33.71	16.82	50.53	74.00	-23.47	peak
5	13908.000	32.19	17.99	50.18	74.00	-23.82	peak
6	17219.000	29.23	22.41	51.64	74.00	-22.36	peak

- Note: 1. Measurement = Reading Level + Correct Factor.  
 2. If Peak Result complies with AV limit, AV Result is deemed to comply with AV limit.  
 3. Peak: Peak detector.  
 4. AVG:  $VBW=1/Ton$ , where: Ton is the transmitting duration.  
 5. For the transmitting duration, please refer to clause 7.1.  
 6. Filter losses were only considered in the spurious frequency bands and the authorized band was not corrected for High Pass Filter losses.  
 7. Proper operation of the transmitter prior to adding the filter to the measurement chain.  
 8. Since non-restricted band peak emissions are less than the average limit, they also comply with the -27dBm/MHz (68.2dBuV/m) limit.

**HARMONICS AND SPURIOUS EMISSIONS (HIGH CHANNEL, VERTICAL)**

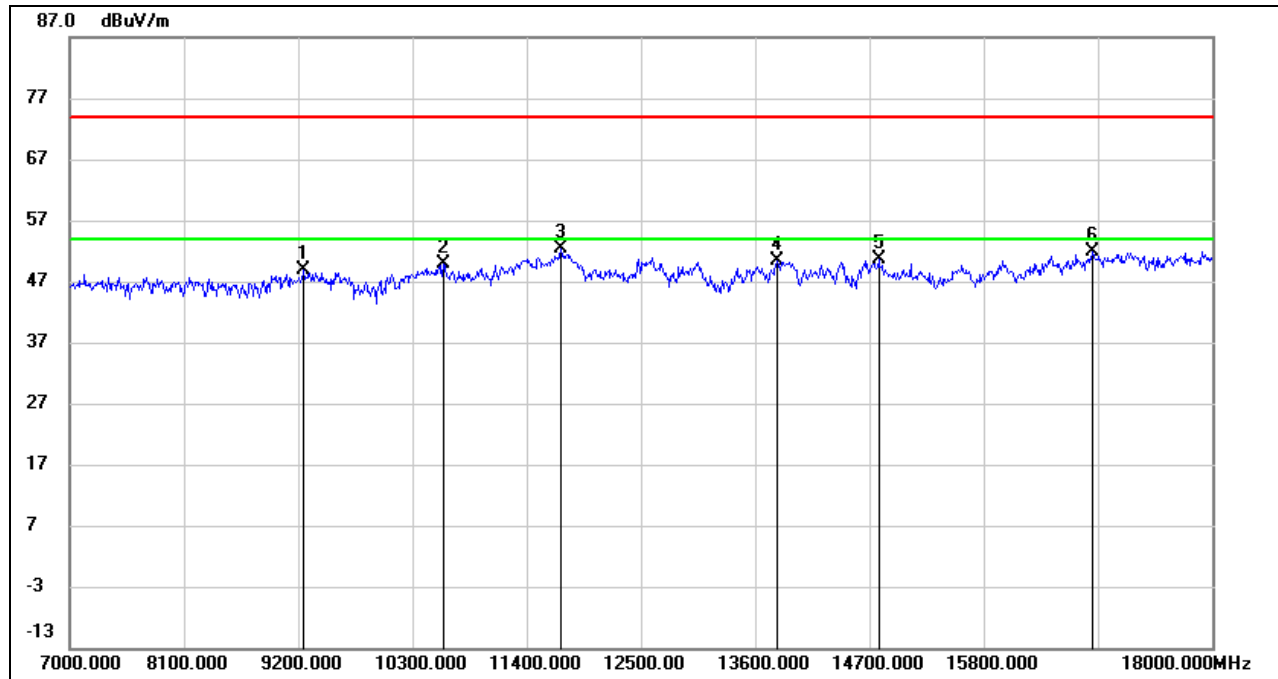

No.	Frequency (MHz)	Reading (dBuV)	Correct (dB/m)	Result (dBuV/m)	Limit (dBuV/m)	Margin (dB)	Remark
1	9255.000	37.96	10.80	48.76	74.00	-25.24	peak
2	10597.000	36.40	13.45	49.85	74.00	-24.15	peak
3	11730.000	36.10	16.39	52.49	74.00	-21.51	peak
4	13809.000	32.22	18.11	50.33	74.00	-23.67	peak
5	14788.000	32.76	17.80	50.56	74.00	-23.44	peak
6	16845.000	30.81	21.09	51.90	74.00	-22.10	peak

- Note: 1. Measurement = Reading Level + Correct Factor.  
 2. If Peak Result complies with AV limit, AV Result is deemed to comply with AV limit.  
 3. Peak: Peak detector.  
 4. AVG:  $VBW=1/Ton$ , where: Ton is the transmitting duration.  
 5. For the transmitting duration, please refer to clause 7.1.  
 6. Filter losses were only considered in the spurious frequency bands and the authorized band was not corrected for High Pass Filter losses.  
 7. Proper operation of the transmitter prior to adding the filter to the measurement chain.  
 8. Since non-restricted band peak emissions are less than the average limit, they also comply with the -27dBm/MHz (68.2dBuV/m) limit.



**UNII-2A BAND**

**HARMONICS AND SPURIOUS EMISSIONS (LOW CHANNEL, HORIZONTAL)**

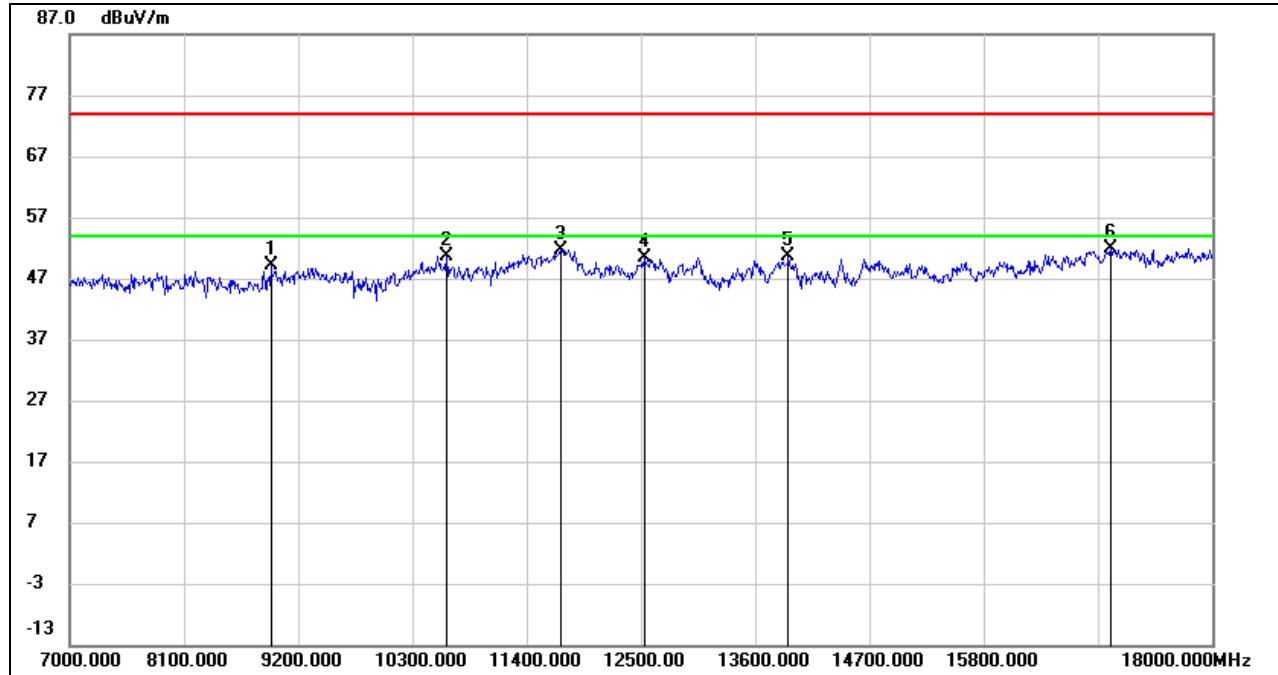

No.	Frequency (MHz)	Reading (dBuV)	Correct (dB/m)	Result (dBuV/m)	Limit (dBuV/m)	Margin (dB)	Remark
1	8936.000	37.95	11.10	49.05	74.00	-24.95	peak
2	10630.000	37.19	13.52	50.71	74.00	-23.29	peak
3	11730.000	35.35	16.39	51.74	74.00	-22.26	peak
4	12533.000	33.66	16.76	50.42	74.00	-23.58	peak
5	13919.000	32.54	17.97	50.51	74.00	-23.49	peak
6	17021.000	30.50	21.49	51.99	74.00	-22.01	peak

- Note:
1. Measurement = Reading Level + Correct Factor.
  2. If Peak Result complies with AV limit, AV Result is deemed to comply with AV limit.
  3. Peak: Peak detector.
  4. AVG: VBW=1/Ton, where: Ton is the transmitting duration.
  5. For the transmitting duration, please refer to clause 7.1.
  6. Filter losses were only considered in the spurious frequency bands and the authorized band was not corrected for High Pass Filter losses.
  7. Proper operation of the transmitter prior to adding the filter to the measurement chain.
  8. Since non-restricted band peak emissions are less than the average limit, they also comply with the -27dBm/MHz (68.2dBuV/m) limit.



**HARMONICS AND SPURIOUS EMISSIONS (LOW CHANNEL, VERTICAL)**

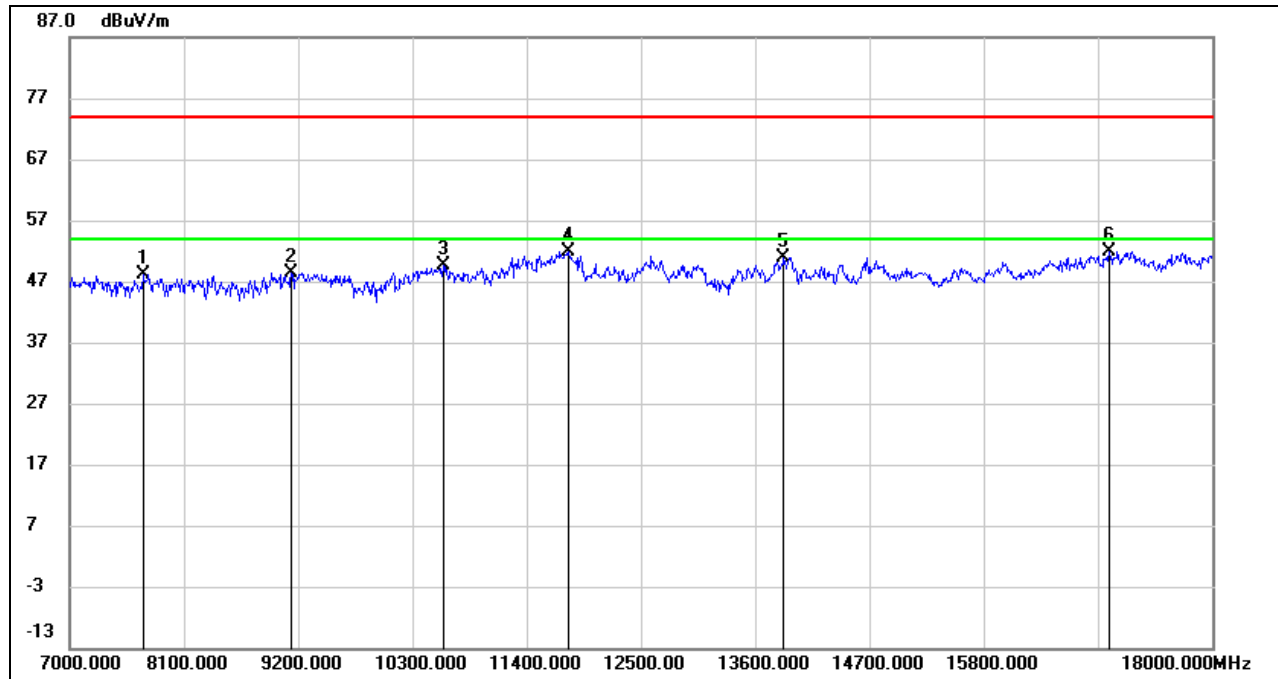

No.	Frequency (MHz)	Reading (dBuV)	Correct (dB/m)	Result (dBuV/m)	Limit (dBuV/m)	Margin (dB)	Remark
1	7704.000	39.06	9.13	48.19	74.00	-25.81	peak
2	9134.000	37.43	10.95	48.38	74.00	-25.62	peak
3	10597.000	36.18	13.45	49.63	74.00	-24.37	peak
4	11807.000	35.29	16.70	51.99	74.00	-22.01	peak
5	13875.000	32.87	18.04	50.91	74.00	-23.09	peak
6	17010.000	30.45	21.43	51.88	74.00	-22.12	peak

- Note:
1. Measurement = Reading Level + Correct Factor.
  2. If Peak Result complies with AV limit, AV Result is deemed to comply with AV limit.
  3. Peak: Peak detector.
  4. AVG:  $VBW=1/Ton$ , where: Ton is the transmitting duration.
  5. For the transmitting duration, please refer to clause 7.1.
  6. Filter losses were only considered in the spurious frequency bands and the authorized band was not corrected for High Pass Filter losses.
  7. Proper operation of the transmitter prior to adding the filter to the measurement chain.
  8. Since non-restricted band peak emissions are less than the average limit, they also comply with the -27dBm/MHz (68.2dBuV/m) limit.



**HARMONICS AND SPURIOUS EMISSIONS (HIGH CHANNEL, HORIZONTAL)**

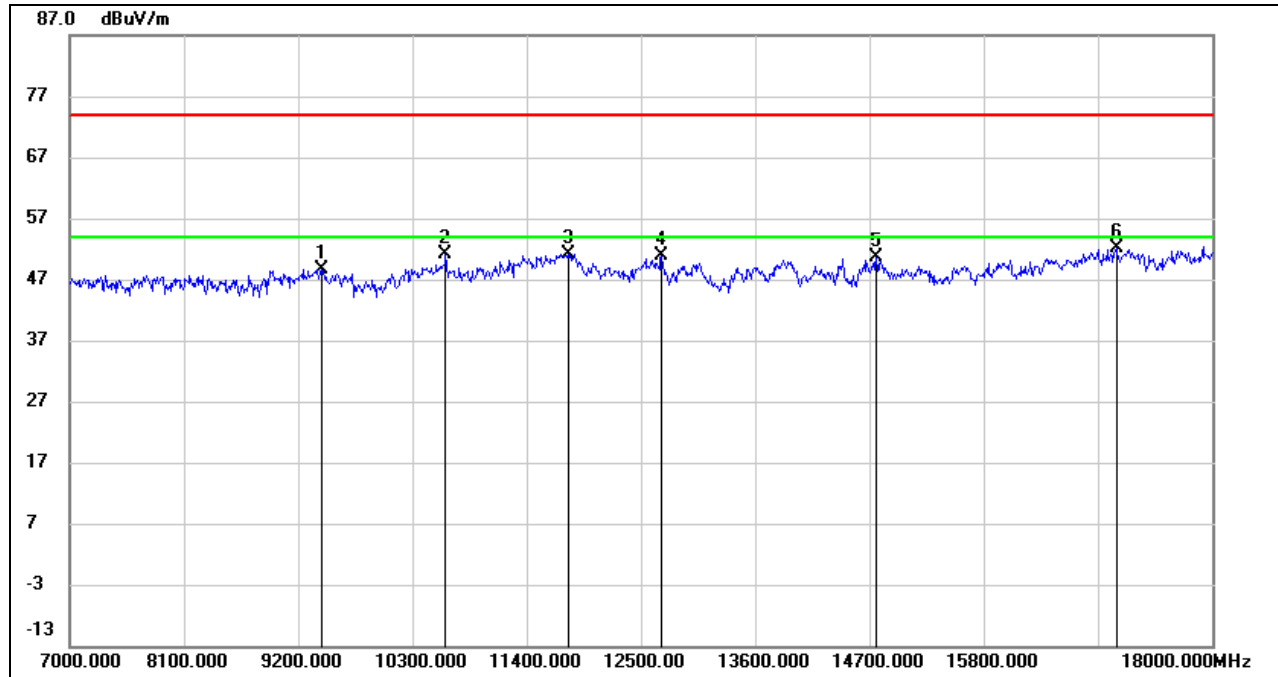

No.	Frequency (MHz)	Reading (dBuV)	Correct (dB/m)	Result (dBuV/m)	Limit (dBuV/m)	Margin (dB)	Remark
1	9420.000	37.18	11.50	48.68	74.00	-25.32	peak
2	10619.000	37.69	13.50	51.19	74.00	-22.81	peak
3	11796.000	34.54	16.69	51.23	74.00	-22.77	peak
4	12698.000	34.06	16.81	50.87	74.00	-23.13	peak
5	14766.000	32.73	17.78	50.51	74.00	-23.49	peak
6	17076.000	30.32	21.79	52.11	74.00	-21.89	peak

- Note:
1. Measurement = Reading Level + Correct Factor.
  2. If Peak Result complies with AV limit, AV Result is deemed to comply with AV limit.
  3. Peak: Peak detector.
  4. AVG:  $VBW=1/Ton$ , where: Ton is the transmitting duration.
  5. For the transmitting duration, please refer to clause 7.1.
  6. Filter losses were only considered in the spurious frequency bands and the authorized band was not corrected for High Pass Filter losses.
  7. Proper operation of the transmitter prior to adding the filter to the measurement chain.
  8. Since non-restricted band peak emissions are less than the average limit, they also comply with the -27dBm/MHz (68.2dBuV/m) limit.

**HARMONICS AND SPURIOUS EMISSIONS (HIGH CHANNEL, VERTICAL)**

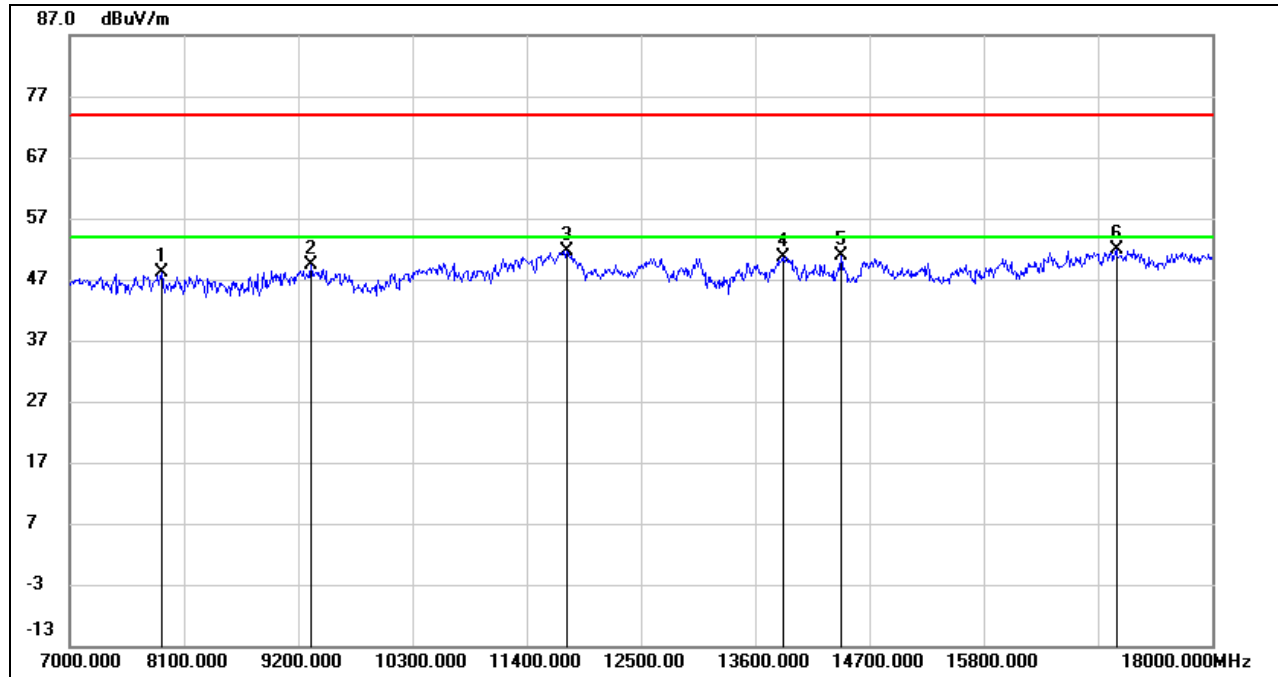

No.	Frequency (MHz)	Reading (dBuV)	Correct (dB/m)	Result (dBuV/m)	Limit (dBuV/m)	Margin (dB)	Remark
1	7891.000	38.77	9.24	48.01	74.00	-25.99	peak
2	9321.000	38.16	11.10	49.26	74.00	-24.74	peak
3	11785.000	35.04	16.63	51.67	74.00	-22.33	peak
4	13864.000	32.54	18.03	50.57	74.00	-23.43	peak
5	14425.000	32.94	17.89	50.83	74.00	-23.17	peak
6	17076.000	30.21	21.79	52.00	74.00	-22.00	peak

- Note:
1. Measurement = Reading Level + Correct Factor.
  2. If Peak Result complies with AV limit, AV Result is deemed to comply with AV limit.
  3. Peak: Peak detector.
  4. AVG:  $VBW=1/Ton$ , where: Ton is the transmitting duration.
  5. For the transmitting duration, please refer to clause 7.1.
  6. Filter losses were only considered in the spurious frequency bands and the authorized band was not corrected for High Pass Filter losses.
  7. Proper operation of the transmitter prior to adding the filter to the measurement chain.
  8. Since non-restricted band peak emissions are less than the average limit, they also comply with the -27dBm/MHz (68.2dBuV/m) limit.



**UNII-2C BAND**

**HARMONICS AND SPURIOUS EMISSIONS (LOW CHANNEL, HORIZONTAL)**

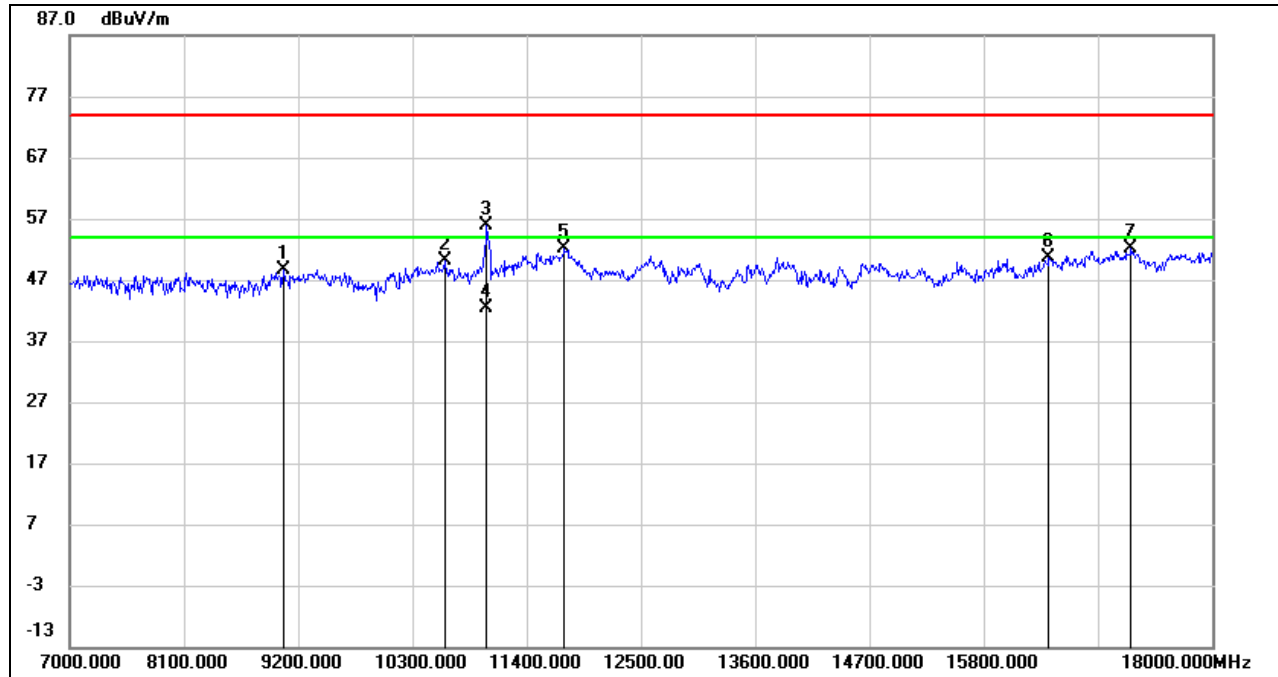

No.	Frequency (MHz)	Reading (dBuV)	Correct (dB/m)	Result (dBuV/m)	Limit (dBuV/m)	Margin (dB)	Remark
1	9057.000	37.23	11.40	48.63	74.00	-25.37	peak
2	10608.000	36.59	13.47	50.06	74.00	-23.94	peak
3	11015.000	41.47	14.45	55.92	74.00	-18.08	peak
4	11015.000	27.83	14.45	42.28	54.00	-11.72	AVG
5	11763.000	35.50	16.53	52.03	74.00	-21.97	peak
6	16427.000	30.74	19.93	50.67	74.00	-23.33	peak
7	17219.000	29.65	22.41	52.06	74.00	-21.94	peak

Note: 1. Measurement = Reading Level + Correct Factor.  
 2. If Peak Result complies with AV limit, AV Result is deemed to comply with AV limit.  
 3. Peak: Peak detector.  
 4. AVG: VBW=1/Ton, where: Ton is the transmitting duration.  
 5. For the transmitting duration, please refer to clause 7.1.  
 6. Filter losses were only considered in the spurious frequency bands and the authorized band was not corrected for High Pass Filter losses.  
 7. Proper operation of the transmitter prior to adding the filter to the measurement chain.  
 8. Since non-restricted band peak emissions are less than the average limit, they also comply with the -27dBm/MHz (68.2dBuV/m) limit.



**HARMONICS AND SPURIOUS EMISSIONS (LOW CHANNEL, VERTICAL)**

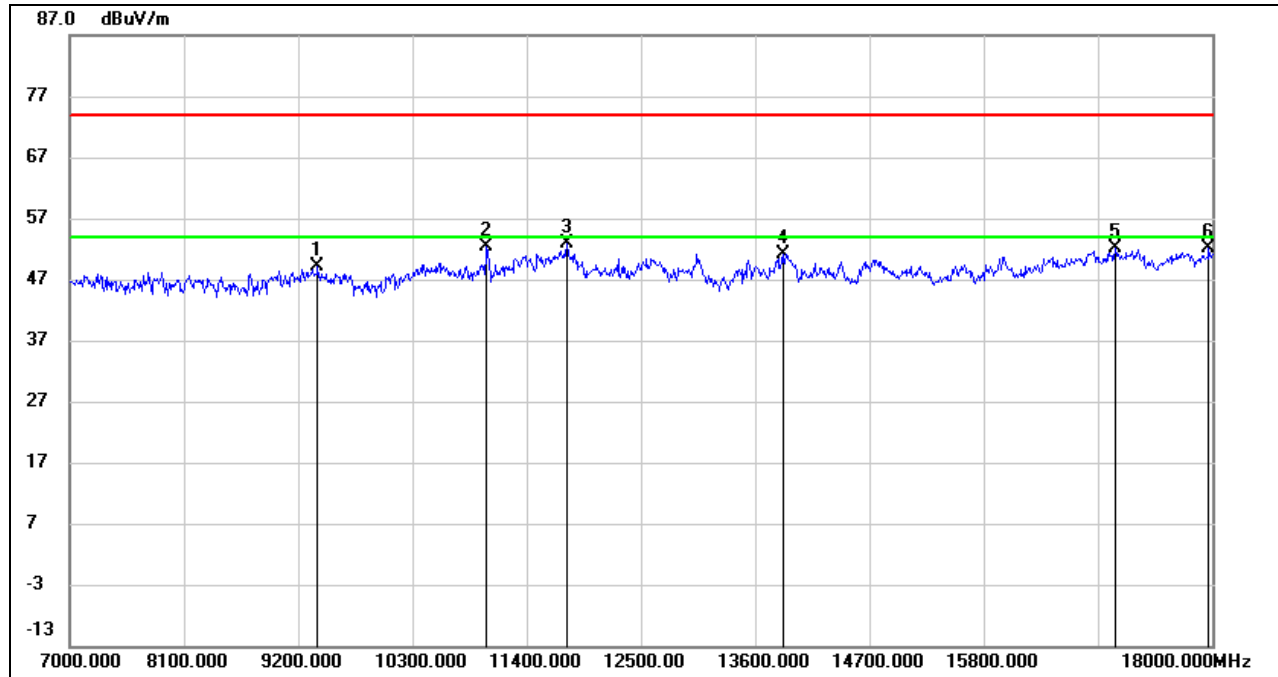

No.	Frequency (MHz)	Reading (dBuV)	Correct (dB/m)	Result (dBuV/m)	Limit (dBuV/m)	Margin (dB)	Remark
1	9387.000	37.65	11.38	49.03	74.00	-24.97	peak
2	11015.000	38.02	14.45	52.47	74.00	-21.53	peak
3	11785.000	36.35	16.63	52.98	74.00	-21.02	peak
4	13864.000	33.21	18.03	51.24	74.00	-22.76	peak
5	17065.000	30.30	21.73	52.03	74.00	-21.97	peak
6	17967.000	28.11	24.00	52.11	74.00	-21.89	peak

Note: 1. Measurement = Reading Level + Correct Factor.  
 2. If Peak Result complies with AV limit, AV Result is deemed to comply with AV limit.  
 3. Peak: Peak detector.  
 4. AVG:  $VBW=1/Ton$ , where: Ton is the transmitting duration.  
 5. For the transmitting duration, please refer to clause 7.1.  
 6. Filter losses were only considered in the spurious frequency bands and the authorized band was not corrected for High Pass Filter losses.  
 7. Proper operation of the transmitter prior to adding the filter to the measurement chain.  
 8. Since non-restricted band peak emissions are less than the average limit, they also comply with the -27dBm/MHz (68.2dBuV/m) limit.

**HARMONICS AND SPURIOUS EMISSIONS (MID CHANNEL, HORIZONTAL)**

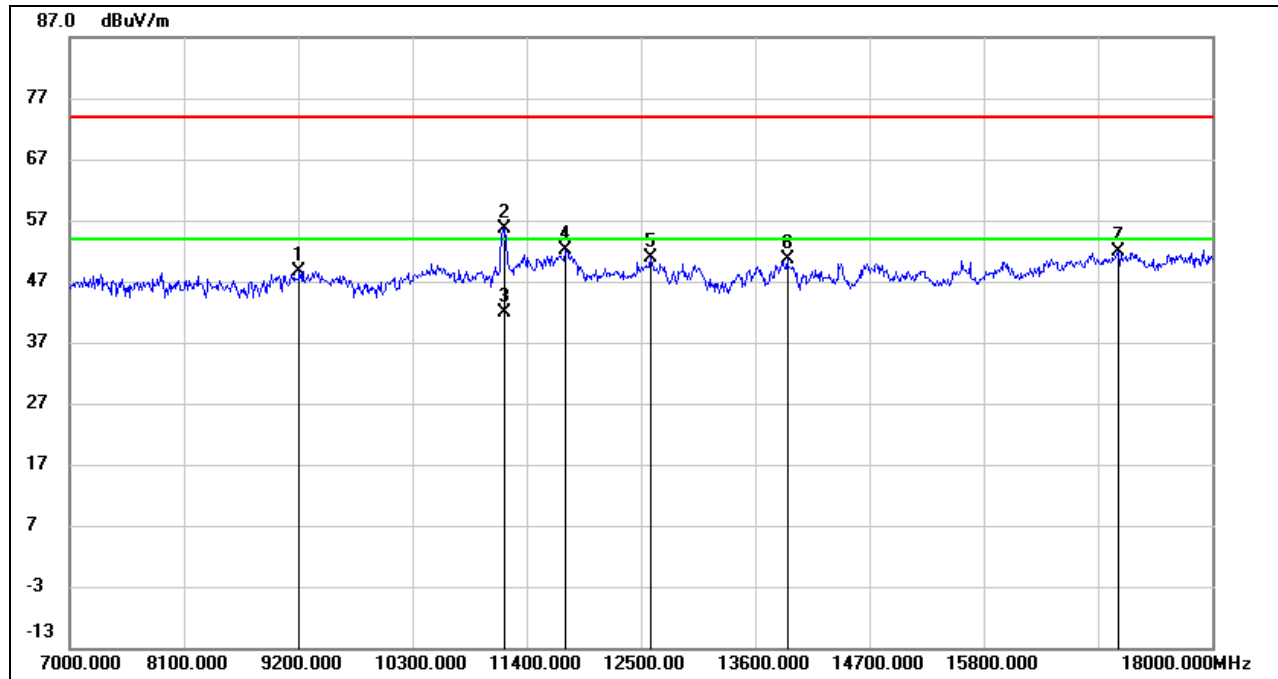

No.	Frequency (MHz)	Reading (dBuV)	Correct (dB/m)	Result (dBuV/m)	Limit (dBuV/m)	Margin (dB)	Remark
1	9211.000	38.13	10.61	48.74	74.00	-25.26	peak
2	11191.000	40.77	14.89	55.66	74.00	-18.34	peak
3	11191.000	27.05	14.89	41.94	54.00	-12.06	AVG
4	11774.000	35.45	16.58	52.03	74.00	-21.97	peak
5	12588.000	33.96	16.81	50.77	74.00	-23.23	peak
6	13908.000	32.68	17.99	50.67	74.00	-23.33	peak
7	17098.000	30.07	21.91	51.98	74.00	-22.02	peak

Note: 1. Measurement = Reading Level + Correct Factor.  
 2. If Peak Result complies with AV limit, AV Result is deemed to comply with AV limit.  
 3. Peak: Peak detector.  
 4. AVG:  $VBW=1/Ton$ , where: Ton is the transmitting duration.  
 5. For the transmitting duration, please refer to clause 7.1.  
 6. Filter losses were only considered in the spurious frequency bands and the authorized band was not corrected for High Pass Filter losses.  
 7. Proper operation of the transmitter prior to adding the filter to the measurement chain.  
 8. Since non-restricted band peak emissions are less than the average limit, they also comply with the -27dBm/MHz (68.2dBuV/m) limit.

### HARMONICS AND SPURIOUS EMISSIONS (MID CHANNEL, VERTICAL)

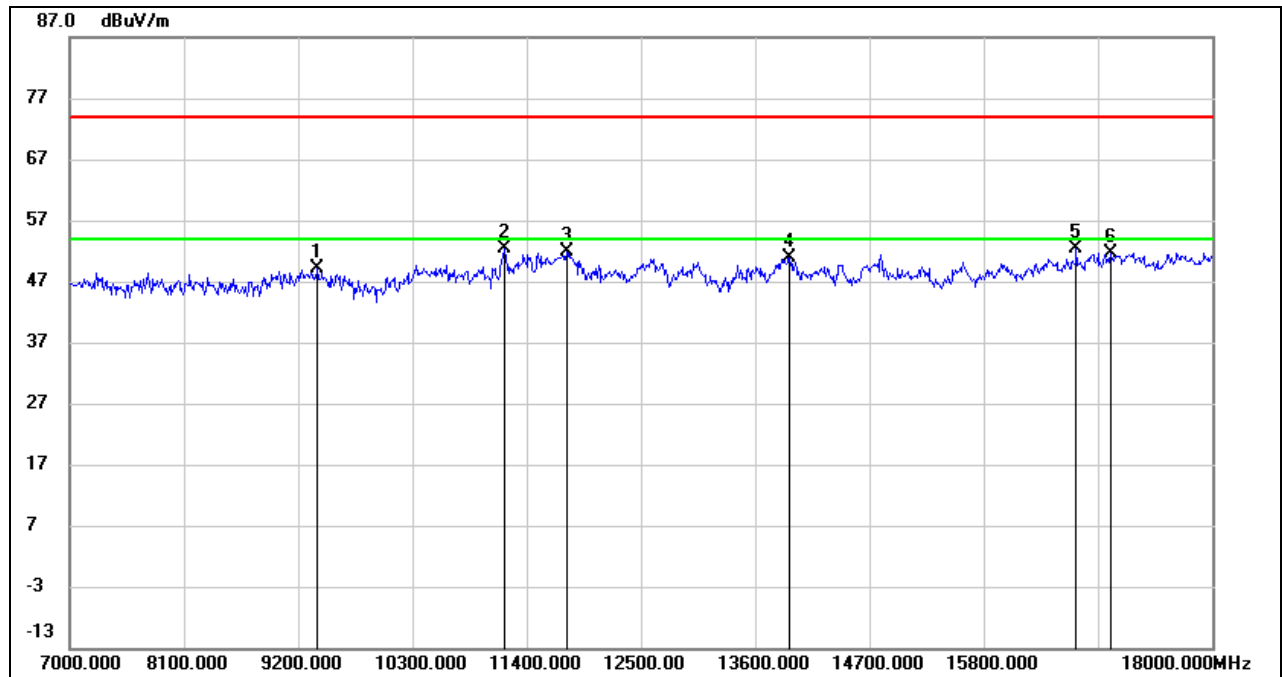

No.	Frequency (MHz)	Reading (dBuV)	Correct (dB/m)	Result (dBuV/m)	Limit (dBuV/m)	Margin (dB)	Remark
1	9387.000	37.81	11.38	49.19	74.00	-24.81	peak
2	11180.000	37.57	14.87	52.44	74.00	-21.56	peak
3	11785.000	35.29	16.63	51.92	74.00	-22.08	peak
4	13930.000	32.93	17.97	50.90	74.00	-23.10	peak
5	16691.000	31.50	20.88	52.38	74.00	-21.62	peak
6	17021.000	30.21	21.49	51.70	74.00	-22.30	peak

- Note: 1. Measurement = Reading Level + Correct Factor.  
 2. If Peak Result complies with AV limit, AV Result is deemed to comply with AV limit.  
 3. Peak: Peak detector.  
 4. AVG:  $VBW=1/Ton$ , where: Ton is the transmitting duration.  
 5. For the transmitting duration, please refer to clause 7.1.  
 6. Filter losses were only considered in the spurious frequency bands and the authorized band was not corrected for High Pass Filter losses.  
 7. Proper operation of the transmitter prior to adding the filter to the measurement chain.  
 8. Since non-restricted band peak emissions are less than the average limit, they also comply with the -27dBm/MHz (68.2dBuV/m) limit.

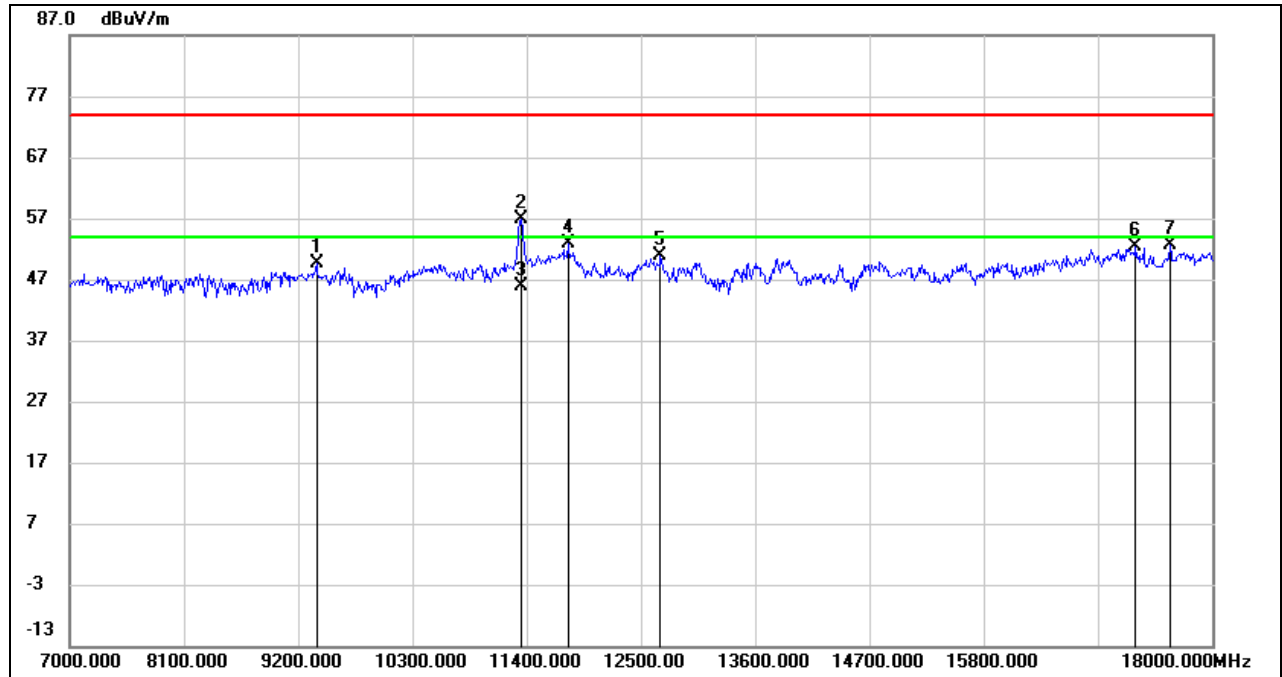
**HARMONICS AND SPURIOUS EMISSIONS (HIGH CHANNEL, HORIZONTAL)**

No.	Frequency (MHz)	Reading (dBuV)	Correct (dB/m)	Result (dBuV/m)	Limit (dBuV/m)	Margin (dB)	Remark
1	9376.000	38.21	11.34	49.55	74.00	-24.45	peak
2	11345.000	41.56	15.29	56.85	74.00	-17.15	peak
3	11345.000	30.47	15.29	45.76	54.00	-8.24	AVG
4	11796.000	36.14	16.69	52.83	74.00	-21.17	peak
5	12687.000	34.05	16.82	50.87	74.00	-23.13	peak
6	17263.000	29.99	22.28	52.27	74.00	-21.73	peak
7	17593.000	30.12	22.54	52.66	74.00	-21.34	peak

- Note: 1. Measurement = Reading Level + Correct Factor.  
 2. If Peak Result complies with AV limit, AV Result is deemed to comply with AV limit.  
 3. Peak: Peak detector.  
 4. AVG: VBW=1/Ton, where: Ton is the transmitting duration.  
 5. For the transmitting duration, please refer to clause 7.1.  
 6. Filter losses were only considered in the spurious frequency bands and the authorized band was not corrected for High Pass Filter losses.  
 7. Proper operation of the transmitter prior to adding the filter to the measurement chain.  
 8. Since non-restricted band peak emissions are less than the average limit, they also comply with the -27dBm/MHz (68.2dBuV/m) limit.



**HARMONICS AND SPURIOUS EMISSIONS (HIGH CHANNEL, VERTICAL)**

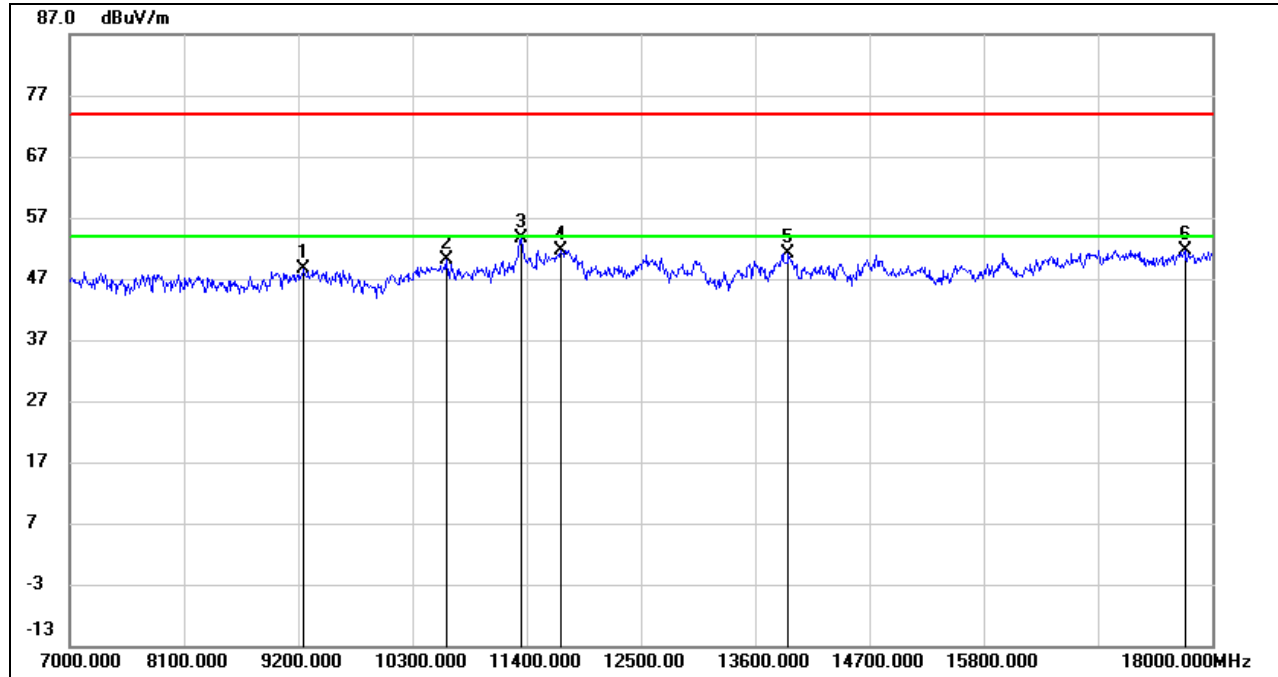

No.	Frequency (MHz)	Reading (dBuV)	Correct (dB/m)	Result (dBuV/m)	Limit (dBuV/m)	Margin (dB)	Remark
1	9255.000	37.85	10.80	48.65	74.00	-25.35	peak
2	10630.000	36.54	13.52	50.06	74.00	-23.94	peak
3	11345.000	38.23	15.29	53.52	74.00	-20.48	peak
4	11730.000	35.23	16.39	51.62	74.00	-22.38	peak
5	13919.000	33.11	17.97	51.08	74.00	-22.92	peak
6	17736.000	28.24	23.50	51.74	74.00	-22.26	peak

- Note:
1. Measurement = Reading Level + Correct Factor.
  2. If Peak Result complies with AV limit, AV Result is deemed to comply with AV limit.
  3. Peak: Peak detector.
  4. AVG:  $VBW=1/Ton$ , where: Ton is the transmitting duration.
  5. For the transmitting duration, please refer to clause 7.1.
  6. Filter losses were only considered in the spurious frequency bands and the authorized band was not corrected for High Pass Filter losses.
  7. Proper operation of the transmitter prior to adding the filter to the measurement chain.
  8. Since non-restricted band peak emissions are less than the average limit, they also comply with the -27dBm/MHz (68.2dBuV/m) limit.



**STRADDLE CHANNEL 142**

**HARMONICS AND SPURIOUS EMISSIONS (HORIZONTAL)**

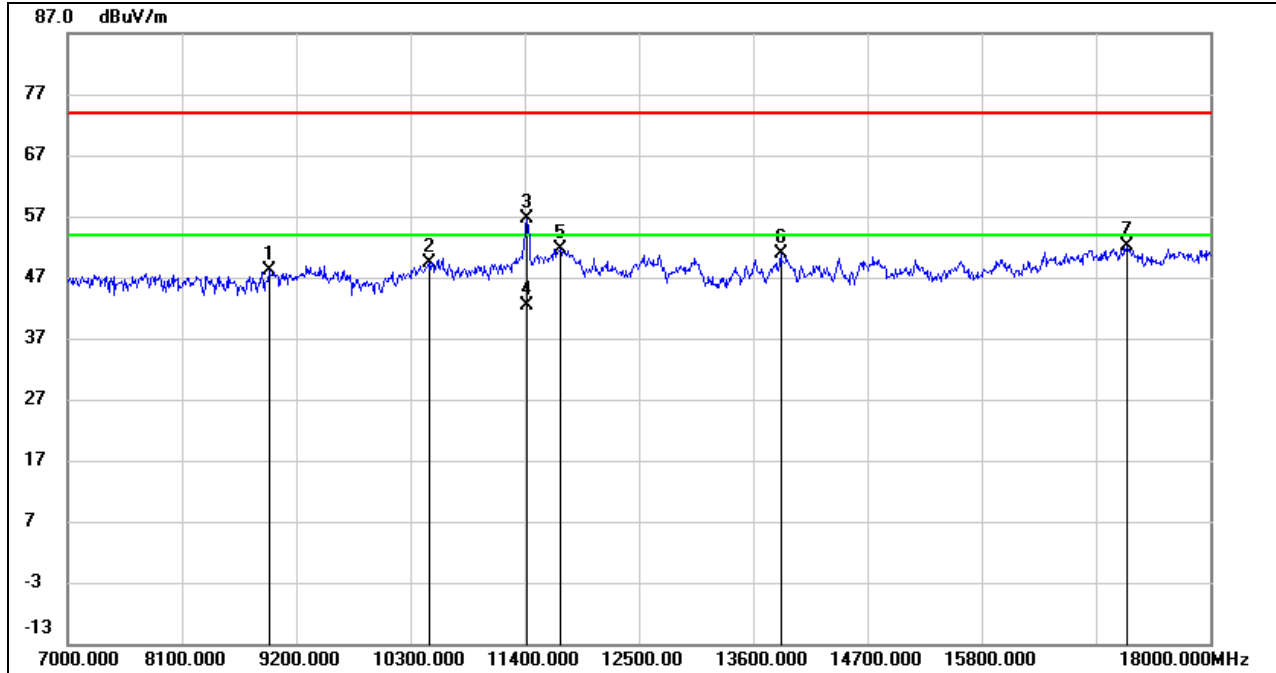

No.	Frequency (MHz)	Reading (dBuV)	Correct (dB/m)	Result (dBuV/m)	Limit (dBuV/m)	Margin (dB)	Remark
1	8936.000	36.92	11.10	48.02	74.00	-25.98	peak
2	10476.000	36.44	12.98	49.42	74.00	-24.58	peak
3	11422.000	41.11	15.47	56.58	74.00	-17.42	peak
4	11422.000	26.88	15.47	42.35	54.00	-11.65	AVG
5	11741.000	35.19	16.43	51.62	74.00	-22.38	peak
6	13864.000	32.85	18.03	50.88	74.00	-23.12	peak
7	17197.000	29.57	22.46	52.03	74.00	-21.97	peak

- Note: 1. Measurement = Reading Level + Correct Factor.  
 2. If Peak Result complies with AV limit, AV Result is deemed to comply with AV limit.  
 3. Peak: Peak detector.  
 4. AVG: VBW=1/Ton, where: Ton is the transmitting duration.  
 5. For the transmitting duration, please refer to clause 7.1.  
 6. Filter losses were only considered in the spurious frequency bands and the authorized band was not corrected for High Pass Filter losses.  
 7. Proper operation of the transmitter prior to adding the filter to the measurement chain.  
 8. Since non-restricted band peak emissions are less than the average limit, they also comply with the -27dBm/MHz (68.2dBuV/m) limit.

**HARMONICS AND SPURIOUS EMISSIONS (VERTICAL)**

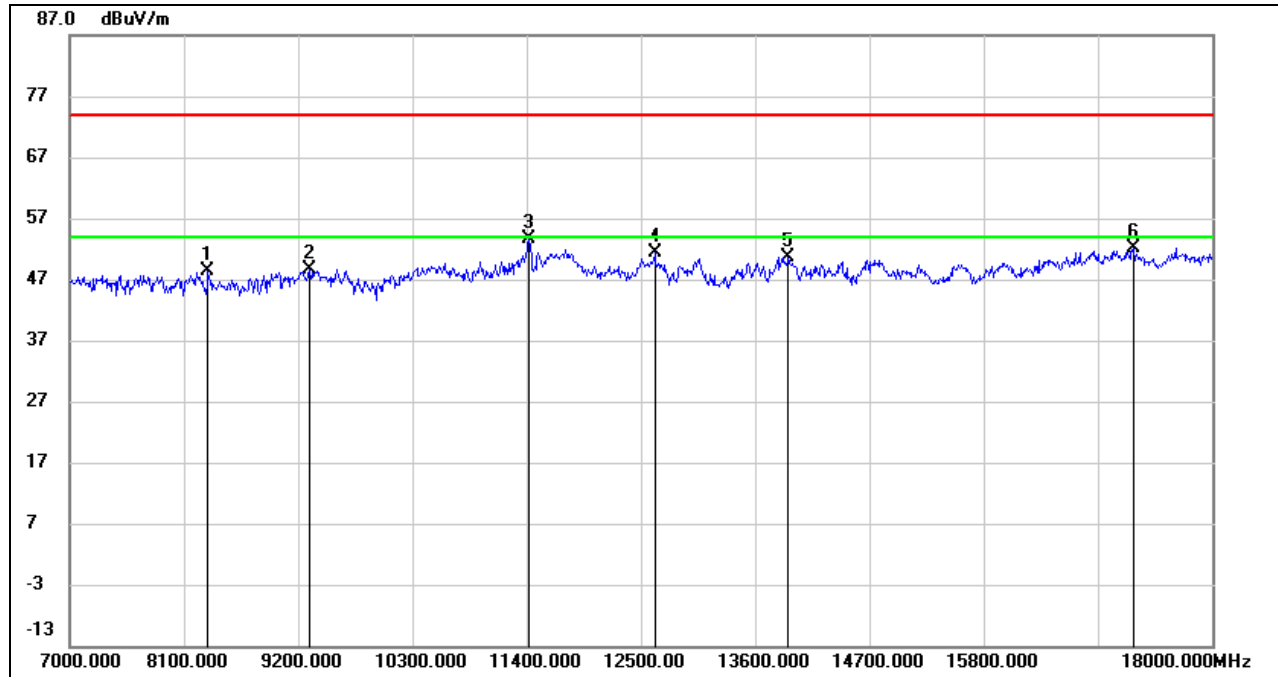

No.	Frequency (MHz)	Reading (dBuV)	Correct (dB/m)	Result (dBuV/m)	Limit (dBuV/m)	Margin (dB)	Remark
1	8331.000	38.24	10.05	48.29	74.00	-25.71	peak
2	9310.000	37.62	11.05	48.67	74.00	-25.33	peak
3	11422.000	38.18	15.47	53.65	74.00	-20.35	peak
4	12632.000	34.47	16.82	51.29	74.00	-22.71	peak
5	13919.000	32.66	17.97	50.63	74.00	-23.37	peak
6	17241.000	29.76	22.34	52.10	74.00	-21.90	peak

- Note:
1. Measurement = Reading Level + Correct Factor.
  2. If Peak Result complies with AV limit, AV Result is deemed to comply with AV limit.
  3. Peak: Peak detector.
  4. AVG:  $VBW=1/Ton$ , where: Ton is the transmitting duration.
  5. For the transmitting duration, please refer to clause 7.1.
  6. Filter losses were only considered in the spurious frequency bands and the authorized band was not corrected for High Pass Filter losses.
  7. Proper operation of the transmitter prior to adding the filter to the measurement chain.
  8. Since non-restricted band peak emissions are less than the average limit, they also comply with the -27dBm/MHz (68.2dBuV/m) limit.

**UNII-3 BAND**

**HARMONICS AND SPURIOUS EMISSIONS (LOW CHANNEL, HORIZONTAL)**

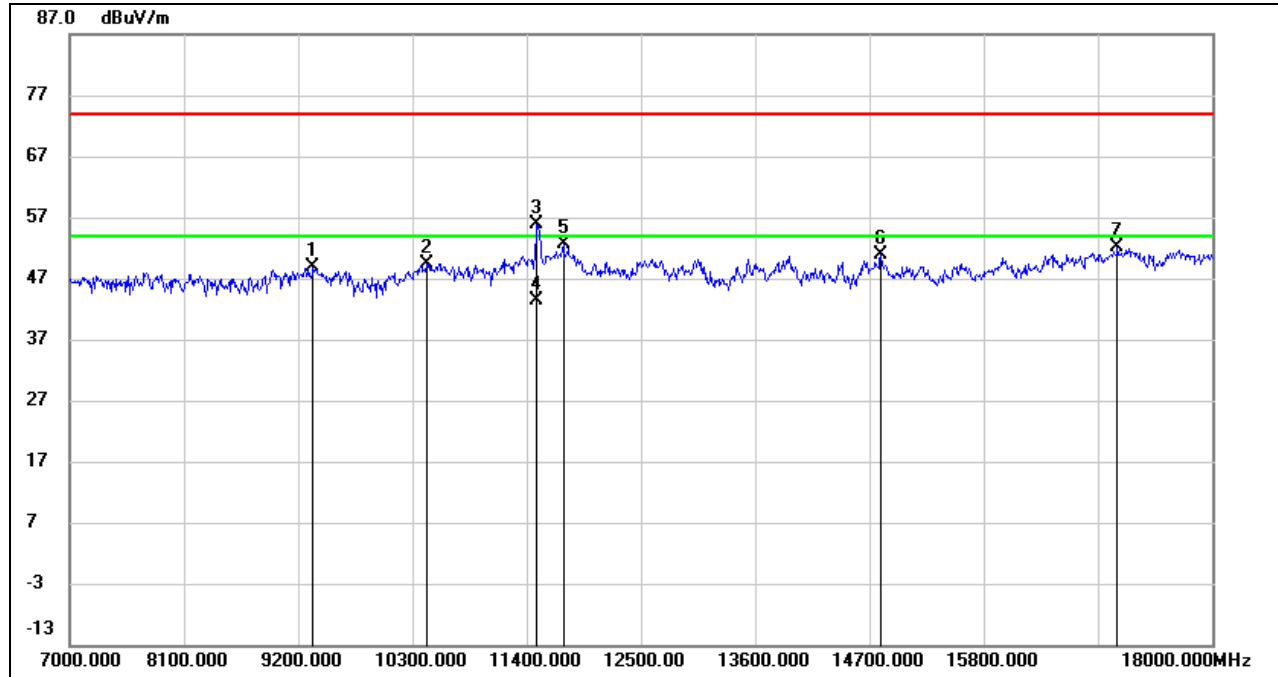

No.	Frequency (MHz)	Reading (dBuV)	Correct (dB/m)	Result (dBuV/m)	Limit (dBuV/m)	Margin (dB)	Remark
1	9343.000	37.67	11.19	48.86	74.00	-25.14	peak
2	10432.000	36.72	12.77	49.49	74.00	-24.51	peak
3	11499.000	40.28	15.60	55.88	74.00	-18.12	peak
4	11499.000	27.87	15.60	43.47	54.00	-10.53	AVG
5	11752.000	36.08	16.48	52.56	74.00	-21.44	peak
6	14810.000	32.95	17.82	50.77	74.00	-23.23	peak
7	17087.000	30.25	21.85	52.10	74.00	-21.90	peak

- Note:
1. Measurement = Reading Level + Correct Factor.
  2. If Peak Result complies with AV limit, AV Result is deemed to comply with AV limit.
  3. Peak: Peak detector.
  4. AVG:  $VBW=1/Ton$ , where: Ton is the transmitting duration.
  5. For the transmitting duration, please refer to clause 7.1.
  6. Filter losses were only considered in the spurious frequency bands and the authorized band was not corrected for High Pass Filter losses.
  7. Proper operation of the transmitter prior to adding the filter to the measurement chain.
  8. Since non-restricted band peak emissions are less than the average limit, they also comply with the -27dBm/MHz (68.2dBuV/m) limit.

### HARMONICS AND SPURIOUS EMISSIONS (LOW CHANNEL, VERTICAL)



No.	Frequency (MHz)	Reading (dBuV)	Correct (dB/m)	Result (dBuV/m)	Limit (dBuV/m)	Margin (dB)	Remark
1	9354.000	37.09	11.23	48.32	74.00	-25.68	peak
2	10608.000	36.66	13.47	50.13	74.00	-23.87	peak
3	11510.000	36.54	15.62	52.16	74.00	-21.84	peak
4	13919.000	32.73	17.97	50.70	74.00	-23.30	peak
5	15987.000	32.09	18.48	50.57	74.00	-23.43	peak
6	17219.000	30.11	22.41	52.52	74.00	-21.48	peak

- Note:
1. Measurement = Reading Level + Correct Factor.
  2. If Peak Result complies with AV limit, AV Result is deemed to comply with AV limit.
  3. Peak: Peak detector.
  4. AVG:  $VBW=1/Ton$ , where: Ton is the transmitting duration.
  5. For the transmitting duration, please refer to clause 7.1.
  6. Filter losses were only considered in the spurious frequency bands and the authorized band was not corrected for High Pass Filter losses.
  7. Proper operation of the transmitter prior to adding the filter to the measurement chain.
  8. Since non-restricted band peak emissions are less than the average limit, they also comply with the -27dBm/MHz (68.2dBuV/m) limit.

**HARMONICS AND SPURIOUS EMISSIONS (HIGH CHANNEL, HORIZONTAL)**

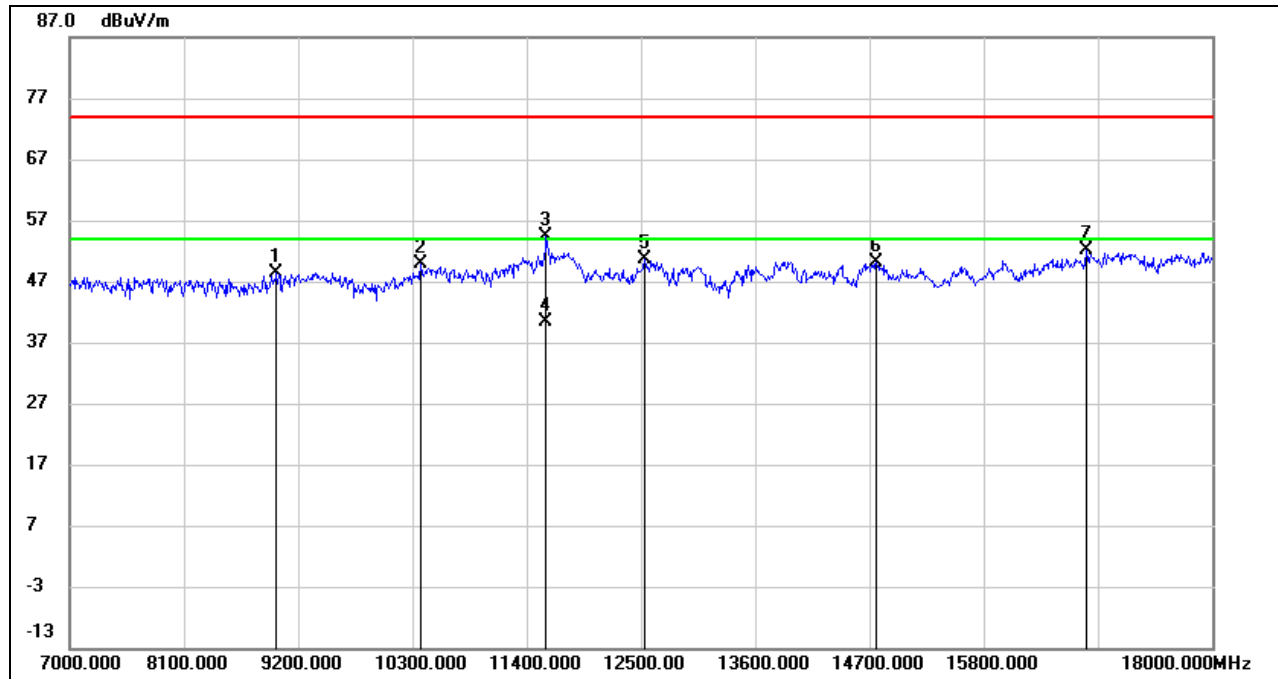

No.	Frequency (MHz)	Reading (dBuV)	Correct (dB/m)	Result (dBuV/m)	Limit (dBuV/m)	Margin (dB)	Remark
1	8991.000	36.84	11.63	48.47	74.00	-25.53	peak
2	10377.000	37.44	12.52	49.96	74.00	-24.04	peak
3	11587.000	38.54	15.78	54.32	74.00	-19.68	peak
4	11587.000	24.70	15.78	40.48	54.00	-13.52	AVG
5	12533.000	33.95	16.76	50.71	74.00	-23.29	peak
6	14766.000	32.44	17.78	50.22	74.00	-23.78	peak
7	16790.000	31.24	20.99	52.23	74.00	-21.77	peak

Note: 1. Measurement = Reading Level + Correct Factor.  
 2. If Peak Result complies with AV limit, AV Result is deemed to comply with AV limit.  
 3. Peak: Peak detector.  
 4. Filter losses were only considered in the spurious frequency bands and the authorized band was not corrected for High Pass Filter losses.  
 5. Proper operation of the transmitter prior to adding the filter to the measurement chain.  
 6. Since non-restricted band peak emissions are less than the average limit, they also comply with the -27dBm/MHz (68.2dBuV/m) limit.

### HARMONICS AND SPURIOUS EMISSIONS (HIGH CHANNEL, VERTICAL)

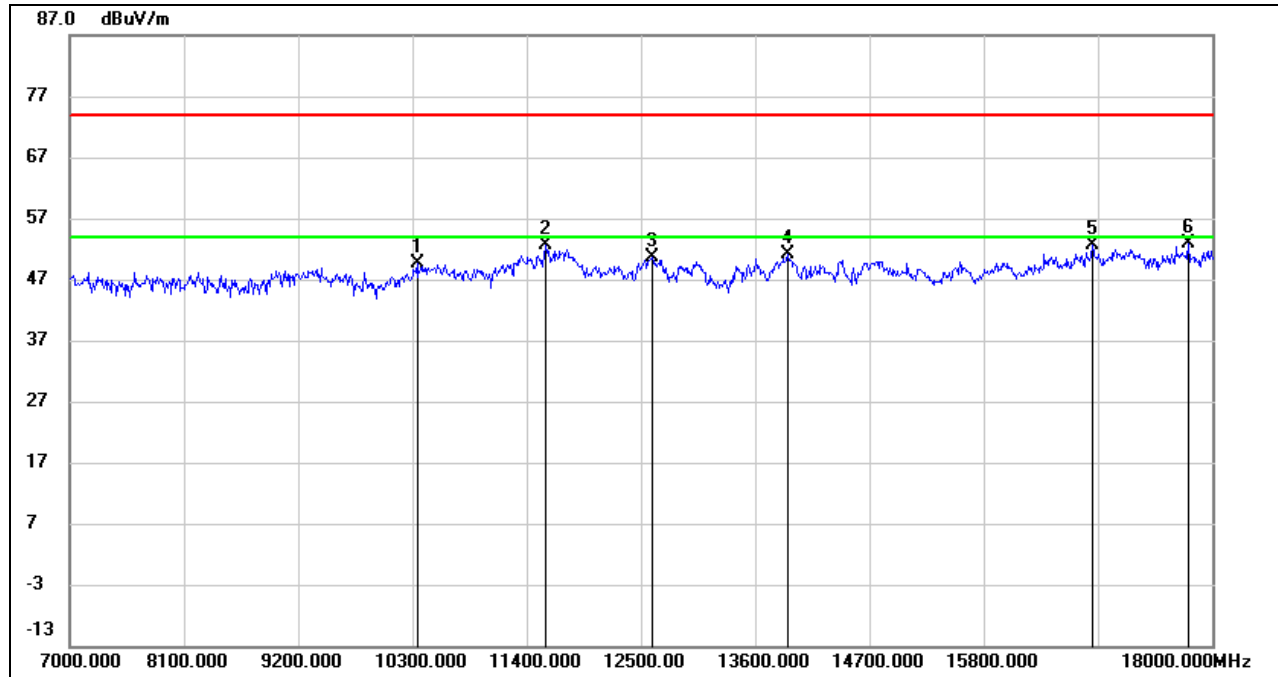

No.	Frequency (MHz)	Reading (dBuV)	Correct (dB/m)	Result (dBuV/m)	Limit (dBuV/m)	Margin (dB)	Remark
1	10344.000	37.19	12.38	49.57	74.00	-24.43	peak
2	11587.000	36.77	15.78	52.55	74.00	-21.45	peak
3	12610.000	33.81	16.82	50.63	74.00	-23.37	peak
4	13908.000	33.25	17.99	51.24	74.00	-22.76	peak
5	16845.000	31.47	21.09	52.56	74.00	-21.44	peak
6	17769.000	29.19	23.73	52.92	74.00	-21.08	peak

- Note: 1. Measurement = Reading Level + Correct Factor.  
 2. If Peak Result complies with AV limit, AV Result is deemed to comply with AV limit.  
 3. Peak: Peak detector.  
 4. AVG:  $VBW=1/Ton$ , where: Ton is the transmitting duration.  
 5. For the transmitting duration, please refer to clause 7.1.  
 6. Filter losses were only considered in the spurious frequency bands and the authorized band was not corrected for High Pass Filter losses.  
 7. Proper operation of the transmitter prior to adding the filter to the measurement chain.  
 8. Since non-restricted band peak emissions are less than the average limit, they also comply with the -27dBm/MHz (68.2dBuV/m) limit.

### 8.4. SPURIOUS EMISSIONS (18 GHz ~ 26 GHz)

#### 8.4.1. 802.11ax HE40 MODE

#### SPURIOUS EMISSIONS (UNII-2C BAND MID CHANNEL, HORIZONTAL, WORST-CASE CONFIGURATION)

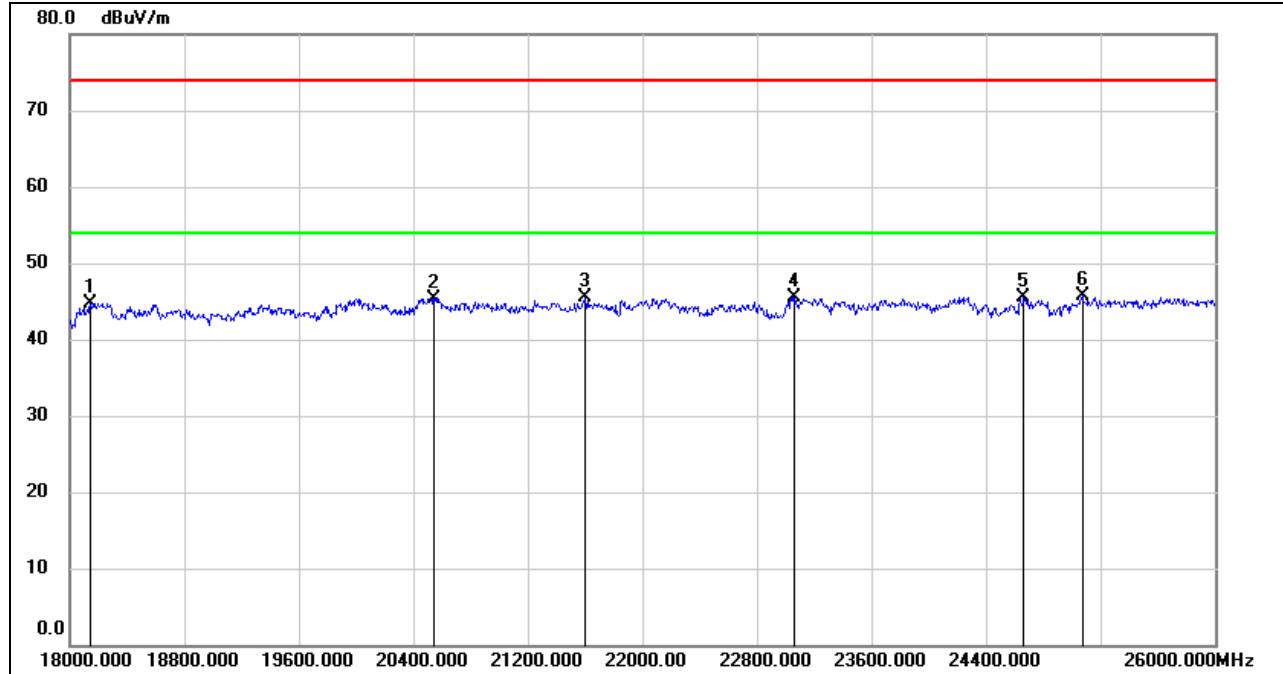

No.	Frequency (MHz)	Reading (dBuV)	Correct (dB/m)	Result (dBuV/m)	Limit (dBuV/m)	Margin (dB)	Remark
1	18144.000	50.27	-5.48	44.79	74.00	-29.21	peak
2	20544.000	50.70	-5.31	45.39	74.00	-28.61	peak
3	21600.000	50.02	-4.54	45.48	74.00	-28.52	peak
4	23064.000	48.99	-3.42	45.57	74.00	-28.43	peak
5	24664.000	47.90	-2.33	45.57	74.00	-28.43	peak
6	25072.000	47.67	-1.97	45.70	74.00	-28.30	peak

Note: 1. Measurement = Reading Level + Correct Factor.  
 2. If Peak Result complies with AV limit, AV Result is deemed to comply with AV limit.  
 3. Peak: Peak detector.  
 4. The preamplifier only effect to the above 18GHz signal and no filter added to the measurement chain.

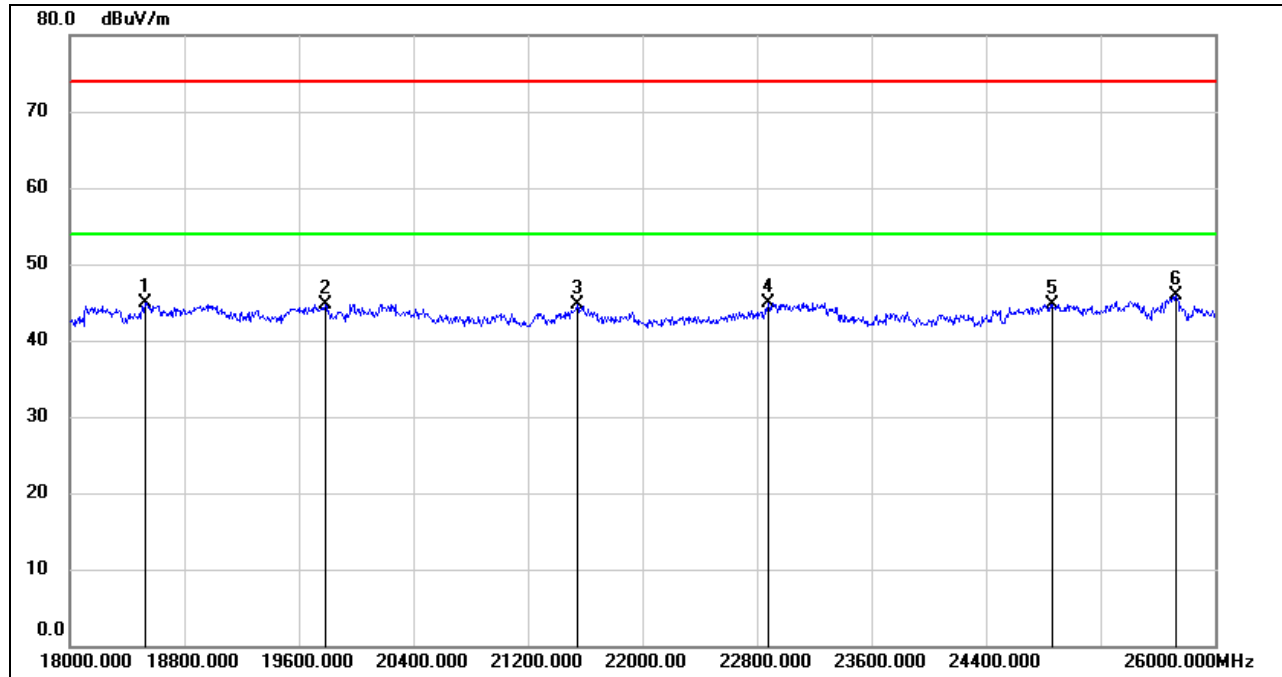

**SPURIOUS EMISSIONS (UNII-2C BAND MID CHANNEL, VERTICAL, WORST-CASE CONFIGURATION)**

No.	Frequency (MHz)	Reading (dBuV)	Correct (dB/m)	Result (dBuV/m)	Limit (dBuV/m)	Margin (dB)	Remark
1	18528.000	50.11	-5.26	44.85	74.00	-29.15	peak
2	19784.000	50.07	-5.28	44.79	74.00	-29.21	peak
3	21544.000	49.26	-4.63	44.63	74.00	-29.37	peak
4	22880.000	48.44	-3.56	44.88	74.00	-29.12	peak
5	24864.000	47.03	-2.23	44.80	74.00	-29.20	peak
6	25728.000	46.61	-0.72	45.89	74.00	-28.11	peak

- Note: 1. Measurement = Reading Level + Correct Factor.  
 2. If Peak Result complies with AV limit, AV Result is deemed to comply with AV limit.  
 3. Peak: Peak detector.

Note: All the modes, channels and antennas had been tested, but only the worst data was recorded in the report.



## 8.5. SPURIOUS EMISSIONS (26 GHz ~ 40 GHz)

### 8.5.1. 802.11ax HE40 MODE

#### SPURIOUS EMISSIONS (UNII-2C BAND MID CHANNEL, HORIZONTAL, WORST-CASE CONFIGURATION)

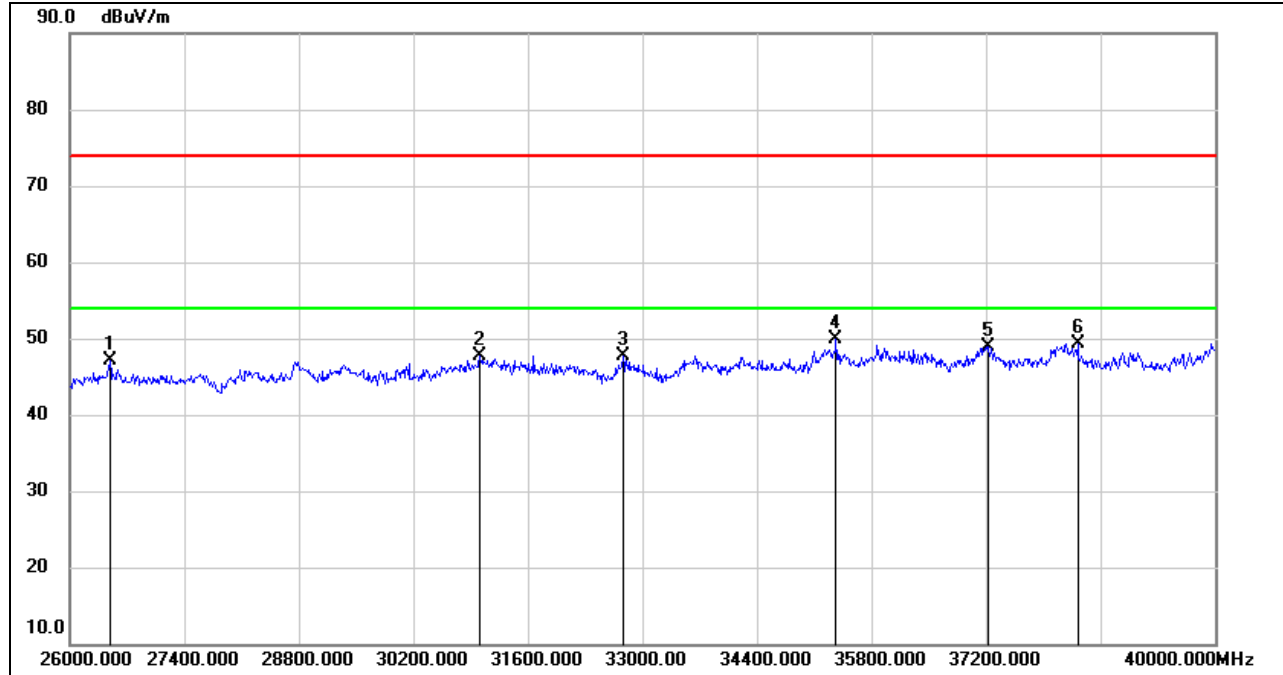

No.	Frequency (MHz)	Reading (dBuV)	Correct (dB/m)	Result (dBuV/m)	Limit (dBuV/m)	Margin (dB)	Remark
1	26490.000	51.79	-4.74	47.05	74.00	-26.95	peak
2	31012.000	48.33	-0.71	47.62	74.00	-26.38	peak
3	32762.000	48.95	-1.21	47.74	74.00	-26.26	peak
4	35366.000	47.40	2.59	49.99	74.00	-24.01	peak
5	37228.000	45.73	3.14	48.87	74.00	-25.13	peak
6	38320.000	45.56	3.77	49.33	74.00	-24.67	peak

Note: 1. Measurement = Reading Level + Correct Factor.  
 2. If Peak Result complies with AV limit, AV Result is deemed to comply with AV limit.  
 3. Peak: Peak detector.  
 4. The preamplifier only effect to the above 18GHz signal and no filter added to the measurement chain.



**SPURIOUS EMISSIONS (UNII-2C BAND MID CHANNEL, VERTICAL, WORST-CASE CONFIGURATION)**

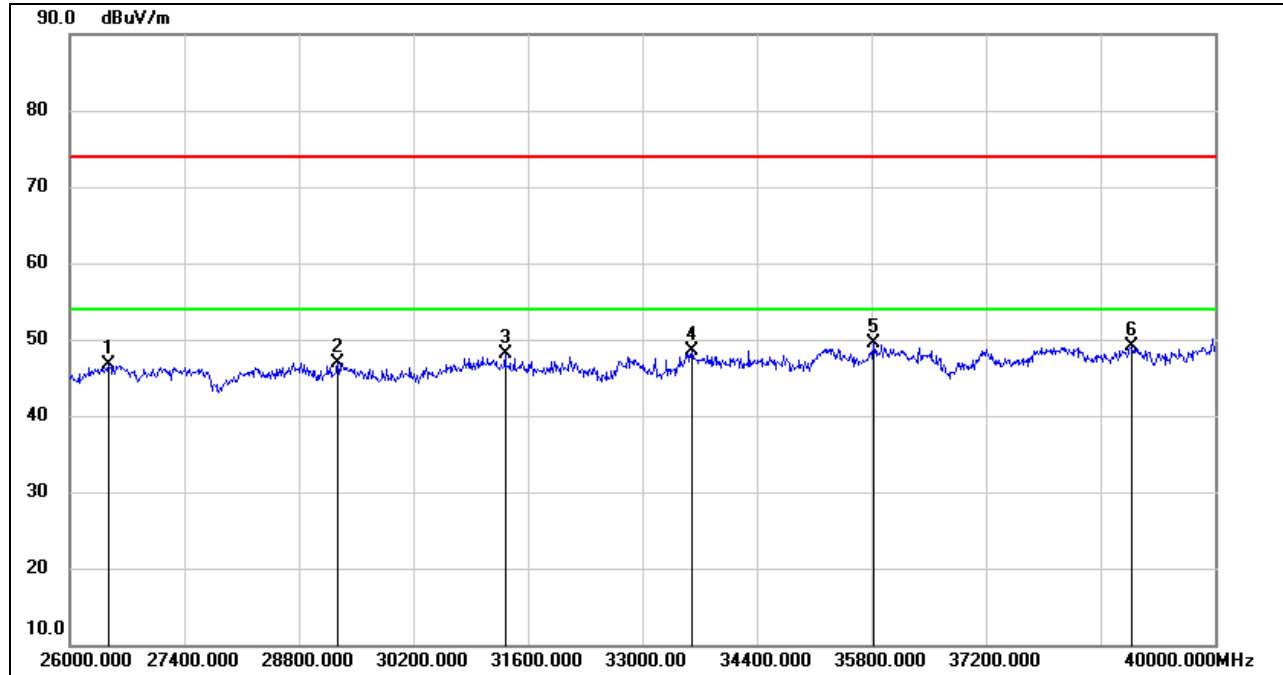

No.	Frequency (MHz)	Reading (dBuV)	Correct (dB/m)	Result (dBuV/m)	Limit (dBuV/m)	Margin (dB)	Remark
1	26476.000	51.53	-4.78	46.75	74.00	-27.25	peak
2	29276.000	48.01	-1.01	47.00	74.00	-27.00	peak
3	31320.000	49.11	-0.93	48.18	74.00	-25.82	peak
4	33602.000	48.01	0.46	48.47	74.00	-25.53	peak
5	35828.000	45.75	3.67	49.42	74.00	-24.58	peak
6	38978.000	44.66	4.35	49.01	74.00	-24.99	peak

- Note: 1. Measurement = Reading Level + Correct Factor.  
 2. If Peak Result complies with AV limit, AV Result is deemed to comply with AV limit.  
 3. Peak: Peak detector.

Note: All the modes, channels and antennas had been tested, but only the worst data was recorded in the report.

## 8.6. SPURIOUS EMISSIONS (30 MHz ~ 1 GHz)

### 8.6.1. 802.11ax HE40 MODE

#### SPURIOUS EMISSIONS (UNII-2C BAND MID CHANNEL, HORIZONTAL, WORST-CASE CONFIGURATION)

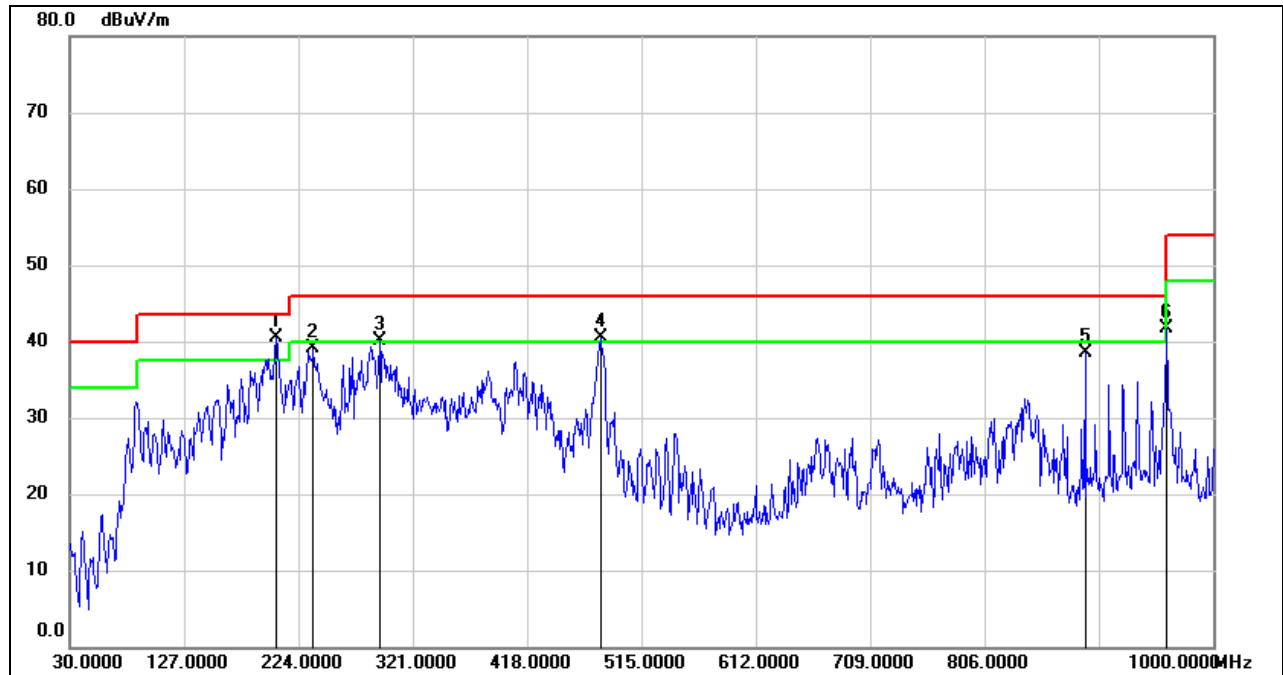

No.	Frequency (MHz)	Reading (dBuV)	Correct (dB/m)	Result (dBuV/m)	Limit (dBuV/m)	Margin (dB)	Remark
1	205.5700	57.33	-16.88	40.45	43.50	-3.05	QP
2	236.6100	58.03	-19.01	39.02	46.00	-6.98	QP
3	292.8700	55.86	-15.73	40.13	46.00	-5.87	QP
4	480.0800	52.20	-11.79	40.41	46.00	-5.59	QP
5	891.3600	43.76	-5.24	38.52	46.00	-7.48	QP
6	960.2300	46.20	-4.54	41.66	54.00	-12.34	QP

- Note: 1. Result Level = Read Level + Correct Factor.  
 2. If Peak Result complies with QP limit, QP Result is deemed to comply with QP limit.  
 3. Test setup: RBW: 120 kHz, VBW: 300 kHz, Sweep time: auto.

**SPURIOUS EMISSIONS (UNII-2C BAND MID CHANNEL, VERTICAL, WORST-CASE CONFIGURATION)**

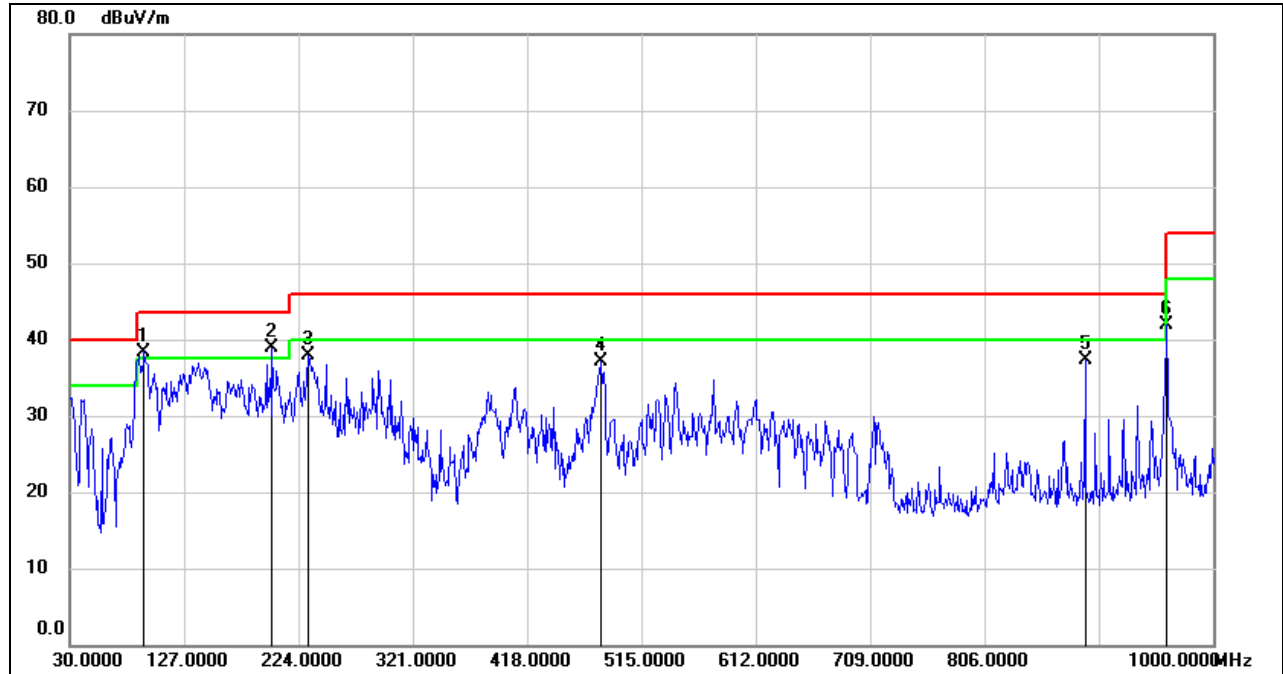

No.	Frequency (MHz)	Reading (dBuV)	Correct (dB/m)	Result (dBuV/m)	Limit (dBuV/m)	Margin (dB)	Remark
1	93.0500	60.09	-21.69	38.40	43.50	-5.10	peak
2	201.6900	55.42	-16.53	38.89	43.50	-4.61	peak
3	232.7300	56.62	-18.79	37.83	46.00	-8.17	peak
4	480.0800	48.95	-11.79	37.16	46.00	-8.84	peak
5	891.3600	42.51	-5.24	37.27	46.00	-8.73	peak
6	960.2300	46.53	-4.54	41.99	54.00	-12.01	peak

- Note: 1. Result Level = Read Level + Correct Factor.  
 2. If Peak Result complies with QP limit, QP Result is deemed to comply with QP limit.  
 3. Test setup: RBW: 120 kHz, VBW: 300 kHz, Sweep time: auto

Note: All the modes, channels and antennas had been tested, but only the worst data was recorded in the report.

## 8.7. SPURIOUS EMISSIONS BELOW 30 MHz

### 8.7.1. 802.11ax HE40 MODE

#### SPURIOUS EMISSIONS (UNII-2C BAND MID CHANNEL, LOOP ANTENNA FACE ON TO THE EUT, WORST-CASE CONFIGURATION)

9 kHz ~ 150 kHz

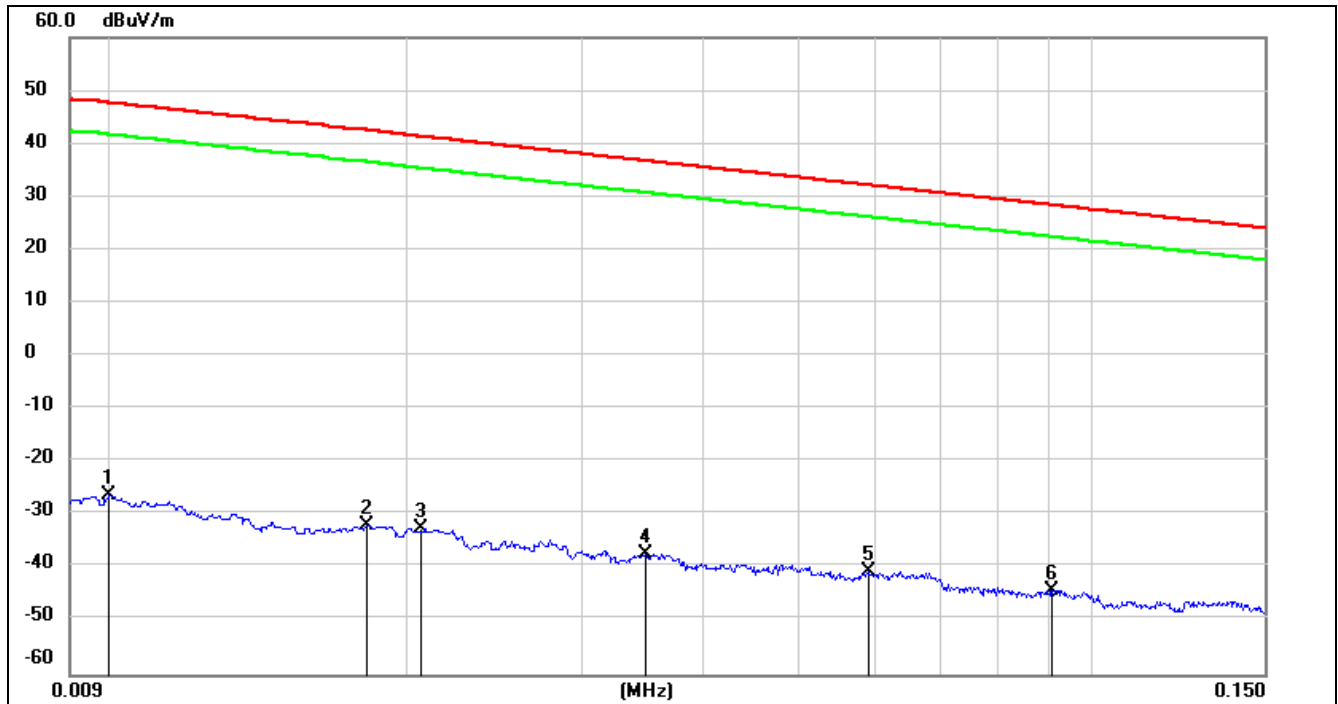

No.	Frequency (MHz)	Reading (dBuV)	Correct (dB/m)	FCC Result (dBuV/m)	FCC Limit (dBuV/m)	ISED Result (dBuA/m)	ISED Limit (dBuA/m)	Margin (dB)	Remark
1	0.0100	75.22	-101.40	-26.18	47.6	-77.68	-3.90	-73.78	peak
2	0.0181	69.35	-101.36	-32.01	42.45	-83.51	-9.05	-74.46	peak
3	0.0206	68.92	-101.35	-32.43	41.32	-83.93	-10.18	-73.75	peak
4	0.0349	64.03	-101.41	-37.38	36.75	-88.88	-14.75	-74.13	peak
5	0.0589	60.81	-101.52	-40.71	32.2	-92.21	-19.30	-72.91	peak
6	0.0911	57.61	-101.72	-44.11	28.41	-95.61	-23.09	-72.52	peak

Note: 1. Measurement = Reading Level + Correct Factor.

2. If Peak Result complies with AV and QP limit, AV and QP Result are deemed to comply with AV limit.

3. All 3 polarizations (Horizontal, Face-on and Face-off) of the loop antenna had been tested, but only the worst data recorded in the report.

4.  $\text{dBuA/m} = \text{dBuV/m} - 20\log_{10}(120\pi) = \text{dBuV/m} - 51.5$ .



**150 kHz ~ 490 kHz**

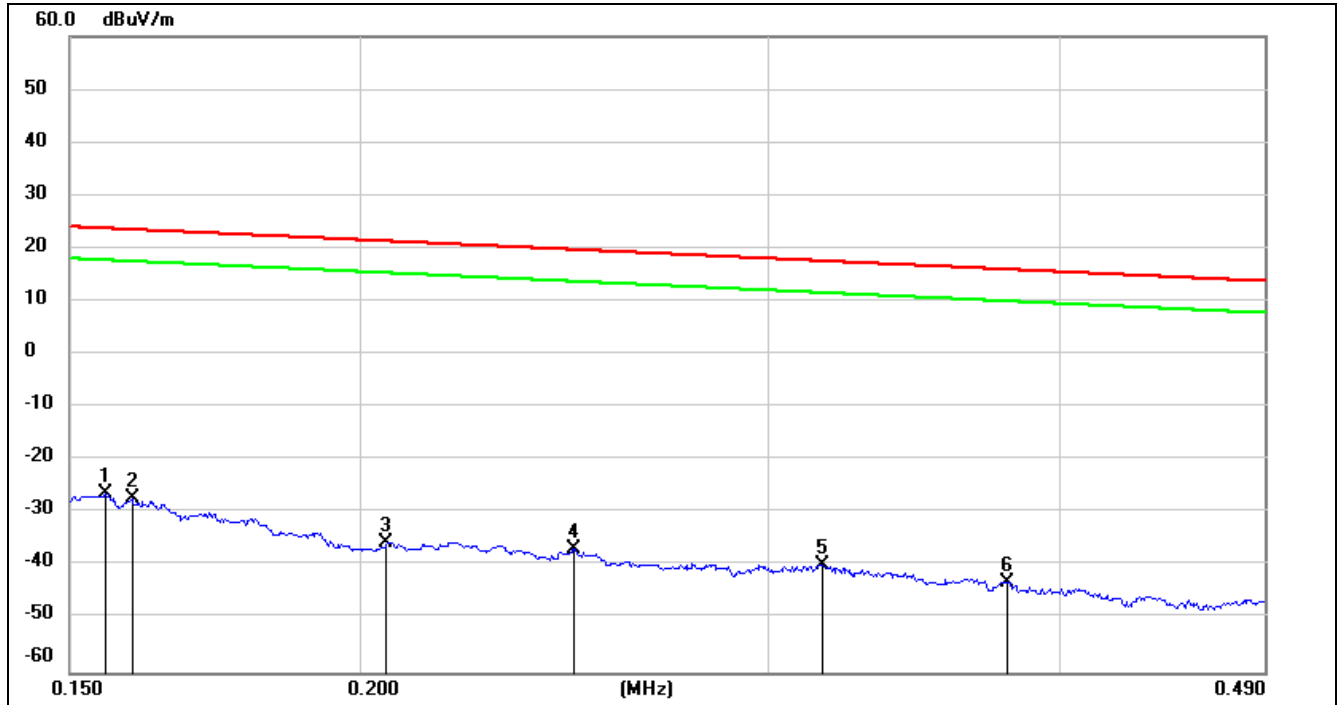

No.	Frequency (MHz)	Reading (dBuV)	Correct (dB/m)	FCC Result (dBuV/m)	FCC Limit (dBuV/m)	ISED Result (dBuA/m)	ISED Limit (dBuA/m)	Margin (dB)	Remark
1	0.1554	75.27	-101.65	-26.38	23.77	-77.88	-27.73	-50.15	peak
2	0.1595	74.36	-101.65	-27.29	23.55	-78.79	-27.95	-50.84	peak
3	0.2053	66.29	-101.73	-35.44	21.35	-86.94	-30.15	-56.79	peak
4	0.2472	64.95	-101.80	-36.85	19.74	-88.35	-31.76	-56.59	peak
5	0.3163	62.20	-101.87	-39.67	17.6	-91.17	-33.90	-57.27	peak
6	0.3800	59.02	-101.94	-42.92	16.01	-94.42	-35.49	-58.93	peak

- Note: 1. Measurement = Reading Level + Correct Factor.  
 2. If Peak Result complies with AV and QP limit, AV and QP Result are deemed to comply with AV limit.  
 3. All 3 polarizations (Horizontal, Face-on and Face-off) of the loop antenna had been tested, but only the worst data recorded in the report.  
 4.  $\text{dBuA/m} = \text{dBuV/m} - 20\log_{10}(120\pi) = \text{dBuV/m} - 51.5$ .

**490 kHz ~ 30 MHz**

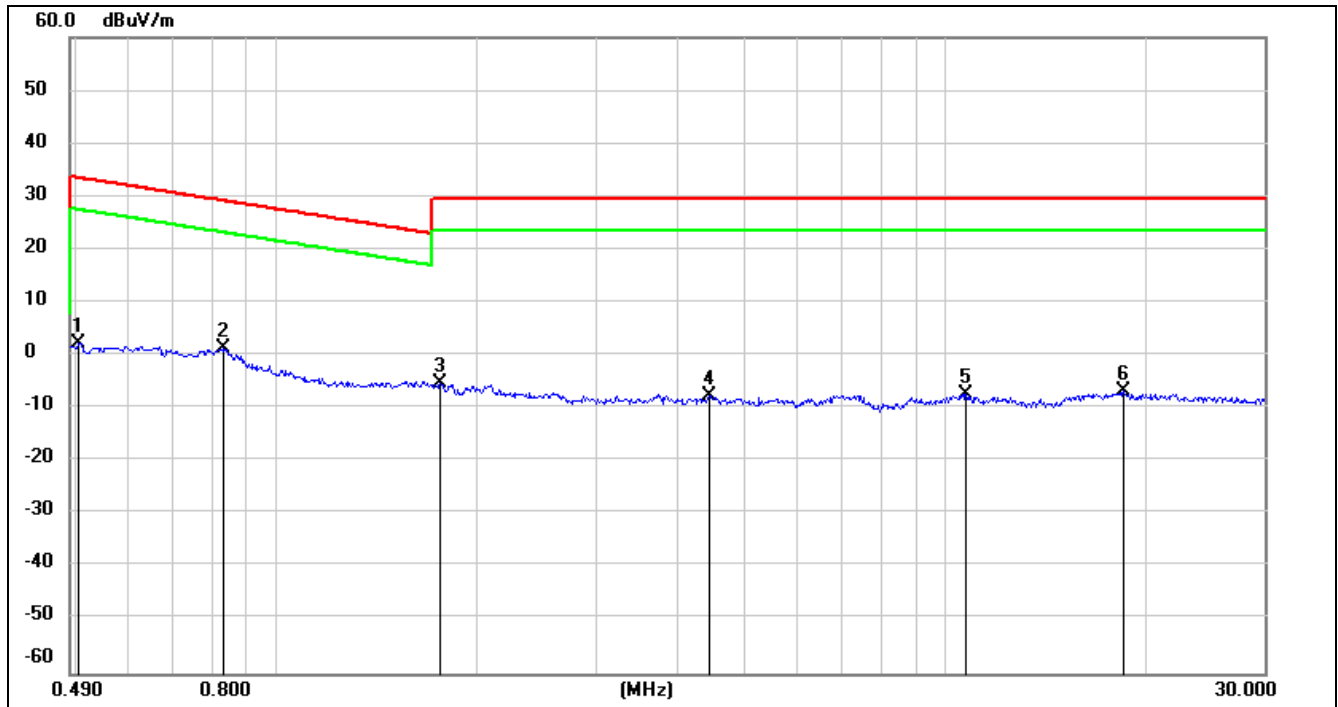

No.	Frequency (MHz)	Reading (dBuV)	Correct (dB/m)	FCC Result (dBuV/m)	FCC Limit (dBuV/m)	ISED Result (dBuA/m)	ISED Limit (dBuA/m)	Margin (dB)	Remark
1	0.5039	64.44	-62.07	2.37	33.56	-49.13	-17.94	-31.19	peak
2	0.8296	63.44	-62.17	1.27	29.23	-50.23	-22.27	-27.96	peak
3	1.7580	56.58	-61.93	-5.35	29.54	-56.85	-21.96	-34.89	peak
4	4.4443	53.79	-61.40	-7.61	29.54	-59.11	-21.96	-37.15	peak
5	10.7299	53.48	-60.83	-7.35	29.54	-58.85	-21.96	-36.89	peak
6	18.4908	54.06	-60.89	-6.83	29.54	-58.33	-21.96	-36.37	peak

- Note: 1. Measurement = Reading Level + Correct Factor.  
 2. If Peak Result complies with AV and QP limit, AV and QP Result are deemed to comply with AV limit.  
 3. All 3 polarizations (Horizontal, Face-on and Face-off) of the loop antenna had been tested, but only the worst data recorded in the report.  
 4.  $\text{dBuA/m} = \text{dBuV/m} - 20\log_{10}(120\pi) = \text{dBuV/m} - 51.5$ .

Note: All the modes, channels and antennas had been tested, but only the worst data was recorded in the report.



## 9. AC POWER LINE CONDUCTED EMISSIONS

### LIMITS

Please refer to CFR 47 FCC §15.207 (a).

FREQUENCY (MHz)	Quasi-peak	Average
0.15 -0.5	66 - 56 *	56 - 46 *
0.50 -5.0	56.00	46.00
5.0 -30.0	60.00	50.00

### TEST SETUP AND PROCEDURE

Refer to ANSI C63.10-2013 clause 6.2.

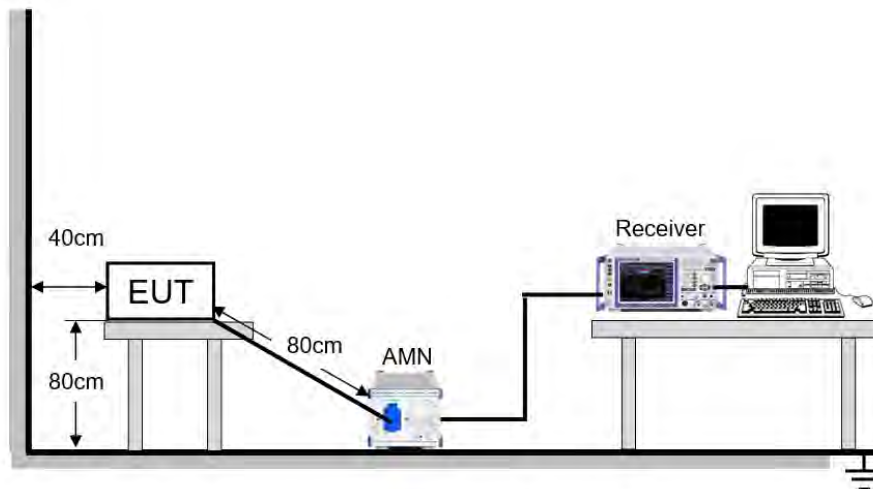

The EUT is put on a table of non-conducting material that is 80 cm high. The vertical conducting wall of shielding is located 40 cm to the rear of the EUT. The power line of the EUT is connected to the AC mains through a Artificial Mains Network (A.M.N.). A EMI Measurement Receiver (R&S Test Receiver ESR3) is used to test the emissions from both sides of AC line. According to the requirements in Section 6.2 of ANSI C63.10-2013. Conducted emissions from the EUT measured in the frequency range between 0.15 MHz and 30 MHz using CISPR Quasi-Peak and average detector mode. The bandwidth of EMI test receiver is set at 9 kHz.

The arrangement of the equipment is installed to meet the standards and operating in a manner, which tends to maximize its emission characteristics in a normal application.

### TEST ENVIRONMENT

Temperature	25.2 °C	Relative Humidity	67.2 %
Atmosphere Pressure	101 kPa	Test Voltage	DC 5 V

**RESULTS**

**9.1.1. 802.11ax HE40 MODE**

**LINE L RESULTS (UNII-2C BAND MID CHANNEL, WORST-CASE CONFIGURATION)**

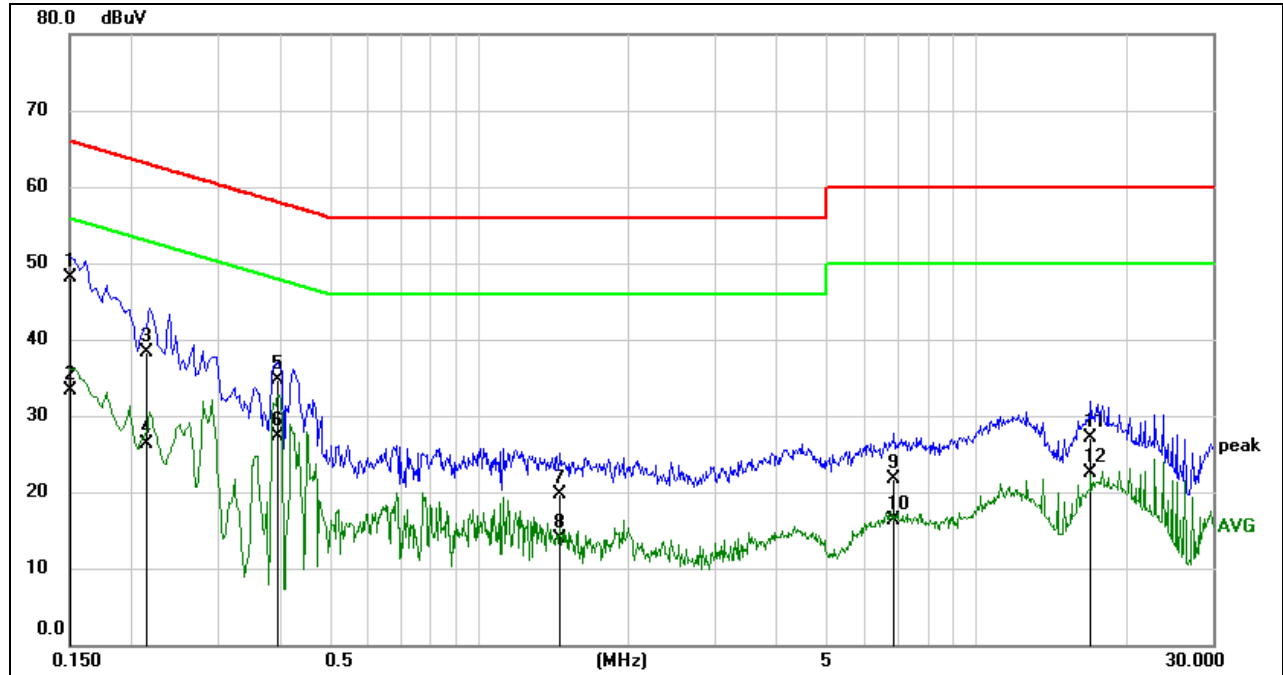

No.	Frequency (MHz)	Reading (dBuV)	Correct (dB)	Result (dBuV)	Limit (dBuV)	Margin (dB)	Remark
1	0.1512	38.44	9.59	48.03	65.93	-17.90	QP
2	0.1512	23.72	9.59	33.31	55.93	-22.62	AVG
3	0.2135	28.72	9.59	38.31	63.07	-24.76	QP
4	0.2135	16.65	9.59	26.24	53.07	-26.83	AVG
5	0.3946	25.09	9.59	34.68	57.97	-23.29	QP
6	0.3946	17.78	9.59	27.37	47.97	-20.60	AVG
7	1.4624	10.09	9.62	19.71	56.00	-36.29	QP
8	1.4624	4.33	9.62	13.95	46.00	-32.05	AVG
9	6.8243	12.17	9.63	21.80	60.00	-38.20	QP
10	6.8243	6.73	9.63	16.36	50.00	-33.64	AVG
11	17.0590	17.29	9.72	27.01	60.00	-32.99	QP
12	17.0590	12.76	9.72	22.48	50.00	-27.52	AVG

Note: 1. Result = Reading + Correct Factor.  
 2. If QP Result complies with AV limit, AV Result is deemed to comply with AV limit.  
 3. Test setup: RBW: 200 Hz (9 kHz ~ 150 kHz), 9 kHz (150 kHz ~ 30 MHz).  
 4. Step size: 80 Hz (0.009 MHz ~ 0.15 MHz), 4 kHz (0.15 MHz ~ 30 MHz), Scan time: auto.

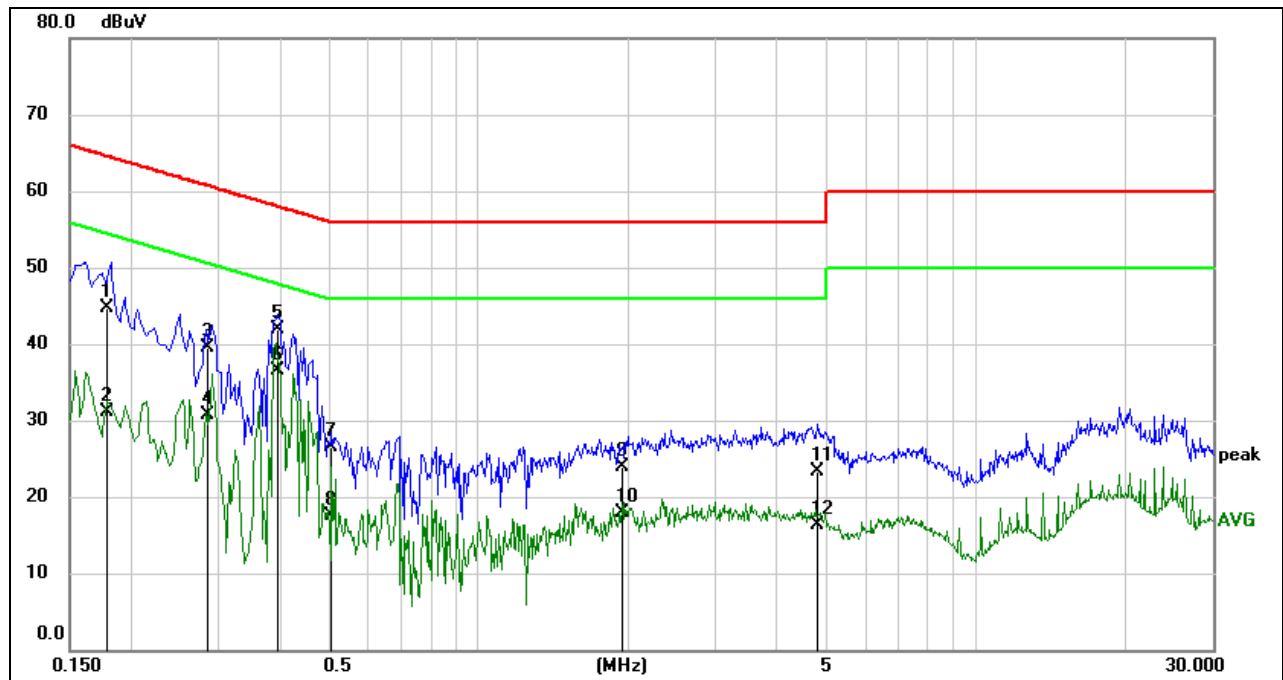
**LINE N RESULTS (UNII-2C BAND MID CHANNEL, WORST-CASE CONFIGURATION)**

No.	Frequency (MHz)	Reading (dBuV)	Correct (dB)	Result (dBuV)	Limit (dBuV)	Margin (dB)	Remark
1	0.1785	35.05	9.59	44.64	64.56	-19.92	QP
2	0.1785	21.45	9.59	31.04	54.56	-23.52	AVG
3	0.2855	29.85	9.59	39.44	60.65	-21.21	QP
4	0.2855	21.09	9.59	30.68	50.65	-19.97	AVG
5	0.3944	32.34	9.59	41.93	57.97	-16.04	QP
6	0.3944	26.87	9.59	36.46	47.97	-11.51	AVG
7	0.5096	16.91	9.60	26.51	56.00	-29.49	QP
8	0.5096	7.90	9.60	17.50	46.00	-28.50	AVG
9	1.9494	14.29	9.63	23.92	56.00	-32.08	QP
10	1.9494	8.33	9.63	17.96	46.00	-28.04	AVG
11	4.8047	13.70	9.61	23.31	56.00	-32.69	QP
12	4.8047	6.65	9.61	16.26	46.00	-29.74	AVG

Note: 1. Result = Reading + Correct Factor.

2. If QP Result complies with AV limit, AV Result is deemed to comply with AV limit.

3. Test setup: RBW: 200 Hz (9 kHz ~ 150 kHz), 9 kHz (150 kHz ~ 30 MHz).

4. Step size: 80 Hz (0.009 MHz ~ 0.15 MHz), 4 kHz (0.15 MHz ~ 30 MHz), Scan time: auto.

Note: All the modes, channels and antennas had been tested, but only the worst data was recorded in the report.

## 10. FREQUENCY STABILITY

### LIMITS

The frequency of the carrier signal shall be maintained within band of operation.

### TEST PROCEDURE

1. The EUT was placed inside an environmental chamber as the temperature in the chamber was varied between 0 °C ~ 70 °C (declared by customer).
2. The temperature was incremented by 10 °C intervals and the unit allowed to stabilize at each temperature before each measurement. The center frequency of the transmitting channel was evaluated at each temperature and the frequency deviation from the channel's center frequency was recorded.
3. The primary supply voltage is varied from 85 % to 115 % of the nominal value for non hand-carried battery and AC powered equipment. For hand-carried, battery-powered equipment, primary supply voltage is reduced to the battery operating end point which shall be specified by the manufacturer.

Connect the EUT to the spectrum analyser and use the following settings:

Center Frequency	The center frequency of the channel under test
Detector	Peak
RBW	10 kHz
VBW	$\geq 3 \times \text{RBW}$
Span	Encompass the entire emissions bandwidth (EBW) of the signal
Trace	Max hold
Sweep time	Auto

4. While maintaining a constant temperature inside the environmental chamber, turn the EUT on and record the operating frequency at startup, and at 2 minutes, 5minutes, and 10 minutes after the EUT is energized.
5. Allow the trace to stabilize, find the peak value of the power envelope and record the frequency, then calculated the frequency drift.

### TEST SETUP

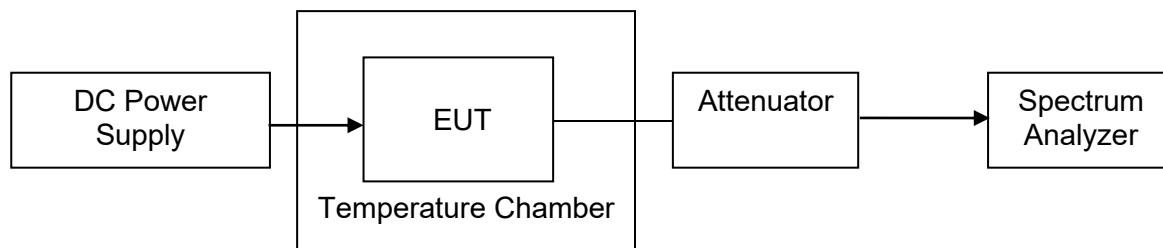



**TEST ENVIRONMENT**

	Normal Test Conditions	Extreme Test Conditions
Relative Humidity	20 % - 75 %	/
Atmospheric Pressure	100 kPa ~102 kPa	/
Temperature	T <sub>N</sub> (Normal Temperature): 23.5 °C	T <sub>L</sub> (Low Temperature): 0 °C
		T <sub>H</sub> (High Temperature): 70 °C
Supply Voltage	V <sub>N</sub> (Normal Voltage): DC 5 V	V <sub>L</sub> (Low Voltage): DC 4.25 V
		V <sub>H</sub> (High Voltage): DC 5.75 V

Note: A test jig has been used to apply voltage variation to device while maintaining functionalities of the device based on C63.10 Clause 5.13 d.

**RESULTS**

Please refer to Appendix E.

## 11. DYNAMIC FREQUENCY SELECTION

### APPLICABILITY OF DFS REQUIREMENTS

A U-NII network will employ a DFS function to detect signals from radar systems and to avoid co-channel operation with these systems. This applies to the 5250-5350 MHz and/or 5470-5725 MHz bands.

Within the context of the operation of the DFS function, a U-NII device will operate in either Master Mode or Client Mode. U-NII devices operating in Client Mode can only operate in a network controlled by a U-NII device operating in Master Mode.

Table 1: Applicability of DFS Requirements Prior to Use of a Channel

Requirement	Operational Mode		
	<input type="checkbox"/> Master	<input checked="" type="checkbox"/> Client Without Radar Detection	<input type="checkbox"/> Client With Radar Detection
Non-Occupancy Period	Yes	Not required	Yes
DFS Detection Threshold	Yes	Not required	Yes
Channel Availability Check Time	Yes	Not required	Not required
U-NII Detection Bandwidth	Yes	Not required	Yes

Table 2: Applicability of DFS requirements during normal operation

Requirement	Operational Mode	
	<input type="checkbox"/> Master Device or Client with Radar Detection	<input checked="" type="checkbox"/> Client Without Radar Detection
DFS Detection Threshold	Yes	Not required
Channel Closing Transmission Time	Yes	Yes
Channel Move Time	Yes	Yes
U-NII Detection Bandwidth	Yes	Not required

Additional requirements for devices with multiple bandwidth modes	<input type="checkbox"/> Master Device or Client with Radar Detection	<input checked="" type="checkbox"/> Client Without Radar Detection
U-NII Detection Bandwidth and Statistical Performance Check	All BW modes must be tested	Not required
Channel Move Time and Channel Closing Transmission Time	Test using widest BW mode available	Test using the widest BW mode available for the link
All other tests	Any single BW mode	Not required

Note: Frequencies selected for statistical performance check should include several frequencies within the radar detection bandwidth and frequencies near the edge of the radar detection bandwidth. For 802.11 devices it is suggested to select frequencies in each of the bonded 20 MHz channels and the channel center frequency.

**LIMITS**

(1) DFS Detection Thresholds

Table 3: DFS Detection Thresholds for Master Devices and Client Devices With Radar Detection

Maximum Transmit Power	Value (See Notes 1, 2, and 3)
EIRP $\geq$ 200 milliwatt	-64 dBm
EIRP < 200 milliwatt and power spectral density < 10 dBm/MHz	-62 dBm
EIRP < 200 milliwatt that do not meet the power spectral density requirement	-64 dBm

Note 1: This is the level at the input of the receiver assuming a 0 dBi receive antenna.  
 Note 2: Throughout these test procedures an additional 1 dB has been added to the amplitude of the test transmission waveforms to account for variations in measurement equipment. This will ensure that the test signal is at or above the detection threshold level to trigger a DFS response.  
 Note3: EIRP is based on the highest antenna gain. For MIMO devices refer to KDB Publication 662911 D01.

(2) DFS Response Requirements

Table 4: DFS Response Requirement Values

Parameter	Value
Non-occupancy period	Minimum 30 minutes
Channel Availability Check Time	60 seconds
Channel Move Time	10 seconds See Note 1.
Channel Closing Transmission Time	200 milliseconds + an aggregate of 60 milliseconds over remaining 10 second period. See Notes 1 and 2.
U-NII Detection Bandwidth	Minimum 100% of the U-NII 99% transmission power bandwidth. See Note 3.

Note 1: Channel Move Time and the Channel Closing Transmission Time should be performed with Radar Type 0. The measurement timing begins at the end of the Radar Type 0 burst.  
 Note 2: The Channel Closing Transmission Time is comprised of 200 milliseconds starting at the beginning of the Channel Move Time plus any additional intermittent control signals required facilitating a Channel move (an aggregate of 60 milliseconds) during the remainder of the 10 second period. The aggregate duration of control signals will not count quiet periods in between transmissions.  
 Note 3: During the U-NII Detection Bandwidth detection test, radar type 0 should be used. For each frequency step the minimum percentage of detection is 90 percent. Measurements are performed with no data traffic.

**PARAMETERS OF RADAR TEST WAVEFORMS**

This section provides the parameters for required test waveforms, minimum percentage of successful detections, and the minimum number of trials that must be used for determining DFS conformance. Step intervals of 0.1 microsecond for Pulse Width, 1 microsecond for PRI, 1 MHz for chirp width and 1 for the number of pulses will be utilized for the random determination of specific test waveforms.

Table 5 Short Pulse Radar Test Waveforms

Radar Type	Pulse Width (µsec)	PRI (µsec)	Number of Pulses	Minimum Percentage of Successful Detection	Minimum Number of Trials
0	1	1428	18	See Note 1	See Note 1
1	1	Test A	Roundup $\left\{ \begin{matrix} \frac{1}{360} \\ \frac{19 \cdot 10^9}{PRI_{\mu sec}} \end{matrix} \right\}$	60%	30
		Test B			
2	1-5	150-230	23-29	60%	30
3	6-10	200-500	16-18	60%	30
4	11-20	200-500	12-16	60%	30
Aggregate (Radar Types 1-4)				80%	120
<p>Note 1: Short Pulse Radar Type 0 should be used for the detection bandwidth test, channel move time, and channel closing time tests.</p> <p>Test A: 15 unique PRI values randomly selected from the list of 23 PRI values in Table 5a.</p> <p>Test B: 15 unique PRI values randomly selected within the range of 518-3066 µsec, with a minimum increment of 1 µsec, excluding PRI values selected in Test A.</p>					

A minimum of 30 unique waveforms are required for each of the Short Pulse Radar Types 2 through 4. If more than 30 waveforms are used for Short Pulse Radar Types 2 through 4, then each additional waveform must also be unique and not repeated from the previous waveforms. If more than 30 waveforms are used for Short Pulse Radar Type 1, then each additional waveform is generated with Test B and must also be unique and not repeated from the previous waveforms in Tests A or B. Test aggregate is average of the percentage of successful detections of short pulse radar types 1-4.



**TEST SETUP**

Setup for Client with injection at the Master

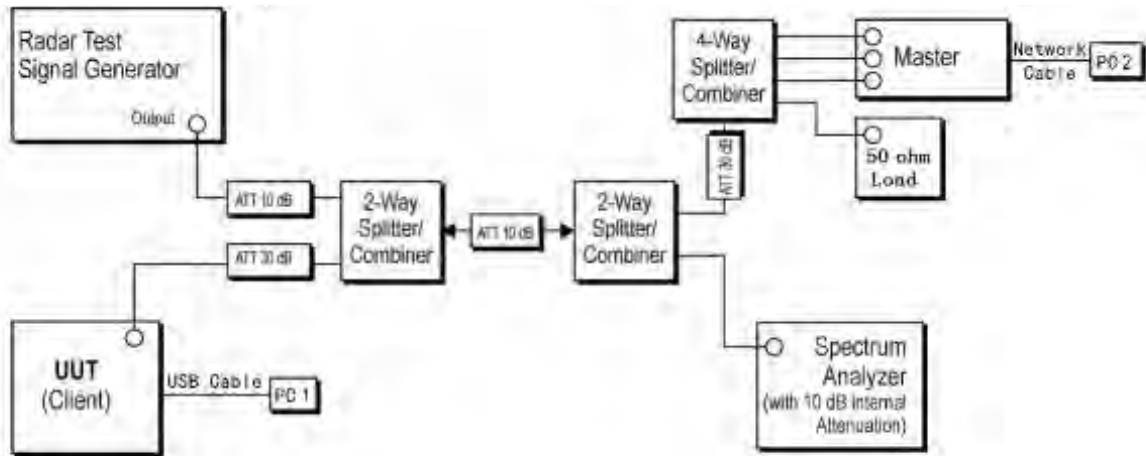

**TEST ENVIRONMENT**

Temperature	26.6 °C	Relative Humidity	62.6 %
Atmosphere Pressure	101 kPa	Test Voltage	DC 5 V

**RESULTS**

Please refer to Appendix F.



## 12. ANTENNA REQUIREMENTS

### APPLICABLE REQUIREMENTS

Please refer to FCC §15.203

An intentional radiator shall be designed to ensure that no antenna other than that furnished by the responsible party shall be used with the device. The use of a permanently attached antenna or of an antenna that uses a unique coupling to the intentional radiator shall be considered sufficient to comply with the provisions of this section. The manufacturer may design the unit so that a broken antenna can be replaced by the user, but the use of a standard antenna jack or electrical connector is prohibited.

Please refer to FCC §15.247(b)(4)

The conducted output power limit specified in paragraph (b) of this section is based on the use of antennas with directional gains that do not exceed 6 dBi. Except as shown in paragraph (c) of this section, if transmitting antennas of directional gain greater than 6 dBi are used, the conducted output power from the intentional radiator shall be reduced below the stated values in paragraphs (b)(1), (b)(2), and (b)(3) of this section, as appropriate, by the amount in dB that the directional gain of the antenna exceeds 6 dBi.

### RESULTS

Complies



### 13. Appendix

#### 13.1. Appendix A1: Emission Bandwidth

##### 13.1.1. Test Result

Test Mode	Antenna	Channel	26db EBW [MHz]	FL[MHz]	FH[MHz]	Verdict		
11A	Ant1	5180	23.920	5167.880	5191.800	PASS		
		5200	24.520	5187.760	5212.280	PASS		
		5240	23.760	5227.960	5251.720	PASS		
		5260	24.400	5248.000	5272.400	PASS		
		5280	23.600	5268.040	5291.640	PASS		
		5320	23.760	5308.440	5332.200	PASS		
		5500	25.320	5487.200	5512.520	PASS		
		5580	24.000	5567.960	5591.960	PASS		
		5700	23.840	5687.720	5711.560	PASS		
		5720	23.920	5707.960	5731.880	PASS		
		5720 UNII-2C	17.04	5707.960	5725	PASS		
		5720 UNII-3	6.88	5725	5731.880	PASS		
		5745	25.640	5731.800	5757.440	PASS		
		5785	23.720	5773.080	5796.800	PASS		
5825	23.560	5813.000	5836.560	PASS				
11N20SISO	Ant1	5180	24.760	5167.680	5192.440	PASS		
		5200	25.240	5187.600	5212.840	PASS		
		5240	24.640	5227.640	5252.280	PASS		
		5260	24.600	5248.200	5272.800	PASS		
		5280	24.920	5267.680	5292.600	PASS		
		5320	24.720	5307.400	5332.120	PASS		
		5500	26.240	5487.520	5513.760	PASS		
		5580	25.160	5567.120	5592.280	PASS		
		5700	24.920	5687.600	5712.520	PASS		
		5720	24.360	5707.680	5732.040	PASS		
		5720 UNII-2C	17.32	5707.680	5725	PASS		
		5720 UNII-3	7.04	5725	5732.040	PASS		
		5745	24.760	5732.280	5757.040	PASS		
		5785	24.440	5772.480	5796.920	PASS		
5825	25.640	5812.280	5837.920	PASS				
11N40SISO	Ant1	5190	47.680	5166.640	5214.320	PASS		
		5230	46.960	5206.800	5253.760	PASS		
		5270	47.280	5246.480	5293.760	PASS		
		5310	48.080	5286.000	5334.080	PASS		
		5510	50.160	5485.920	5536.080	PASS		
		5550	49.760	5525.520	5575.280	PASS		
		5670	47.120	5645.920	5693.040	PASS		
		5710	46.640	5686.240	5732.880	PASS		
		5710 UNII-2C	38.76	5686.240	5725	PASS		
		5710 UNII-3	7.88	5725	5732.880	PASS		
		5755	46.480	5731.320	5777.800	PASS		
		5795	46.800	5771.080	5817.880	PASS		
		11AX20SISO	Ant1	5180	25.120	5167.640	5192.760	PASS
				5200	24.880	5187.600	5212.480	PASS
5240	24.560			5227.720	5252.280	PASS		
5260	25.160			5247.520	5272.680	PASS		
5280	24.960			5267.520	5292.480	PASS		
5320	24.440			5307.480	5331.920	PASS		
5500	24.920			5487.400	5512.320	PASS		
5580	25.360			5567.160	5592.520	PASS		
5700	24.040			5687.960	5712.000	PASS		
5720	25.040			5707.480	5732.520	PASS		



		5720 UNII-2C	17.52	5707.480	5725	PASS
		5720 UNII-3	7.52	5725	5732.520	PASS
		5745	24.640	5732.920	5757.560	PASS
		5785	24.480	5772.840	5797.320	PASS
		5825	24.360	5812.480	5836.840	PASS
		5190	45.120	5167.680	5212.800	PASS
		5230	45.280	5207.680	5252.960	PASS
		5270	45.040	5247.520	5292.560	PASS
		5310	45.840	5287.680	5333.520	PASS
		5510	46.240	5487.600	5533.840	PASS
		5550	46.640	5527.360	5574.000	PASS
		5670	46.080	5645.920	5692.000	PASS
		5710	44.640	5687.120	5731.760	PASS
		5710 UNII-2C	37.88	5687.120	5725	PASS
		5710 UNII-3	6.76	5725	5731.760	PASS
		5755	46.720	5730.760	5777.480	PASS
		5795	44.880	5772.280	5817.160	PASS
11AX40SISO	Ant1					



### 13.1.2. Test Graphs



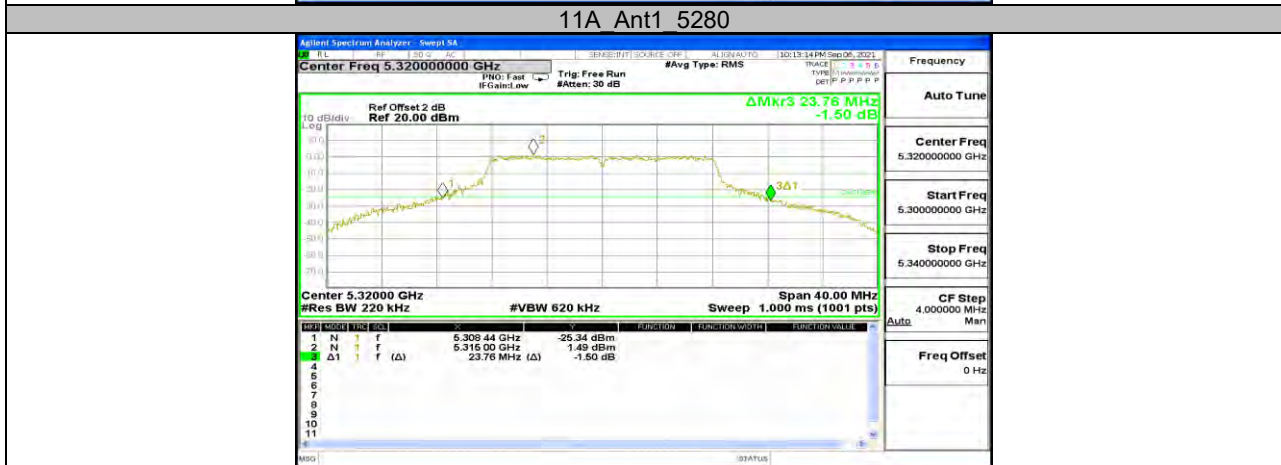





11A Ant1 5500

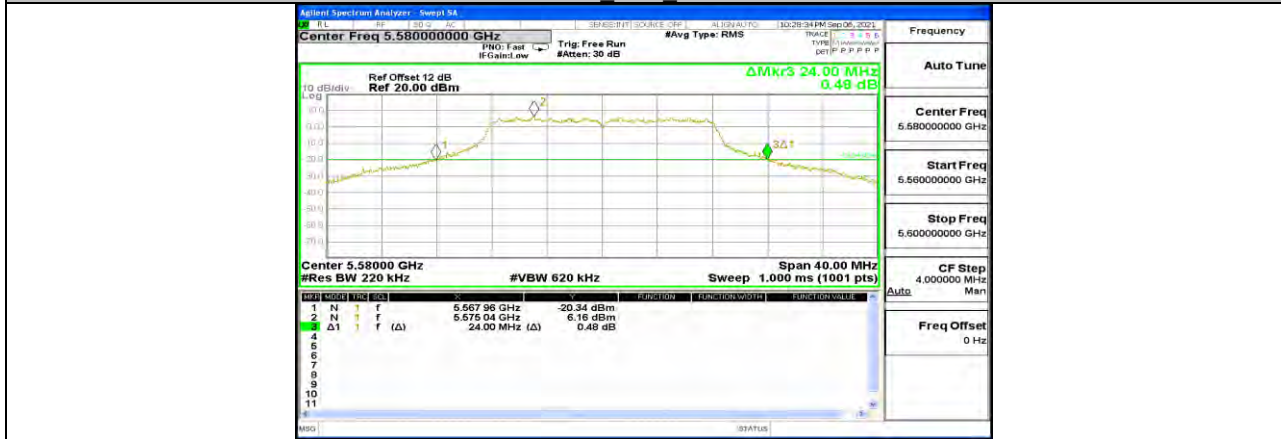

11A Ant1 5580



11A Ant1 5700



11A Ant1 5720



11A Ant1 5745



11A Ant1 5785





11A Ant1 5825



11N20SISO Ant1 5180



11N20SISO Ant1 5200



11N20SISO Ant1 5240



11N20SISO Ant1 5260



11N20SISO Ant1 5280



11N20SISO Ant1 5320



11N20SISO Ant1 5500



11N20SISO Ant1 5580





11N20SISO Ant1 5700



11N20SISO Ant1 5720



11N20SISO Ant1 5745



11N20SISO Ant1 5785



11N20SISO Ant1 5825



11N40SISO Ant1 5190



11N40SISO Ant1 5230



11N40SISO Ant1 5270



11N40SISO Ant1 5310





11N40SISO Ant1 5510

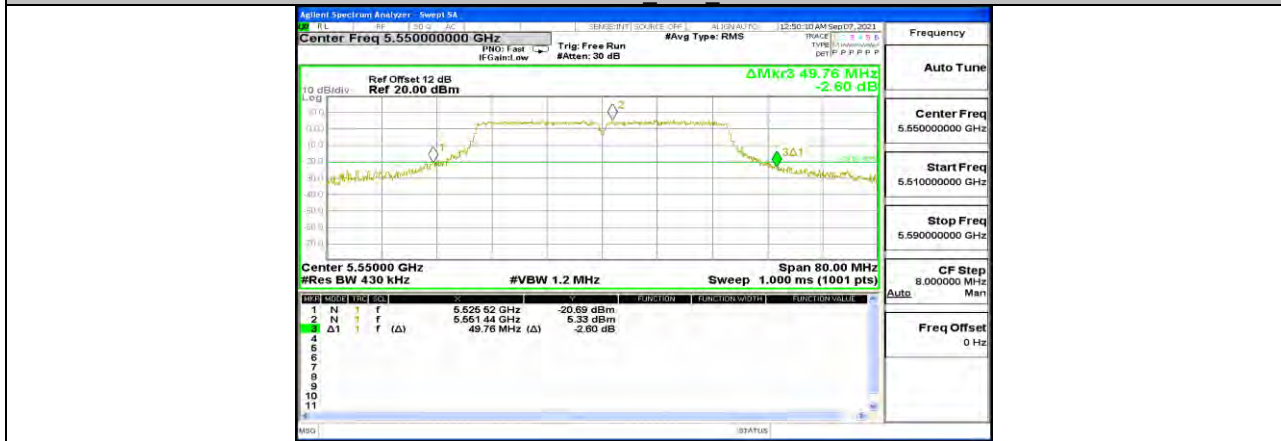

11N40SISO Ant1 5550



11N40SISO Ant1 5670



11N40SISO Ant1 5710



11N40SISO Ant1 5755



11N40SISO Ant1 5795





11AX20SISO Ant1 5180



11AX20SISO Ant1 5200



11AX20SISO Ant1 5240



11AX20SISO Ant1 5260



11AX20SISO Ant1 5280



11AX20SISO Ant1 5320



11AX20SISO Ant1 5500



11AX20SISO Ant1 5580



11AX20SISO Ant1 5700





11AX20SISO Ant1 5720



11AX20SISO Ant1 5745



11AX20SISO Ant1 5785

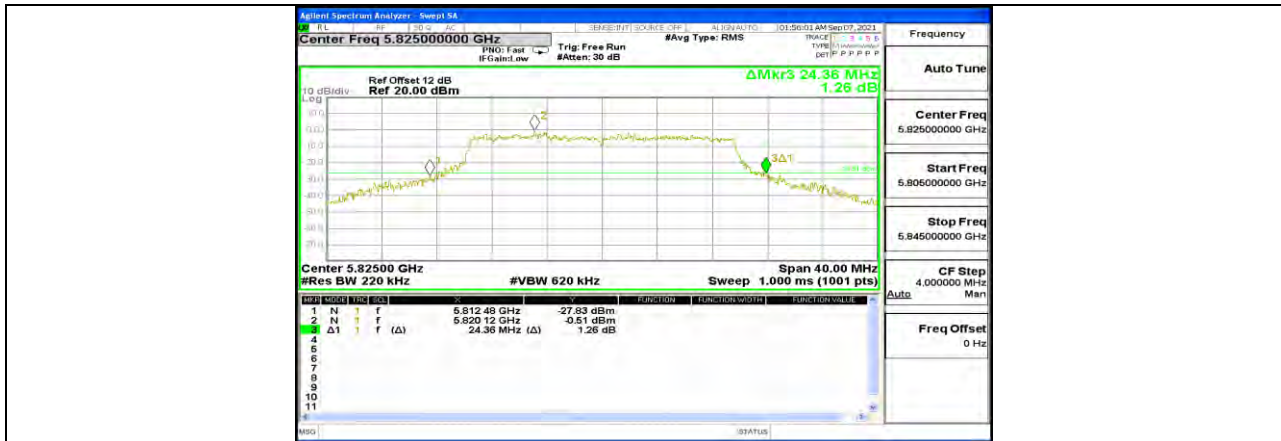

11AX20SISO Ant1 5825



11AX40SISO Ant1 5190



11AX40SISO Ant1 5230



11AX40SISO Ant1 5270



11AX40SISO Ant1 5310



11AX40SISO Ant1 5510





11AX40SISO Ant1 5550



11AX40SISO Ant1 5670

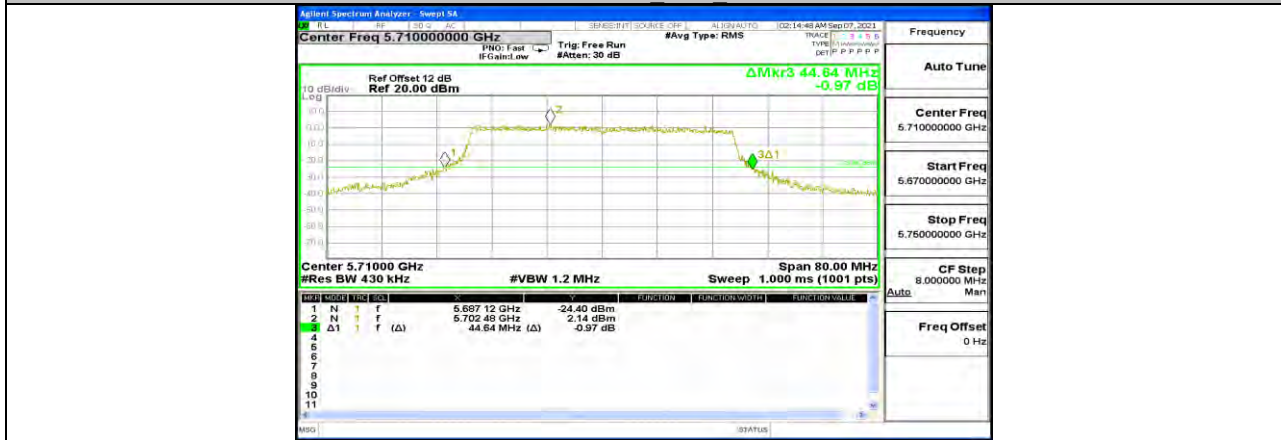

11AX40SISO Ant1 5710