



**CFR 47 FCC PART 15 SUBPART C  
ISED RSS-247 ISSUE 2**

**CERTIFICATION TEST REPORT**

*For*

**WiFi Module**

**MODEL NUMBER: SI07**

**FCC ID: 2AFG6-SI07**

**IC: 22166- SI07**

**REPORT NUMBER: 4789708215-4**

**ISSUE DATE: November 30, 2020**

*Prepared for*

**Guangzhou Shirui Electronics Co Ltd  
192 Kezhu Road, Scientech Park, Guangzhou Economic Technology Development  
District Guangzhou China**

*Prepared by*

**UL Verification Services (Guangzhou) Co., Ltd, Song Shan Lake Branch**

**Building 10, Innovation Technology Park, No. 1, Li Bin Road, Song Shan Lake Hi-  
Tech Development Zone Dongguan, 523808, People's Republic of China**

**Tel: +86 769 22038881**

**Fax: +86 769 33244054**

**Website: [www.ul.com](http://www.ul.com)**



Revision History

<u>Rev.</u>	<u>Issue Date</u>	<u>Revisions</u>	<u>Revised By</u>
V0	11/30/2020	Initial Issue	



Summary of Test Results			
Clause	Test Items	FCC/ISED Rules	Test Results
1	20dB Bandwidth and 99% Occupied Bandwidth	FCC 15.247 (a) (1) RSS-247 Clause 5.1 (a) RSS-Gen Clause 6.7	Pass
2	Conducted Output Power	FCC 15.247 (b) (1) RSS-247 Clause 5.1 (b)	Pass
3	Carrier Hopping Channel Separation	FCC 15.247 (a) (1) RSS-247 Clause 5.1 (b)	Pass
4	Number of Hopping Frequency	15.247 (a) (1) III RSS-247 Clause 5.1 (d)	Pass
5	Time of Occupancy (Dwell Time)	15.247 (a) (1) III RSS-247 Clause 5.1 (d)	Pass
6	Conducted Bandedge	FCC 15.247 (d) RSS-247 Clause 5.5	Pass
7	Radiated Bandedge and Spurious	FCC 15.247 (d) FCC 15.209 FCC 15.205 RSS-247 Clause 5.5 RSS-GEN Clause 8.9 RSS-GEN Clause 8.10	Pass
8	Conducted Emission Test for AC Power Port	FCC 15.207 RSS-GEN Clause 8.8	Pass
9	Antenna Requirement	FCC 15.203 RSS-GEN Clause 6.8	Pass
<p>Note:</p> <p>1. This test report is only published to and used by the applicant, and it is not for evidence purpose in China.</p> <p>2. The measurement result for the sample received is &lt;Pass&gt; according to &lt; CFR 47 FCC PART 15 SUBPART C &gt;&lt; ISED RSS-247 &gt; when &lt;Accuracy Method&gt; decision rule is applied.</p>			



## TABLE OF CONTENTS

<b>1. ATTESTATION OF TEST RESULTS .....</b>	<b>6</b>
<b>2. TEST METHODOLOGY .....</b>	<b>7</b>
<b>3. FACILITIES AND ACCREDITATION .....</b>	<b>7</b>
<b>4. CALIBRATION AND UNCERTAINTY .....</b>	<b>8</b>
4.1. <i>MEASURING INSTRUMENT CALIBRATION .....</i>	<i>8</i>
4.2. <i>MEASUREMENT UNCERTAINTY.....</i>	<i>8</i>
<b>5. EQUIPMENT UNDER TEST .....</b>	<b>9</b>
5.1. <i>DESCRIPTION OF EUT .....</i>	<i>9</i>
5.2. <i>MAXIMUM PEAK OUTPUT POWER .....</i>	<i>9</i>
5.3. <i>PACKET TYPE CONFIGURATION .....</i>	<i>9</i>
5.4. <i>CHANNEL LIST.....</i>	<i>10</i>
5.5. <i>TEST CHANNEL CONFIGURATION.....</i>	<i>10</i>
5.6. <i>WORST-CASE CONFIGURATIONS.....</i>	<i>10</i>
5.7. <i>THE WORSE CASE POWER SETTING PARAMETER.....</i>	<i>11</i>
5.8. <i>DESCRIPTION OF AVAILABLE ANTENNAS .....</i>	<i>11</i>
5.9. <i>DESCRIPTION OF TEST SETUP.....</i>	<i>12</i>
<b>6. MEASURING INSTRUMENT AND SOFTWARE USED .....</b>	<b>13</b>
<b>7. ANTENNA PORT TEST RESULTS .....</b>	<b>15</b>
7.1. <i>ON TIME AND DUTY CYCLE.....</i>	<i>15</i>
7.2. <i>20 dB BANDWIDTH AND 99 % OCCUPIED BANDWIDTH .....</i>	<i>16</i>
7.3. <i>CONDUCTED OUTPUT POWER.....</i>	<i>18</i>
7.4. <i>CARRIER FREQUENCY SEPARATION.....</i>	<i>19</i>
7.5. <i>NUMBER OF HOPPING FREQUENCIES .....</i>	<i>21</i>
7.6. <i>TIME OF OCCUPANCY (DWELL TIME).....</i>	<i>23</i>
7.7. <i>CONDUCTED BANDEDGE AND SPURIOUS EMISSION.....</i>	<i>25</i>
<b>8. RADIATED TEST RESULTS.....</b>	<b>27</b>
8.1. <i>RESTRICTED BANDEDGE.....</i>	<i>33</i>
8.1.1. <i>GFSK MODE .....</i>	<i>33</i>
8.1.2. <i>8DPSK MODE .....</i>	<i>35</i>
8.2. <i>SPURIOUS EMISSIONS (1 GHz ~ 3 GHz).....</i>	<i>37</i>
8.2.1. <i>8DPSK MODE .....</i>	<i>37</i>
8.3. <i>SPURIOUS EMISSIONS (3 GHz ~ 18 GHz).....</i>	<i>39</i>
8.3.1. <i>GFSK MODE .....</i>	<i>39</i>



8.3.2. 8DPSK MODE .....45

8.4. SPURIOUS EMISSIONS (18 GHz ~ 26 GHz) .....51

8.4.1. 8DPSK MODE .....51

8.5. SPURIOUS EMISSIONS (30 MHz ~ 1 GHz).....53

8.5.1. 8DPSK MODE .....53

8.6. SPURIOUS EMISSIONS BELOW 30 MHz .....55

8.6.1. 8DPSK MODE .....55

**9. AC POWER LINE CONDUCTED EMISSIONS .....58**

9.1.1. 8DPSK MODE .....59

**10. ANTENNA REQUIREMENTS .....61**

**Appendix .....62**

*Appendix A: 20dB Emission Bandwidth .....62*

Test Result.....62

Test Graphs .....63

*Appendix B: Occupied Channel Bandwidth .....65*

Test Result.....65

Test Graphs .....66

*Appendix C: Maximum conducted output power.....68*

Test Result.....68

*Appendix D: Carrier frequency separation .....69*

Test Result.....69

Test Graphs .....70

*Appendix E: Time of occupancy .....71*

Test Result.....71

Test Graphs .....72

*Appendix F: Number of hopping channels .....74*

Test Result.....74

Test Graphs .....75

*Appendix G: Band edge measurements .....76*

Test Result.....76

Test Graphs .....77

*Appendix H: Conducted Spurious Emission .....80*

Test Result.....80

Test Graphs .....81

*Appendix I: Duty Cycle .....87*

Test Result.....87

Test Graphs .....88



# 1. ATTESTATION OF TEST RESULTS

## Applicant Information

Company Name: Guangzhou Shirui Electronics Co Ltd  
Address: 192 Kezhu Road, Sciencetech Park, Guangzhou Economic Technology Development District Guangzhou China

## Manufacturer Information

Company Name: Guangzhou Shirui Electronics Co Ltd  
Address: 192 Kezhu Road, Sciencetech Park, Guangzhou Economic Technology Development District Guangzhou China

## EUT Information

EUT Name: WiFi Module  
Model: SI07  
Sample Received Date: October 29, 2020  
Sample Status: Normal  
Sample ID: 3437335  
Date of Tested: October 29, 2020~ November 28, 2020

APPLICABLE STANDARDS	
STANDARD	TEST RESULTS
CFR 47 FCC PART 15 SUBPART C	PASS
ISED RSS-247 Issue 2	PASS
ISED RSS-GEN Issue 5	PASS

Prepared By:

Mick Zhang  
Project Engineer

Checked By:

Shawn Wen  
Laboratory Leader

Approved By:

Stephen Guo  
Laboratory Manager



## 2. TEST METHODOLOGY

The tests documented in this report were performed in accordance with KDB 558074 D01 15.247 Meas Guidance v05r02, 414788 D01 Radiated Test Site v01r01, CFR 47 FCC Part 2, CFR 47 FCC Part 15, ANSI C63.10-2013, ISED RSS-247 Issue 2 and ISED RSS-GEN Issue 5.

## 3. FACILITIES AND ACCREDITATION

Accreditation Certificate	<p><b>A2LA (Certificate No.: 4102.01)</b> UL Verification Services (Guangzhou) Co., Ltd. Song Shan Lake Branch. has been assessed and proved to be in compliance with A2LA.</p> <p><b>FCC (FCC Designation No.: CN1187)</b> UL Verification Services (Guangzhou) Co., Ltd. Song Shan Lake Branch. Has been recognized to perform compliance testing on equipment subject to the Commission's Declaration of Conformity (DoC) and Certification rules</p> <p><b>ISED (Company No.: 21320)</b> UL Verification Services (Guangzhou) Co., Ltd. Song Shan Lake Branch. has been registered and fully described in a report filed with ISED. The Company Number is 21320.</p> <p><b>VCCI (Registration No.: G-20019, R-20004, C-20012 and T-20011)</b> UL Verification Services (Guangzhou) Co., Ltd. Song Shan Lake Branch. has been assessed and proved to be in compliance with VCCI, the Membership No. is 3793. Facility Name: Chamber D, the VCCI registration No. is G-20019 and R-20004 Shielding Room B , the VCCI registration No. is C-20012 and T-20011</p>
---------------------------	--

Note 1: All tests measurement facilities use to collect the measurement data are located at Building 10, Innovation Technology Park, Song Shan Lake Hi tech Development Zone, Dongguan, 523808, China

Note 2: The test anechoic chamber in UL Verification Services (Guangzhou) Co., Ltd. Song Shan Lake Branch had been calibrated and compared to the open field sites and the test anechoic chamber is shown to be equivalent to or worst case from the open field site.

Note 3: For below 30 MHz, lab had performed measurements at test anechoic chamber and comparing to measurements obtained on an open field site. And these measurements below 30 MHz had been correlated to measurements performed on an OFS.



## 4. CALIBRATION AND UNCERTAINTY

### 4.1. MEASURING INSTRUMENT CALIBRATION

The measuring equipment utilized to perform the tests documented in this report has been calibrated in accordance with the manufacturer's recommendations and is traceable to recognized national standards.

### 4.2. MEASUREMENT UNCERTAINTY

Where relevant, the following measurement uncertainty levels have been estimated for tests performed on the apparatus:

Test Item	Uncertainty
Conduction emission	3.62 dB
Radiated Emission (Included Fundamental Emission) (9 kHz ~ 30 MHz)	2.2 dB
Radiated Emission (Included Fundamental Emission) (30 MHz ~ 1 GHz)	4.00 dB
Radiated Emission (Included Fundamental Emission) (1 GHz to 26 GHz)	5.78 dB (1 GHz ~ 18 GHz)
	5.23 dB (18 GHz ~ 26 GHz)
Note: This uncertainty represents an expanded uncertainty expressed at approximately the 95 % confidence level using a coverage factor of k=2.	





## 5. EQUIPMENT UNDER TEST

### 5.1. DESCRIPTION OF EUT

EUT Name	WiFi Module		
Model	SI07		
Technology	Bluetooth – BR & EDR		
Transmit Frequency Range	2402 MHz ~ 2480 MHz		
Mode	Basic Rate	Enhanced Data Rate	
Modulation	GFSK	π/4-DQPSK	8DPSK
Packet Type (Maximum Payload):	DH5	2DH5	3DH5
Data Rate	1 Mbps	2 Mbps	3M bps
Power Supply	DC State	Rate Input:	DC 5 V
Wireless Module	SKI.WB8822CU.1		

### 5.2. MAXIMUM PEAK OUTPUT POWER

Test Mode	Frequency (MHz)	Channel Number	Maximum Peak Output Power (dBm)	Maximum EIRP (dBm)
GFSK	2402 ~ 2480	0-78[79]	5.71	8.46
8DPSK	2402 ~ 2480	0-78[79]	8.33	12.08

### 5.3. PACKET TYPE CONFIGURATION

Test Mode	Packet Type	Setting (Packet Length)
GFSK	DH1	27
	DH3	183
	DH5	339
π/4-DQPSK	2-DH1	54
	2-DH3	367
	2-DH5	679
8DPSK	3-DH1	83
	3-DH3	552
	3-DH5	1021

## 5.4. CHANNEL LIST

Channel	Frequency (MHz)	Channel	Frequency (MHz)	Channel	Frequency (MHz)	Channel	Frequency (MHz)
00	2402	20	2422	40	2442	60	2462
01	2403	21	2423	41	2443	61	2463
02	2404	22	2424	42	2444	62	2464
03	2405	23	2425	43	2445	63	2465
04	2406	24	2426	44	2446	64	2466
05	2407	25	2427	45	2447	65	2467
06	2408	26	2428	46	2448	66	2468
07	2409	27	2429	47	2449	67	2469
08	2410	28	2430	48	2450	68	2470
09	2411	29	2431	49	2451	69	2471
10	2412	30	2432	50	2452	70	2472
11	2413	31	2433	51	2453	71	2473
12	2414	32	2434	52	2454	72	2474
13	2415	33	2435	53	2455	73	2475
14	2416	34	2436	54	2456	74	2476
15	2417	35	2437	55	2457	75	2477
16	2418	36	2438	56	2458	76	2478
17	2419	37	2439	57	2459	77	2479
18	2420	38	2440	58	2460	78	2480
19	2421	39	2441	59	2461	/	/

## 5.5. TEST CHANNEL CONFIGURATION

Test Mode	Test Channel	Frequency
GFSK	CH 0(Low Channel), CH 39(MID Channel), CH 78(High Channel)	2402 MHz, 2441 MHz, 2480 MHz
8DPSK	CH 0(Low Channel), CH 39(MID Channel), CH 78(High Channel)	2402 MHz, 2441 MHz, 2480 MHz
GFSK	Hop	2402 MHz ~ 2480 MHz
8DPSK	Hop	2402 MHz ~ 2480 MHz

Note: The hop is hopping mode.

## 5.6. WORST-CASE CONFIGURATIONS

Test Mode	Modulation Technology	Modulation Type	Data Rate	Packet Type
BR	FHSS	GFSK	1Mbit/s	DH5
EDR	FHSS	8DPSK	3Mbit/s	3-DH5

Note: Pre-Scan has been conducted to determine the worst-case mode from all possible combinations between available modulations, data rates. Only GFSK and 8DPSK test data were report in this report.

## 5.7. THE WORSE CASE POWER SETTING PARAMETER

The Worst Case Power Setting Parameter under 2400 ~ 2483.5 MHz Band				
Test Software		RTLBTAPP		
Test Mode	Transmit Antenna Number	Test Software Setting Value		
		CH 00	CH 39	CH 78
GFSK	1	Default	Default	Default
8DPSK	1	Default	Default	Default

## 5.8. DESCRIPTION OF AVAILABLE ANTENNAS

Antenna	Frequency (MHz)	Antenna Type	MAX Antenna Gain (dBi)
1	2402-2480	FPC antenna	3.75

Note: The value of the antenna gain was declared by customer.

Test Mode	Transmit and Receive Mode	Description
GFSK	<input checked="" type="checkbox"/> 1TX, 1RX	Antenna 1 can be used as transmitting/receiving antenna.
8DPSK	<input checked="" type="checkbox"/> 1TX, 1RX	Antenna 1 can be used as transmitting/receiving antenna.

Note: The EUT have two wireless modules, one is called module SKI.WB7668CU.1 and the other one called module SKI.WB8822CU.1.

Simultaneously transmission condition.

Condition	Technology				Support (YES/NO)
	WLAN(2.4G)	BLE	WLAN(2.4G)	WLAN(5G)	
1 (Module SKI.WB7668CU.1)	WLAN(2.4G)		WLAN(5G)		NO
2 (Module SKI.WB8822CU.1)	BT	BLE	WLAN(2.4G)	WLAN(5G)	NO

Co-Location condition.

Condition	Technology (Module SKI.WB7668CU.1)	Technology (Module SKI.WB8822CU.1)	Support (YES/NO)
1	WLAN(2.4G)	BT	YES
2	WLAN(2.4G)	BLE	YES
3	WLAN(2.4G)	WLAN (2.4G)	YES
4	WLAN(2.4G)	WLAN (5G)	YES
5	WLAN (5G)	BT	YES
6	WLAN (5G)	BLE	YES
7	WLAN (5G)	WLAN (2.4G)	YES
8	WLAN (5G)	WLAN (5G)	YES

Note: For the Co-Location test result please refer to test report 4789708215-10.

## 5.9. DESCRIPTION OF TEST SETUP

### SUPPORT EQUIPMENT

Item	Equipment	Brand Name	Model Name	P/N
1	PC	Dell	Vostro 3902	8KNDDDB2

### I/O CABLES

Cable No	Port	Connector Type	Cable Type	Cable Length(m)	Remarks
1	USB	/	/	1.0	/

### ACCESSORIES

Item	Accessory	Brand Name	Model Name	Description
/	/	/	/	/

### TEST SETUP

The EUT can work in engineering mode with a software through a Laptop.

### SETUP DIAGRAM FOR TESTS

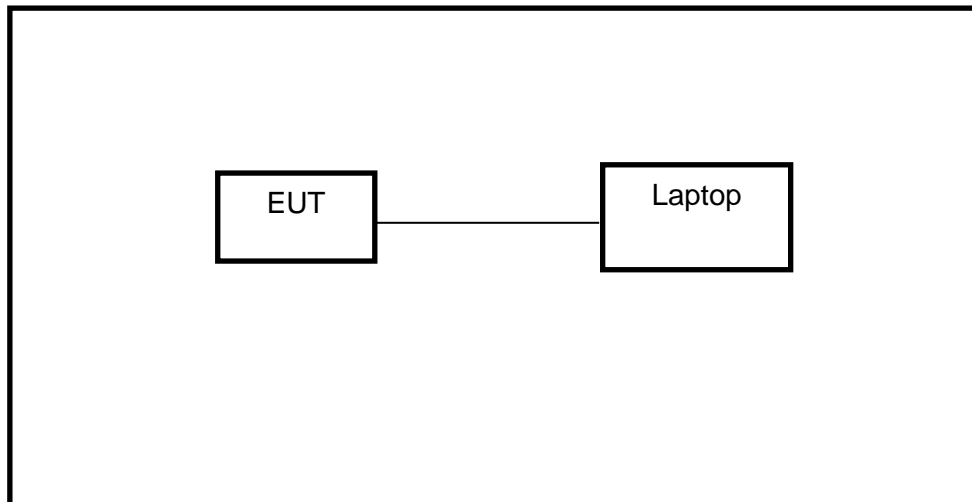

**6. MEASURING INSTRUMENT AND SOFTWARE USED**

Conducted Emissions						
Instrument						
Used	Equipment	Manufacturer	Model No.	Serial No.	Last Cal.	Next Cal.
<input checked="" type="checkbox"/>	EMI Test Receiver	R&S	ESR3	101961	Dec.05,2019	Dec.05,2020
<input checked="" type="checkbox"/>	Two-Line V- Network	R&S	ENV216	101983	Dec.05,2019	Dec.05,2020
Software						
Used	Description	Manufacturer	Name	Version		
<input checked="" type="checkbox"/>	Test Software for Conducted disturbance	Farad	EZ-EMC	Ver. UL-3A1		
Radiated Emissions						
Instrument						
Used	Equipment	Manufacturer	Model No.	Serial No.	Last Cal.	Next Cal.
<input checked="" type="checkbox"/>	MXE EMI Receiver	KESIGHT	N9038A	MY56400036	Dec.06,2019	Dec.06,2020
<input checked="" type="checkbox"/>	Hybrid Log Periodic Antenna	TDK	HLP-3003C	130960	Sep.17, 2018	Sep.17, 2021
<input checked="" type="checkbox"/>	Preamplifier	HP	8447D	2944A09099	Dec.05,2019	Dec.05,2020
<input checked="" type="checkbox"/>	EMI Measurement Receiver	R&S	ESR26	101377	Dec.05,2019	Dec.05,2020
<input checked="" type="checkbox"/>	Horn Antenna	TDK	HRN-0118	130939	Sep.17, 2018	Sep.17, 2021
<input checked="" type="checkbox"/>	High Gain Horn Antenna	Schwarzbeck	BBHA-9170	691	Aug.11, 2018	Aug.11, 2021
<input checked="" type="checkbox"/>	Preamplifier	TDK	PA-02-0118	TRS-305- 00066	Dec.05,2019	Dec.05,2020
<input checked="" type="checkbox"/>	Preamplifier	TDK	PA-02-2	TRS-307- 00003	Dec.05,2019	Dec.05,2020
<input checked="" type="checkbox"/>	Loop antenna	Schwarzbeck	1519B	00008	Jan.07, 2019	Jan.07, 2022
<input checked="" type="checkbox"/>	Preamplifier	TDK	PA-02-001- 3000	TRS-302- 00050	Dec.5, 2019	Dec.5, 2020
<input checked="" type="checkbox"/>	High Pass Filter	Wi	WHKX10- 2700-3000- 18000-40SS	23	Dec.05,2019	Dec.05,2020
Software						
Used	Description	Manufacturer	Name	Version		
<input checked="" type="checkbox"/>	Test Software for Radiated disturbance	Farad	EZ-EMC	Ver. UL-3A1		



Other instruments						
Used	Equipment	Manufacturer	Model No.	Serial No.	Last Cal.	Next Cal.
<input checked="" type="checkbox"/>	Spectrum Analyzer	Keysight	N9030A	MY55410512	Dec.06,2019	Dec.06,2020
<input checked="" type="checkbox"/>	Spectrum Analyzer	Keysight	N9020A	MY49100060	Dec.06,2019	Dec.06,2020
<input checked="" type="checkbox"/>	Power Meter	Keysight	N1911A	MY55416024	Dec.06,2019	Dec.06,2020
<input checked="" type="checkbox"/>	Power Sensor	Keysight	U2021XA	MY5100022	Dec.06,2019	Dec.06,2020



## 7. ANTENNA PORT TEST RESULTS

### 7.1. ON TIME AND DUTY CYCLE

#### LIMITS

None; for reporting purposes only.

#### PROCEDURE

Refer to ANSI C63.10-2013 Zero – Span Spectrum Analyzer method.

#### TEST SETUP

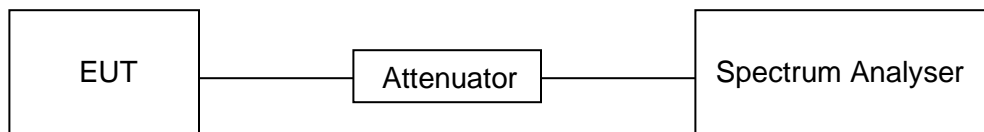

#### TEST ENVIRONMENT

Temperature	25.4 °C	Relative Humidity	61 %
Atmosphere Pressure	101 kPa	Test Voltage	DC 5 V

#### RESULTS

Please refer to appendix I.

## 7.2. 20 dB BANDWIDTH AND 99 % OCCUPIED BANDWIDTH

### LIMITS

CFR 47FCC Part15 (15.247) Subpart C ISED RSS-247 ISSUE 2			
Section	Test Item	Limit	Frequency Range (MHz)
CFR 47 FCC 15.247 (a) (1) RSS-247 Clause 5.1 (a)	20 dB Bandwidth	None; for reporting purposes only.	2400-2483.5
ISED RSS-Gen Clause 6.7	99 % Occupied Bandwidth	None; for reporting purposes only.	2400-2483.5

### TEST PROCEDURE

Refer to ANSI C63.10-2013 clause 6.9.2.

Connect the EUT to the spectrum analyser and use the following settings:

Center Frequency	The center frequency of the channel under test
Detector	Peak
RBW	For 20 dB Bandwidth: 1 % to 5 % of the 20 dB bandwidth For 99 % Occupied Bandwidth: 1 % to 5 % of the occupied bandwidth
VBW	For 20 dB Bandwidth: approximately 3×RBW For 99 % Occupied Bandwidth: ≥ 3×RBW
Span	Approximately 2 to 3 times the 20dB bandwidth
Trace	Max hold
Sweep	Auto couple

a) Use the occupied bandwidth function of the instrument, allow the trace to stabilize and report the measured 99 % occupied bandwidth and 20 dB Bandwidth.

### TEST SETUP

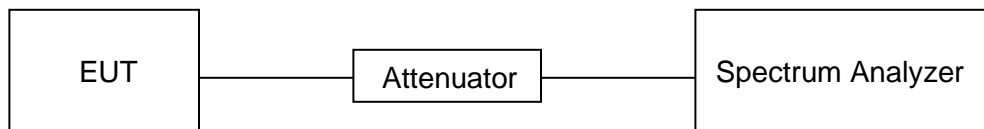





**TEST ENVIRONMENT**

Temperature	25.4 °C	Relative Humidity	61 %
Atmosphere Pressure	101 kPa	Test Voltage	DC 5 V

**RESULTS**

Please refer to appendix A and B.

### 7.3. CONDUCTED OUTPUT POWER

**LIMITS**

CFR 47 FCC Part15 (15.247), Subpart C ISED RSS-247 ISSUE 2			
Section	Test Item	Limit	Frequency Range (MHz)
CFR 47 FCC 15.247 (b) (1) ISED RSS-247 Clause 5.4 (b)	Peak Conducted Output Power	Hopping channel carrier frequencies separated by a minimum of 25 kHz or the 20 dB bandwidth of the hopping channel: 1 watt or 30 dBm; Hopping channel carrier frequencies that are separated by 25 kHz or two-thirds of the 20 dB bandwidth of the hopping channel: 125 mW or 21 dBm	2400-2483.5

**TEST PROCEDURE**

Connect the EUT to a low loss RF cable from the antenna port to the power sensor (video bandwidth is greater than the occupied bandwidth).  
Measure peak emission level, the indicated level is the peak output power, after any corrections for external attenuators and cables.

**TEST SETUP**

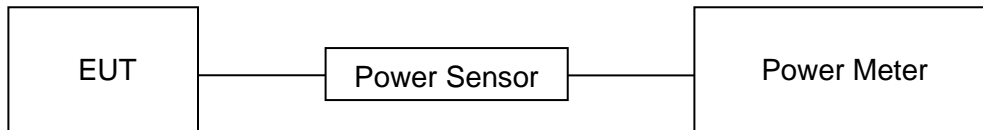

**TEST ENVIRONMENT**

Temperature	25.4 °C	Relative Humidity	61 %
Atmosphere Pressure	101 kPa	Test Voltage	DC 5 V

**RESULTS**

Please refer to appendix C.

## 7.4. CARRIER FREQUENCY SEPARATION

### LIMITS

CFR 47 FCC Part15 (15.247), Subpart C ISSED RSS-247 ISSUE 2			
Section	Test Item	Limit	Frequency Range (MHz)
CFR 47 FCC 15.247 (a) (1) ISED RSS-247 Clause 5.1 (b)	Carrier Frequency Separation	Frequency hopping systems shall have hopping channel carrier frequencies separated by a minimum of 25 kHz or the 20 dB bandwidth of the hopping channel, whichever is greater. Alternatively, frequency hopping systems operating in the 2400-2483.5 MHz band may have hopping channel carrier frequencies that are separated by 25 kHz or two-thirds of the 20 dB bandwidth of the hopping channel.	2400-2483.5

### TEST PROCEDURE

Refer to ANSI C63.10-2013 clause 7.8.2.

Connect the EUT to the spectrum analyzer and use the following settings:

Center Frequency	The center frequency of the channel under test
Span	wide enough to capture the peaks of two adjacent channels
Detector	Peak
RBW	Start with the RBW set to approximately 30 % of the channel spacing; adjust as necessary to best identify the center of each individual channel.
VBW	≥RBW
Trace	Max hold
Sweep time	Auto couple

Allow the trace to stabilize and use the marker-delta function to determine the separation between the peaks of the adjacent channels.

Compliance of an EUT with the appropriate regulatory limit shall be determined.

### TEST SETUP

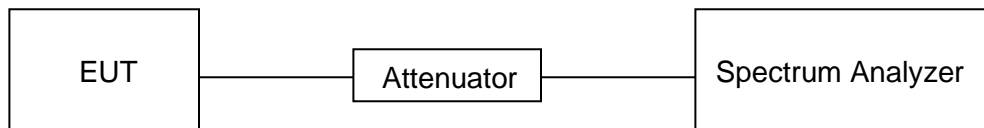



**TEST ENVIRONMENT**

Temperature	25.4 °C	Relative Humidity	61 %
Atmosphere Pressure	101 kPa	Test Voltage	DC 5 V

**RESULTS**

Please refer to Appendix D.

## 7.5. NUMBER OF HOPPING FREQUENCIES

### LIMITS

CFR 47 FCC Part15 (15.247), Subpart C ISED RSS-247 ISSUE 2		
Section	Test Item	Limit
CFR 47 15.247 (a) (1) III ISED RSS-247 Clause 5.1 (d)	Number of Hopping Frequency	at least 15 hopping channels

### TEST PROCEDURE

Refer to ANSI C63.10-2013 clause 7.8.3.

Connect the EUT to the spectrum Analyzer and use the following settings:

Detector	Peak
RBW	To identify clearly the individual channels, set the RBW to less than 30% of the channel spacing or the 20 dB bandwidth, whichever is smaller.
VBW	$\geq$ RBW
Span	The frequency band of operation. Depending on the number of channels the device supports, it may be necessary to divide the frequency range of operation across multiple spans, to allow the individual channels to be clearly seen.
Trace	Max hold
Sweep time	Auto couple

Set EUT to transmit maximum output power and switch on frequency hopping function. then set enough count time (larger than 5000 times) to get all the hopping frequency channel displayed on the screen of spectrum analyzer, count the quantity of peaks to get the number of hopping channels.

### TEST SETUP

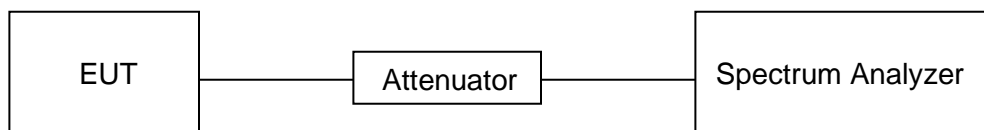



**TEST ENVIRONMENT**

Temperature	25.4 °C	Relative Humidity	61 %
Atmosphere Pressure	101 kPa	Test Voltage	DC 5 V

**RESULTS**

Please refer to appendix F.



## 7.6. TIME OF OCCUPANCY (DWELL TIME)

### LIMITS

CFR 47 FCC Part15 (15.247), Subpart C ISED RSS-247 ISSUE 2		
Section	Test Item	Limit
CFR 47 15.247 (a) (1) III ISED RSS-247 Clause 5.1 (d)	Time of Occupancy (Dwell Time)	The average time of occupancy on any channel shall not be greater than 0.4 seconds within a period of 0.4 seconds, multiplied by the number of hopping channels employed.

### TEST PROCEDURE

Refer to ANSI C63.10-2013 clause 7.8.4.

Connect the EUT to the spectrum Analyzer and use the following settings:

Center Frequency	The center frequency of the channel under test
Detector	Peak
RBW	1 MHz
VBW	≥RBW
Span	Zero span, centered on a hopping channel
Trace	Max hold
Sweep time	As necessary to capture the entire dwell time per hopping channel; where possible use a video trigger and trigger delay so that the transmitted signal starts a little to the right of the start of the plot. The trigger level might need slight adjustment to prevent triggering when the system hops on an adjacent channel

Use the marker-delta function to determine the transmit time per hop (Burst Width). If this value varies with different modes of operation (data rate, modulation format, number of hopping channels, etc.), then repeat this test for each variation in transmit time.

For FHSS Mode (79 Channel):

DH1/3DH1 Dwell Time: Burst Width \* (1600/2) \* 31.6 / (channel number)

DH3/3DH3 Dwell Time: Burst Width \* (1600/4) \* 31.6 / (channel number)

DH5/3DH5 Dwell Time: Burst Width \* (1600/6) \* 31.6 / (channel number)

For AFHSS Mode (20 Channel):

DH1/3DH1 Dwell Time: Burst Width \* (800/2) \* 8 / (channel number)

DH3/3DH3 Dwell Time: Burst Width \* (800/4) \* 8 / (channel number)

DH5/3DH5 Dwell Time: Burst Width \* (800/6) \* 8 / (channel number)



**TEST SETUP**

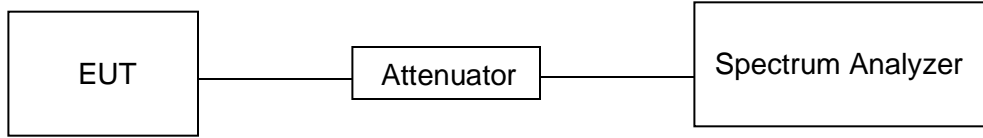

**TEST ENVIRONMENT**

Temperature	25.4 °C	Relative Humidity	61 %
Atmosphere Pressure	101 kPa	Test Voltage	DC 5 V

**RESULTS**

Please refer to appendix E.





## 7.7. CONDUCTED BANDEGE AND SPURIOUS EMISSION

### LIMITS

CFR 47 FCC Part15 (15.247), Subpart C ISED RSS-247 ISSUE 2		
Section	Test Item	Limit
CFR 47 FCC §15.247 (d) ISED RSS-247 5.5	Conducted Spurious Emission	at least 20 dB below that in the 100 kHz bandwidth within the band that contains the highest level of the desired power

### TEST PROCEDURE

Refer to ANSI C63.10-2013 clause 7.8.6 and 7.8.8.

Connect the EUT to the spectrum analyser and use the following settings for reference level measurement:

Center Frequency	The center frequency of the channel under test
Detector	Peak
RBW	100 kHz
VBW	$\geq 3 \times \text{RBW}$
Span	1.5 x DTS bandwidth
Trace	Max hold
Sweep time	Auto couple.

Allow trace to fully stabilize and use the peak marker function to determine the maximum PSD level.

Change the settings for emission level measurement:

Span	Set the center frequency and span to encompass frequency range to be measured
Detector	Peak
RBW	100 kHz
VBW	$\geq 3 \times \text{RBW}$
measurement points	$\geq \text{span}/\text{RBW}$
Trace	Max hold
Sweep time	Auto couple.

Allow trace to fully stabilize and use the peak marker function to determine the maximum PSD level. Ensure that the amplitude of all unwanted emissions outside of the authorized frequency band (excluding restricted frequency bands) is attenuated by at least the minimum requirements.



**TEST SETUP**

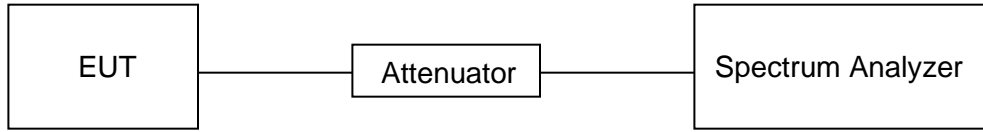

**TEST ENVIRONMENT**

Temperature	25.4 °C	Relative Humidity	61 %
Atmosphere Pressure	101 kPa	Test Voltage	DC 5 V

**RESULTS**

Please refer to appendix G & H.



## 8. RADIATED TEST RESULTS

### LIMITS

Please refer to CFR 47 FCC §15.205 and §15.209.

Please refer to ISED RSS-GEN Clause 8.9 and Clause 8.10.

Radiation Disturbance Test Limit for FCC (Class B) (9 kHz-1 GHz)

Emissions radiated outside of the specified frequency bands above 30 MHz		
Frequency Range (MHz)	Field Strength Limit (uV/m) at 3 m	Field Strength Limit (dBuV/m) at 3 m
		Quasi-Peak
30 - 88	100	40
88 - 216	150	43.5
216 - 960	200	46
Above 960	500	54
Above 1000	500	Peak
		Average
		74
		54

FCC Emissions radiated outside of the specified frequency bands below 30 MHz		
Frequency (MHz)	Field strength (microvolts/meter)	Measurement distance (meters)
0.009-0.490	2400/F(kHz)	300
0.490-1.705	24000/F(kHz)	30
1.705-30.0	30	30

ISED General field strength limits at frequencies below 30 MHz

Table 6 – General field strength limits at frequencies below 30 MHz		
Frequency	Magnetic field strength (H-Field) (µA/m)	Measurement distance (m)
9 - 490 kHz <sup>Note 1</sup>	6.37/F (F in kHz)	300
490 - 1705 kHz	63.7/F (F in kHz)	30
1.705 - 30 MHz	0.08	30

**Note 1:** The emission limits for the ranges 9-90 kHz and 110-490 kHz are based on measurements employing a linear average detector.



ISED Restricted bands please refer to ISED RSS-GEN Clause 8.10

Table 7 – Restricted frequency bands <sup>Note 1</sup>		
MHz	MHz	GHz
0.090 - 0.110	149.9 - 150.05	9.0 - 9.2
0.495 - 0.505	156.52475 - 156.52525	9.3 - 9.5
2.1735 - 2.1905	156.7 - 156.9	10.6 - 12.7
3.020 - 3.026	162.0125 - 167.17	13.25 - 13.4
4.125 - 4.128	167.72 - 173.2	14.47 - 14.5
4.17725 - 4.17775	240 - 285	15.35 - 16.2
4.20725 - 4.20775	322 - 335.4	17.7 - 21.4
5.677 - 5.683	399.9 - 410	22.01 - 23.12
6.215 - 6.218	608 - 614	23.6 - 24.0
6.26775 - 6.26825	960 - 1427	31.2 - 31.8
6.31175 - 6.31225	1435 - 1626.5	36.43 - 36.5
8.291 - 8.294	1645.5 - 1646.5	Above 38.6
8.362 - 8.366	1660 - 1710	
8.37625 - 8.38675	1718.8 - 1722.2	
8.41425 - 8.41475	2200 - 2300	
12.29 - 12.293	2310 - 2390	
12.51975 - 12.52025	2483.5 - 2500	
12.57675 - 12.57725	2655 - 2900	
13.36 - 13.41	3260 - 3267	
16.42 - 16.423	3332 - 3339	
16.69475 - 16.69525	3345.8 - 3358	
16.80425 - 16.80475	3500 - 4400	
25.5 - 25.67	4500 - 5150	
37.5 - 38.25	5350 - 5460	
73 - 74.6	7250 - 7750	
74.8 - 75.2	8025 - 8500	
108 - 138		

**Note 1:** Certain frequency bands listed in table 7 and in bands above 38.6 GHz are designated for licence-exempt applications. These frequency bands and the requirements that apply to related devices are set out in the 200 and 300 series of RSSs.

FCC Restricted bands of operation refer to FCC §15.205 (a):

MHz	MHz	MHz	GHz
0.090-0.110	16.42-16.423	399.9-410	4.5-5.15
<sup>1</sup> 0.495-0.505	16.69475-16.69525	608-614	5.35-5.46
2.1735-2.1905	16.80425-16.80475	960-1240	7.25-7.75
4.125-4.128	25.5-25.67	1300-1427	8.025-8.5
4.17725-4.17775	37.5-38.25	1435-1626.5	9.0-9.2
4.20725-4.20775	73-74.6	1645.5-1646.5	9.3-9.5
6.215-6.218	74.8-75.2	1660-1710	10.6-12.7
6.26775-6.26825	108-121.94	1718.8-1722.2	13.25-13.4
6.31175-6.31225	123-138	2200-2300	14.47-14.5
8.291-8.294	149.9-150.05	2310-2390	15.35-16.2
8.362-8.366	156.52475-156.52525	2483.5-2500	17.7-21.4
8.37625-8.38675	156.7-156.9	2690-2900	22.01-23.12
8.41425-8.41475	162.0125-167.17	3260-3267	23.6-24.0
12.29-12.293	167.72-173.2	3332-3339	31.2-31.8
12.51975-12.52025	240-285	3345.8-3358	36.43-36.5
12.57675-12.57725	322-335.4	3600-4400	( <sup>2</sup> )
13.36-13.41			

Note: <sup>1</sup>Until February 1, 1999, this restricted band shall be 0.490-0.510 MHz.

<sup>2</sup>Above 38.6c

**TEST SETUP AND PROCEDURE**

Below 30 MHz

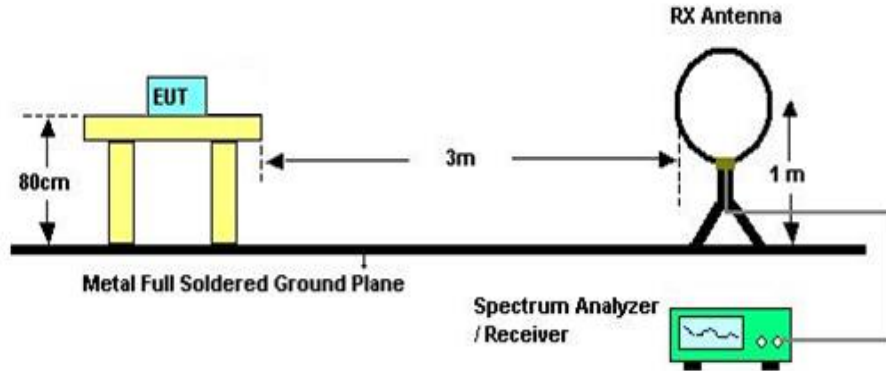

The setting of the spectrum analyser

RBW	200 Hz (From 9 kHz to 0.15 MHz)/ 9 kHz (From 0.15 MHz to 30 MHz)
VBW	200 Hz (From 9 kHz to 0.15 MHz)/ 9 kHz (From 0.15 MHz to 30 MHz)
Sweep	Auto
Trace	Max hold

1. The testing follows the guidelines in ANSI C63.10-2013 clause 6.4.
2. The EUT was arranged to its worst case and then turntable (from 0 degree to 360 degrees) to find the maximum reading. A pre-amp and a high pass filter are used for the test in order to get better signal level. Both Horizontal, Face-on and Face-off polarizations of the antenna are set to make the measurement.
3. The EUT was placed on a turntable with 80 cm above ground.
4. The EUT was set 3 meters from the interference receiving antenna, which was mounted on the top of a 1 m height antenna tower.
5. The radiated emission limits are based on measurements employing a CISPR quasi-peak detector except for the frequency bands 9-90 kHz, 110-490 kHz and above 1000 MHz. Radiated emission limits in these three bands are based on measurements employing an average detector.
6. For measurement below 1 GHz, the initial step in collecting conducted emission data is a spectrum analyzer peak detector mode pre-scanning the measurement frequency range. Significant peaks are then marked and then Quasi Peak and average detector mode re-measured. If the emission level of the EUT measured by the peak detector is 3 dB lower than the applicable limit, the peak emission level will be reported. Otherwise, the emission measurement will be repeated using the quasi-peak and average detector and reported.
7. Although these tests were performed other than open field site, adequate comparison measurements were confirmed against 30m open field site. Therefore sufficient tests were made to demonstrate that the alternative site produces results that correlate with the ones of tests made in an open field site based on KDB 414788.

Below 1 GHz and above 30 MHz

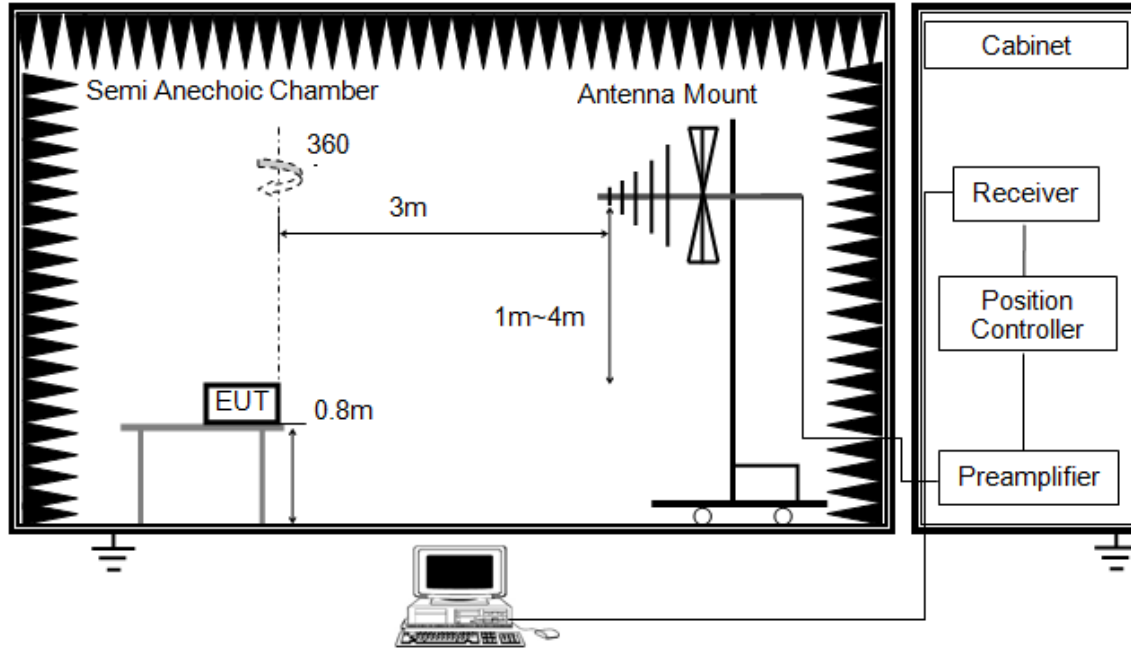

The setting of the spectrum analyser

RBW	120 kHz
VBW	300 kHz
Sweep	Auto
Detector	Peak/QP
Trace	Max hold

1. The testing follows the guidelines in ANSI C63.10-2013 clause 6.5.
2. The EUT was arranged to its worst case and then tune the antenna tower (from 1 m to 4 m) and turntable (from 0 degree to 360 degrees) to find the maximum reading. A pre-amp and a high pass filter are used for the test in order to get better signal level. Both horizontal and vertical polarizations of the antenna are set to make the measurement.
3. The EUT was placed on a turntable with 80 cm above ground.
4. The EUT was set 3 meters from the interference receiving antenna, which was mounted on the top of a variable height antenna tower.
5. For measurement below 1 GHz, the initial step in collecting conducted emission data is a spectrum analyzer peak detector mode pre-scanning the measurement frequency range. Significant peaks are then marked and then Quasi Peak detector mode re-measured. If the emission level of the EUT measured by the peak detector is 3 dB lower than the applicable limit, the peak emission level will be reported. Otherwise, the emission measurement will be repeated using the quasi-peak detector and reported.

Above 1 GHz



The setting of the spectrum analyser

RBW	1 MHz
VBW	PEAK: 3 MHz AVG: see note 6
Sweep	Auto
Detector	Peak
Trace	Max hold

1. The testing follows the guidelines in ANSI C63.10-2013 clause 6.6.
2. The EUT was arranged to its worst case and then tune the antenna tower (1.5 m) and turntable (from 0 degree to 360 degrees) to find the maximum reading. A pre-amp and a high pass filter are used for the test in order to get better signal level. Both horizontal and vertical polarizations of the antenna are set to make the measurement.
3. The EUT was placed on a turntable with 1.5 m above ground.
4. The EUT was set 3 meters from the interference receiving antenna, which was mounted on the top of a variable height antenna tower.
5. For measurement above 1 GHz, the emission measurement will be measured by the peak detector. This peak level, once corrected, must comply with the limit specified in Section 15.209.
6. For measurements above 1 GHz the resolution bandwidth is set to 1 MHz, then the video bandwidth is set to 3 MHz for peak measurements and 1 MHz resolution bandwidth with 1/T video bandwidth with peak detector for average measurements. For the Duty Cycle please refer to clause 7.1.ON TIME AND DUTY CYCLE.

X axis, Y axis, Z axis positions:

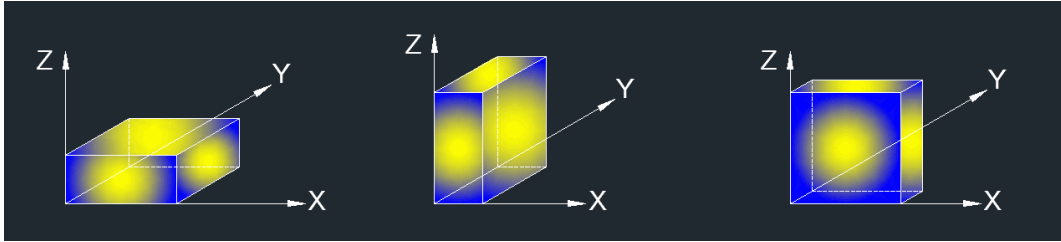

Note 1: For all radiated test, EUT in each of three orthogonal axis emissions had been tested, but only the worst case (X axis) data recorded in the report.

Note 2: Simultaneous transmission had been evaluated with the 2.4G Hz WiFi, 5 GHz WiFi and BT transmitter and there were no any additional or worse emissions found. Only the worst data was recorded in the test report.

Note 3: The EUT was fully exercised with external accessories during the test. In the case of multiple accessory external ports, an external accessory shall be connected to one of each type of port.

**TEST ENVIRONMENT**

Temperature	24.9 °C	Relative Humidity	57 %
Atmosphere Pressure	101 kPa	Test Voltage	DC 5 V

**RESULTS**



## 8.1. RESTRICTED BANDEDGE

### 8.1.1. GFSK MODE

#### RESTRICTED BANDEDGE (LOW CHANNEL, HORIZONTAL)

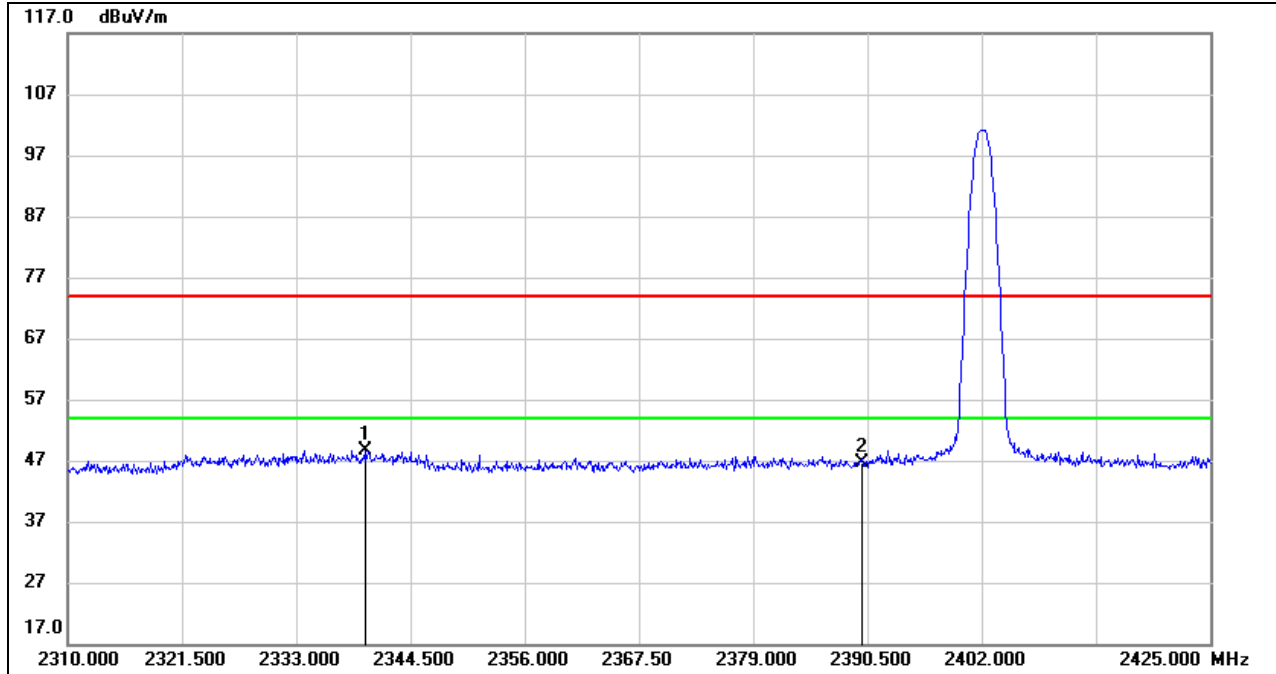

No.	Frequency (MHz)	Reading (dBuV)	Correct (dB/m)	Result (dBuV/m)	Limit (dBuV/m)	Margin (dB)	Remark
1	2339.900	15.98	32.77	48.75	74.00	-25.25	peak
2	2390.000	13.73	32.94	46.67	74.00	-27.33	peak

Note: 1. Measurement = Reading Level + Correct Factor.  
 2. If Peak Result complies with AV limit, AV Result is deemed to comply with AV limit.  
 3. Peak: Peak detector.  
 4. Only the worst data was recorded, if it complies with the limit, the other emissions deemed to comply with the limit.



**RESTRICTED BANDEDGE (HIGH CHANNEL, HORIZONTAL)**

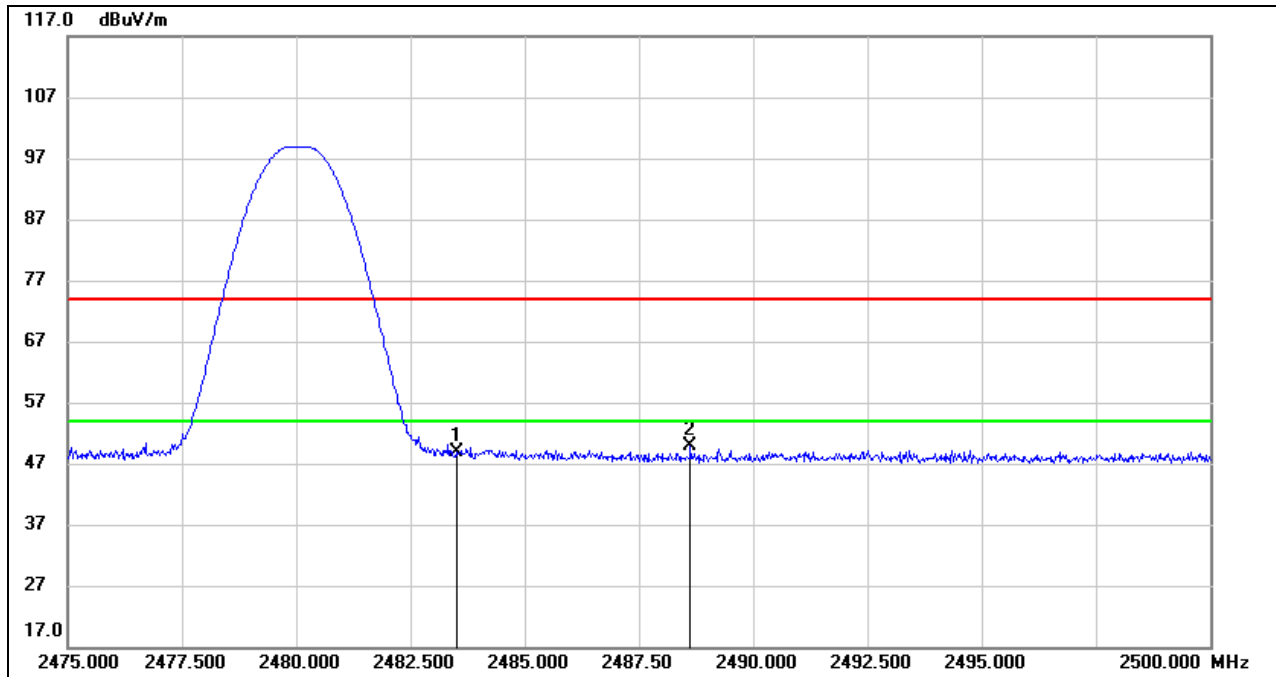

No.	Frequency (MHz)	Reading (dBuV)	Correct (dB/m)	Result (dBuV/m)	Limit (dBuV/m)	Margin (dB)	Remark
1	2483.500	15.20	33.58	48.78	74.00	-25.22	peak
2	2488.625	16.28	33.62	49.90	74.00	-24.10	peak

- Note: 1. Measurement = Reading Level + Correct Factor.  
 2. If Peak Result complies with AV limit, AV Result is deemed to comply with AV limit.  
 3. Peak: Peak detector.  
 4. Only the worst data was recorded, if it complies with the limit, the other emissions deemed to comply with the limit.

### 8.1.2. 8DPSK MODE

#### RESTRICTED BANDEDGE (LOW CHANNEL, HORIZONTAL)

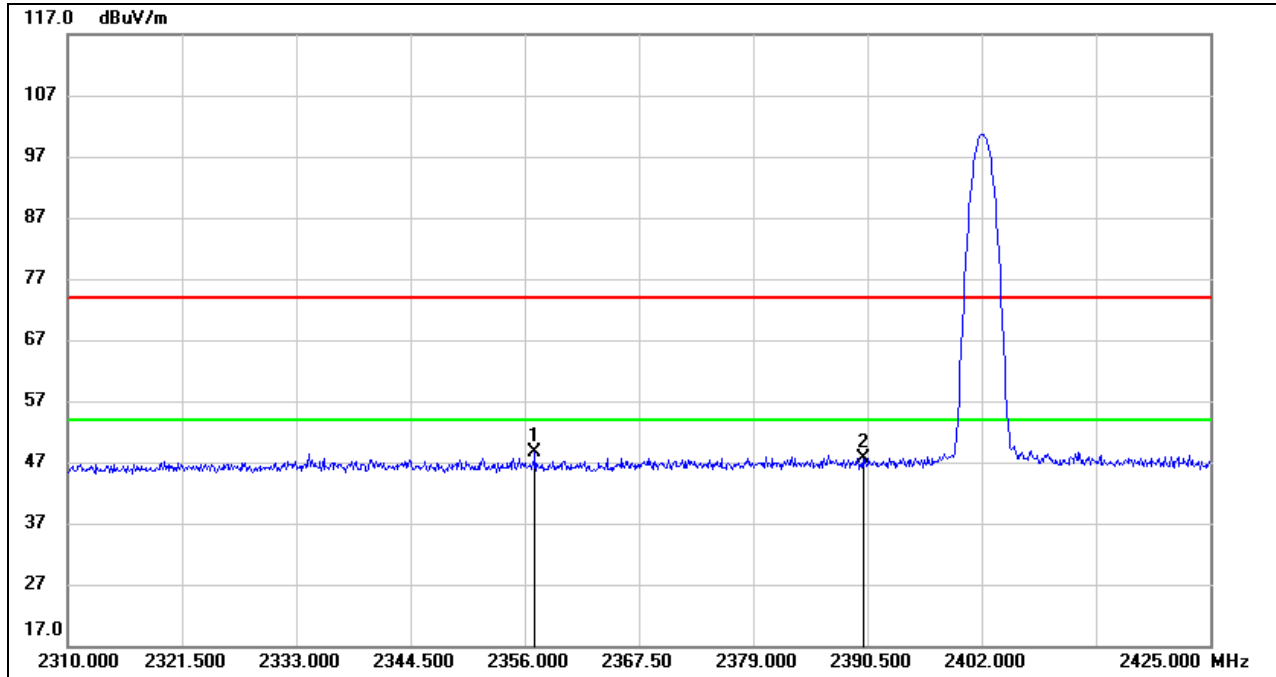

No.	Frequency (MHz)	Reading (dBuV)	Correct (dB/m)	Result (dBuV/m)	Limit (dBuV/m)	Margin (dB)	Remark
1	2357.035	15.76	32.83	48.59	74.00	-25.41	peak
2	2390.000	14.64	32.94	47.58	74.00	-26.42	peak

Note: 1. Measurement = Reading Level + Correct Factor.  
 2. If Peak Result complies with AV limit, AV Result is deemed to comply with AV limit.  
 3. Peak: Peak detector.  
 4. Only the worst data was recorded, if it complies with the limit, the other emissions deemed to comply with the limit.

**RESTRICTED BANDEDGE (HIGH CHANNEL, HORIZONTAL)**

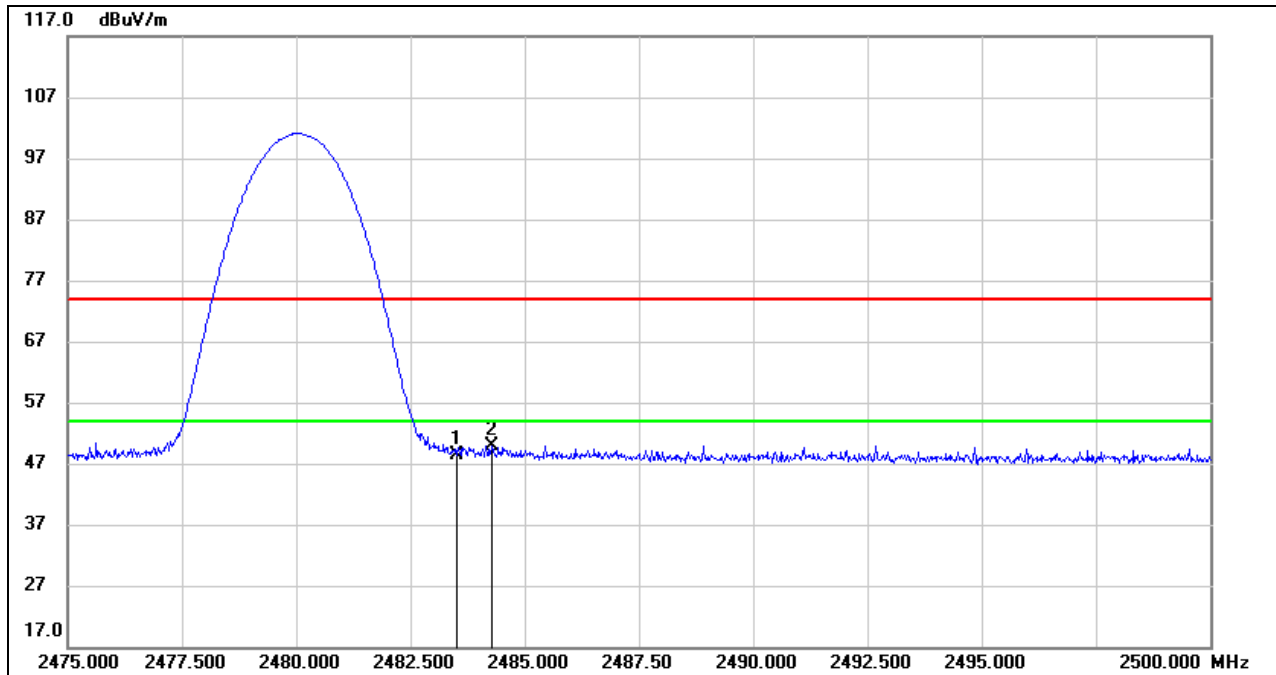

No.	Frequency (MHz)	Reading (dBuV)	Correct (dB/m)	Result (dBuV/m)	Limit (dBuV/m)	Margin (dB)	Remark
1	2483.500	14.82	33.58	48.40	74.00	-25.60	peak
2	2484.275	16.40	33.58	49.98	74.00	-24.02	peak

Note: 1. Measurement = Reading Level + Correct Factor.  
 2. If Peak Result complies with AV limit, AV Result is deemed to comply with AV limit.  
 3. Peak: Peak detector.  
 4. Only the worst data was recorded, if it complies with the limit, the other emissions deemed to comply with the limit.

Note: All the polarities had been tested, only the worst data was recorded in the report.

## 8.2. SPURIOUS EMISSIONS (1 GHz ~ 3 GHz)

### 8.2.1. 8DPSK MODE

#### HARMONICS AND SPURIOUS EMISSIONS (HIGH CHANNEL, HORIZONTAL)

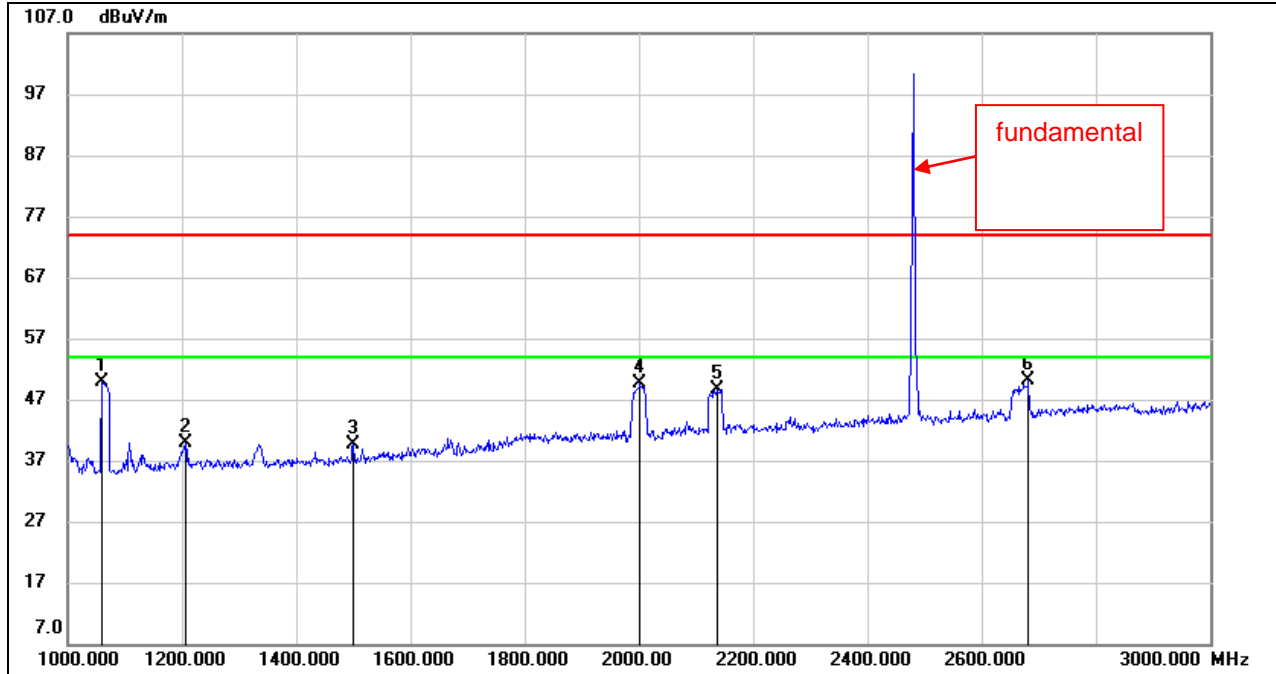

No.	Frequency (MHz)	Reading (dBuV)	Correct (dB/m)	Result (dBuV/m)	Limit (dBuV/m)	Margin (dB)	Remark
1	1060.000	47.33	2.44	49.77	74.00	-24.23	peak
2	1206.000	36.15	3.73	39.88	74.00	-34.12	peak
3	1500.000	35.27	4.27	39.54	74.00	-34.46	peak
4	2002.000	42.14	7.56	49.70	74.00	-24.30	peak
5	2136.000	40.24	8.43	48.67	74.00	-25.33	peak
6	2682.000	39.82	10.19	50.01	74.00	-23.99	peak

- Note: 1. Measurement = Reading Level + Correct Factor.  
 2. If Peak Result complies with AV limit, AV Result is deemed to comply with AV limit.  
 3. Peak: Peak detector.

**HARMONICS AND SPURIOUS EMISSIONS (HIGH CHANNEL, VERTICAL)**

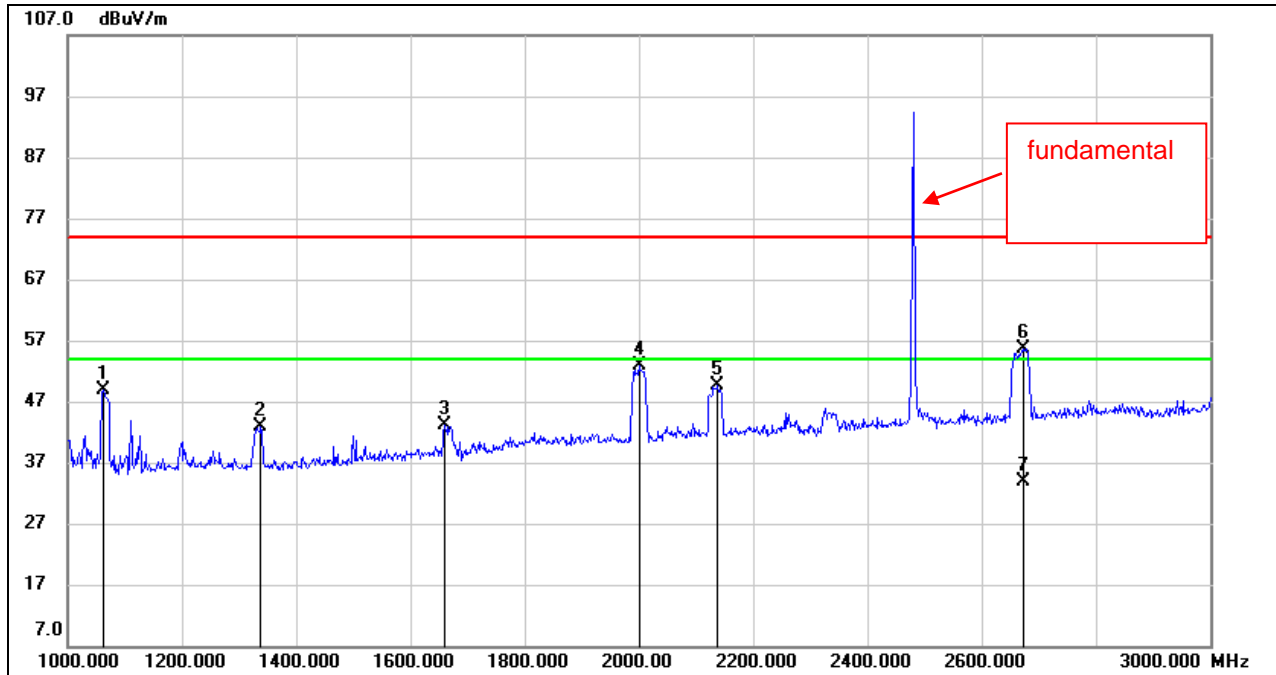

No.	Frequency (MHz)	Reading (dBuV)	Correct (dB/m)	Result (dBuV/m)	Limit (dBuV/m)	Margin (dB)	Remark
1	1062.000	46.40	2.44	48.84	74.00	-25.16	peak
2	1338.000	39.03	3.94	42.97	74.00	-31.03	peak
3	1660.000	37.81	5.41	43.22	74.00	-30.78	peak
4	2000.000	45.38	7.55	52.93	74.00	-21.07	peak
5	2138.000	41.29	8.45	49.74	74.00	-24.26	peak
6	2672.000	45.60	10.14	55.74	74.00	-18.26	peak
7	2672.000	23.81	10.14	33.95	54.00	-20.05	AVG

- Note: 1. Measurement = Reading Level + Correct Factor.  
 2. If Peak Result complies with AV limit, AV Result is deemed to comply with AV limit.  
 3. Peak: Peak detector.  
 4. AVG:  $VBW=1/Ton$ , where: Ton is the transmitting duration.  
 5. For the transmitting duration, please refer to clause 7.1.

Note: All the modes and channels have been tested, only the worst data was recorded in the report.

### 8.3. SPURIOUS EMISSIONS (3 GHz ~ 18 GHz)

#### 8.3.1. GFSK MODE

##### HARMONICS AND SPURIOUS EMISSIONS (LOW CHANNEL, HORIZONTAL)

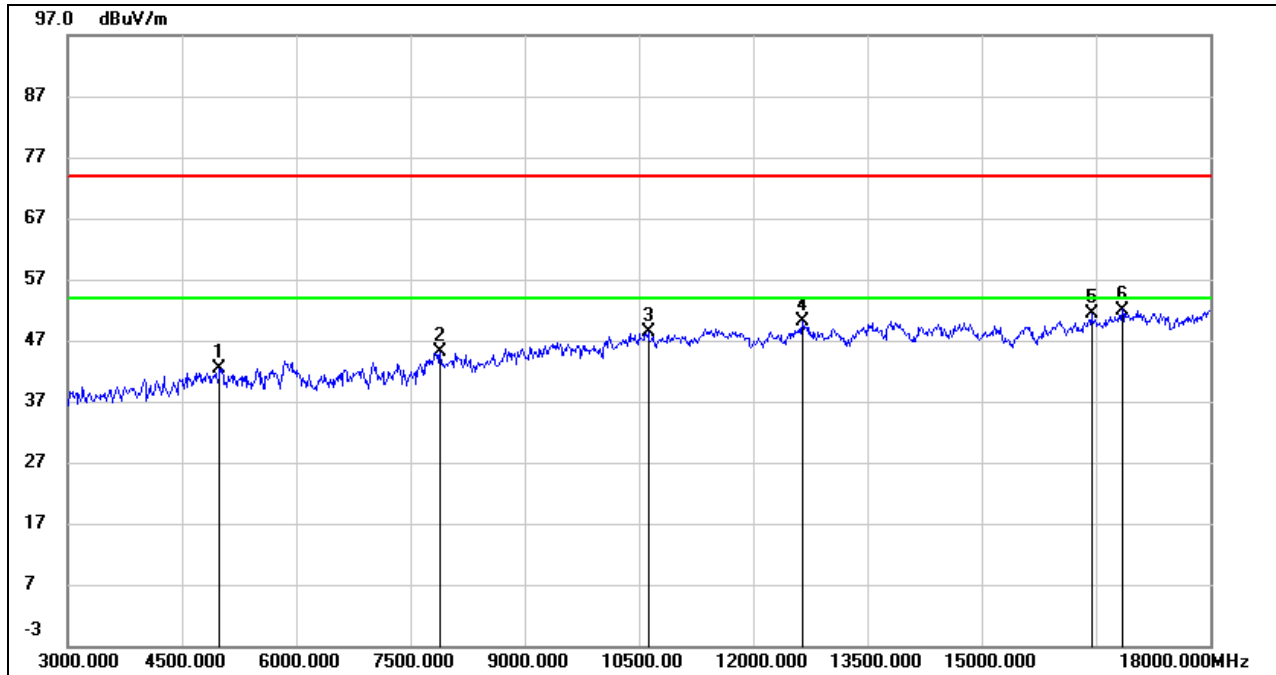

No.	Frequency (MHz)	Reading (dBuV)	Correct (dB/m)	Result (dBuV/m)	Limit (dBuV/m)	Margin (dB)	Remark
1	4995.000	40.99	1.37	42.36	74.00	-31.64	peak
2	7890.000	37.83	7.30	45.13	74.00	-28.87	peak
3	10620.000	36.41	11.88	48.29	74.00	-25.71	peak
4	12645.000	36.11	14.13	50.24	74.00	-23.76	peak
5	16440.000	32.36	18.94	51.30	74.00	-22.70	peak
6	16845.000	32.04	19.96	52.00	74.00	-22.00	peak

Note: 1. Peak Result = Reading Level + Correct Factor.

2. If Peak Result complies with AV limit, AV Result is deemed to comply with AV limit.

3. Peak: Peak detector.

4. Filter losses were only considered in the spurious frequency bands and the authorized band was not corrected for High Pass Filter losses.

5. Proper operation of the transmitter prior to adding the filter to the measurement chain.

**HARMONICS AND SPURIOUS EMISSIONS (LOW CHANNEL, VERTICAL)**

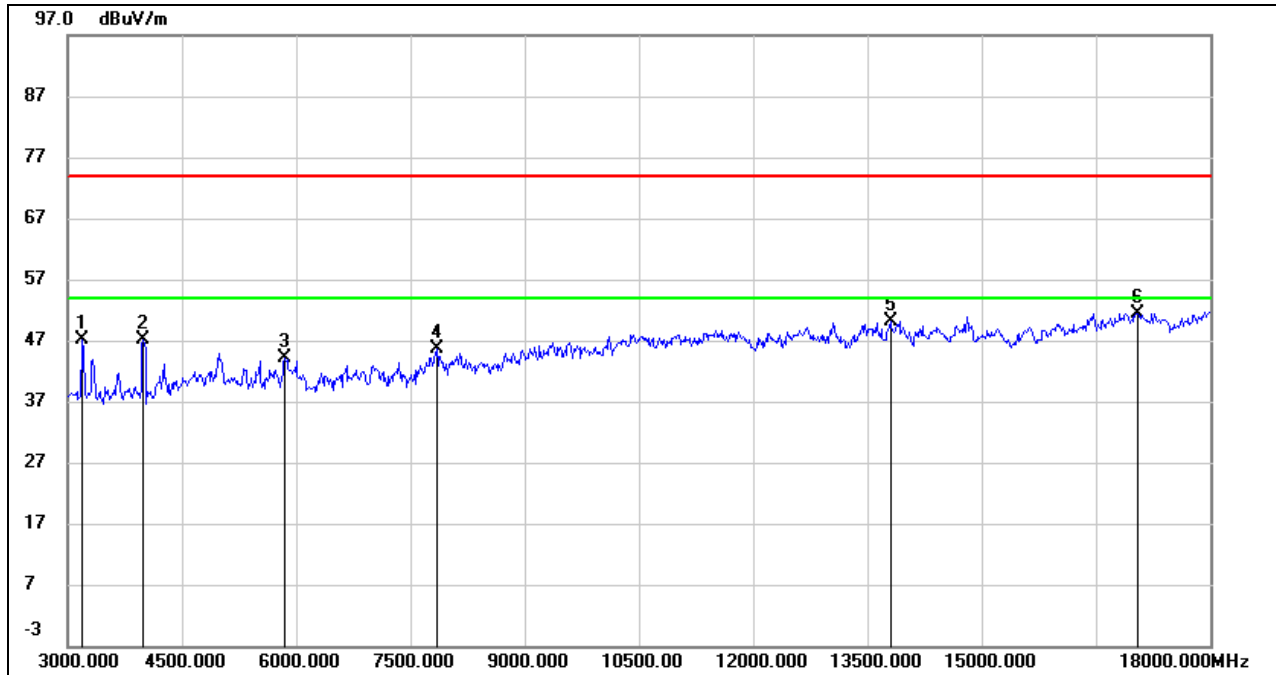

No.	Frequency (MHz)	Reading (dBuV)	Correct (dB/m)	Result (dBuV/m)	Limit (dBuV/m)	Margin (dB)	Remark
1	3195.000	51.58	-4.42	47.16	74.00	-26.84	peak
2	3990.000	49.95	-2.89	47.06	74.00	-26.94	peak
3	5850.000	40.10	4.02	44.12	74.00	-29.88	peak
4	7845.000	37.97	7.62	45.59	74.00	-28.41	peak
5	13800.000	33.07	17.10	50.17	74.00	-23.83	peak
6	17055.000	30.94	20.53	51.47	74.00	-22.53	peak

- Note: 1. Peak Result = Reading Level + Correct Factor.  
 2. If Peak Result complies with AV limit, AV Result is deemed to comply with AV limit.  
 3. Peak: Peak detector.  
 4. Filter losses were only considered in the spurious frequency bands and the authorized band was not corrected for High Pass Filter losses.  
 5. Proper operation of the transmitter prior to adding the filter to the measurement chain.



**HARMONICS AND SPURIOUS EMISSIONS (MID CHANNEL, HORIZONTAL)**

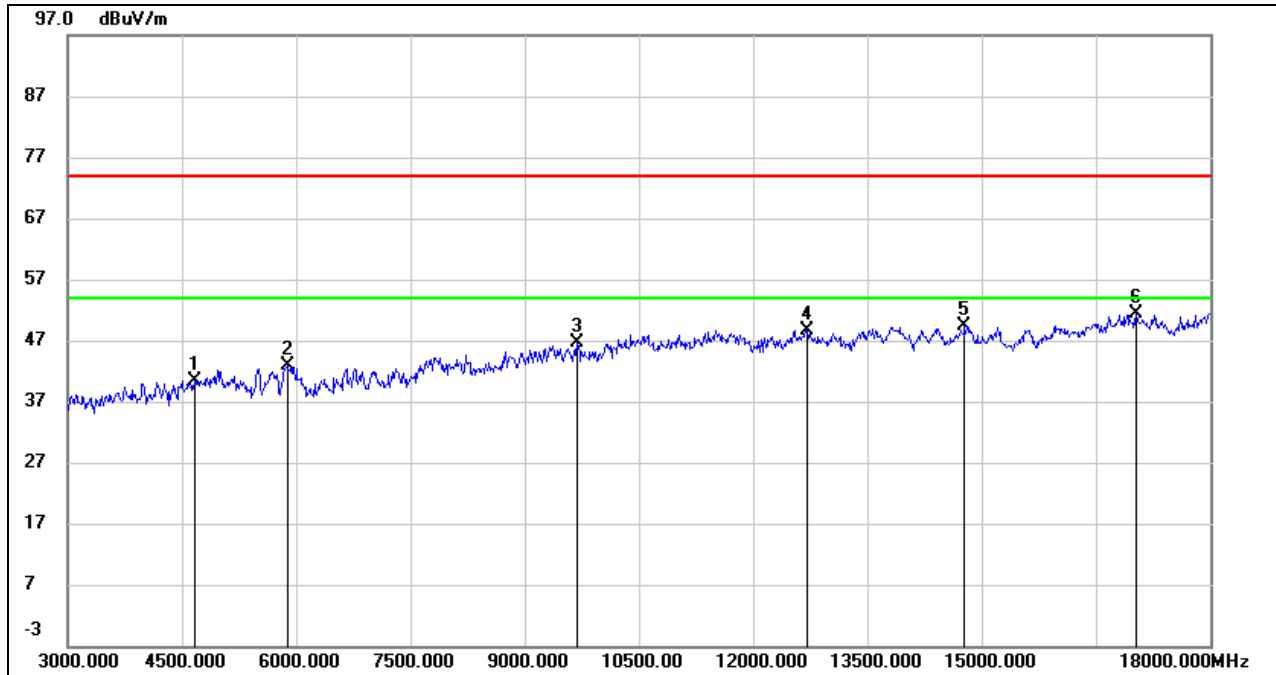

No.	Frequency (MHz)	Reading (dBuV)	Correct (dB/m)	Result (dBuV/m)	Limit (dBuV/m)	Margin (dB)	Remark
1	4665.000	40.37	-0.03	40.34	74.00	-33.66	peak
2	5880.000	38.27	4.59	42.86	74.00	-31.14	peak
3	9690.000	36.97	9.63	46.60	74.00	-27.40	peak
4	12705.000	34.39	14.35	48.74	74.00	-25.26	peak
5	14775.000	33.49	15.95	49.44	74.00	-24.56	peak
6	17025.000	30.89	20.46	51.35	74.00	-22.65	peak

- Note: 1. Peak Result = Reading Level + Correct Factor.  
 2. If Peak Result complies with AV limit, AV Result is deemed to comply with AV limit.  
 3. Peak: Peak detector.  
 4. Filter losses were only considered in the spurious frequency bands and the authorized band was not corrected for High Pass Filter losses.  
 5. Proper operation of the transmitter prior to adding the filter to the measurement chain.

**HARMONICS AND SPURIOUS EMISSIONS (MID CHANNEL, VERTICAL)**

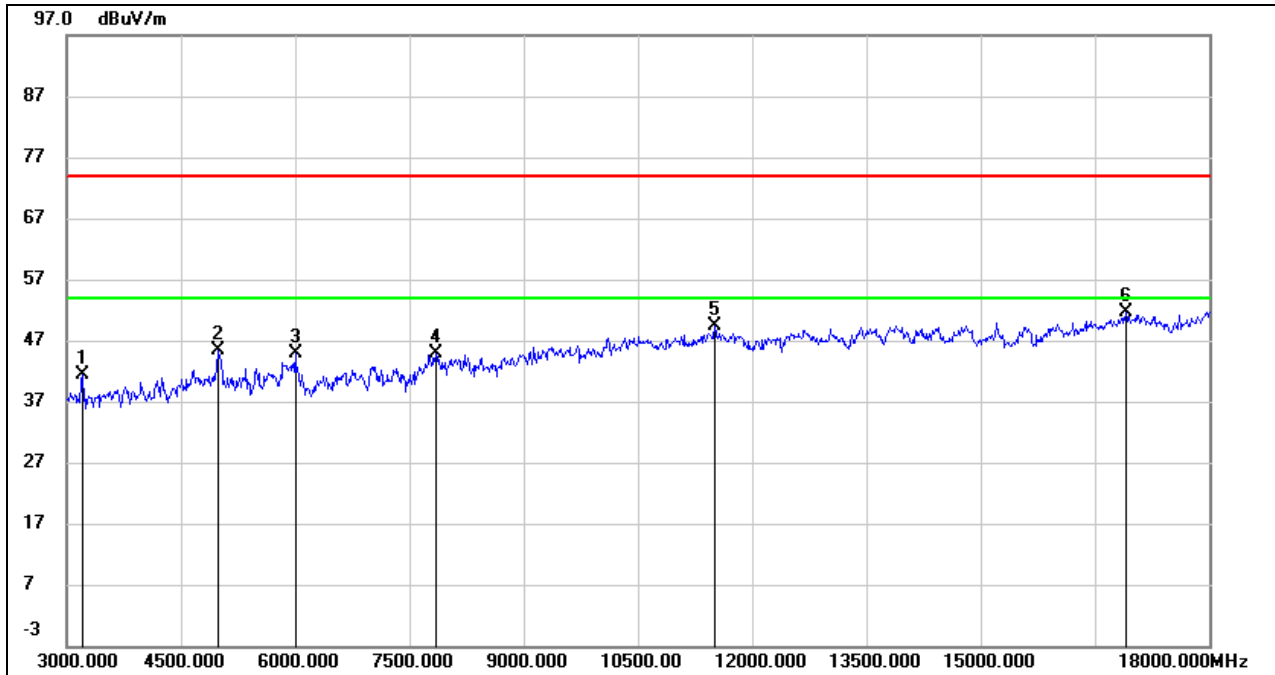

No.	Frequency (MHz)	Reading (dBuV)	Correct (dB/m)	Result (dBuV/m)	Limit (dBuV/m)	Margin (dB)	Remark
1	3210.000	45.91	-4.43	41.48	74.00	-32.52	peak
2	4980.000	44.00	1.29	45.29	74.00	-28.71	peak
3	6000.000	41.56	3.29	44.85	74.00	-29.15	peak
4	7845.000	37.17	7.62	44.79	74.00	-29.21	peak
5	11505.000	35.84	13.42	49.26	74.00	-24.74	peak
6	16905.000	31.71	19.99	51.70	74.00	-22.30	peak

- Note: 1. Peak Result = Reading Level + Correct Factor.  
 2. If Peak Result complies with AV limit, AV Result is deemed to comply with AV limit.  
 3. Peak: Peak detector.  
 4. Filter losses were only considered in the spurious frequency bands and the authorized band was not corrected for High Pass Filter losses.  
 5. Proper operation of the transmitter prior to adding the filter to the measurement chain.

**HARMONICS AND SPURIOUS EMISSIONS (HIGH CHANNEL, HORIZONTAL)**

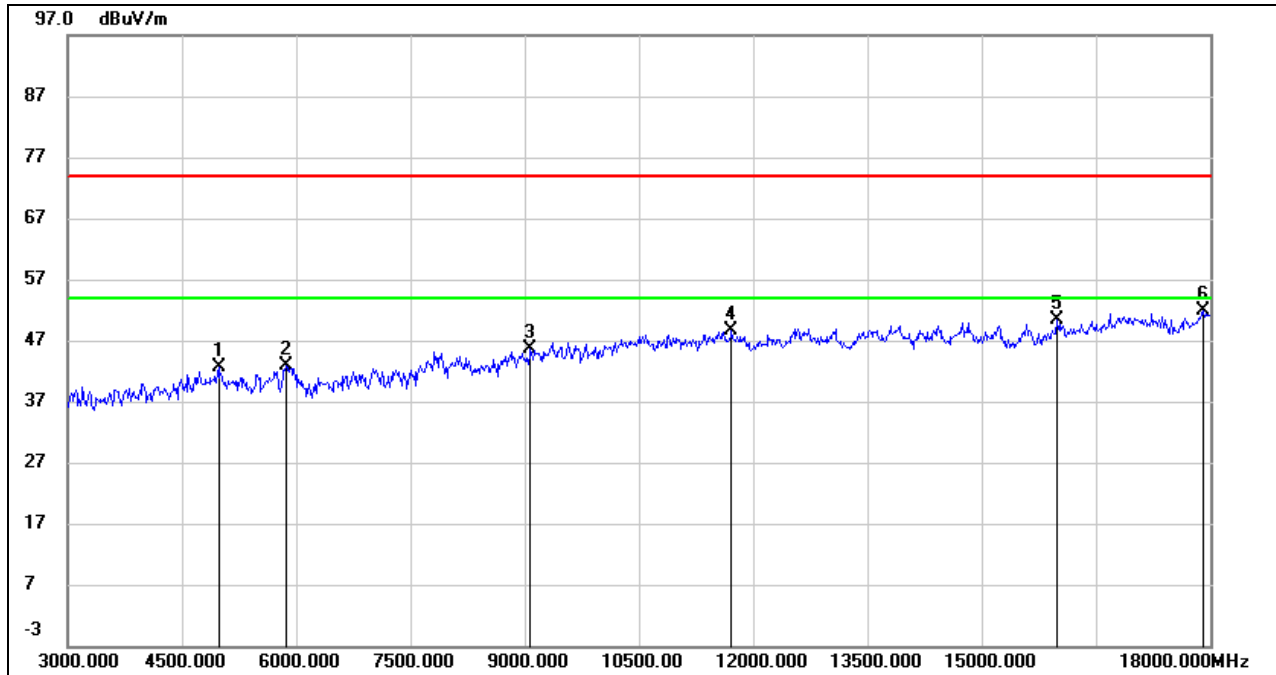

No.	Frequency (MHz)	Reading (dBuV)	Correct (dB/m)	Result (dBuV/m)	Limit (dBuV/m)	Margin (dB)	Remark
1	4980.000	41.44	1.29	42.73	74.00	-31.27	peak
2	5865.000	38.47	4.30	42.77	74.00	-31.23	peak
3	9075.000	36.33	9.28	45.61	74.00	-28.39	peak
4	11715.000	35.54	12.99	48.53	74.00	-25.47	peak
5	15990.000	32.71	17.68	50.39	74.00	-23.61	peak
6	17910.000	28.42	23.35	51.77	74.00	-22.23	peak

- Note: 1. Peak Result = Reading Level + Correct Factor.  
 2. If Peak Result complies with AV limit, AV Result is deemed to comply with AV limit.  
 3. Peak: Peak detector.  
 4. Filter losses were only considered in the spurious frequency bands and the authorized band was not corrected for High Pass Filter losses.  
 5. Proper operation of the transmitter prior to adding the filter to the measurement chain.



**HARMONICS AND SPURIOUS EMISSIONS (HIGH CHANNEL, VERTICAL)**

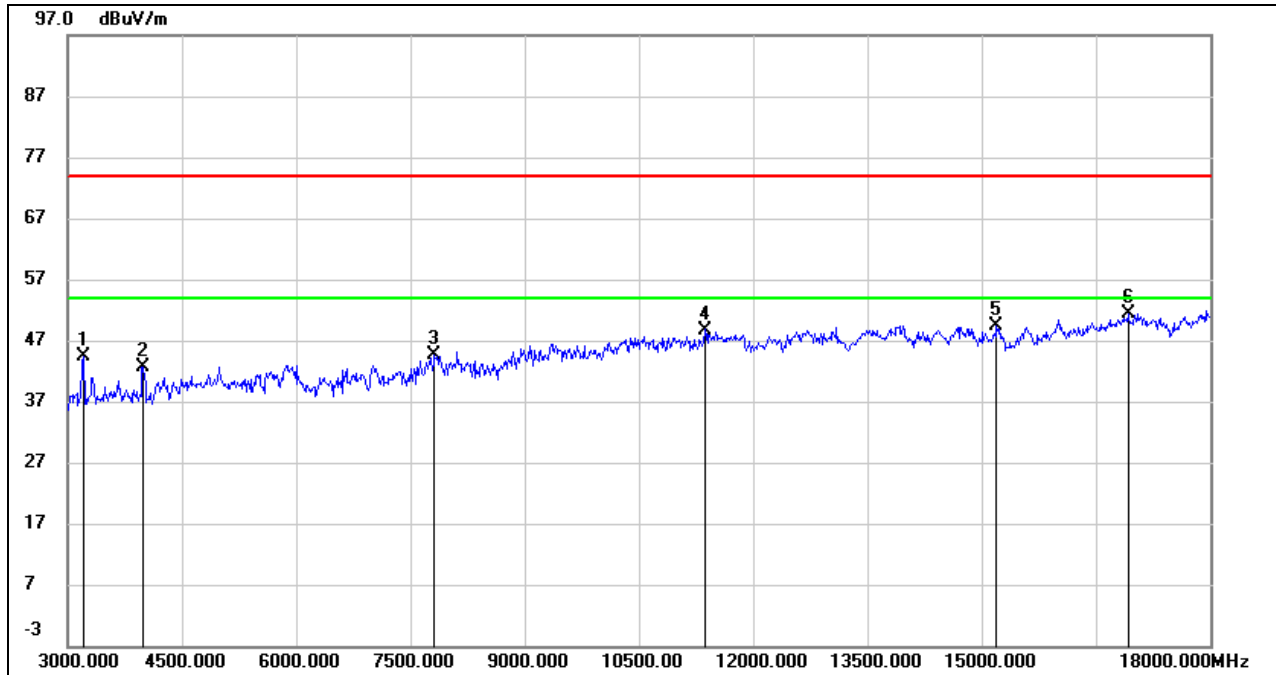

No.	Frequency (MHz)	Reading (dBuV)	Correct (dB/m)	Result (dBuV/m)	Limit (dBuV/m)	Margin (dB)	Remark
1	3210.000	48.76	-4.43	44.33	74.00	-29.67	peak
2	3990.000	45.58	-2.89	42.69	74.00	-31.31	peak
3	7815.000	36.68	7.83	44.51	74.00	-29.49	peak
4	11370.000	36.21	12.54	48.75	74.00	-25.25	peak
5	15195.000	33.22	16.09	49.31	74.00	-24.69	peak
6	16920.000	31.39	20.06	51.45	74.00	-22.55	peak

- Note: 1. Peak Result = Reading Level + Correct Factor.  
 2. If Peak Result complies with AV limit, AV Result is deemed to comply with AV limit.  
 3. Peak: Peak detector.  
 4. Filter losses were only considered in the spurious frequency bands and the authorized band was not corrected for High Pass Filter losses.  
 5. Proper operation of the transmitter prior to adding the filter to the measurement chain.

### 8.3.2. 8DPSK MODE

#### HARMONICS AND SPURIOUS EMISSIONS (LOW CHANNEL, HORIZONTAL)

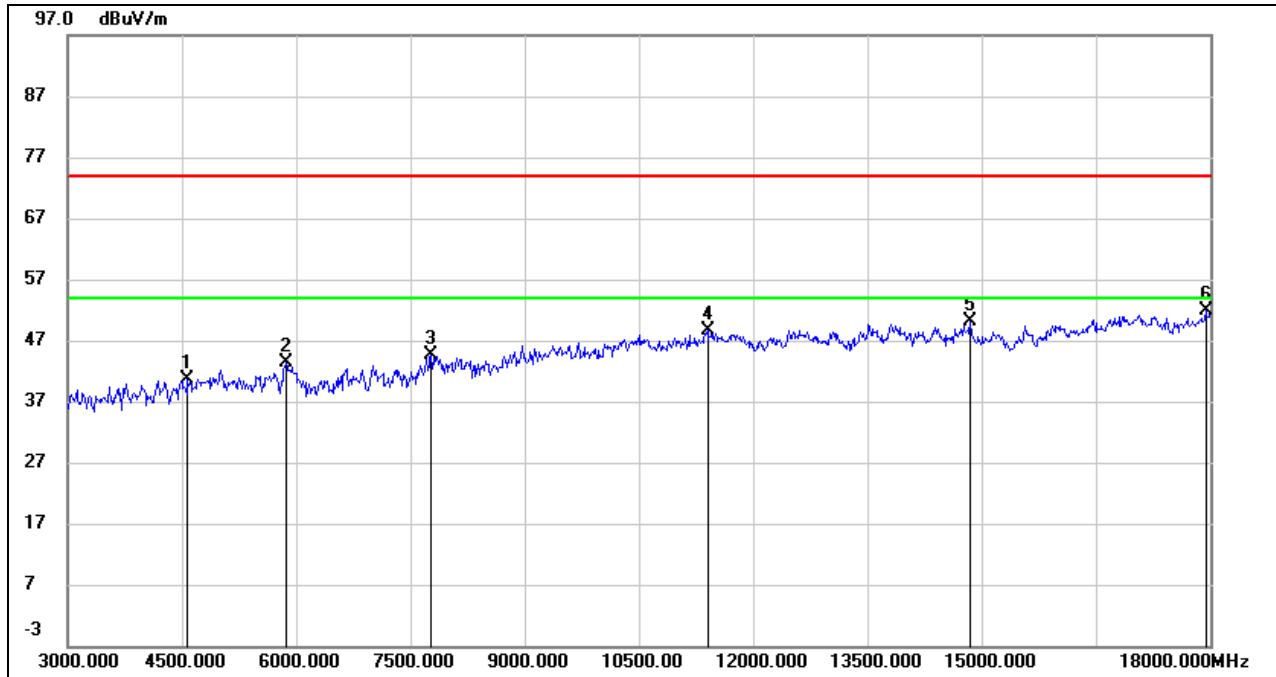

No.	Frequency (MHz)	Reading (dBuV)	Correct (dB/m)	Result (dBuV/m)	Limit (dBuV/m)	Margin (dB)	Remark
1	4575.000	41.05	-0.48	40.57	74.00	-33.43	peak
2	5865.000	39.10	4.30	43.40	74.00	-30.60	peak
3	7770.000	37.16	7.50	44.66	74.00	-29.34	peak
4	11400.000	36.12	12.62	48.74	74.00	-25.26	peak
5	14850.000	34.07	15.97	50.04	74.00	-23.96	peak
6	17940.000	28.54	23.39	51.93	74.00	-22.07	peak

- Note: 1. Peak Result = Reading Level + Correct Factor.  
 2. If Peak Result complies with AV limit, AV Result is deemed to comply with AV limit.  
 3. Peak: Peak detector.  
 4. Filter losses were only considered in the spurious frequency bands and the authorized band was not corrected for High Pass Filter losses.  
 5. Proper operation of the transmitter prior to adding the filter to the measurement chain.



**HARMONICS AND SPURIOUS EMISSIONS (LOW CHANNEL, VERTICAL)**

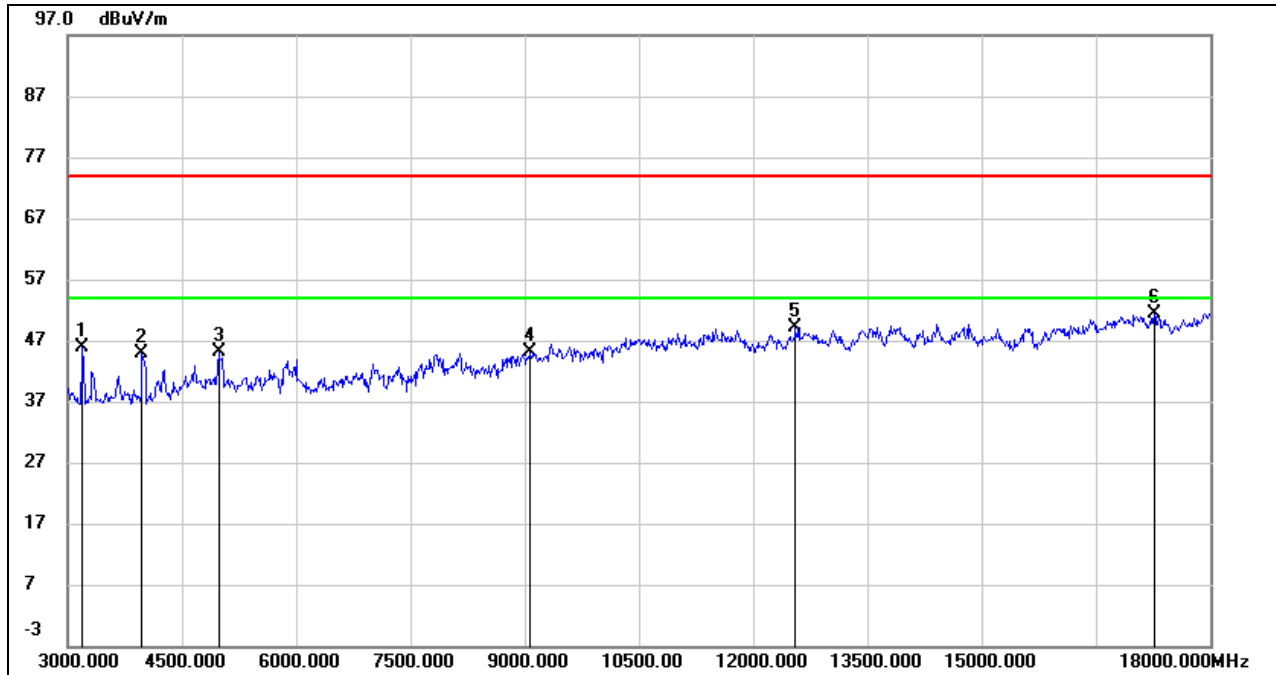

No.	Frequency (MHz)	Reading (dBuV)	Correct (dB/m)	Result (dBuV/m)	Limit (dBuV/m)	Margin (dB)	Remark
1	3195.000	50.31	-4.42	45.89	74.00	-28.11	peak
2	3975.000	47.70	-2.90	44.80	74.00	-29.20	peak
3	4980.000	43.95	1.29	45.24	74.00	-28.76	peak
4	9075.000	35.82	9.28	45.10	74.00	-28.90	peak
5	12555.000	34.89	14.24	49.13	74.00	-24.87	peak
6	17265.000	30.01	21.46	51.47	74.00	-22.53	peak

- Note: 1. Peak Result = Reading Level + Correct Factor.  
 2. If Peak Result complies with AV limit, AV Result is deemed to comply with AV limit.  
 3. Peak: Peak detector.  
 4. Filter losses were only considered in the spurious frequency bands and the authorized band was not corrected for High Pass Filter losses.  
 5. Proper operation of the transmitter prior to adding the filter to the measurement chain.

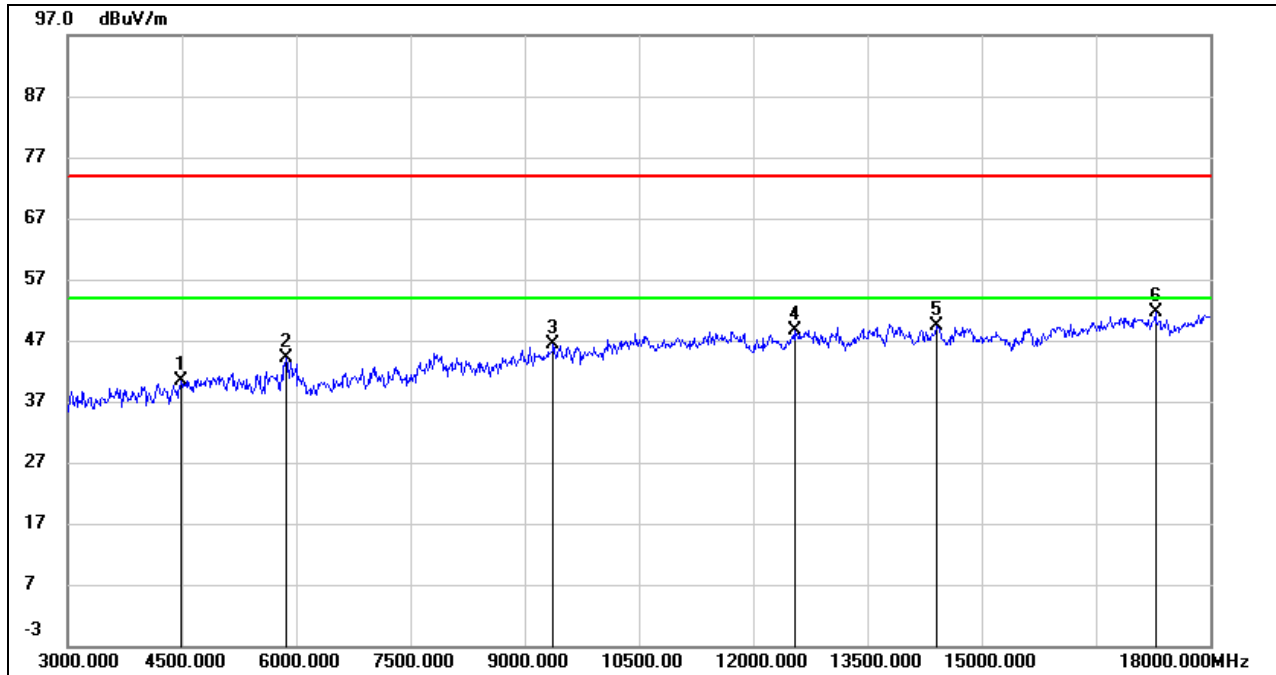
**HARMONICS AND SPURIOUS EMISSIONS (MID CHANNEL, HORIZONTAL)**

No.	Frequency (MHz)	Reading (dBuV)	Correct (dB/m)	Result (dBuV/m)	Limit (dBuV/m)	Margin (dB)	Remark
1	4485.000	41.24	-0.83	40.41	74.00	-33.59	peak
2	5865.000	39.71	4.30	44.01	74.00	-29.99	peak
3	9375.000	36.90	9.45	46.35	74.00	-27.65	peak
4	12540.000	34.26	14.33	48.59	74.00	-25.41	peak
5	14415.000	33.14	16.35	49.49	74.00	-24.51	peak
6	17280.000	30.04	21.59	51.63	74.00	-22.37	peak

- Note: 1. Peak Result = Reading Level + Correct Factor.  
 2. If Peak Result complies with AV limit, AV Result is deemed to comply with AV limit.  
 3. Peak: Peak detector.  
 4. Filter losses were only considered in the spurious frequency bands and the authorized band was not corrected for High Pass Filter losses.  
 5. Proper operation of the transmitter prior to adding the filter to the measurement chain.

**HARMONICS AND SPURIOUS EMISSIONS (MID CHANNEL, VERTICAL)**

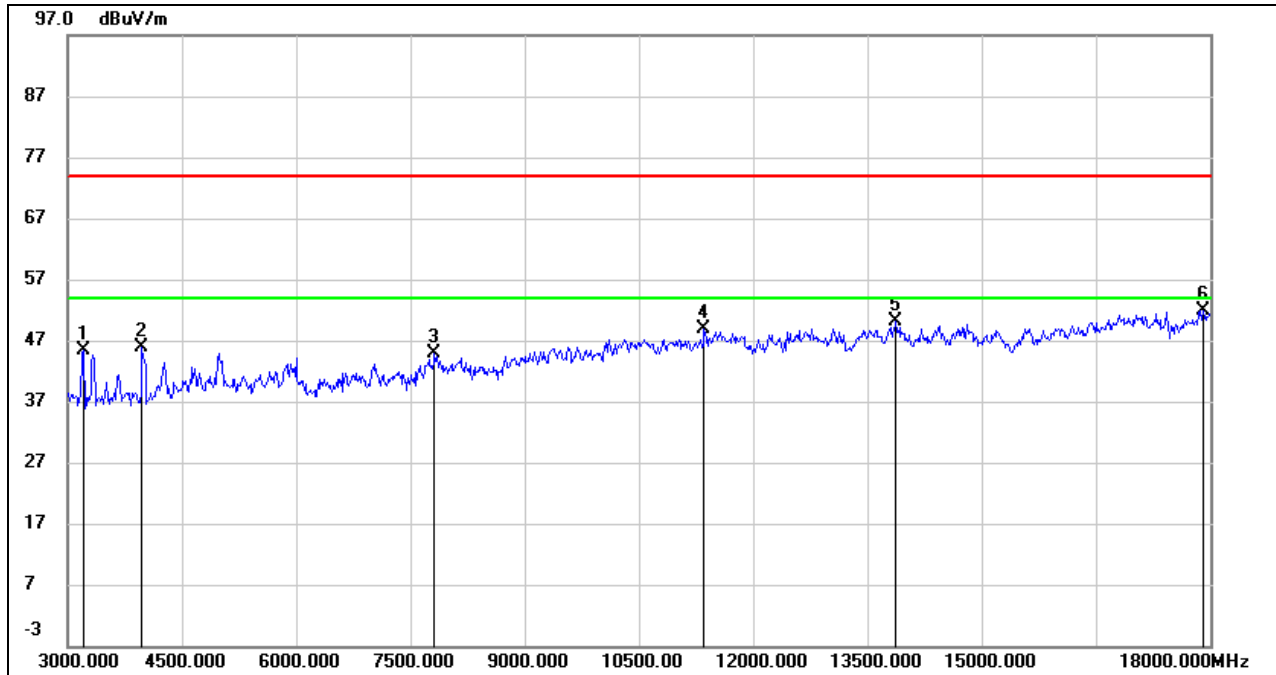

No.	Frequency (MHz)	Reading (dBuV)	Correct (dB/m)	Result (dBuV/m)	Limit (dBuV/m)	Margin (dB)	Remark
1	3210.000	49.81	-4.43	45.38	74.00	-28.62	peak
2	3975.000	48.79	-2.90	45.89	74.00	-28.11	peak
3	7815.000	37.11	7.83	44.94	74.00	-29.06	peak
4	11355.000	36.33	12.48	48.81	74.00	-25.19	peak
5	13875.000	33.76	16.44	50.20	74.00	-23.80	peak
6	17910.000	28.56	23.35	51.91	74.00	-22.09	peak

- Note: 1. Peak Result = Reading Level + Correct Factor.  
 2. If Peak Result complies with AV limit, AV Result is deemed to comply with AV limit.  
 3. Peak: Peak detector.  
 4. Filter losses were only considered in the spurious frequency bands and the authorized band was not corrected for High Pass Filter losses.  
 5. Proper operation of the transmitter prior to adding the filter to the measurement chain.





**HARMONICS AND SPURIOUS EMISSIONS (HIGH CHANNEL, HORIZONTAL)**

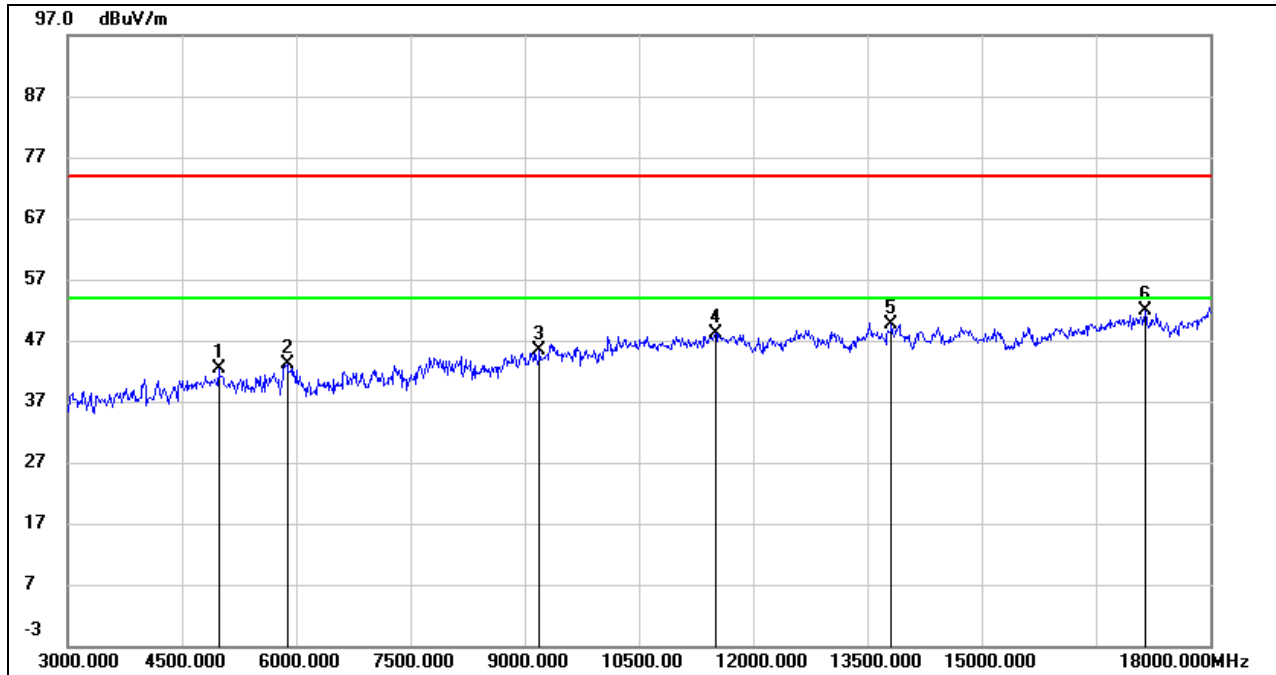

No.	Frequency (MHz)	Reading (dBuV)	Correct (dB/m)	Result (dBuV/m)	Limit (dBuV/m)	Margin (dB)	Remark
1	4980.000	41.01	1.29	42.30	74.00	-31.70	peak
2	5880.000	38.64	4.59	43.23	74.00	-30.77	peak
3	9195.000	36.66	8.70	45.36	74.00	-28.64	peak
4	11505.000	34.82	13.42	48.24	74.00	-25.76	peak
5	13815.000	32.76	16.97	49.73	74.00	-24.27	peak
6	17145.000	31.21	20.77	51.98	74.00	-22.02	peak

- Note: 1. Peak Result = Reading Level + Correct Factor.  
 2. If Peak Result complies with AV limit, AV Result is deemed to comply with AV limit.  
 3. Peak: Peak detector.  
 4. Filter losses were only considered in the spurious frequency bands and the authorized band was not corrected for High Pass Filter losses.  
 5. Proper operation of the transmitter prior to adding the filter to the measurement chain.



**HARMONICS AND SPURIOUS EMISSIONS (HIGH CHANNEL, VERTICAL)**

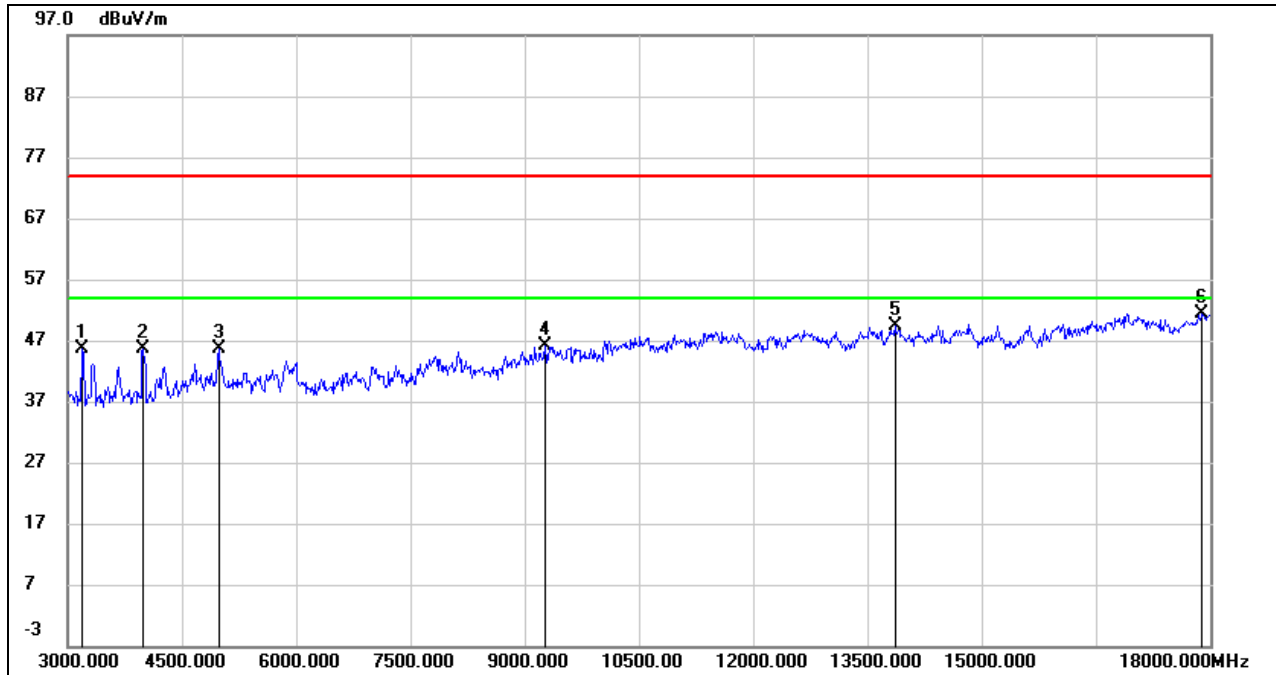

No.	Frequency (MHz)	Reading (dBuV)	Correct (dB/m)	Result (dBuV/m)	Limit (dBuV/m)	Margin (dB)	Remark
1	3195.000	50.12	-4.42	45.70	74.00	-28.30	peak
2	3990.000	48.45	-2.89	45.56	74.00	-28.44	peak
3	4980.000	44.39	1.29	45.68	74.00	-28.32	peak
4	9270.000	37.20	8.89	46.09	74.00	-27.91	peak
5	13860.000	32.83	16.56	49.39	74.00	-24.61	peak
6	17895.000	28.07	23.34	51.41	74.00	-22.59	peak

- Note: 1. Peak Result = Reading Level + Correct Factor.  
 2. If Peak Result complies with AV limit, AV Result is deemed to comply with AV limit.  
 3. Peak: Peak detector.  
 4. Filter losses were only considered in the spurious frequency bands and the authorized band was not corrected for High Pass Filter losses.  
 5. Proper operation of the transmitter prior to adding the filter to the measurement chain.

## 8.4. SPURIOUS EMISSIONS (18 GHz ~ 26 GHz)

### 8.4.1. 8DPSK MODE

#### SPURIOUS EMISSIONS (HIGH CHANNEL, WORST-CASE CONFIGURATION, HORIZONTAL)

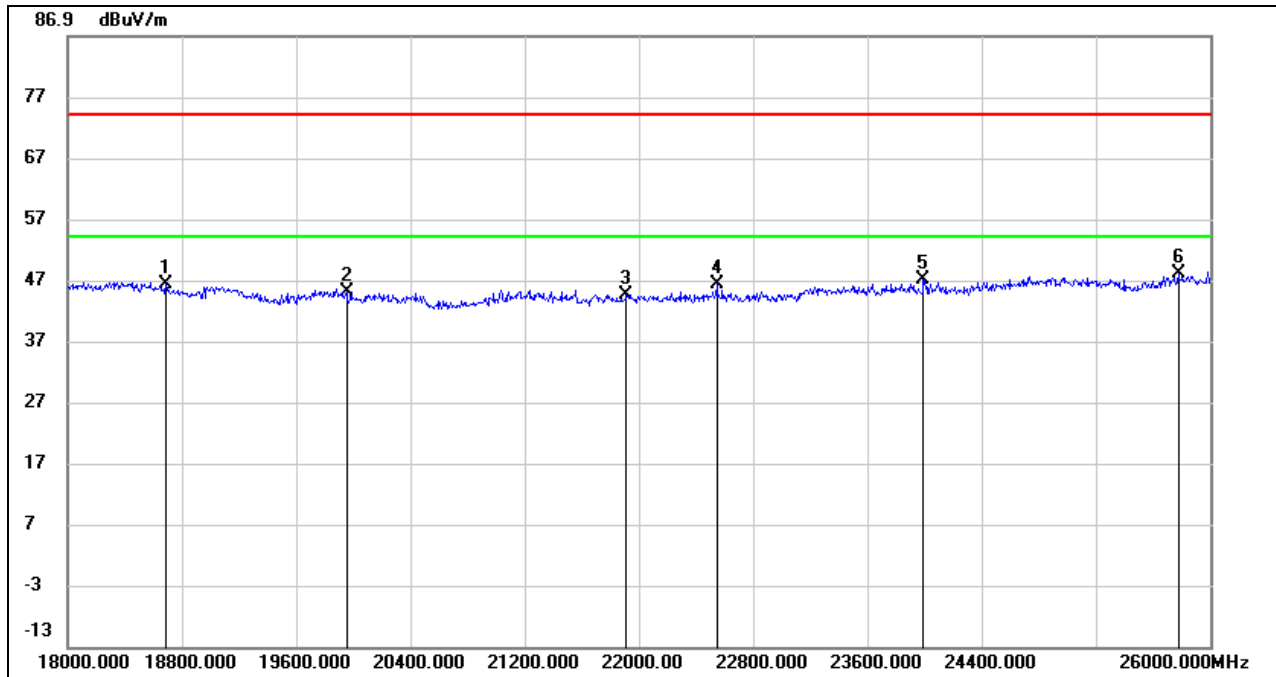

No.	Frequency (MHz)	Reading (dBuV)	Correct (dB/m)	Result (dBuV/m)	Limit (dBuV/m)	Margin (dB)	Remark
1	18688.000	51.12	-4.72	46.40	74.00	-27.60	peak
2	19952.000	49.46	-4.36	45.10	74.00	-28.90	peak
3	21912.000	50.71	-6.07	44.64	74.00	-29.36	peak
4	22544.000	51.98	-5.79	46.19	74.00	-27.81	peak
5	23992.000	51.16	-4.03	47.13	74.00	-26.87	peak
6	25776.000	49.42	-1.45	47.97	74.00	-26.03	peak

Note: 1. Peak Result = Reading Level + Correct Factor.

2. If Peak Result complies with AV limit, AV Result is deemed to comply with AV limit.

3. Peak: Peak detector.

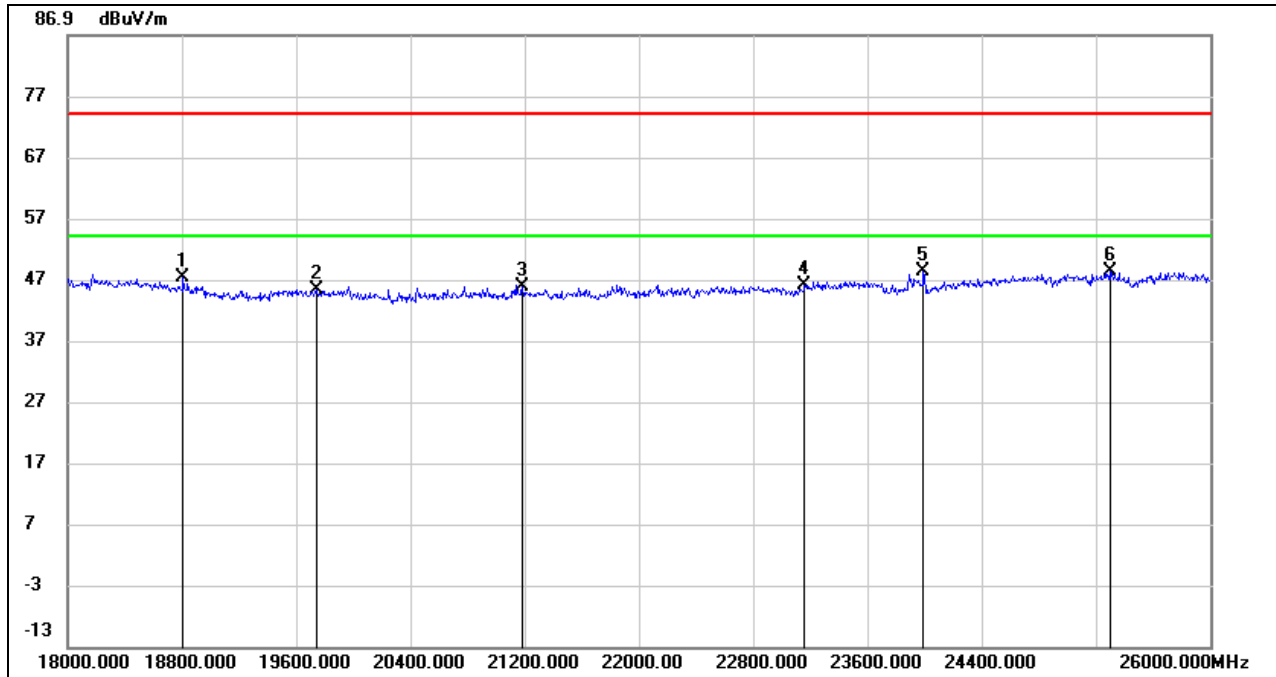
**SPURIOUS EMISSIONS (HIGH CHANNEL, WORST-CASE CONFIGURATION, VERTICAL)**

No.	Frequency (MHz)	Reading (dBuV)	Correct (dB/m)	Result (dBuV/m)	Limit (dBuV/m)	Margin (dB)	Remark
1	18808.000	52.05	-4.85	47.20	74.00	-26.80	peak
2	19744.000	49.64	-4.35	45.29	74.00	-28.71	peak
3	21184.000	51.17	-5.45	45.72	74.00	-28.28	peak
4	23160.000	51.46	-5.38	46.08	74.00	-27.92	peak
5	23992.000	52.22	-4.03	48.19	74.00	-25.81	peak
6	25296.000	49.70	-1.30	48.40	74.00	-25.60	peak

Note: 1. Peak Result = Reading Level + Correct Factor.

2. If Peak Result complies with AV limit, AV Result is deemed to comply with AV limit.

3. Peak: Peak detector.

Note: All the modes have been tested, only the worst data was recorded in the report.

## 8.5. SPURIOUS EMISSIONS (30 MHz ~ 1 GHz)

### 8.5.1. 8DPSK MODE

#### SPURIOUS EMISSIONS (HIGH CHANNEL, WORST-CASE CONFIGURATION, HORIZONTAL)

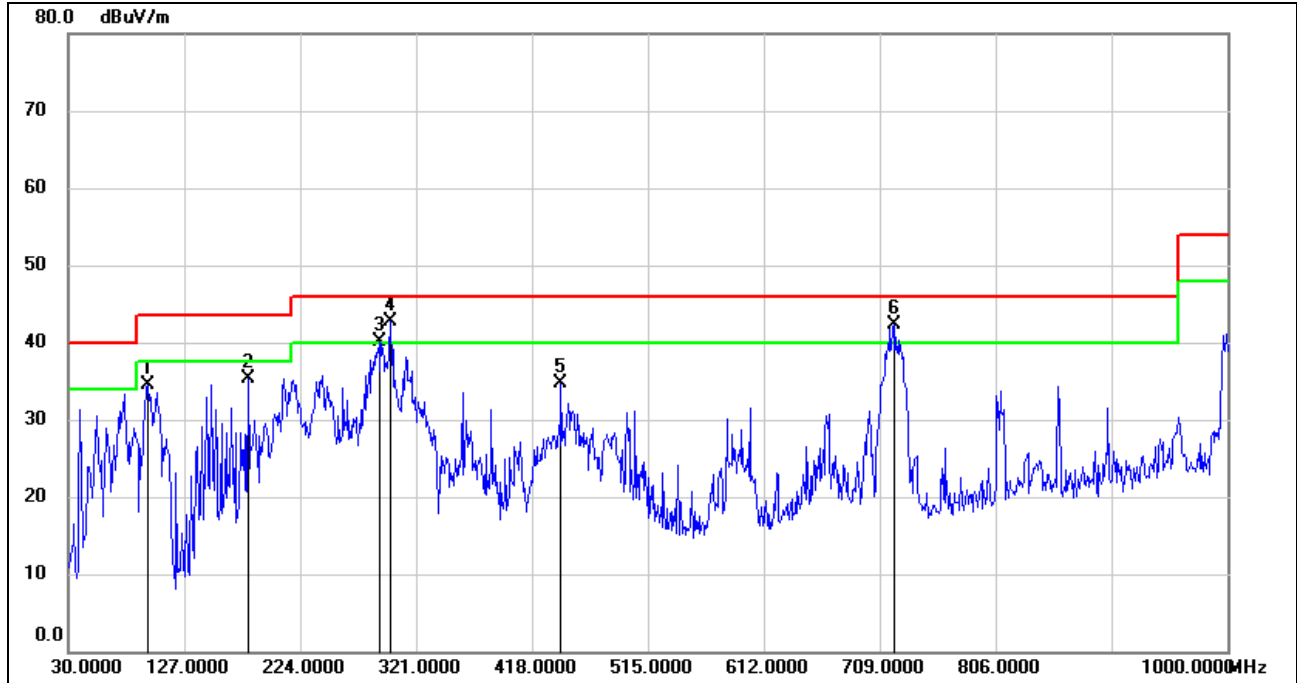

No.	Frequency (MHz)	Reading (dBuV)	Correct (dB/m)	Result (dBuV/m)	Limit (dBuV/m)	Margin (dB)	Remark
1	96.9300	56.01	-21.43	34.58	43.50	-8.92	QP
2	180.3500	51.87	-16.53	35.34	43.50	-8.16	QP
3	289.9600	54.93	-14.78	40.15	46.00	-5.85	QP
4	299.6600	57.12	-14.39	42.73	46.00	-3.27	QP
5	442.2500	46.73	-11.96	34.77	46.00	-11.23	QP
6	721.6100	48.86	-6.47	42.39	46.00	-3.61	QP

- Note: 1. Result Level = Read Level + Antenna Factor + Cable loss.  
 2. If Peak Result complies with QP limit, QP Result is deemed to comply with QP limit.  
 3. Test setup: RBW: 120 kHz, VBW: 300 kHz, Sweep time: auto.



**SPURIOUS EMISSIONS (HIGH CHANNEL, WORST-CASE CONFIGURATION, VERTICAL)**

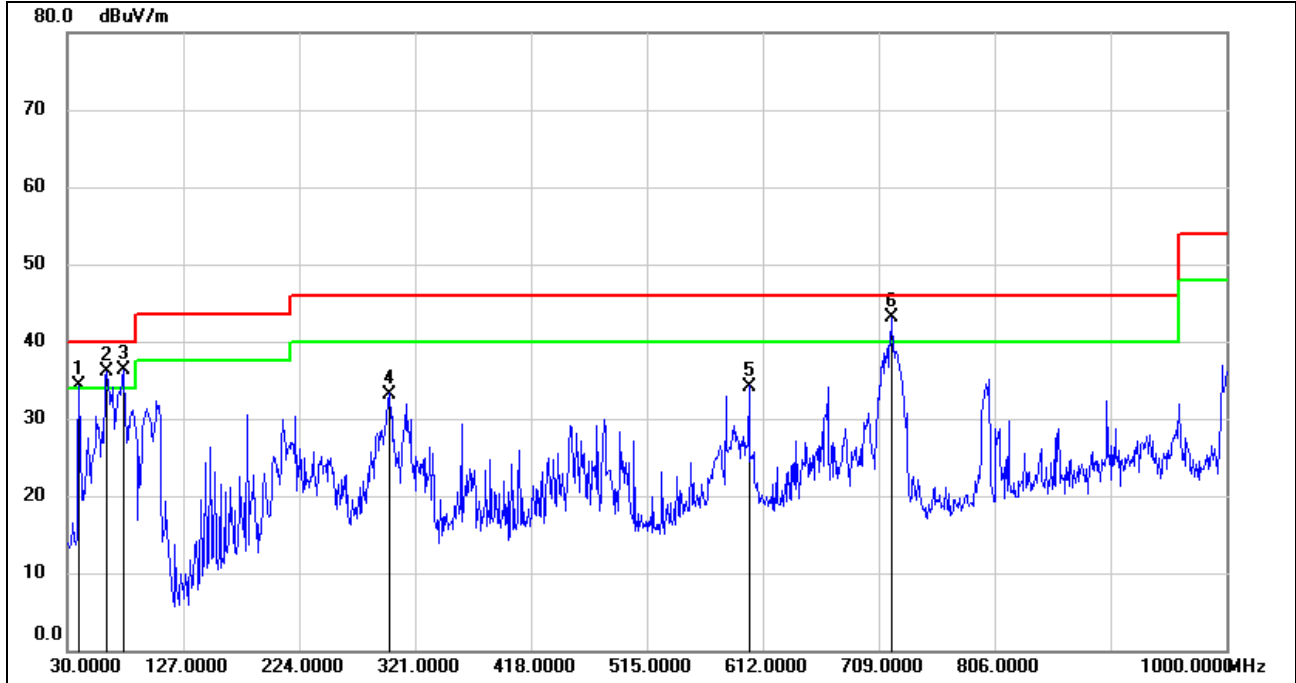

No.	Frequency (MHz)	Reading (dBuV)	Correct (dB/m)	Result (dBuV/m)	Limit (dBuV/m)	Margin (dB)	Remark
1	39.7000	52.21	-17.87	34.34	40.00	-5.66	QP
2	62.9800	55.72	-19.58	36.14	40.00	-3.86	QP
3	76.5600	56.68	-20.38	36.30	40.00	-3.70	QP
4	299.6600	47.59	-14.39	33.20	46.00	-12.80	QP
5	600.3600	43.00	-8.80	34.20	46.00	-11.80	QP
6	719.6700	49.56	-6.45	43.11	46.00	-2.89	QP

- Note: 1. Result Level = Read Level + Antenna Factor + Cable loss.  
 2. If Peak Result complies with QP limit, QP Result is deemed to comply with QP limit.  
 3. Test setup: RBW: 120 kHz, VBW: 300 kHz, Sweep time: auto

Note: All the modes have been tested, only the worst data was recorded in the report.

## 8.6. SPURIOUS EMISSIONS BELOW 30 MHz

### 8.6.1. 8DPSK MODE

**(HIGH CHANNEL, LOOP ANTENNA FACE ON TO THE EUT, WORST-CASE CONFIGURATION)**

9 kHz~ 150 kHz

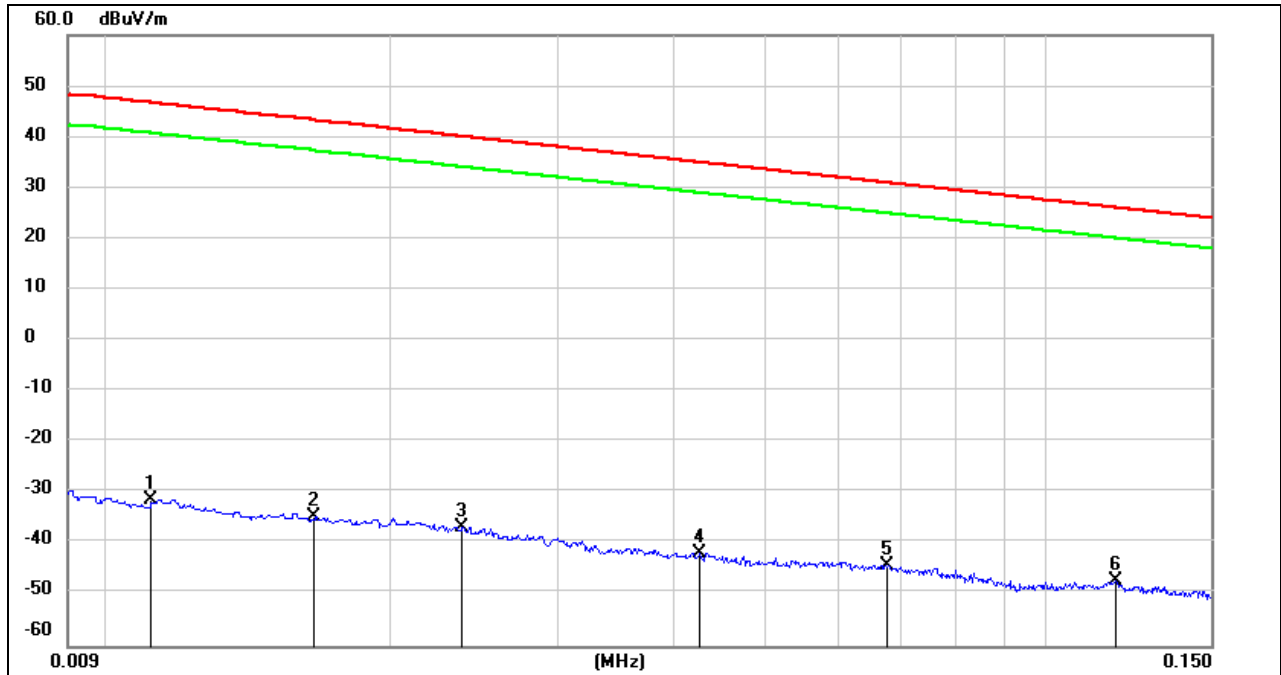

No.	Frequency (MHz)	Reading (dBuV)	Correct (dB/m)	FCC Result (dBuV/m)	FCC Limit (dBuV/m)	ISED Result (dBuA/m)	ISED Limit (dBuA/m)	Margin (dB)	Remark
1	0.0111	69.95	-101.39	-31.44	46.69	-82.94	-4.81	-78.13	peak
2	0.0165	66.84	-101.37	-34.53	43.25	-86.03	-8.25	-77.78	peak
3	0.0238	64.56	-101.36	-36.8	40.07	-88.30	-11.43	-76.87	peak
4	0.0427	59.64	-101.45	-41.81	34.99	-93.31	-16.51	-76.80	peak
5	0.0675	57.35	-101.56	-44.21	31.02	-95.71	-20.48	-75.23	peak
6	0.1188	54.56	-101.74	-47.18	26.11	-98.68	-25.39	-73.29	peak

Note: 1. Measurement = Reading Level + Correct Factor (dBuA/m= dBuV/m- 20Log10[120π] = dBuV/m- 51.5).

2. If Peak Result complies with AV and QP limit, AV and QP Result are deemed to comply with AV limit.

3. All 3 polarizations(Horizontal, Face-on and Face-off) of the loop antenna had been tested, but only the worst data recorded in the report.

**150 kHz ~ 490 kHz**

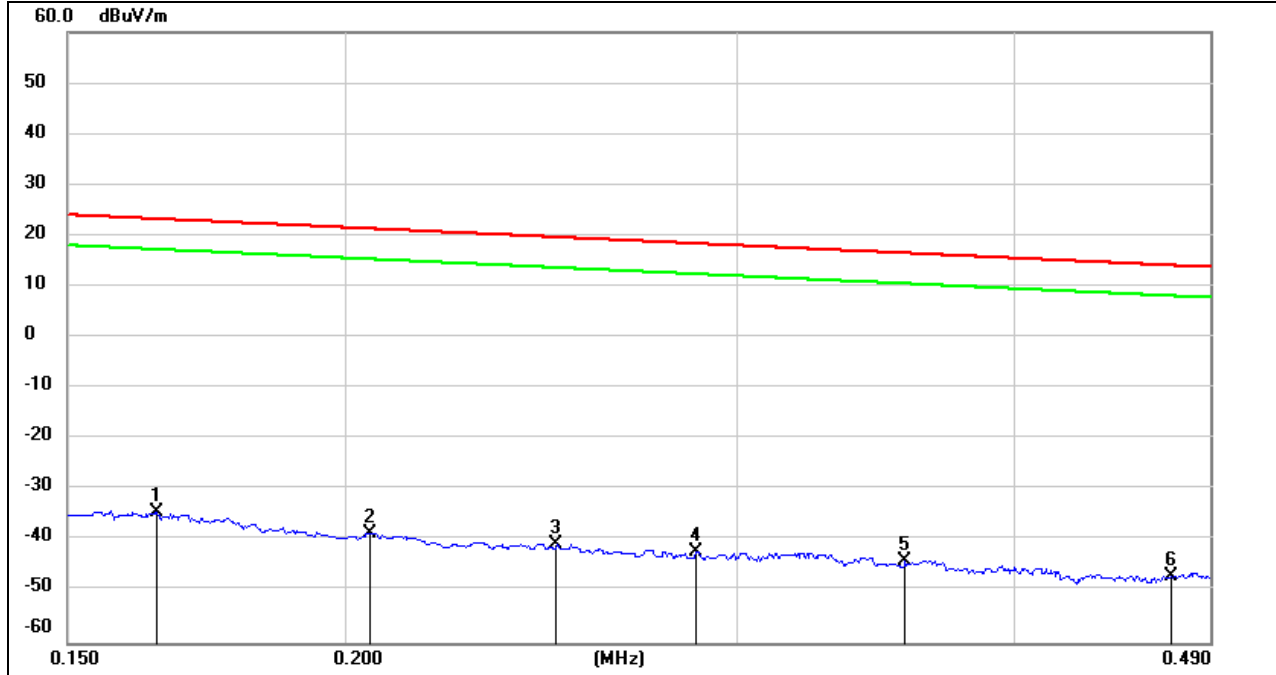

No.	Frequency (MHz)	Reading (dBuV)	Correct (dB/m)	FCC Result (dBuV/m)	FCC Limit (dBuV/m)	ISED Result (dBuA/m)	ISED Limit (dBuA/m)	Margin (dB)	Remark
1	0.1645	67.25	-101.66	-34.41	23.28	-85.91	-28.22	-57.69	peak
2	0.2051	63.31	-101.73	-38.42	21.36	-89.92	-30.14	-59.78	peak
3	0.2489	61.19	-101.80	-40.61	19.68	-92.11	-31.82	-60.29	peak
4	0.2877	59.84	-101.85	-42.01	18.42	-93.51	-33.08	-60.43	peak
5	0.3573	58.08	-101.91	-43.83	16.54	-95.33	-34.96	-60.37	peak
6	0.4707	55.23	-102.04	-46.81	14.15	-98.31	-37.35	-60.96	peak

Note: 1. Measurement = Reading Level + Correct Factor (dBuA/m= dBuV/m- 20Log10[120π] = dBuV/m- 51.5).

2. If Peak Result complies with AV and QP limit, AV and QP Result are deemed to comply with AV limit.

3. All 3 polarizations(Horizontal, Face-on and Face-off) of the loop antenna had been tested, but only the worst data recorded in the report.



**490 kHz ~ 30 MHz**

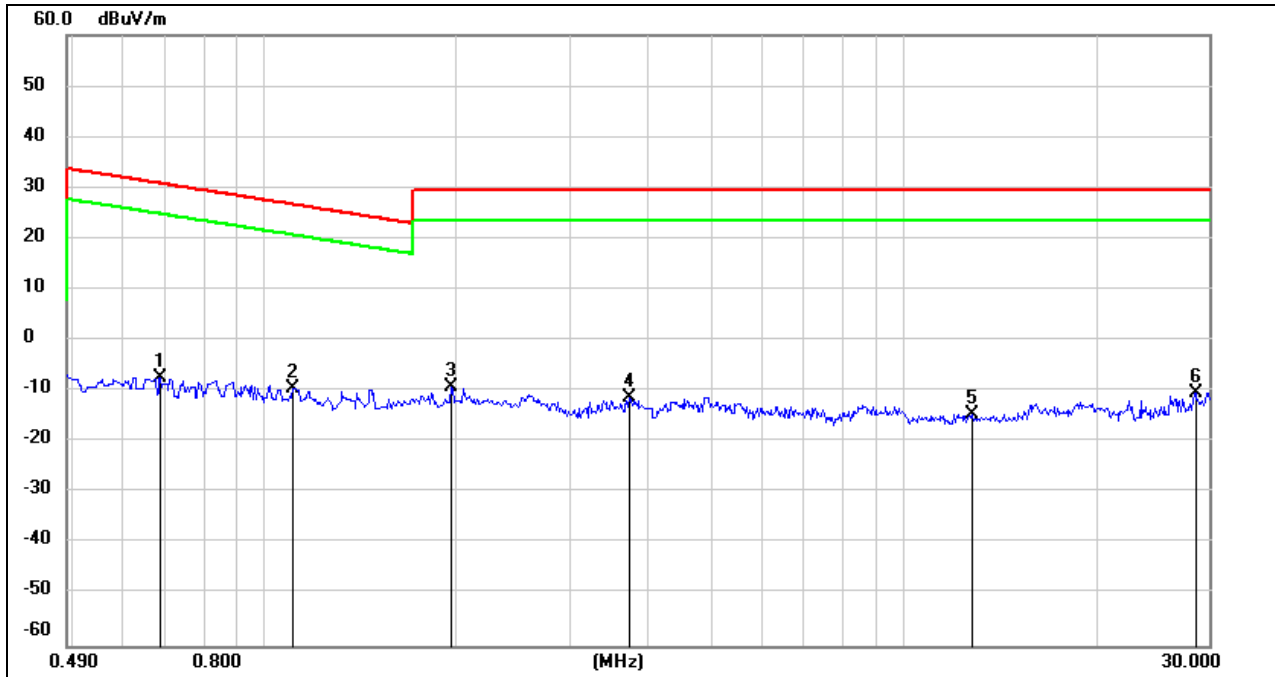

No.	Frequency (MHz)	Reading (dBuV)	Correct (dB/m)	FCC Result (dBuV/m)	FCC Limit (dBuV/m)	ISED Result (dBuA/m)	ISED Limit (dBuA/m)	Margin (dB)	Remark
1	0.6864	54.79	-62.11	-7.32	30.87	-58.82	-20.63	-38.19	peak
2	1.1091	52.82	-62.22	-9.4	26.71	-60.90	-24.79	-36.11	peak
3	1.9521	52.61	-61.84	-9.23	29.54	-60.73	-21.96	-38.77	peak
4	3.7100	50.20	-61.41	-11.21	29.54	-62.71	-21.96	-40.75	peak
5	12.7660	46.40	-60.92	-14.52	29.54	-66.02	-21.96	-44.06	peak
6	28.6128	49.87	-60.10	-10.23	29.54	-61.73	-21.96	-39.77	peak

Note: 1. Measurement = Reading Level + Correct Factor (dBuA/m= dBuV/m- 20Log10[120π] = dBuV/m- 51.5).

2. If Peak Result complies with AV and QP limit, AV and QP Result are deemed to comply with AV limit.

3. All 3 polarizations(Horizontal, Face-on and Face-off) of the loop antenna had been tested, but only the worst data recorded in the report.

Note: All the modes have been tested, only the worst data was recorded in the report.

## 9. AC POWER LINE CONDUCTED EMISSIONS

### LIMITS

Please refer to CFR 47 FCC §15.207 (a) and ISED RSS-Gen Clause 8.8

FREQUENCY (MHz)	Quasi-peak	Average
0.15 -0.5	66 - 56 *	56 - 46 *
0.50 -5.0	56.00	46.00
5.0 -30.0	60.00	50.00

### TEST SETUP AND PROCEDURE

Refer to ANSI C63.10-2013 clause 6.2.

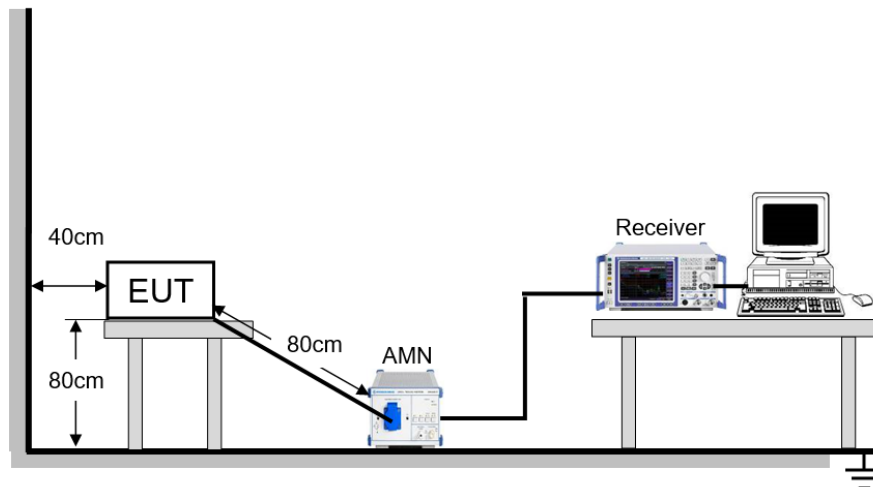

The EUT is put on a table of non-conducting material that is 80 cm high. The vertical conducting wall of shielding is located 40 cm to the rear of the EUT. The power line of the EUT is connected to the AC mains through a Artificial Mains Network (A.M.N.). A EMI Measurement Receiver (R&S Test Receiver ESR3) is used to test the emissions from both sides of AC line. According to the requirements in Section 6.2 of ANSI C63.10-2013. Conducted emissions from the EUT measured in the frequency range between 0.15 MHz and 30 MHz using CISPR Quasi-Peak and average detector mode. The bandwidth of EMI test receiver is set at 9 kHz.

The arrangement of the equipment is installed to meet the standards and operating in a manner, which tends to maximize its emission characteristics in a normal application.

### TEST ENVIRONMENT

Temperature	23.1 °C	Relative Humidity	56 %
Atmosphere Pressure	101 kPa	Test Voltage	DC 5 V



**TEST RESULTS**

**9.1.1. 8DPSK MODE**

**LINE L RESULTS (HIGH CHANNEL, WORST-CASE CONFIGURATION)**

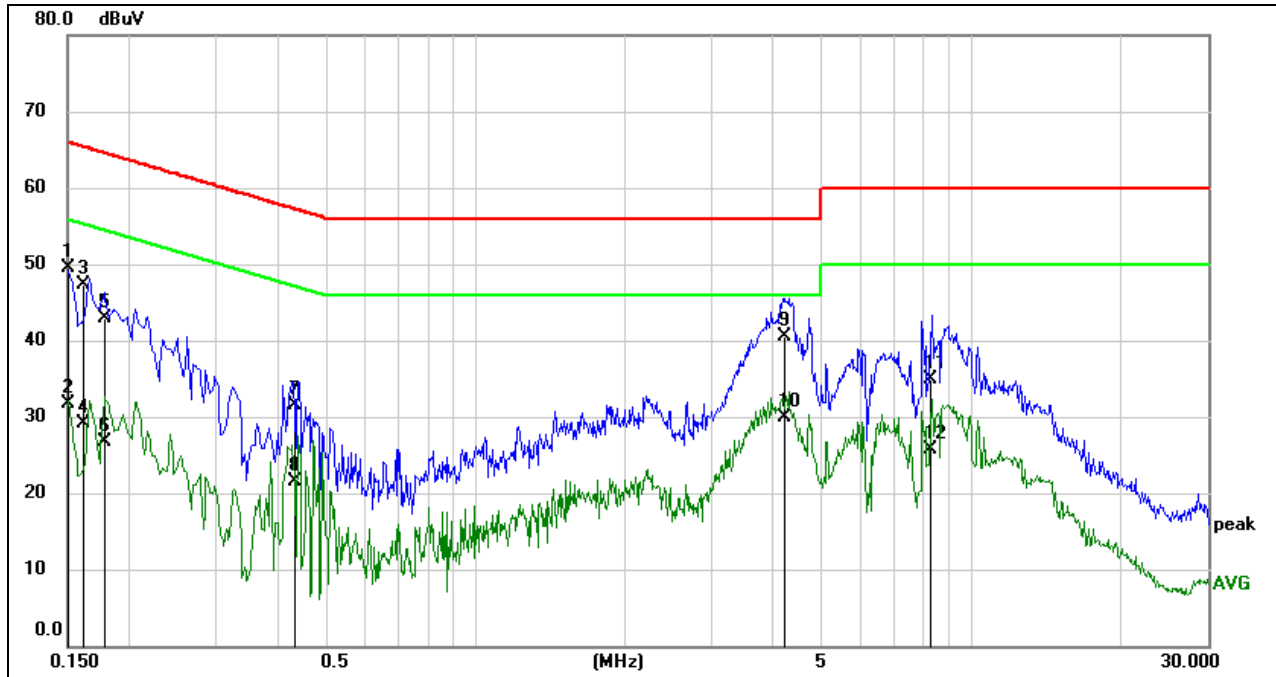

No.	Frequency (MHz)	Reading (dBuV)	Correct (dB)	Result (dBuV)	Limit (dBuV)	Margin (dB)	Remark
1	0.1507	39.88	9.61	49.49	65.96	-16.47	QP
2	0.1507	22.02	9.61	31.63	55.96	-24.33	AVG
3	0.1611	37.65	9.61	47.26	65.41	-18.15	QP
4	0.1611	19.55	9.61	29.16	55.41	-26.25	AVG
5	0.1780	33.31	9.61	42.92	64.58	-21.66	QP
6	0.1780	17.07	9.61	26.68	54.58	-27.90	AVG
7	0.4310	21.84	9.60	31.44	57.23	-25.79	QP
8	0.4310	11.84	9.60	21.44	47.23	-25.79	AVG
9	4.1771	30.84	9.66	40.50	56.00	-15.50	QP
10	4.1771	20.20	9.66	29.86	46.00	-16.14	AVG
11	8.2848	25.27	9.72	34.99	60.00	-25.01	QP
12	8.2848	16.07	9.72	25.79	50.00	-24.21	AVG

- Note: 1. Result = Reading + Correct Factor.  
 2. If QP Result complies with AV limit, AV Result is deemed to comply with AV limit.  
 3. Test setup: RBW: 200 Hz (9 kHz ~ 150 kHz), 9 kHz (150 kHz ~ 30 MHz).  
 4. Step size: 80 Hz (0.009 MHz ~ 0.15 MHz), 4 kHz (0.15 MHz ~ 30 MHz), Scan time: auto.



**LINE N RESULTS (HIGH CHANNEL, WORST-CASE CONFIGURATION)**

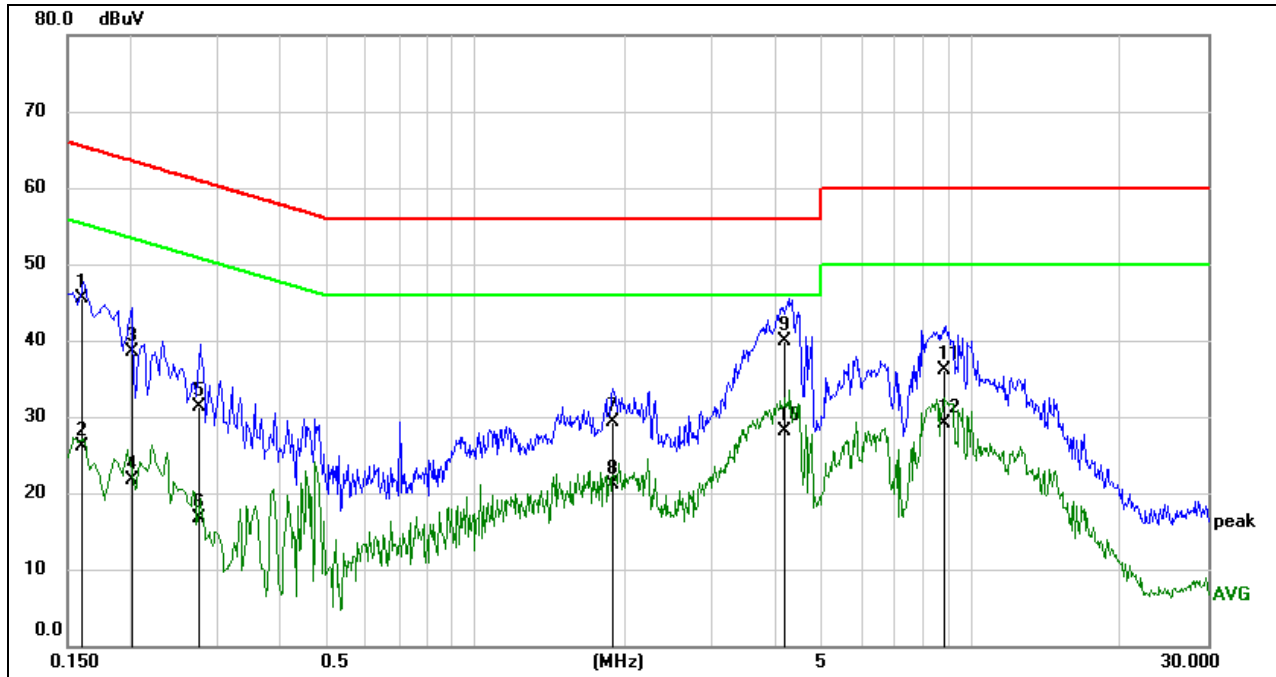

No.	Frequency (MHz)	Reading (dBuV)	Correct (dB)	Result (dBuV)	Limit (dBuV)	Margin (dB)	Remark
1	0.1598	35.85	9.60	45.45	65.47	-20.02	QP
2	0.1598	16.59	9.60	26.19	55.47	-29.28	AVG
3	0.2031	28.88	9.60	38.48	63.48	-25.00	QP
4	0.2031	12.12	9.60	21.72	53.48	-31.76	AVG
5	0.2744	21.61	9.60	31.21	60.98	-29.77	QP
6	0.2744	7.10	9.60	16.70	50.98	-34.28	AVG
7	1.8936	19.63	9.63	29.26	56.00	-26.74	QP
8	1.8936	11.38	9.63	21.01	46.00	-24.99	AVG
9	4.2001	30.23	9.66	39.89	56.00	-16.11	QP
10	4.2001	18.53	9.66	28.19	46.00	-17.81	AVG
11	8.8440	26.43	9.74	36.17	60.00	-23.83	QP
12	8.8440	19.33	9.74	29.07	50.00	-20.93	AVG

- Note: 1. Result = Reading + Correct Factor.  
 2. If QP Result complies with AV limit, AV Result is deemed to comply with AV limit.  
 3. Test setup: RBW: 200 Hz (9 kHz ~ 150 kHz), 9 kHz (150 kHz ~ 30 MHz).  
 4. Step size: 80 Hz (0.009 MHz ~ 0.15 MHz), 4 kHz (0.15 MHz ~ 30 MHz), Scan time: auto.

Note: All the modes have been tested, only the worst data was recorded in the report.



## 10. ANTENNA REQUIREMENTS

### APPLICABLE REQUIREMENTS

Please refer to FCC §15.203

An intentional radiator shall be designed to ensure that no antenna other than that furnished by the responsible party shall be used with the device. The use of a permanently attached antenna or of an antenna that uses a unique coupling to the intentional radiator shall be considered sufficient to comply with the provisions of this section. The manufacturer may design the unit so that a broken antenna can be replaced by the user, but the use of a standard antenna jack or electrical connector is prohibited.

Please refer to FCC §15.247(b)(4)

The conducted output power limit specified in paragraph (b) of this section is based on the use of antennas with directional gains that do not exceed 6 dBi. Except as shown in paragraph (c) of this section, if transmitting antennas of directional gain greater than 6 dBi are used, the conducted output power from the intentional radiator shall be reduced below the stated values in paragraphs (b)(1), (b)(2), and (b)(3) of this section, as appropriate, by the amount in dB that the directional gain of the antenna exceeds 6 dBi.

### RESULTS

Complies



## Appendix

### Appendix A: 20dB Emission Bandwidth Test Result

Test Packet Type	Antenna	Channel	20db EBW[MHz]	FL[MHz]	FH[MHz]	Verdict
DH5	Ant1	2402	0.942	2401.577	2402.519	PASS
		2441	0.942	2440.577	2441.519	PASS
		2480	0.945	2479.577	2480.522	PASS
3DH5	Ant1	2402	1.254	2401.400	2402.654	PASS
		2441	1.266	2440.397	2441.663	PASS
		2480	1.290	2479.391	2480.681	PASS



### Test Graphs

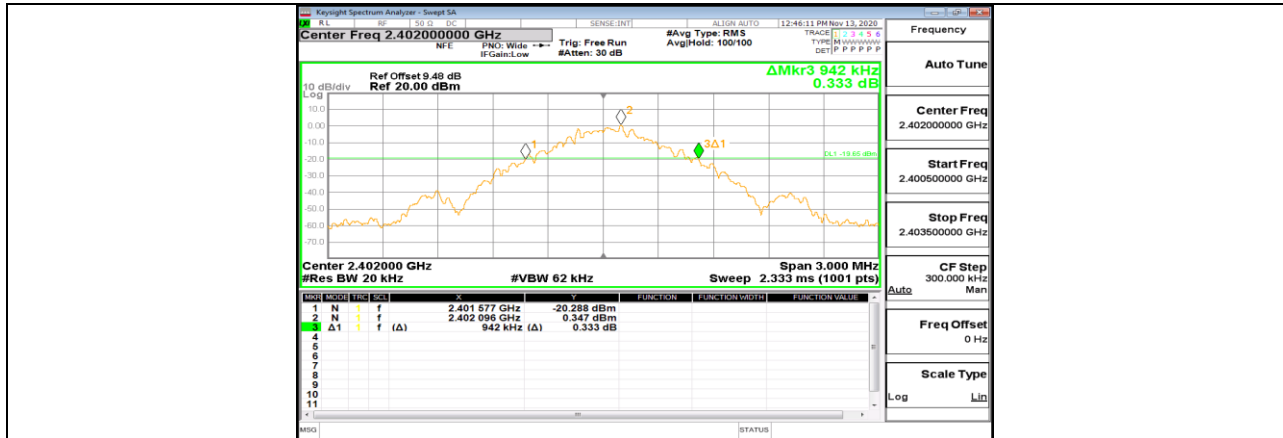

DH5\_Ant1\_2402



DH5\_Ant1\_2441

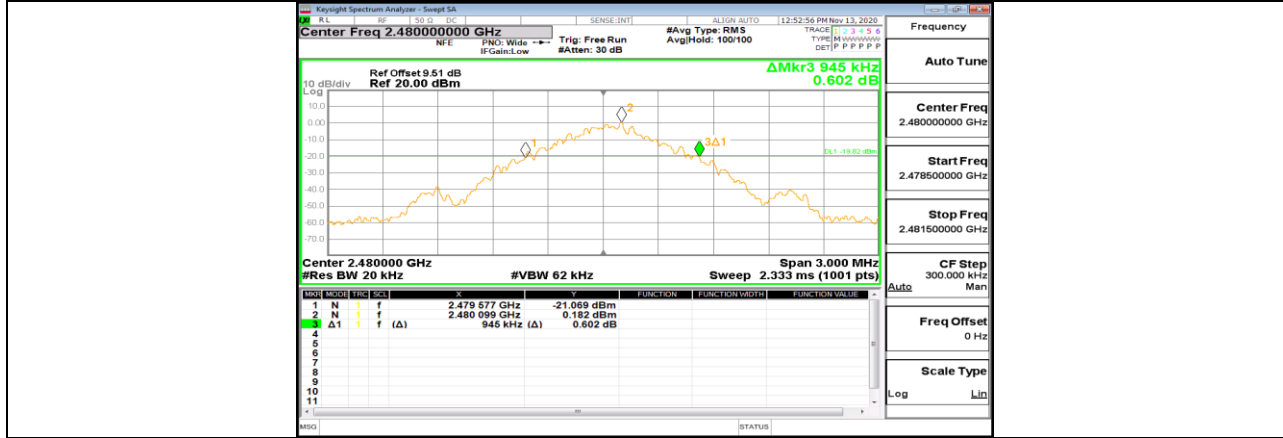

DH5\_Ant1\_2480

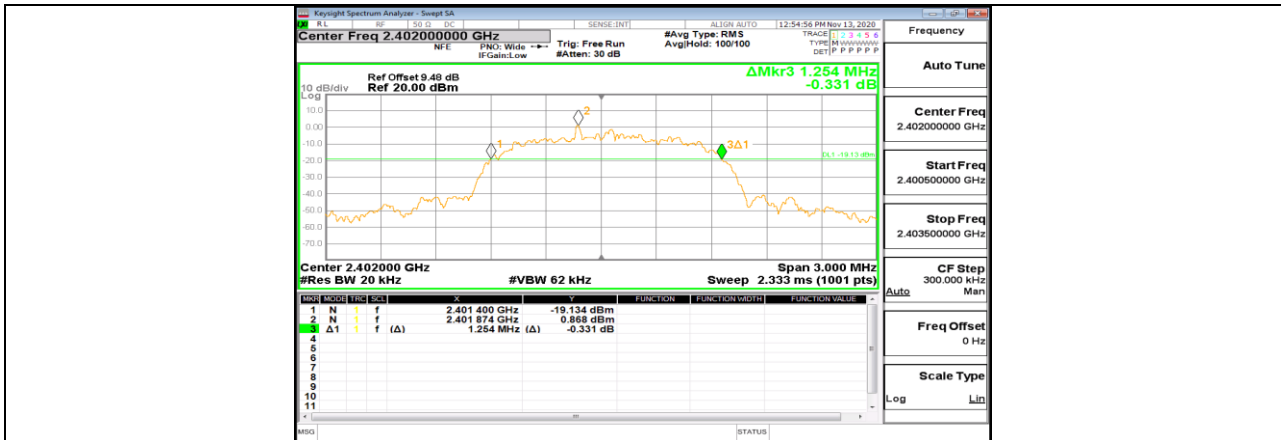

3DH5\_Ant1\_2402



3DH5\_Ant1\_2441

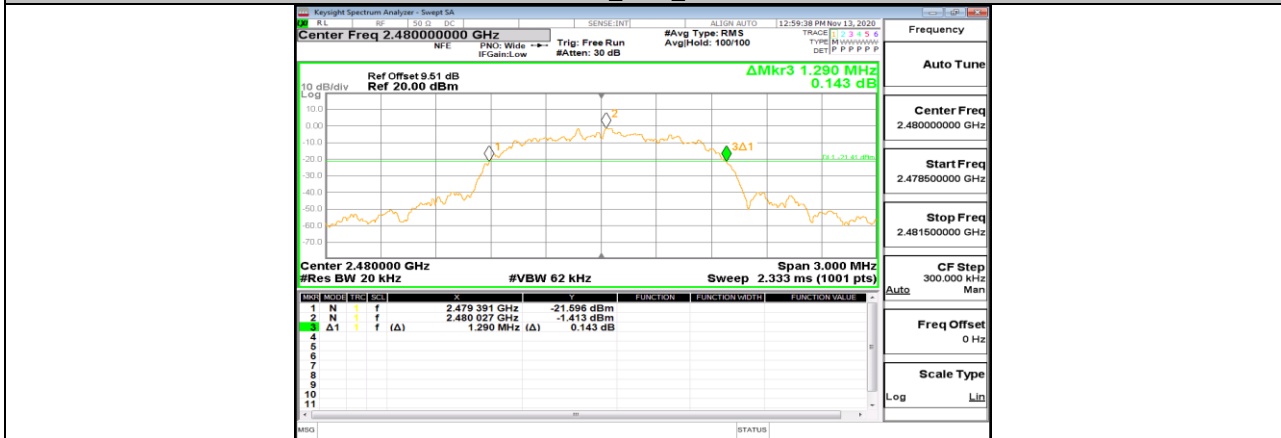

3DH5\_Ant1\_2480





### Appendix B: Occupied Channel Bandwidth Test Result

Test Packet Type	Antenna	Channel	OCB [MHz]	FL[MHz]	FH[MHz]	Verdict
DH5	Ant1	2402	0.86622	2401.600	2402.466	PASS
		2441	0.86393	2440.600	2441.464	PASS
		2480	0.86356	2479.602	2480.465	PASS
3DH5	Ant1	2402	1.1776	2401.445	2402.622	PASS
		2441	1.1651	2440.453	2441.619	PASS
		2480	1.1684	2479.451	2480.619	PASS



### Test Graphs



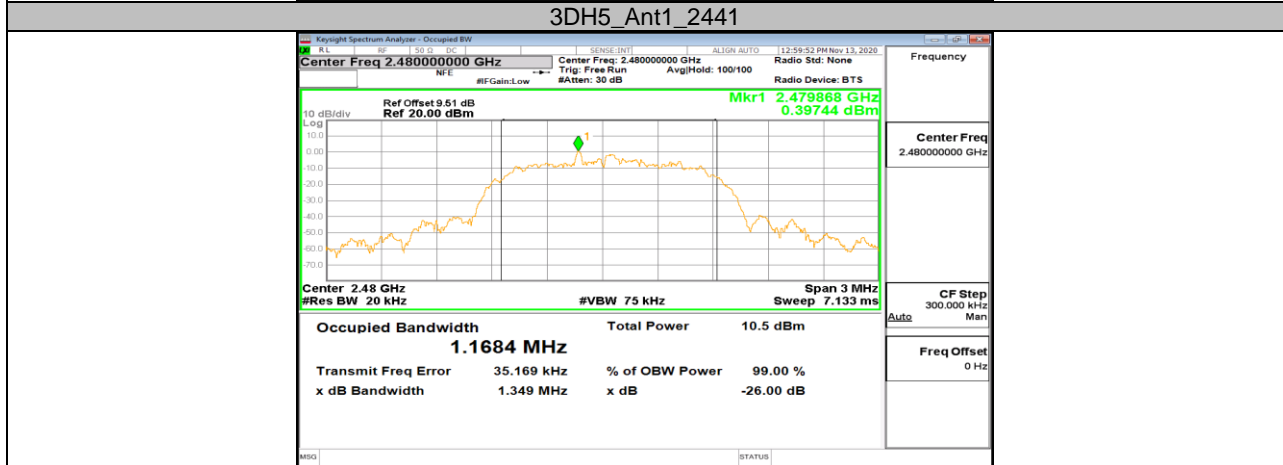
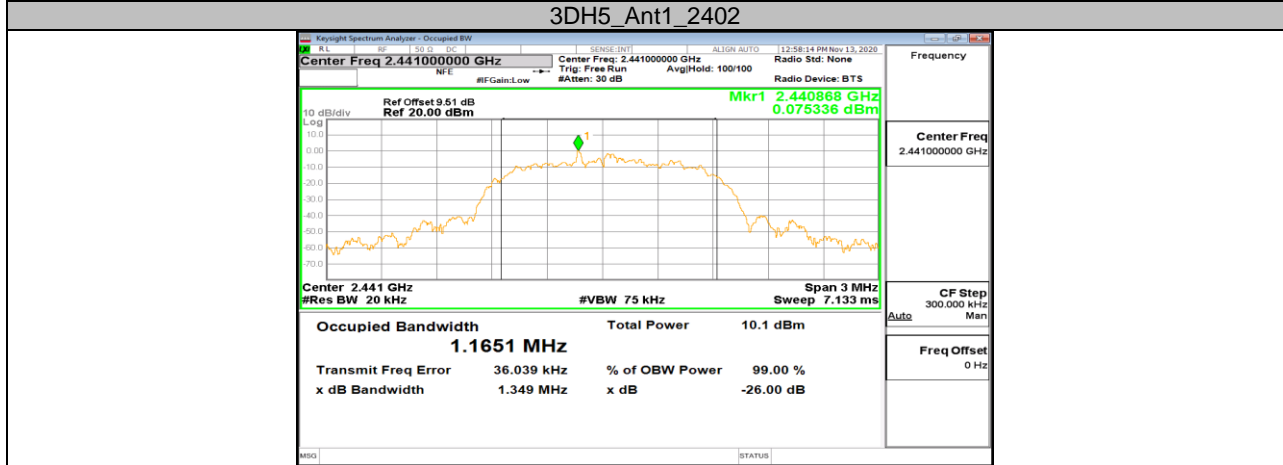
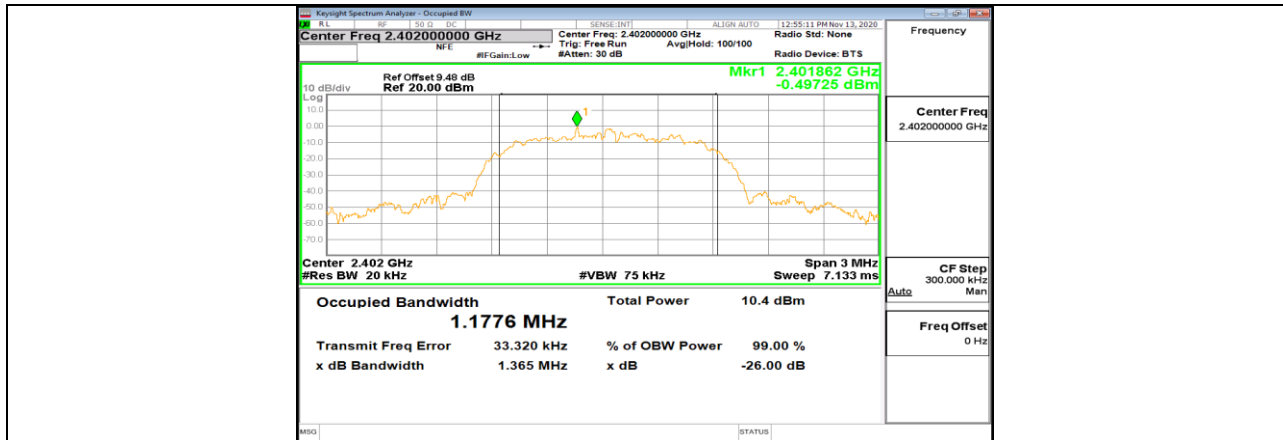

**3DH5\_Ant1\_2480**



### Appendix C: Maximum conducted output power Test Result

Test Packet Type	Antenna	Channel	Result[dBm]	Limit[dBm]	Verdict
DH5	Ant1	2402	5.71	<=30	PASS
		2441	5.41	<=30	PASS
		2480	5.54	<=30	PASS
3DH5	Ant1	2402	8.09	<=30	PASS
		2441	7.95	<=30	PASS
		2480	8.33	<=30	PASS



### Appendix D: Carrier frequency separation Test Result

Test Packet Type	Antenna	Channel	Result[MHz]	Limit[MHz]	Verdict
DH5	Ant1	Hop	1.008	$\geq 0.945$	PASS
3DH5	Ant1	Hop	1.008	$\geq 1.290$	PASS



### Test Graphs

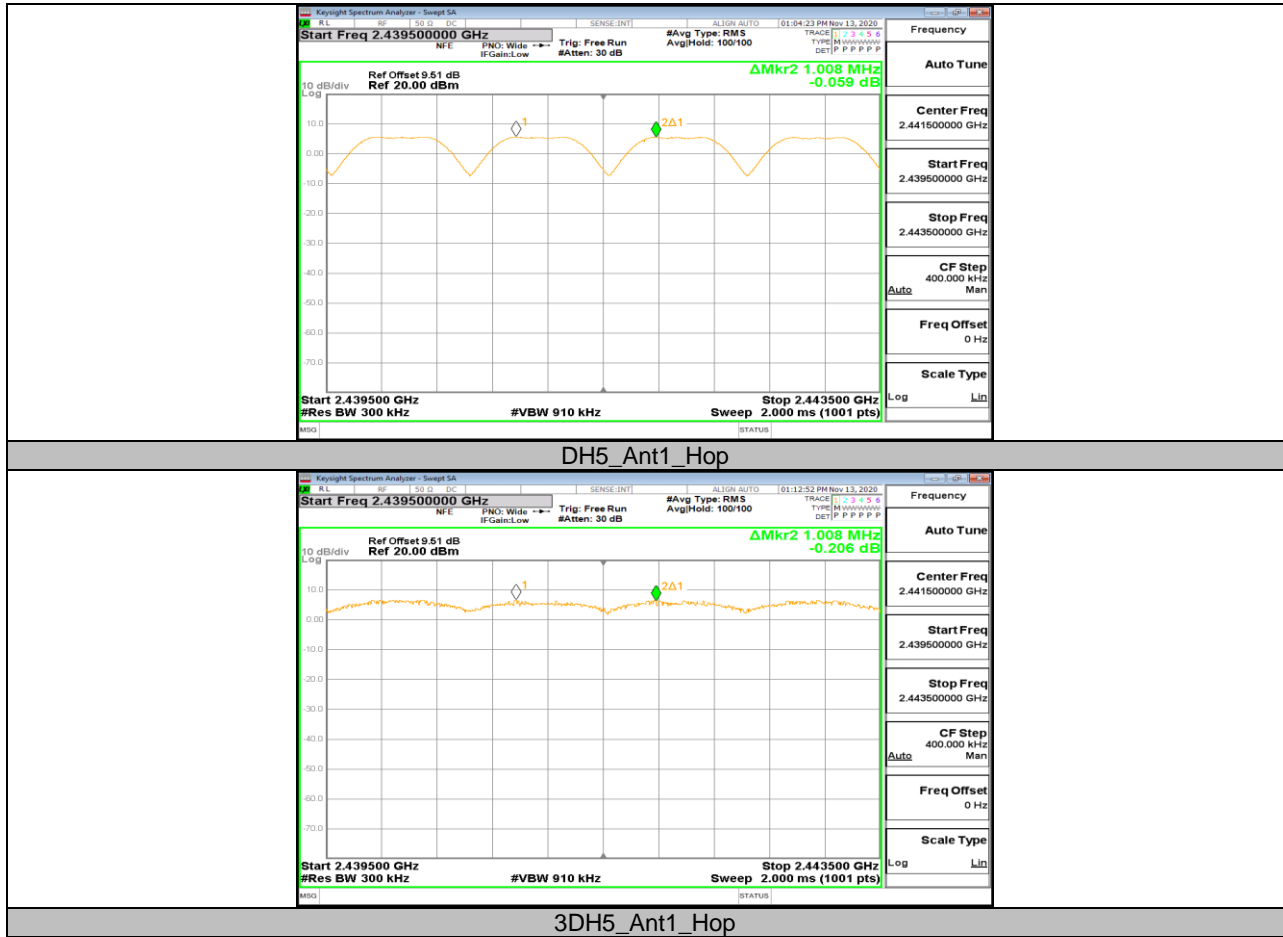

### Appendix E: Time of occupancy Test Result

FHSS Mode						
Test Packet Type	Antenna	Channel	BurstWidth [ms]	Result[s]	Limit[s]	Verdict
DH1	Ant1	Hop	0.38	0.122	<=0.4	PASS
DH3	Ant1	Hop	1.64	0.262	<=0.4	PASS
DH5	Ant1	Hop	2.89	0.308	<=0.4	PASS
3DH1	Ant1	Hop	0.39	0.125	<=0.4	PASS
3DH3	Ant1	Hop	1.64	0.262	<=0.4	PASS
3DH5	Ant1	Hop	2.89	0.308	<=0.4	PASS

AFHSS Mode						
Test Packet Type	Antenna	Channel	BurstWidth [ms]	Result[s]	Limit[s]	Verdict
DH1	Ant1	Hop	0.38	0.061	<=0.4	PASS
DH3	Ant1	Hop	1.64	0.131	<=0.4	PASS
DH5	Ant1	Hop	2.89	0.154	<=0.4	PASS
3DH1	Ant1	Hop	0.39	0.062	<=0.4	PASS
3DH3	Ant1	Hop	1.64	0.131	<=0.4	PASS



### Test Graphs

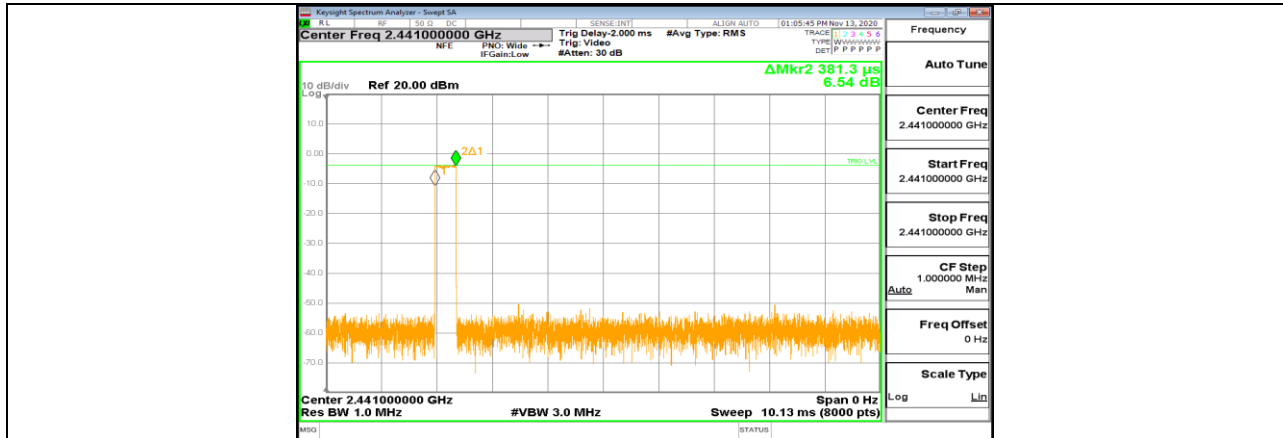

DH1\_Ant1\_Hop

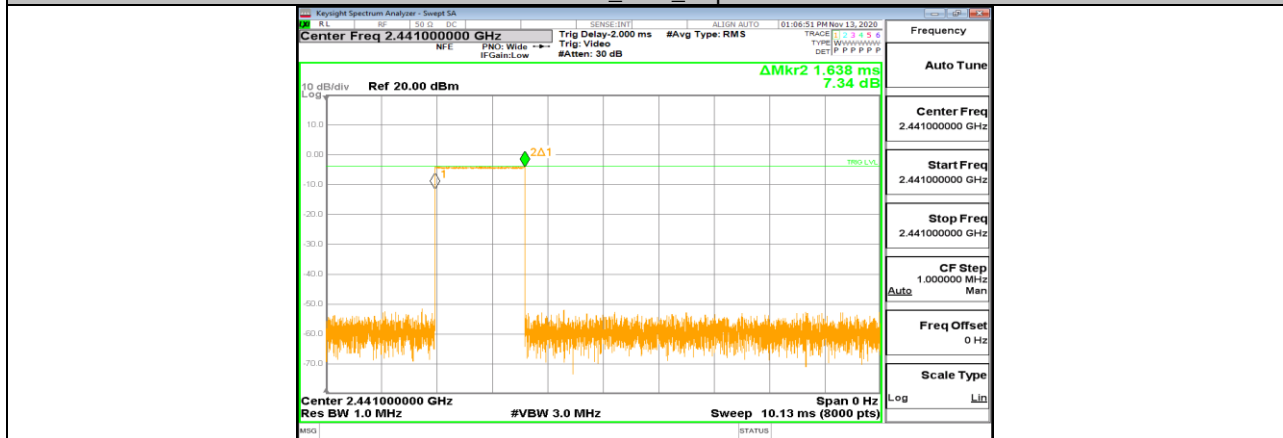

DH3\_Ant1\_Hop

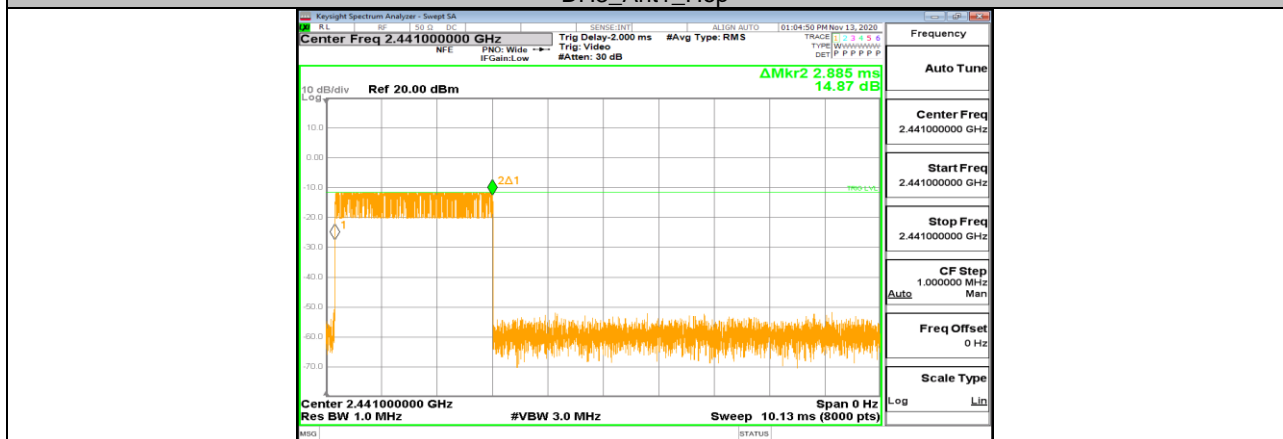

DH5\_Ant1\_Hop



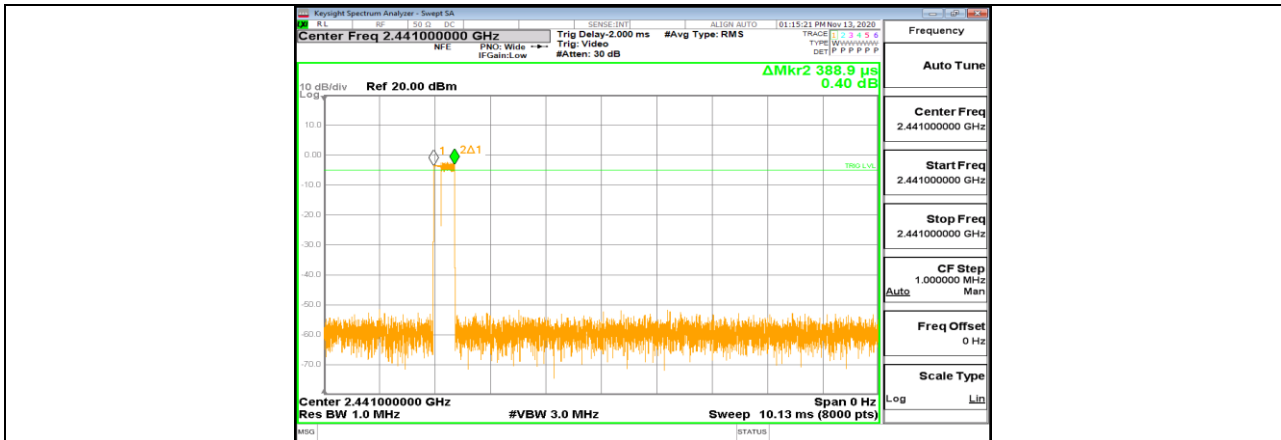

3DH1\_Ant1\_Hop

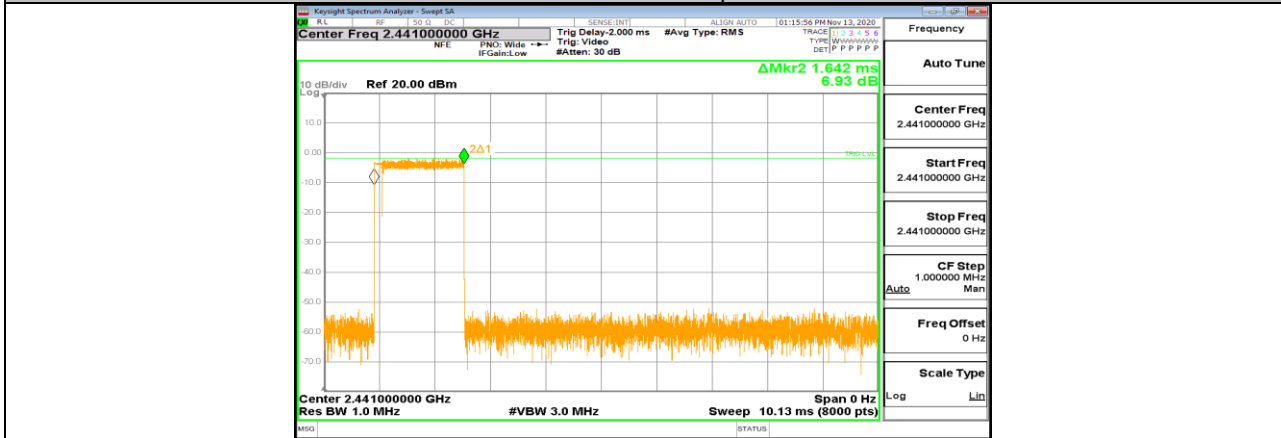

3DH3\_Ant1\_Hop

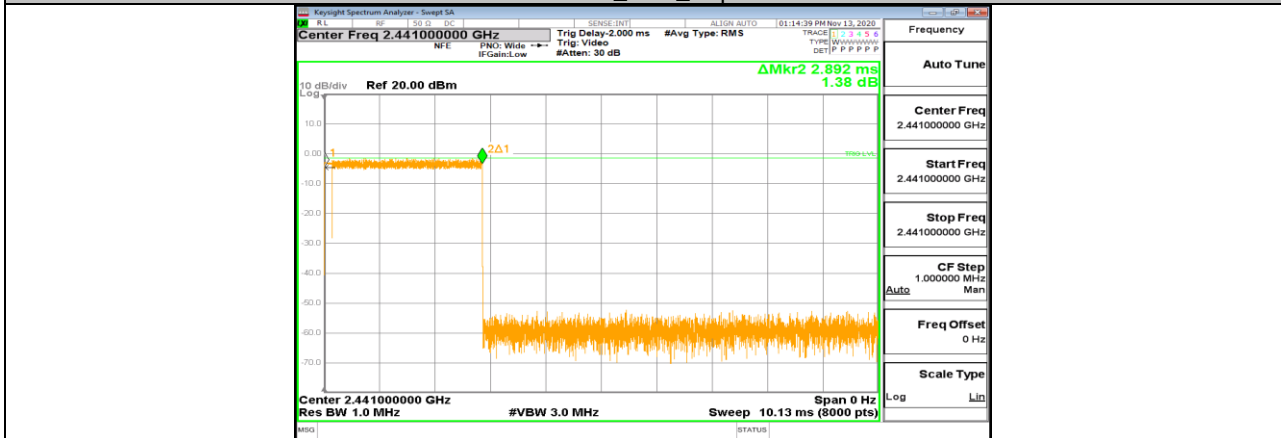

3DH5\_Ant1\_Hop



### Appendix F: Number of hopping channels Test Result

Test Packet Type	Antenna	Channel	Result[Num]	Limit[Num]	Verdict
DH5	Ant1	Hop	79	$\geq 15$	PASS
3DH5	Ant1	Hop	79	$\geq 15$	PASS



### Test Graphs

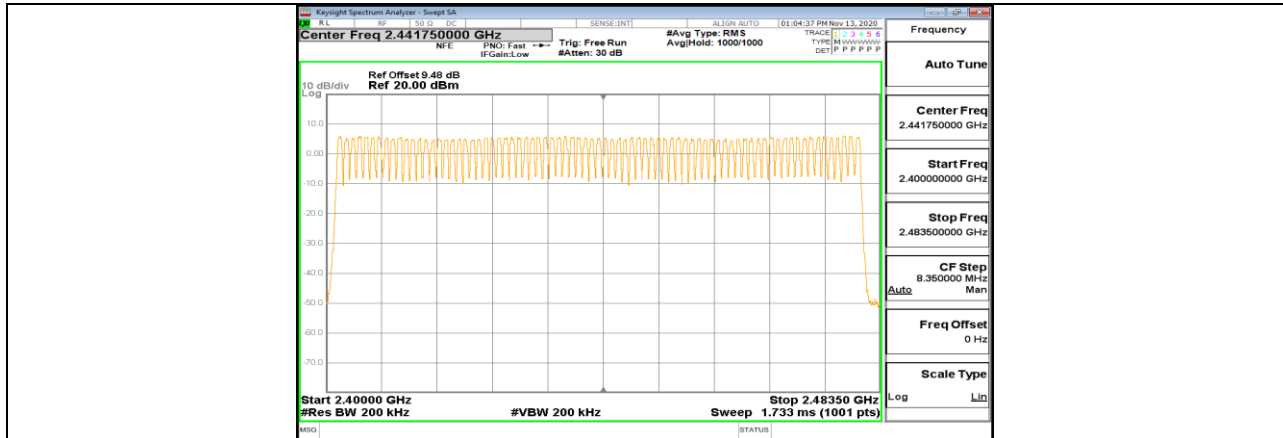

DH5\_Ant1\_Hop

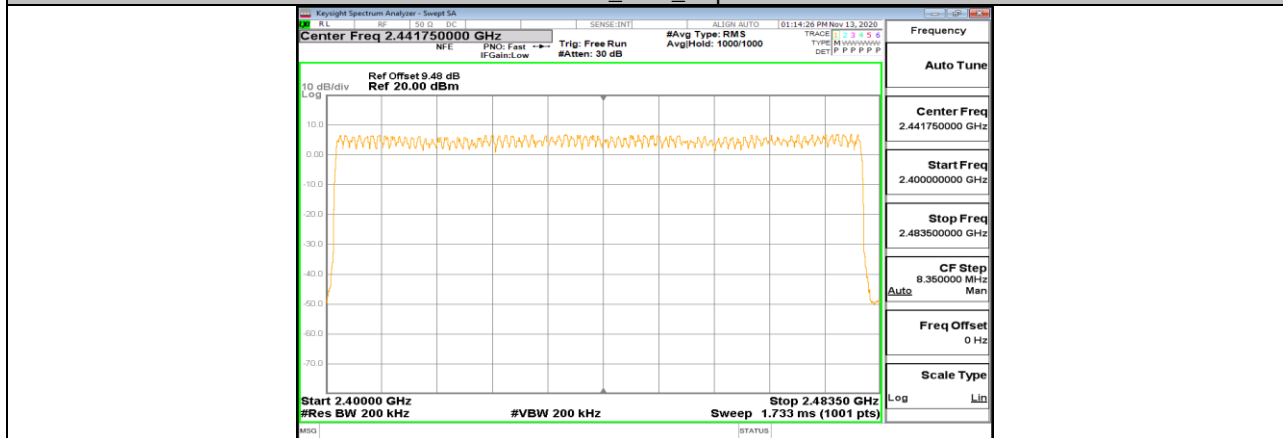

3DH5\_Ant1\_Hop



### Appendix G: Band edge measurements Test Result

Test Packet Type	Antenna	ChName	Channel	RefLevel [dBm]	Result [dBm]	Limit [dBm]	Verdict
DH5	Ant1	Low	2402	3.62	-49.8	<=-16.38	PASS
		High	2480	4.22	-51.01	<=-15.79	PASS
		Low	Hop_2402	5.79	-50.23	<=-14.21	PASS
		High	Hop_2480	4.52	-50.75	<=-15.48	PASS
3DH5	Ant1	Low	2402	4.52	-51.26	<=-15.48	PASS
		High	2480	4.33	-50.9	<=-15.67	PASS
		Low	Hop_2402	1.65	-51.35	<=-18.35	PASS
		High	Hop_2480	2.55	-50.77	<=-17.45	PASS



### Test Graphs

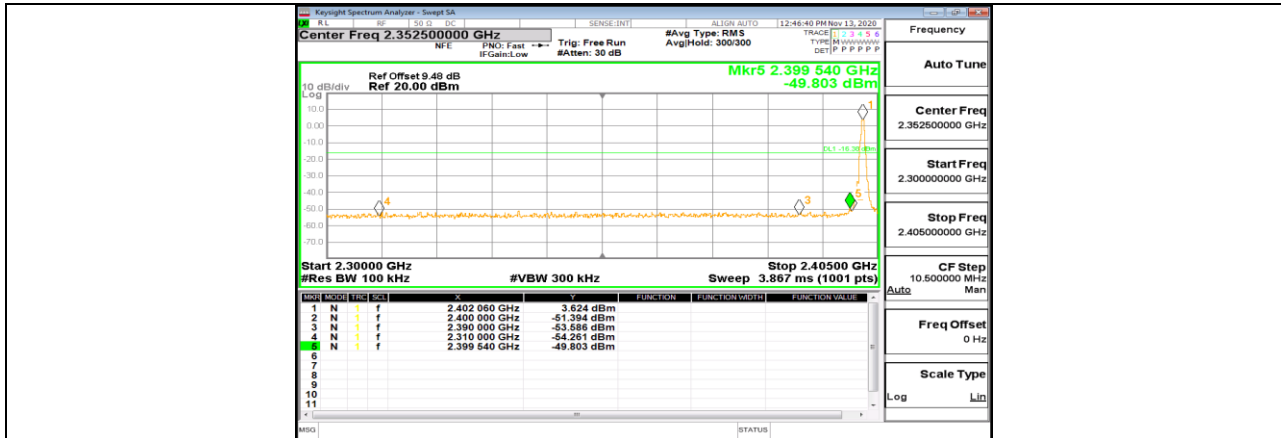

DH5\_Ant1\_Low\_2402

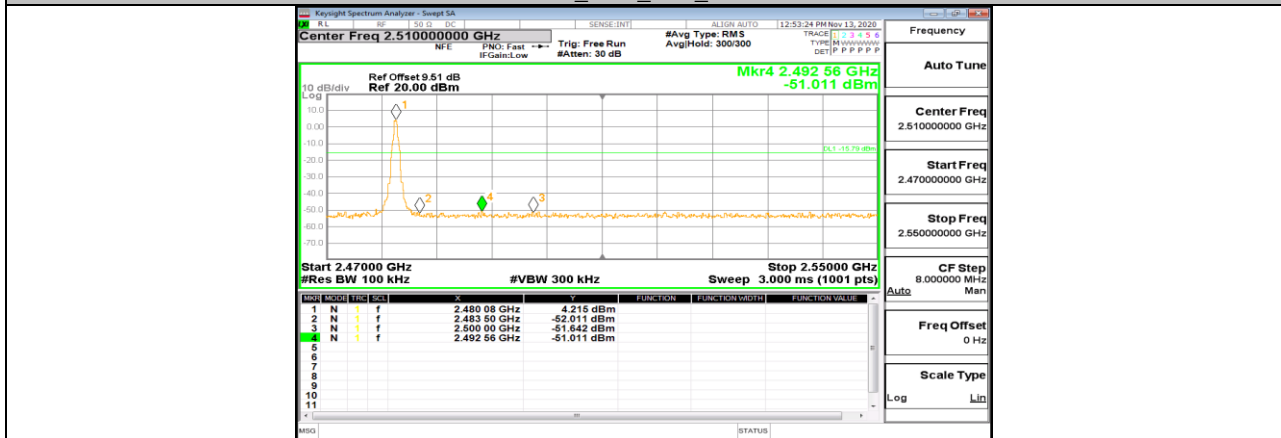

DH5\_Ant1\_High\_2480

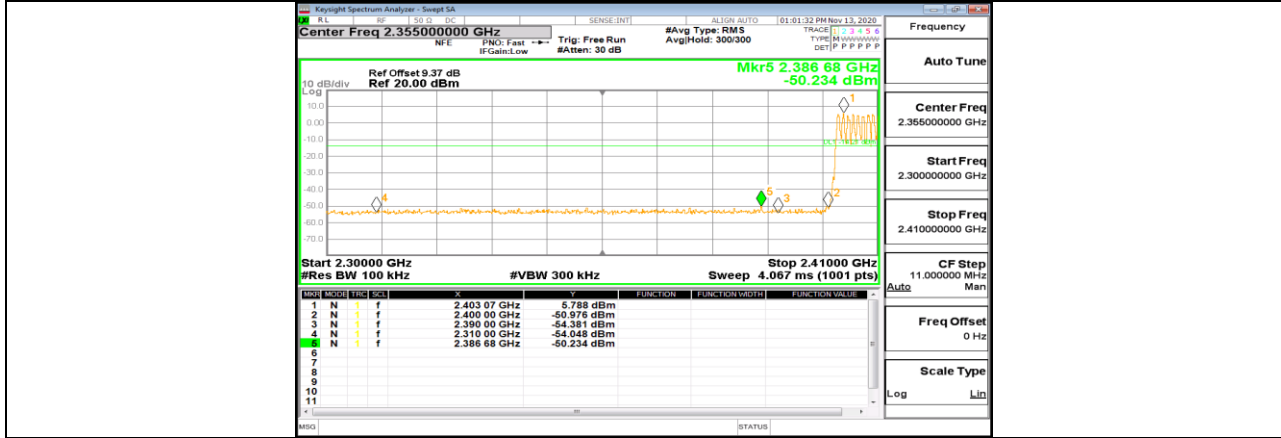

DH5\_Ant1\_Low\_Hop\_2402

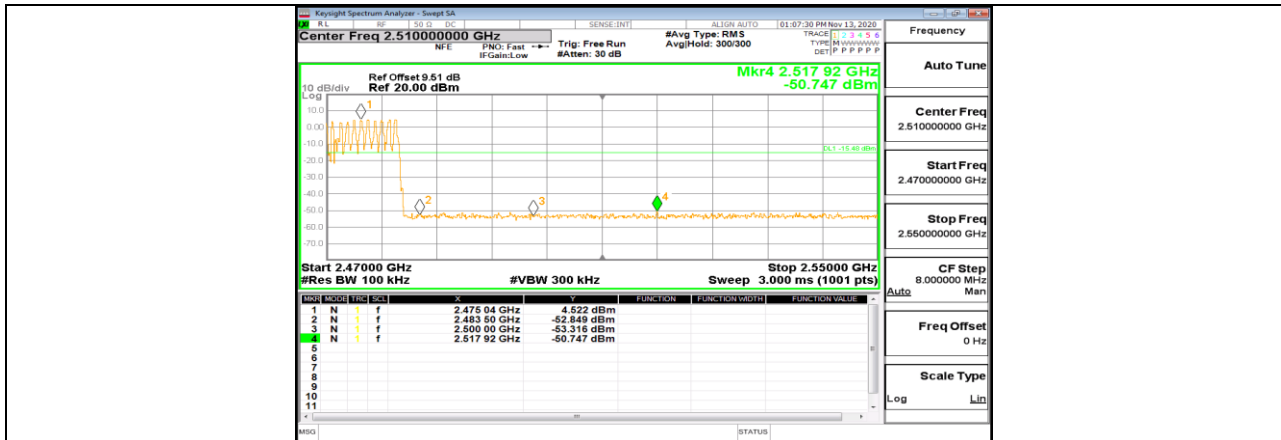

DH5\_Ant1\_High\_Hop\_2480

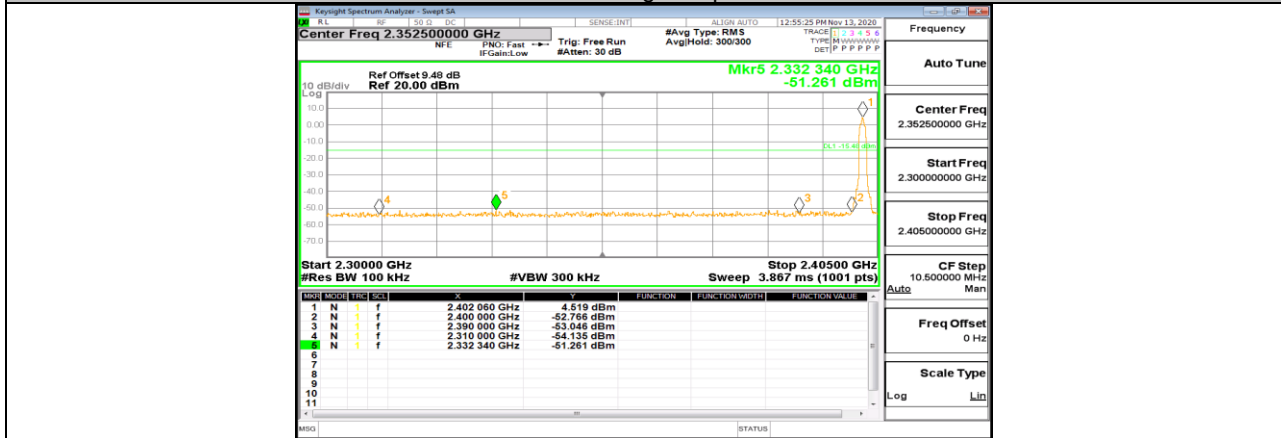

3DH5\_Ant1\_Low\_2402

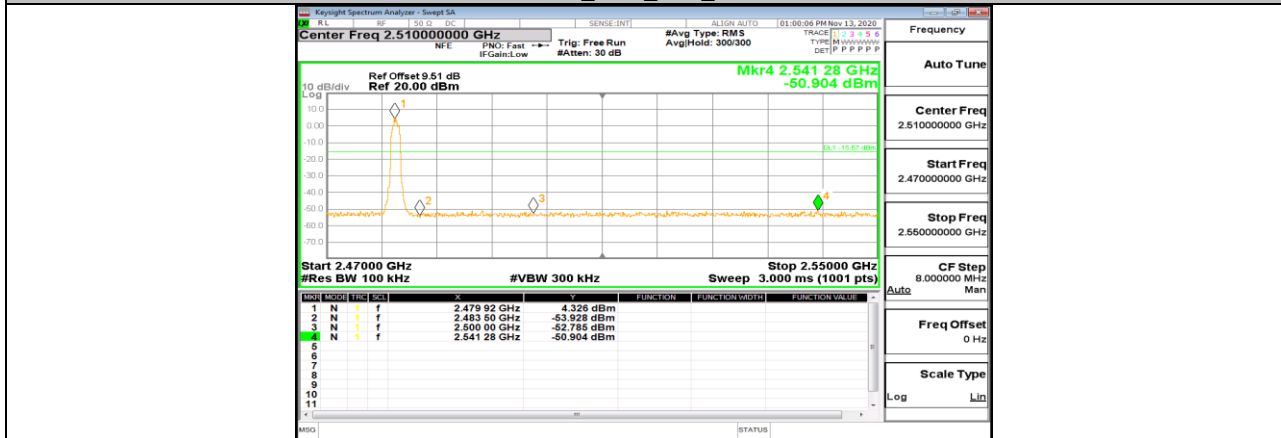

3DH5\_Ant1\_High\_2480

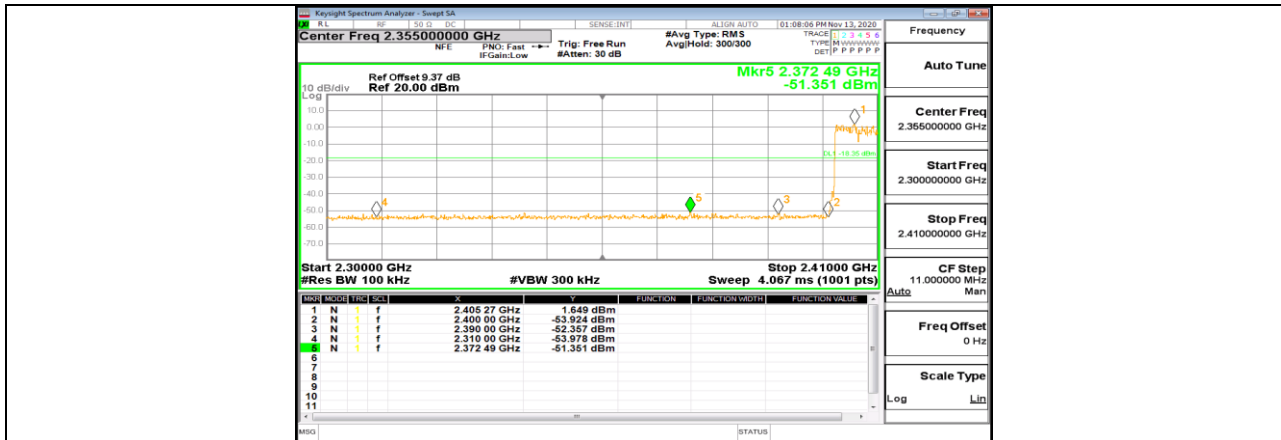

3DH5\_Ant1\_Low\_Hop\_2402

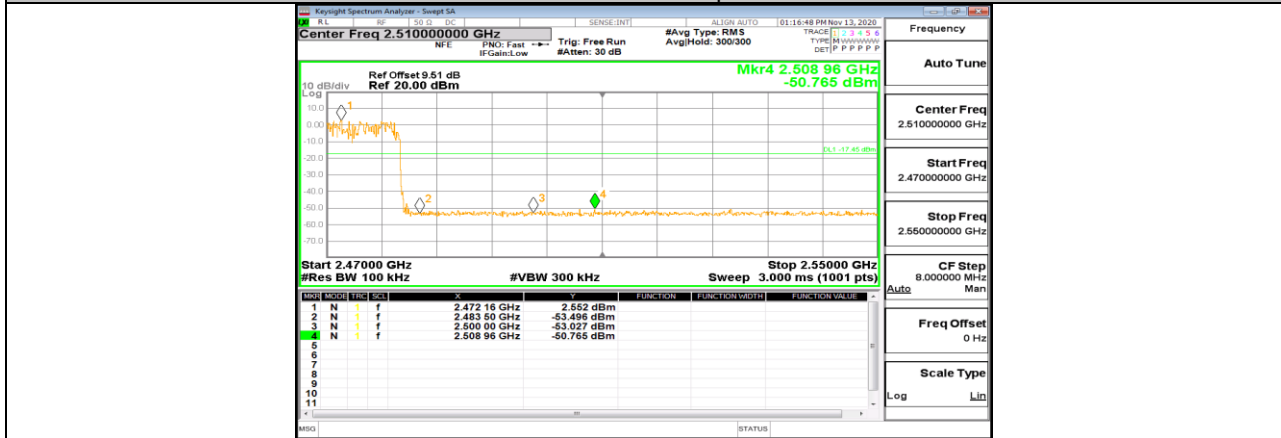

3DH5\_Ant1\_High\_Hop\_2480



### Appendix H: Conducted Spurious Emission Test Result

Test Packet Type	Antenna	Channel	FreqRange [MHz]	RefLevel [dBm]	Result [dBm]	Limit [dBm]	Verdict
DH5	Ant1	2402	Reference	4.14	4.14	---	PASS
			30~1000	---	-62.377	<=-15.859	PASS
			1000~26500	---	-55.007	<=-15.859	PASS
		2441	Reference	3.25	3.25	---	PASS
			30~1000	---	-63.425	<=-16.75	PASS
			1000~26500	---	-53.845	<=-16.75	PASS
		2480	Reference	4.09	4.09	---	PASS
			30~1000	---	-63.197	<=-15.907	PASS
			1000~26500	---	-54.578	<=-15.907	PASS
3DH5	Ant1	2402	Reference	4.52	4.52	---	PASS
			30~1000	---	-62.965	<=-15.482	PASS
			1000~26500	---	-53.154	<=-15.482	PASS
		2441	Reference	2.80	2.80	---	PASS
			30~1000	---	-62.939	<=-17.201	PASS
			1000~26500	---	-54.451	<=-17.201	PASS
		2480	Reference	4.17	4.17	---	PASS
			30~1000	---	-63.765	<=-15.833	PASS
			1000~26500	---	-54.152	<=-15.833	PASS





### Test Graphs

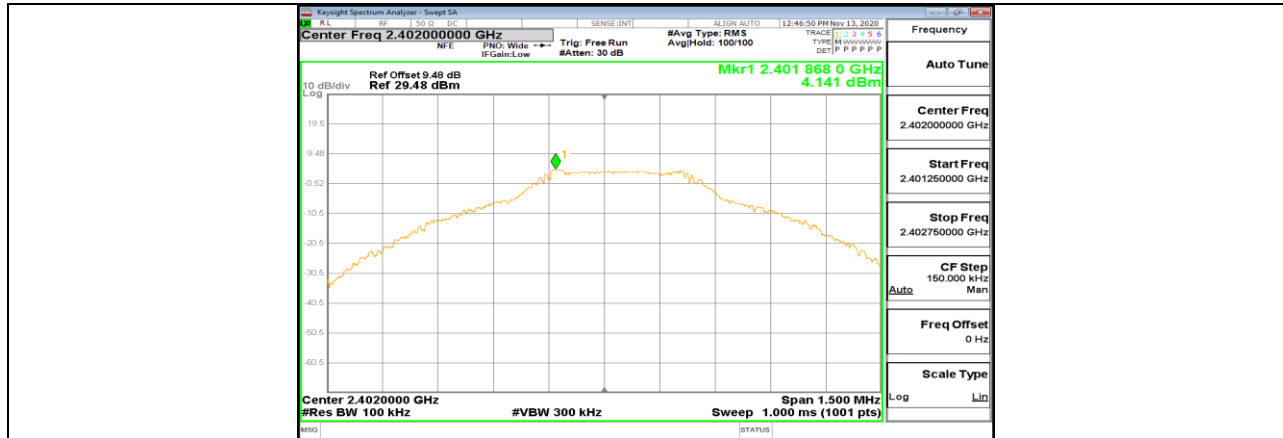

DH5\_Ant1\_2402\_0-Reference

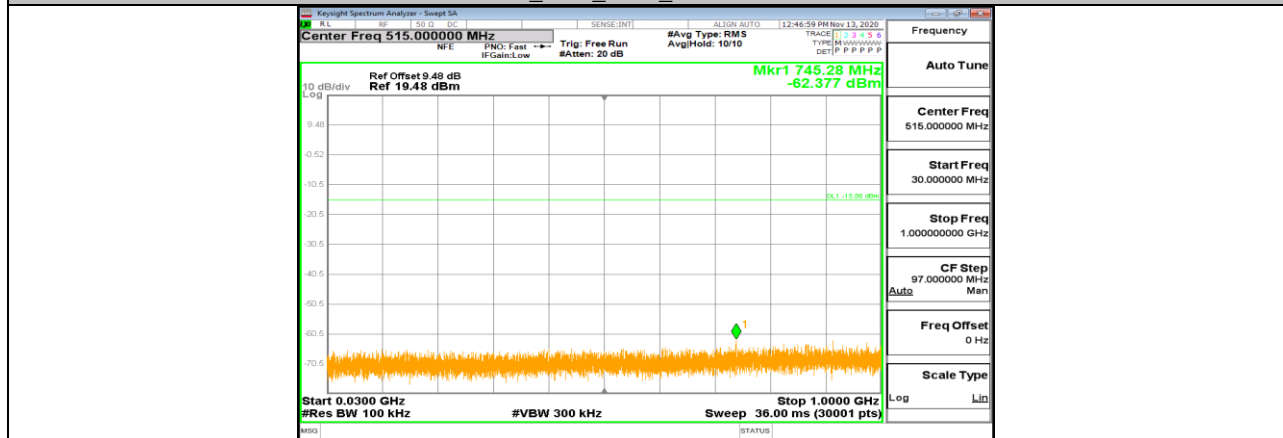

DH5\_Ant1\_2402\_30~1000

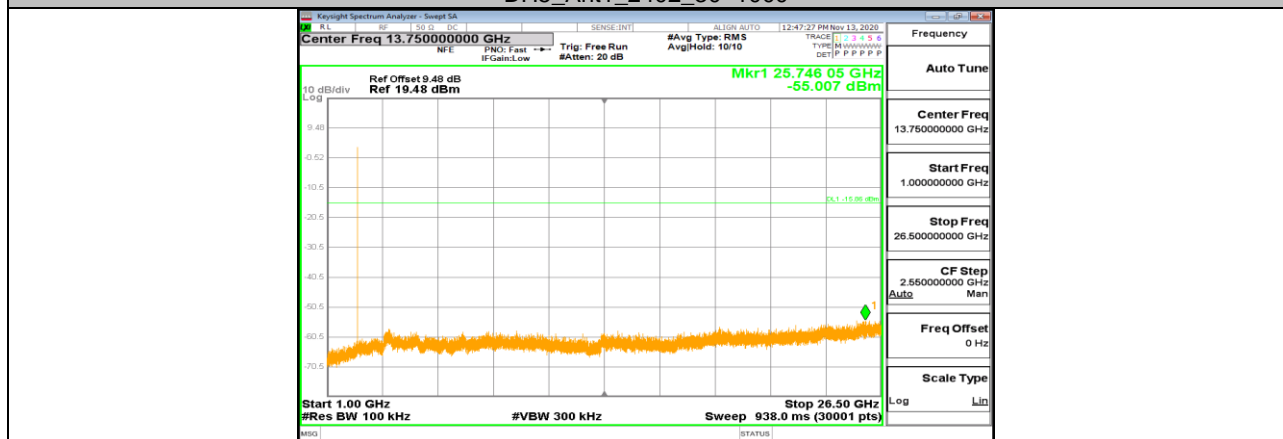

DH5\_Ant1\_2402\_1000~26500

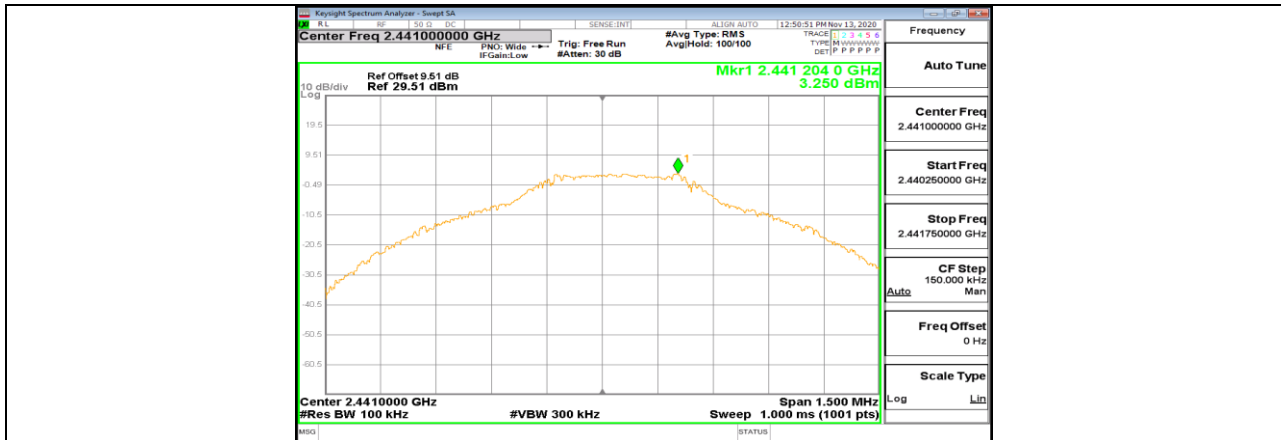

DH5\_Ant1\_2441\_0-Reference

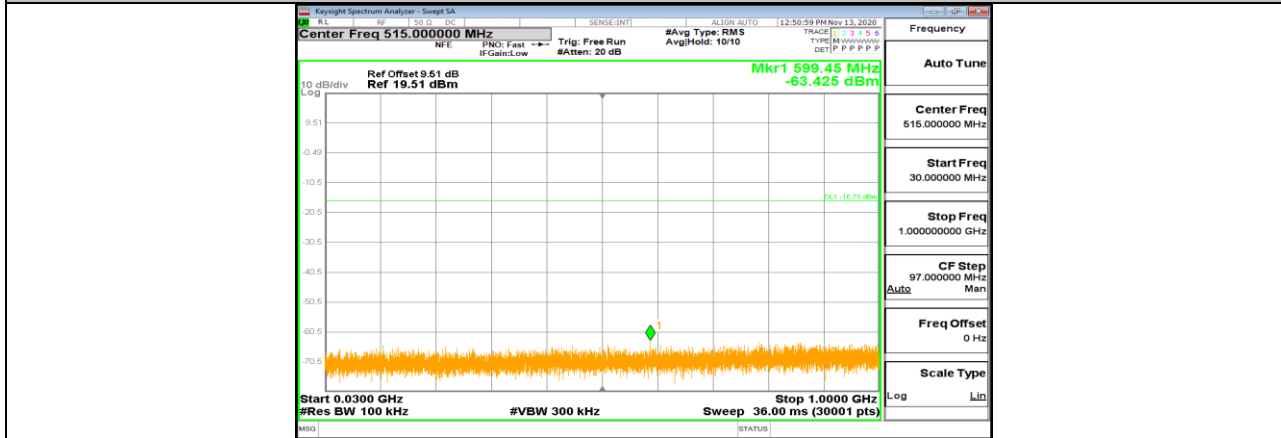

DH5\_Ant1\_2441\_30-1000

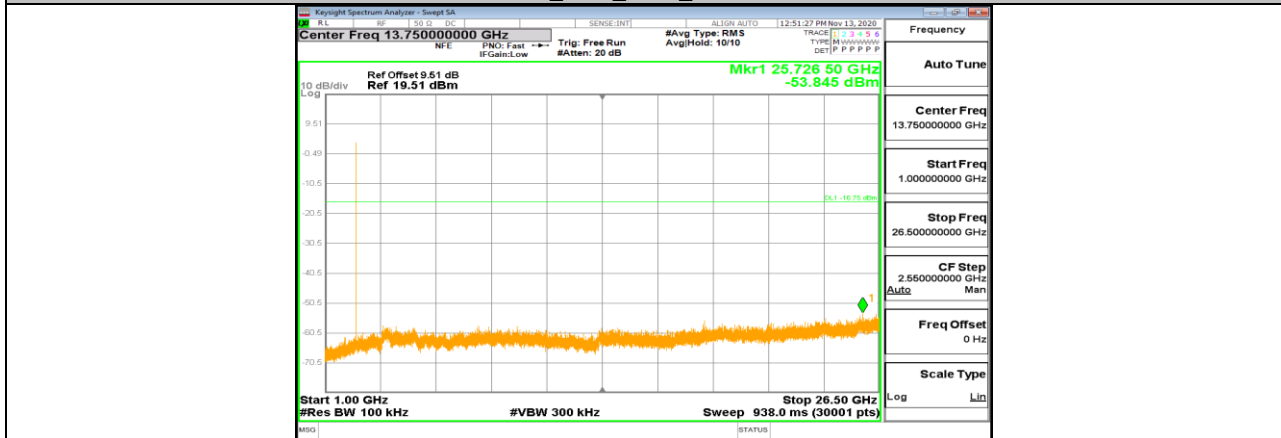

DH5\_Ant1\_2441\_1000-26500

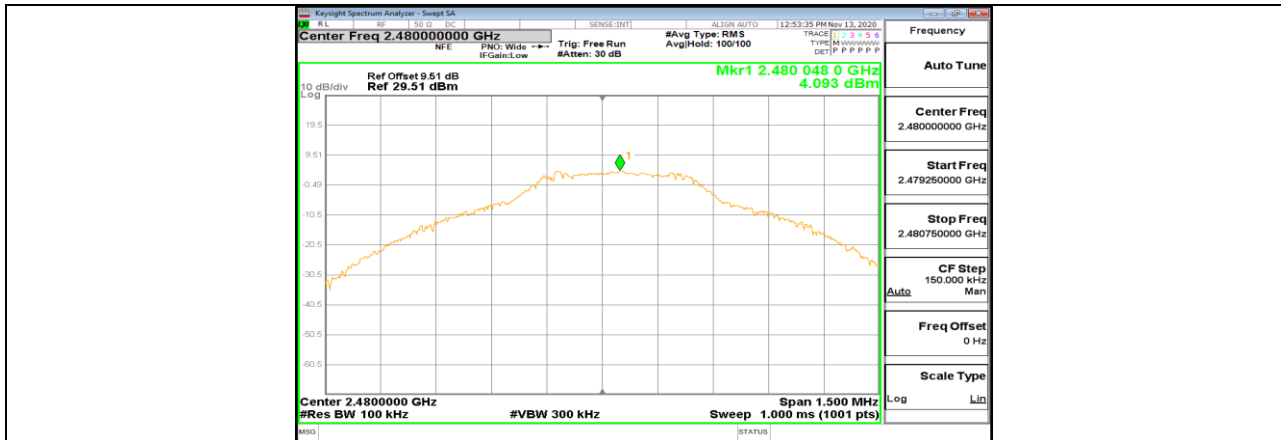

DH5\_Ant1\_2480\_0-Reference

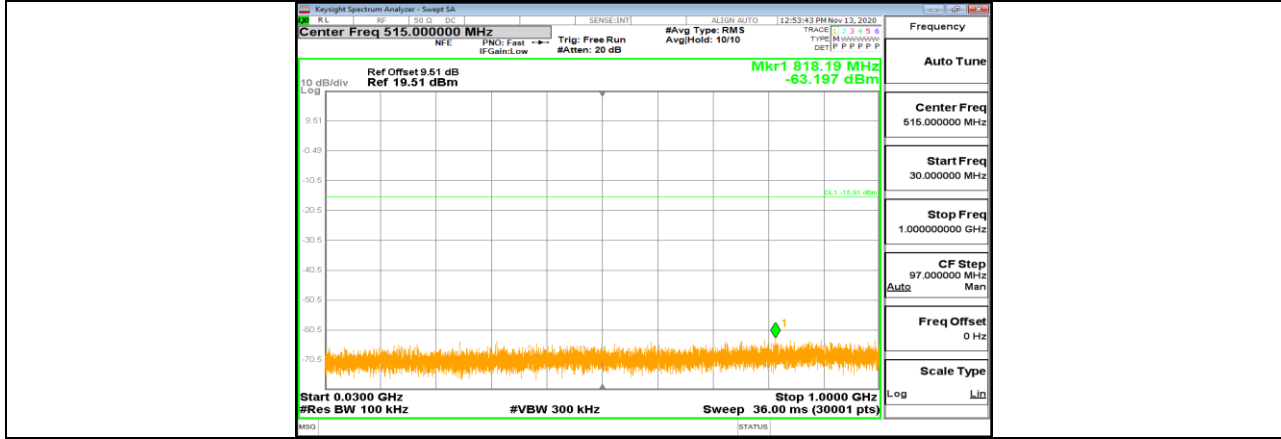

DH5\_Ant1\_2480\_30-1000

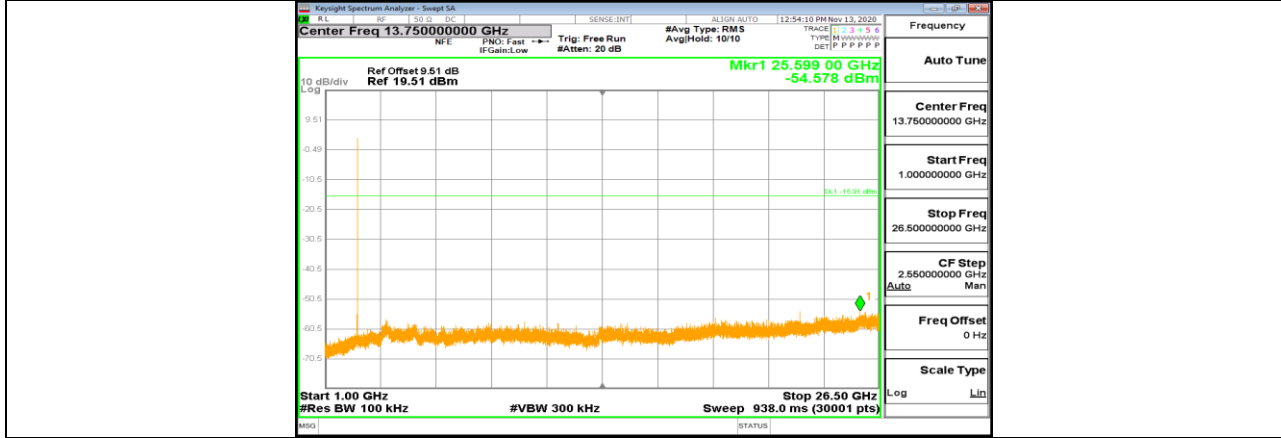

DH5\_Ant1\_2480\_1000-26500

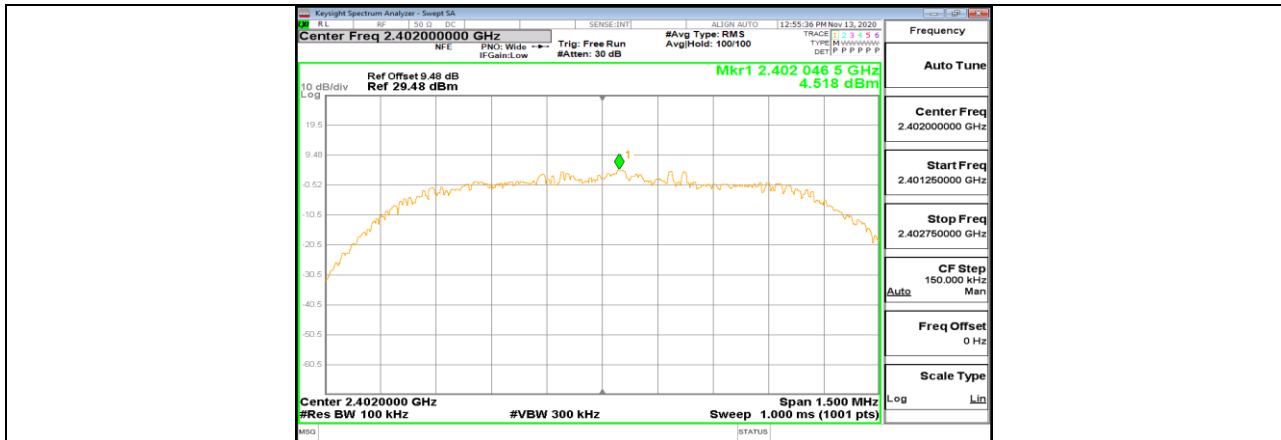

3DH5\_Ant1\_2402\_0~Reference

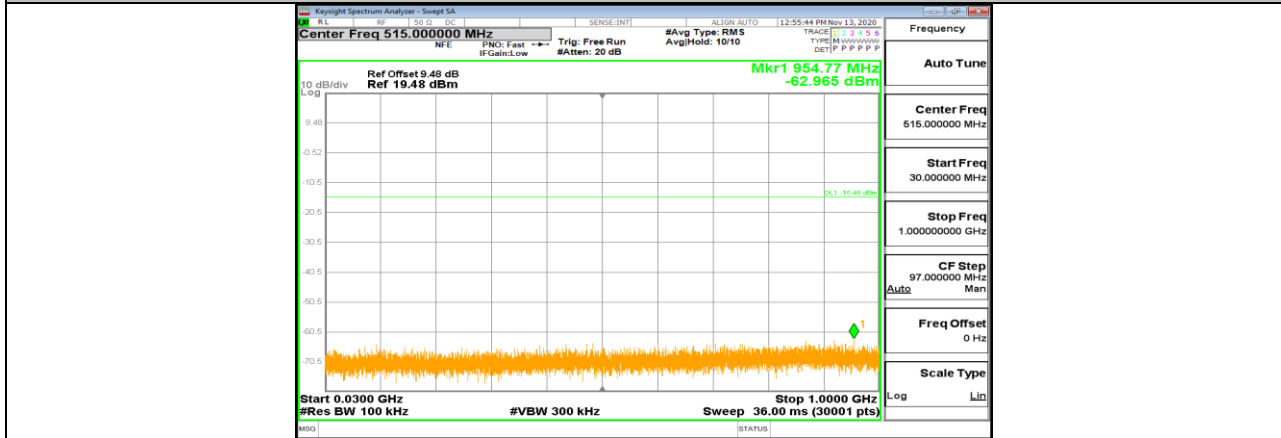

3DH5\_Ant1\_2402\_30~1000

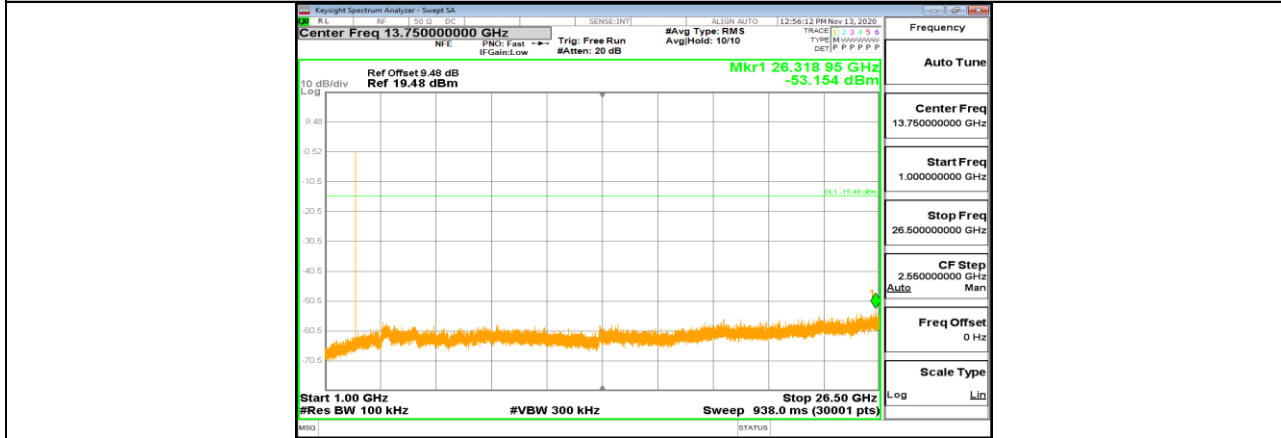

3DH5\_Ant1\_2402\_1000~26500

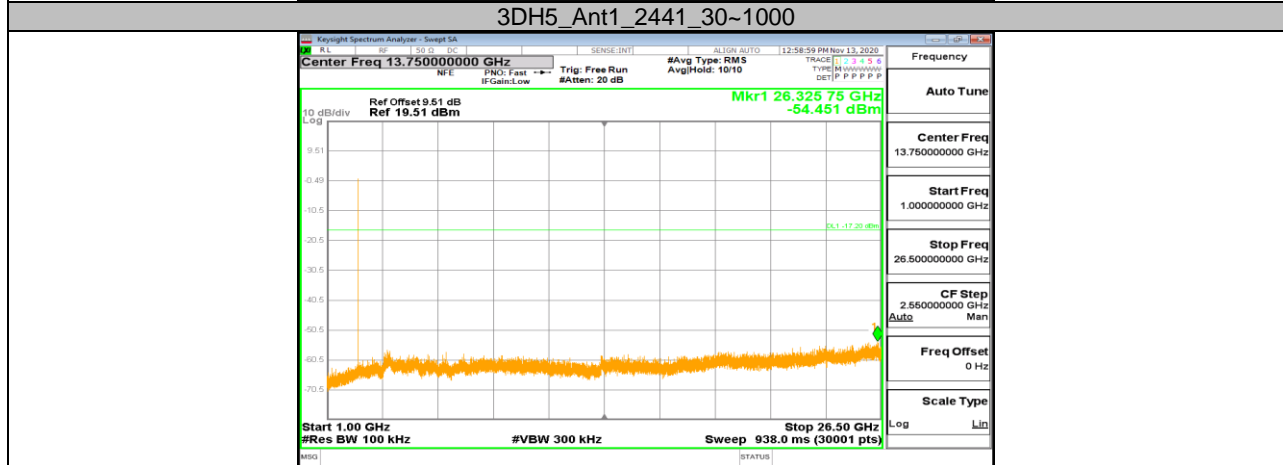
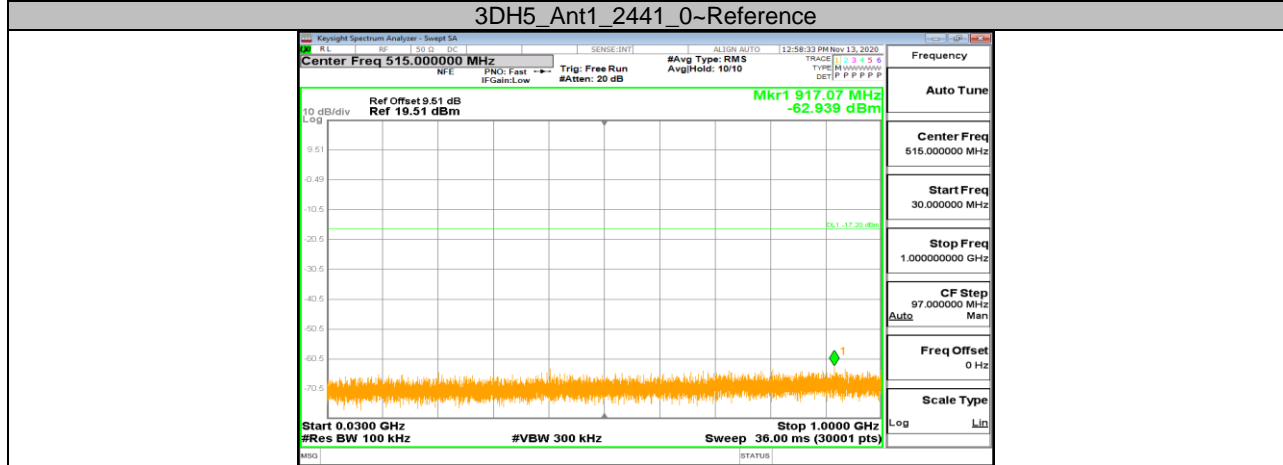
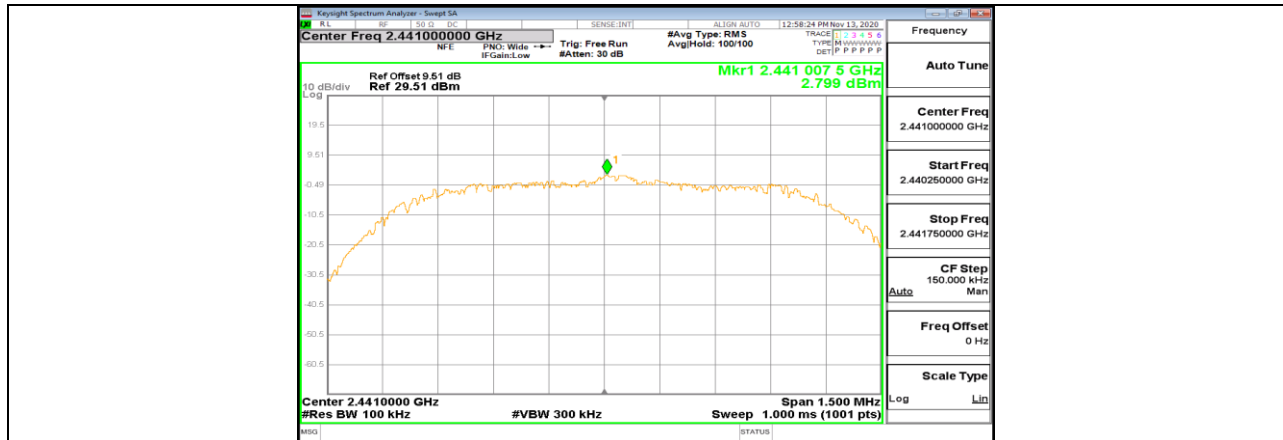

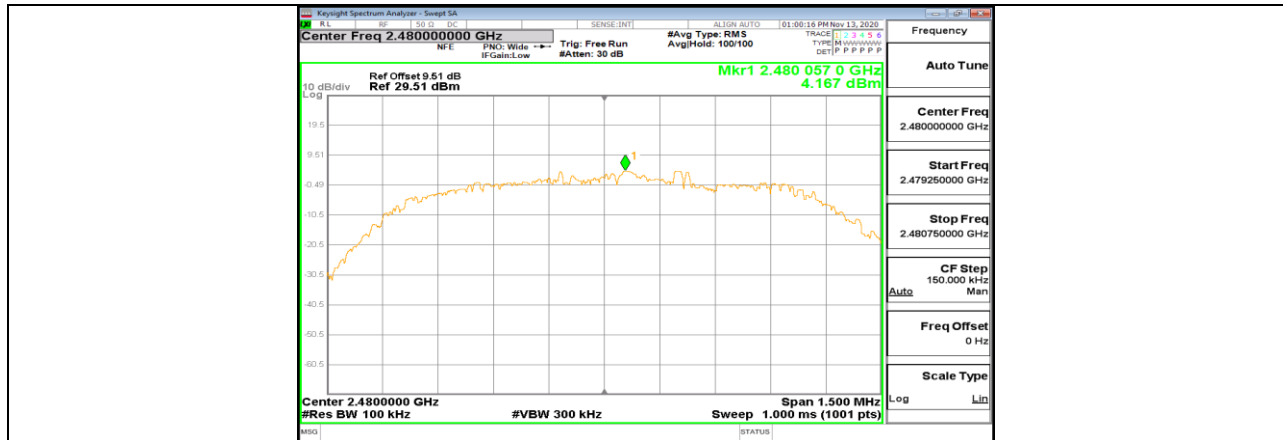

3DH5\_Ant1\_2480\_0~Reference

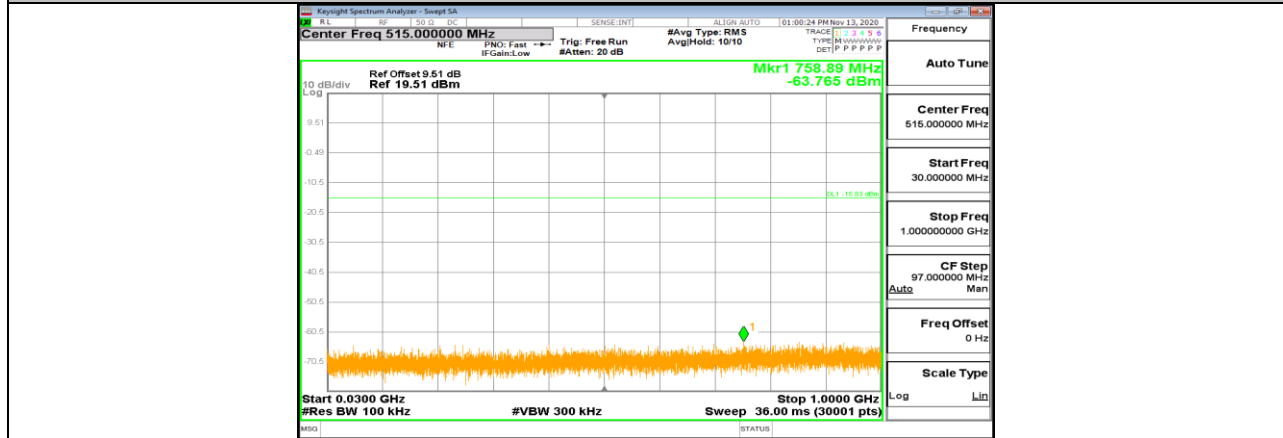

3DH5\_Ant1\_2480\_30~1000

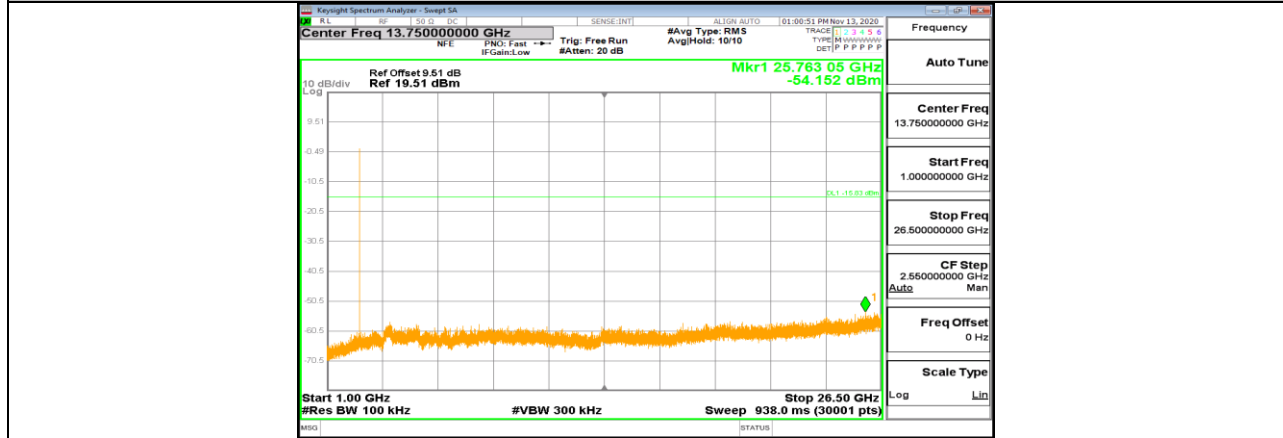

3DH5\_Ant1\_2480\_1000~26500



## Appendix I: Duty Cycle Test Result

Test Packet Type	On Time (msec)	Period (msec)	Duty Cycle x (Linear)	Duty Cycle (%)	Duty Cycle Correction Factor (dB)	1/T Minimum VBW (kHz)	Final setting For VBW (kHz)
DH5	2.88	3.73	0.7721	77.21	1.12	0.35	0.5
3DH5	2.89	3.74	0.7727	77.27	1.12	0.35	0.5

Note:

Duty Cycle Correction Factor=10log (1/x).

Where: x is Duty Cycle (Linear)

Where: T is On Time

If that calculated VBW is not available on the analyzer then the next higher value should be used.

### Test Graphs



DH5\_Ant1\_2441

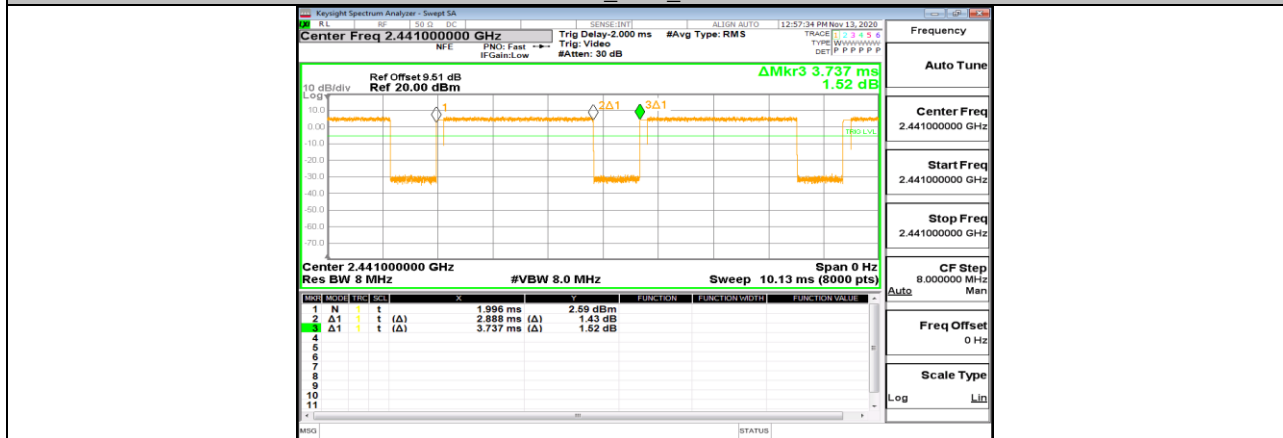

3DH5\_Ant1\_2441

**END OF REPORT**