

FCC CERTIFICATION TEST REPORT

Applicant:	Guangzhou Shirui Electronics Co.,Ltd
Address:	192 Kezhu Road, Sciencetech Park, Guangzhou Economic & Technology Development District, Guangzhou, Guangdong, China
Manufacturer:	Guangzhou Shirui Electronics Co.,Ltd
Address:	192 Kezhu Road, Sciencetech Park, Guangzhou Economic & Technology Development District, Guangzhou, Guangdong, China
Product Description:	Speakerphone
Brand Name:	NA
Tested Model:	BM41
FCC ID:	2AFG6-BM41
Report No.:	JCF220826201-002
Received Date:	Aug. 26, 2022
Tested Date:	Aug. 26, 2022~Sep. 10, 2022
Issued Date:	Sep. 13, 2022
Test Standards:	FCC Rules and Regulations Part 15 Subpart C
Test Procedure :	ANSI C63.10:2013
Test Result:	Pass
Prepared By:	
 <u>Roger Li/Engineer</u>	
	
Reviewed By:	
 <u>Jone Lv/Engineer</u>	
	
Approved By:	
 <u>Talent Zhang/Engineer</u>	
	

Note: The test results in this report apply exclusively to the tested model / sample. Without written approval of Guangzhou Jingce Testing Technology Co., Ltd. the test report shall not be reproduced except in full.

Report Revise Record

Report Version	Revise Time	Issued Date	Valid Version	Notes
V1.0	/	Sep. 13, 2022	Original Report	/

TABLE OF CONTENTS

1. Test Report Declare	5
2. Summary of Test Results	6
3. Test Laboratory	6
4. Equipment Under Test	7
4.1. Description of EUT	7
4.2. Channel List	7
4.3. Test Channel Configuration	7
4.4. Test environment conditions	8
4.5. The Worse Case Power Setting Parameter	8
4.6. Description of Available Antennas	8
5. Description of Test Setup	8
5.1. Accessory	8
5.2. Support Equipment	8
5.3. Test Setup	8
5.4. Setup Diagram for Tests	8
6. Measurement Uncertainty	9
7. Measuring Instrument and Software Used	9
8. On Time and Duty Cycle	11
8.1. Block Diagram of Test Setup	11
8.2. Limits	11
8.3. Procedure	11
8.4. Results	11
8.5. Original Test Data	12
9. 6 dB DTS Bandwidth	14
9.1. Block Diagram of Test Setup	14
9.2. Limits	14
9.3. Test Procedure	14
9.4. Results	14
9.5. Original Test Data	15
10. Peak Conducted Output Power	17
10.1. Block Diagram of Test Setup	17
10.2. Limits	17
10.3. Test Procedure	17
10.4. Results	17
10.5. Original Test Data	18
11. Power Spectral Density	20
11.1. Block Diagram of Test Setup	20
11.2. Limits	20
11.3. Test Procedure	20
11.4. Results	20
11.5. Original Test Data	21
12. Conducted Bandedge and Spurious Emissions	23
12.1. Block Diagram of Test Setup	23
12.2. Limits	23
12.3. Test Procedure	23
12.4. Results	23

12.5. Original test data	25
13. Radiated Emission	31
13.1. Block Diagram of Test Setup	31
13.2. Limit	32
13.3. Test Procedure	34
13.4. Results	37
13.5. Original Test Data	37
14. AC Power Line Conducted Emissions	38
14.1. Block Diagram of Test Setup	38
14.2. Limits	38
14.3. Test Procedure	38
14.4. Test Result	39
14.5. Original Test Data	39
15. Antenna Requirements	40
15.1. Limits	40
15.2. Result	40
APPENDIX A – Radiated Emission Below 1GHz Test Data	41
APPENDIX B – Radiated Emission Above 1GHz Test Data	43
APPENDIX C – AC Power Line Conducted Emission Test Data	53

1. Test Report Declare

Applicant:	Guangzhou Shirui Electronics Co.,Ltd
Address:	192 Kezhu Road, Sciencetech Park, Guangzhou Economic & Technology Development District, Guangzhou, Guangdong, China
Manufacturer:	Guangzhou Shirui Electronics Co.,Ltd
Address:	192 Kezhu Road, Sciencetech Park, Guangzhou Economic & Technology Development District, Guangzhou, Guangdong, China
Product Name:	Speakerphone
Brand Name:	NA
Model Name:	BM41, BMxx(x: 0~9, A~Z, Blank)
Difference Description:	The products with all the models covered in this report are the same as each other, except for different model number and market region.

We Declare:

The equipment described above is tested by Guangzhou Jingce Testing Technology Co., Ltd. and in the configuration tested the equipment complied with the standards specified above. The test results are contained this test report and Guangzhou Jingce Testing Technology Co., Ltd. is assumed of full responsibility for the accuracy and completeness of these tests.

2. Summary of Test Results

Summary of Test Results			
Clause	Test Items	FCC/ISED Rules	Test Results
1	6 dB Bandwidth	FCC Part 15.247 (a) (2)	Pass
2	Peak Conducted Output Power	FCC Part 15.247 (b) (3)	Pass
3	Power Spectral Density	FCC Part 15.247 (e)	Pass
4	Conducted Bandedge and Spurious Emission	FCC Part 15.247 (d)	Pass
5	Radiated Bandedge and Spurious Emission	FCC Part 15.247 (d) FCC Part 15.209 FCC Part 15.205	Pass
6	Conducted Emission Test For AC Power Port	FCC Part 15.207	Pass
7	Antenna Requirement	FCC Part 15.203	Pass

3. Test Laboratory

Guangzhou Jingce Testing Technology Co., Ltd.

Add.: No.192, Kezhu Road, Huangpu District, Guangzhou, Guangdong, China

Association for Laboratory Accreditation(A2LA). Certificate Number: 6594.01

FCC Designation Number:CN1331. Test Firm Registration Number: 360543

IC Test Firm Registration Number: 28796

Conformity Assessment Body identifier: CN0138

4. Equipment Under Test

4.1. Description of EUT

EUT Name:	Speakerphone
Model Number:	BM41
EUT Function Description:	Please reference user's manual
Power Supply:	DC 5V from Adapter DC 3.7V from Battery
Hardware Version:	V1.1
Software Version:	220805180611_BT1_V6.8
Radio Specification:	Bluetooth V5.3
Operation Frequency:	2402 MHz - 2480 MHz
Modulation:	GFSK
Data Rate:	1Mbps
Antenna Type:	PCB Antenna, 1.72 dBi

Note 1: EUT is the ab. of equipment under test.

Note 2: The antenna gain is declared by the customer and the laboratory is not responsible for the accuracy of the antenna gain.

4.2. Channel List

Channel	Frequency (MHz)	Channel	Frequency (MHz)	Channel	Frequency (MHz)	Channel	Frequency (MHz)
0	2402	11	2424	22	2446	33	2468
1	2404	12	2426	23	2448	34	2470
2	2406	13	2428	24	2450	35	2472
3	2408	14	2430	25	2452	36	2474
4	2410	15	2432	26	2454	37	2476
5	2412	16	2434	27	2456	38	2478
6	2414	17	2436	28	2458	39	2480
7	2416	18	2438	29	2460	/	/
8	2418	19	2440	30	2462	/	/
9	2420	20	2442	31	2464	/	/
10	2422	21	2444	32	2468	/	/

4.3. Test Channel Configuration

Tested mode, channel, information		
Mode	Channel	Frequency (MHz)
GFSK	LCH:CH0	2402
	MCH:CH19	2440
	HCH:CH39	2480

4.4. Test environment conditions

During the measurement the environmental conditions were within the listed ranges:

Temperature range:	21-25 °C
Humidity range:	40-75%
Pressure range:	86-106 kPa

4.5. The Worst Case Power Setting Parameter

The Worst Case Power Setting Parameter under 2400 ~ 2483.5MHz Band				
Test Software		FCC Assist 1.0.2.2		
Modulation Type	Transmit Antenna Number	Test Software Setting Value		
		CH 00	CH 39	CH 78
GFSK	1	Default	Default	Default

4.6. Description of Available Antennas

Test Mode	Transmit and Receive Mode	Description
GFSK	<input checked="" type="checkbox"/> 1TX, 1RX	Antenna 1 can be used as transmitting/receiving antenna.

5. Description of Test Setup

5.1. Accessory

Description of Accessories	Manufacturer	Model Number	Description	Remark
USB-C Cable	/	/	1.0m	Shielded

5.2. Support Equipment

Equipment	Brand Name	Model Name	P/N
PC	Lenovo	T480	/
Adapter	FlyPower	PS10K050K2000CU	/

5.3. Test Setup

The EUT can work in fixed frequency.

5.4. Setup Diagram for Tests



6. Measurement Uncertainty

Where relevant, the following measurement uncertainty levels have been estimated for tests performed on the apparatus:

Test Item	Uncertainty
AC Power Conduction emission	1.37 dB
All Radiated emissions	5.4dB
Conducted emissions	3.09 dB
Occupied Channel Bandwidth	1.1%
Conducted Output power	0.82dB
Power Spectral Density	0.82dB

Note: This uncertainty represents an expanded uncertainty expressed at approximately the 95 % confidence level using a coverage factor of k = 2.

7. Measuring Instrument and Software Used

TS Test System						
Used	Equipment	Manufacturer	Model No.	Serial No.	Last Cal.	Due. Date
<input checked="" type="checkbox"/>	Spectrum Analyzer	Keysight	N9030B	MY56320512	Jul.25,2022	Jul.24,2023
<input checked="" type="checkbox"/>	Vector Signal Generator	Keysight	N5182B	MY57300334	Dec.03,2021	Dec.02,2022
<input checked="" type="checkbox"/>	Signal Generator	Keysight	N5171B	MY57280639	Dec.03,2021	Dec.02,2022
<input checked="" type="checkbox"/>	DC POWER	Keysight	E342A	MY59020356	Jul.25,2022	Jul.24,2023
<input checked="" type="checkbox"/>	Incubator thermometer	GWS	EL-02JA	21107288	Nov.05,2021	Nov.04,2022
<input checked="" type="checkbox"/>	Control unit(Power sensor)	Tonscend	JS0806-2	/	Aug.25,2021	Aug.24,2022
Software						
Used	Description	Manufacturer	Name	Version		
<input checked="" type="checkbox"/>	Test software	TS+	JS1120-3	V3.2.11		
RSE Test System						
Used	Equipment	Manufacturer	Model No.	Serial No.	Last Cal.	Due. Date
<input checked="" type="checkbox"/>	EMI Receiver	R&S	ESW	101685	Jul.24,2022	Jul.23,2023
<input checked="" type="checkbox"/>	Bilog Antenna	Schwarzbeck	VULB 9163	01416	Feb.22,2022	Feb.21,2023
<input checked="" type="checkbox"/>	Horn Antenna 1	Schwarzbeck	BBHA 9120 D	02411	May.30,2022	May.29,2023
<input checked="" type="checkbox"/>	Horn Antenna 2	ETS	3116C	00217677	Aug.27,2022	Aug.26,2023
<input checked="" type="checkbox"/>	Signal Pre-Amplifier	Tonscend	TAP01018050	AP21C806122	Aug.08,2022	Aug.07,2023
<input checked="" type="checkbox"/>	Signal Pre-Amplifier	Tonscend	TAP9K3G32	AP20K806104	Aug.08,2022	Aug.07,2023
<input checked="" type="checkbox"/>	Signal Pre-Amplifier	ETS	3116C-PA	00217677	Sep.29,2021	Sep.28,2022

<input checked="" type="checkbox"/>	Wideband radio communication tester	R&S	CMW500	163478	Jul.25,2022	Jul.24,2023
<input checked="" type="checkbox"/>	3m Fully-anechoic Chamber	ETS	RFD-100	/	Apr.24,2021	Apr.23,2024
Software						
Used	Description	Manufacturer	Name	Version		
<input checked="" type="checkbox"/>	Test software	TS+	TS+	V3.0.0.4		
Conducted Emission Test For AC Power Port						
Used	Equipment	Manufacturer	Model No.	Serial No.	Last Cal.	Due. Date
<input checked="" type="checkbox"/>	LISN	R&S	ENV216	102154	Jul.24,2022	Jul.23,2023
<input checked="" type="checkbox"/>	EMI Receiver	R&S	ESR3	102509	Jul.24,2022	Jul.23,2023
Software						
Used	Description	Manufacturer	Name	Version		
<input checked="" type="checkbox"/>	Test software	EZ	EZ-EMC	EMEC-3A1		
Other Instrument						
Used	Equipment	Manufacturer	Model No.	Serial No.	Last Cal.	Due. Date
<input checked="" type="checkbox"/>	Temperature & Humidity	Temperature	HTC-1	/	Jan.24,2022	Jan.23,2023

8. On Time and Duty Cycle

8.1. Block Diagram of Test Setup

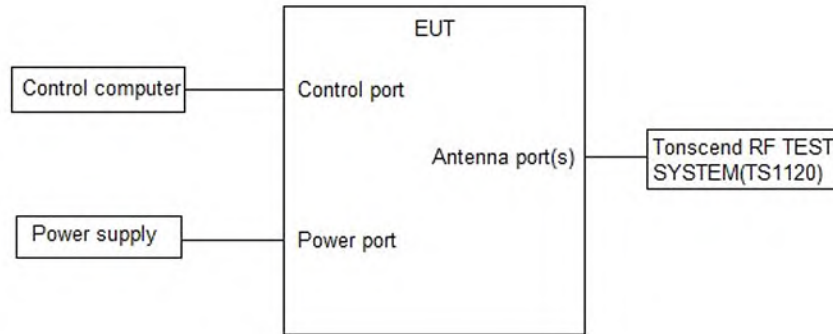

8.2. Limits

None; for reporting purposes only

8.3. Procedure

KDB 558074 Zero-Span Spectrum Analyzer Method

8.4. Results

Test Mode	Ant.	Freq. (MHz)	ON Time (ms)	Period (ms)	Duty Cycle (%)	Duty Cycle Factor(dB)
BLE_1M	Ant1	2402	2.14	2.50	85.60	0.68
		2440	2.14	2.50	85.60	0.68
		2480	2.13	2.50	85.20	0.70

Note: Duty Cycle Correction Factor = $10\log(1/x)$.

Where: x is Duty Cycle(Linear)

Where: T is On Time (transmit duration)

If that calculated VBW is not available on the analyzer, then the next higher value should be used.

8.5. Original Test Data

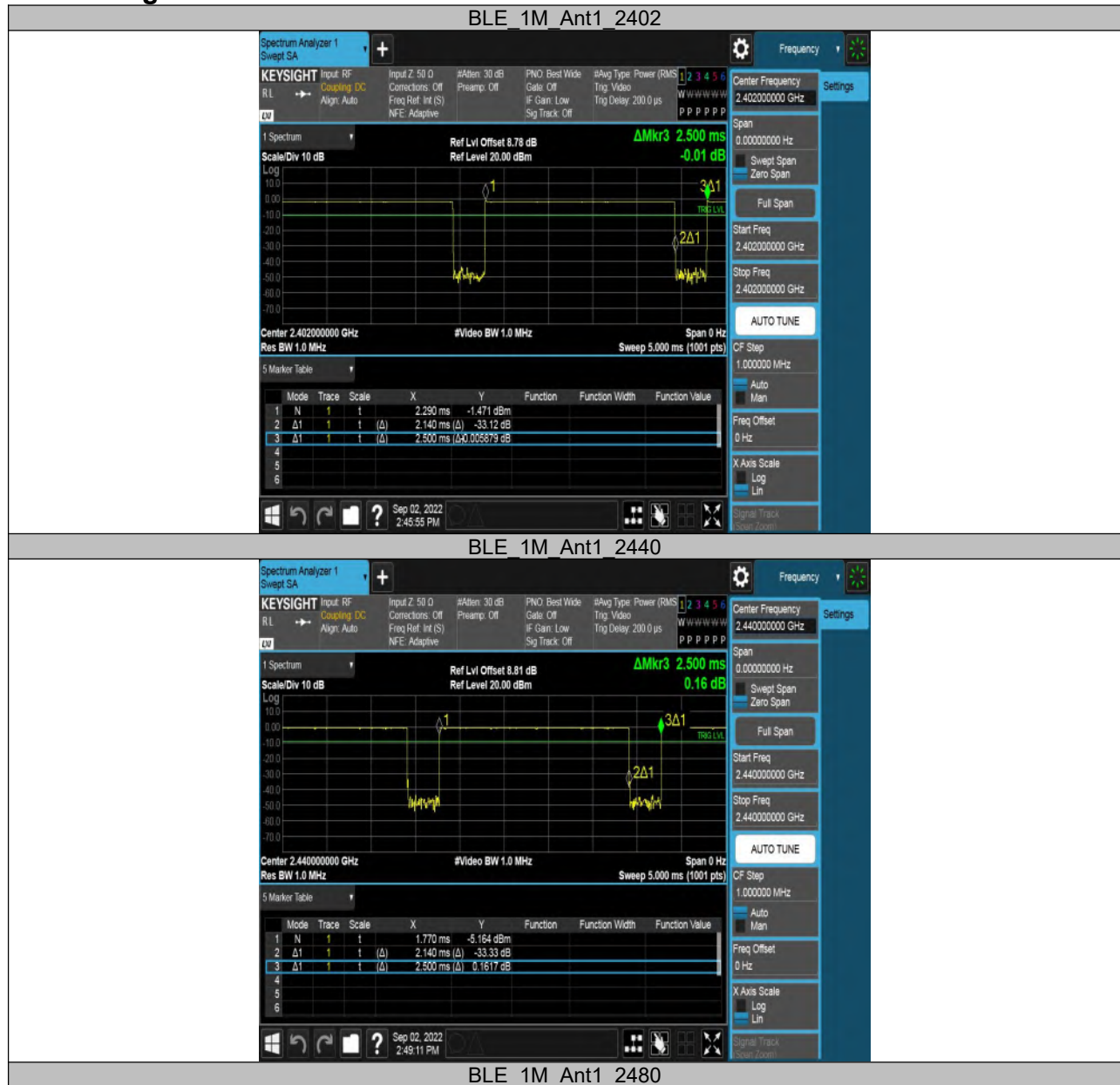



9. 6 dB DTS Bandwidth

9.1. Block Diagram of Test Setup

Same as section 8.1

9.2. Limits

CFR 47FCC Part15 (15.247) Subpart C			
Section	Test Item	Limit	Frequency Range (MHz)
CFR 47 FCC 15.247(a)(2)	6 dB Bandwidth	>= 500 kHz	2400-2483.5

9.3. Test Procedure

Connect the UUT to the spectrum analyzer and use the following settings:

Center Frequency	The center frequency of the channel under test
Detector	Peak
RBW	For 6 dB Bandwidth :100 kHz
VBW	For 6 dB Bandwidth : $\geq 3 \times$ RBW
Trace	Max hold
Sweep	Auto couple

Allow the trace to stabilize and measure the maximum width of the emission that is constrained by the frequencies associated with the two outermost amplitude points (upper and lower frequencies) that are attenuated by 6 dB relative to the maximum level measured in the fundamental emission.

9.4. Results

Test Mode	Ant.	Freq. (MHz)	DTS BW (MHz)	FL (MHz)	FH (MHz)	Limit (MHz)	Verdict
BLE_1M	Ant1	2402	0.656	2401.688	2402.344	0.5	PASS
		2440	0.692	2439.660	2440.352	0.5	PASS
		2480	0.652	2479.688	2480.340	0.5	PASS

9.5. Original Test Data

6 dB bandwidth:





10. Peak Conducted Output Power

10.1. Block Diagram of Test Setup

Same as section 8.1

10.2. Limits

CFR 47 FCC Part15 (15.247) Subpart C			
Section	Test Item	Limit	Frequency Range (MHz)
CFR 47 FCC 15.247(b)(3)	Peak Output Power	1 watt or 30 dBm	2400 - 2483.5

10.3. Test Procedure

(1) Connect EUT's antenna output to spectrum analyzer by RF cable.

(2) Measure the maximum output power of EUT by spectrum analyzer with PK detector and RBW=2 MHz (above 20 dB bandwidth of measured signal), VBW=6 MHz

Note: The attenuator loss was inputted into spectrum analyzer as amplitude offset.

10.4. Results

Test Mode	Ant.	Freq (MHz)	Conducted Peak Power (dBm)	Conducted Limit (dBm)	Verdict
BLE_1M	Ant1	2402	-1.36	≤30	PASS
		2440	-0.29	≤30	PASS
		2480	0.05	≤30	PASS

10.5. Original Test Data

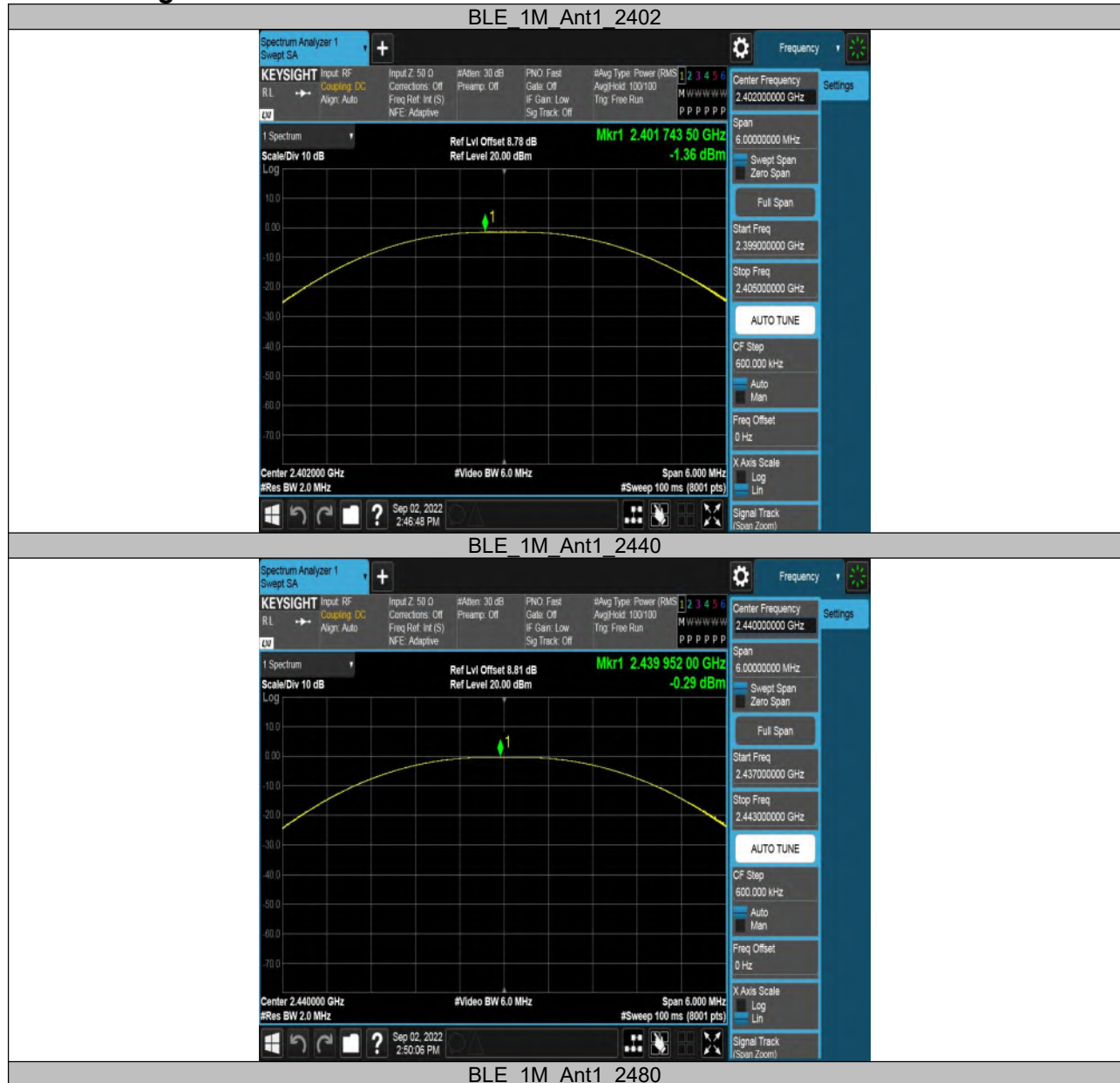

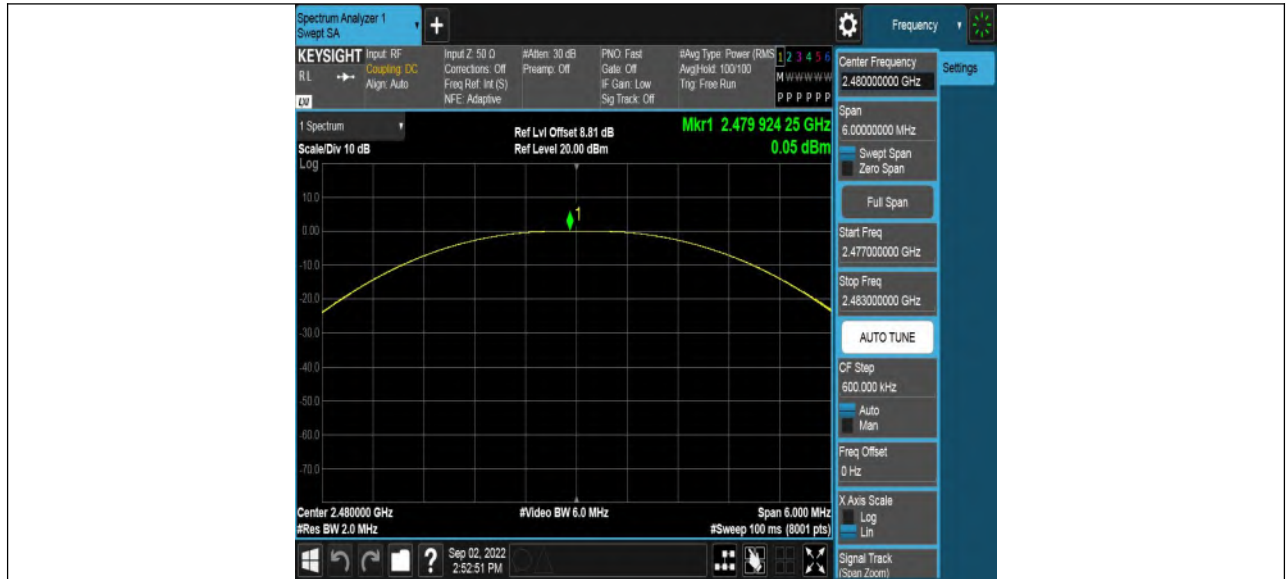

11. Power Spectral Density

11.1. Block Diagram of Test Setup

Same as section 8.1

11.2. Limits

CFR 47 FCC Part15 (15.247) Subpart C			
Section	Test Item	Limit	Frequency Range (MHz)
CFR 47 FCC §15.247 (e)	Power Spectral Density	8 dBm in any 3 kHz band	2400 - 2483.5

11.3. Test Procedure

Connect the UUT to the spectrum analyzer and use the following settings:

Center Frequency	The center frequency of the channel under test
Detector	Peak
RBW	$3 \text{ kHz} \leq \text{RBW} \leq 100 \text{ kHz}$
VBW	$\geq 3 \times \text{RBW}$
Span	1.5 x DTS bandwidth
Trace	Max hold
Sweep time	Auto couple.

Allow trace to fully stabilize and use the peak marker function to determine the maximum amplitude level within the RBW.

If measured value exceeds limit, reduce RBW (no less than 3 kHz) and repeat.

11.4. Results

Test Mode	Ant.	Freq. (MHz)	Result (dBm/3kHz)	Limit (dBm/3kHz)	Verdict
BLE_1M	Ant1	2402	-17.89	≤ 8.00	PASS
		2440	-17.04	≤ 8.00	PASS
		2480	-16.67	≤ 8.00	PASS

11.5. Original Test Data

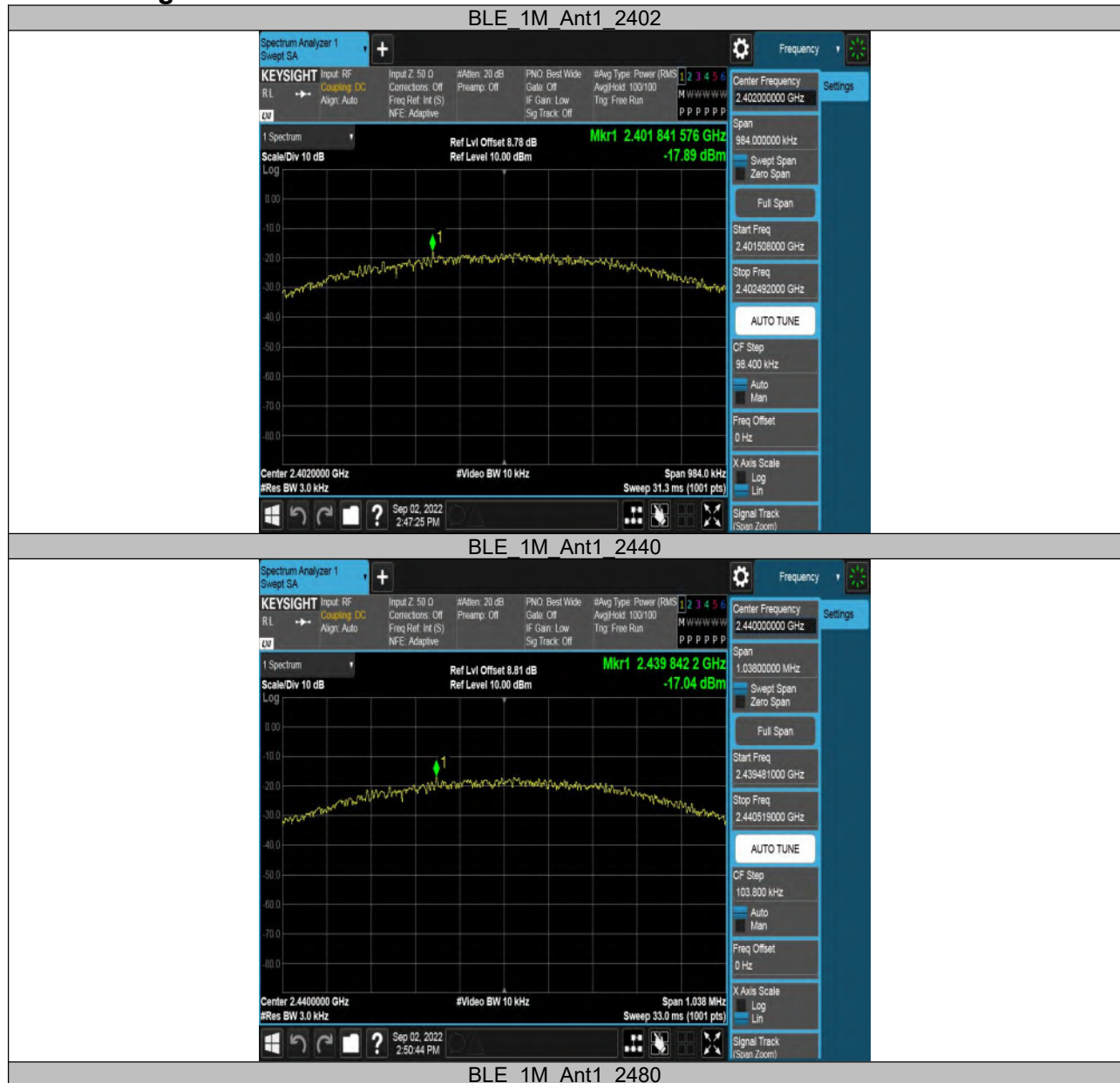

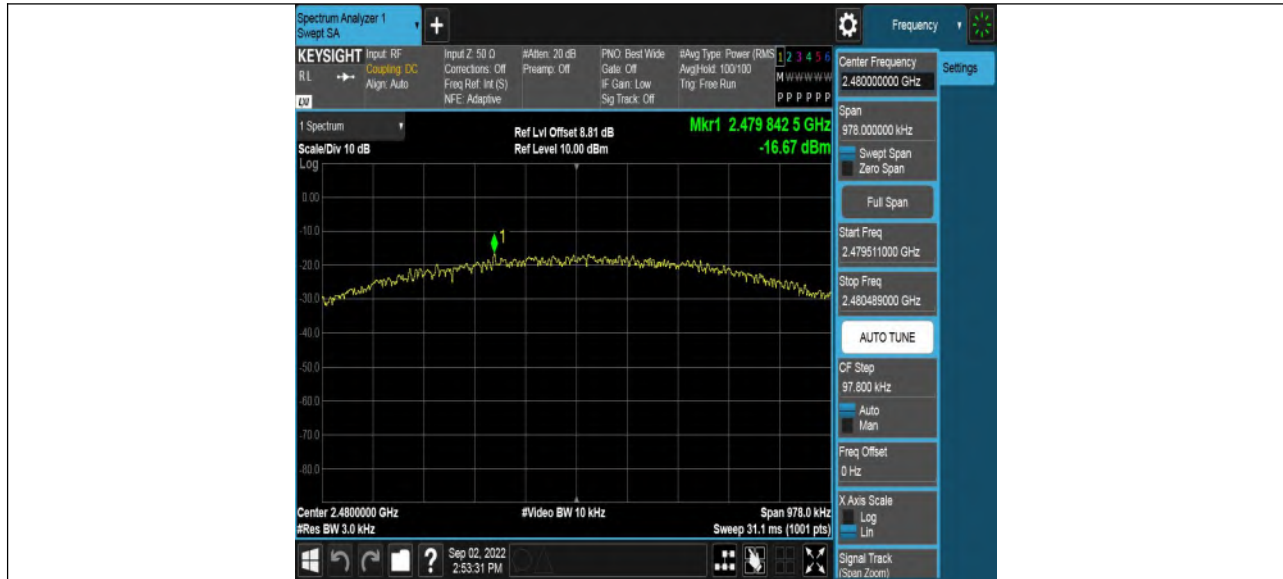

12. Conducted Bandedge and Spurious Emissions

12.1. Block Diagram of Test Setup

Same as section 8.1

12.2. Limits

CFR 47 FCC Part15 (15.247) Subpart C		
Section	Test Item	Limit
CFR 47 FCC §15.247 (d)	Conducted Band edge and Spurious Emissions	at least 20 dB below that in the 100 kHz bandwidth within the band that contains the highest level of the desired power

12.3. Test Procedure

Center Frequency	The center frequency of the channel under test
Detector	Peak
RBW	100 kHz
VBW	$\geq 3 \times \text{RBW}$
Span	$\geq 1.5 \times \text{DTS bandwidth}$
Trace	Max hold
Sweep time	Auto couple

Connect the UUT to the spectrum analyzer and use the following settings:

Use the peak marker function to determine the maximum peak power level to establish the reference level.

Span	Set the center frequency and span to encompass frequency range to be measured
Detector	Peak
RBW	100 kHz
VBW	$\geq 3 \times \text{RBW}$
measurement points	$\geq \text{span}/\text{RBW}$
Trace	Max hold
Sweep time	Auto couple

Use the peak marker function to determine the maximum amplitude level.

12.4. Results

Band edge

Test Mode	Ant.	Ch Name	Freq. (MHz)	Ref Level (dBm)	Result (dBm)	Limit (dBm)	Verdict
BLE_1M	Ant1	Low	2402	-1.63	-51.49	≤ -21.63	PASS
		High	2480	-0.18	-50.51	≤ -20.18	PASS

Spurious Emissions

Test Mode	Ant.	Freq. (MHz)	Freq Range (MHz)	Ref Level (dBm)	Result (dBm)	Limit (dBm)	Verdict
BLE_1M	Ant1	2402	30~1000	-1.63	-64.01	≤-21.63	PASS
			1000~26500	-1.63	-55.42	≤-21.63	PASS
		2440	30~1000	-0.62	-63.41	≤-20.62	PASS
			1000~26500	-0.62	-53.07	≤-20.62	PASS
		2480	30~1000	-0.18	-64.23	≤-20.18	PASS
			1000~26500	-0.18	-53.67	≤-20.18	PASS

12.5. Original test data

Reference level





Band edge:

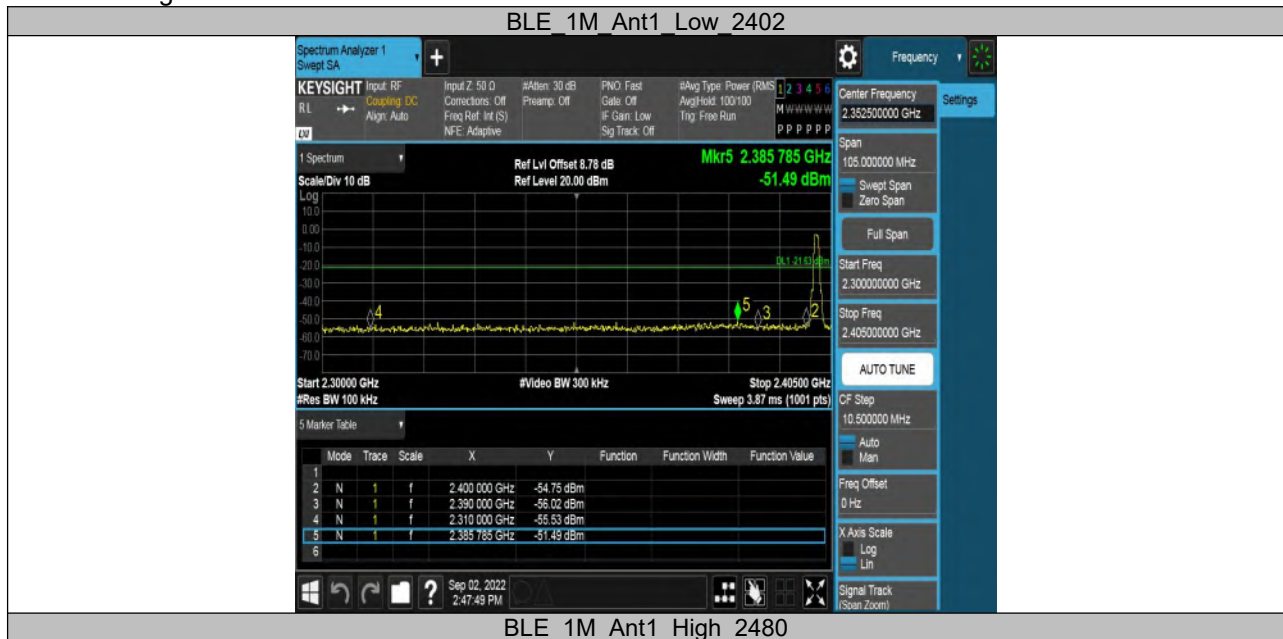

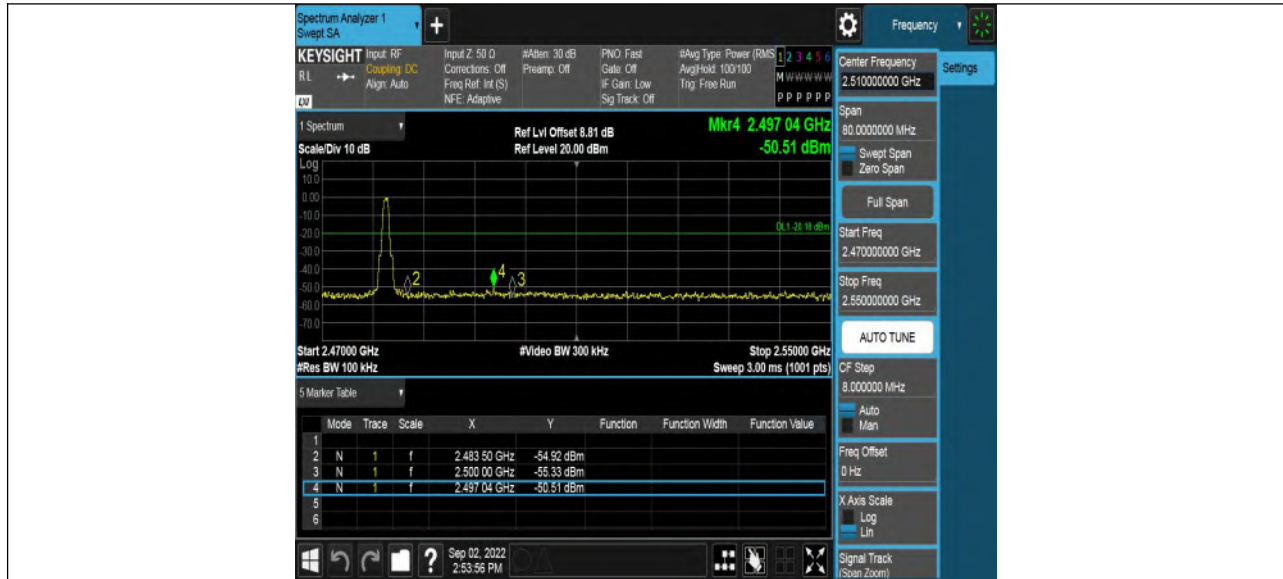

Spurious Emissions:

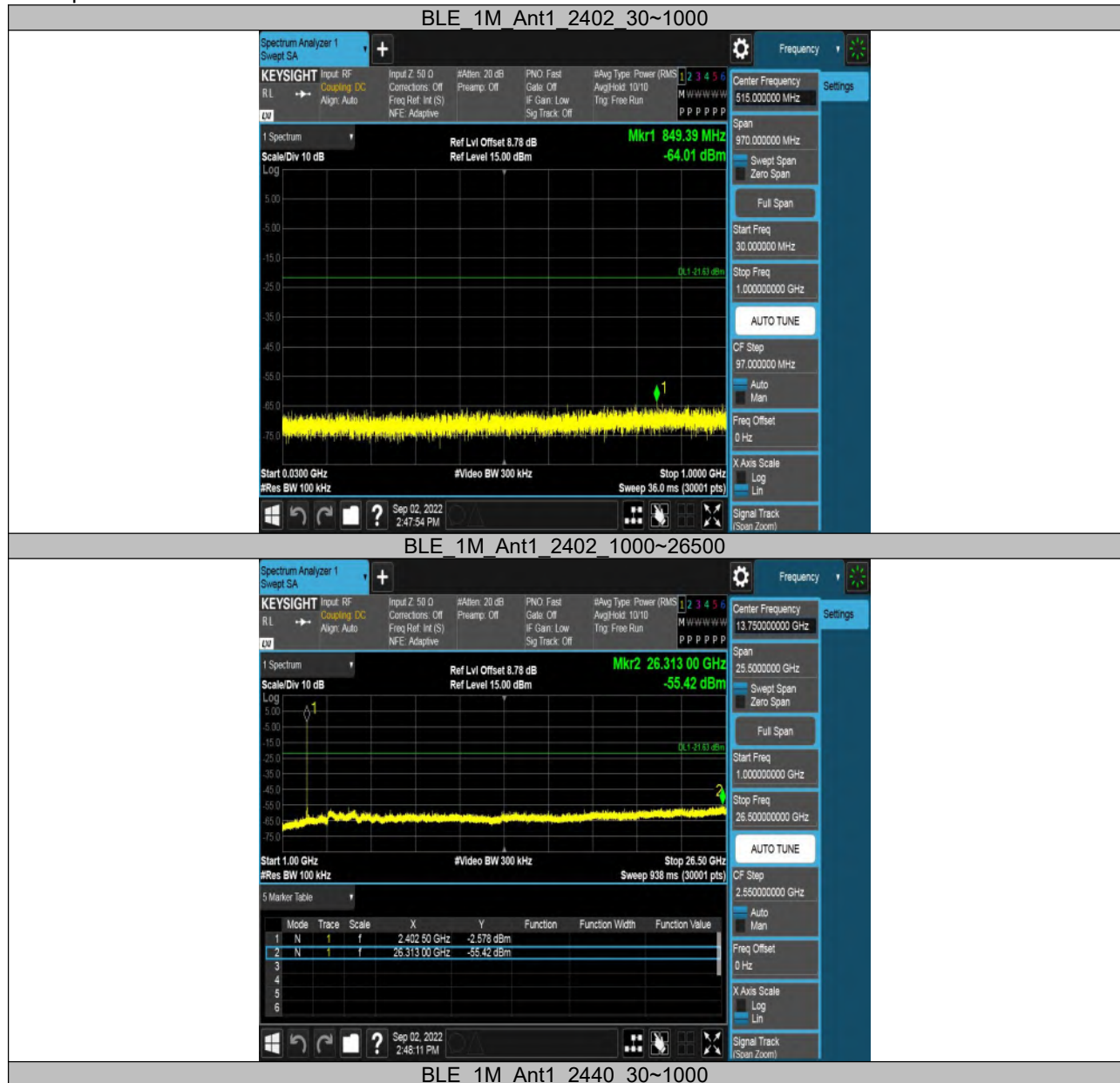

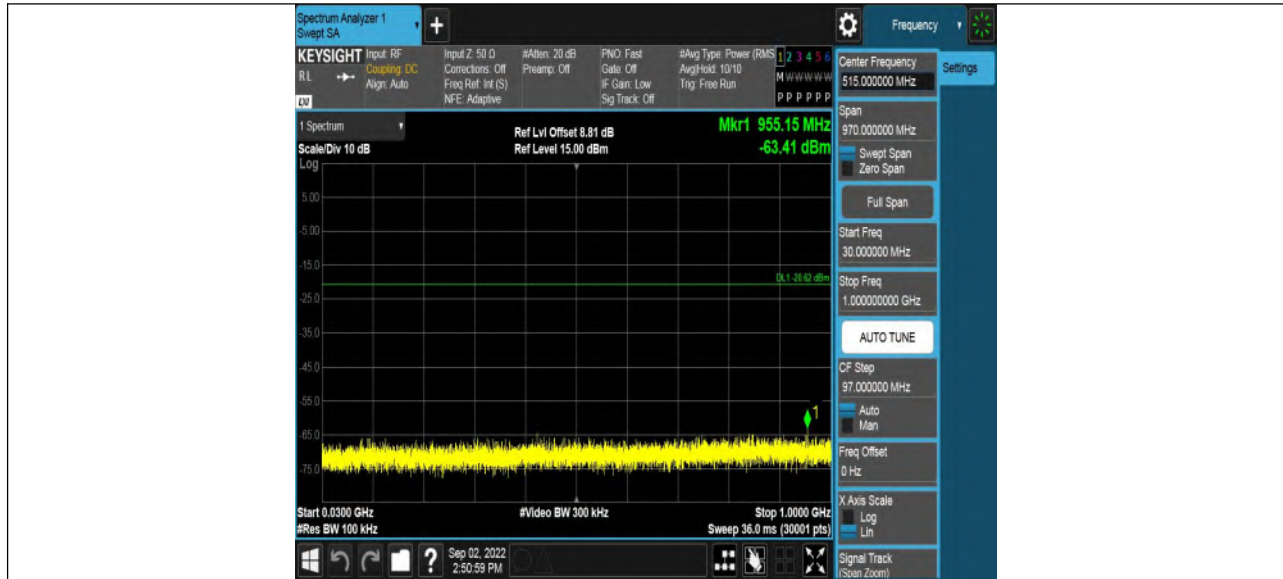

BLE 1M Ant1 2440 1000~26500



BLE 1M Ant1 2480 30~1000

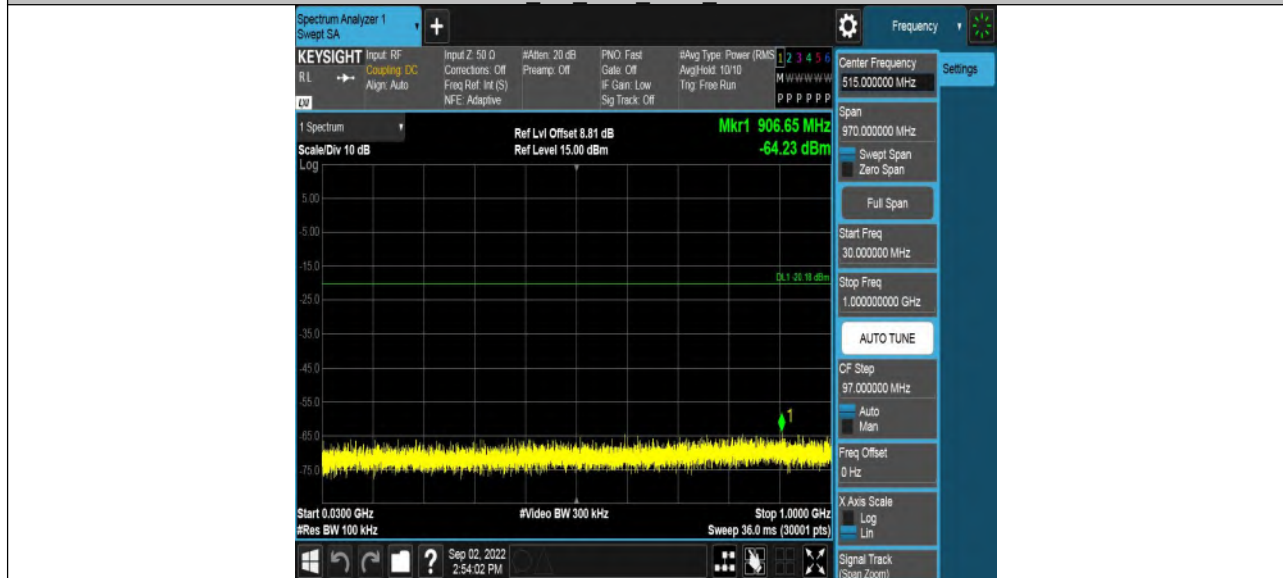

BLE 1M Ant1 2480 1000~26500



13. Radiated Emission

13.1. Block Diagram of Test Setup

In 3 m Anechoic Chamber, test setup diagram for 9 kHz - 30 MHz:

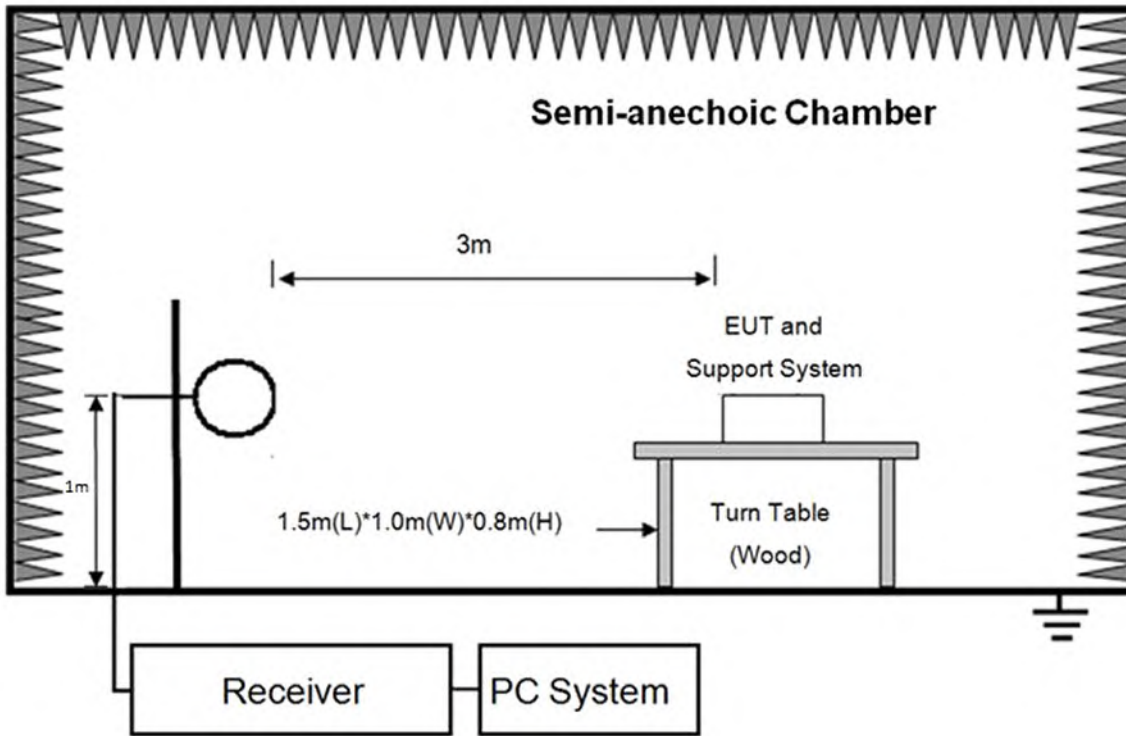

In 3 m Anechoic Chamber, test setup diagram for 30 MHz - 1 GHz:

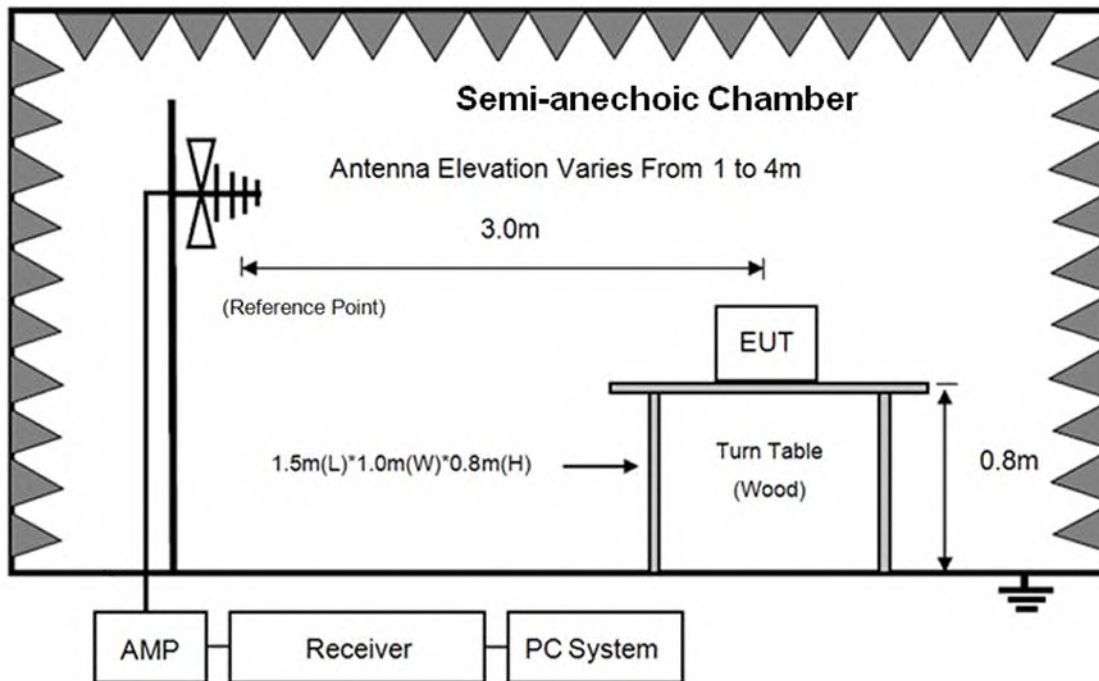

In 3 m Anechoic Chamber, test setup diagram for frequency above 1 GHz:

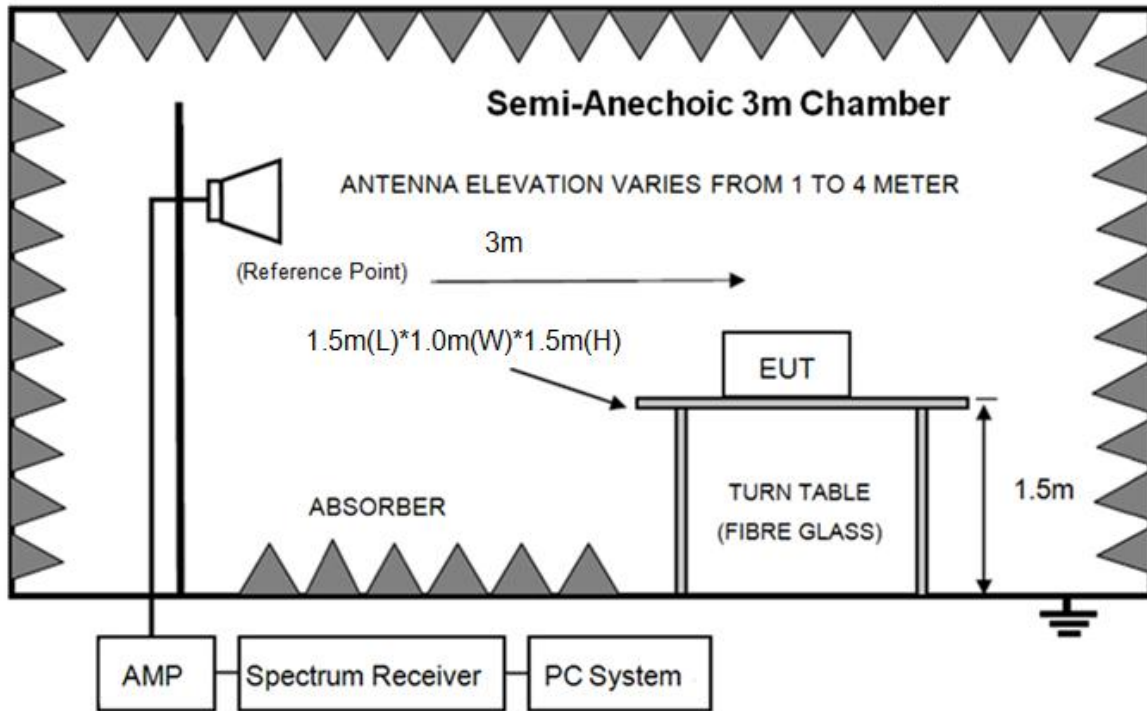

Note: For harmonic emissions test an appropriate high pass filter was inserted in the input port of AMP.

13.2. Limit

(1) FCC 15.205 Restricted frequency band

MHz	MHz	MHz	GHz
0.090-0.110	16.42-16.423	399.9-410	4.5-5.15
0.495-0.505	16.69475-16.69525	608-614	5.35-5.46
2.1735-2.1905	16.80425-16.80475	960-1240	7.25-7.75
4.125-4.128	25.5-25.67	1300-1427	8.025-8.5
4.1772&4.17775	37.5-38.25	1435-1626.5	9.0-9.2
4.2072&4.20775	73-74.6	1645.5-1646.5	9.3-9.5
6.215-6.218	74.8-75.2	1660-1710	10.6-12.7
6.26775-6.26825	108-121.94	1718.8-1722.2	13.25-13.4
6.31175-6.31225	123-138	2200-2300	14.47-14.5
8.291-8.294	149.9-150.05	2310-2390	15.35-16.2
8.362-8.366	156.52475-156.52525	2483.5-2500	17.7-21.4
8.37625-8.38675	156.7-156.9	2690-2900	22.01-23.12
8.41425-8.41475	162.0125-167.17	3260-3267	23.6-24.0
12.29-12.293	167.72-173.2	3332-3339	31.2-31.8
12.51975-12.52025	240-285	3345.8-3358	36.43-36.5
12.57675-12.57725	322-335.4	3600-4400	(²)
13.36-13.41			

¹Until February 1, 1999, this restricted band shall be 0.490-0.510 MHz.

²Above 38.6

(2) FCC 15.209 Limit.

Frequency MHz	Distance Meters	Field Strengths Limit	
		$\mu\text{V}/\text{m}$	$\text{dB}(\mu\text{V})/\text{m}$
0.009 ~ 0.490	300	$2400/F(\text{kHz})$	$67.6-20\log(F)$
0.490 ~ 1.705	30	$24000/F(\text{kHz})$	$87.6-20\log(F)$
1.705 ~ 30.0	30	30	29.54
30 ~ 88	3	100	40.0
88 ~ 216	3	150	43.5
216~960	3	200	46.0
960~1000	3	500	54.0
Above 1000	3	74.0 $\text{dB}(\mu\text{V})/\text{m}$ (Peak) 54.0 $\text{dB}(\mu\text{V})/\text{m}$ (Average)	

Note: (1) At frequencies at or above 30 MHz, measurements may be performed at a distance other than what is specified provided: measurements are not made in the near field except where it can be shown that near field measurements are appropriate due to the characteristics of the device; and it can be demonstrated that the signal levels needed to be measured at the distance employed can be detected by the measurement equipment. Measurements shall not be performed at a distance greater than 30 meters unless it can be further demonstrated that measurements at a distance of 30 meters or less are impractical. When performing measurements at a distance other than that specified, the results shall be extrapolated to the specified distance using an extrapolation factor of 20 dB/decade (inverse linear-distance for field strength measurements; inverse-linear-distance-squared for power density measurements).

(2) At frequencies below 30 MHz, measurements may be performed at a distance closer than that specified in the regulations; however, an attempt should be made to avoid making measurements in the near field. Pending the development of an appropriate measurement procedure for measurements performed below 30 MHz, when performing measurements at a closer distance than specified, the results shall be extrapolated to the specified distance by either making measurements at a minimum of two distances on at least one radial to determine the proper extrapolation factor or by using the square of an inverse linear distance extrapolation factor (40 dB/decade). This paragraph (f) shall not apply to Access BPL devices operating below 30 MHz.

About Restricted bands of operation please refer to FCC § 15.205(a),

13.3. Test Procedure

Below 30 MHz:

The setting of the spectrum Analyzer

RBW	200 Hz (From 9 kHz to 0.15 MHz)/ 9 kHz (From 0.15 MHz to 30 MHz)
VBW	200 Hz (From 9 kHz to 0.15 MHz)/ 9 kHz (From 0.15 MHz to 30 MHz)
Sweep	Auto
Trace	Max hold

1. The testing follows the guidelines in ANSI C63.10-2013
2. The EUT was arranged to its worst case and then turntable (from 0 degree to 360 degrees) to find the maximum reading. A pre-amp and a high pass filter are used for the test in order to get better signal level. Both Horizontal, Face-on and Face-off polarizations of the antenna are set to make the measurement.
3. The EUT was placed on a turntable with 80 cm meter above ground.
4. The EUT was set 3 meters from the interference receiving antenna, which was mounted on the top of 1 meter height antenna tower.
5. The radiated emission limits are based on measurements employing a CISPR quasi-peak detector except for the frequency bands 9-90 kHz, 110-490 kHz and above 1000 MHz. Radiated emission limits in these three bands are based on measurements employing an average detector.
6. For measurement below 1 GHz, the initial step in collecting conducted emission data is a spectrum analyzer peak detector mode pre-scanning the measurement frequency range. Significant peaks are then marked and then Quasi Peak detector mode re-measured. If the emission level of the EUT measured by the peak detector is 3 dB lower than the applicable limit, the peak emission level will be reported. Otherwise, the emission measurement will be repeated using the quasi-peak detector and reported.
7. Although these tests were performed other than open field site, adequate comparison measurements were confirmed against 30m open field site. Therefore, sufficient tests were made to demonstrate that the alternative site produces results that correlate with the ones of tests made in an open field site based on KDB 414788.

Below 1 GHz and above 30 MHz:

The setting of the spectrum Analyzer

RBW	120 kHz
VBW	300 kHz
Sweep	Auto
Trace	Max hold

1. The testing follows the guidelines in ANSI C63.10-2013.
2. The EUT was arranged to its worst case and then tune the antenna tower (from 1 m to 4 m) and turntable (from 0 degree to 360 degrees) to find the maximum reading. A pre-amp and a high pass filter are used for the test in order to get better signal level. Both horizontal and vertical polarizations of the antenna are set to make the measurement.
3. The EUT was placed on a turntable with 80 cm above ground.
4. The EUT was set 3 meters from the interference receiving antenna, which was mounted on the top of a variable height antenna tower.
5. For measurement below 1GHz, the initial step in collecting conducted emission data is a spectrum analyzer peak detector mode pre-scanning the measurement frequency range. Significant peaks are then marked and then Quasi Peak detector mode re-measured. If the emission level of the EUT measured by the peak detector is 3 dB lower than the applicable limit, the peak emission level will be reported. Otherwise, the emission measurement will be repeated using the quasi-peak detector and reported.

Above 1 GHz:

RBW	1 MHz
VBW	PEAK: 3 MHz AVG: see note 6
Sweep	Auto
Detector	Peak
Trace	Max hold

1. The testing follows the guidelines in ANSI C63.10-2013.

2. The EUT was arranged to its worst case and then tune the antenna tower (from 1 m to 4 m) and turntable (from 0 degree to 360 degrees) to find the maximum reading. A pre-amp and a high pass filter are used for the test in order to get better signal level. Both horizontal and vertical polarizations of the antenna are set to make the measurement.

3. The EUT was placed on a turntable with 1.5m above ground.

4. The EUT was set 3 meters from the interference receiving antenna, which was mounted on the top of a variable height antenna tower.

5. For measurement above 1GHz, the emission measurement will be measured by the peak detector. This peak level, once corrected, must comply with the limit specified in Section 15.209.

6. For measurements above 1 GHz the resolution bandwidth is set to 1 MHz, then the video bandwidth is set to 3 MHz for peak measurements and 1 MHz resolution bandwidth with 1/T video bandwidth with peak detector for AVG measurements. For the Duty Cycle please refer to clause 8.1.ON TIME AND DUTY CYCLE.

7. Restriction band: Investigated frequency range from 2310 MHz to 2410 MHz and 2470MHz to 2500 MHz.

All restriction band should comply with 15.209, other emission should be at least 20 dB below the fundamental.

Note 1: For all radiated test, EUT in each of three orthogonal axis emissions had been tested, but only the worst case (X axis) data recorded in the report.

Note 2: The EUT does not support simultaneous transmission.

Note 3: The EUT was fully exercised with external accessories during the test. In the case of multiple accessory external ports, an external accessory shall be connected to one of each type of port.

13.4. Results

Pass. (See below detailed test result)

All the emissions except fundamental emission from 9 kHz to 25 GHz were comply with 15.209 limits.

Note1: According exploratory test, the emission levels are 20 dB below the limit detected from 9 kHz to 30 MHz, so the final test was performed with frequency range from 30 MHz to 26 GHz and recorded in below.

Note2: For emissions below 1 GHz, according exploratory explorer test, when change Tx mode and channel, have no distinct influence on emissions level, so for emissions below 1 GHz, the final test was only performed with EUT working in GFSK, Tx 2480 MHz mode.

Note3: For emissions above 1 GHz. If peak results comply with AV limit, AV Result is deemed to comply with AV limit.

13.5. Original Test Data

Below 1 GHz and above 30 MHz test data Refer to appendix A

Above 1 GHz test data Refer to appendix B

14. AC Power Line Conducted Emissions

14.1. Block Diagram of Test Setup

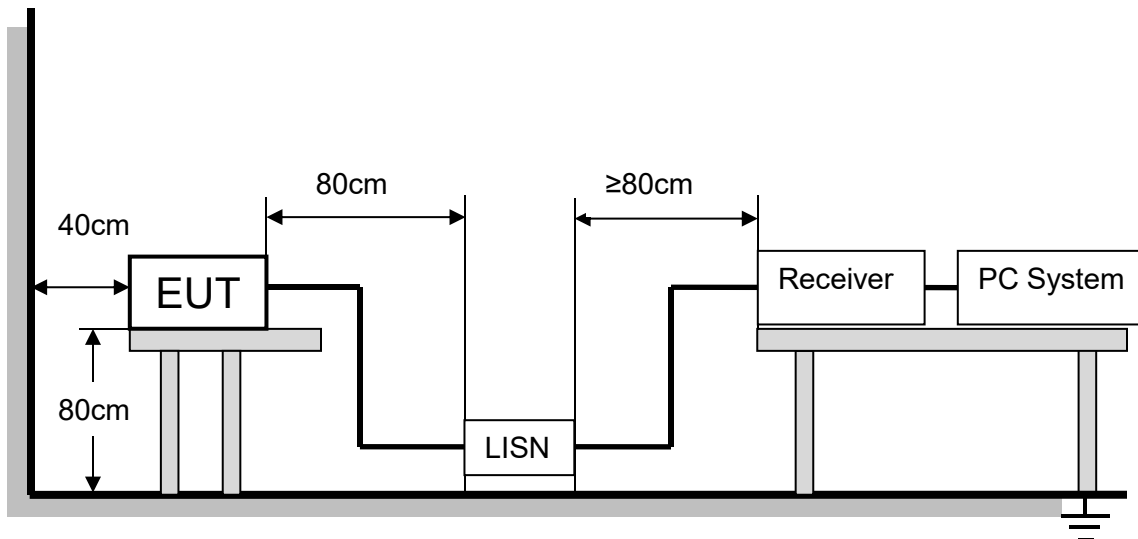

The EUT is put on a table of non-conducting material that is 80 cm high. The vertical conducting wall of shielding is located 40 cm to the rear of the EUT. The power line of the EUT is connected to the AC mains through an Artificial Mains Network (A.M.N.). A EMI Measurement Receiver (R&S Test Receiver ESR3) is used to test the emissions from both sides of AC line. According to the requirements in Section 6.2 of ANSI C63.10-2013. Conducted emissions from the EUT measured in the frequency range between 0.15 MHz and 30 MHz using CISPR Quasi-Peak and average detector mode. The bandwidth of EMI test receiver is set at 9 kHz.

The arrangement of the equipment is installed to meet the standards and operating in a manner, which tends to maximize its emission characteristics in a normal application.

14.2. Limits

Please refer to CFR 47 FCC § 15.207 (a) .

Frequency (MHz)	Quasi-peak	Average
0.15 -0.5	66 - 56 *	56 - 46 *
0.50 -5.0	56.00	46.00
5.0 -30.0	60.00	50.00

Note 1: * Decreasing linearly with logarithm of frequency.

Note 2: The lower limit shall apply at the transition frequencies.

14.3. Test Procedure

The EUT and Support equipment, if needed, were put placed on a non-metallic table, 80cm above the ground plane.

Configuration EUT to simulate typical usage as described in clause 2.4 and test equipment as described in clause 10.2 of this report.

All I/O cables were positioned to simulate typical actual usage as per ANSI C63.10.

All support equipment power received from a second LISN.

Emissions were measured on each current carrying line of the EUT using an EMI Test Receiver connected to the LISN powering the EUT.

The Receiver scanned from 150 kHz to 30 MHz for emissions in each of the test modes.

During the above scans, the emissions were maximized by cable manipulation.

The test mode(s) described in clause 2.4 were scanned during the preliminary test.

After the preliminary scan, we found the test mode producing the highest emission level.

The EUT configuration and worse cable configuration of the above highest emission levels were recorded for reference of the final test.

EUT and support equipment were set up on the test bench as per the configuration with highest emission level in the preliminary test.

A scan was taken on both power lines, Neutral and Line, recording at least the six highest emissions.

Emission frequency and amplitude were recorded into a computer in which correction factors were used to calculate the emission level and compare reading to the applicable limit.

The test data of the worst-case condition(s) was recorded.

The bandwidth of test receiver is set at 9 kHz.

14.4. Test Result

Pass. (See below detailed test result)

Note1: All emissions not reported below are too low against the prescribed limits.

Note2: Pre-test AC conducted emission at both voltage AC 120V/60Hz and AC 240V/50Hz, recorded worse case.

14.5. Original Test Data

Refer to appendix C

15. Antenna Requirements

15.1. Limits

Please refer to FCC § 15.203

An intentional radiator shall be designed to ensure that no antenna other than that furnished by the responsible party shall be used with the device. The use of a permanently attached antenna or of an antenna that uses a unique coupling to the intentional radiator shall be considered sufficient to comply with the provisions of this section. The manufacturer may design the unit so that a broken antenna can be replaced by the user, but the use of a standard antenna jack or electrical connector is prohibited.

Please refer to FCC § 15.247(b)(4)

The conducted output power limit specified in paragraph (b) of this section is based on the use of antennas with directional gains that do not exceed 6 dBi. Except as shown in paragraph (c) of this section, if transmitting antennas of directional gain greater than 6 dBi are used, the conducted output power from the intentional radiator shall be reduced below the stated values in paragraphs (b)(1), (b)(2), and (b)(3) of this section, as appropriate, by the amount in dB that the directional gain of the antenna exceeds 6 dBi.

15.2. Result

The antenna used for this product is PCB antenna and that no antenna other than that furnished by the responsible party shall be used with the device, the maximum peak gain of the transmit antenna is 1.72 dBi

APPENDIX A – Radiated Emission Below 1GHz Test Data

Test Report

Project Information			
EUT:	Speakerphone	Environment:	25°C/58%
Model:	BM41	SN:	
Mode:	BLE_1M_2480	Voltage:	AC120V/60Hz
Customer:		Engineer:	Roger
Remark:			
Test Standard:			

Start of Test: 2022-09-07 22:39:42

Test Graph

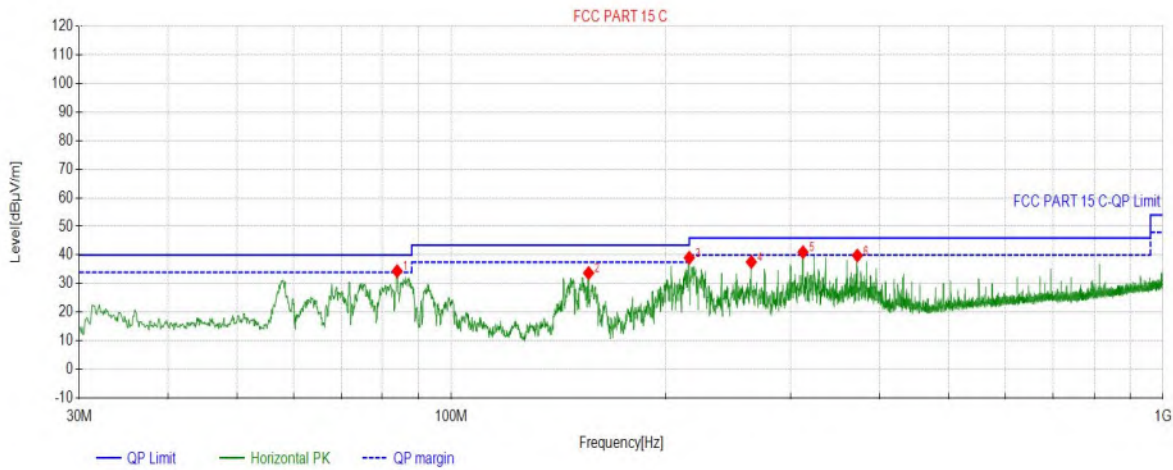

Suspected Data List								
NO.	Freq. (MHz)	Level (dBµV/m)	Factor (dB)	Limit (dBµV/m)	Margin (dB)	Height (cm)	Angle (°)	Polarity
1	83.9374	34.38	-26.79	40.00	5.62	100	191	Horizontal
2	155.918	33.71	-25.55	43.50	9.79	100	159	Horizontal
3	215.967	39.07	-22.55	43.50	4.43	100	180	Horizontal
4	263.987	37.58	-21.02	46.00	8.42	100	148	Horizontal
5	312.007	41.03	-19.76	46.00	4.97	100	235	Horizontal
6	371.959	39.83	-18.01	46.00	6.17	100	222	Horizontal

Test Report

Project Information			
EUT:	Speakerphone	Environment:	25°C/58%
Model:	BM41	SN:	
Mode:	BLE_1M_2480	Voltage:	AC120V/60Hz
Customer:		Engineer:	Roger
Remark:			
Test Standard:			

Start of Test: 2022-09-07 22:40:17

Test Graph

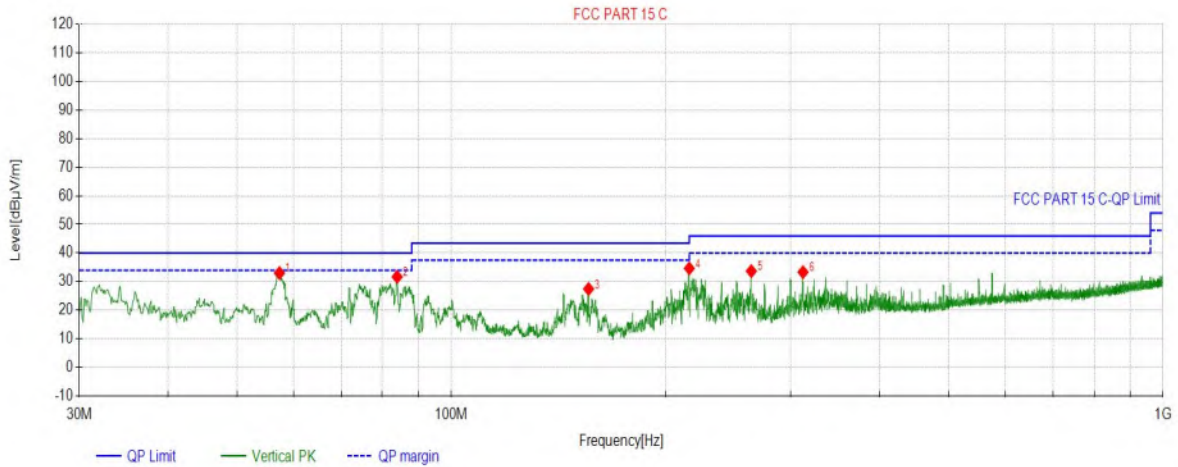

Suspected Data List								
NO.	Freq. (MHz)	Level (dBµV/m)	Factor (dB)	Limit (dBµV/m)	Margin (dB)	Height (cm)	Angle (°)	Polarity
1	57.3567	33.03	-22.11	40.00	6.97	100	214	Vertical
2	83.9374	31.69	-26.79	40.00	8.31	100	30	Vertical
3	155.918	27.44	-25.55	43.50	16.06	100	30	Vertical
4	215.967	34.65	-22.55	43.50	8.85	100	30	Vertical
5	263.987	33.70	-21.02	46.00	12.30	100	30	Vertical
6	312.007	33.34	-19.76	46.00	12.66	100	30	Vertical

APPENDIX B – Radiated Emission Above 1GHz Test Data

Test Report

Project Information			
Customer:		EUT:	Speakerphone
Model:	BM41	SN:	
Mode:	BLE_1M_2402	Voltage:	AC120V/60Hz
Environment:	25°C/58%	Engineer:	Roger
Remark:			
Test Standard:			

Start of Test: 2022-09-07 20:43:31

Test Graph

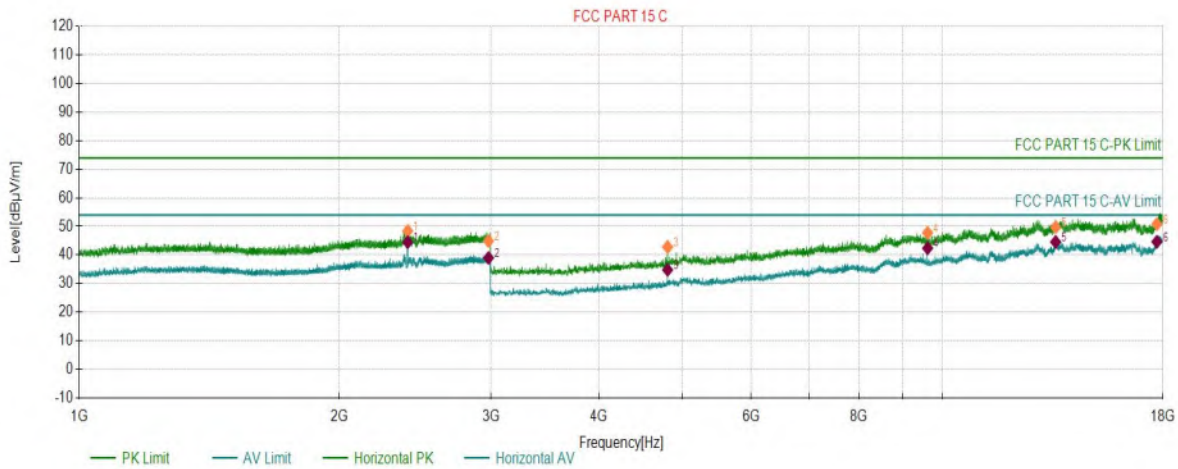

PK Final Data List

NO.	Freq. (MHz)	Factor (dB)	PK Value (dBµV/m)	PK Limit (dBµV/m)	PK Margin (dB)	Height (cm)	Angle (°)	Polarity
1	2401.9402	7.13	48.45	74.00	25.55	150	0	Horizontal
2	2979.1979	8.75	44.90	74.00	29.10	150	266	Horizontal
3	4803.1803	-10.14	42.82	74.00	31.18	150	2	Horizontal
4	9608.1608	3.01	47.79	74.00	26.21	150	207	Horizontal
5	13517.5518	10.59	49.76	74.00	24.24	150	330	Horizontal
6	17707.4707	13.06	50.81	74.00	23.19	150	106	Horizontal

AV Final Data List

NO.	Freq. (MHz)	Factor (dB)	AV Value (dBµV/m)	AV Limit (dBµV/m)	AV Margin (dB)	Height (cm)	Angle (°)	Polarity
1	2401.9402	7.13	44.52	54.00	9.48	150	0	Horizontal
2	2979.1979	8.75	39.00	54.00	15.00	150	266	Horizontal
3	4803.1803	-10.14	34.81	54.00	19.19	150	2	Horizontal
4	9608.1608	3.01	42.41	54.00	11.59	150	207	Horizontal
5	13517.5518	10.59	44.58	54.00	9.42	150	330	Horizontal
6	17707.4707	13.06	44.65	54.00	9.35	150	106	Horizontal

Test Report

Project Information			
Customer:		EUT:	Speakerphone
Model:	BM41	SN:	
Mode:	BLE_1M_2402	Voltage:	AC120V/60Hz
Environment:	25°C/58%	Engineer:	Roger
Remark:			
Test Standard:			

Start of Test: 2022-09-07 20:44:57

Test Graph

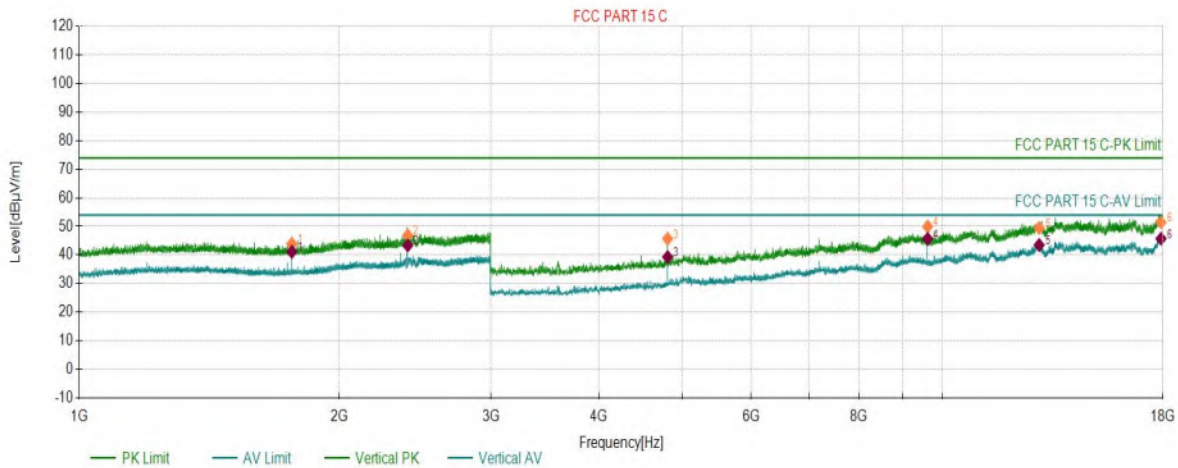

PK Final Data List

NO.	Freq. (MHz)	Factor (dB)	PK Value (dBµV/m)	PK Limit (dBµV/m)	PK Margin (dB)	Height (cm)	Angle (°)	Polarity
1	1763.2763	3.31	43.94	74.00	30.06	150	173	Vertical
2	2401.9402	7.13	46.90	74.00	27.10	150	232	Vertical
3	4803.1803	-10.14	45.70	74.00	28.30	150	352	Vertical
4	9608.1608	3.01	49.97	74.00	24.03	150	355	Vertical
5	12936.9937	9.50	49.45	74.00	24.55	150	99	Vertical
6	17902.4902	14.84	51.44	74.00	22.56	150	324	Vertical

AV Final Data List

NO.	Freq. (MHz)	Factor (dB)	AV Value (dBµV/m)	AV Limit (dBµV/m)	AV Margin (dB)	Height (cm)	Angle (°)	Polarity
1	1763.2763	3.31	41.13	54.00	12.87	150	173	Vertical
2	2401.9402	7.13	43.36	54.00	10.64	150	232	Vertical
3	4803.1803	-10.14	39.33	54.00	14.67	150	352	Vertical
4	9608.1608	3.01	45.67	54.00	8.33	150	355	Vertical
5	12936.9937	9.50	43.53	54.00	10.47	150	99	Vertical
6	17902.4902	14.84	45.73	54.00	8.27	150	324	Vertical

Test Report

Project Information			
Customer:		EUT:	Speakerphone
Model:	BM41	SN:	
Mode:	BLE_1M_2440	Voltage:	AC120V/60Hz
Environment:	25°C/58%	Engineer:	Roger
Remark:			
Test Standard:			

Start of Test: 2022-09-07 20:58:01

Test Graph

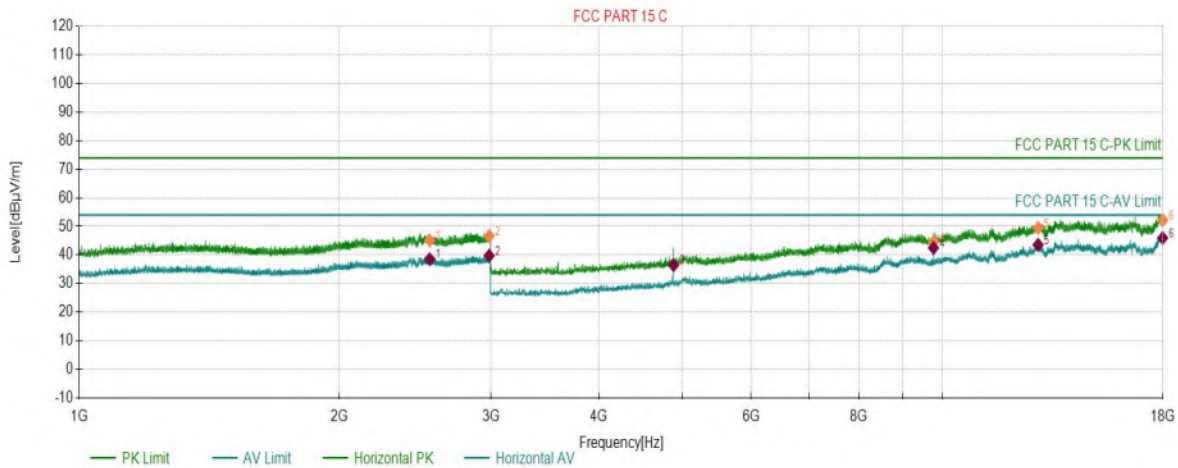

PK Final Data List

NO.	Freq. (MHz)	Factor (dB)	PK Value (dBµV/m)	PK Limit (dBµV/m)	PK Margin (dB)	Height (cm)	Angle (°)	Polarity
1	2546.3546	7.57	45.12	74.00	28.88	150	2	Horizontal
2	2983.9984	8.78	46.66	74.00	27.34	150	17	Horizontal
3	4879.6880	-9.50	36.46	74.00	37.54	150	1	Horizontal
4	9759.6760	3.08	44.53	74.00	29.47	150	273	Horizontal
5	12899.4899	9.51	49.49	74.00	24.51	150	307	Horizontal
6	17980.4981	14.46	52.22	74.00	21.78	150	334	Horizontal

AV Final Data List

NO.	Freq. (MHz)	Factor (dB)	AV Value (dBµV/m)	AV Limit (dBµV/m)	AV Margin (dB)	Height (cm)	Angle (°)	Polarity
1	2546.3546	7.57	38.59	54.00	15.41	150	2	Horizontal
2	2983.9984	8.78	39.78	54.00	14.22	150	17	Horizontal
3	4879.6880	-9.50	36.51	54.00	17.49	150	1	Horizontal
4	9759.6760	3.08	42.48	54.00	11.52	150	273	Horizontal
5	12899.4899	9.51	43.60	54.00	10.40	150	307	Horizontal
6	17980.4981	14.46	45.97	54.00	8.03	150	334	Horizontal

Test Report

Project Information			
Customer:		EUT:	Speakerphone
Model:	BM41	SN:	
Mode:	BLE_1M_2440	Voltage:	AC120V/60Hz
Environment:	25°C/58%	Engineer:	Roger
Remark:			
Test Standard:			

Start of Test: 2022-09-07 20:59:20

Test Graph

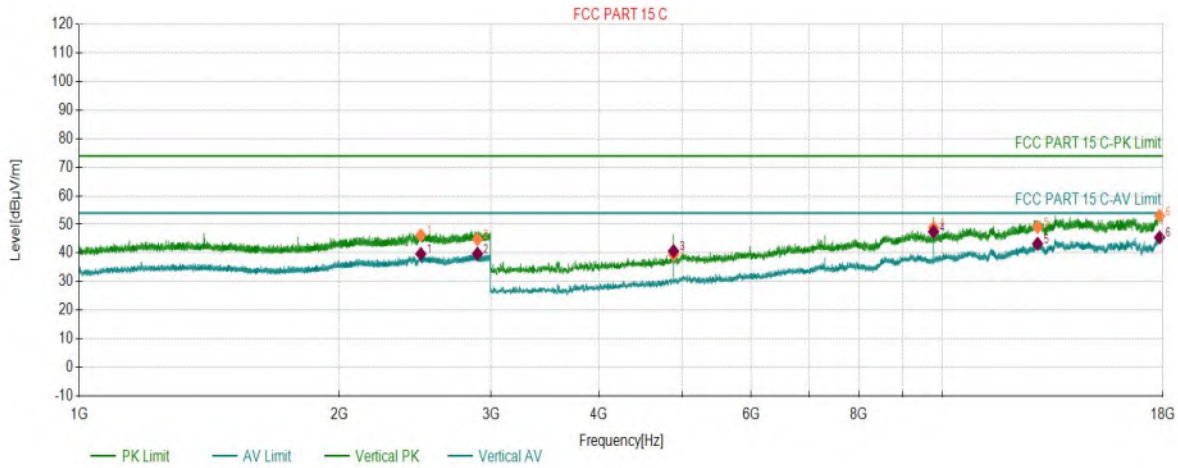

PK Final Data List								
NO.	Freq. (MHz)	Factor (dB)	PK Value (dBµV/m)	PK Limit (dBµV/m)	PK Margin (dB)	Height (cm)	Angle (°)	Polarity
1	2487.1487	7.73	46.22	74.00	27.78	150	98	Vertical
2	2892.5893	8.33	44.81	74.00	29.19	150	31	Vertical
3	4879.6880	-9.50	39.46	74.00	34.54	150	0	Vertical
4	9759.6760	3.08	48.93	74.00	25.07	150	114	Vertical
5	12881.4881	9.48	49.04	74.00	24.96	150	269	Vertical
6	17836.4836	14.39	53.02	74.00	20.98	150	1	Vertical

AV Final Data List								
NO.	Freq. (MHz)	Factor (dB)	AV Value (dBµV/m)	AV Limit (dBµV/m)	AV Margin (dB)	Height (cm)	Angle (°)	Polarity
1	2487.1487	7.73	39.70	54.00	14.30	150	98	Vertical
2	2892.5893	8.33	39.76	54.00	14.24	150	31	Vertical
3	4879.6880	-9.50	40.69	54.00	13.31	150	0	Vertical
4	9759.6760	3.08	47.45	54.00	6.55	150	114	Vertical
5	12881.4881	9.48	43.27	54.00	10.73	150	269	Vertical
6	17836.4836	14.39	45.46	54.00	8.54	150	1	Vertical

Test Report

Project Information			
Customer:		EUT:	Speakerphone
Model:	BM41	SN:	
Mode:	BLE_1M_2440	Voltage:	AC120V/60Hz
Environment:	25°C/58%	Engineer:	Roger
Remark:			
Test Standard:			

Start of Test: 2022-09-07 21:01:27

Test Graph

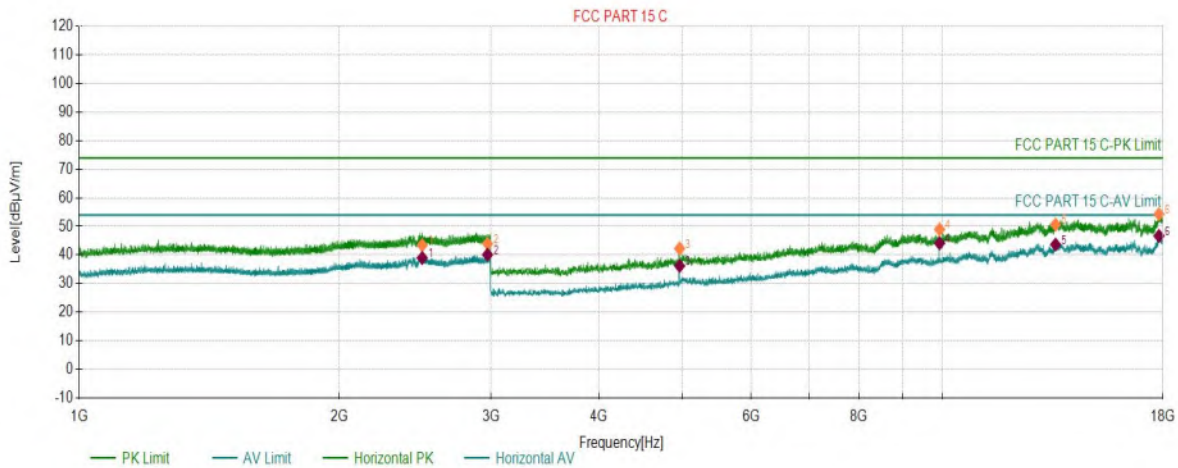

PK Final Data List

NO.	Freq. (MHz)	Factor (dB)	PK Value (dBµV/m)	PK Limit (dBµV/m)	PK Margin (dB)	Height (cm)	Angle (°)	Polarity
1	2496.5497	7.18	43.42	74.00	30.58	150	24	Horizontal
2	2971.5972	8.72	43.95	74.00	30.05	150	173	Horizontal
3	4959.1959	-8.84	42.29	74.00	31.71	150	0	Horizontal
4	9920.1920	3.89	48.99	74.00	25.01	150	355	Horizontal
5	13514.5515	10.60	50.62	74.00	23.38	150	218	Horizontal
6	17806.4806	14.18	54.29	74.00	19.71	150	355	Horizontal

AV Final Data List

NO.	Freq. (MHz)	Factor (dB)	AV Value (dBµV/m)	AV Limit (dBµV/m)	AV Margin (dB)	Height (cm)	Angle (°)	Polarity
1	2496.5497	7.18	39.02	54.00	14.98	150	24	Horizontal
2	2971.5972	8.72	40.13	54.00	13.87	150	173	Horizontal
3	4959.1959	-8.84	36.22	54.00	17.78	150	0	Horizontal
4	9920.1920	3.89	44.11	54.00	9.89	150	355	Horizontal
5	13514.5515	10.60	43.68	54.00	10.32	150	218	Horizontal
6	17806.4806	14.18	46.69	54.00	7.31	150	355	Horizontal

Test Report

Project Information			
Customer:		EUT:	Speakerphone
Model:	BM41	SN:	
Mode:	BLE_1M_2480	Voltage:	AC120V/60Hz
Environment:	25°C/58%	Engineer:	Roger
Remark:			
Test Standard:			

Start of Test: 2022-09-07 21:02:54

Test Graph

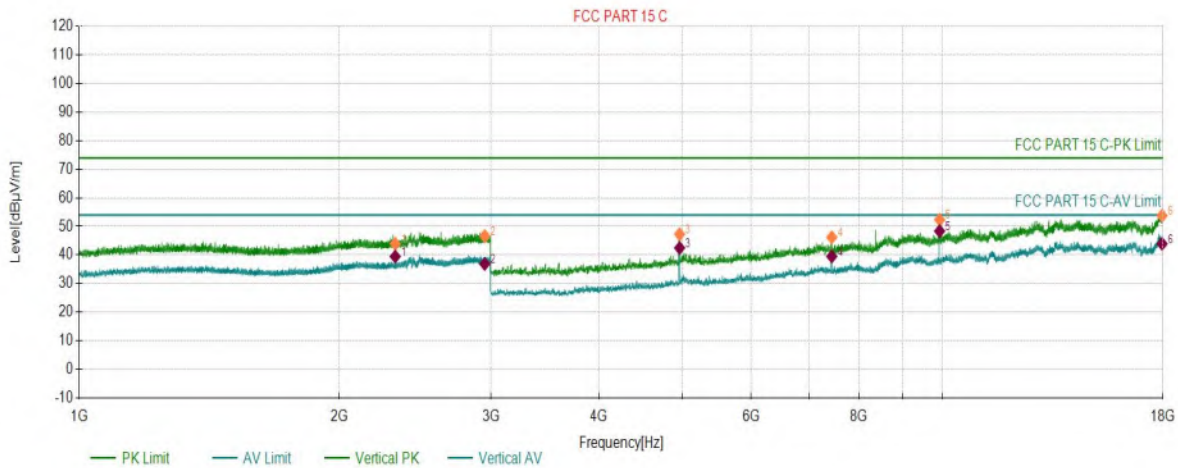

PK Final Data List

NO.	Freq. (MHz)	Factor (dB)	PK Value (dBµV/m)	PK Limit (dBµV/m)	PK Margin (dB)	Height (cm)	Angle (°)	Polarity
1	2323.1323	6.27	43.91	74.00	30.09	150	191	Vertical
2	2949.5950	8.60	46.61	74.00	27.39	150	280	Vertical
3	4959.1959	-8.84	47.26	74.00	26.74	150	8	Vertical
4	7440.4440	-1.68	46.22	74.00	27.78	150	1	Vertical
5	9920.1920	3.89	52.36	74.00	21.64	150	358	Vertical
6	17953.4954	14.59	53.79	74.00	20.21	150	96	Vertical

AV Final Data List

NO.	Freq. (MHz)	Factor (dB)	AV Value (dBµV/m)	AV Limit (dBµV/m)	AV Margin (dB)	Height (cm)	Angle (°)	Polarity
1	2323.1323	6.27	39.48	54.00	14.52	150	191	Vertical
2	2949.5950	8.60	36.91	54.00	17.09	150	280	Vertical
3	4959.1959	-8.84	42.50	54.00	11.50	150	8	Vertical
4	7440.4440	-1.68	39.52	54.00	14.48	150	1	Vertical
5	9920.1920	3.89	48.37	54.00	5.63	150	358	Vertical
6	17953.4954	14.59	43.94	54.00	10.06	150	96	Vertical

Restriction Band Emission

Test Report

Project Information			
Customer:		EUT:	Speakerphone
Model:	BM41	SN:	
Mode:	BLE_1M_2402	Voltage:	AC120V/60Hz
Environment:	25°C/58%	Engineer:	Roger
Remark:			
Test Standard:			

Start of Test: 2022-09-07 21:10:14

Test Graph

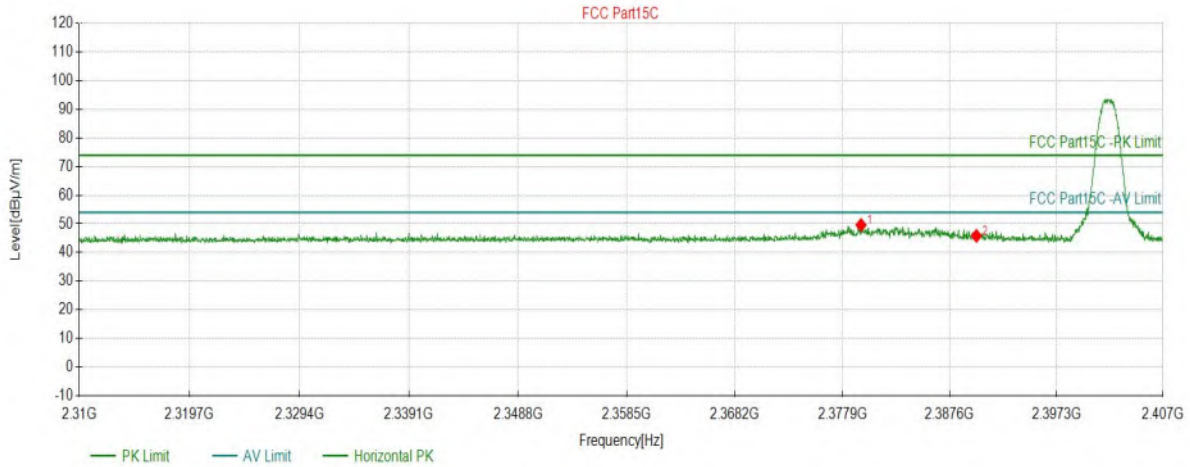

Suspected Data List									
NO.	Freq. (MHz)	Level (dBµV/m)	Factor (dB)	Limit (dBµV/m)	Margin (dB)	Height (cm)	Angle (°)	Detector	Polarity
1	2379.5722	49.63	6.45	74.00	24.37	150	359	PK	Horizont
2	2390.0193	45.82	6.47	74.00	28.18	150	8	PK	Horizont

Test Report

Project Information			
Customer:		EUT:	Speakerphone
Model:	BM41	SN:	
Mode:	BLE_1M_2402	Voltage:	AC120V/60Hz
Environment:	25°C/58%	Engineer:	Roger
Remark:			
Test Standard:			

Start of Test: 2022-09-07 21:11:03

Test Graph

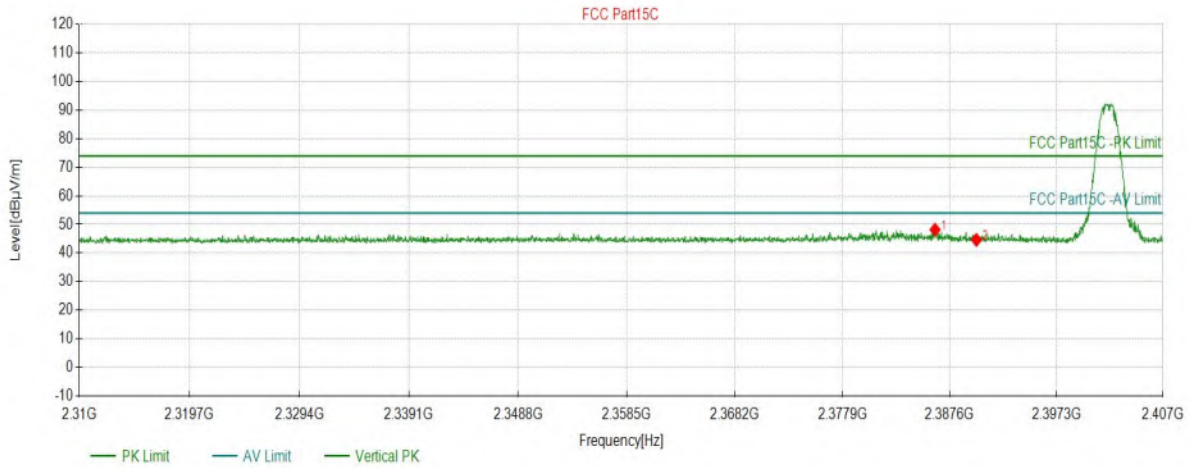

Suspected Data List									
NO.	Freq. (MHz)	Level (dBµV/m)	Factor (dB)	Limit (dBµV/m)	Margin (dB)	Height (cm)	Angle (°)	Detector	Polarity
1	2386.2674	48.17	6.46	74.00	25.83	150	257	PK	Vertical
2	2390.0193	44.60	6.47	74.00	29.40	150	357	PK	Vertical

Test Report

Project Information			
Customer:		EUT:	Speakerphone
Model:	BM41	SN:	
Mode:	BLE_1M_2480	Voltage:	AC120V/60Hz
Environment:	25°C/58%	Engineer:	Roger
Remark:			
Test Standard:			

Start of Test: 2022-09-07 21:05:51

Test Graph

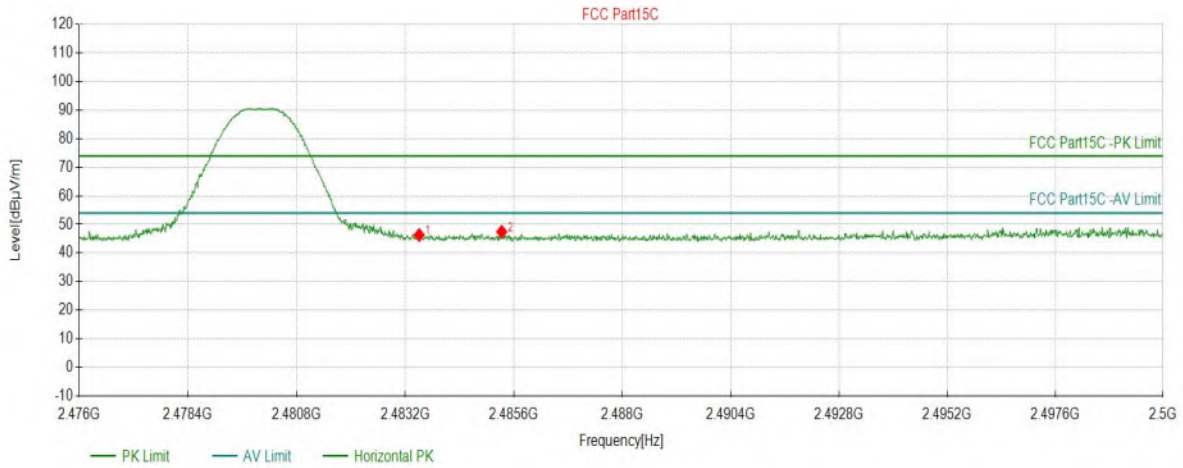

Suspected Data List									
NO.	Freq. (MHz)	Level (dBµV/m)	Factor (dB)	Limit (dBµV/m)	Margin (dB)	Height (cm)	Angle (°)	Detector	Polarity
1	2483.5038	46.31	7.09	74.00	27.69	150	246	PK	Horizont
2	2485.3287	47.42	7.10	74.00	26.58	150	48	PK	Horizont

Test Report

Project Information			
Customer:		EUT:	Speakerphone
Model:	BM41	SN:	
Mode:	BLE_1M_2480	Voltage:	AC120V/60Hz
Environment:	25°C/58%	Engineer:	Roger
Remark:			
Test Standard:			

Start of Test: 2022-09-07 21:06:44

Test Graph

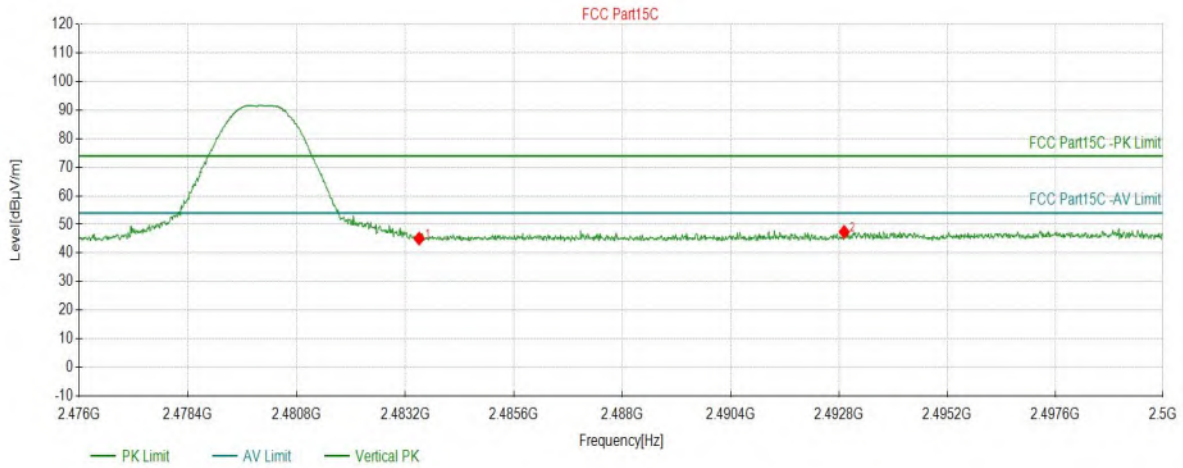

Suspected Data List									
NO.	Freq. (MHz)	Level (dBµV/m)	Factor (dB)	Limit (dBµV/m)	Margin (dB)	Height (cm)	Angle (°)	Detector	Polarity
1	2483.5038	45.07	7.09	74.00	28.93	150	354	PK	Vertical
2	2492.9165	47.39	7.16	74.00	26.61	150	129	PK	Vertical

APPENDIX C – AC Power Line Conducted Emission Test Data

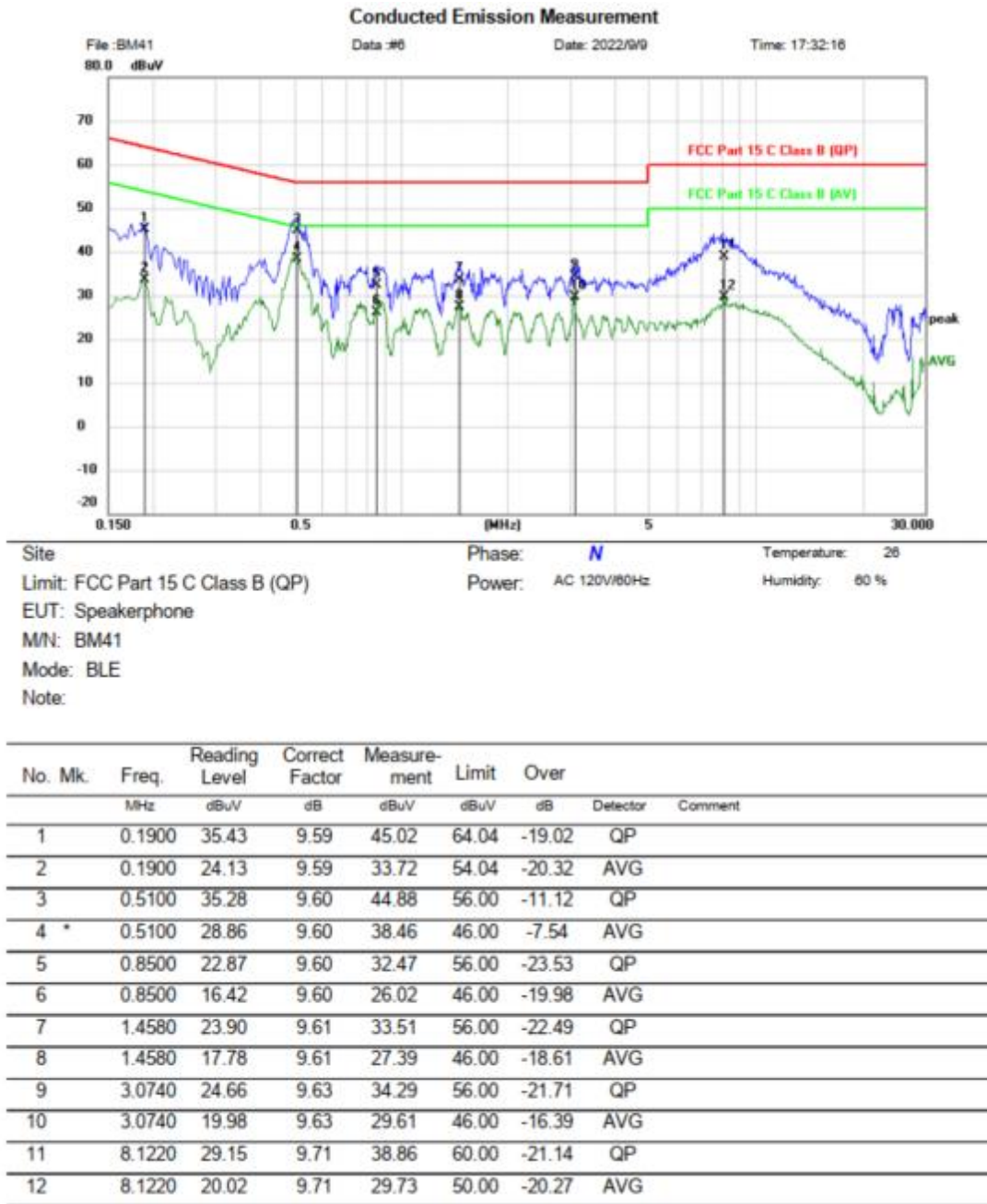

Conducted Emission Measurement

File: BM41 Data: #7 Date: 2022/9/9 Time: 17:35:23

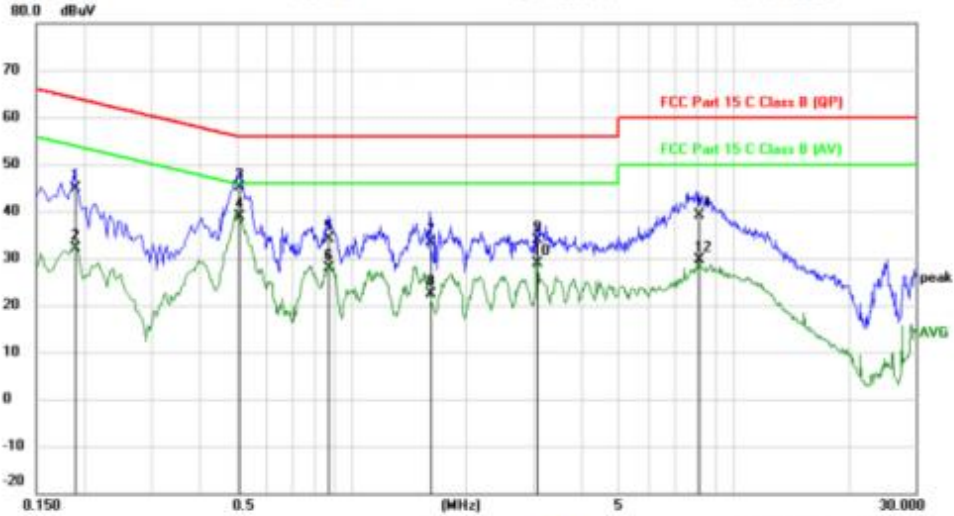

Site: Phase: **N** Temperature: 28
 Limit: FCC Part 15 C Class B (QP) Power: AC 120V/60Hz Humidity: 60 %
 EUT: Speakerphone
 M/N: BM41
 Mode: BLE
 Note:

No. Mk.	Freq. MHz	Reading Level dBuV	Correct Factor dB	Measurement dBuV	Limit dBuV	Over dB	Detector	Comment
1	0.1900	35.30	9.59	44.89	64.04	-19.15	QP	
2	0.1900	22.50	9.59	32.09	54.04	-21.95	AVG	
3	0.5100	35.58	9.60	45.18	56.00	-10.82	QP	
4 *	0.5100	29.22	9.60	38.82	46.00	-7.18	AVG	
5	0.8740	24.53	9.61	34.14	56.00	-21.86	QP	
6	0.8740	18.32	9.61	27.93	46.00	-18.07	AVG	
7	1.6100	23.72	9.61	33.33	56.00	-22.67	QP	
8	1.6100	12.77	9.61	22.38	46.00	-23.62	AVG	
9	3.0700	24.34	9.63	33.97	56.00	-22.03	QP	
10	3.0700	19.37	9.63	29.00	46.00	-17.00	AVG	
11	8.1220	29.34	9.71	39.05	60.00	-20.95	QP	
12	8.1220	19.82	9.71	29.53	50.00	-20.47	AVG	

END OF REPORT