



CFR 47 FCC PART 15 SUBPART C

CERTIFICATION TEST REPORT

For

Speakerphone

MODEL NUMBER: UC BM35, BM31, UC BMXXX(X:0~9, A~Z OR BLANK)

FCC ID: 2AFG6-BM31

REPORT NUMBER: 4790311613-11

ISSUE DATE: May 9, 2022

Prepared for

**Guangzhou Shirui Electronics Co., Ltd.
192 Kezhu Road, Sciencetech Park, Guangzhou Economic & Technology
Development District, Guangzhou, Guangdong, China**

Prepared by

UL Verification Services (Guangzhou) Co., Ltd, Song Shan Lake Branch

Building 10, Innovation Technology Park, No. 1, Li Bin Road, Song Shan Lake Hi-Tech Development Zone Dongguan, 523808, People's Republic of China

Tel: +86 769 22038881

Fax: +86 769 33244054

Website: www.ul.com



Revision History

<u>Rev.</u>	<u>Issue Date</u>	<u>Revisions</u>	<u>Revised By</u>
V0	05/09/2022	Initial Issue	



Summary of Test Results			
Clause	Test Items	FCC Rules	Test Results
1	20dB Bandwidth	FCC 15.247 (a) (1)	Pass
2	Conducted Output Power	FCC 15.247 (b) (1)	Pass
3	Carrier Hopping Channel Separation	FCC 15.247 (a) (1)	Pass
4	Number of Hopping Frequency	15.247 (a) (1) III	Pass
5	Time of Occupancy (Dwell Time)	15.247 (a) (1) III	Pass
6	Conducted Bandedge	FCC 15.247 (d)	Pass
7	Radiated Bandedge and Spurious	FCC 15.247 (d) FCC 15.209 FCC 15.205	Pass
8	Conducted Emission Test for AC Power Port	FCC 15.207	Pass
9	Antenna Requirement	FCC 15.203	Pass
Note: 1. This test report is only published to and used by the applicant, and it is not for evidence purpose in China. 2. The measurement result for the sample received is <Pass> according to < CFR 47 FCC PART 15 SUBPART C > when <Accuracy Method> decision rule is applied.			



TABLE OF CONTENTS

1. ATTESTATION OF TEST RESULTS	7
2. TEST METHODOLOGY	8
3. FACILITIES AND ACCREDITATION	8
4. CALIBRATION AND UNCERTAINTY	9
4.1. <i>MEASURING INSTRUMENT CALIBRATION</i>	9
4.2. <i>MEASUREMENT UNCERTAINTY</i>	9
5. EQUIPMENT UNDER TEST	10
5.1. <i>DESCRIPTION OF EUT</i>	10
5.2. <i>MAXIMUM PEAK OUTPUT POWER</i>	10
5.3. <i>PACKET TYPE CONFIGURATION</i>	10
5.4. <i>CHANNEL LIST</i>	11
5.5. <i>TEST CHANNEL CONFIGURATION</i>	11
5.6. <i>WORST-CASE CONFIGURATIONS</i>	11
5.7. <i>THE WORSE CASE POWER SETTING PARAMETER</i>	12
5.8. <i>DESCRIPTION OF AVAILABLE ANTENNAS</i>	12
5.9. <i>DESCRIPTION OF TEST SETUP</i>	13
6. MEASURING INSTRUMENT AND SOFTWARE USED	14
7. ANTENNA PORT TEST RESULTS	16
7.1. <i>ON TIME AND DUTY CYCLE</i>	16
7.2. <i>20 dB BANDWIDTH</i>	17
7.3. <i>CONDUCTED OUTPUT POWER</i>	19
7.4. <i>CARRIER FREQUENCY SEPARATION</i>	20
7.5. <i>NUMBER OF HOPPING FREQUENCIES</i>	22
7.6. <i>TIME OF OCCUPANCY (DWELL TIME)</i>	24
7.7. <i>CONDUCTED BANDEDGE AND SPURIOUS EMISSION</i>	26
8. RADIATED TEST RESULTS	28
8.1. <i>RESTRICTED BANDEDGE</i>	34
8.1.1. <i>GFSK MODE</i>	34
8.1.2. <i>π/4-DQPSK MODE</i>	38
8.2. <i>SPURIOUS EMISSIONS (1 GHz ~ 3 GHz)</i>	41
8.2.1. <i>GFSK MODE</i>	41
8.3. <i>SPURIOUS EMISSIONS (3 GHz ~ 18 GHz)</i>	47



8.3.1.	GFSK MODE.....	47
8.3.2.	π/4-DQPSK MODE.....	53
8.4.	SPURIOUS EMISSIONS (18 GHz ~ 26 GHz).....	59
8.4.1.	GFSK MODE.....	59
8.5.	SPURIOUS EMISSIONS (30 MHz ~ 1 GHz).....	61
8.5.1.	GFSK MODE.....	61
8.6.	SPURIOUS EMISSIONS BELOW 30 MHz.....	63
8.6.1.	GFSK MODE.....	63
9.	AC POWER LINE CONDUCTED EMISSIONS.....	66
9.1.	GFSK MODE.....	67
10.	ANTENNA REQUIREMENTS.....	69
11.	Photo.....	70
11.1.	External Photo.....	70
11.2.	Internal Photo.....	71
11.3.	Setup Photo.....	78
12.	Appendix.....	82
12.1.	Appendix A: 20dB Emission Bandwidth.....	82
12.1.1.	Test Result.....	82
12.1.2.	Test Graphs.....	83
12.2.	Appendix B: Occupied Channel Bandwidth.....	85
12.2.1.	Test Result.....	85
12.2.2.	Test Graphs.....	86
12.3.	Appendix C: Maximum conducted output power.....	88
12.3.1.	Test Result.....	88
12.4.	Appendix D: Carrier frequency separation.....	89
12.4.1.	Test Result.....	89
12.4.2.	Test Graphs.....	90
12.5.	Appendix E: Time of occupancy.....	91
12.5.1.	Test Result.....	91
12.5.2.	Test Graphs.....	92
12.6.	Appendix F: Number of hopping channels.....	94
12.6.1.	Test Result.....	94
12.6.2.	Test Graphs.....	95
12.7.	Appendix G: Band edge measurements.....	96
12.7.1.	Test Result.....	96
12.7.2.	Test Graphs.....	97
12.8.	Appendix H: Conducted Spurious Emission.....	100
12.8.1.	Test Result.....	100
12.8.2.	Test Graphs.....	101
12.9.	Appendix I: Duty Cycle.....	108
12.9.1.	Test Result.....	108



12.9.2. Test Graphs 109



1. ATTESTATION OF TEST RESULTS

Applicant Information

Company Name: Guangzhou Shirui Electronics Co., Ltd.
Address: 192 Kezhu Road, Sciencetech Park, Guangzhou Economic & Technology Development District, Guangzhou,Guangdong,China

Manufacturer Information

Company Name: Guangzhou Shirui Electronics Co., Ltd.
Address: 192 Kezhu Road, Sciencetech Park, Guangzhou Economic & Technology Development District, Guangzhou,Guangdong,China

EUT Information

EUT Name: Speakerphone
Model: UC BM35, BM31, UC BMXXX(X:0~9, A~Z OR BLANK)
Brand: MAXHUB
Sample Received Date: March 11, 2022
Sample Status: Normal
Sample ID: 4819782
Date of Tested: March 11, 2022~ May 9, 2022

APPLICABLE STANDARDS	
STANDARD	TEST RESULTS
CFR 47 FCC PART 15 SUBPART C	PASS

Prepared By:

Dean Hua
Project Engineer

Checked By:

Shawn Wen
Laboratory Leader

Approved By:

Stephen Guo
Laboratory Manager



2. TEST METHODOLOGY

The tests documented in this report were performed in accordance with KDB 558074 D01 15.247 Meas Guidance v05r02, 414788 D01 Radiated Test Site v01r01, CFR 47 FCC Part 2, CFR 47 FCC Part 15, ANSI C63.10-2013.

3. FACILITIES AND ACCREDITATION

Accreditation Certificate	<p>A2LA (Certificate No.: 4102.01) UL Verification Services (Guangzhou) Co., Ltd. Song Shan Lake Branch. has been assessed and proved to be in compliance with A2LA.</p> <p>FCC (FCC Designation No.: CN1187) UL Verification Services (Guangzhou) Co., Ltd. Song Shan Lake Branch. Has been recognized to perform compliance testing on equipment subject to the Commission's Declaration of Conformity (DoC) and Certification rules</p> <p>ISED (Company No.: 21320) UL Verification Services (Guangzhou) Co., Ltd. Song Shan Lake Branch. has been registered and fully described in a report filed with ISED. The Company Number is 21320 and the test lab Conformity Assessment Body Identifier (CABID) is CN0046.</p> <p>VCCI (Registration No.: G-20019, R-20004, C-20012 and T-20011) UL Verification Services (Guangzhou) Co., Ltd. Song Shan Lake Branch. has been assessed and proved to be in compliance with VCCI, the Membership No. is 3793. Facility Name: Chamber D, the VCCI registration No. is G-20019 and R-20004 Shielding Room B , the VCCI registration No. is C-20012 and T-20011</p>
---------------------------	---

Note 1: All tests measurement facilities use to collect the measurement data are located at Building 10, Innovation Technology Park, Song Shan Lake Hi tech Development Zone, Dongguan, 523808, China

Note 2: The test anechoic chamber in UL Verification Services (Guangzhou) Co., Ltd. Song Shan Lake Branch had been calibrated and compared to the open field sites and the test anechoic chamber is shown to be equivalent to or worst case from the open field site.

Note 3: For below 30 MHz, lab had performed measurements at test anechoic chamber and comparing to measurements obtained on an open field site. And these measurements below 30 MHz had been correlated to measurements performed on an OFS.



4. CALIBRATION AND UNCERTAINTY

4.1. MEASURING INSTRUMENT CALIBRATION

The measuring equipment utilized to perform the tests documented in this report has been calibrated in accordance with the manufacturer's recommendations and is traceable to recognized national standards.

4.2. MEASUREMENT UNCERTAINTY

Where relevant, the following measurement uncertainty levels have been estimated for tests performed on the apparatus:

Test Item	Uncertainty
Conduction emission	3.62 dB
Radiated Emission (Included Fundamental Emission) (9 kHz ~ 30 MHz)	2.2 dB
Radiated Emission (Included Fundamental Emission) (30 MHz ~ 1 GHz)	4.00 dB
Radiated Emission (Included Fundamental Emission) (1 GHz to 26 GHz)	5.78 dB (1 GHz ~ 18 GHz)
	5.23 dB (18 GHz ~ 26 GHz)
Note: This uncertainty represents an expanded uncertainty expressed at approximately the 95 % confidence level using a coverage factor of k=2.	



5. EQUIPMENT UNDER TEST

5.1. DESCRIPTION OF EUT

EUT Name:	Speakerphone		
Model Name:	UC BM35, BM31, UC BMXXX (X:0~9, A~Z OR BLANK)		
Model difference:	There are no difference except the model name.		
Product Description (Bluetooth)	Operation Frequency	2402 MHz ~ 2480 MHz	
	Modulation Type	Data Rate	
	GFSK	1Mbps	
	π/4-DQPSK	2Mbps	
Power Supply	DC 7.4 V		
Note:	1.The EUT has two independent RF Modules, each RF module supports one antenna. All the modules and antennas are identical. When we test one module, another module will be disabled.		

5.2. MAXIMUM PEAK OUTPUT POWER

Test Mode	Frequency (MHz)	Channel Number	Maximum Peak Output Power (dBm)	Maximum EIRP (dBm)
GFSK	2402 ~ 2480	0-78[79]	2.83	5.83
π/4-DQPSK	2402 ~ 2480	0-78[79]	1.89	4.89

5.3. PACKET TYPE CONFIGURATION

Test Mode	Packet Type	Setting (Packet Length)
GFSK	DH1	27
	DH3	183
	DH5	339
π/4-DQPSK	2-DH1	54
	2-DH3	367
	2-DH5	679

5.4. CHANNEL LIST

Channel	Frequency (MHz)	Channel	Frequency (MHz)	Channel	Frequency (MHz)	Channel	Frequency (MHz)
00	2402	20	2422	40	2442	60	2462
01	2403	21	2423	41	2443	61	2463
02	2404	22	2424	42	2444	62	2464
03	2405	23	2425	43	2445	63	2465
04	2406	24	2426	44	2446	64	2466
05	2407	25	2427	45	2447	65	2467
06	2408	26	2428	46	2448	66	2468
07	2409	27	2429	47	2449	67	2469
08	2410	28	2430	48	2450	68	2470
09	2411	29	2431	49	2451	69	2471
10	2412	30	2432	50	2452	70	2472
11	2413	31	2433	51	2453	71	2473
12	2414	32	2434	52	2454	72	2474
13	2415	33	2435	53	2455	73	2475
14	2416	34	2436	54	2456	74	2476
15	2417	35	2437	55	2457	75	2477
16	2418	36	2438	56	2458	76	2478
17	2419	37	2439	57	2459	77	2479
18	2420	38	2440	58	2460	78	2480
19	2421	39	2441	59	2461	/	/

5.5. TEST CHANNEL CONFIGURATION

Test Mode	Test Channel	Frequency
GFSK-DH5	CH 0(Low Channel), CH 39(MID Channel), CH 78(High Channel)	2402 MHz, 2441 MHz, 2480 MHz
π/4-DQPSK	CH 0(Low Channel), CH 39(MID Channel), CH 78(High Channel)	2402 MHz, 2441 MHz, 2480 MHz
GFSK-DH5	Hopping	2402 MHz ~ 2480 MHz
π/4-DQPSK	Hopping	2402 MHz ~ 2480 MHz

5.6. WORST-CASE CONFIGURATIONS

Bluetooth Mode	Modulation Technology	Modulation Type	Data Rate (Mbps)
BR	FHSS	GFSK	1Mbit/s
EDR	FHSS	π/4-DQPSK	2Mbit/s

Note:

1. The EUT has two independent RF Modules, each RF module supports one antenna. All the modules and antennas are identical. When we test one module, another module will be disabled.

5.7. THE WORSE CASE POWER SETTING PARAMETER

The Worst Case Power Setting Parameter under 2400 ~ 2483.5MHz Band				
Test Software		FCC_assist 1.0.2.2		
Modulation Type	Transmit Antenna Number	Test Software setting value		
		CH 00	CH 39	CH 78
GFSK	1	9	9	9
π/4-DQPSK	1	9	9	9

5.8. DESCRIPTION OF AVAILABLE ANTENNAS

Antenna	Frequency (MHz)	Antenna Type	MAX Antenna Gain (dBi)
1	2402-2480	PCB	3

Note:

1.The EUT has two independent RF Modules, each RF module supports one antenna. All the modules and antennas are identical. When we test one module, another module will be disabled.

Test Mode	Transmit and Receive Mode	Description
GFSK	<input checked="" type="checkbox"/> 1TX, 1RX	Antenna 1 can be used as transmitting/receiving antenna.
π/4-DQPSK	<input checked="" type="checkbox"/> 1TX, 1RX	Antenna 1 can be used as transmitting/receiving antenna.

Note:

1.The value of the antenna gain was declared by customer.
 2.The EUT has two independent RF Modules, each RF module supports one antenna. All the modules and antennas are identical. When we test one module, another module will be disabled.

5.9. DESCRIPTION OF TEST SETUP

SUPPORT EQUIPMENT

Item	Equipment	Brand Name	Model Name	Remarks
1	Laptop	Lenovo	E42	/
2	Laptop	Lenovo	E42	/

I/O CABLES

Cable No	Port	Connector Type	Cable Type	Cable Length(m)	Remarks
1	USB	/	Type-C Cable	1.0	/

ACCESSORIES

Item	Accessory	Brand Name	Model Name	Description
/	Adapter	FEIYING	PS05L050K1000CU	Input: 100-240~, 50/60Hz, 0.25A Max Output: 5Vdc, 1A, 5W

TEST SETUP

The EUT can work in engineering mode with a software through a Laptop.

SETUP DIAGRAM FOR TESTS

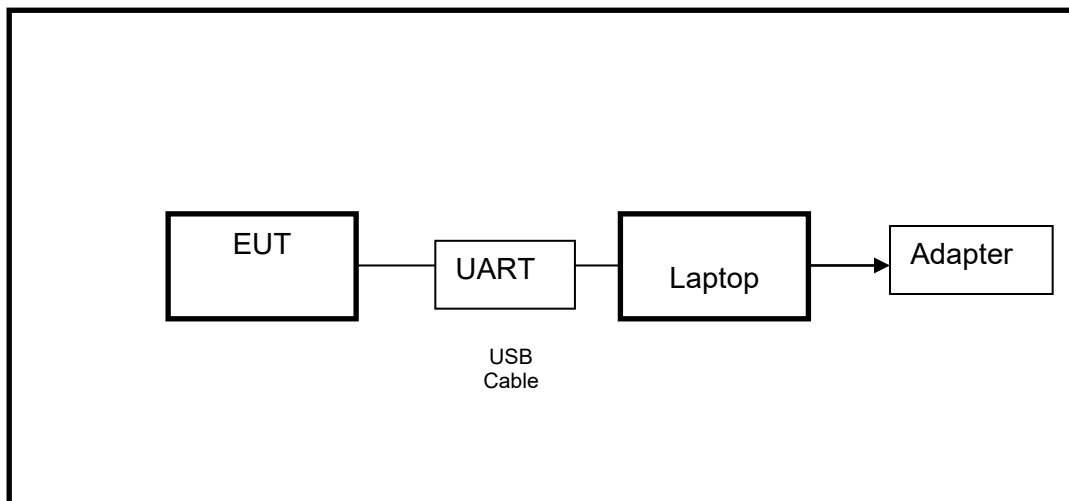

Note: AC adapter only use for AC POWER LINE CONDUCTED EMISSIONS testing.

**6. MEASURING INSTRUMENT AND SOFTWARE USED**

R&S TS 8997 Test System					
Equipment	Manufacturer	Model No.	Serial No.	Last Cal.	Due. Date
Power sensor, Power Meter	R&S	OSP120	100921	Mar.23,2021	Mar.22,2022
Vector Signal Generator	R&S	SMBV100A	261637	Oct.30, 2021	Oct.29, 2022
Signal Generator	R&S	SMB100A	178553	Oct.30, 2021	Oct.29, 2022
Signal Analyzer	R&S	FSV40	101118	Oct.30, 2021	Oct.29, 2022
Software					
Description	Manufacturer	Name		Version	
For R&S TS 8997 Test System	Rohde & Schwarz	EMC 32		10.60.10	
Tonsend RF Test System					
Equipment	Manufacturer	Model No.	Serial No.	Last Cal.	Due. Date
Wideband Radio Communication Tester	R&S	CMW500	155523	Oct.30, 2021	Oct.29, 2022
Wireless Connectivity Tester	R&S	CMW270	1201.0002N75-102	Sep.29, 2021	Sep.28, 2022
PXA Signal Analyzer	Keysight	N9030A	MY55410512	Oct.30, 2021	Oct.29, 2022
MXG Vector Signal Generator	Keysight	N5182B	MY56200284	Oct.30, 2021	Oct.29, 2022
MXG Vector Signal Generator	Keysight	N5172B	MY56200301	Oct.30, 2021	Oct.29, 2022
DC power supply	Keysight	E3642A	MY55159130	Oct.30, 2021	Oct.29, 2022
Temperature & Humidity Chamber	SANMOOD	SG-80-CC-2	2088	Nov.20,2020	Nov.19,2022
Software					
Description	Manufacturer	Name		Version	
Tonsend SRD Test System	Tonsend	JS1120-3 RF Test System		2.6.77.0518	



Radiated Emissions					
Equipment	Manufacturer	Model No.	Serial No.	Last Cal.	Due Date
MXE EMI Receiver	KESIGHT	N9038A	MY56400036	Oct.30, 2021	Oct.29, 2022
Hybrid Log Periodic Antenna	TDK	HLP-3003C	130959	Aug.02, 2021	Aug.01, 2024
Preamplifier	HP	8447D	2944A09099	Oct.30, 2021	Oct.29, 2022
EMI Measurement Receiver	R&S	ESR26	101377	Oct.30, 2021	Oct.29, 2022
Horn Antenna	TDK	HRN-0118	130940	July 20, 2021	July 19, 2024
Preamplifier	TDK	PA-02-0118	TRS-305-00067	Oct.30, 2021	Oct.29, 2022
Horn Antenna	Schwarzbeck	BBHA9170	697	July 20, 2021	July 19, 2024
Preamplifier	TDK	PA-02-2	TRS-307-00003	Oct.31, 2021	Oct.30, 2022
Preamplifier	TDK	PA-02-3	TRS-308-00002	Oct.31, 2021	Oct.30, 2022
Loop antenna	Schwarzbeck	1519B	00008	Dec.14, 2021	Dec.14, 2024
Preamplifier	TDK	PA-02-001-3000	TRS-302-00050	Oct.31, 2021	Oct.30, 2022
Preamplifier	Mini-Circuits	ZX60-83LN-S+	SUP01201941	Oct.31, 2021	Oct.30, 2022
High Pass Filter	Wi	WHKX10-2700-3000-18000-40SS	23	Oct.31, 2021	Oct.30, 2022
Band Reject Filter	Wainwright	WRCJV8-2350-2400-2483.5-2533.5-40SS	4	Oct.31, 2021	Oct.30, 2022
Software					
Description			Manufacturer	Name	Version
Test Software for Radiated Emissions			Farad	EZ-EMC	Ver. UL-3A1

7. ANTENNA PORT TEST RESULTS

7.1. ON TIME AND DUTY CYCLE

LIMITS

None; for reporting purposes only.

PROCEDURE

Refer to ANSI C63.10-2013 Zero – Span Spectrum Analyzer method.

TEST SETUP

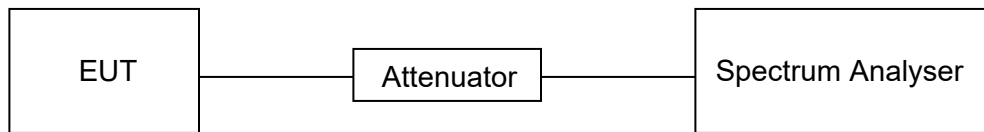

TEST ENVIRONMENT

Temperature	23.8 °C	Relative Humidity	54.9 %
Atmosphere Pressure	101 kPa	Test Voltage	DC 7.4 V

RESULTS

Please refer to appendix I.

7.2. 20 dB BANDWIDTH

LIMITS

CFR 47FCC Part15 (15.247) Subpart C			
Section	Test Item	Limit	Frequency Range (MHz)
CFR 47 FCC 15.247 (a) (1) RSS-247 Clause 5.1 (a)	20 dB Bandwidth	None; for reporting purposes only.	2400-2483.5

TEST PROCEDURE

Refer to ANSI C63.10-2013 clause 6.9.2.

Connect the EUT to the spectrum analyser and use the following settings:

Center Frequency	The center frequency of the channel under test
Detector	Peak
RBW	For 20 dB Bandwidth: 1 % to 5 % of the 20 dB bandwidth For 99 % Occupied Bandwidth: 1 % to 5 % of the occupied bandwidth
VBW	For 20 dB Bandwidth: approximately 3×RBW For 99 % Occupied Bandwidth: ≥ 3×RBW
Span	Approximately 2 to 3 times the 20dB bandwidth
Trace	Max hold
Sweep	Auto couple

a) Use the occupied bandwidth function of the instrument, allow the trace to stabilize and report the measured 20 dB Bandwidth.

TEST SETUP

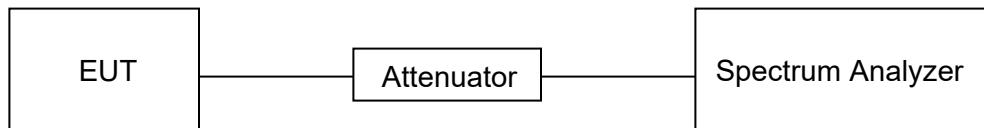



TEST ENVIRONMENT

Temperature	23.8 °C	Relative Humidity	54.9 %
Atmosphere Pressure	101 kPa	Test Voltage	DC 7.4 V

RESULTS

Please refer to appendix A and B.

7.3. CONDUCTED OUTPUT POWER

LIMITS

CFR 47 FCC Part15 (15.247), Subpart C			
Section	Test Item	Limit	Frequency Range (MHz)
CFR 47 FCC 15.247 (b) (1)	Peak Conducted Output Power	Hopping channel carrier frequencies separated by a minimum of 25 kHz or the 20 dB bandwidth of the hopping channel: 1 watt or 30 dBm; Hopping channel carrier frequencies that are separated by 25 kHz or two-thirds of the 20 dB bandwidth of the hopping channel: 125 mW or 21 dBm	2400-2483.5

TEST PROCEDURE

Connect the EUT to a low loss RF cable from the antenna port to the power sensor (video bandwidth is greater than the occupied bandwidth).
Measure peak emission level, the indicated level is the peak output power, after any corrections for external attenuators and cables.

TEST SETUP

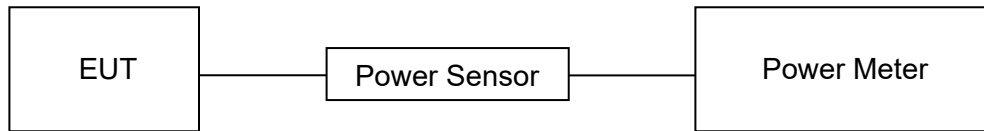

TEST ENVIRONMENT

Temperature	23.8 °C	Relative Humidity	54.9 %
Atmosphere Pressure	101 kPa	Test Voltage	DC 7.4 V

RESULTS

Please refer to appendix C.

7.4. CARRIER FREQUENCY SEPARATION

LIMITS

CFR 47 FCC Part15 (15.247)			
Section	Test Item	Limit	Frequency Range (MHz)
CFR 47 FCC 15.247 (a) (1)	Carrier Frequency Separation	Frequency hopping systems shall have hopping channel carrier frequencies separated by a minimum of 25 kHz or the 20 dB bandwidth of the hopping channel, whichever is greater. Alternatively, frequency hopping systems operating in the 2400-2483.5 MHz band may have hopping channel carrier frequencies that are separated by 25 kHz or two-thirds of the 20 dB bandwidth of the hopping channel.	2400-2483.5

TEST PROCEDURE

Refer to ANSI C63.10-2013 clause 7.8.2.

Connect the EUT to the spectrum analyzer and use the following settings:

Center Frequency	The center frequency of the channel under test
Span	wide enough to capture the peaks of two adjacent channels
Detector	Peak
RBW	Start with the RBW set to approximately 30 % of the channel spacing; adjust as necessary to best identify the center of each individual channel.
VBW	≥RBW
Trace	Max hold
Sweep time	Auto couple

Allow the trace to stabilize and use the marker-delta function to determine the separation between the peaks of the adjacent channels.

Compliance of an EUT with the appropriate regulatory limit shall be determined.

TEST SETUP

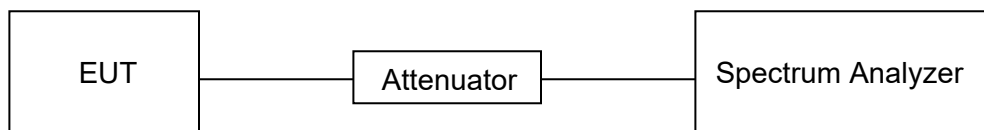



TEST ENVIRONMENT

Temperature	23.8 °C	Relative Humidity	54.9 %
Atmosphere Pressure	101 kPa	Test Voltage	DC 7.4 V

RESULTS

Please refer to Appendix D.

7.5. NUMBER OF HOPPING FREQUENCIES

LIMITS

CFR 47 FCC Part15 (15.247), Subpart C		
Section	Test Item	Limit
CFR 47 15.247 (a) (1) III	Number of Hopping Frequency	at least 15 hopping channels

TEST PROCEDURE

Refer to ANSI C63.10-2013 clause 7.8.3.

Connect the EUT to the spectrum Analyzer and use the following settings:

Detector	Peak
RBW	To identify clearly the individual channels, set the RBW to less than 30% of the channel spacing or the 20 dB bandwidth, whichever is smaller.
VBW	\geq RBW
Span	The frequency band of operation. Depending on the number of channels the device supports, it may be necessary to divide the frequency range of operation across multiple spans, to allow the individual channels to be clearly seen.
Trace	Max hold
Sweep time	Auto couple

Set EUT to transmit maximum output power and switch on frequency hopping function. then set enough count time (larger than 5000 times) to get all the hopping frequency channel displayed on the screen of spectrum analyzer, count the quantity of peaks to get the number of hopping channels.

TEST SETUP

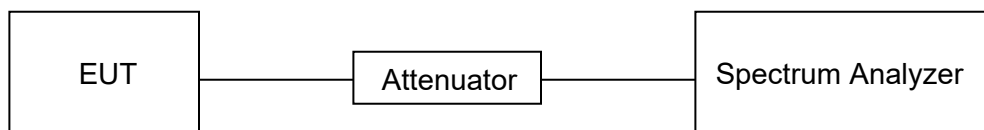



TEST ENVIRONMENT

Temperature	23.8 °C	Relative Humidity	54.9 %
Atmosphere Pressure	101 kPa	Test Voltage	DC 7.4 V

RESULTS

Please refer to appendix F.

7.6. TIME OF OCCUPANCY (DWELL TIME)

LIMITS

CFR 47 FCC Part15 (15.247), Subpart C		
Section	Test Item	Limit
CFR 47 15.247 (a) (1) III	Time of Occupancy (Dwell Time)	The average time of occupancy on any channel shall not be greater than 0.4 seconds within a period of 0.4 seconds, multiplied by the number of hopping channels employed.

TEST PROCEDURE

Refer to ANSI C63.10-2013 clause 7.8.4.

Connect the EUT to the spectrum Analyzer and use the following settings:

Center Frequency	The center frequency of the channel under test
Detector	Peak
RBW	1 MHz
VBW	≥RBW
Span	Zero span, centered on a hopping channel
Trace	Max hold
Sweep time	As necessary to capture the entire dwell time per hopping channel; where possible use a video trigger and trigger delay so that the transmitted signal starts a little to the right of the start of the plot. The trigger level might need slight adjustment to prevent triggering when the system hops on an adjacent channel

Use the marker-delta function to determine the transmit time per hop (Burst Width). If this value varies with different modes of operation (data rate, modulation format, number of hopping channels, etc.), then repeat this test for each variation in transmit time.

For FHSS Mode (79 Channel):

DH1/3DH1 Dwell Time: $\text{Burst Width} * (1600/2) * 31.6 / (\text{channel number})$

DH3/3DH3 Dwell Time: $\text{Burst Width} * (1600/4) * 31.6 / (\text{channel number})$

DH5/3DH5 Dwell Time: $\text{Burst Width} * (1600/6) * 31.6 / (\text{channel number})$

For AFHSS Mode (20 Channel):

DH1/3DH1 Dwell Time: $\text{Burst Width} * (800/2) * 8 / (\text{channel number})$

DH3/3DH3 Dwell Time: $\text{Burst Width} * (800/4) * 8 / (\text{channel number})$

DH5/3DH5 Dwell Time: $\text{Burst Width} * (800/6) * 8 / (\text{channel number})$



TEST SETUP

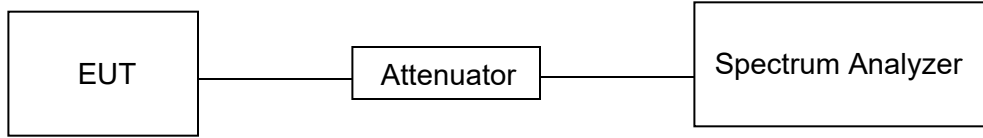

TEST ENVIRONMENT

Temperature	23.8 °C	Relative Humidity	54.9 %
Atmosphere Pressure	101 kPa	Test Voltage	DC 7.4 V

RESULTS

Please refer to appendix E.

7.7. CONDUCTED BANDEdge AND SPURIOUS EMISSION

LIMITS

CFR 47 FCC Part15 (15.247), Subpart C		
Section	Test Item	Limit
CFR 47 FCC §15.247 (d)	Conducted Spurious Emission	at least 20 dB below that in the 100 kHz bandwidth within the band that contains the highest level of the desired power

TEST PROCEDURE

Refer to ANSI C63.10-2013 clause 7.8.6 and 7.8.8.

Connect the EUT to the spectrum analyser and use the following settings for reference level measurement:

Center Frequency	The center frequency of the channel under test
Detector	Peak
RBW	100 kHz
VBW	$\geq 3 \times \text{RBW}$
Span	1.5 x DTS bandwidth
Trace	Max hold
Sweep time	Auto couple.

Allow trace to fully stabilize and use the peak marker function to determine the maximum PSD level.

Change the settings for emission level measurement:

Span	Set the center frequency and span to encompass frequency range to be measured
Detector	Peak
RBW	100 kHz
VBW	$\geq 3 \times \text{RBW}$
measurement points	$\geq \text{span}/\text{RBW}$
Trace	Max hold
Sweep time	Auto couple.

Allow trace to fully stabilize and use the peak marker function to determine the maximum PSD level. Ensure that the amplitude of all unwanted emissions outside of the authorized frequency band (excluding restricted frequency bands) is attenuated by at least the minimum requirements.



TEST SETUP

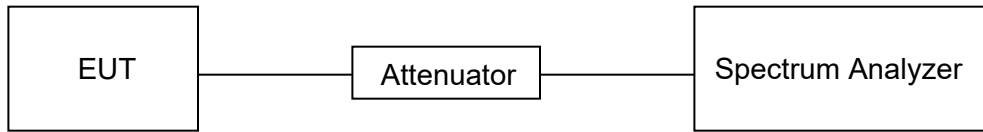

TEST ENVIRONMENT

Temperature	23.8 °C	Relative Humidity	54.9 %
Atmosphere Pressure	101 kPa	Test Voltage	DC 7.4 V

RESULTS

Please refer to appendix G & H.



8. RADIATED TEST RESULTS

LIMITS

Please refer to CFR 47 FCC §15.205 and §15.209.

Radiation Disturbance Test Limit for FCC (Class B) (9 kHz-1 GHz)

Emissions radiated outside of the specified frequency bands above 30 MHz		
Frequency Range (MHz)	Field Strength Limit (uV/m) at 3 m	Field Strength Limit (dBuV/m) at 3 m
		Quasi-Peak
30 - 88	100	40
88 - 216	150	43.5
216 - 960	200	46
Above 960	500	54
Above 1000	500	Peak
		Average
		74
		54

FCC Emissions radiated outside of the specified frequency bands below 30 MHz		
Frequency (MHz)	Field strength (microvolts/meter)	Measurement distance (meters)
0.009-0.490	2400/F(kHz)	300
0.490-1.705	24000/F(kHz)	30
1.705-30.0	30	30



FCC Restricted bands of operation refer to FCC §15.205 (a):

MHz	MHz	MHz	GHz
0.090-0.110	16.42-16.423	399.9-410	4.5-5.15
¹ 0.495-0.505	16.69475-16.69525	608-614	5.35-5.46
2.1735-2.1905	16.80425-16.80475	960-1240	7.25-7.75
4.125-4.128	25.5-25.67	1300-1427	8.025-8.5
4.17725-4.17775	37.5-38.25	1435-1626.5	9.0-9.2
4.20725-4.20775	73-74.6	1645.5-1646.5	9.3-9.5
6.215-6.218	74.8-75.2	1660-1710	10.6-12.7
6.26775-6.26825	108-121.94	1718.8-1722.2	13.25-13.4
6.31175-6.31225	123-138	2200-2300	14.47-14.5
8.291-8.294	149.9-150.05	2310-2390	15.35-16.2
8.362-8.366	156.52475-156.52525	2483.5-2500	17.7-21.4
8.37625-8.38675	156.7-156.9	2690-2900	22.01-23.12
8.41425-8.41475	162.0125-167.17	3260-3267	23.6-24.0
12.29-12.293	167.72-173.2	3332-3339	31.2-31.8
12.51975-12.52025	240-285	3345.8-3358	36.43-36.5
12.57675-12.57725	322-335.4	3600-4400	(²)
13.36-13.41			

Note: ¹Until February 1, 1999, this restricted band shall be 0.490-0.510 MHz.

²Above 38.6c

TEST SETUP AND PROCEDURE

Below 30 MHz

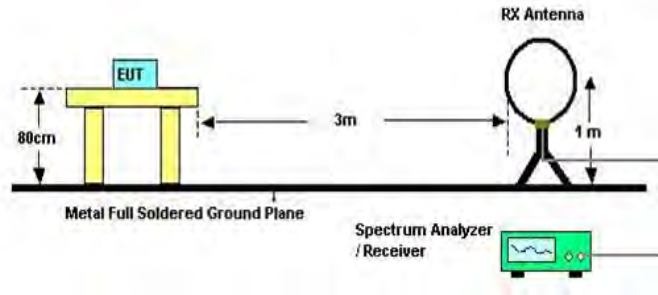

The setting of the spectrum analyser

RBW	200 Hz (From 9 kHz to 0.15 MHz)/ 9 kHz (From 0.15 MHz to 30 MHz)
VBW	200 Hz (From 9 kHz to 0.15 MHz)/ 9 kHz (From 0.15 MHz to 30 MHz)
Sweep	Auto

1. The testing follows the guidelines in ANSI C63.10-2013 clause 6.4.
2. The EUT was arranged to its worst case and then turntable (from 0 degree to 360 degrees) to find the maximum reading. A pre-amp and a high pass filter are used for the test in order to get better signal level. Both Horizontal, Face-on and Face-off polarizations of the antenna are set to make the measurement.
3. The EUT was placed on a turntable with 80 cm above ground.
4. The EUT was set 3 meters from the interference receiving antenna, which was mounted on the top of a 1 m height antenna tower.
5. The radiated emission limits are based on measurements employing a CISPR quasi-peak detector except for the frequency bands 9-90 kHz, 110-490 kHz and above 1000 MHz Radiated emission limits in these three bands are based on measurements employing an average detector.
6. For measurement below 1 GHz, the initial step in collecting conducted emission data is a spectrum analyzer peak detector mode pre-scanning the measurement frequency range. Significant peaks are then marked and then Quasi Peak and average detector mode re-measured. If the emission level of the EUT measured by the peak detector is 3 dB lower than the applicable limit, the peak emission level will be reported. Otherwise, the emission measurement will be repeated using the quasi-peak and average detector and reported.
7. Although these tests were performed other than open field site, adequate comparison measurements were confirmed against 30m open field site. Therefore sufficient tests were made to demonstrate that the alternative site produces results that correlate with the ones of tests made in an open field site based on KDB 414788.
8. The limits in CFR 47, Part 15, Subpart C, paragraph 15.209 (a), are identical to those in RSS-GEN Section 8.9, Table 6, since the measurements are performed in terms of magnetic field strength and converted to electric field strength levels (as reported in the table) using the free space impedance of 377Ω. For example, the measurement frequency X KHz resulted in a level of Y dBuV/m, which is equivalent to $Y-51.5 = Z$ dBuA/m, which has the same margin, W dB, to the corresponding RSS-GEN Table 6 limit as it has to be 15.209(a) limit.

Below 1 GHz and above 30 MHz

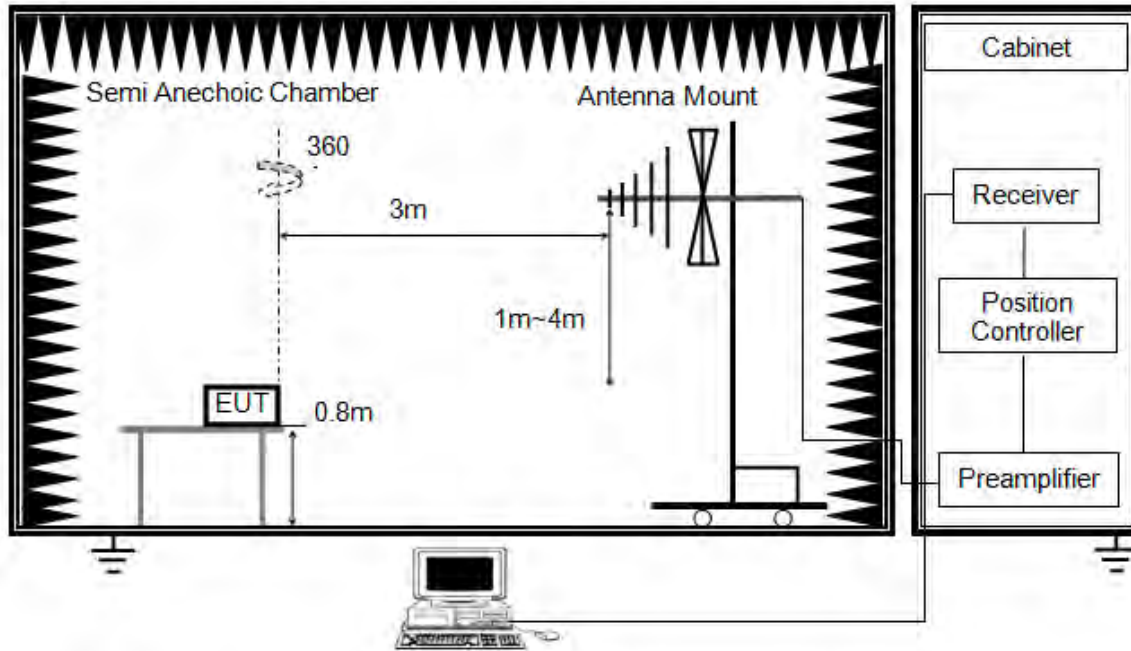

The setting of the spectrum analyser

RBW	120 kHz
VBW	300 kHz
Sweep	Auto
Detector	Peak/QP
Trace	Max hold

1. The testing follows the guidelines in ANSI C63.10-2013 clause 6.5.
2. The EUT was arranged to its worst case and then tune the antenna tower (from 1 m to 4 m) and turntable (from 0 degree to 360 degrees) to find the maximum reading. A pre-amp and a high pass filter are used for the test in order to get better signal level. Both horizontal and vertical polarizations of the antenna are set to make the measurement.
3. The EUT was placed on a turntable with 80 cm above ground.
4. The EUT was set 3 meters from the interference receiving antenna, which was mounted on the top of a variable height antenna tower.
5. For measurement below 1 GHz, the initial step in collecting conducted emission data is a spectrum analyzer peak detector mode pre-scanning the measurement frequency range. Significant peaks are then marked and then Quasi Peak detector mode re-measured. If the emission level of the EUT measured by the peak detector is 3 dB lower than the applicable limit, the peak emission level will be reported. Otherwise, the emission measurement will be repeated using the quasi-peak detector and reported.

Above 1 GHz

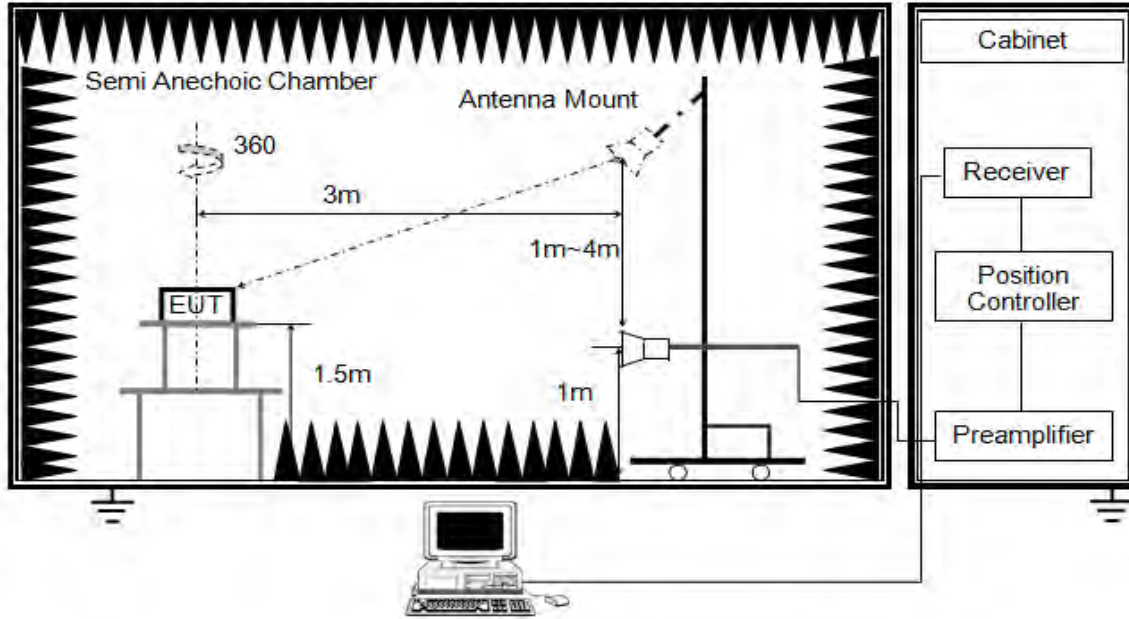

The setting of the spectrum analyser

RBW	1 MHz
VBW	PEAK: 3 MHz AVG: see note 6
Sweep	Auto
Detector	Peak
Trace	Max hold

1. The testing follows the guidelines in ANSI C63.10-2013 clause 6.6.
2. The EUT was arranged to its worst case and then tune the antenna tower (from 1 m to 4 m) and turntable (from 0 degree to 360 degrees) to find the maximum reading. A pre-amp and a high pass filter are used for the test in order to get better signal level. Both horizontal and vertical polarizations of the antenna are set to make the measurement.
3. The EUT was placed on a turntable with 1.5 m above ground.
4. The EUT was set 3 meters from the interference receiving antenna, which was mounted on the top of a variable height antenna tower.
5. For measurement above 1 GHz, the emission measurement will be measured by the peak detector. This peak level, once corrected, must comply with the limit specified in Section 15.209.
6. For measurements above 1 GHz the resolution bandwidth is set to 1 MHz, then the video bandwidth is set to 3 MHz for peak measurements and 1 MHz resolution bandwidth with 1/T video bandwidth with peak detector for average measurements. For the Duty Cycle please refer to clause 7.1.ON TIME AND DUTY CYCLE.

X axis, Y axis, Z axis positions:

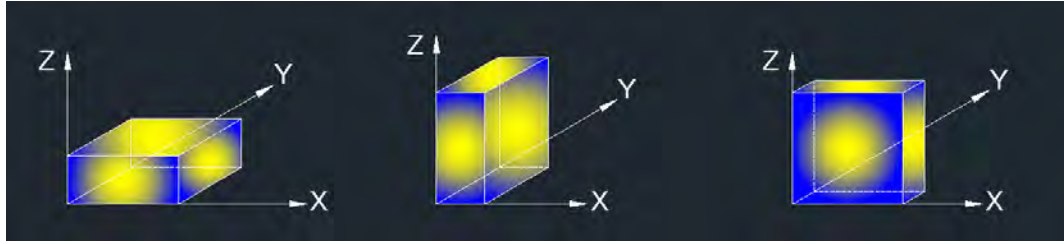

Note 1: For all radiated test, EUT in each of three orthogonal axis emissions had been tested, but only the worst case (X axis) data recorded in the report.

TEST ENVIRONMENT

Temperature	24.3 °C	Relative Humidity	61 %
Atmosphere Pressure	101 kPa	Test Voltage	DC 7.4 V

RESULTS

8.1. RESTRICTED BANDEDGE

8.1.1. GFSK MODE

RESTRICTED BANDEDGE (LOW CHANNEL, HORIZONTAL)

PEAK

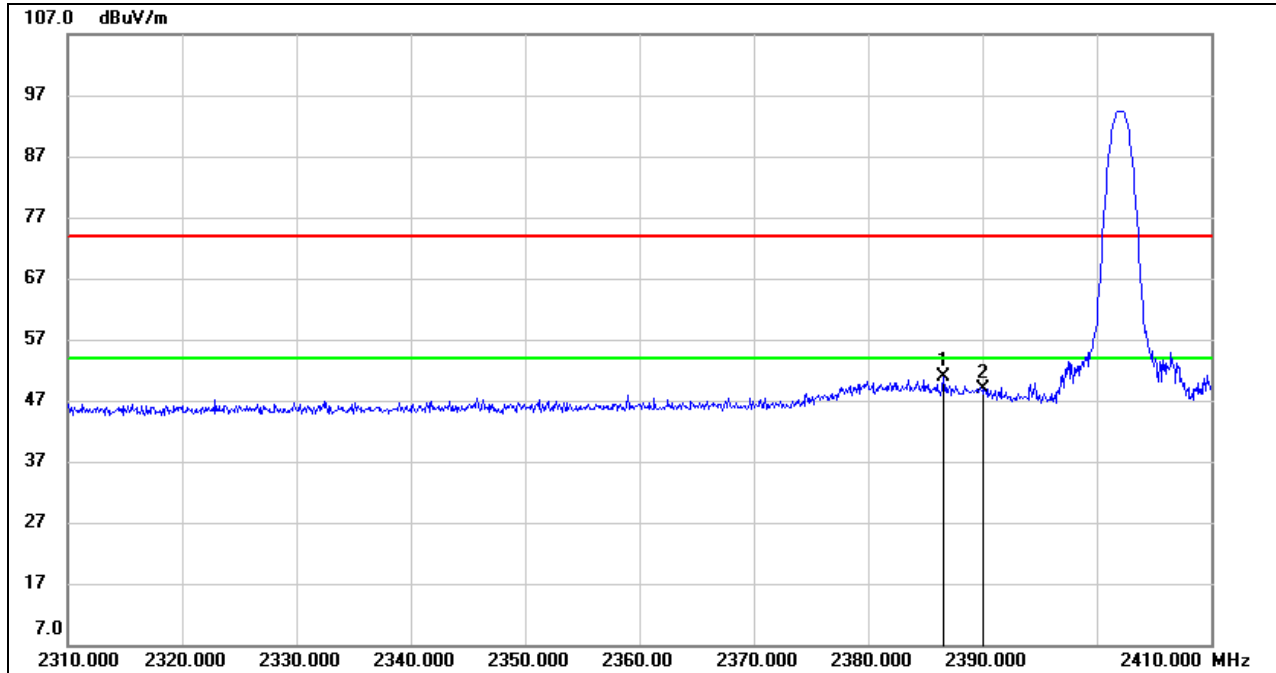

No.	Frequency (MHz)	Reading (dBuV)	Correct (dB/m)	Result (dBuV/m)	Limit (dBuV/m)	Margin (dB)	Remark
1	2386.600	18.20	32.64	50.84	74.00	-23.16	peak
2	2390.000	16.18	32.66	48.84	74.00	-25.16	peak

Note: 1. Measurement = Reading Level + Correct Factor.
 2. If Peak Result complies with AV limit, AV Result is deemed to comply with AV limit.
 3. Peak: Peak detector.
 4. Only the worst data was recorded, if it complies with the limit, the other emissions deemed to comply with the limit.

RESTRICTED BANDEDGE (LOW CHANNEL, VERTICAL)

PEAK

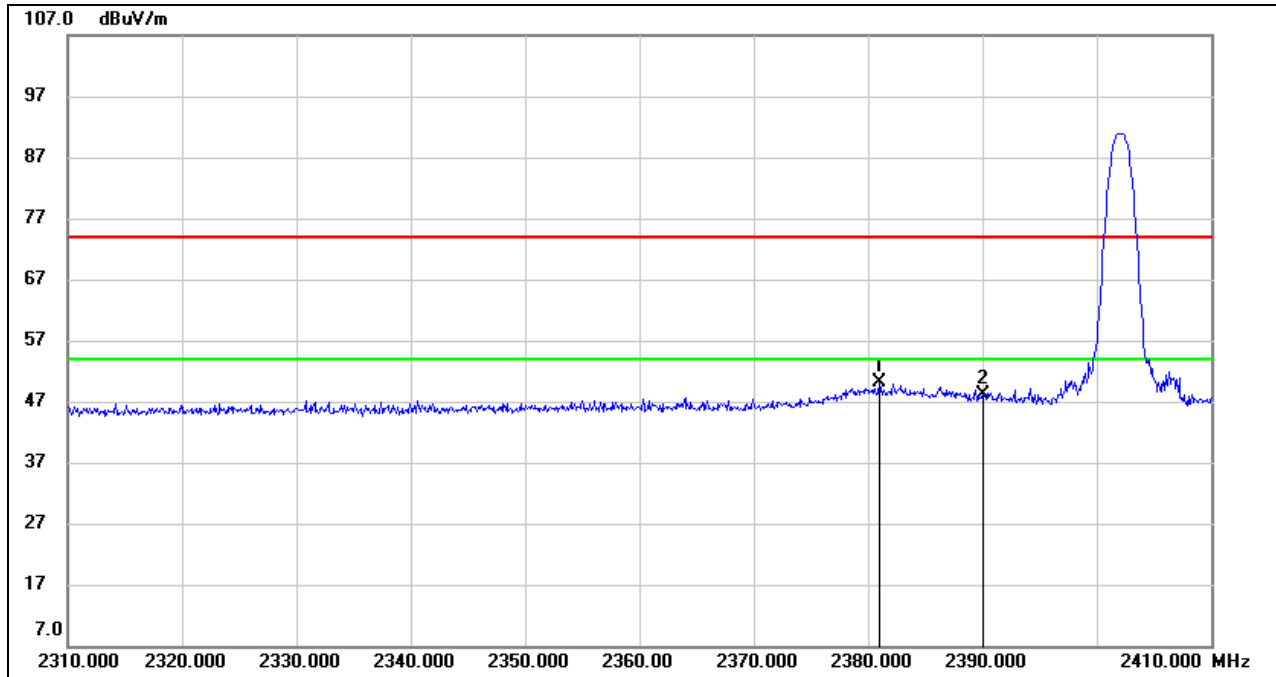

No.	Frequency (MHz)	Reading (dBuV)	Correct (dB/m)	Result (dBuV/m)	Limit (dBuV/m)	Margin (dB)	Remark
1	2381.000	17.49	32.59	50.08	74.00	-23.92	peak
2	2390.000	15.54	32.66	48.20	74.00	-25.80	peak

- Note: 1. Measurement = Reading Level + Correct Factor.
 2. If Peak Result complies with AV limit, AV Result is deemed to comply with AV limit.
 3. Peak: Peak detector.
 4. Only the worst data was recorded, if it complies with the limit, the other emissions deemed to comply with the limit.



RESTRICTED BANDEDGE (HIGH CHANNEL, HORIZONTAL)

PEAK

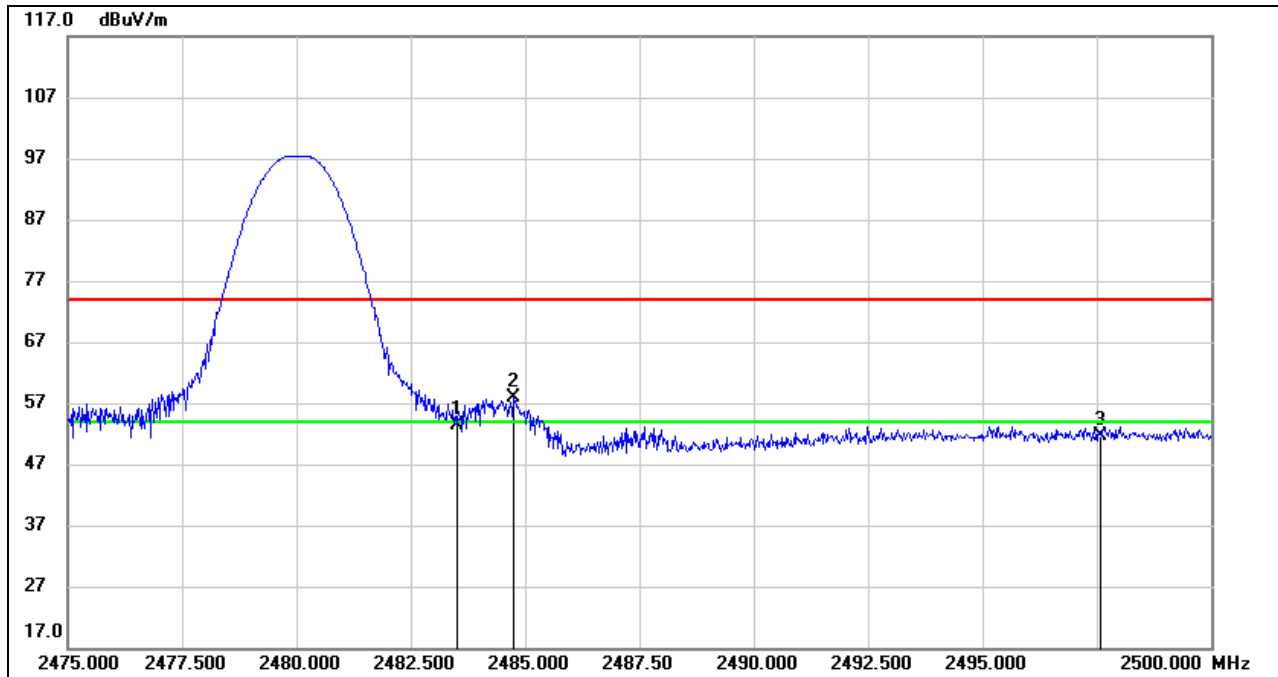

No.	Frequency (MHz)	Reading (dBuV)	Correct (dB/m)	Result (dBuV/m)	Limit (dBuV/m)	Margin (dB)	Remark
1	2483.500	20.35	33.10	53.45	74.00	-20.55	peak
2	2484.750	24.80	33.10	57.90	74.00	-16.10	peak
3	2497.575	18.38	33.15	51.53	74.00	-22.47	peak

Note: 1. Measurement = Reading Level + Correct Factor.
 2. If Peak Result complies with AV limit, AV Result is deemed to comply with AV limit.
 3. Peak: Peak detector.
 4. Only the worst data was recorded, if it complies with the limit, the other emissions deemed to comply with the limit.

AVG

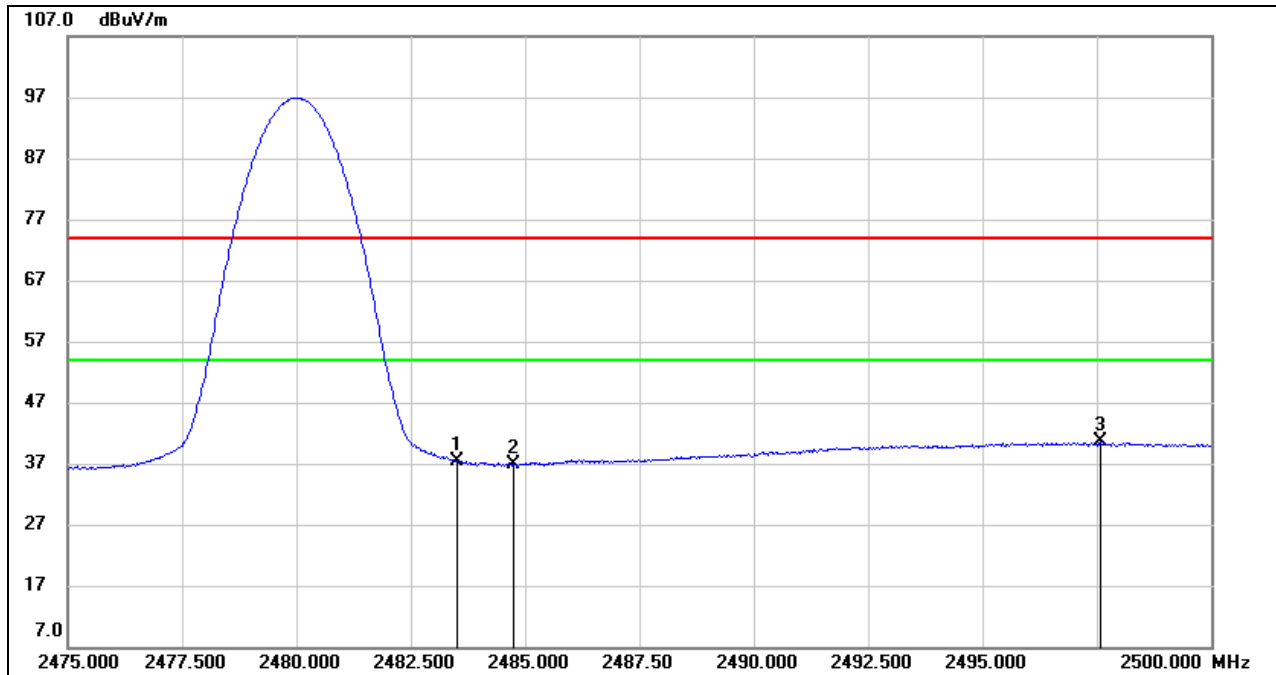

No.	Frequency (MHz)	Reading (dBuV)	Correct (dB/m)	Result (dBuV/m)	Limit (dBuV/m)	Margin (dB)	Remark
1	2483.500	4.38	33.10	37.48	54.00	-16.52	AVG
2	2484.750	3.77	33.10	36.87	54.00	-17.13	AVG
3	2497.575	7.36	33.15	40.51	54.00	-13.49	AVG

Note: 1. Measurement = Reading Level + Correct Factor.
 2. If Peak Result complies with AV limit, AV Result is deemed to comply with AV limit.
 3. Peak: Peak detector.
 4. Only the worst data was recorded, if it complies with the limit, the other emissions deemed to comply with the limit.

Note: All the polarities (Vertical & Horizontal) had been tested, only the worst data was recorded in the report.

8.1.2. □/4-DQPSK MODE

RESTRICTED BANDEDGE (LOW CHANNEL, HORIZONTAL)

PEAK

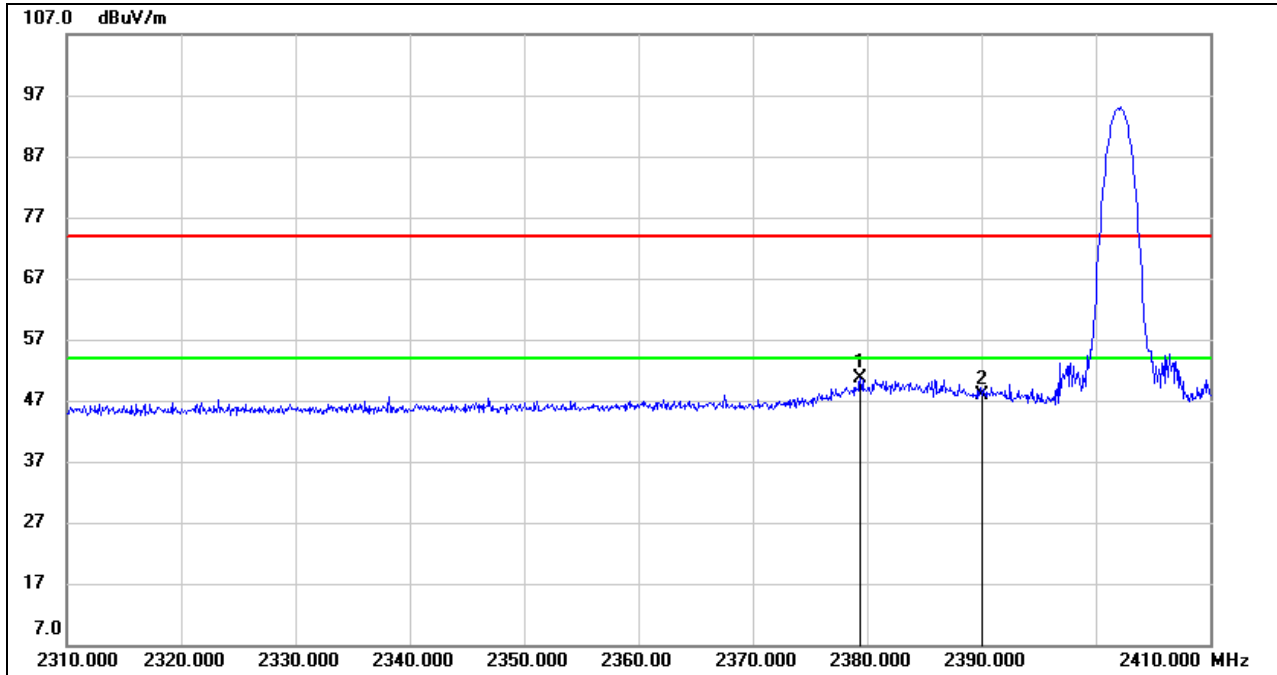

No.	Frequency (MHz)	Reading (dBuV)	Correct (dB/m)	Result (dBuV/m)	Limit (dBuV/m)	Margin (dB)	Remark
1	2379.400	17.97	32.58	50.55	74.00	-23.45	peak
2	2390.000	15.21	32.66	47.87	74.00	-26.13	peak

- Note: 1. Measurement = Reading Level + Correct Factor.
 2. If Peak Result complies with AV limit, AV Result is deemed to comply with AV limit.
 3. Peak: Peak detector.
 4. Only the worst data was recorded, if it complies with the limit, the other emissions deemed to comply with the limit.

RESTRICTED BANDEDGE (HIGH CHANNEL, HORIZONTAL)

PEAK

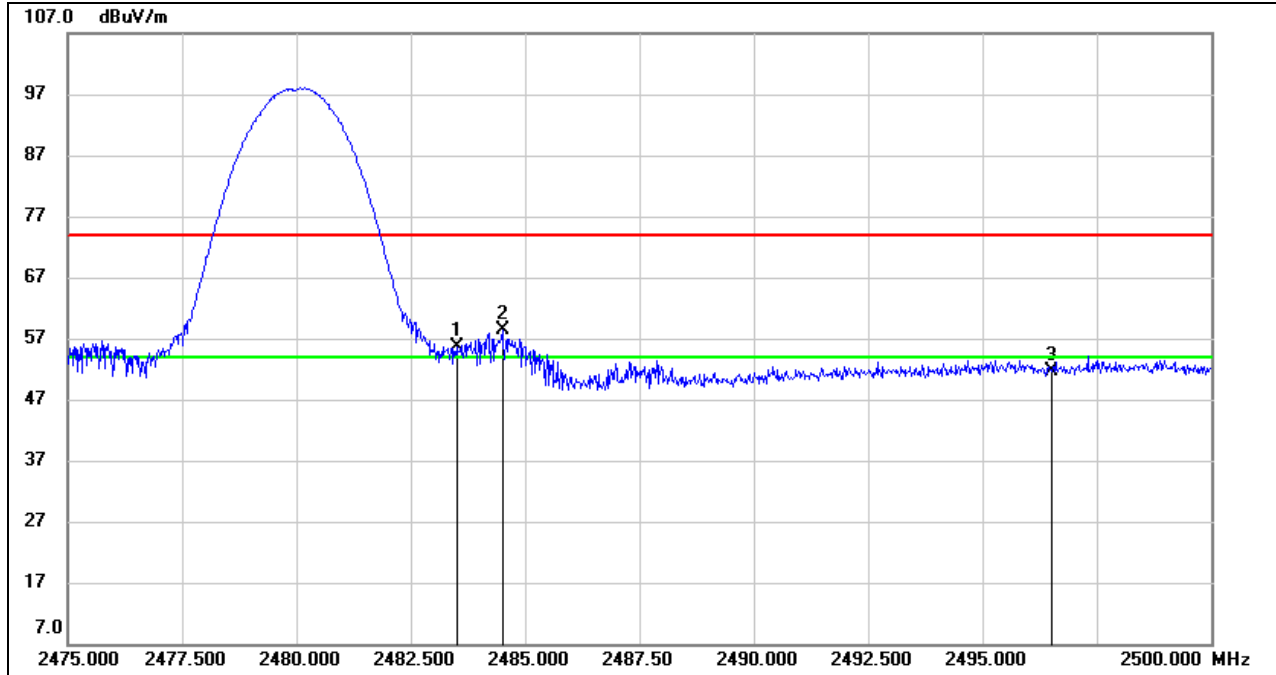

No.	Frequency (MHz)	Reading (dBuV)	Correct (dB/m)	Result (dBuV/m)	Limit (dBuV/m)	Margin (dB)	Remark
1	2483.500	22.61	33.10	55.71	74.00	-18.29	peak
2	2484.500	25.31	33.10	58.41	74.00	-15.59	peak
3	2496.525	18.41	33.14	51.55	74.00	-22.45	peak

Note: 1. Measurement = Reading Level + Correct Factor.
 2. If Peak Result complies with AV limit, AV Result is deemed to comply with AV limit.
 3. Peak: Peak detector.
 4. Only the worst data was recorded, if it complies with the limit, the other emissions deemed to comply with the limit.

AVG

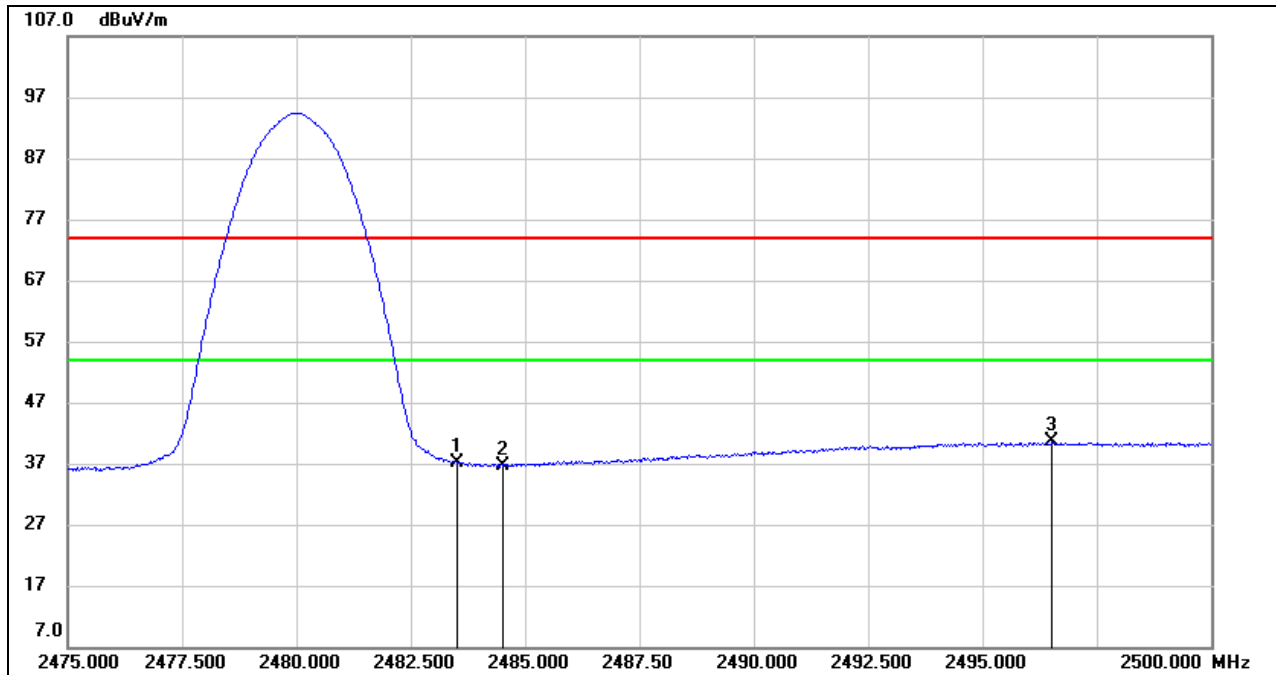

No.	Frequency (MHz)	Reading (dBuV)	Correct (dB/m)	Result (dBuV/m)	Limit (dBuV/m)	Margin (dB)	Remark
1	2483.500	4.07	33.10	37.17	54.00	-16.83	AVG
2	2484.500	3.63	33.10	36.73	54.00	-17.27	AVG
3	2496.525	7.40	33.14	40.54	54.00	-13.46	AVG

Note: 1. Measurement = Reading Level + Correct Factor.
 2. If Peak Result complies with AV limit, AV Result is deemed to comply with AV limit.
 3. Peak: Peak detector.
 4. Only the worst data was recorded, if it complies with the limit, the other emissions deemed to comply with the limit.

Note: All the polarities (Vertical & Horizontal) had been tested, only the worst data was recorded in the report.

8.2. SPURIOUS EMISSIONS (1 GHz ~ 3 GHz)

8.2.1. GFSK MODE

HARMONICS AND SPURIOUS EMISSIONS (LOW CHANNEL, HORIZONTAL)

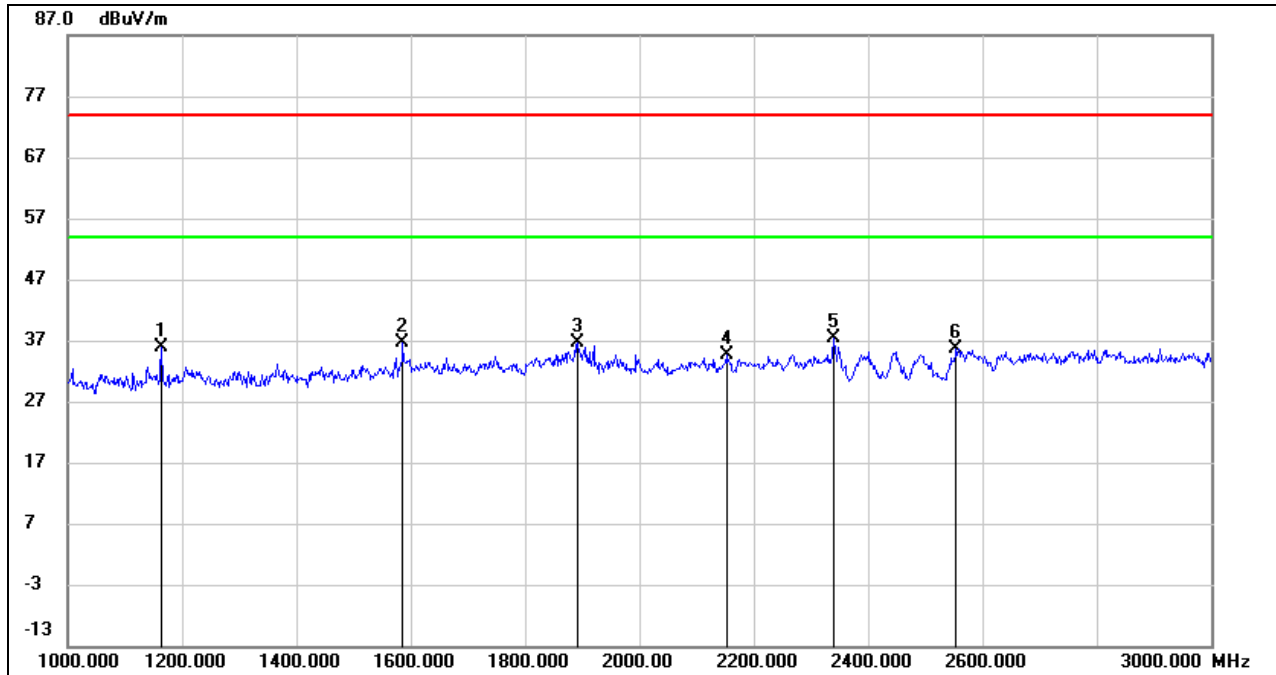

No.	Frequency (MHz)	Reading (dBuV)	Correct (dB/m)	Result (dBuV/m)	Limit (dBuV/m)	Margin (dB)	Remark
1	1164.000	49.88	-13.95	35.93	74.00	-38.07	peak
2	1586.000	48.56	-11.92	36.64	74.00	-37.36	peak
3	1892.000	47.27	-10.76	36.51	74.00	-37.49	peak
4	2153.000	44.57	-10.00	34.57	74.00	-39.43	peak
5	2341.000	46.46	-9.17	37.29	74.00	-36.71	peak
6	2554.000	44.20	-8.63	35.57	74.00	-38.43	peak

Note:

1. Peak Result = Reading Level + Correct Factor.
2. If Peak Result complies with AV limit, AV Result is deemed to comply with AV limit.
3. Peak: Peak detector.
4. Filter losses were only considered in the spurious frequency bands and the authorized band was not corrected for Band reject filter losses.
5. Proper operation of the transmitter prior to adding the filter to the measurement chain.

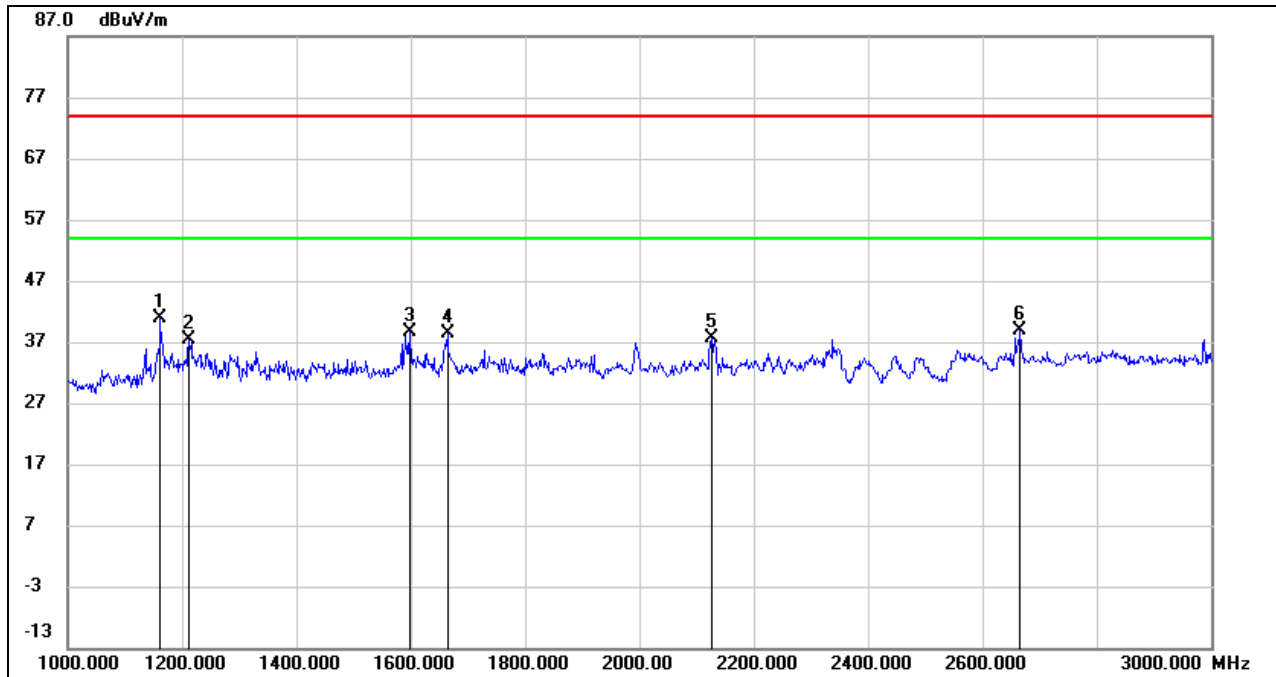
HARMONICS AND SPURIOUS EMISSIONS (LOW CHANNEL, VERTICAL)

No.	Frequency (MHz)	Reading (dBuV)	Correct (dB/m)	Result (dBuV/m)	Limit (dBuV/m)	Margin (dB)	Remark
1	1162.000	54.84	-13.97	40.87	74.00	-33.13	peak
2	1213.000	50.94	-13.67	37.27	74.00	-36.73	peak
3	1598.000	50.53	-11.86	38.67	74.00	-35.33	peak
4	1665.000	49.71	-11.43	38.28	74.00	-35.72	peak
5	2126.000	47.77	-10.17	37.60	74.00	-36.40	peak
6	2666.000	47.12	-8.27	38.85	74.00	-35.15	peak

Note:

1. Peak Result = Reading Level + Correct Factor.
2. If Peak Result complies with AV limit, AV Result is deemed to comply with AV limit.
3. Peak: Peak detector.
4. Filter losses were only considered in the spurious frequency bands and the authorized band was not corrected for Band reject filter losses.
5. Proper operation of the transmitter prior to adding the filter to the measurement chain.

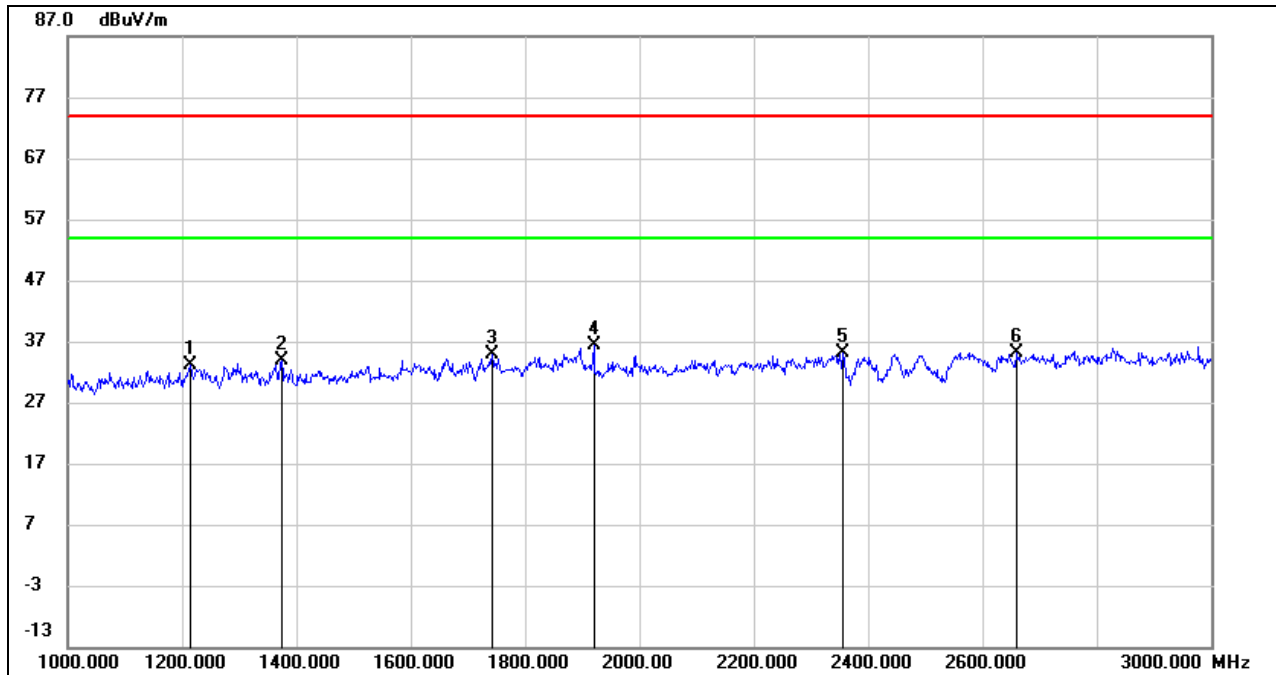
HARMONICS AND SPURIOUS EMISSIONS (MID CHANNEL, HORIZONTAL)

No.	Frequency (MHz)	Reading (dBuV)	Correct (dB/m)	Result (dBuV/m)	Limit (dBuV/m)	Margin (dB)	Remark
1	1214.000	46.73	-13.66	33.07	74.00	-40.93	peak
2	1375.000	46.95	-13.14	33.81	74.00	-40.19	peak
3	1742.000	45.87	-10.95	34.92	74.00	-39.08	peak
4	1920.000	47.07	-10.81	36.26	74.00	-37.74	peak
5	2356.000	44.24	-9.11	35.13	74.00	-38.87	peak
6	2660.000	43.31	-8.30	35.01	74.00	-38.99	peak

Note:

1. Peak Result = Reading Level + Correct Factor.
2. If Peak Result complies with AV limit, AV Result is deemed to comply with AV limit.
3. Peak: Peak detector.
4. Filter losses were only considered in the spurious frequency bands and the authorized band was not corrected for Band reject filter losses.
5. Proper operation of the transmitter prior to adding the filter to the measurement chain.

HARMONICS AND SPURIOUS EMISSIONS (MID CHANNEL, VERTICAL)

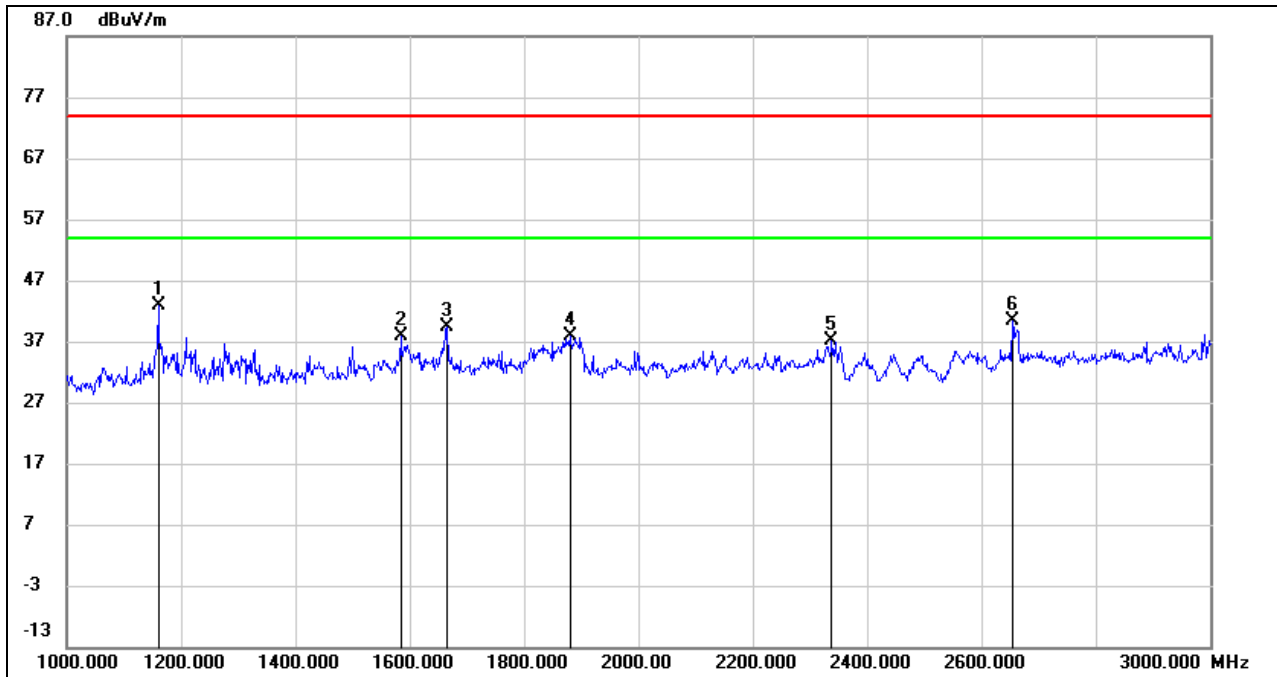

No.	Frequency (MHz)	Reading (dBuV)	Correct (dB/m)	Result (dBuV/m)	Limit (dBuV/m)	Margin (dB)	Remark
1	1160.000	56.84	-13.98	42.86	74.00	-31.14	peak
2	1585.000	49.75	-11.94	37.81	74.00	-36.19	peak
3	1665.000	50.70	-11.43	39.27	74.00	-34.73	peak
4	1880.000	48.61	-10.73	37.88	74.00	-36.12	peak
5	2338.000	46.35	-9.18	37.17	74.00	-36.83	peak
6	2654.000	48.79	-8.32	40.47	74.00	-33.53	peak

Note:

1. Peak Result = Reading Level + Correct Factor.
2. If Peak Result complies with AV limit, AV Result is deemed to comply with AV limit.
3. Peak: Peak detector.
4. Filter losses were only considered in the spurious frequency bands and the authorized band was not corrected for Band reject filter losses.
5. Proper operation of the transmitter prior to adding the filter to the measurement chain.

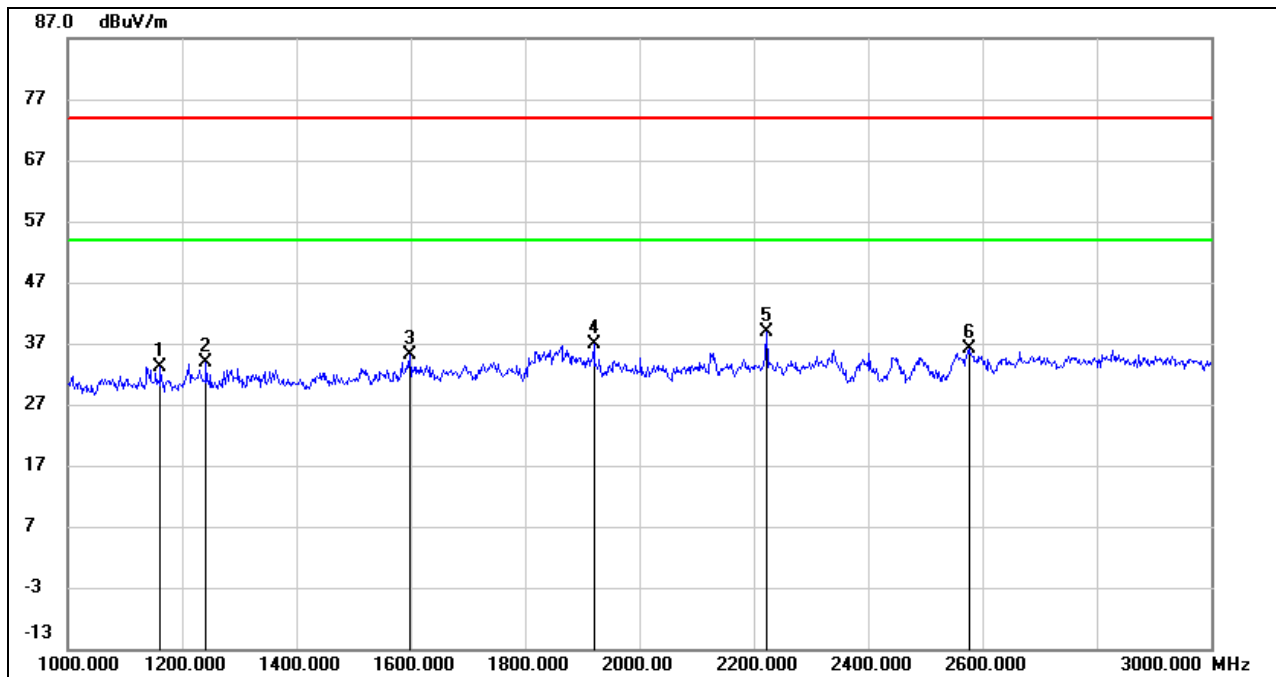
HARMONICS AND SPURIOUS EMISSIONS (HIGH CHANNEL, HORIZONTAL)

No.	Frequency (MHz)	Reading (dBuV)	Correct (dB/m)	Result (dBuV/m)	Limit (dBuV/m)	Margin (dB)	Remark
1	1163.000	47.01	-13.96	33.05	74.00	-40.95	peak
2	1243.000	47.40	-13.57	33.83	74.00	-40.17	peak
3	1598.000	47.09	-11.86	35.23	74.00	-38.77	peak
4	1920.000	47.58	-10.81	36.77	74.00	-37.23	peak
5	2222.000	48.43	-9.62	38.81	74.00	-35.19	peak
6	2577.000	44.64	-8.61	36.03	74.00	-37.97	peak

Note:

1. Peak Result = Reading Level + Correct Factor.
2. If Peak Result complies with AV limit, AV Result is deemed to comply with AV limit.
3. Peak: Peak detector.
4. Filter losses were only considered in the spurious frequency bands and the authorized band was not corrected for Band reject filter losses.
5. Proper operation of the transmitter prior to adding the filter to the measurement chain.

HARMONICS AND SPURIOUS EMISSIONS (HIGH CHANNEL, VERTICAL)

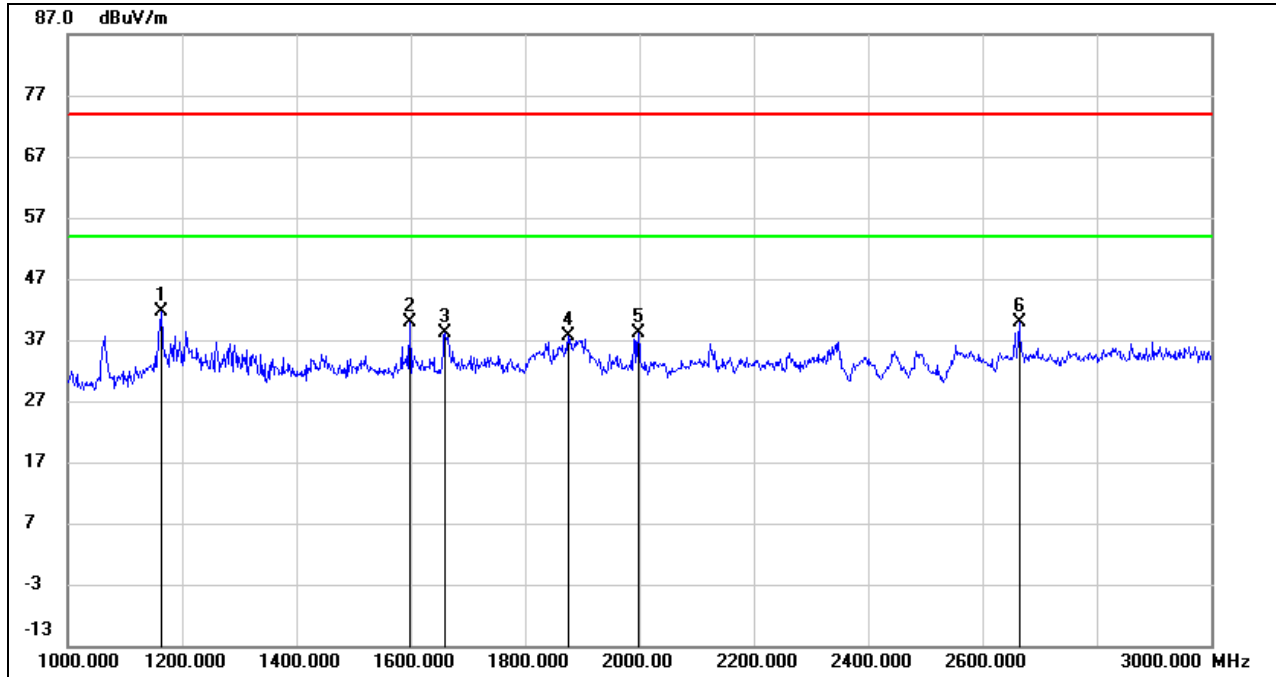

No.	Frequency (MHz)	Reading (dBuV)	Correct (dB/m)	Result (dBuV/m)	Limit (dBuV/m)	Margin (dB)	Remark
1	1164.000	55.55	-13.95	41.60	74.00	-32.40	peak
2	1599.000	51.81	-11.85	39.96	74.00	-34.04	peak
3	1660.000	49.57	-11.47	38.10	74.00	-35.90	peak
4	1877.000	48.30	-10.73	37.57	74.00	-36.43	peak
5	1999.000	49.10	-10.96	38.14	74.00	-35.86	peak
6	2665.000	48.07	-8.27	39.80	74.00	-34.20	peak

Note:

1. Peak Result = Reading Level + Correct Factor.
2. If Peak Result complies with AV limit, AV Result is deemed to comply with AV limit.
3. Peak: Peak detector.
4. Filter losses were only considered in the spurious frequency bands and the authorized band was not corrected for Band reject filter losses.
5. Proper operation of the transmitter prior to adding the filter to the measurement chain.

Note: All the modes and channels had been tested, but only the worst data was recorded in the report.

8.3. SPURIOUS EMISSIONS (3 GHz ~ 18 GHz)

8.3.1. GFSK MODE

HARMONICS AND SPURIOUS EMISSIONS (LOW CHANNEL, HORIZONTAL)

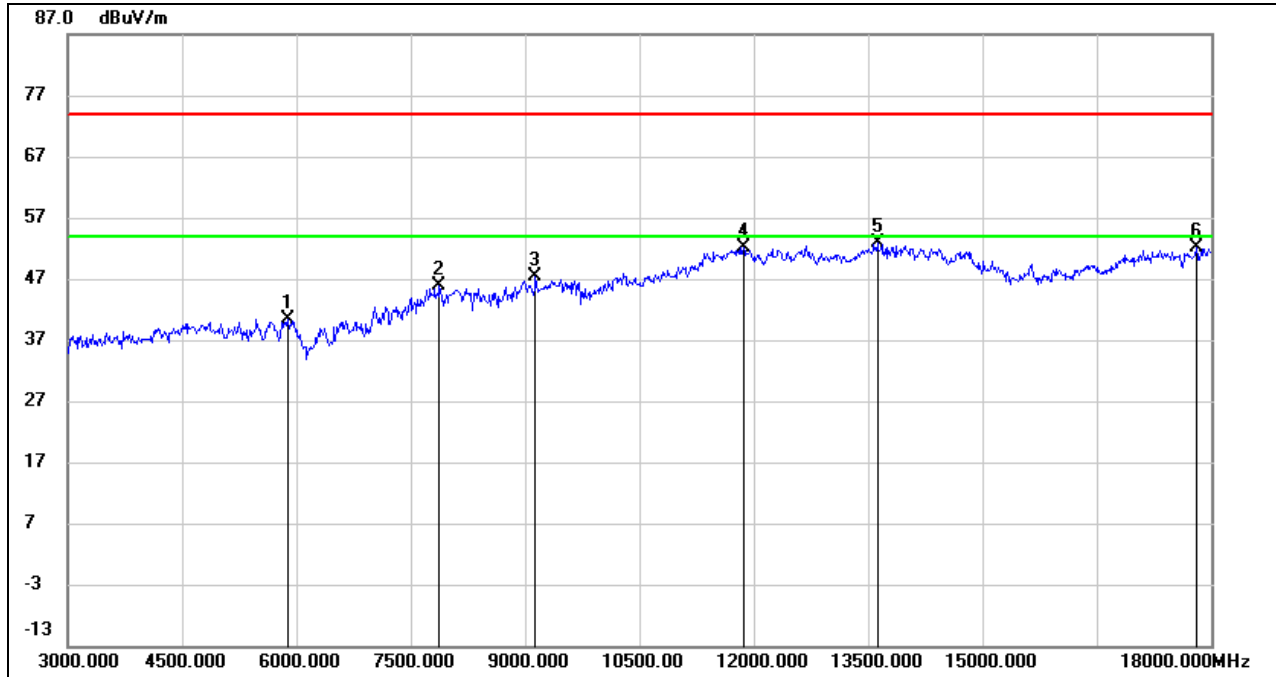

No.	Frequency (MHz)	Reading (dBuV)	Correct (dB/m)	Result (dBuV/m)	Limit (dBuV/m)	Margin (dB)	Remark
1	5887.500	37.95	2.50	40.45	74.00	-33.55	peak
2	7875.000	39.02	6.75	45.77	74.00	-28.23	peak
3	9142.500	38.18	9.11	47.29	74.00	-26.71	peak
4	11872.500	34.95	17.11	52.06	74.00	-21.94	peak
5	13627.500	32.26	20.57	52.83	74.00	-21.17	peak
6	17805.000	27.50	24.53	52.03	74.00	-21.97	peak

- Note: 1. Peak Result = Reading Level + Correct Factor.
 2. If Peak Result complies with AV limit, AV Result is deemed to comply with AV limit.
 3. Peak: Peak detector.
 4. Filter losses were only considered in the spurious frequency bands and the authorized band was not corrected for High Pass Filter losses.
 5. Proper operation of the transmitter prior to adding the filter to the measurement chain.

HARMONICS AND SPURIOUS EMISSIONS (LOW CHANNEL, VERTICAL)

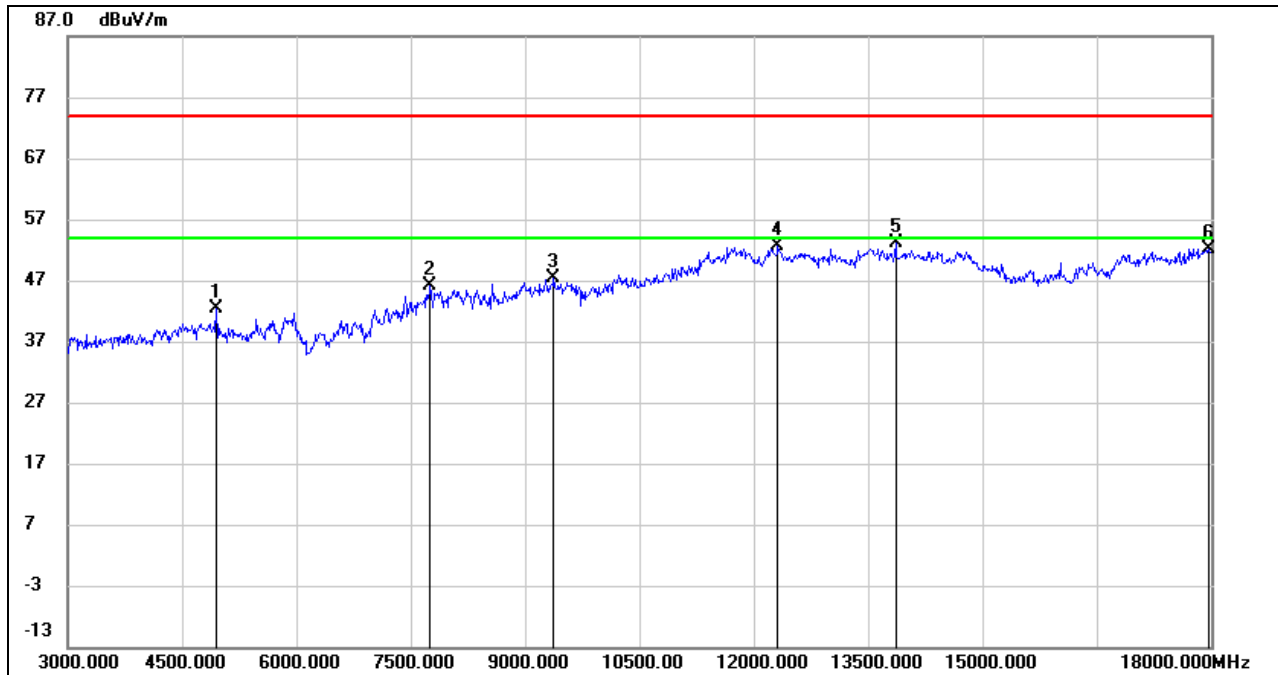

No.	Frequency (MHz)	Reading (dBuV)	Correct (dB/m)	Result (dBuV/m)	Limit (dBuV/m)	Margin (dB)	Remark
1	4957.500	42.60	-0.18	42.42	74.00	-31.58	peak
2	7762.500	39.23	6.87	46.10	74.00	-27.90	peak
3	9382.500	37.12	10.21	47.33	74.00	-26.67	peak
4	12322.500	34.91	17.64	52.55	74.00	-21.45	peak
5	13860.000	32.02	21.18	53.20	74.00	-20.80	peak
6	17977.500	27.02	25.14	52.16	74.00	-21.84	peak

- Note: 1. Peak Result = Reading Level + Correct Factor.
 2. If Peak Result complies with AV limit, AV Result is deemed to comply with AV limit.
 3. Peak: Peak detector.
 4. Filter losses were only considered in the spurious frequency bands and the authorized band was not corrected for High Pass Filter losses.
 5. Proper operation of the transmitter prior to adding the filter to the measurement chain.

HARMONICS AND SPURIOUS EMISSIONS (MID CHANNEL, HORIZONTAL)

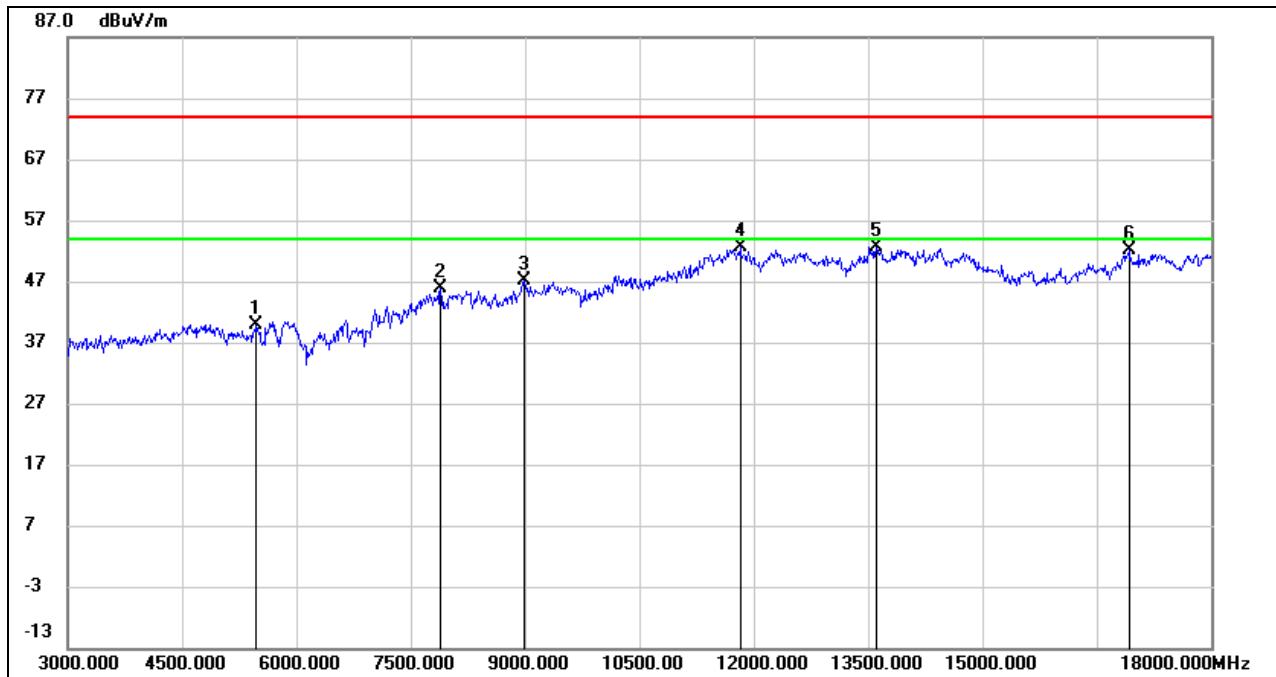

No.	Frequency (MHz)	Reading (dBuV)	Correct (dB/m)	Result (dBuV/m)	Limit (dBuV/m)	Margin (dB)	Remark
1	5482.500	38.43	1.55	39.98	74.00	-34.02	peak
2	7890.000	39.09	6.67	45.76	74.00	-28.24	peak
3	8985.000	37.30	9.86	47.16	74.00	-26.84	peak
4	11820.000	35.70	16.92	52.62	74.00	-21.38	peak
5	13605.000	32.11	20.42	52.53	74.00	-21.47	peak
6	16927.500	32.01	20.13	52.14	74.00	-21.86	peak

- Note: 1. Peak Result = Reading Level + Correct Factor.
 2. If Peak Result complies with AV limit, AV Result is deemed to comply with AV limit.
 3. Peak: Peak detector.
 4. Filter losses were only considered in the spurious frequency bands and the authorized band was not corrected for High Pass Filter losses.
 5. Proper operation of the transmitter prior to adding the filter to the measurement chain.

HARMONICS AND SPURIOUS EMISSIONS (MID CHANNEL, VERTICAL)

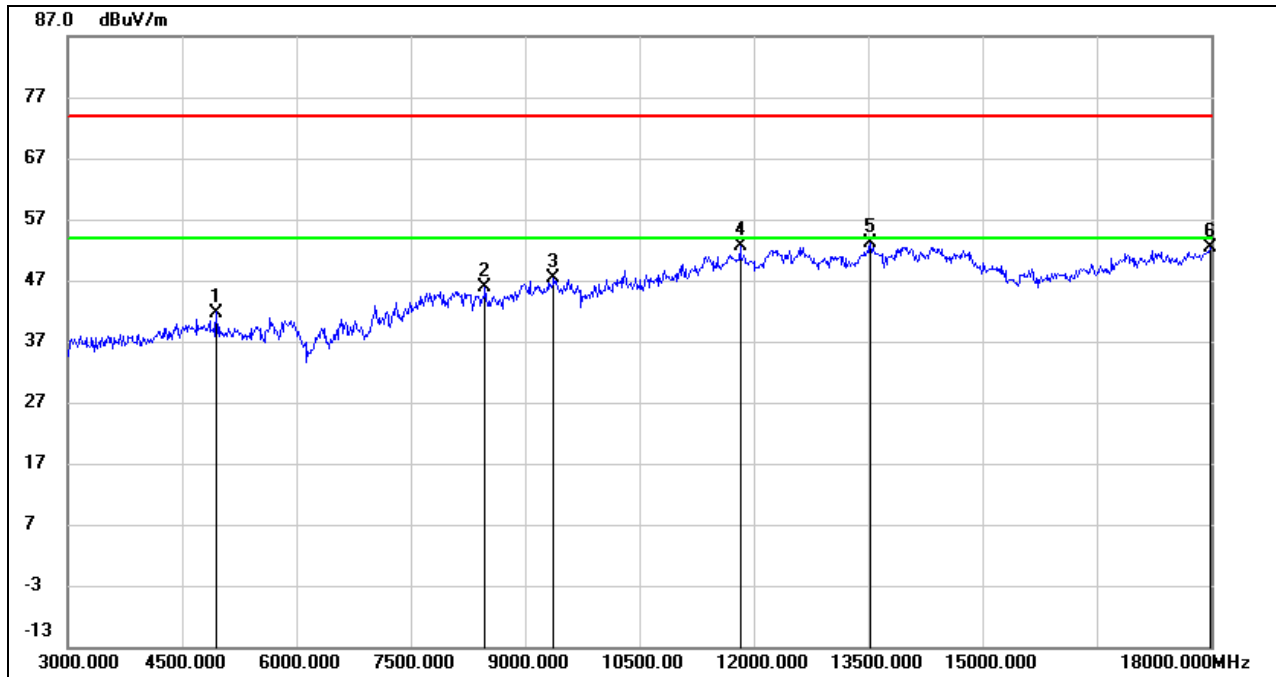

No.	Frequency (MHz)	Reading (dBuV)	Correct (dB/m)	Result (dBuV/m)	Limit (dBuV/m)	Margin (dB)	Remark
1	4957.500	41.93	-0.18	41.75	74.00	-32.25	peak
2	8475.000	38.61	7.29	45.90	74.00	-28.10	peak
3	9382.500	37.10	10.21	47.31	74.00	-26.69	peak
4	11827.500	35.63	16.95	52.58	74.00	-21.42	peak
5	13537.500	32.63	20.39	53.02	74.00	-20.98	peak
6	17985.000	27.20	25.18	52.38	74.00	-21.62	peak

- Note: 1. Peak Result = Reading Level + Correct Factor.
 2. If Peak Result complies with AV limit, AV Result is deemed to comply with AV limit.
 3. Peak: Peak detector.
 4. Filter losses were only considered in the spurious frequency bands and the authorized band was not corrected for High Pass Filter losses.
 5. Proper operation of the transmitter prior to adding the filter to the measurement chain.

HARMONICS AND SPURIOUS EMISSIONS (HIGH CHANNEL, HORIZONTAL)

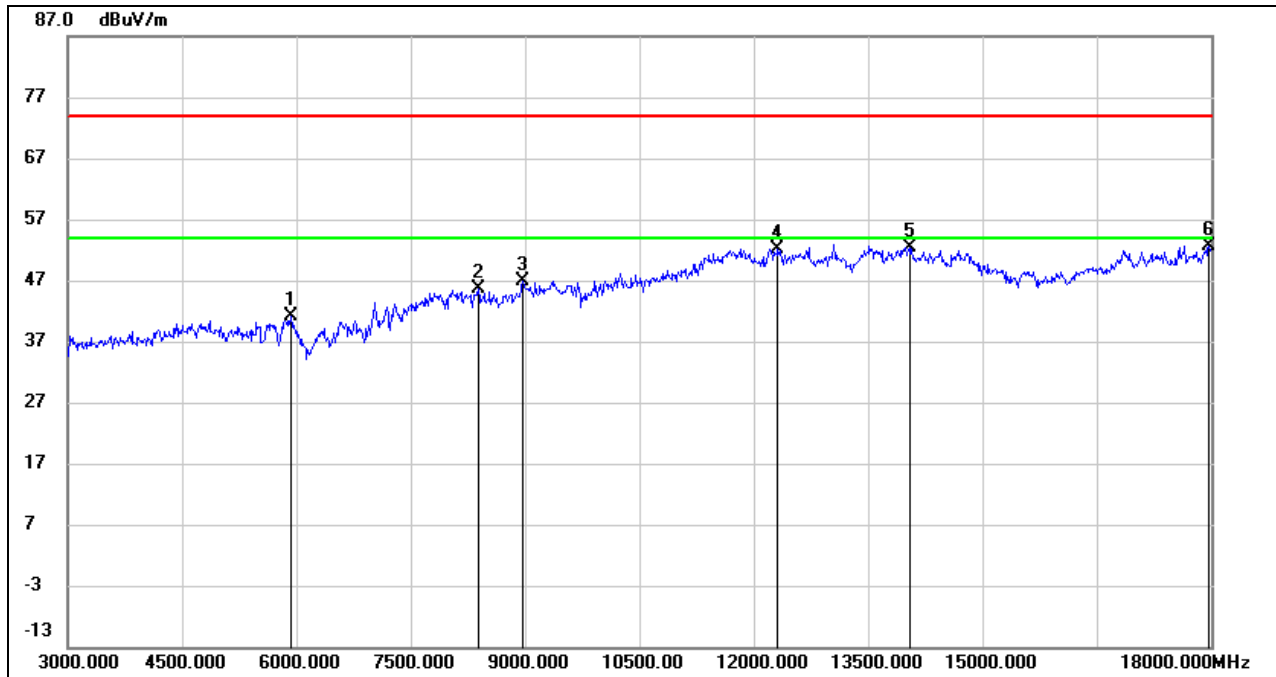

No.	Frequency (MHz)	Reading (dBuV)	Correct (dB/m)	Result (dBuV/m)	Limit (dBuV/m)	Margin (dB)	Remark
1	5932.500	38.68	2.44	41.12	74.00	-32.88	peak
2	8392.500	38.13	7.40	45.53	74.00	-28.47	peak
3	8977.500	37.26	9.71	46.97	74.00	-27.03	peak
4	12322.500	34.42	17.64	52.06	74.00	-21.94	peak
5	14062.500	31.35	21.07	52.42	74.00	-21.58	peak
6	17977.500	27.53	25.14	52.67	74.00	-21.33	peak

- Note: 1. Peak Result = Reading Level + Correct Factor.
 2. If Peak Result complies with AV limit, AV Result is deemed to comply with AV limit.
 3. Peak: Peak detector.
 4. Filter losses were only considered in the spurious frequency bands and the authorized band was not corrected for High Pass Filter losses.
 5. Proper operation of the transmitter prior to adding the filter to the measurement chain.

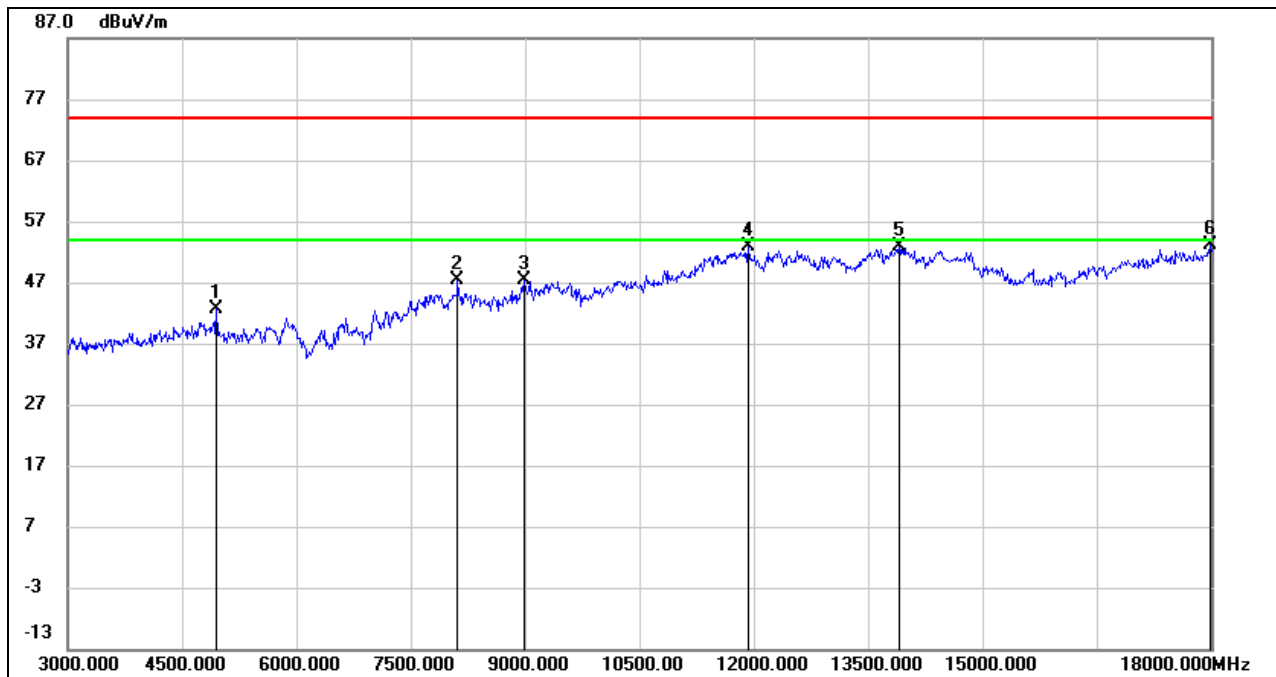
HARMONICS AND SPURIOUS EMISSIONS (HIGH CHANNEL, VERTICAL)

No.	Frequency (MHz)	Reading (dBuV)	Correct (dB/m)	Result (dBuV/m)	Limit (dBuV/m)	Margin (dB)	Remark
1	4957.500	42.83	-0.18	42.65	74.00	-31.35	peak
2	8122.500	39.45	7.89	47.34	74.00	-26.66	peak
3	8985.000	37.63	9.86	47.49	74.00	-26.51	peak
4	11925.000	35.54	17.24	52.78	74.00	-21.22	peak
5	13912.500	31.66	21.22	52.88	74.00	-21.12	peak
6	17992.500	27.79	25.23	53.02	74.00	-20.98	peak

- Note: 1. Peak Result = Reading Level + Correct Factor.
 2. If Peak Result complies with AV limit, AV Result is deemed to comply with AV limit.
 3. Peak: Peak detector.
 4. Filter losses were only considered in the spurious frequency bands and the authorized band was not corrected for High Pass Filter losses.
 5. Proper operation of the transmitter prior to adding the filter to the measurement chain.

8.3.2. $\pi/4$ -DQPSK MODE

HARMONICS AND SPURIOUS EMISSIONS (LOW CHANNEL, HORIZONTAL)

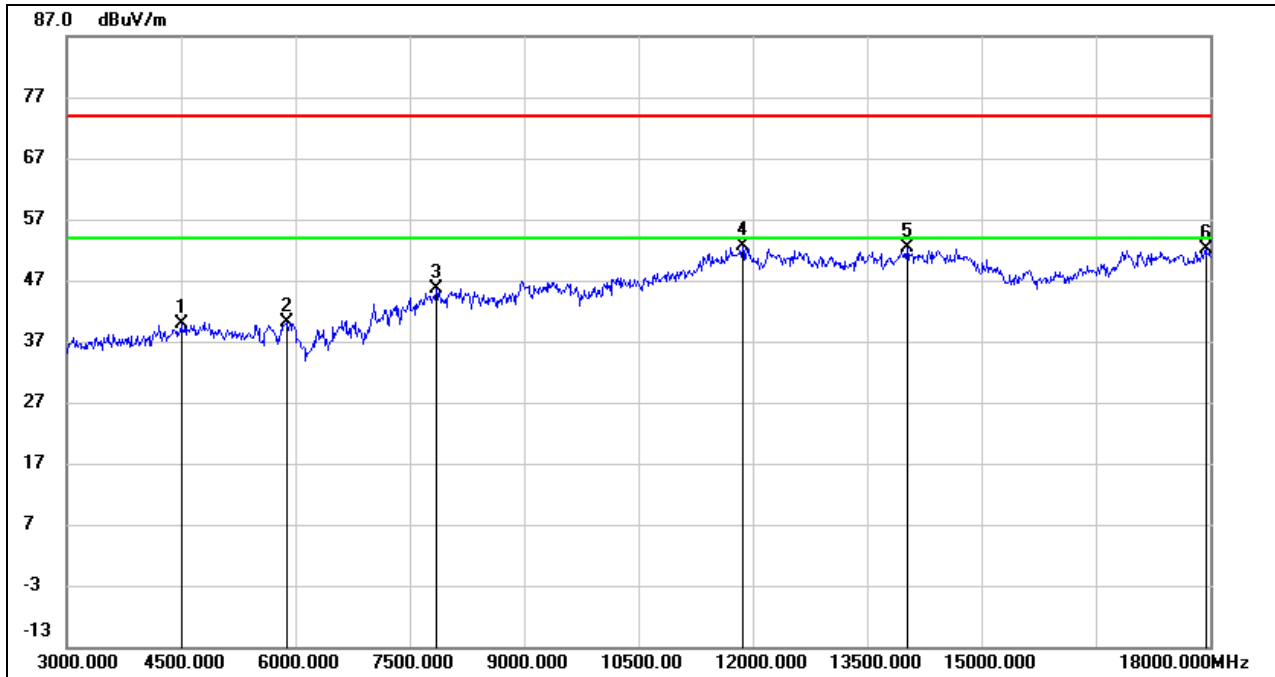

No.	Frequency (MHz)	Reading (dBuV)	Correct (dB/m)	Result (dBuV/m)	Limit (dBuV/m)	Margin (dB)	Remark
1	4507.500	41.46	-1.61	39.85	74.00	-34.15	peak
2	5887.500	37.56	2.50	40.06	74.00	-33.94	peak
3	7845.000	38.72	6.94	45.66	74.00	-28.34	peak
4	11872.500	35.61	17.11	52.72	74.00	-21.28	peak
5	14032.500	31.22	21.25	52.47	74.00	-21.53	peak
6	17947.500	27.13	24.95	52.08	74.00	-21.92	peak

- Note:
1. Peak Result = Reading Level + Correct Factor.
 2. If Peak Result complies with AV limit, AV Result is deemed to comply with AV limit.
 3. Peak: Peak detector.
 4. Filter losses were only considered in the spurious frequency bands and the authorized band was not corrected for High Pass Filter losses.
 5. Proper operation of the transmitter prior to adding the filter to the measurement chain.

HARMONICS AND SPURIOUS EMISSIONS (LOW CHANNEL, VERTICAL)

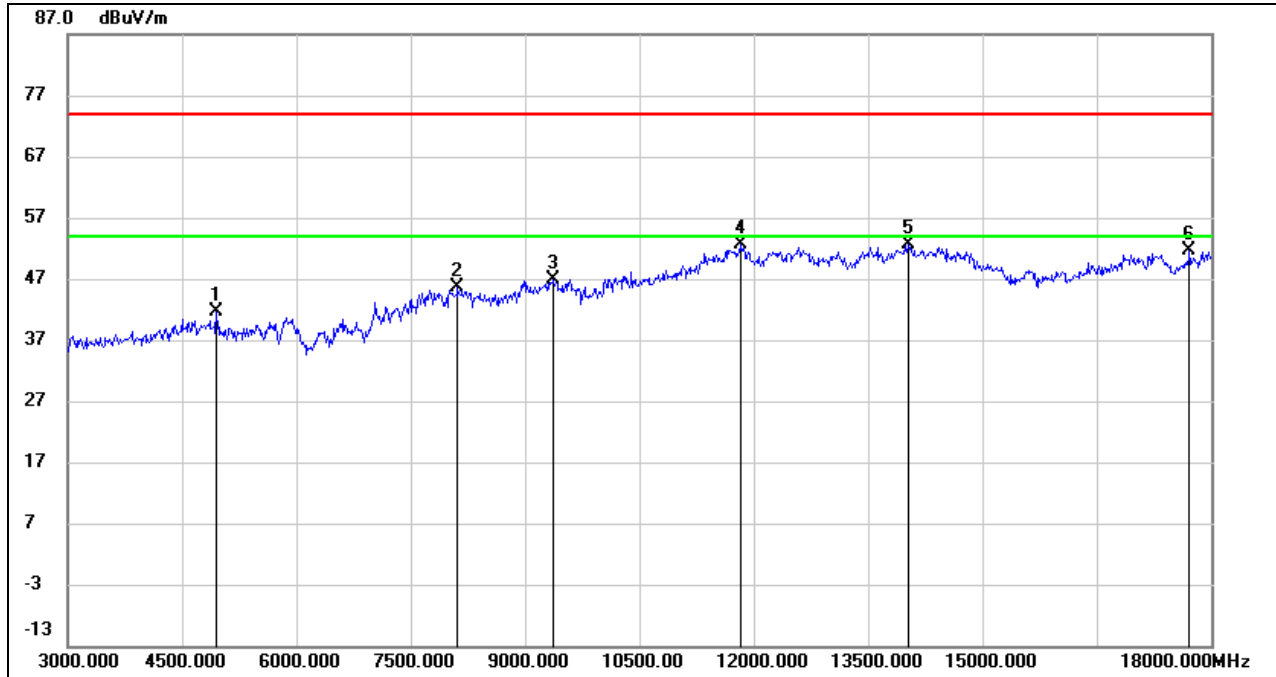

No.	Frequency (MHz)	Reading (dBuV)	Correct (dB/m)	Result (dBuV/m)	Limit (dBuV/m)	Margin (dB)	Remark
1	4957.500	41.92	-0.18	41.74	74.00	-32.26	peak
2	8115.000	37.69	7.92	45.61	74.00	-28.39	peak
3	9375.000	36.82	10.17	46.99	74.00	-27.01	peak
4	11827.500	35.62	16.95	52.57	74.00	-21.43	peak
5	14025.000	31.32	21.30	52.62	74.00	-21.38	peak
6	17715.000	27.71	23.81	51.52	74.00	-22.48	peak

- Note: 1. Peak Result = Reading Level + Correct Factor.
 2. If Peak Result complies with AV limit, AV Result is deemed to comply with AV limit.
 3. Peak: Peak detector.
 4. Filter losses were only considered in the spurious frequency bands and the authorized band was not corrected for High Pass Filter losses.
 5. Proper operation of the transmitter prior to adding the filter to the measurement chain.

HARMONICS AND SPURIOUS EMISSIONS (MID CHANNEL, HORIZONTAL)

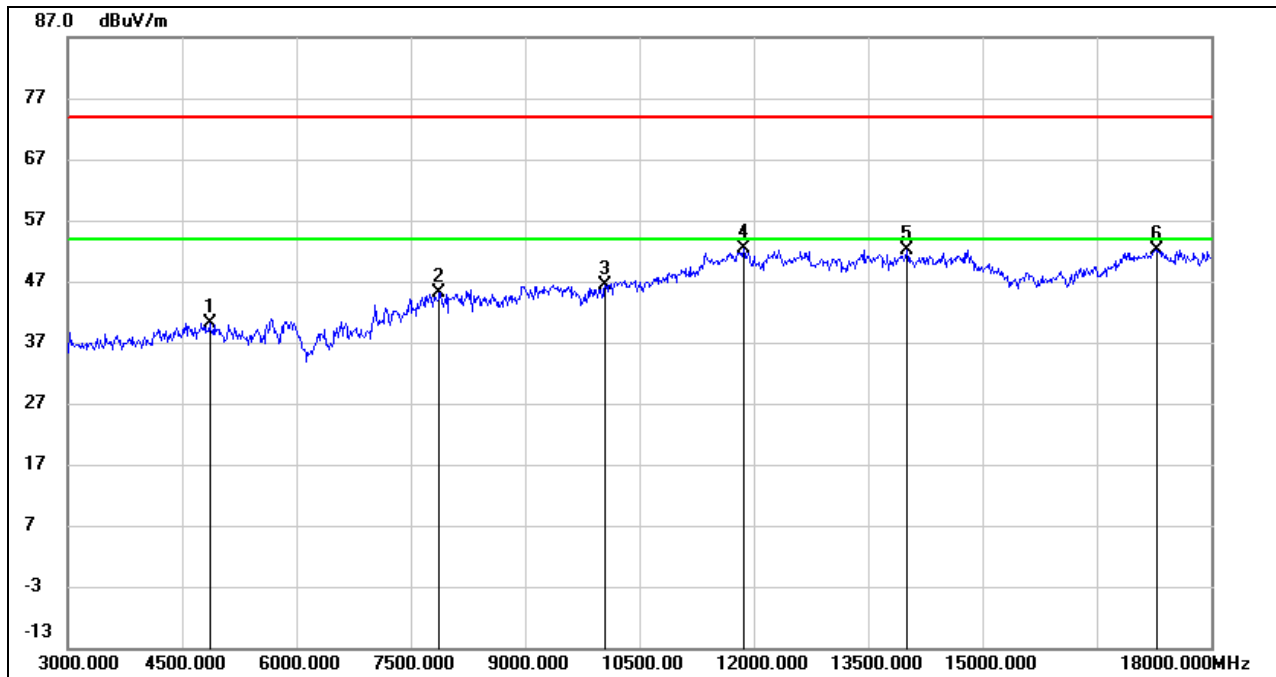

No.	Frequency (MHz)	Reading (dBuV)	Correct (dB/m)	Result (dBuV/m)	Limit (dBuV/m)	Margin (dB)	Remark
1	4860.000	40.73	-0.49	40.24	74.00	-33.76	peak
2	7882.500	38.47	6.72	45.19	74.00	-28.81	peak
3	10057.500	35.04	11.35	46.39	74.00	-27.61	peak
4	11872.500	35.36	17.11	52.47	74.00	-21.53	peak
5	14010.000	30.79	21.40	52.19	74.00	-21.81	peak
6	17287.500	30.40	21.80	52.20	74.00	-21.80	peak

- Note: 1. Peak Result = Reading Level + Correct Factor.
 2. If Peak Result complies with AV limit, AV Result is deemed to comply with AV limit.
 3. Peak: Peak detector.
 4. Filter losses were only considered in the spurious frequency bands and the authorized band was not corrected for High Pass Filter losses.
 5. Proper operation of the transmitter prior to adding the filter to the measurement chain.

HARMONICS AND SPURIOUS EMISSIONS (MID CHANNEL, VERTICAL)

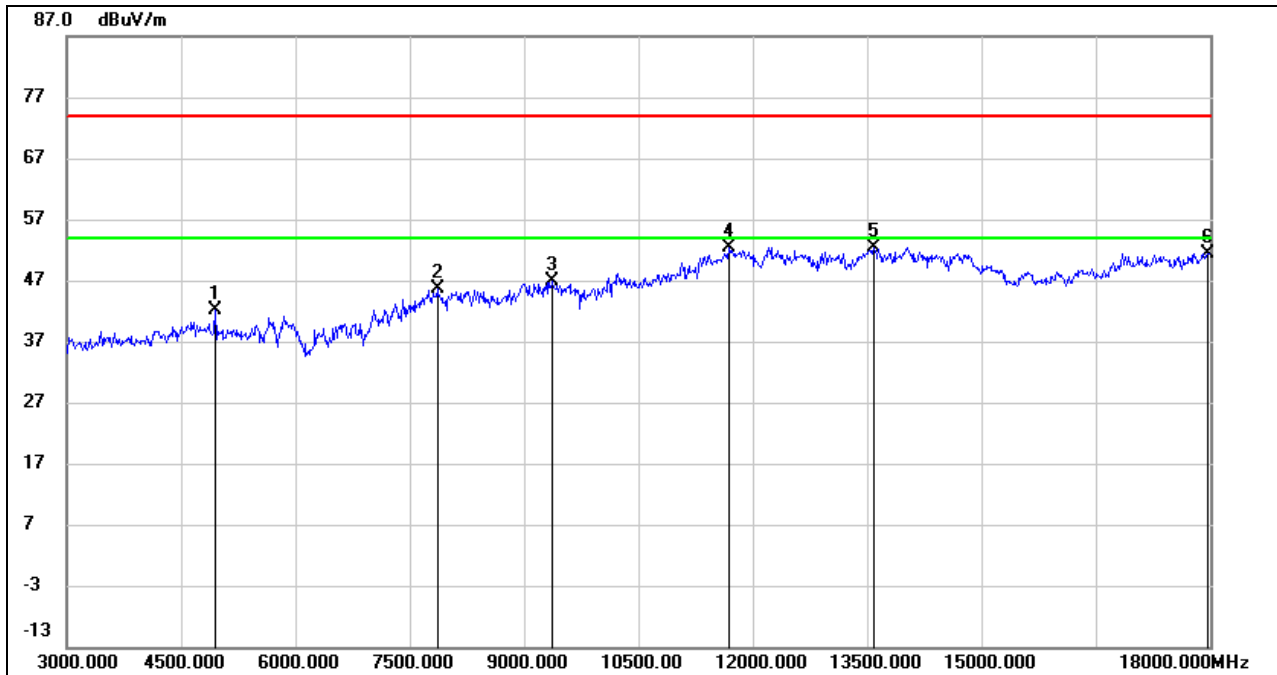

No.	Frequency (MHz)	Reading (dBuV)	Correct (dB/m)	Result (dBuV/m)	Limit (dBuV/m)	Margin (dB)	Remark
1	4957.500	42.32	-0.18	42.14	74.00	-31.86	peak
2	7867.500	38.75	6.80	45.55	74.00	-28.45	peak
3	9375.000	36.64	10.17	46.81	74.00	-27.19	peak
4	11685.000	35.71	16.76	52.47	74.00	-21.53	peak
5	13590.000	31.98	20.39	52.37	74.00	-21.63	peak
6	17970.000	26.37	25.08	51.45	74.00	-22.55	peak

- Note: 1. Peak Result = Reading Level + Correct Factor.
 2. If Peak Result complies with AV limit, AV Result is deemed to comply with AV limit.
 3. Peak: Peak detector.
 4. Filter losses were only considered in the spurious frequency bands and the authorized band was not corrected for High Pass Filter losses.
 5. Proper operation of the transmitter prior to adding the filter to the measurement chain.



HARMONICS AND SPURIOUS EMISSIONS (HIGH CHANNEL, HORIZONTAL)

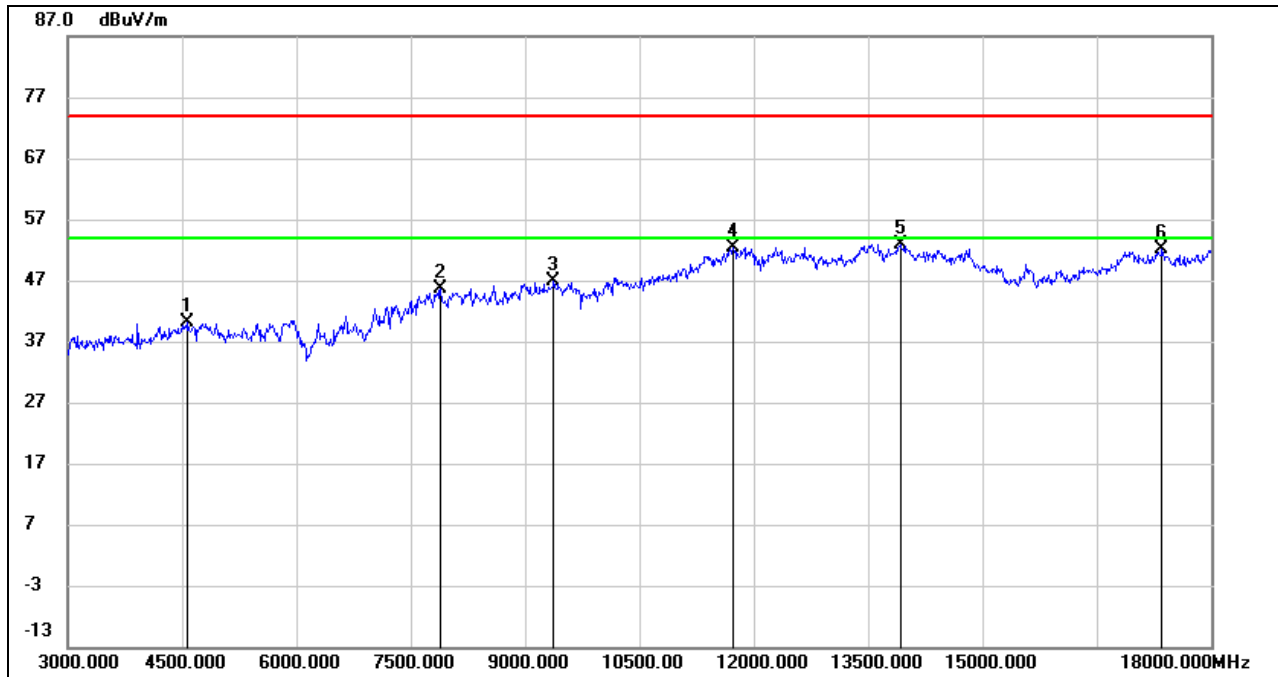

No.	Frequency (MHz)	Reading (dBuV)	Correct (dB/m)	Result (dBuV/m)	Limit (dBuV/m)	Margin (dB)	Remark
1	4582.500	41.45	-1.26	40.19	74.00	-33.81	peak
2	7897.500	39.11	6.64	45.75	74.00	-28.25	peak
3	9375.000	36.61	10.17	46.78	74.00	-27.22	peak
4	11730.000	35.62	16.86	52.48	74.00	-21.52	peak
5	13920.000	31.72	21.24	52.96	74.00	-21.04	peak
6	17362.500	30.52	21.56	52.08	74.00	-21.92	peak

- Note: 1. Peak Result = Reading Level + Correct Factor.
 2. If Peak Result complies with AV limit, AV Result is deemed to comply with AV limit.
 3. Peak: Peak detector.
 4. Filter losses were only considered in the spurious frequency bands and the authorized band was not corrected for High Pass Filter losses.
 5. Proper operation of the transmitter prior to adding the filter to the measurement chain.

HARMONICS AND SPURIOUS EMISSIONS (HIGH CHANNEL, VERTICAL)

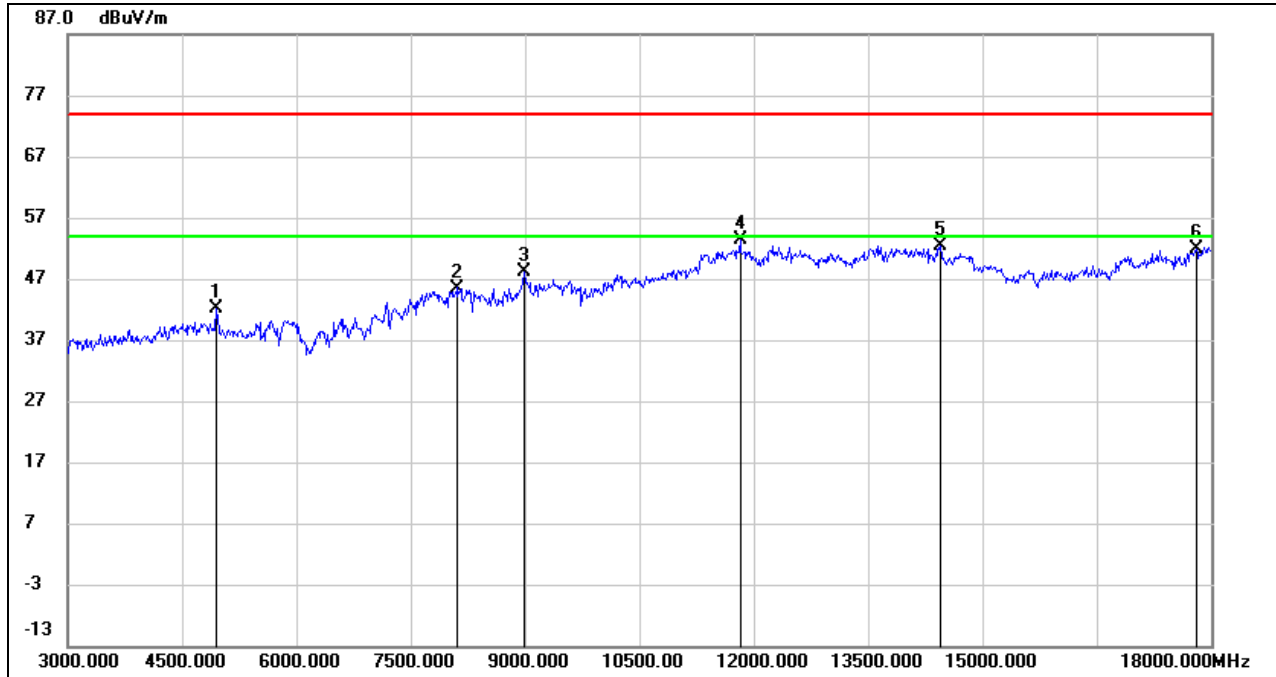

No.	Frequency (MHz)	Reading (dBuV)	Correct (dB/m)	Result (dBuV/m)	Limit (dBuV/m)	Margin (dB)	Remark
1	4957.500	42.34	-0.18	42.16	74.00	-31.84	peak
2	8122.500	37.61	7.89	45.50	74.00	-28.50	peak
3	8992.500	38.01	10.01	48.02	74.00	-25.98	peak
4	11827.500	36.42	16.95	53.37	74.00	-20.63	peak
5	14445.000	33.16	19.23	52.39	74.00	-21.61	peak
6	17812.500	27.32	24.54	51.86	74.00	-22.14	peak

- Note: 1. Peak Result = Reading Level + Correct Factor.
 2. If Peak Result complies with AV limit, AV Result is deemed to comply with AV limit.
 3. Peak: Peak detector.
 4. Filter losses were only considered in the spurious frequency bands and the authorized band was not corrected for High Pass Filter losses.
 5. Proper operation of the transmitter prior to adding the filter to the measurement chain.

8.4. SPURIOUS EMISSIONS (18 GHz ~ 26 GHz)

8.4.1. GFSK MODE

SPURIOUS EMISSIONS (HIGH CHANNEL, WORST-CASE CONFIGURATION, HORIZONTAL)

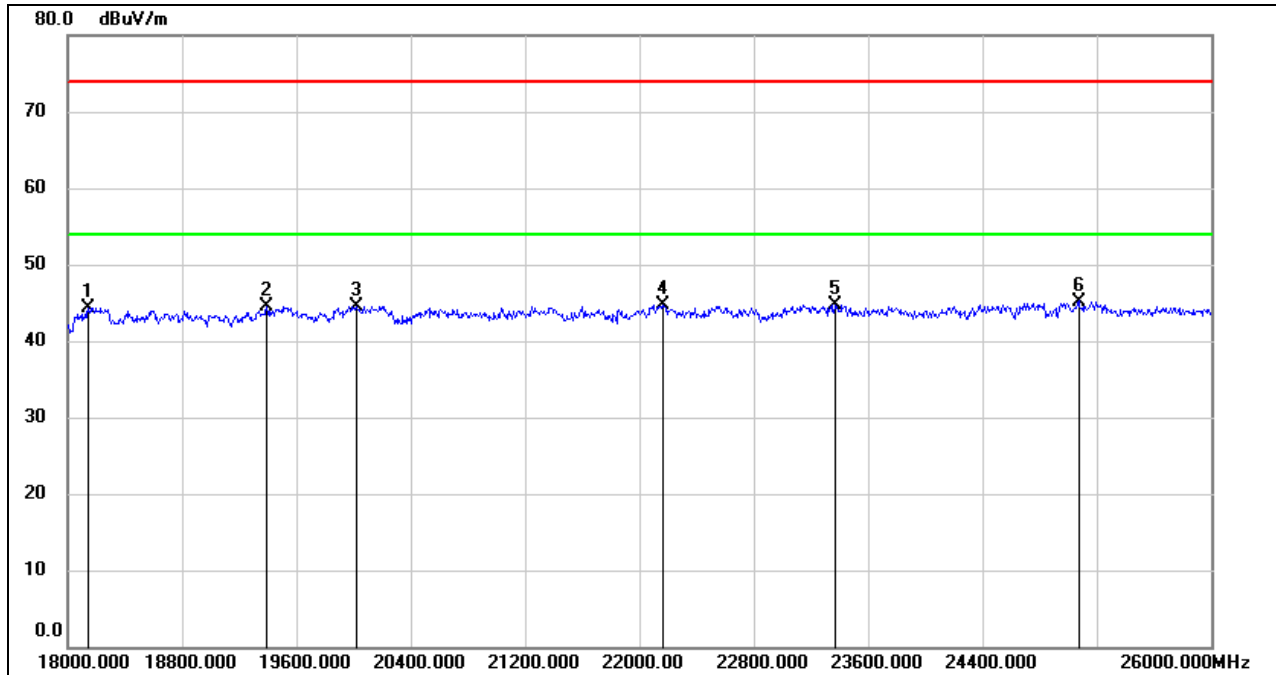

No.	Frequency (MHz)	Reading (dBuV)	Correct (dB/m)	Result (dBuV/m)	Limit (dBuV/m)	Margin (dB)	Remark
1	18144.000	49.77	-5.48	44.29	74.00	-29.71	peak
2	19392.000	50.12	-5.57	44.55	74.00	-29.45	peak
3	20016.000	50.06	-5.47	44.59	74.00	-29.41	peak
4	22160.000	49.08	-4.31	44.77	74.00	-29.23	peak
5	23368.000	47.95	-3.26	44.69	74.00	-29.31	peak
6	25072.000	47.17	-1.97	45.20	74.00	-28.80	peak

Note: 1. Peak Result = Reading Level + Correct Factor.

2. If Peak Result complies with AV limit, AV Result is deemed to comply with AV limit.

3. Peak: Peak detector.

SPURIOUS EMISSIONS (HIGH CHANNEL, WORST-CASE CONFIGURATION, VERTICAL)

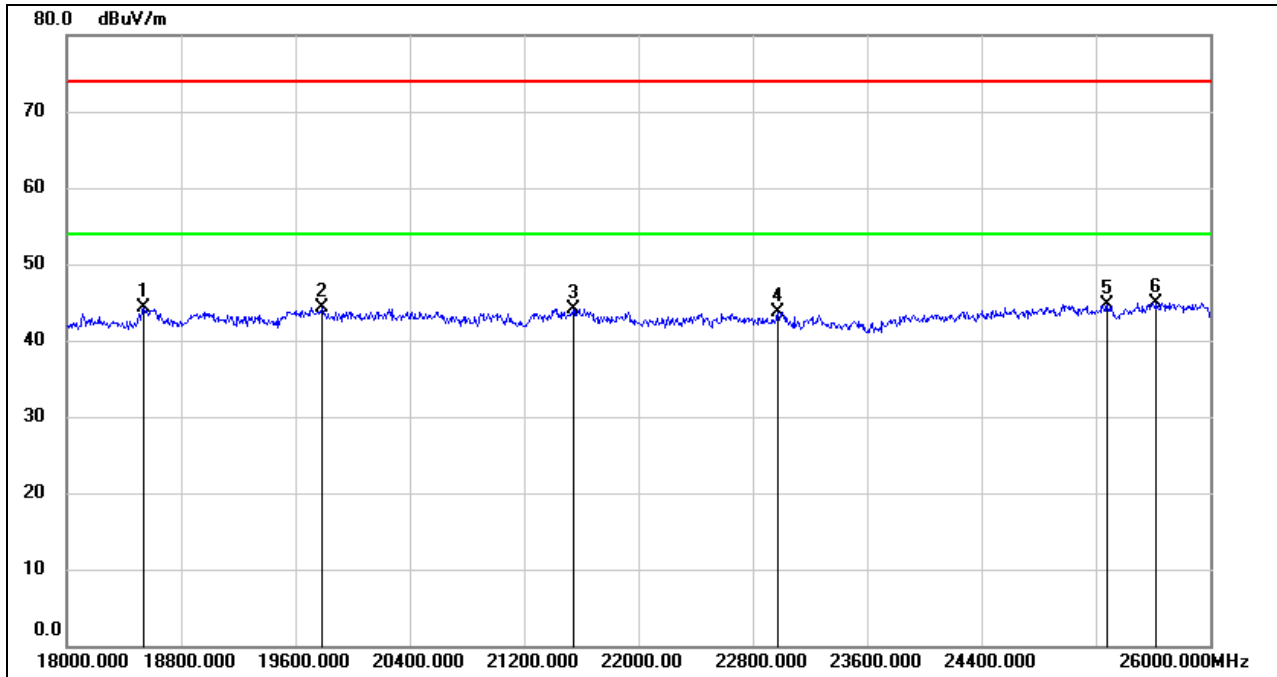

No.	Frequency (MHz)	Reading (dBuV)	Correct (dB/m)	Result (dBuV/m)	Limit (dBuV/m)	Margin (dB)	Remark
1	18536.000	49.60	-5.27	44.33	74.00	-29.67	peak
2	19784.000	49.57	-5.28	44.29	74.00	-29.71	peak
3	21544.000	48.76	-4.63	44.13	74.00	-29.87	peak
4	22976.000	47.26	-3.46	43.80	74.00	-30.20	peak
5	25280.000	46.30	-1.68	44.62	74.00	-29.38	peak
6	25624.000	46.09	-1.20	44.89	74.00	-29.11	peak

- Note: 1. Peak Result = Reading Level + Correct Factor.
 2. If Peak Result complies with AV limit, AV Result is deemed to comply with AV limit.
 3. Peak: Peak detector.

Note: All the modes, channels and antenna had been tested, but only the worst data was recorded in the report.

8.5. SPURIOUS EMISSIONS (30 MHz ~ 1 GHz)

8.5.1. GFSK MODE

SPURIOUS EMISSIONS (HIGH CHANNEL, WORST-CASE CONFIGURATION, HORIZONTAL)

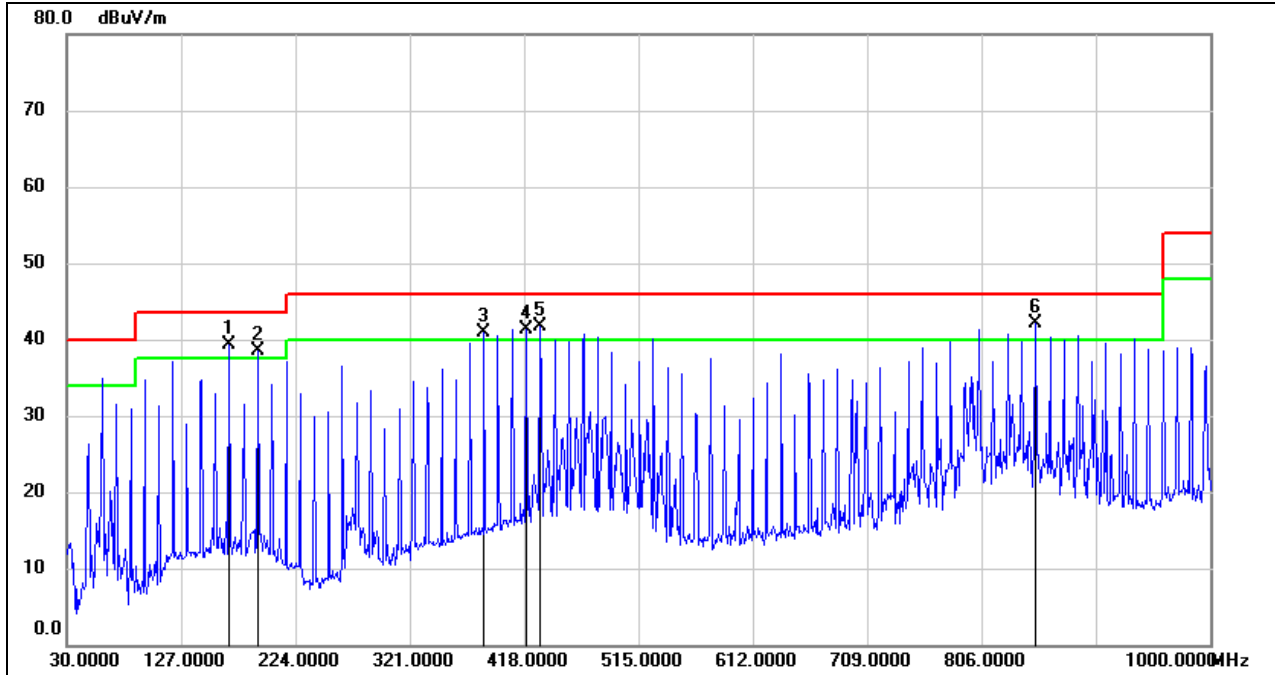

No.	Frequency (MHz)	Reading (dBuV)	Correct (dB/m)	Result (dBuV/m)	Limit (dBuV/m)	Margin (dB)	Remark
1	167.7400	56.76	-17.41	39.35	43.50	-4.15	QP
2	191.9900	55.10	-16.56	38.54	43.50	-4.96	QP
3	384.0500	54.44	-13.58	40.86	46.00	-5.14	QP
4	419.9400	54.39	-12.99	41.40	46.00	-4.60	QP
5	431.5800	54.35	-12.70	41.65	46.00	-4.35	QP
6	851.5900	48.32	-6.21	42.11	46.00	-3.89	QP

- Note: 1. Result Level = Read Level + Antenna Factor + Cable loss.
 2. If Peak Result complies with QP limit, QP Result is deemed to comply with QP limit.
 3. Test setup: RBW: 120 kHz, VBW: 300 kHz, Sweep time: auto.

SPURIOUS EMISSIONS (HIGH CHANNEL, WORST-CASE CONFIGURATION, VERTICAL)

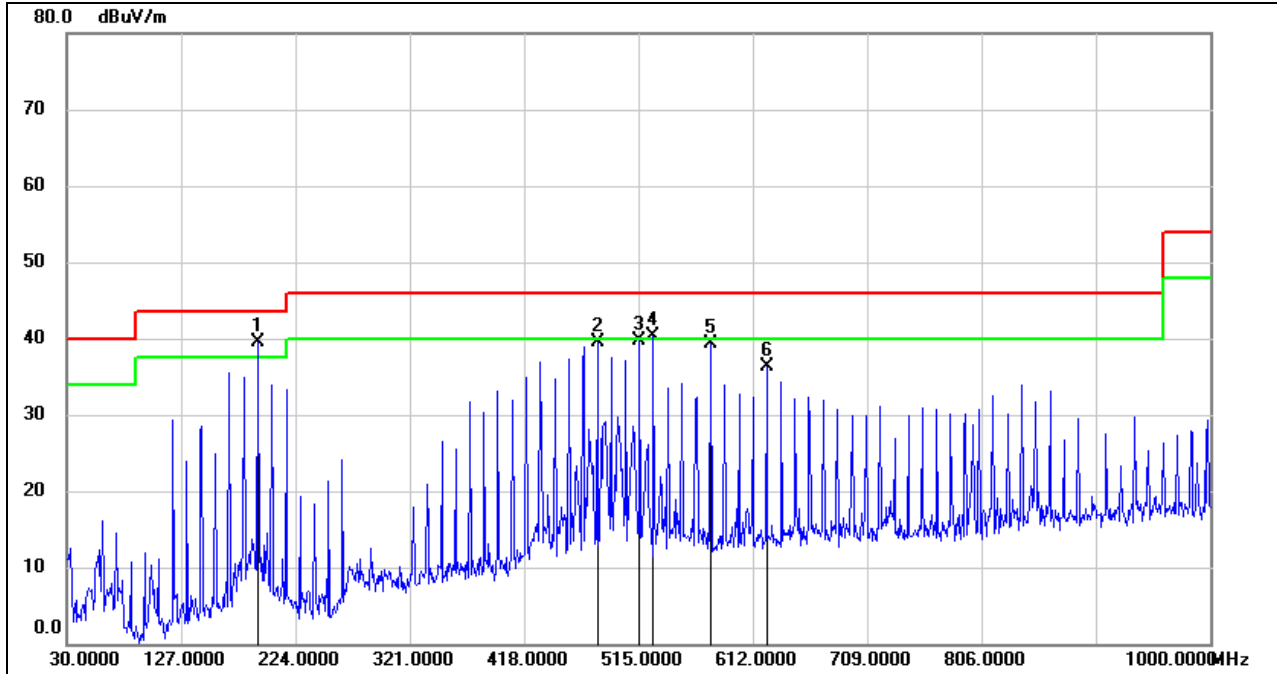

No.	Frequency (MHz)	Reading (dBuV)	Correct (dB/m)	Result (dBuV/m)	Limit (dBuV/m)	Margin (dB)	Remark
1	191.9900	56.05	-16.56	39.49	43.50	-4.01	QP
2	480.0800	51.22	-11.79	39.43	46.00	-6.57	QP
3	515.9699	50.81	-11.15	39.66	46.00	-6.34	QP
4	527.6100	51.27	-10.88	40.39	46.00	-5.61	QP
5	576.1100	49.41	-10.02	39.39	46.00	-6.61	QP
6	623.6400	45.61	-9.33	36.28	46.00	-9.72	QP

- Note: 1. Result Level = Read Level + Antenna Factor + Cable loss.
 2. If Peak Result complies with QP limit, QP Result is deemed to comply with QP limit.
 3. Test setup: RBW: 120 kHz, VBW: 300 kHz, Sweep time: auto

Note: All the modes, channels and antenna had been tested, but only the worst data was recorded in the report.

8.6. SPURIOUS EMISSIONS BELOW 30 MHz

8.6.1. GFSK MODE

(HIGH CHANNEL, LOOP ANTENNA FACE ON TO THE EUT, WORST-CASE CONFIGURATION)

9 kHz~ 150 kHz

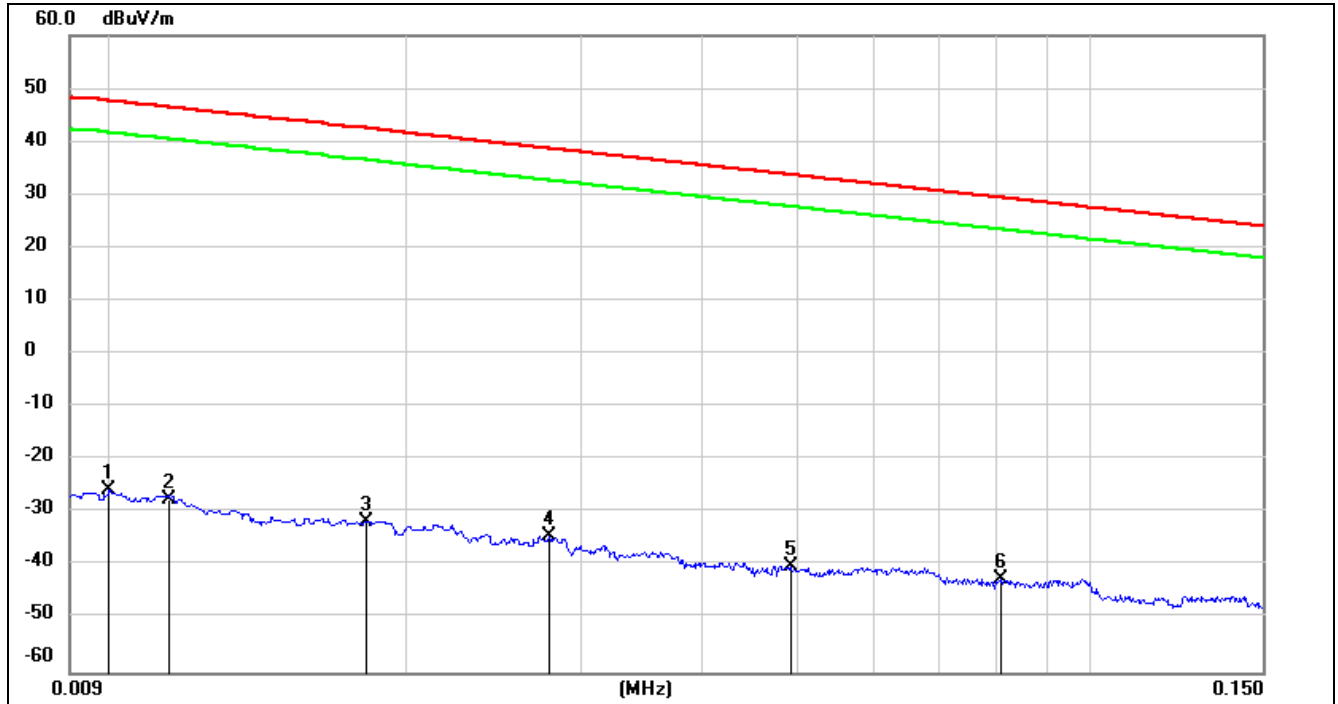

No.	Frequency (MHz)	Reading (dBuV)	Correct (dB/m)	Result (dBuV/m)	Limit (dBuV/m)	Margin (dB)	Remark
1	0.0100	75.72	-101.40	-25.68	47.6	-73.28	peak
2	0.0114	73.95	-101.40	-27.45	46.46	-73.91	peak
3	0.0181	69.85	-101.36	-31.51	42.45	-73.96	peak
4	0.0279	67.17	-101.38	-34.21	38.69	-72.90	peak
5	0.0492	61.55	-101.47	-39.92	33.76	-73.68	peak
6	0.0806	59.18	-101.63	-42.45	29.47	-71.92	peak

Note:

1. If Peak Result complies with AV and QP limit, AV and QP Result are deemed to comply with AV limit.
2. All 3 polarizations(Horizontal, Face-on and Face-off) of the loop antenna had been tested, but only the worst data recorded in the report.

150 kHz ~ 490 kHz

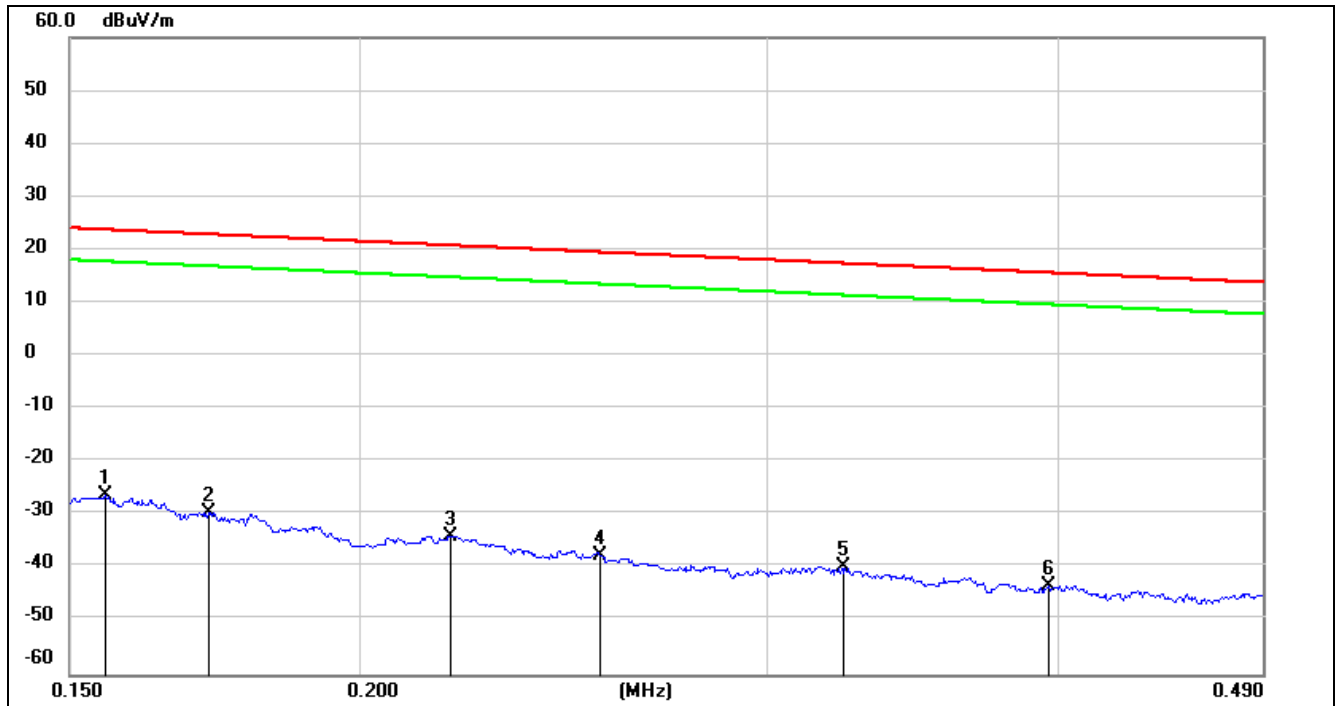

No.	Frequency (MHz)	Reading (dBuV)	Correct (dB/m)	Result (dBuV/m)	Limit (dBuV/m)	Margin (dB)	Remark
1	0.1554	75.27	-101.65	-26.38	23.77	-50.15	peak
2	0.1720	72.19	-101.67	-29.48	22.9	-52.38	peak
3	0.2190	67.77	-101.75	-33.98	20.79	-54.77	peak
4	0.2540	64.10	-101.80	-37.7	19.5	-57.20	peak
5	0.3234	61.98	-101.88	-39.9	17.41	-57.31	peak
6	0.3966	58.68	-101.96	-43.28	15.63	-58.91	peak

Note:

1. If Peak Result complies with AV and QP limit, AV and QP Result are deemed to comply with AV limit.
2. All 3 polarizations(Horizontal, Face-on and Face-off) of the loop antenna had been tested, but only the worst data recorded in the report.

490 kHz ~ 30 MHz

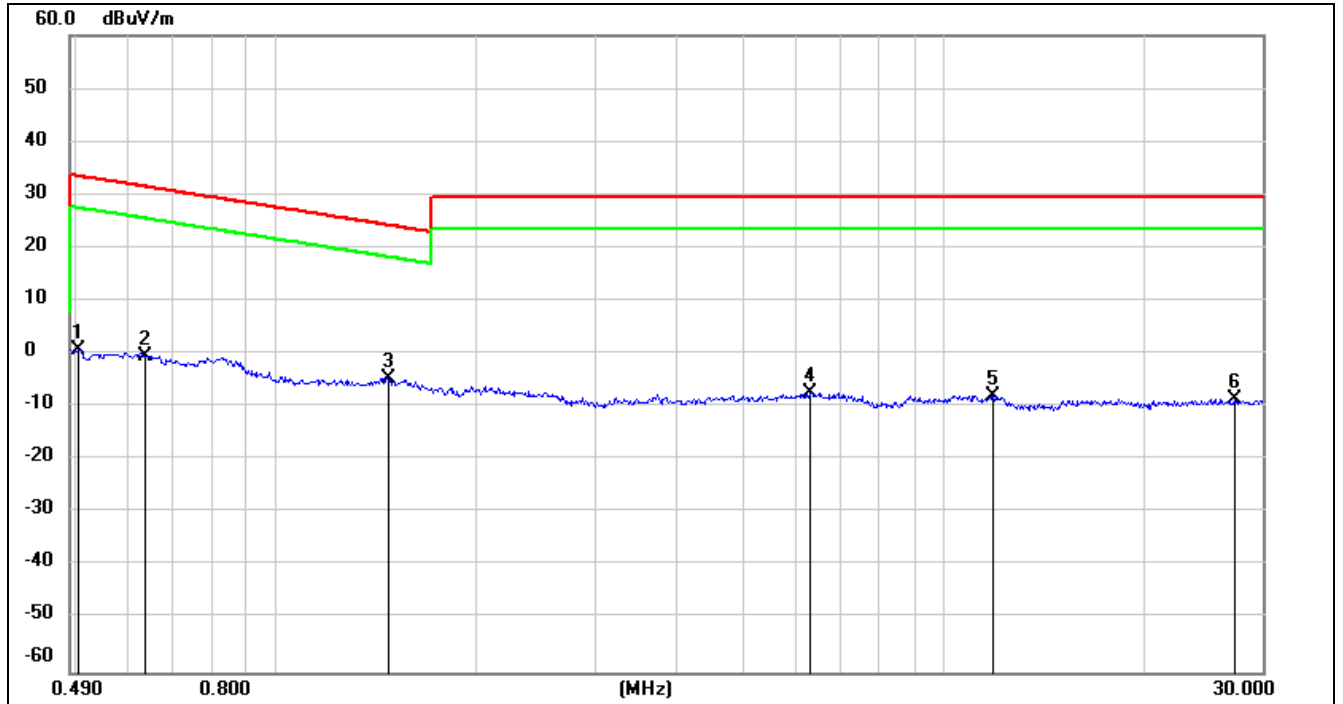

No.	Frequency (MHz)	Reading (dBuV)	Correct (dB/m)	Result (dBuV/m)	Limit (dBuV/m)	Margin (dB)	Remark
1	0.5039	62.93	-62.07	0.86	33.56	-32.70	peak
2	0.6370	61.75	-62.10	-0.35	31.52	-31.87	peak
3	1.4700	57.39	-62.05	-4.66	24.26	-28.92	peak
4	6.3033	53.95	-61.31	-7.36	29.54	-36.90	peak
5	11.8513	53.06	-60.88	-7.82	29.54	-37.36	peak
6	27.1966	51.81	-60.24	-8.43	29.54	-37.97	peak

Note:

1. If Peak Result complies with AV and QP limit, AV and QP Result are deemed to comply with AV limit.
2. All 3 polarizations(Horizontal, Face-on and Face-off) of the loop antenna had been tested, but only the worst data recorded in the report.

Note: All the modes, channels and antenna had been tested, but only the worst data was recorded in the report.

9. AC POWER LINE CONDUCTED EMISSIONS

LIMITS

Please refer to CFR 47 FCC §15.207 (a)

FREQUENCY (MHz)	Quasi-peak	Average
0.15 -0.5	66 - 56 *	56 - 46 *
0.50 -5.0	56.00	46.00
5.0 -30.0	60.00	50.00

TEST SETUP AND PROCEDURE

Refer to ANSI C63.10-2013 clause 6.2.

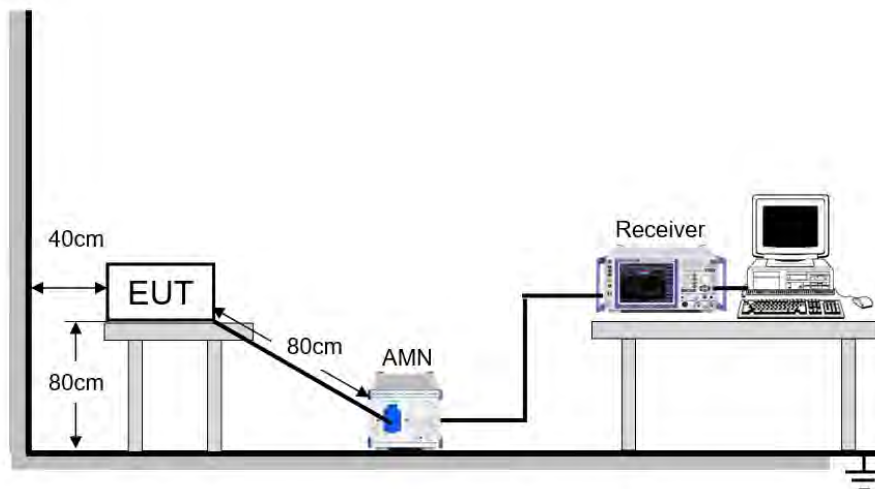

The EUT is put on a table of non-conducting material that is 80 cm high. The vertical conducting wall of shielding is located 40 cm to the rear of the EUT. The power line of the EUT is connected to the AC mains through a Artificial Mains Network (A.M.N.). A EMI Measurement Receiver (R&S Test Receiver ESR3) is used to test the emissions from both sides of AC line. According to the requirements in Section 6.2 of ANSI C63.10-2013. Conducted emissions from the EUT measured in the frequency range between 0.15 MHz and 30 MHz using CISPR Quasi-Peak and average detector mode. The bandwidth of EMI test receiver is set at 9 kHz.

The arrangement of the equipment is installed to meet the standards and operating in a manner, which tends to maximize its emission characteristics in a normal application.

TEST ENVIRONMENT

Temperature	21.7 °C	Relative Humidity	52.4 %
Atmosphere Pressure	101 kPa	Test Voltage	AC 120 V, 60 Hz



TEST RESULTS

9.1. GFSK MODE

LINE L RESULTS (HIGH CHANNEL, WORST-CASE CONFIGURATION)

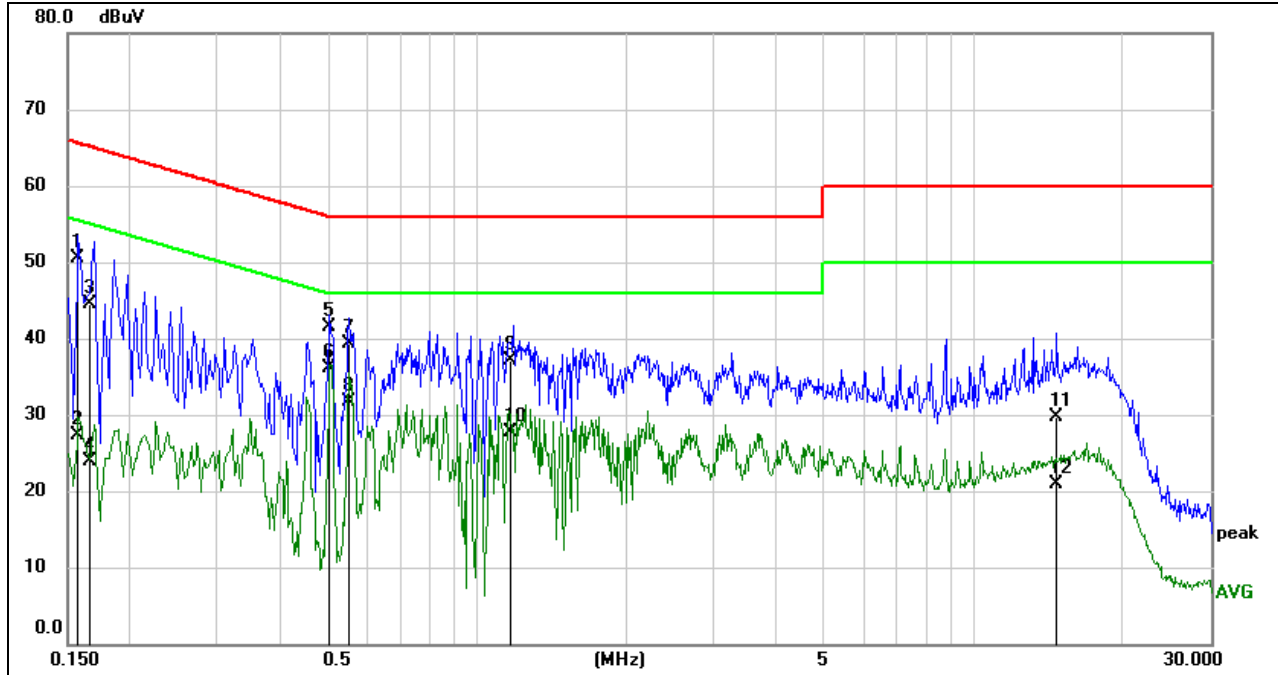

No.	Frequency (MHz)	Reading (dBuV)	Correct (dB)	Result (dBuV)	Limit (dBuV)	Margin (dB)	Remark
1	0.1576	41.05	9.51	50.56	65.59	-15.03	QP
2	0.1576	17.76	9.51	27.27	55.59	-28.32	AVG
3	0.1652	35.03	9.52	44.55	65.20	-20.65	QP
4	0.1652	14.44	9.52	23.96	55.20	-31.24	AVG
5	0.5068	31.92	9.50	41.42	56.00	-14.58	QP
6	0.5068	26.65	9.50	36.15	46.00	-9.85	AVG
7	0.5558	29.85	9.50	39.35	56.00	-16.65	QP
8	0.5558	22.22	9.50	31.72	46.00	-14.28	AVG
9	1.1776	27.53	9.53	37.06	56.00	-18.94	QP
10	1.1776	18.25	9.53	27.78	46.00	-18.22	AVG
11	14.7172	19.95	9.66	29.61	60.00	-30.39	QP
12	14.7172	11.25	9.66	20.91	50.00	-29.09	AVG

Note: 1. Result = Reading + Correct Factor.
 2. If QP Result complies with AV limit, AV Result is deemed to comply with AV limit.
 3. Test setup: RBW: 200 Hz (9 kHz ~ 150 kHz), 9 kHz (150 kHz ~ 30 MHz).
 4. Step size: 80 Hz (0.009 MHz ~ 0.15 MHz), 4 kHz (0.15 MHz ~ 30 MHz), Scan time: auto.

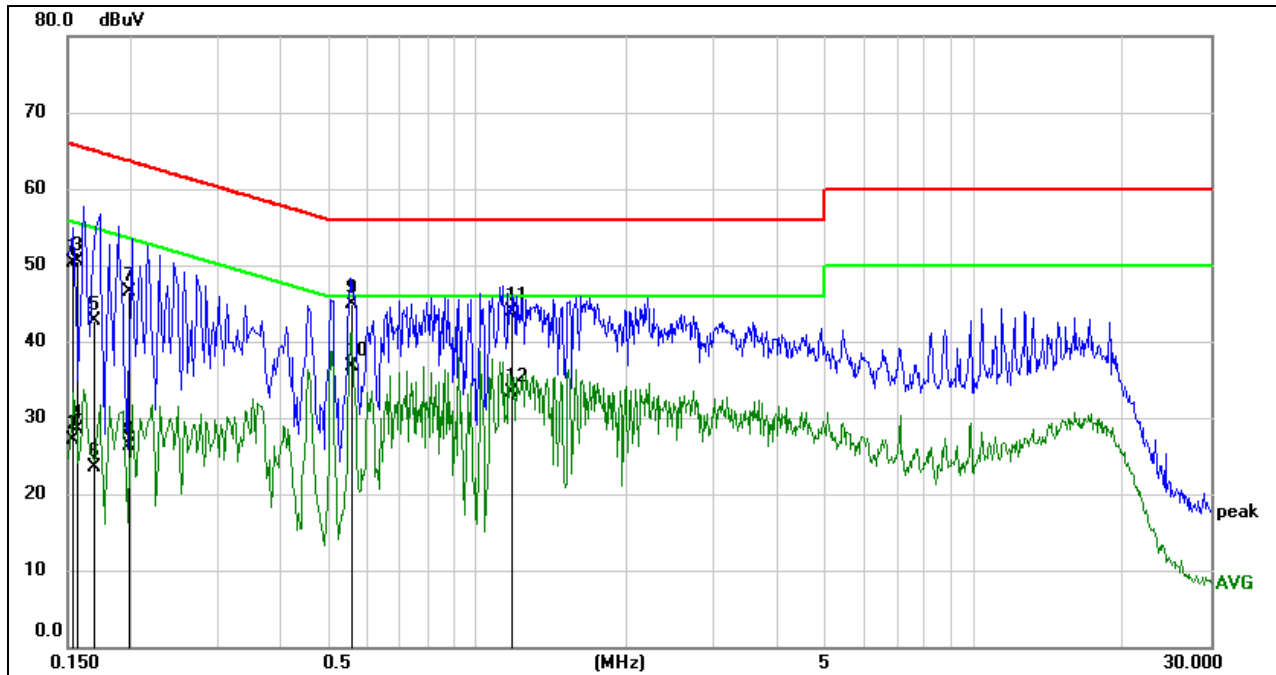
**LINE N RESULTS (HIGH CHANNEL, WORST-CASE CONFIGURATION)**

No.	Frequency (MHz)	Reading (dBuV)	Correct (dB)	Result (dBuV)	Limit (dBuV)	Margin (dB)	Remark
1	0.1538	40.88	9.50	50.38	65.79	-15.41	QP
2	0.1538	17.65	9.50	27.15	55.79	-28.64	AVG
3	0.1578	41.05	9.51	50.56	65.58	-15.02	QP
4	0.1578	18.92	9.51	28.43	55.58	-27.15	AVG
5	0.1696	33.16	9.53	42.69	64.98	-22.29	QP
6	0.1696	13.99	9.53	23.52	54.98	-31.46	AVG
7	0.1992	36.84	9.59	46.43	63.64	-17.21	QP
8	0.1992	16.76	9.59	26.35	53.64	-27.29	AVG
9	0.5588	35.49	9.50	44.99	56.00	-11.01	QP
10	0.5588	27.26	9.50	36.76	46.00	-9.24	AVG
11	1.1803	34.41	9.53	43.94	56.00	-12.06	QP
12	1.1803	23.72	9.53	33.25	46.00	-12.75	AVG

Note: 1. Result = Reading + Correct Factor.

2. If QP Result complies with AV limit, AV Result is deemed to comply with AV limit.

3. Test setup: RBW: 200 Hz (9 kHz ~ 150 kHz), 9 kHz (150 kHz ~ 30 MHz).

4. Step size: 80 Hz (0.009 MHz ~ 0.15 MHz), 4 kHz (0.15 MHz ~ 30 MHz), Scan time: auto.

Note: All the modes, channels and antenna had been tested, but only the worst data was recorded in the report.



10. ANTENNA REQUIREMENTS

APPLICABLE REQUIREMENTS

Please refer to FCC §15.203

An intentional radiator shall be designed to ensure that no antenna other than that furnished by the responsible party shall be used with the device. The use of a permanently attached antenna or of an antenna that uses a unique coupling to the intentional radiator shall be considered sufficient to comply with the provisions of this section. The manufacturer may design the unit so that a broken antenna can be replaced by the user, but the use of a standard antenna jack or electrical connector is prohibited.

Please refer to FCC §15.247(b)(4)

The conducted output power limit specified in paragraph (b) of this section is based on the use of antennas with directional gains that do not exceed 6 dBi. Except as shown in paragraph (c) of this section, if transmitting antennas of directional gain greater than 6 dBi are used, the conducted output power from the intentional radiator shall be reduced below the stated values in paragraphs (b)(1), (b)(2), and (b)(3) of this section, as appropriate, by the amount in dB that the directional gain of the antenna exceeds 6 dBi.

RESULTS

Complies

11. Photo

11.1. External Photo

View of EUT-1



View of EUT-2

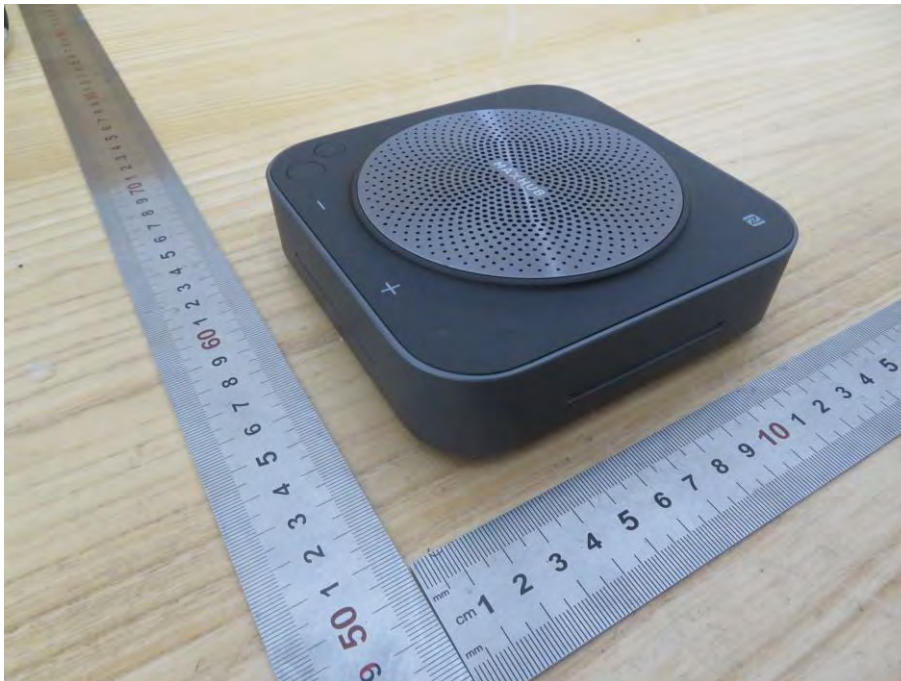

View of EUT-3



View of EUT-4



11.2. Internal Photo

Internal View of EUT-1

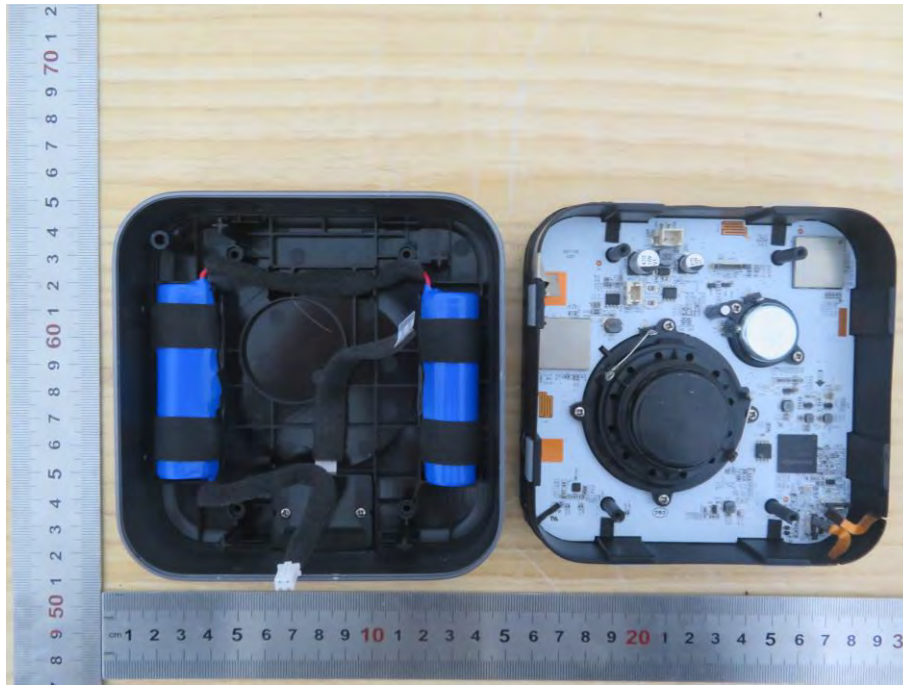

Internal View of EUT-2

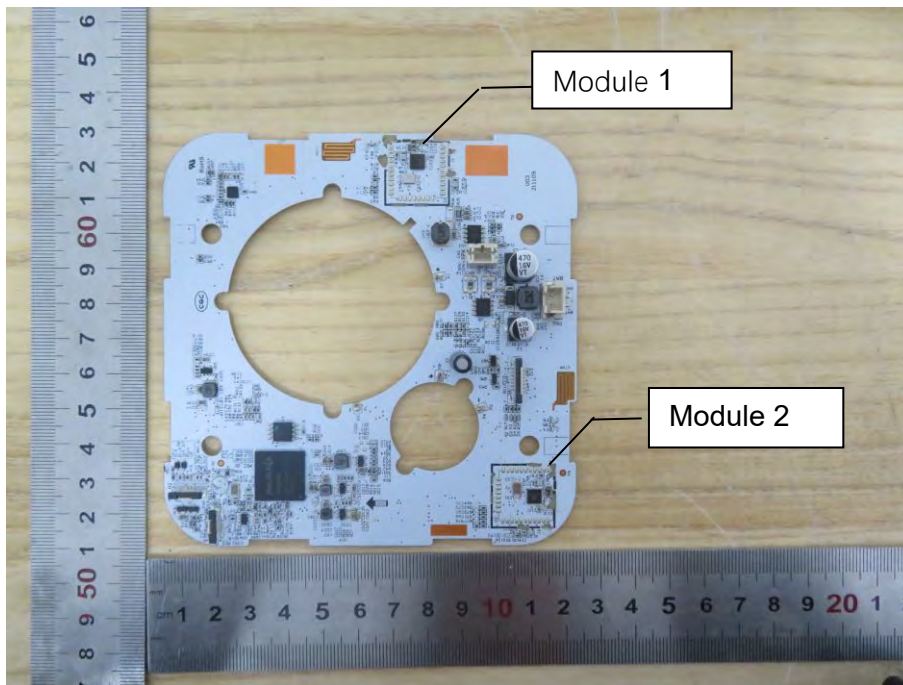

Internal View of EUT-3

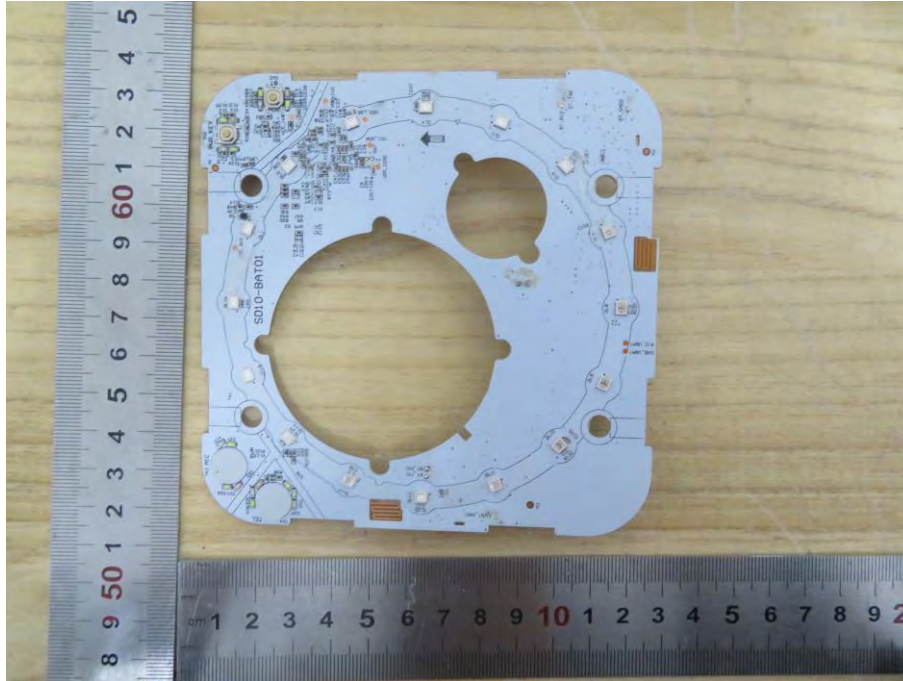

Internal View of EUT-4

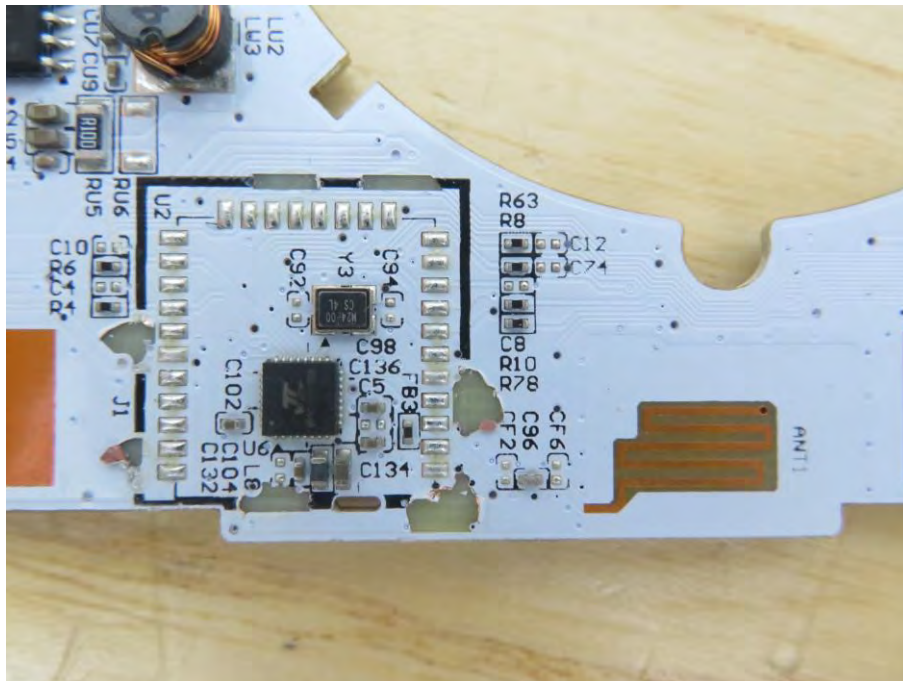

Internal View of EUT-5

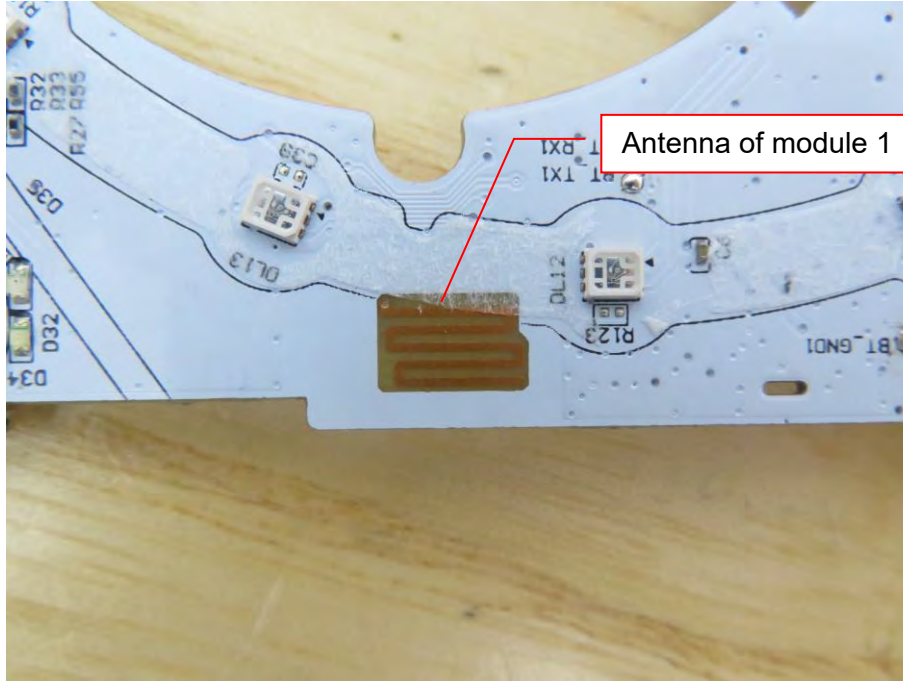

Internal View of EUT-6

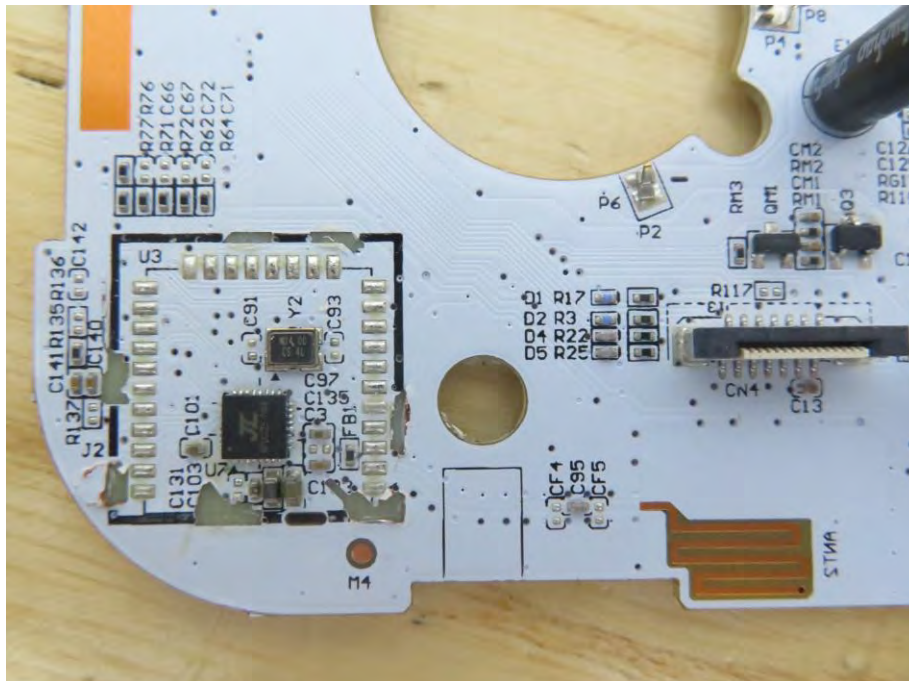

Internal View of EUT-9

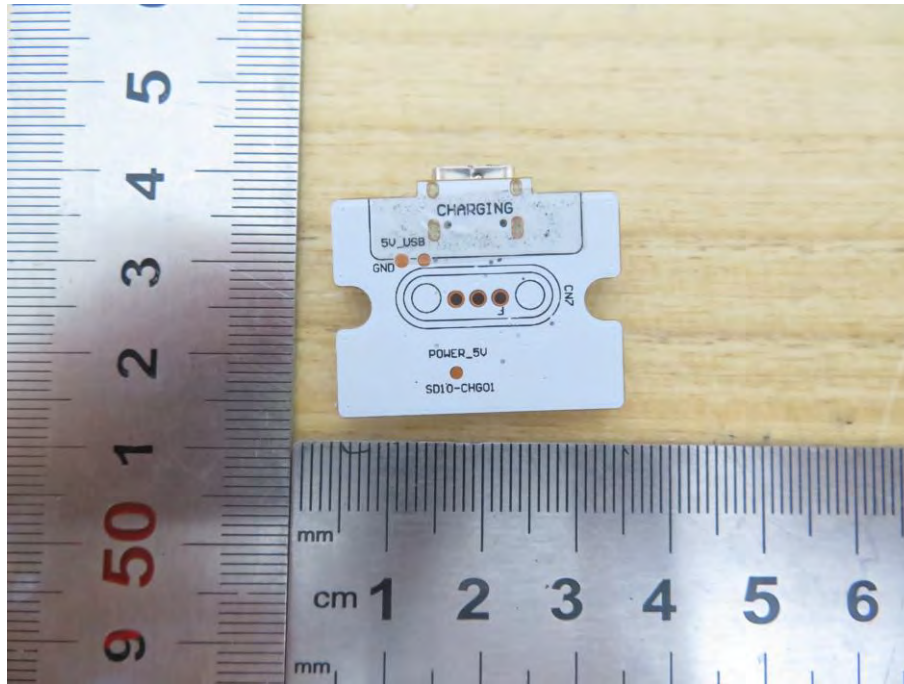

Internal View of EUT-10

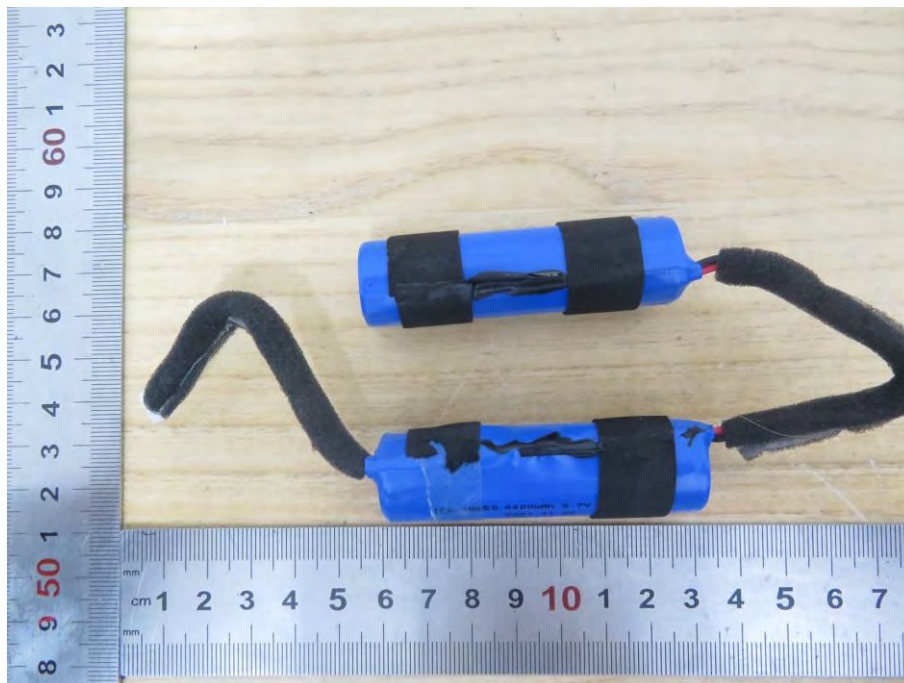

Internal View of EUT-11



Internal View of EUT-12

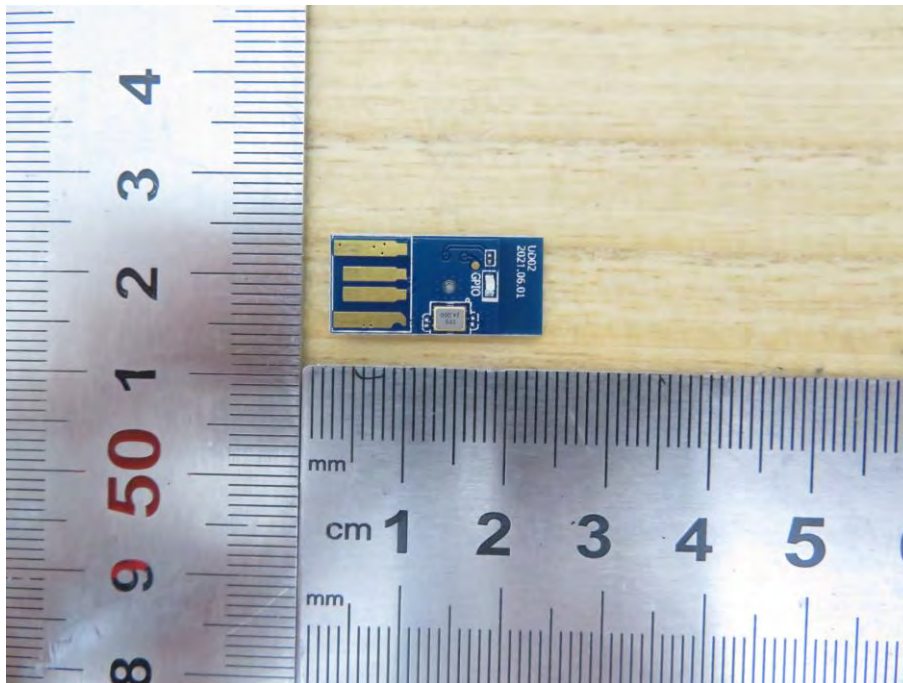

Internal View of EUT-13

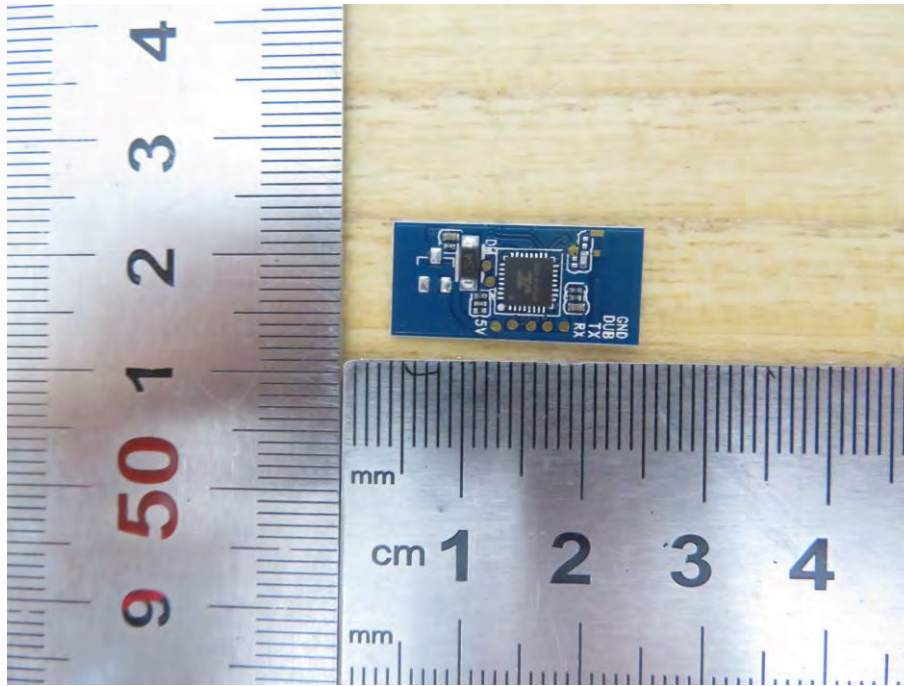

11.3. Setup Photo

Radiated Disturbance below 1 GHz and above 30 MHz



Radiated Disturbance below 30 MHz

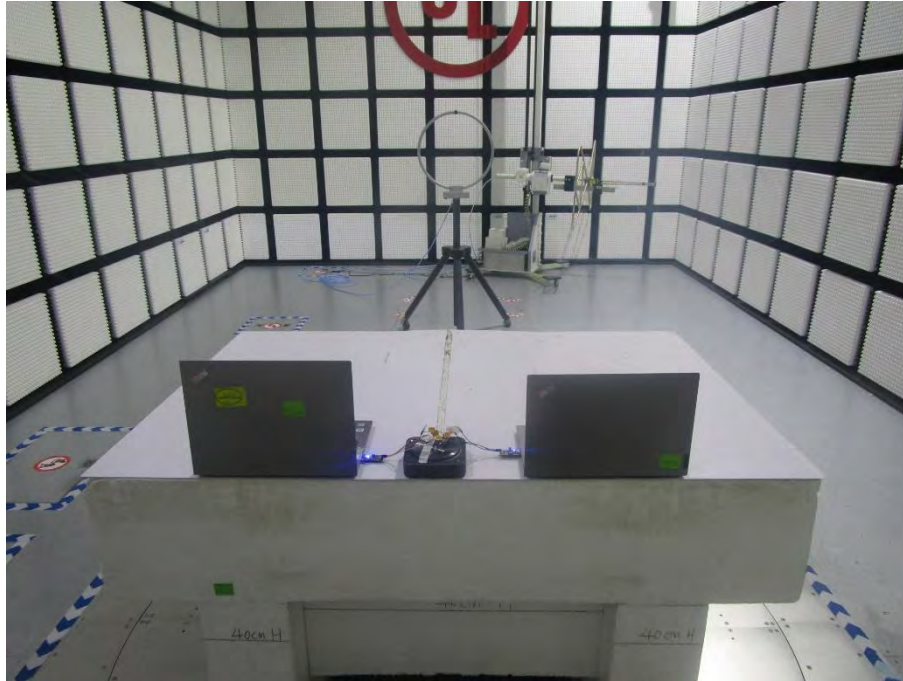

Radiated Disturbance Setup (Above 1 GHz – X axis)

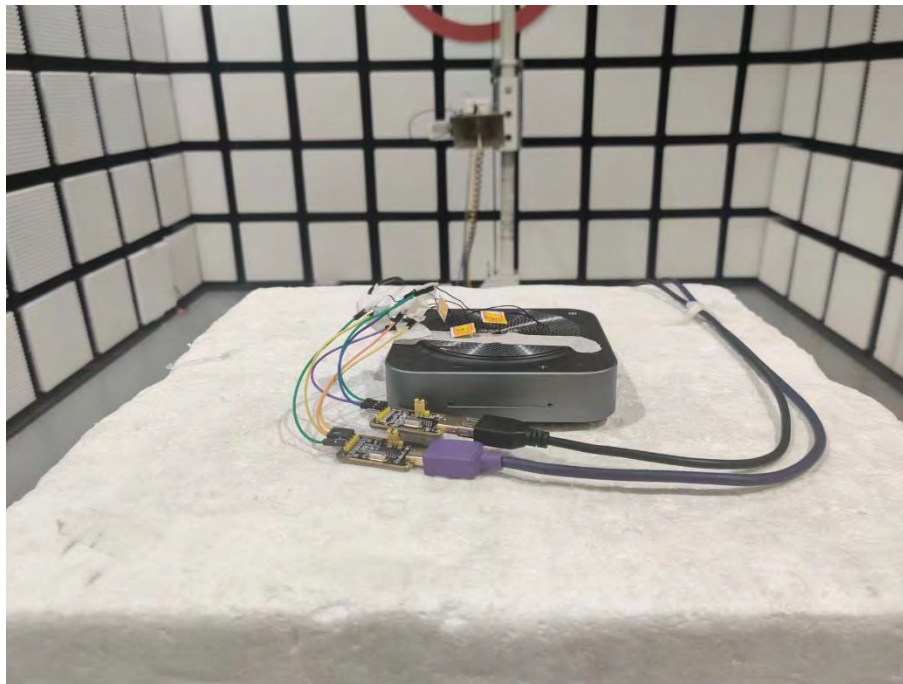

Radiated Disturbance Setup (Above 1 GHz – Y axis)

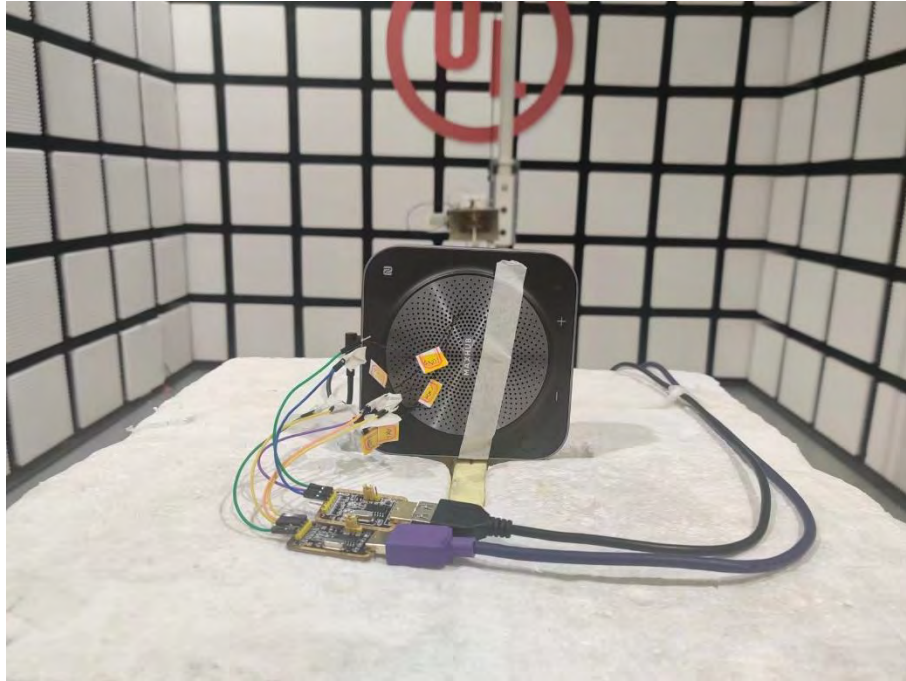

Radiated Disturbance Setup (Above 1 GHz – Z axis)



Radiated Disturbance Setup (Above 1 GHz – Worst Case)



AC Power Line Conducted Emissions setup

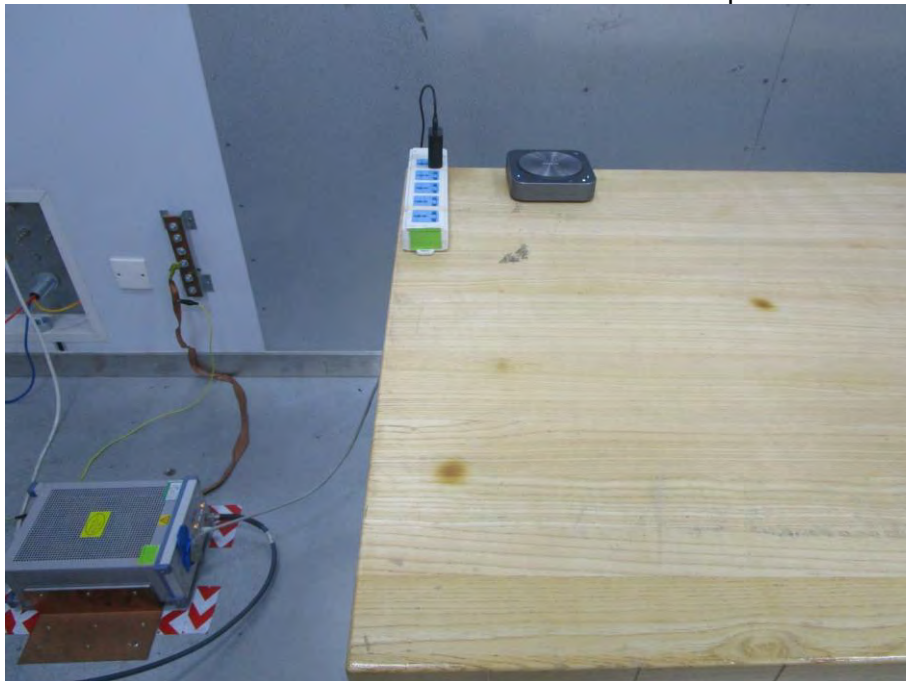



12. Appendix

12.1. Appendix A: 20dB Emission Bandwidth

12.1.1. Test Result

Test Mode	Antenna	Channel	20db EBW[MHz]	FL[MHz]	FH[MHz]	Verdict
DH5	Ant1	2402	0.936	2401.529	2402.465	PASS
		2441	0.936	2440.529	2441.465	PASS
		2480	0.978	2479.490	2480.468	PASS
2DH5	Ant1	2402	1.296	2401.355	2402.651	PASS
		2441	1.293	2440.358	2441.651	PASS
		2480	1.317	2479.334	2480.651	PASS

Note:

The EUT has two independent RF Modules, each RF module supports one antenna. All the modules and antennas are identical. When we test one module, another module will be disabled.

12.1.2. Test Graphs



DH5 Ant1 2402



DH5 Ant1 2441



DH5 Ant1 2480



2DH5 Ant1 2402



2DH5 Ant1 2441

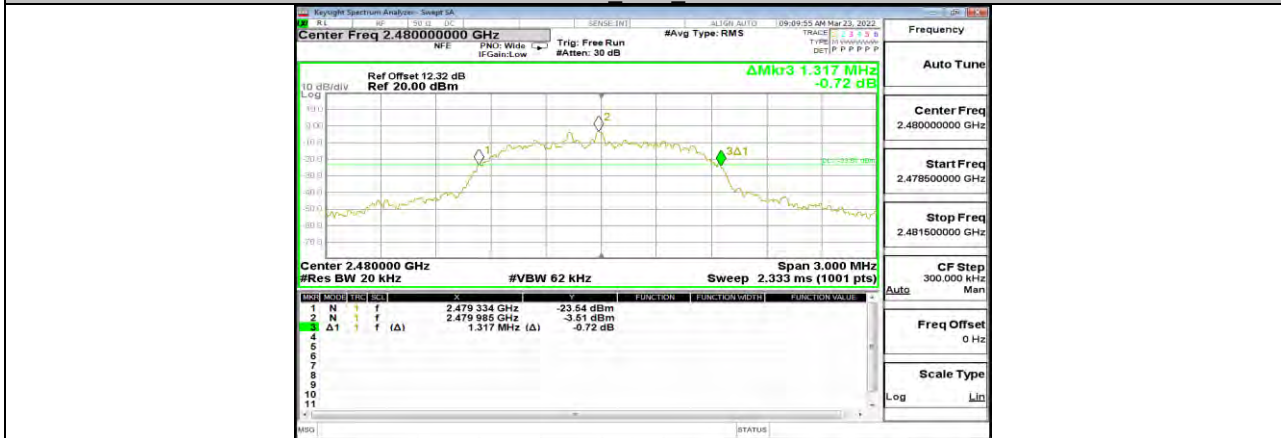

2DH5 Ant1 2480



12.2. Appendix B: Occupied Channel Bandwidth

12.2.1. Test Result

Test Mode	Antenna	Channel	OCB [MHz]	FL[MHz]	FH[MHz]	Verdict
DH5	Ant1	2402	0.88004	2401.549	2402.429	PASS
		2441	0.88510	2440.546	2441.431	PASS
		2480	0.89020	2479.545	2480.436	PASS
2DH5	Ant1	2402	1.1805	2401.400	2402.581	PASS
		2441	1.1862	2440.398	2441.584	PASS
		2480	1.1957	2479.395	2480.590	PASS

Note:

The EUT has two independent RF Modules, each RF module supports one antenna. All the modules and antennas are identical. When we test one module, another module will be disabled.

12.2.2. Test Graphs



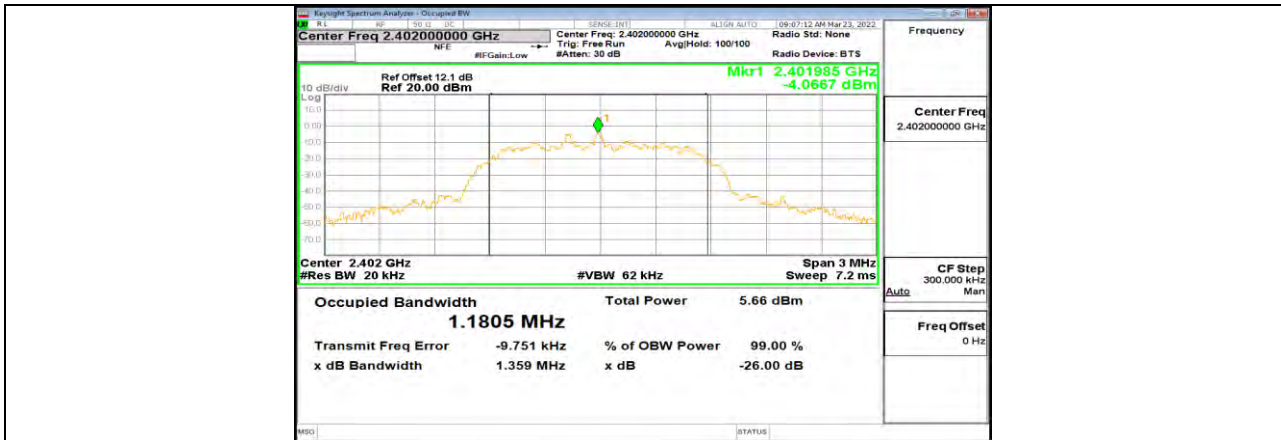

2DH5 Ant1 2402

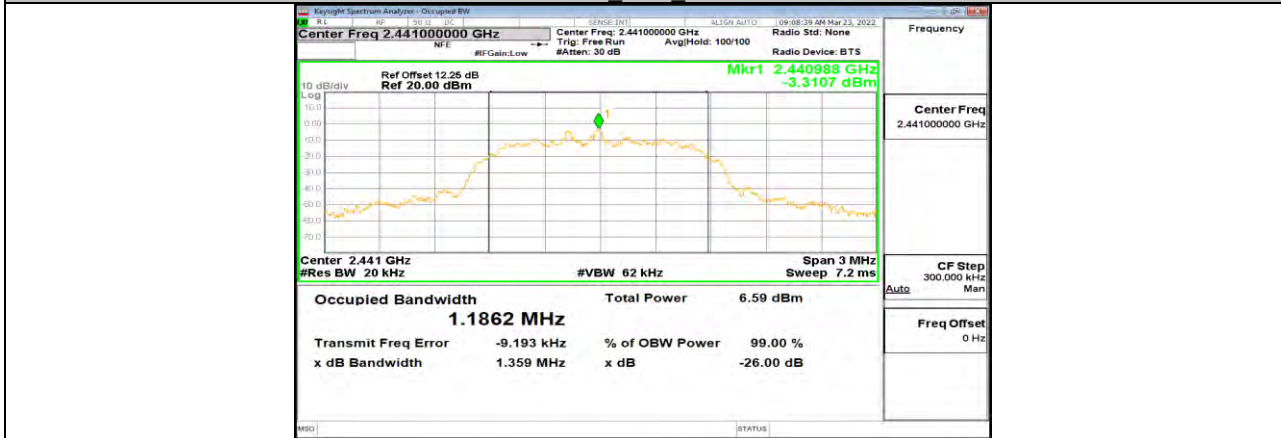

2DH5 Ant1 2441

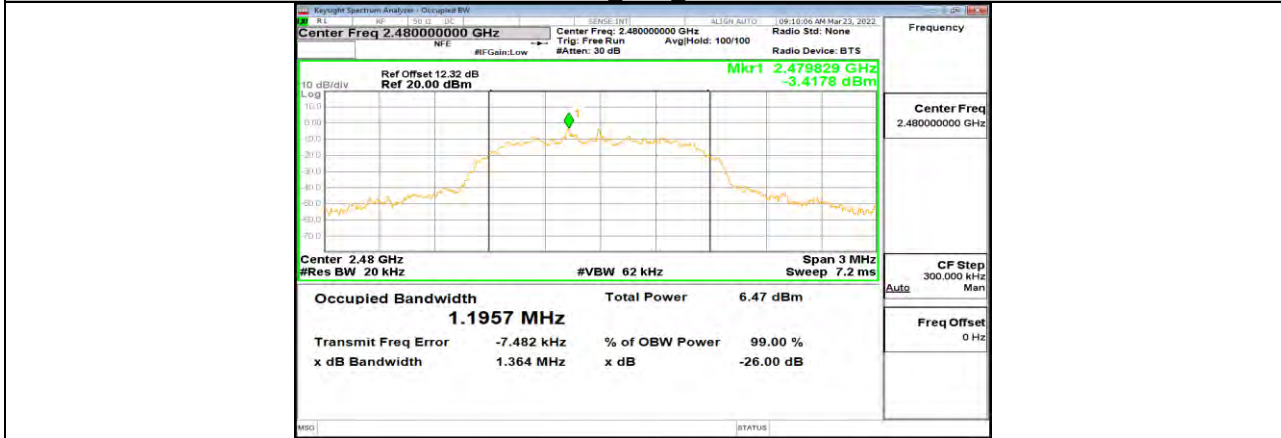

2DH5 Ant1 2480



12.3. Appendix C: Maximum conducted output power

12.3.1. Test Result

Test Mode	Antenna	Channel	Result[dBm]	Limit[dBm]	Verdict
DH5	Ant1	2402	2.83	≤30	PASS
		2441	1.07	≤30	PASS
		2480	2.72	≤30	PASS
2DH5	Ant1	2402	0.8	≤20.97	PASS
		2441	1.7	≤20.97	PASS
		2480	1.89	≤20.97	PASS

Note:

The EUT has two independent RF Modules, each RF module supports one antenna. All the modules and antennas are identical. When we test one module, another module will be disabled.



12.4. Appendix D: Carrier frequency separation

12.4.1. Test Result

Test Mode	Antenna	Channel	Result[MHz]	Limit[MHz]	Verdict
DH5	Ant1	Hop	1.008	≥ 0.978	PASS
2DH5	Ant1	Hop	1.012	≥ 0.878	PASS

Note:

The EUT has two independent RF Modules, each RF module supports one antenna. All the modules and antennas are identical. When we test one module, another module will be disabled.

12.4.2. Test Graphs



12.5. Appendix E: Time of occupancy

12.5.1. Test Result

FHSS Mode						
Test Mode	Antenna	Channel	BurstWidth [ms]	Result[s]	Limit[s]	Verdict
DH1	Ant1	Hop	0.38	0.122	<=0.4	PASS
DH3	Ant1	Hop	1.64	0.262	<=0.4	PASS
DH5	Ant1	Hop	2.88	0.307	<=0.4	PASS
2DH1	Ant1	Hop	0.39	0.125	<=0.4	PASS
2DH3	Ant1	Hop	1.64	0.262	<=0.4	PASS
2DH5	Ant1	Hop	2.89	0.308	<=0.4	PASS

AFHSS Mode						
Test Mode	Antenna	Channel	BurstWidth [ms]	Result[s]	Limit[s]	Verdict
DH1	Ant1	Hop	0.38	0.061	<=0.4	PASS
DH3	Ant1	Hop	1.64	0.131	<=0.4	PASS
DH5	Ant1	Hop	2.88	0.154	<=0.4	PASS
2DH1	Ant1	Hop	0.39	0.062	<=0.4	PASS
2DH3	Ant1	Hop	1.64	0.131	<=0.4	PASS
2DH5	Ant1	Hop	2.89	0.154	<=0.4	PASS

Note:

The EUT has two independent RF Modules, each RF module supports one antenna. All the modules and antennas are identical. When we test one module, another module will be disabled.

12.5.2. Test Graphs

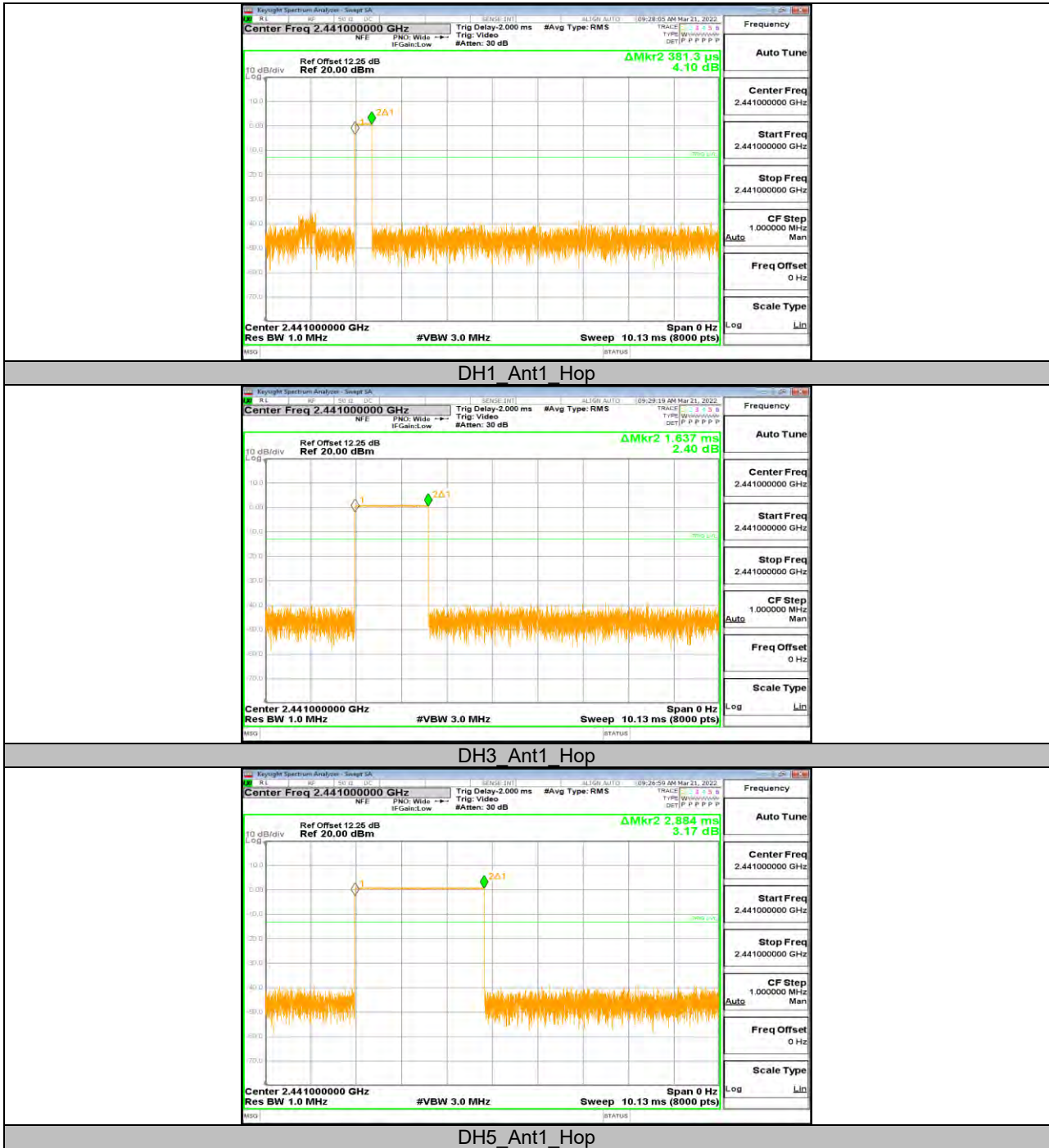



2DH1 Ant1 Hop



2DH3 Ant1 Hop

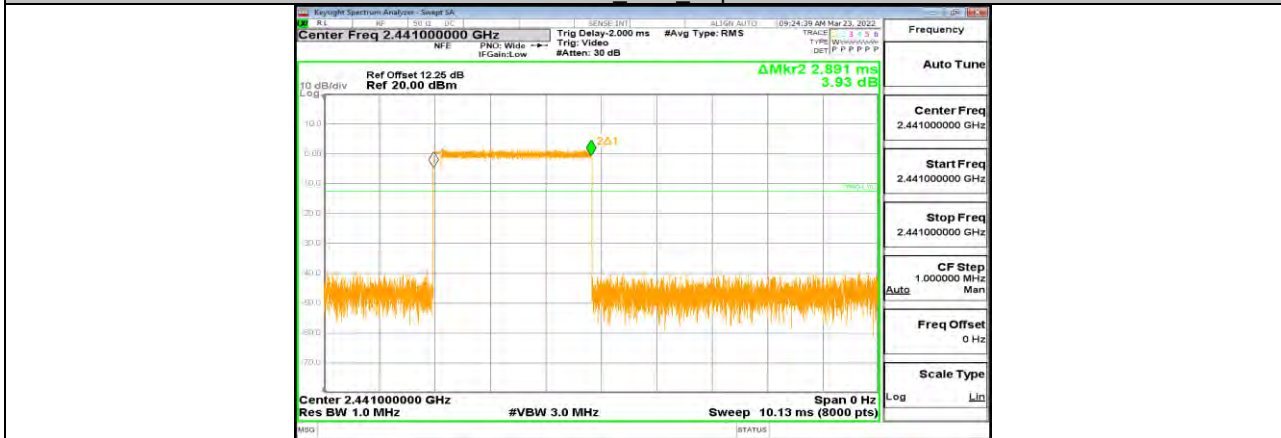

2DH5 Ant1 Hop



12.6. Appendix F: Number of hopping channels

12.6.1. Test Result

Test Mode	Antenna	Channel	Result[Num]	Limit[Num]	Verdict
DH5	Ant1	Hop	79	≥15	PASS
2DH5	Ant1	Hop	79	≥15	PASS

Note:

The EUT has two independent RF Modules, each RF module supports one antenna. All the modules and antennas are identical. When we test one module, another module will be disabled.

12.6.2. Test Graphs

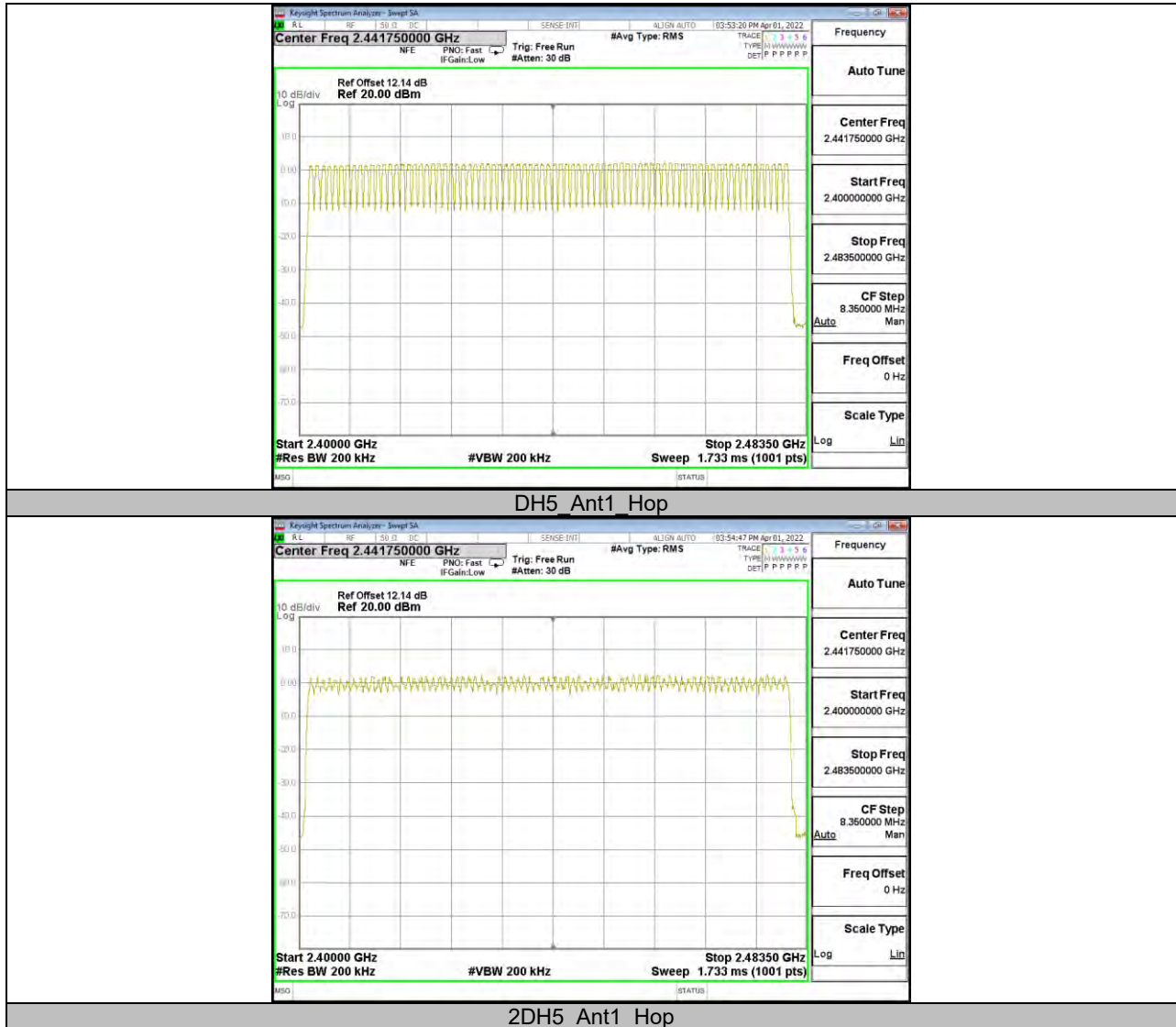



12.7. Appendix G: Band edge measurements

12.7.1. Test Result

Test Mode	Antenna	ChName	Channel	RefLevel [dBm]	Result [dBm]	Limit [dBm]	Verdict
DH5	Ant1	Low	2402	2.37	-40.26	≤ -17.63	PASS
		High	2480	2.23	-39.98	≤ -17.77	PASS
		Low	Hop_2402	-0.24	-47.59	≤ -20.24	PASS
		High	Hop_2480	0.49	-47.64	≤ -19.51	PASS
2DH5	Ant1	Low	2402	-0.31	-47.33	≤ -20.31	PASS
		High	2480	0.77	-47.56	≤ -19.23	PASS
		Low	Hop_2402	-0.10	-47.4	≤ -20.1	PASS
		High	Hop_2480	0.85	-46.98	≤ -19.15	PASS

Note:

The EUT has two independent RF Modules, each RF module supports one antenna. All the modules and antennas are identical. When we test one module, another module will be disabled.

12.7.2. Test Graphs

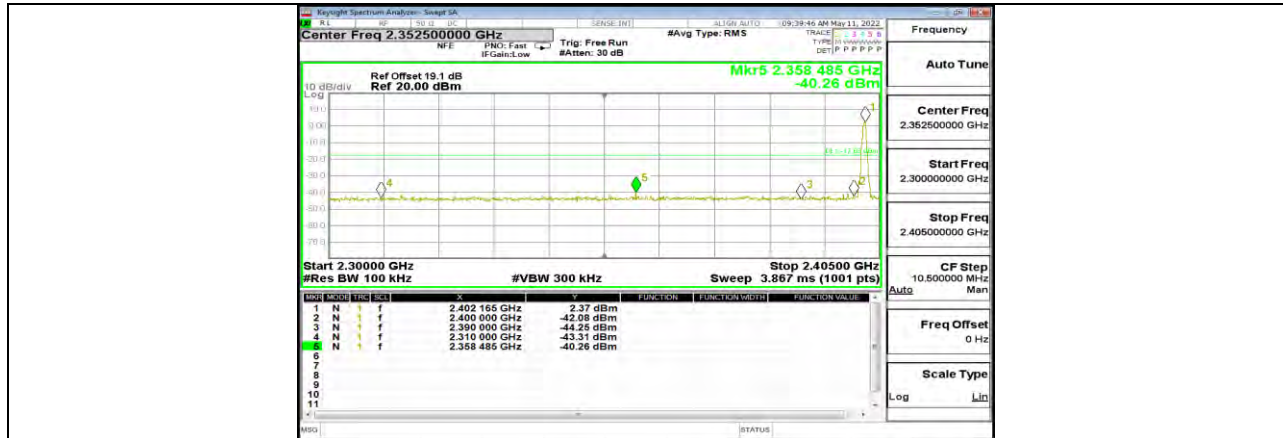

DH5 Ant1 Low 2402

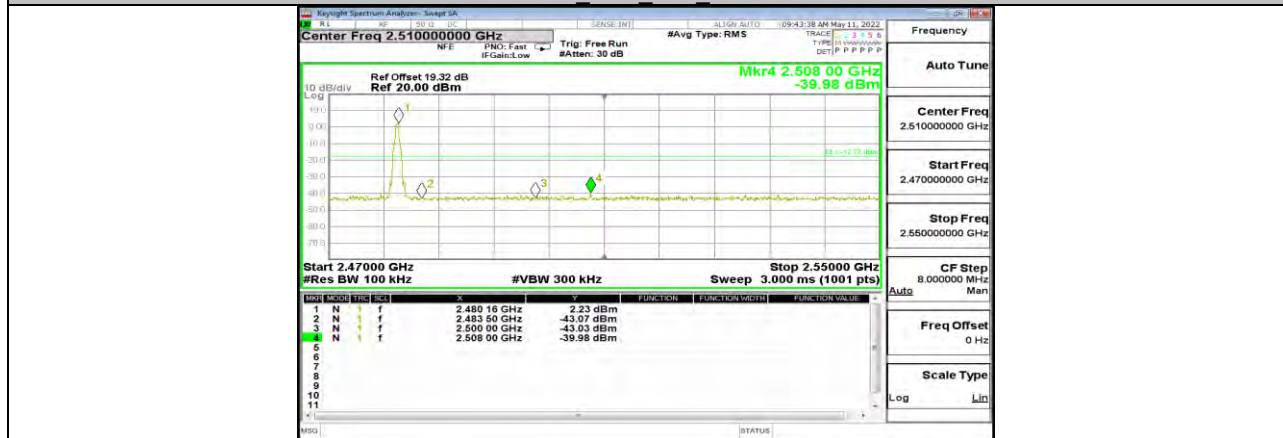

DH5 Ant1 High 2480

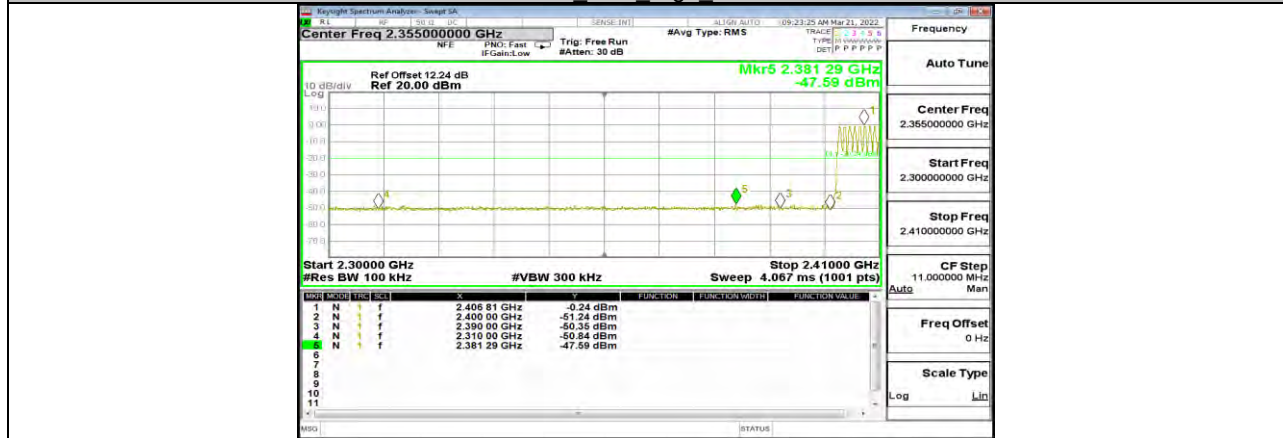

DH5 Ant1 Low Hop 2402

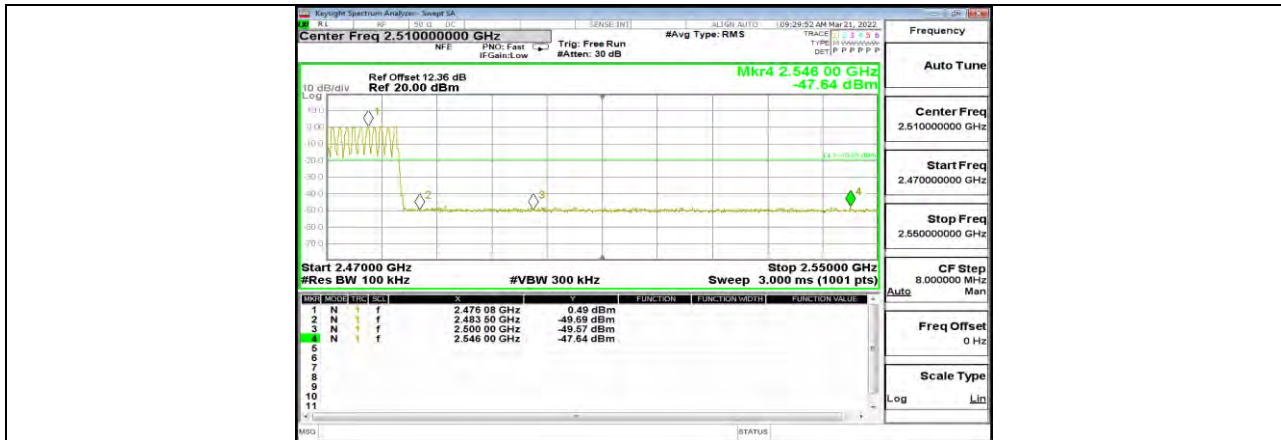

DH5 Ant1 High Hop 2480

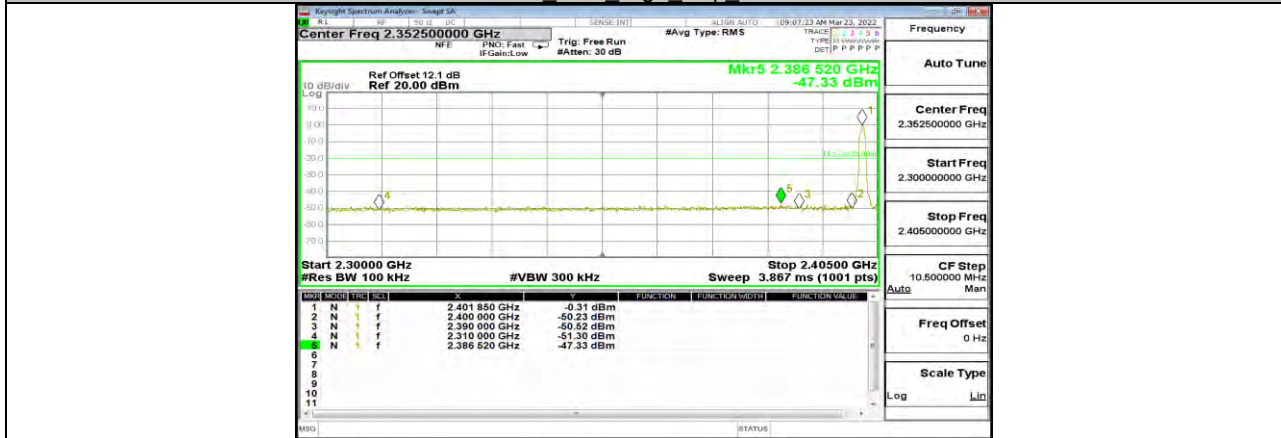

2DH5 Ant1 Low 2402

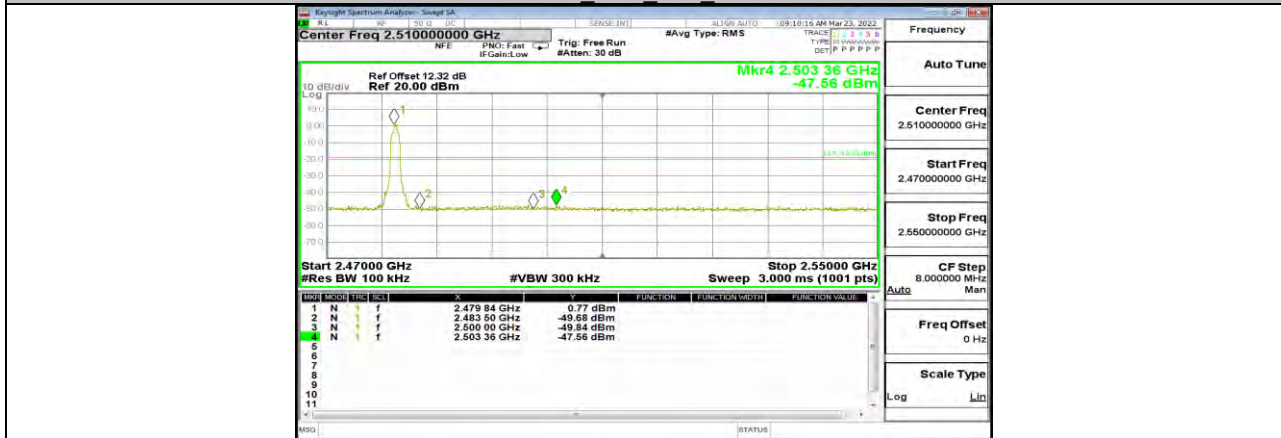

2DH5 Ant1 High 2480

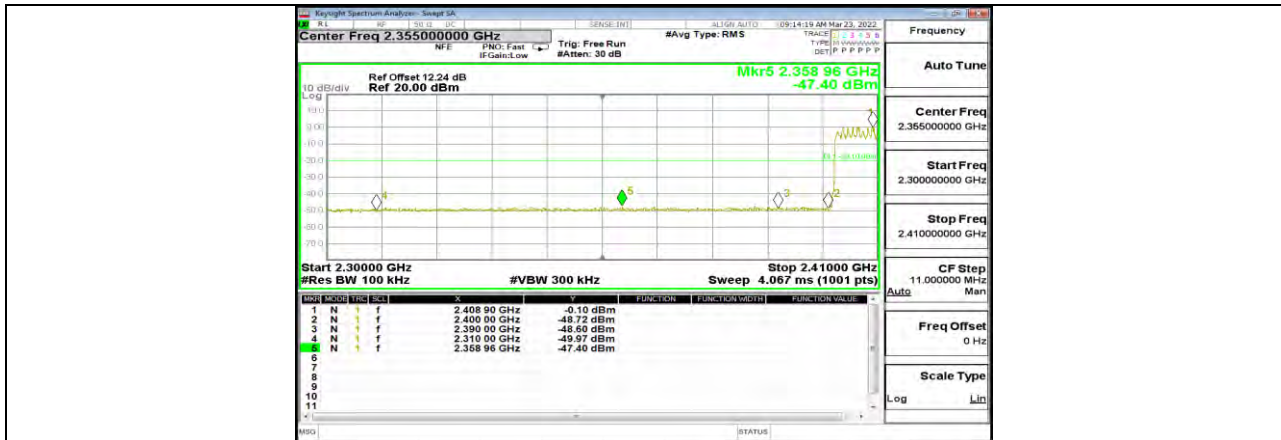

2DH5 Ant1 Low Hop 2402

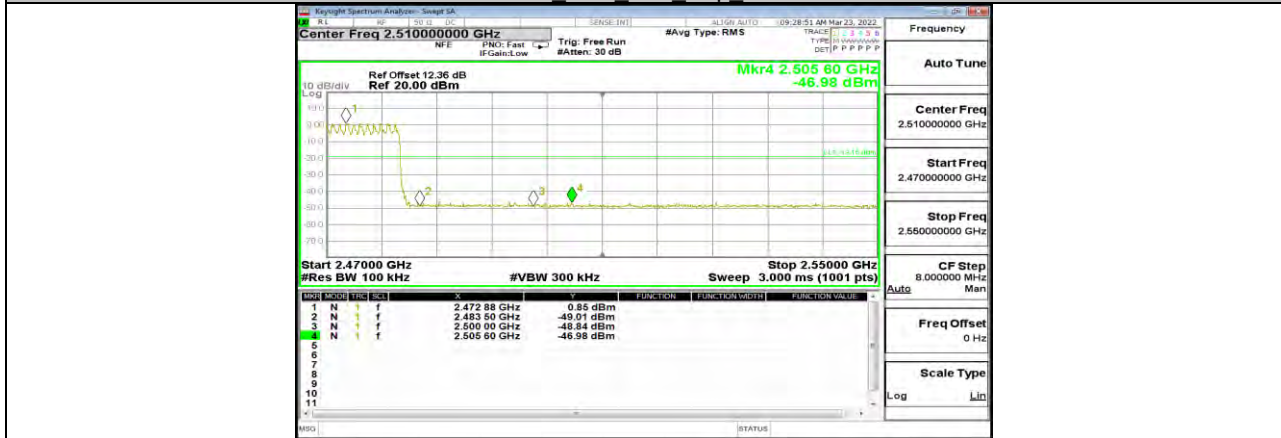

2DH5 Ant1 High Hop 2480



12.8. Appendix H: Conducted Spurious Emission
12.8.1. Test Result

Test Mode	Antenna	Channel	FreqRange [MHz]	RefLevel [dBm]	Result [dBm]	Limit [dBm]	Verdict
DH5	Ant1	2402	Reference	2.15	2.15	---	PASS
			30~1000	2.15	-52.28	≤-17.85	PASS
			1000~26500	2.15	-44.58	≤-17.85	PASS
		2441	Reference	0.65	0.65	---	PASS
			30~1000	0.65	-52.94	≤-19.35	PASS
			1000~26500	0.65	-44.31	≤-19.35	PASS
		2480	Reference	2.24	2.24	---	PASS
			30~1000	2.24	-52.25	≤-17.76	PASS
			1000~26500	2.24	-44.83	≤-17.76	PASS
2DH5	Ant1	2402	Reference	-0.30	-0.30	---	PASS
			30~1000	-0.30	-60.31	≤-20.3	PASS
			1000~26500	-0.30	-52	≤-20.3	PASS
		2441	Reference	0.60	0.60	---	PASS
			30~1000	0.60	-58.69	≤-19.4	PASS
			1000~26500	0.60	-51.79	≤-19.4	PASS
		2480	Reference	0.79	0.79	---	PASS
			30~1000	0.79	-56.75	≤-19.21	PASS
			1000~26500	0.79	-51.1	≤-19.21	PASS

Note:

The EUT has two independent RF Modules, each RF module supports one antenna. All the modules and antennas are identical. When we test one module, another module will be disabled.



12.8.2. Test Graphs





DH5 Ant1 2441 0-Reference

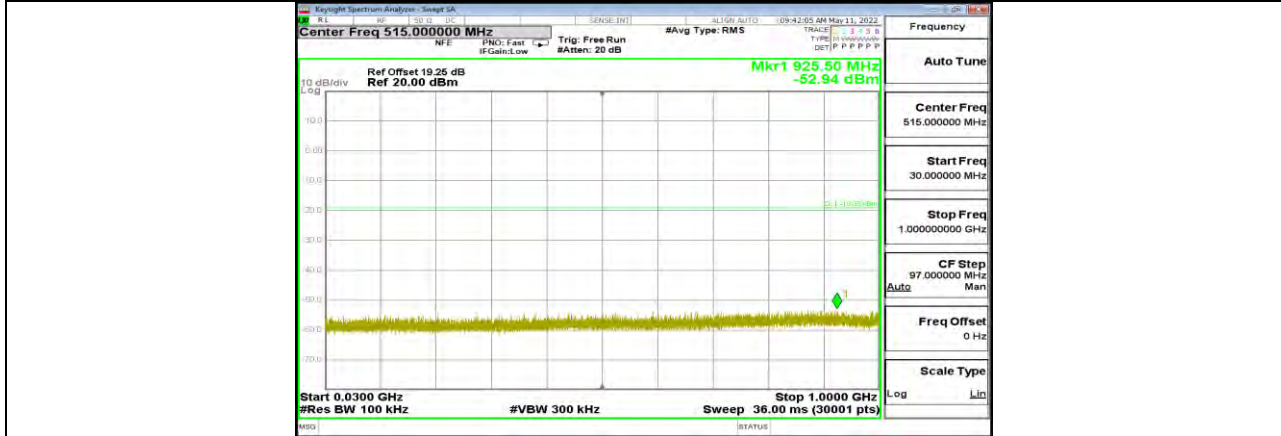

DH5 Ant1 2441 30~1000

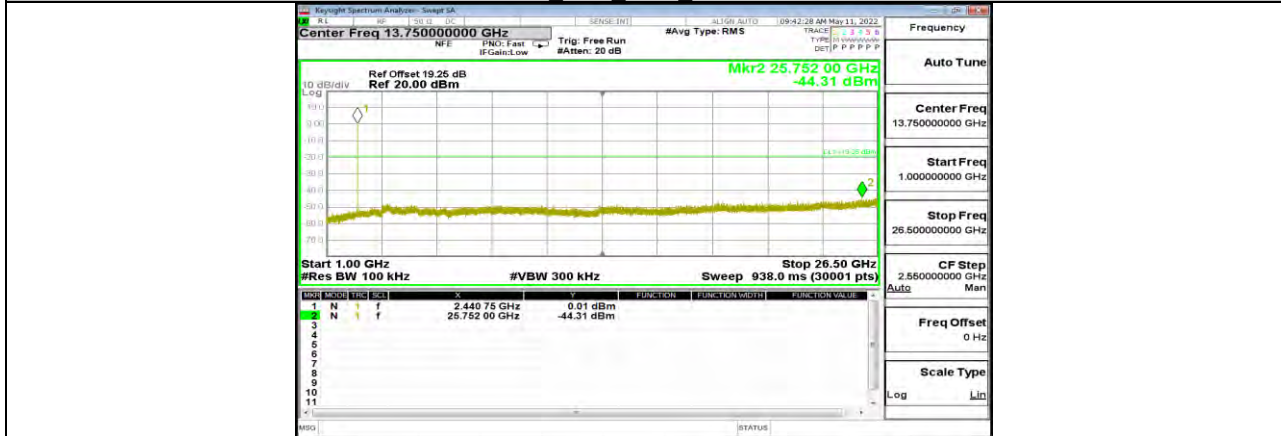

DH5 Ant1 2441 1000~26500

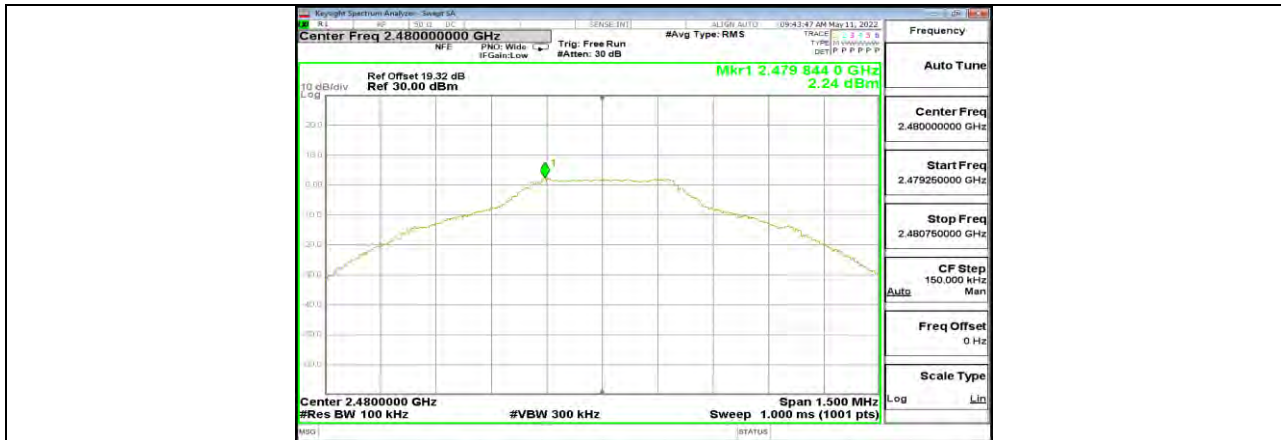

DH5 Ant1 2480 0-Reference

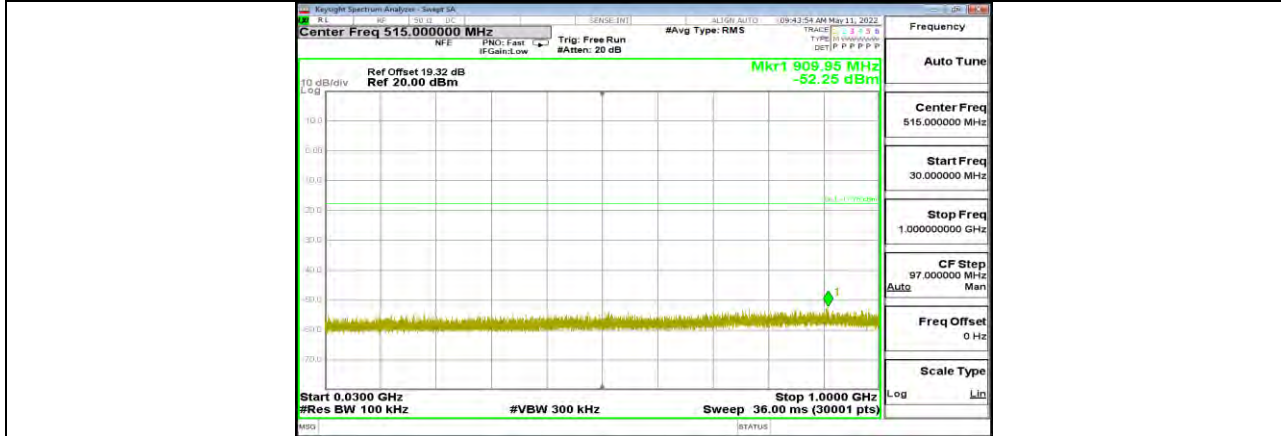

DH5 Ant1 2480 30-1000

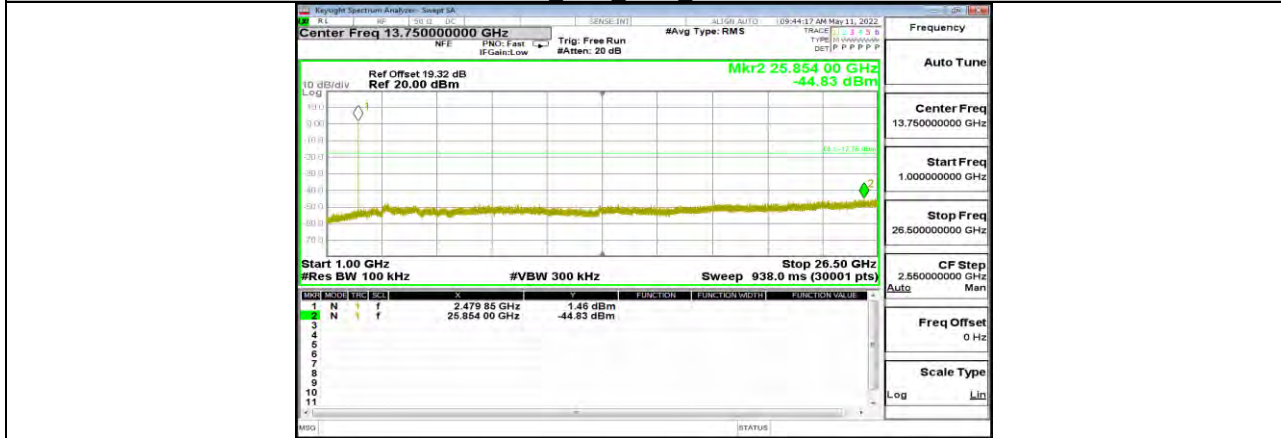

DH5 Ant1 2480 1000-26500



2DH5 Ant1 2402 0~Reference

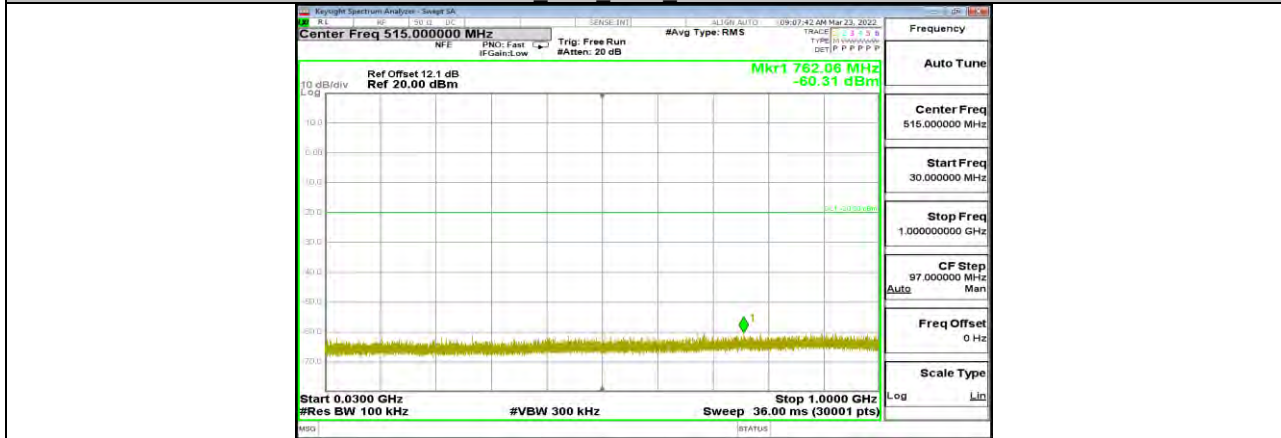

2DH5 Ant1 2402 30~1000

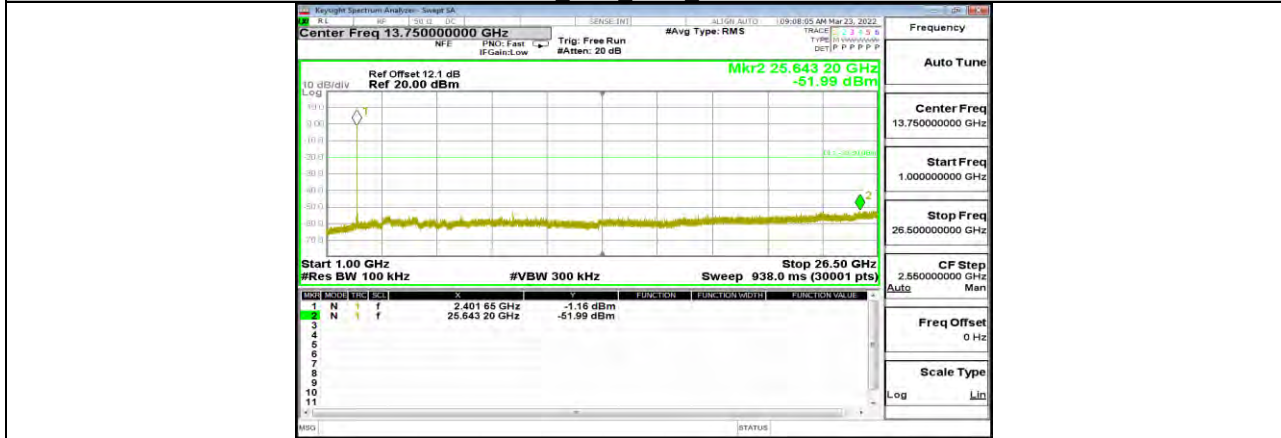

2DH5 Ant1 2402 1000~26500



2DH5 Ant1 2441 0~Reference

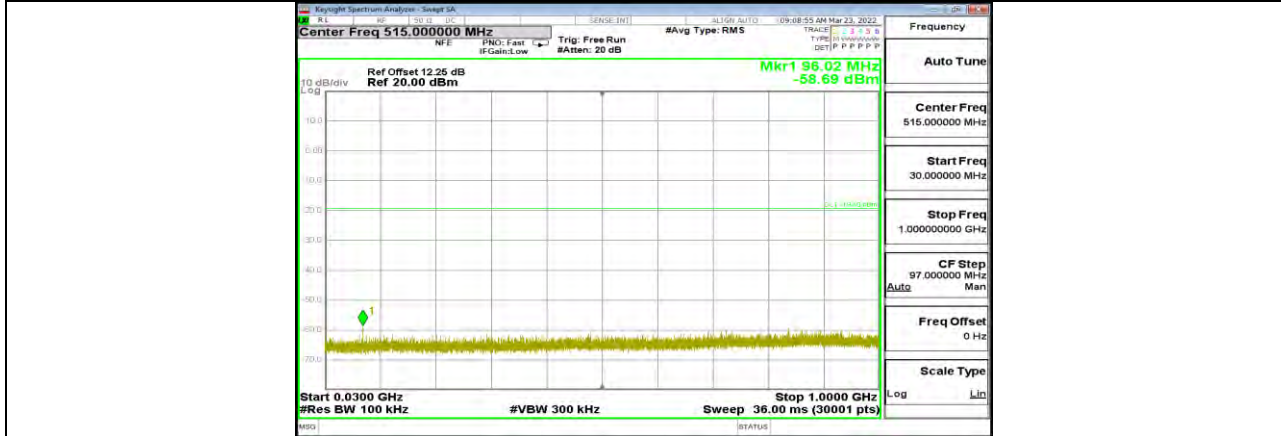

2DH5 Ant1 2441 30~1000

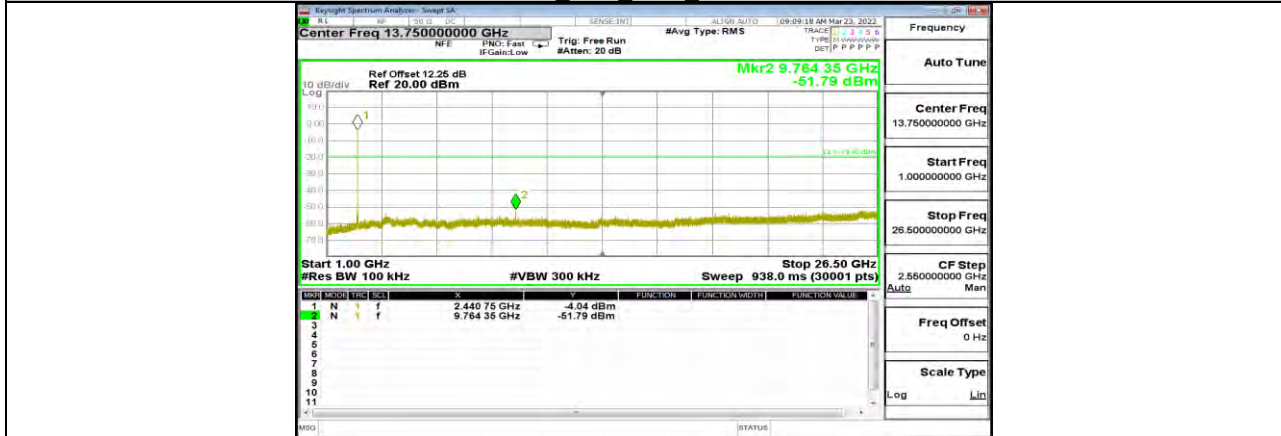

2DH5 Ant1 2441 1000~26500



2DH5 Ant1 2480 0~Reference

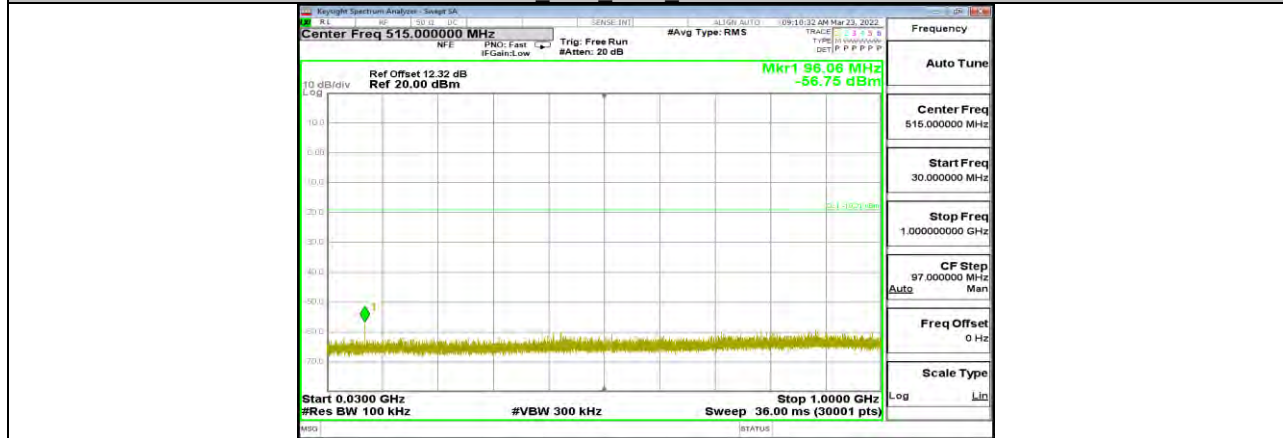

2DH5 Ant1 2480 30~1000

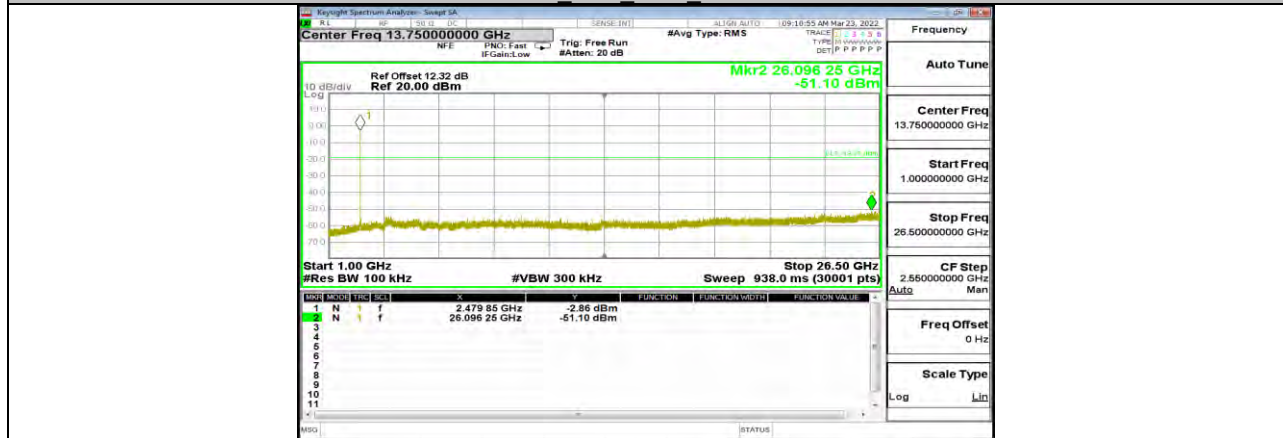

2DH5 Ant1 2480 1000~26500



3DH5 Ant1 2480 0~Reference

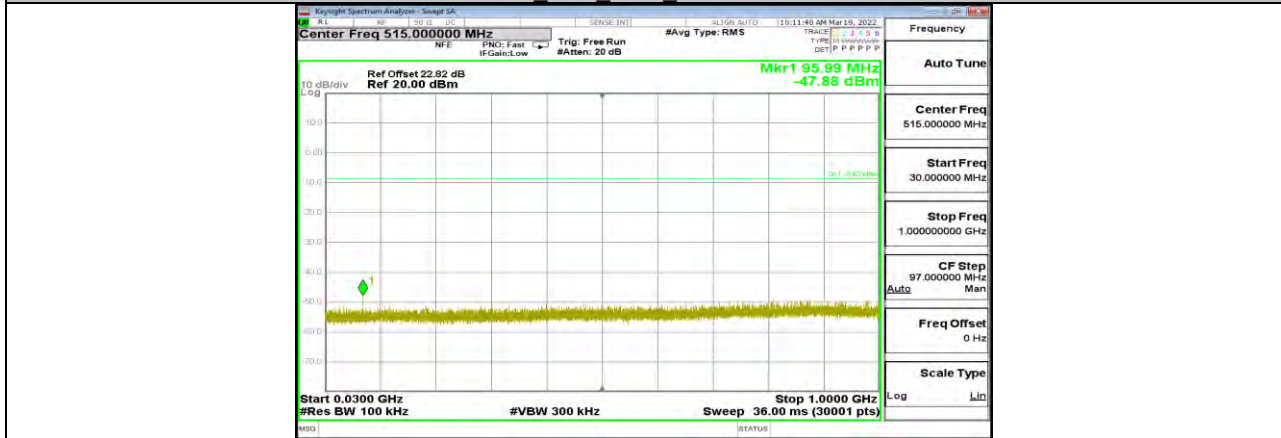

3DH5 Ant1 2480 30~1000

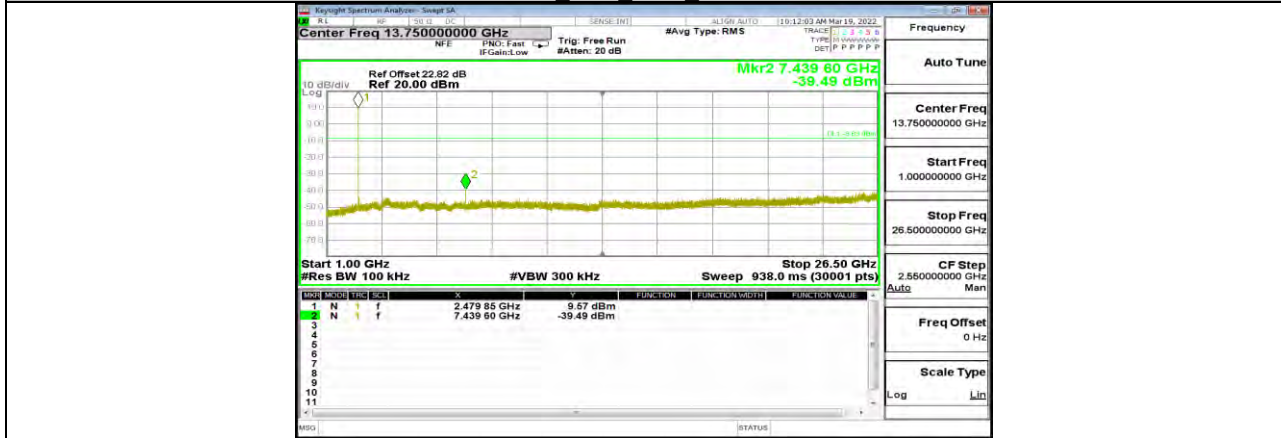

3DH5 Ant1 2480 1000~26500



12.9. Appendix I: Duty Cycle

12.9.1. Test Result

Test Mode	On Time (msec)	Period (msec)	Duty Cycle x (Linear)	Duty Cycle (%)	Duty Cycle Correction Factor (dB)	1/T Minimum VBW (kHz)	Final setting For VBW (kHz)
DH5	2.89	3.75	0.9958	99.58	0.02	0.12	0.01
2DH5	2.90	3.75	0.9734	97.34	0.12	0.72	1

Note:

Duty Cycle Correction Factor=10log (1/x).

Where: x is Duty Cycle (Linear)

Where: T is On Time

If that calculated VBW is not available on the analyzer then the next higher value should be used.

Note:

The EUT has two independent RF Modules, each RF module supports one antenna. All the modules and antennas are identical. When we test one module, another module will be disabled.



12.9.2. Test Graphs



DH5 Ant1 2402



2DH5 Ant1 2402

END OF REPORT