



**SGS-CSTC Standards Technical Services  
(Shanghai) Co., Ltd.**

588 West Jindu Road, Xinqiao, Songjiang, 201612 Shanghai, China  
 Telephone: +86 (0) 21 6191 5666  
 Fax: +86 (0) 21 6191 5678  
 ee.shanghai@sgs.com

Report No.: SHEM161200793103  
 Page: 1 of 45

**1 Cover Page**

***RF TEST REPORT***

<b>Application No.:</b>	SHEM1612007931CR
<b>Applicant:</b>	Adam Hall GmbH
<b>FCC ID:</b>	2AFF62G82IUAM
<b>IC:</b>	22349-2G82IUAM
<b>Equipment Under Test (EUT):</b>	
<b>NOTE:</b> The following sample(s) was/were submitted and identified by the client as	
<b>Product Name:</b>	Active PA BoX
<b>Model No.(EUT):</b>	MAUI28G2
<b>Standards:</b>	FCC PART 15 Subpart C: 2016 RSS-247 Issue 1 (May 2015) RSS-Gen Issue 4 (November 2014)
<b>Date of Receipt:</b>	2016-12-15
<b>Date of Test:</b>	2016-12-15 to 2017-1-9
<b>Date of Issue:</b>	2017-1-9
<b>Test Result:</b>	<b>Pass*</b>

\* In the configuration tested, the EUT (Equipment under test) complied with the standards specified above.



The manufacturer should ensure that all products in series production are in conformity with the product sample detailed in this report. If the product in this report is used in any configuration other than that detailed in the report, the manufacturer must ensure the new system complies with all relevant standards.

The report must not be used by the client to claim product certification, approval, or endorsement by NVLAP, NIST, or any agency of the federal government. All test results in this report can be traceable to National or International Standards.

This document is issued by the Company subject to its General Conditions of Service printed overleaf, available on request or accessible at [www.sgs.com/terms\\_and\\_conditions.htm](http://www.sgs.com/terms_and_conditions.htm) and, for electronic format documents, subject to Terms and Conditions for Electronic Documents at [www.sgs.com/terms\\_e-document.htm](http://www.sgs.com/terms_e-document.htm). Attention is drawn to the limitation of liability, indemnification and jurisdiction issues defined therein. Any holder of this document is advised that information contained hereon reflects the Company's findings at the time of its intervention only and within the limits of Client's instructions, if any. The Company's sole responsibility is to its Client and this document does not exonerate parties to a transaction from exercising all their rights and obligations under the transaction documents. This document cannot be reproduced except in full, without prior written approval of the Company. Any unauthorized alteration, forgery or falsification of the content or appearance of this document is unlawful and offenders may be prosecuted to the fullest extent of the law. Unless otherwise stated the results shown in this test report refer only to the sample(s) tested and such sample(s) are retained for 90 days only

## 2 Test Summary

Test Item	FCC Requirement	IC Requirement	Test method	Result
Antenna Requirement	FCC Part 15, Subpart C Section 15.203/15.247 (c)	RSS-Gen Section 8.1.3	---	PASS
AC Power Line Conducted Emission	FCC Part 15, Subpart C Section 15.207	RSS-Gen Section 8.8	ANSI C63.10 (2013) Section 6.2	PASS
20dB Occupied Bandwidth	FCC Part 15, Subpart C Section 15.247 (a)(1)	RSS-247 Clause 5.1(1)	ANSI C63.10 (2013) Section 6.9.2	PASS
Conducted Peak Output Power	FCC Part 15, Subpart C Section 15.247 (b)(1)	RSS-247 Clause 5.4(2)	ANSI C63.10 (2013) Section 7.8.5	PASS
Carrier Frequencies Separation	FCC Part 15, Subpart C Section 15.247 (a)(1)	RSS-247 Clause 5.1(2))	ANSI C63.10 (2013) Section 7.8.2	PASS
Hopping Channel Number	FCC Part 15, Subpart C Section 15.247 (a)(1)	RSS-247 Clause 5.1(3)	ANSI C63.10 (2013) Section 7.8.3	PASS
Dwell Time	FCC Part 15, Subpart C Section 15.247 (a)(1)	RSS-247 Clause 5.1(4)	ANSI C63.10 (2013) Section 7.8.4	PASS
Conducted Spurious Emissions and Band- edge	FCC Part 15, Subpart C Section 15.247(d)	RSS-247 Clause 5.5	ANSI C63.10 (2013) Section 7.8.6&7.8.8	PASS
Radiated Spurious Emissions and Band- edge	FCC Part 15, Subpart C Section 15.209&15.205	RSS-247 Clause 5.5	ANSI C63.10 (2013) Section 6.4&6.5&6.6&6.10	PASS
99% Occupied Bandwidth	---	RSS-Gen Section 6.6	RSS-Gen section 6.6	PASS

### 3 Contents

	Page
<b>1 COVER PAGE .....</b>	<b>1</b>
<b>2 TEST SUMMARY .....</b>	<b>2</b>
<b>3 CONTENTS.....</b>	<b>3</b>
<b>4 GENERAL INFORMATION .....</b>	<b>4</b>
4.1 CLIENT INFORMATION.....	4
4.2 GENERAL DESCRIPTION OF E.U.T.....	4
4.3 TECHNICAL SPECIFICATIONS.....	4
4.4 DESCRIPTION OF SUPPORT UNITS.....	4
4.5 TEST MODE.....	4
4.6 TEST LOCATION .....	5
4.7 TEST FACILITY .....	6
4.8 MEASUREMENT UNCERTAINTY .....	6
<b>5 EQUIPMENTS USED DURING TEST.....</b>	<b>7</b>
<b>6 TEST RESULTS .....</b>	<b>9</b>
6.1 E.U.T. TEST CONDITIONS .....	9
6.2 FREQUENCY HOPPING SYSTEM REQUIREMENT .....	9
6.3 ANTENNA REQUIREMENT.....	11
6.4 CONDUCTED EMISSIONS ON MAINS TERMINALS .....	12
6.5 20dB OCCUPIED BANDWIDTH.....	15
6.6 CONDUCTED PEAK OUTPUT POWER .....	18
6.7 CARRIER FREQUENCIES SEPARATED .....	21
6.8 HOPPING CHANNEL NUMBER.....	23
6.9 DWELL TIME .....	25
6.10 CONDUCTED SPURIOUS EMISSIONS AND BAND-EDGE .....	29
6.10.1 Conducted spurious emission.....	30
6.11 RADIATED SPURIOUS EMISSIONS AND BAND-EDGE.....	33
6.11.1 Radiated Spurious Emissions.....	36
6.11.2 Radiated Band edge .....	39
6.12 99% OCCUPIED BANDWIDTH.....	43
<b>7 TEST SETUP PHOTOGRAPHS.....</b>	<b>45</b>
<b>8 EUT CONSTRUCTIONAL DETAILS.....</b>	<b>45</b>

## 4 General Information

### 4.1 Client Information

Applicant:	Adam Hall GmbH
Address of Applicant:	Daimlerstrasse 9, 61267 Neu-Anspach, Germany
Manufacturer:	Adam Hall GmbH
Address of Manufacturer:	Daimlerstrasse 9, 61267 Neu-Anspach, Germany
Factory:	Speaker Electronic(Jia Shan) Co.,Ltd.
Address of Factory:	No.8 Development Zone Road, Huimin Sub-district, Jiashan County, Zhejiang, 314112, P.R. China

### 4.2 General Description of E.U.T.

Power supply:	AC100-120V/200-240V 50-60Hz Max600W
---------------	---

### 4.3 Technical Specifications

Operation Frequency:	2402MHz~2480MHz
Modulation Technique:	FHSS
Number of Channel:	79
Antenna Type	Integral Antenna
Antenna Gain	1.54dBi

### 4.4 Description of Support Units

The EUT has been tested with associated equipment below.

Description	Manufacturer	Model No.	Supplied by
Laptop	Lenovo	ThinkPad X100e	SGS
iPAD	Apple	/	iPAD

Software name	Manufacturer	Version	Supplied By
Blue Test	/	2.5.0	SGS

### 4.5 Test Mode

Test Mode	Description of Test Mode
Hopping disabled mode	Using test software to control EUT working in continuous transmitting, and select channel and modulation type.
Hopping enabled mode	Using test software to control EUT working in continuous transmitting, and hopping on status.

The packet type used for the final test:

Test Item	Packet Type			Hopping Status	
	DH1	DH3	DH5	Disabled	Enabled
CE	-	-	√	√	√
20dB OBW	-	-	√	√	-



Peak Power	-	-	√	√	-
CFS	-	-	√	-	√
HCN	-	-	√	-	√
Dwell Time	√	√	√	-	√
CSE	-	-	√	√	-
Conducted Band-edge	-	-	√	√	√
RSE & Band-edge	-	-	√	√	-
99% OBW	-	-	√	√	-

#### **4.6 Test Location**

All tests were performed at:

SGS-CSTC Standards Technical Services (Shanghai) Co., Ltd.

588 West Jindu Road, Xinqiao, Songjiang, 201612 Shanghai, China

Tel: +86 21 6191 5666

Fax: +86 21 6191 5678

#### 4.7 Test Facility

The test facility is recognized, certified, or accredited by the following organizations:

- **CNAS (No. CNAS L0599)**

CNAS has accredited SGS-CSTC Standards Technical Services (Shanghai) Co., Ltd. to ISO/IEC 17025:2005 General Requirements for the Competence of Testing and Calibration Laboratories (CNAS-CL01 Accreditation Criteria for the Competence of Testing and Calibration Laboratories) for the competence in the field of testing.

- **FCC – Registration No.: 402683**

SGS-CSTC Standards Technical Services (Shanghai) Co., Ltd. has been registered and fully described in a report filed with the Federal Communications Commission (FCC). The acceptance letter from the FCC is maintained in our files. Registration No.: 402683.

- **Industry Canada (IC) – IC Assigned Code: 8617A**

The 3m Semi-anechoic chamber of SGS-CSTC Standards Technical Services (Shanghai) Co., Ltd. has been registered by Certification and Engineering Bureau of Industry Canada for radio equipment testing with Registration No.: 8617A-1.

- **VCCI (Member No.: 3061)**

The 3m Semi-anechoic chamber and Shielded Room of SGS-CSTC Standards Technical Services (Shanghai) Co., Ltd. has been registered in accordance with the Regulations for Voluntary Control Measures with Registration No.: R-3868, C-4336, T-2221, G-830 respectively.

#### 4.8 Measurement Uncertainty

No.	Parameter	Measurement Uncertainty
1	Radio Frequency	$< \pm 1 \times 10^{-5}$
2	Total RF power, conducted	$< \pm 1.5$ dB
3	RF power density, conducted	$< \pm 3$ dB
4	Spurious emissions, conducted	$< \pm 3$ dB
5	All emissions, radiated	$< \pm 6$ dB (Below 1GHz) $< \pm 6$ dB (Above 1GHz)
6	Temperature	$< \pm 1^{\circ}\text{C}$
7	Humidity	$< \pm 5$ %
8	DC and low frequency voltages	$< \pm 3$ %

## 5 Equipments Used during Test

No.	Equipment	Manufacturer	Model No.	Inventory No.	Cal. Date	Cal. Due date
1	Power Meter	R&S	NRP	SHEM057-1	2016-01-14	2017-01-13
2	Power Meter Sensor	R&S	NRP-Z22	SHEM136-1	2016-08-12	2017-08-11
3	Spectrum Analyzer	R&S	FSP-30	SHEM002-1	2016-01-14	2017-01-13
4	EMI Receiver	R&S	ESU40	SHEM051-1	2016-01-16	2017-01-15
5	EMI Receiver	R&S	ESR7	SHEM162-1	2016-01-14	2017-01-13
6	LISN	SCHWARZBECK	NSLK8127	SHEM061-1	2016-01-14	2017-01-13
7	LISN	EMCO	3816/2	SHEM019-1	2016-01-14	2017-01-13
8	Loop Antenna (9kHz to 30MHz)	R&S	FMZB1519	SHEM135-1	2016-01-18	2017-01-17
9	Broadband Antenna (25MHz to 2GHz)	SCHWARZBECK	VULB9168	SHEM048-1	2016-01-16	2017-01-15
10	Broadband Antenna (25MHz to 3GHz)	R&S	HL562	SHEM010-1	2016-01-16	2017-01-15
11	Horn Antenna (1GHz to 18GHz)	R&S	HF906	SHEM009-1	2016-01-16	2017-01-15
12	Horn Antenna (1GHz to 18GHz)	SCHWARZBECK	BBHA9120D	SHEM050-1	2016-01-16	2017-01-15
13	Horn Antenna (14GHz to 40GHz)	SCHWARZBECK	BBHA 9170	SHEM049-1	2016-01-16	2017-01-15
14	Pre-amplifier (9KHz – 2GHz)	TESEQ	LNA6900	SHEM074-1	2016-01-14	2017-01-13
15	Pre-amplifier (1GHz – 26.5GHz)	SCHWARZBECK	F0118-G40-BZ4	SHEM049-2	2016-01-14	2017-01-13
16	Pre-amplifie (14GHz – 40GHz)	SCHWARZBECK	F1840-G35-BZ3	SHEM050-2	2016-01-14	2017-01-13
17	Low Pass Filter	Mini-Circuits	VLF-2500	SHEM114-1		
18	High Pass Filter	LORCH	5BRX-2400	SHEM155-1	/	/
19	High-low Temperature Cabinet	Suzhou Zhihe	TL-40	SHEM087-1	2016-08-15	2017-08-14
20	AC Power Stabilizer	WOCEN	6100	SHEM045-1	2016-01-14	2017-01-13



**SGS-CSTC Standards Technical Services  
(Shanghai) Co., Ltd.**

Report No.: SHEM161200793103

Page: 8 of 45

21	DC Power Supply	QJE	QJ30003SII	SHEM046-1	2016-01-14	2017-01-13
22	Signal Generator (Interferer)	R&S	SMR40	SHEM058-1	2016-08-12	2017-08-11
23	Signal Generator (Blocker)	R&S	SMJ100A	SHEM141-1	2016-01-14	2017-01-13
24	Splitter	ANRITSU CORP	MA1612A	SHEM159-1	/	/
25	Coupler	Mini-Circuits	803-S-1	SHEM113-1	/	/

This document is issued by the Company subject to its General Conditions of Service printed overleaf, available on request or accessible at [www.sgs.com/terms\\_and\\_conditions.htm](http://www.sgs.com/terms_and_conditions.htm) and, for electronic format documents, subject to Terms and Conditions for Electronic Documents at [www.sgs.com/terms\\_e-document.htm](http://www.sgs.com/terms_e-document.htm). Attention is drawn to the limitation of liability, indemnification and jurisdiction issues defined therein. Any holder of this document is advised that information contained hereon reflects the Company's findings at the time of its intervention only and within the limits of Client's instructions, if any. The Company's sole responsibility is to its Client and this document does not exonerate parties to a transaction from exercising all their rights and obligations under the transaction documents. This document cannot be reproduced except in full, without prior written approval of the Company. Any unauthorized alteration, forgery or falsification of the content or appearance of this document is unlawful and offenders may be prosecuted to the fullest extent of the law. Unless otherwise stated the results shown in this test report refer only to the sample(s) tested and such sample(s) are retained for 90 days only



## 6 Test Results

### 6.1 E.U.T. test conditions

**Requirements:** 15.31(e) For intentional radiators, measurements of the variation of the input power or the radiated signal level of the fundamental frequency component of the emission, as appropriate, shall be performed with the supply voltage varied between 85% and 115% of the nominal rated supply voltage. For battery operated equipment, the equipment tests shall be performed using a new battery.

<b>Operating Environment:</b>	Temperature:	20.0 -25.0 °C
	Humidity:	35-75 % RH
	Atmospheric Pressure:	99.2 -102 kPa

**Test frequencies:** According to the 15.31(m) Measurements on intentional radiators or receivers, other than TV broadcast receivers, shall be performed and, if required, reported for each band in which the device can be operated with the device operating at the number of frequencies in each band specified in the following table:

Frequency range over which device operates	Number of frequencies	Location in the range of operation
1 MHz or less	1	Middle
1 to 10 MHz	2	1 near top and 1 near bottom
More than 10 MHz	3	1 near top, 1 near middle and 1 near bottom

Pursuant to Part 15.31(c) For swept frequency equipment, measurements shall be made with the frequency sweep stopped at those frequencies chosen for the measurements to be reported.

Test frequency is the lowest channel: 0 channel (2402MHz), middle channel: 39 channel (2441MHz) and highest channel: 78 channel (2480MHz) with fixed at channel.

### 6.2 Frequency Hopping System Requirement

**Test Requirement: Section 15.247 (a)(1), (g), (h) requirement:**

The system shall hop to channel frequencies that are selected at the system hopping rate from a Pseudorandom ordered list of hopping frequencies. Each frequency must be used equally on the average by each transmitter. The system receivers shall have input bandwidths that match the hopping channel bandwidths of their corresponding transmitters and shall shift frequencies in synchronization with the transmitted signals.

Frequency hopping spread spectrum systems are not required to employ all available hopping channels during each transmission. However, the system, consisting of both the transmitter and the receiver, must be designed to comply with all of the regulations in this section should the transmitter be presented with a continuous data (or information) stream. In addition, a system employing short transmission bursts must comply with the definition of a frequency hopping system and must distribute its transmissions over the minimum number of hopping channels specified in this section.

The incorporation of intelligence within a frequency hopping spread spectrum system that permits the

system to recognize other users within the spectrum band so that it individually and independently chooses and adapts its hop sets to avoid hopping on occupied channels is permitted. The coordination of frequency hopping systems in any other manner for the express purpose of avoiding the simultaneous occupancy of individual hopping frequencies by multiple transmitters is not permitted.

**Compliance for section 15.247(a)(1)**

According to Bluetooth Core Specification, the pseudorandom sequence may be generated in a nine-stage shift register whose 5th and 9th stage outputs are added in a modulo-two addition stage. And the result is fed back to the input of the first stage. The sequence begins with the first ONE of 9 consecutive ONES; i.e. the shift register is initialized with nine ones.

- Number of shift register stages: 9
- Length of pseudo-random sequence:  $2^9 - 1 = 511$  bits
- Longest sequence of zeros: 8 (non-inverted signal)

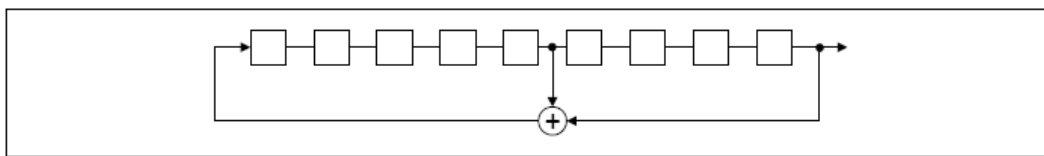

*Linear Feedback Shift Register for Generation of the PRBS sequence*

An example of Pseudorandom Frequency Hopping Sequence as follow:

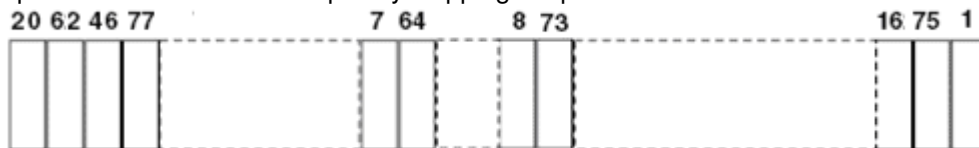

Each frequency used equally on the average by each transmitter.

According to Bluetooth Core Specification, Bluetooth receivers are designed to have input and IF bandwidths that match the hopping channel bandwidths of any Bluetooth transmitters and shift frequencies in synchronization with the transmitted signals.

**Compliance for section 15.247(g)**

According to Bluetooth Core Specification, the Bluetooth system transmits the packet with the pseudorandom hopping frequency with a continuous data and the short burst transmission from the Bluetooth system is also transmitted under the frequency hopping system with the pseudorandom hopping frequency system.

**Compliance for section 15.247(h)**

According to Bluetooth Core specification, the Bluetooth system incorporates with an adaptive system to detect other user within the spectrum band so that it individually and independently to avoid hopping on the occupied channels.

According to the Bluetooth Core specification, the Bluetooth system is designed not have the ability to coordinate with other FHSS System in an effort to avoid the simultaneous occupancy of individual hopping frequencies by multiple transmitter.

### 6.3 Antenna Requirement

**Standard requirement:**

15.203 requirement:

An intentional radiator shall be designed to ensure that no antenna other than that furnished by the responsible party shall be used with the device. The use of a permanently attached antenna or of an antenna that uses a unique coupling to the intentional radiator, the manufacturer may design the unit so that a broken antenna can be replaced by the user, but the use of a standard antenna jack or electrical connector is prohibited

15.247(b) (4) requirement:

The conducted output power limit specified in paragraph (b) of this section is based on the use of antennas with directional gains that do not exceed 6 dBi. Except as shown in paragraph (c) of this section, if transmitting antennas of directional gain greater than 6 dBi are used, the conducted output power from the intentional radiator shall be reduced below the stated values in paragraphs (b)(1), (b)(2), and (b)(3) of this section, as appropriate, by the amount in dB that the directional gain of the antenna exceeds 6 dBi.

**EUT Antenna:**

The BT antenna is integral antenna and no consideration of replacement. The gain of the antenna is less than 1.54 dBi.

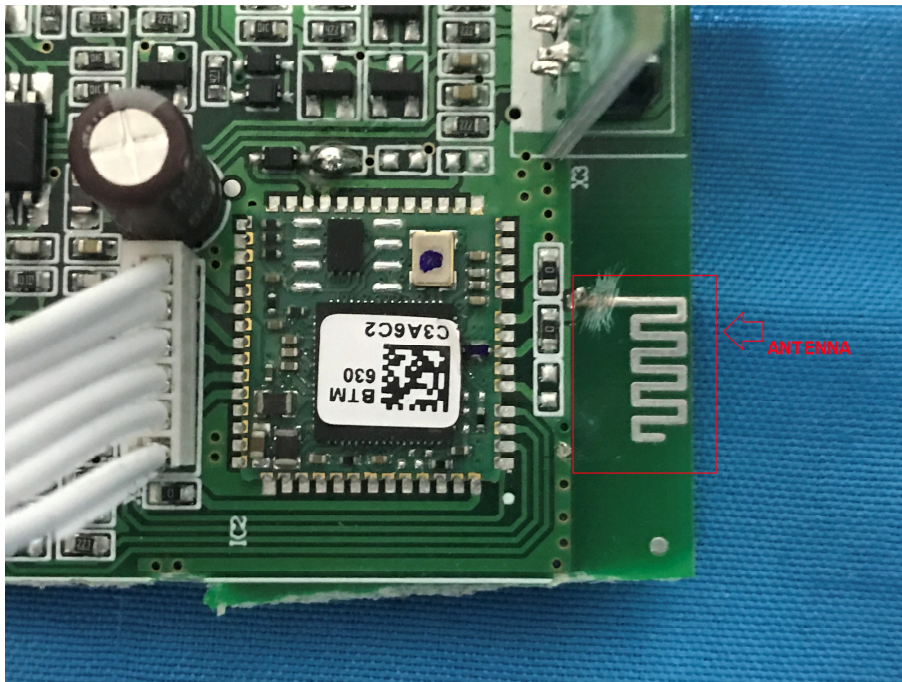

## 6.4 Conducted Emissions on Mains Terminals

**Frequency Range:** 150 KHz to 30 MHz

**Limit:**

Frequency range MHz	Class B Limits: dB (µV)	
	Quasi-peak	Average
0.15 to 0.50	66 to 56	56 to 46
0.50 to 5	56	46
5 to 30	60	50

Note1: The limit decreases linearly with the logarithm of the frequency in the range 0.15 MHz to 0.50MHz.

Note2: The lower limit is applicable at the transition frequency.

**Test Setup:**

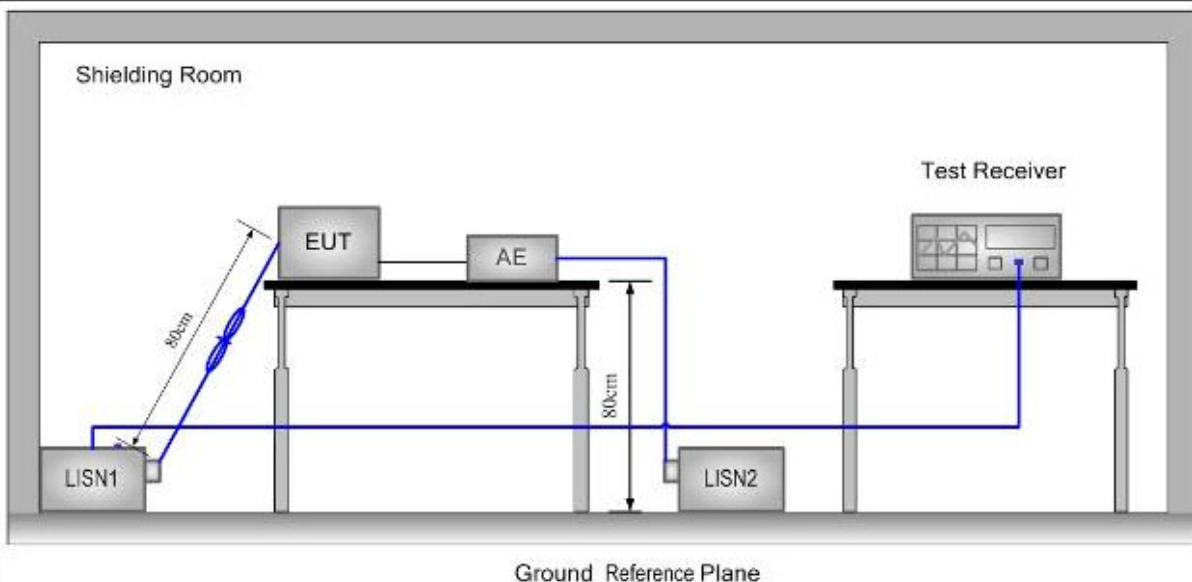

**Test Procedure:**

- 1) The mains terminal disturbance voltage was measured with the EUT in a shielded room.
- 2) The EUT was connected to AC power source through a LISN 1 (Line Impedance Stabilization Network) which provides  $50\Omega/50\mu\text{H} + 5\Omega$  linear impedance. The power cables of all other units of the EUT were connected to a second LISN, which was bonded to the ground reference plane in the same way as the LISN for the unit being measured. A multiple socket outlet strip was used to connect multiple power cables to a single LISN provided the rating of the LISN was not exceeded
- 3) The tabletop EUT was placed upon a non-metallic table 0.8m above the ground reference plane. And for floor-standing arrangement, the EUT was placed on the horizontal ground reference plane, but separated from metallic contact with the ground reference plane by 0.1m of insulation.
- 4) The test was performed with a vertical ground reference plane. The rear of the EUT shall be 0.4 m from the vertical ground reference plane. The vertical ground reference plane was bonded to the horizontal ground reference plane. The LISN was placed 0.8 m from the boundary of the unit under test and bonded to a ground reference plane for LISN mounted on top of the ground reference plane. This distance was between the closest points of the LISN and the EUT. The mains lead of EUT excess 0.8m was folded back and forth parallel to the lead so as to form a horizontal bundle with a length between 0.3m and 0.4m. All other units of the EUT and associated

equipment were at least 0.8 m from the LISN.

Remark: Pre-scan was performed with peak detected on all ports, Quasi-peak & average measurements were performed at the frequencies at which maximum peak emission level were detected. Pretest under all modes; choose the worst case mode (GFSK and Hopping enabled mode) record on the report. Please see the attached Quasi-peak and Average test results.

**Test Data:**

<b>Test Mode:</b> Hopping enabled mode	<b>Test Port:</b> AC Live Line
--	--------------------------------

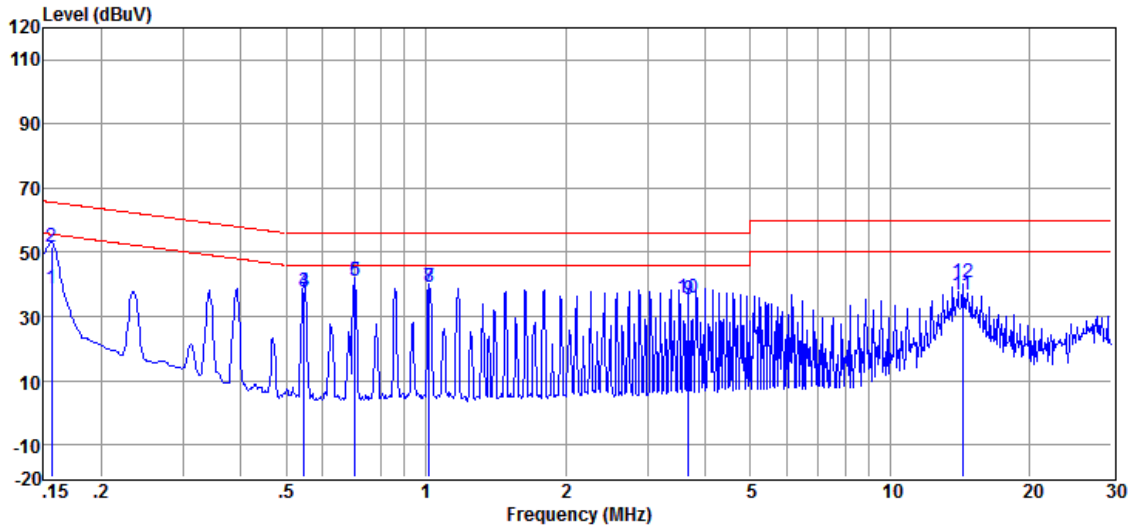

Item (Mark)	Freq (MHz)	Read Level (dBμV)	LISN Factor (dB)	Cable Loss (dB)	Level (dBμV)	Limit Line (dBμV)	Over Limit (dB)	Detector
1	0.156	28.69	0.06	10.15	38.90	55.65	-16.75	Average
2	0.156	41.63	0.06	10.15	51.84	65.65	-13.81	QP
3	0.546	27.64	0.10	10.17	37.91	46.00	-8.09	Average
4	0.546	27.64	0.10	10.17	37.91	56.00	-18.09	QP
5	0.705	30.77	0.10	10.17	41.04	46.00	-4.96	Average
6	0.705	30.68	0.10	10.17	40.95	56.00	-15.05	QP
7	1.016	28.96	0.08	10.18	39.22	46.00	-6.78	Average
8	1.016	29.05	0.08	10.18	39.31	56.00	-16.69	QP
9	3.681	25.12	0.13	10.21	35.46	46.00	-10.54	Average
10	3.681	25.56	0.13	10.21	35.90	56.00	-20.10	QP
11	14.336	26.10	0.22	10.27	36.59	50.00	-13.41	Average
12	14.336	30.12	0.22	10.27	40.61	60.00	-19.39	QP

This document is issued by the Company subject to its General Conditions of Service printed overleaf, available on request or accessible at [www.sgs.com/terms\\_and\\_conditions.htm](http://www.sgs.com/terms_and_conditions.htm) and, for electronic format documents, subject to Terms and Conditions for Electronic Documents at [www.sgs.com/terms\\_e-document.htm](http://www.sgs.com/terms_e-document.htm). Attention is drawn to the limitation of liability, indemnification and jurisdiction issues defined therein. Any holder of this document is advised that information contained hereon reflects the Company's findings at the time of its intervention only and within the limits of Client's instructions, if any. The Company's sole responsibility is to its Client and this document does not exonerate parties to a transaction from exercising all their rights and obligations under the transaction documents. This document cannot be reproduced except in full, without prior written approval of the Company. Any unauthorized alteration, forgery or falsification of the content or appearance of this document is unlawful and offenders may be prosecuted to the fullest extent of the law. Unless otherwise stated the results shown in this test report refer only to the sample(s) tested and such sample(s) are retained for 90 days only



<b>Test Mode:</b> Hopping enabled mode	<b>Test Port:</b> AC Neutral Line
--	-----------------------------------

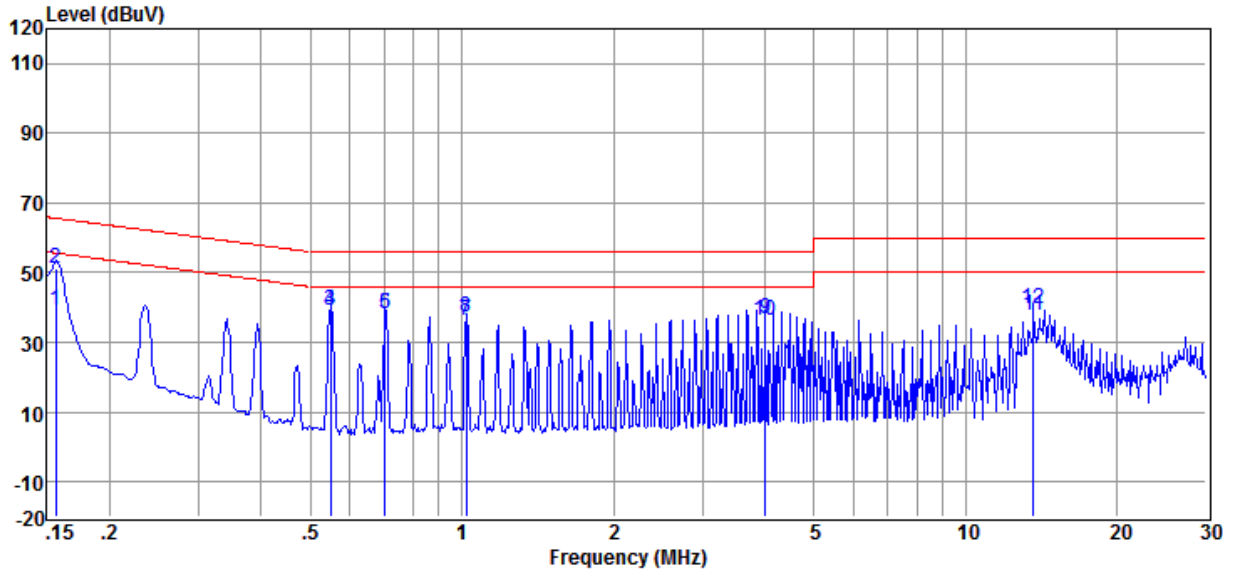

Item (Mark)	Freq (MHz)	Read Level (dBμV)	LISN Factor (dB)	Cable Loss (dB)	Level (dBμV)	Limit Line (dBμV)	Over Limit (dB)	Detector
1	0.156	28.99	0.05	10.15	39.19	55.65	-16.46	Average
2	0.156	40.91	0.05	10.15	51.11	65.65	-14.54	QP
3	0.549	28.80	0.04	10.17	39.01	46.00	-6.99	Average
4	0.549	28.80	0.04	10.17	39.01	56.00	-16.99	QP
5	0.705	27.91	0.05	10.17	38.13	46.00	-7.87	Average
6	0.705	27.97	0.05	10.17	38.19	56.00	-17.81	QP
7	1.021	26.16	0.05	10.18	36.39	46.00	-9.61	Average
8	1.021	27.09	0.05	10.18	37.32	56.00	-18.68	QP
9	4.006	26.59	0.15	10.22	36.96	46.00	-9.04	Average
10	4.006	26.15	0.15	10.22	36.52	56.00	-19.48	QP
11	13.623	27.07	0.25	10.26	37.58	50.00	-12.42	Average
12	13.623	29.22	0.25	10.26	39.73	60.00	-20.27	QP

Remark: Level = Read Level + LISN/ISN Factor + Cable Loss.

## 6.5 20dB Occupied Bandwidth

Test Configuration:

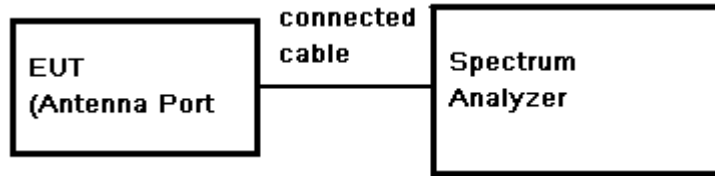

Test Procedure:

- 1) Remove the antenna from the EUT and then connect a low RF cable from the antenna port to the spectrum;
- 2) Set the spectrum analyzer: Span = approximately 2 to 5 times the OBW, centred on the hopping channel;
- 3) Set the spectrum analyzer: RBW  $\geq$  1% to 5% of the OBW (set 30 kHz). VBW  $\geq$  RBW. Sweep = Auto; Detector = Peak. Trace = Max Hold.
- 4) Mark the peak frequency and -20dB points.

Test Date:

Test Frequency(MHz)	Bandwidth(MHz)
2402	1.045
2441	1.048
2480	1.048

**Test plot as follows:**

Test mode channel: 2402

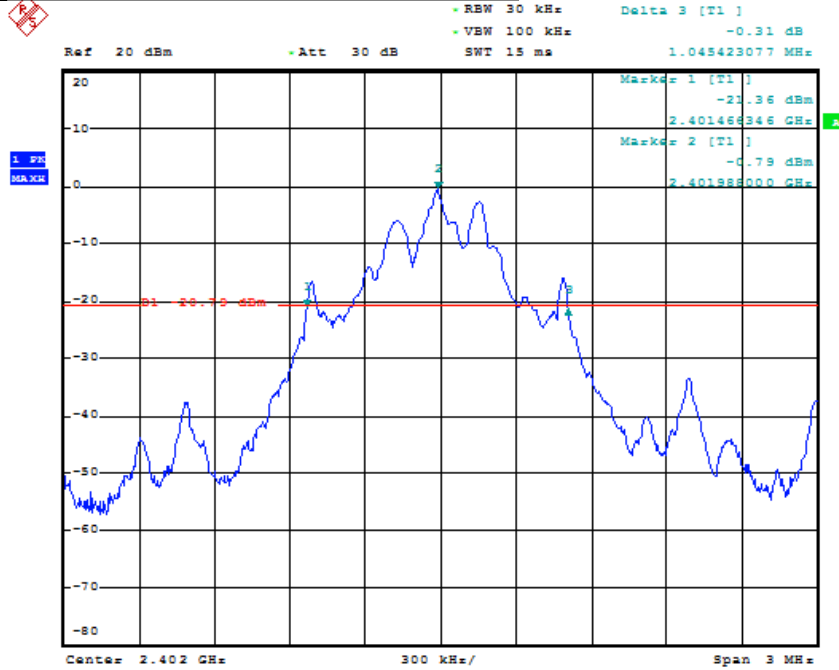

Test mode channel: 2441

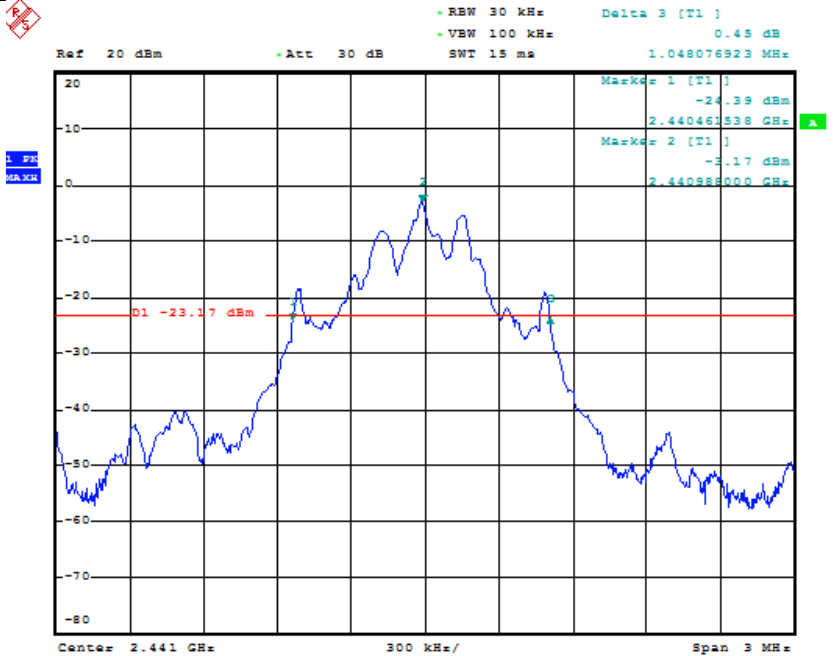





Test mode channel: 2480

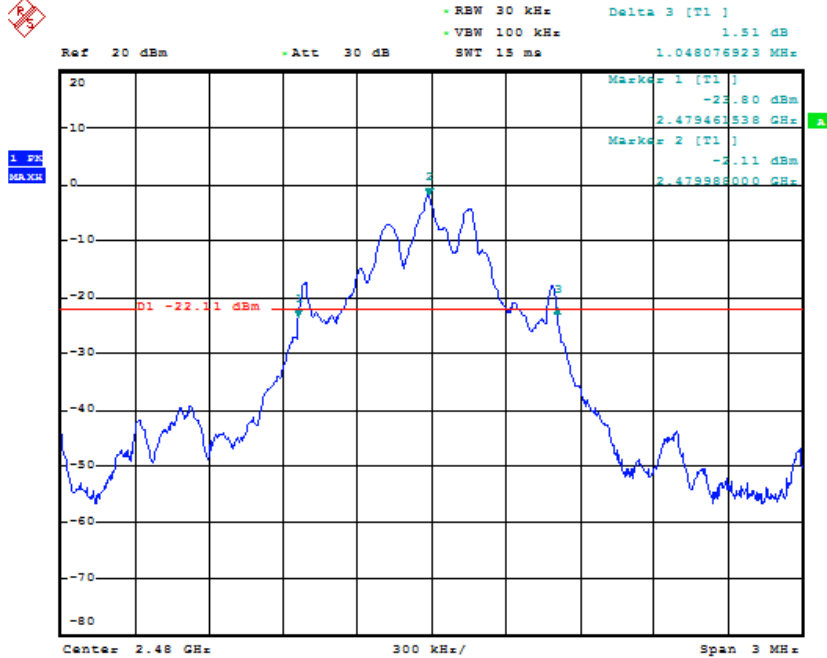

This document is issued by the Company subject to its General Conditions of Service printed overleaf, available on request or accessible at [www.sgs.com/terms\\_and\\_conditions.htm](http://www.sgs.com/terms_and_conditions.htm) and, for electronic format documents, subject to Terms and Conditions for Electronic Documents at [www.sgs.com/terms\\_e-document.htm](http://www.sgs.com/terms_e-document.htm). Attention is drawn to the limitation of liability, indemnification and jurisdiction issues defined therein. Any holder of this document is advised that information contained hereon reflects the Company's findings at the time of its intervention only and within the limits of Client's instructions, if any. The Company's sole responsibility is to its Client and this document does not exonerate parties to a transaction from exercising all their rights and obligations under the transaction documents. This document cannot be reproduced except in full, without prior written approval of the Company. Any unauthorized alteration, forgery or falsification of the content or appearance of this document is unlawful and offenders may be prosecuted to the fullest extent of the law. Unless otherwise stated the results shown in this test report refer only to the sample(s) tested and such sample(s) are retained for 90 days only

## 6.6 Conducted Peak Output Power

**Test Configuration:**

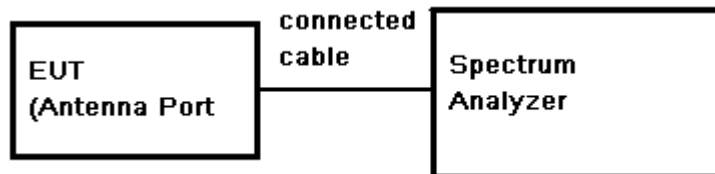

**Test Procedure:**

- 1) Remove the antenna from the EUT and then connect a low RF cable from the antenna port to the spectrum.
- 2) Set the spectrum analyzer: RBW = 3 MHz, VBW = 10 MHz, Sweep = auto; Detector Function = Peak.
- 3) Keep the EUT in transmitting at lowest, middle and highest channel individually. Record the max value.

**Test Limit:**

Regulation 15.247 (b)(1) For frequency hopping systems operating in the 2400-2483.5 MHz band employing at least 75 non-overlapping hopping channels, and all frequency hopping systems in the 5725-5850 MHz band: 1 watt. For all other frequency hopping systems in the 2400-2483.5 MHz band: 0.125 watts. Refer to the result "Hopping channel number" of this document. The 1 watt (30.0dBm) limit applies.

**Test Data:**

Test Frequency (MHz)	Reading Power (dBm)	Cable Loss (dB)	Output Power (dBm)	Limit (dBm)	Test Result
2402	-0.14	0.5	0.36	21	Pass
2441	-0.23		0.27		Pass
2480	-0.13		0.37		Pass

Remark: Output Power=Reading Power + Cable loss

**Test plot as follows:**

Test mode	channel: 2402
-----------	---------------

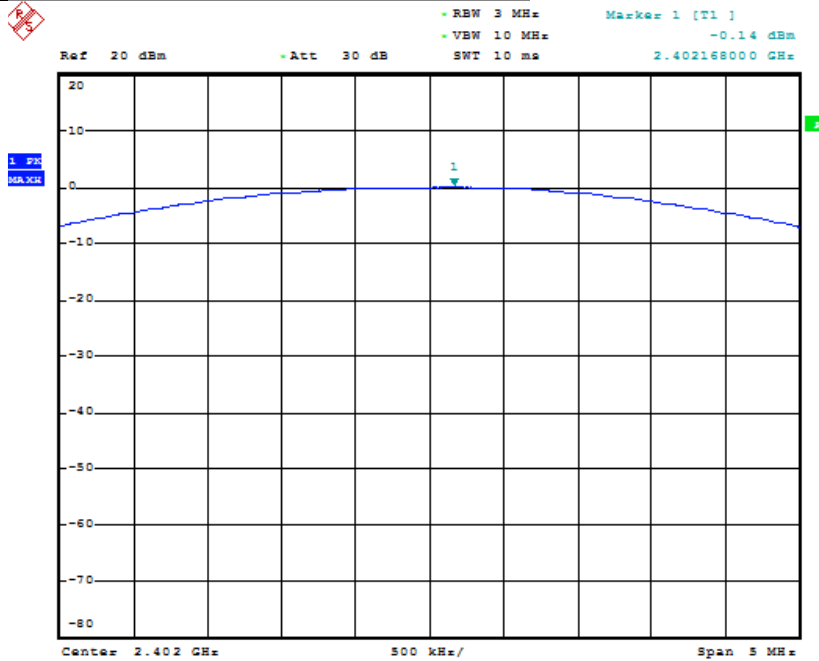

Test mode	channel: 2441
-----------	---------------

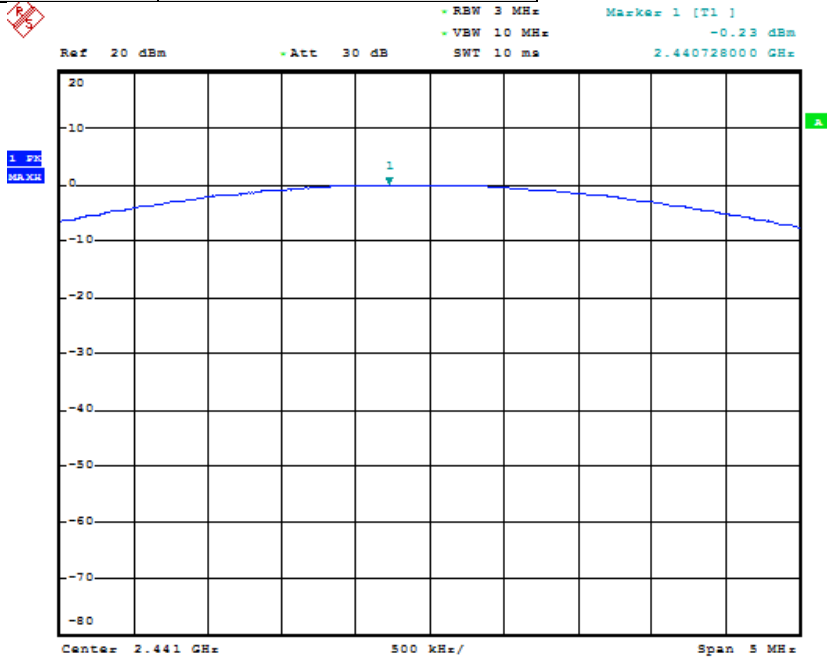



Test mode channel: 2480



RBW 3 MHz  
VBW 10 MHz  
SWT 10 ms  
Marker 1 [T1] -0.13 dBm  
2.479776000 GHz

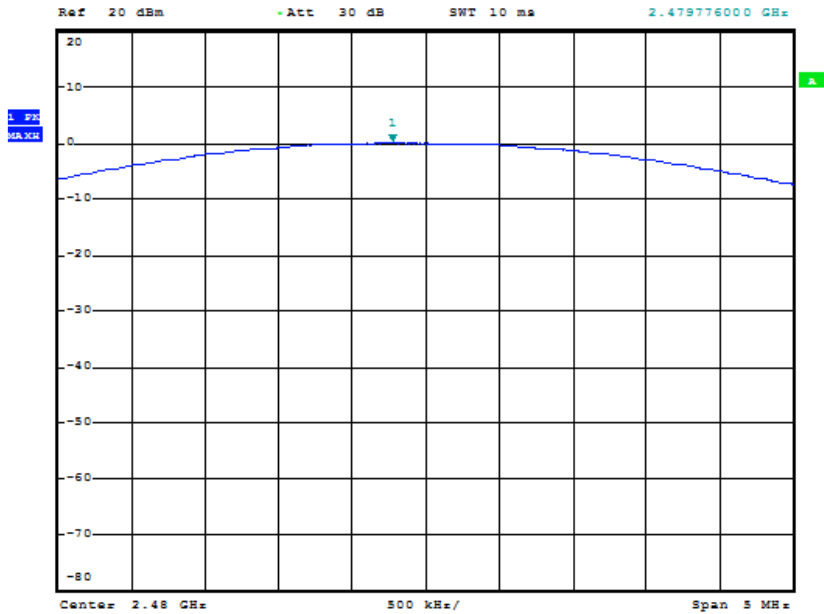

This document is issued by the Company subject to its General Conditions of Service printed overleaf, available on request or accessible at [www.sgs.com/terms\\_and\\_conditions.htm](http://www.sgs.com/terms_and_conditions.htm) and, for electronic format documents, subject to Terms and Conditions for Electronic Documents at [www.sgs.com/terms\\_e-document.htm](http://www.sgs.com/terms_e-document.htm). Attention is drawn to the limitation of liability, indemnification and jurisdiction issues defined therein. Any holder of this document is advised that information contained hereon reflects the Company's findings at the time of its intervention only and within the limits of Client's instructions, if any. The Company's sole responsibility is to its Client and this document does not exonerate parties to a transaction from exercising all their rights and obligations under the transaction documents. This document cannot be reproduced except in full, without prior written approval of the Company. Any unauthorized alteration, forgery or falsification of the content or appearance of this document is unlawful and offenders may be prosecuted to the fullest extent of the law. Unless otherwise stated the results shown in this test report refer only to the sample(s) tested and such sample(s) are retained for 90 days only

## 6.7 Carrier Frequencies Separated

**Test Configuration:**

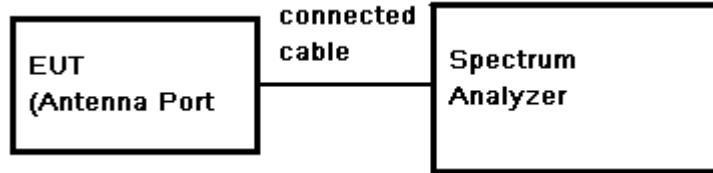

**Test Procedure:**

- 1) Remove the antenna from the EUT and then connect a low RF cable from the antenna port to the spectrum.
- 2) Set the spectrum analyzer: RBW  $\geq$  1% of the span (set 30 kHz). VBW  $\geq$  RBW, Span = 3MHz. Sweep = auto; Detector Function = Peak. Trace = Maxhold.
- 3) Allow the trace to stabilize. Use the marker-delta function to determine the separation between the peaks of the adjacent channels. The limit is specified in one of the subparagraphs of this Section. Submit this plot.

**Limit:**

0.025MHz or 2/3 of the 20dB bandwidth (whichever is greater)

**Test data:**

Test Channel	Carrier Frequencies Separated (MHz)	Limit	Test Result
Middle Channels (Channel 39 & 40)	0.9909	699kHz	Pass

- Remark: 1. According to the section 6.6, the conducted power measured is less than 125mW and 2/3 of 20dB bandwidth is used for limit.  
2. 20dB bandwidth reference Section 6.5



Test plot as follows:

Test mode	channel: Channel 39 & 40
-----------	--------------------------

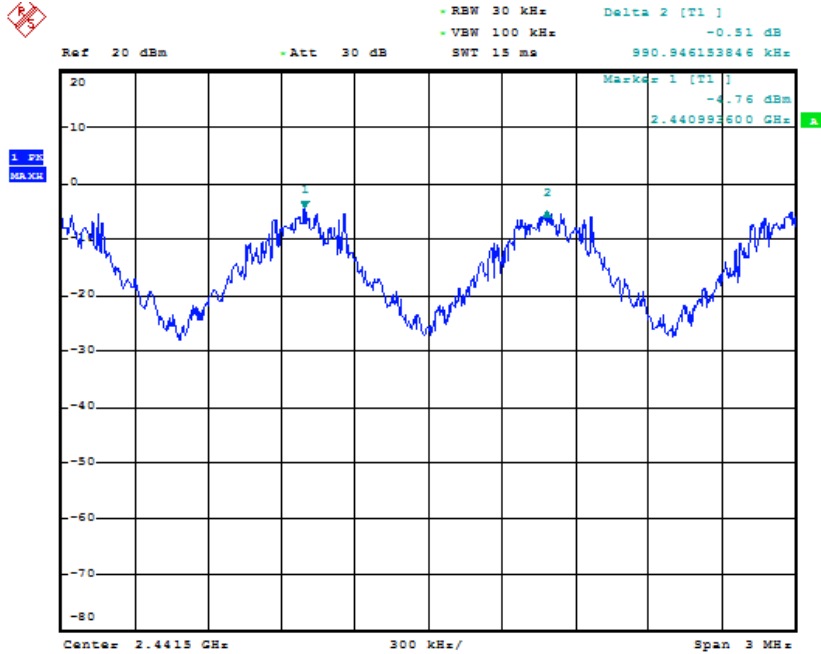

This document is issued by the Company subject to its General Conditions of Service printed overleaf, available on request or accessible at [www.sgs.com/terms\\_and\\_conditions.htm](http://www.sgs.com/terms_and_conditions.htm) and, for electronic format documents, subject to Terms and Conditions for Electronic Documents at [www.sgs.com/terms\\_e-document.htm](http://www.sgs.com/terms_e-document.htm). Attention is drawn to the limitation of liability, indemnification and jurisdiction issues defined therein. Any holder of this document is advised that information contained hereon reflects the Company's findings at the time of its intervention only and within the limits of Client's instructions, if any. The Company's sole responsibility is to its Client and this document does not exonerate parties to a transaction from exercising all their rights and obligations under the transaction documents. This document cannot be reproduced except in full, without prior written approval of the Company. Any unauthorized alteration, forgery or falsification of the content or appearance of this document is unlawful and offenders may be prosecuted to the fullest extent of the law. Unless otherwise stated the results shown in this test report refer only to the sample(s) tested and such sample(s) are retained for 90 days only

## 6.8 Hopping Channel Number

**Test Configuration:**

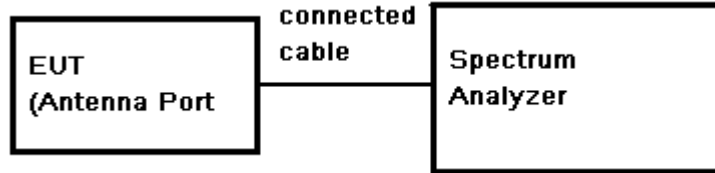

**Test Procedure:**

- 1) Remove the antenna from the EUT and then connect a low RF cable from the antenna port to the spectrum.
- 2) Set the spectrum analyzer: RBW = 300 kHz. VBW = 300 kHz. Sweep = auto; Detector Function = Peak. Trace = Max hold.
- 3) Allow the trace to stabilize. It may prove necessary to break the span up to sections. in order to clearly show all of the hopping frequencies. The limit is specified in one of the subparagraphs of this Section.
- 4) Set the spectrum analyzer: start frequency = 2400MHz. stop frequency = 2483.5MHz. Submit the test result graph.

**Limit:**

At least 15 channels

**Test Data:**

Hopping channel numbers	Limit	Test Result
79	≥15	Pass

Test plot as follows:

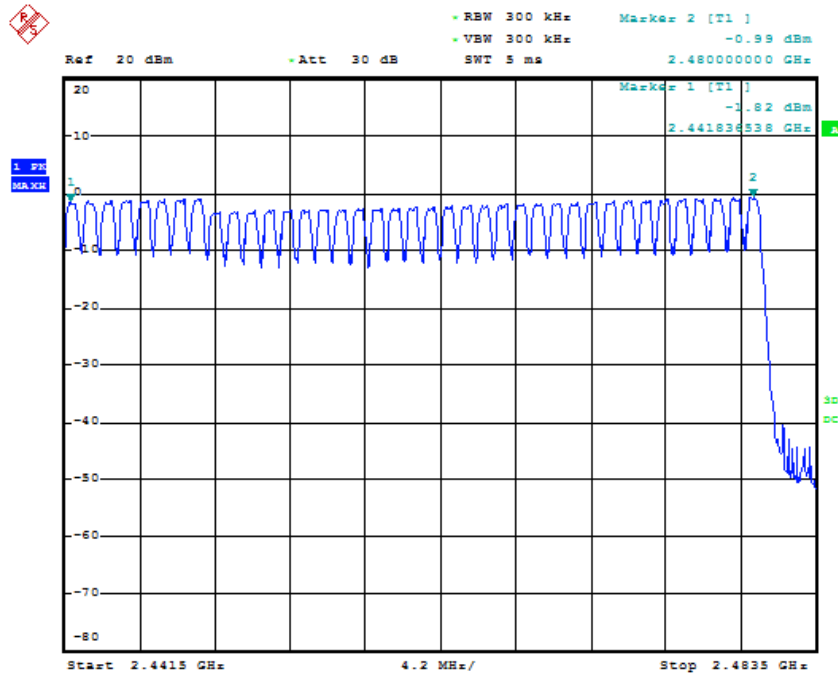
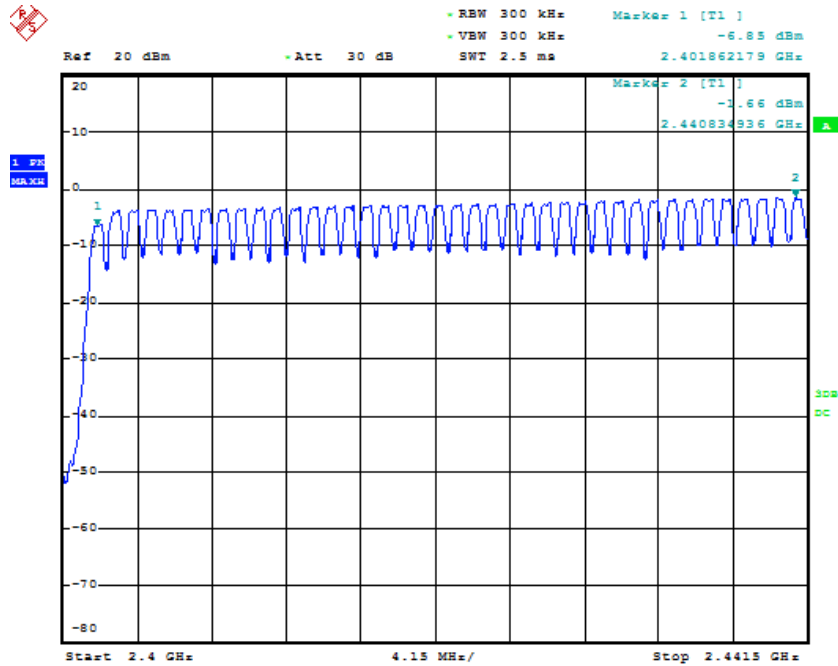



## 6.9 Dwell Time

**Test Configuration:**

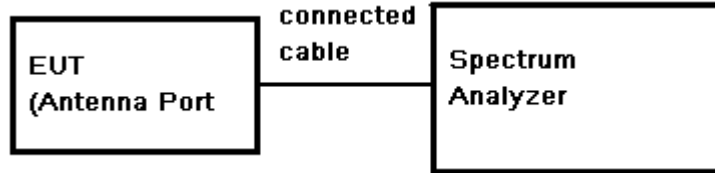

**Test Procedure:**

- 1) Remove the antenna from the EUT and then connect a low RF cable from the antenna port to the spectrum. Keep EUT in Hopping transmitting with all kind of modulation.
- 2) Set spectrum analyzer span = 0. centered on a hopping channel;
- 3) Use Emission width \* No. of Hopping Channels in 31.6s to determine the dwell time.

**Limit:**

Regulation 15.247(a)(1)(iii) Frequency hopping systems in the 2400-2483.5 MHz band shall use at least 15 channels. The average time of occupancy on any channel shall not be greater than 0.4 seconds within a period of 0.4 seconds multiplied by the number of hopping channels employed. Frequency hopping systems may avoid or suppress transmissions on a particular hopping frequency provided that a minimum of 15 channels are used.

**Test Data:**

Test Frequency	Packet	Emission Width (ms)	Number of Hopping Channel in 31.6s	Average Occupancy Time (s)	Limit(s)	Test Result
2441	DH1	0.399	320	0.127	0.4	Pass
	DH3	1.673	160	0.267		Pass
	DH5	2.901	110	0.319		Pass

**Test plot as follows:**

Test mode:DH1	channel:2441
---------------	--------------

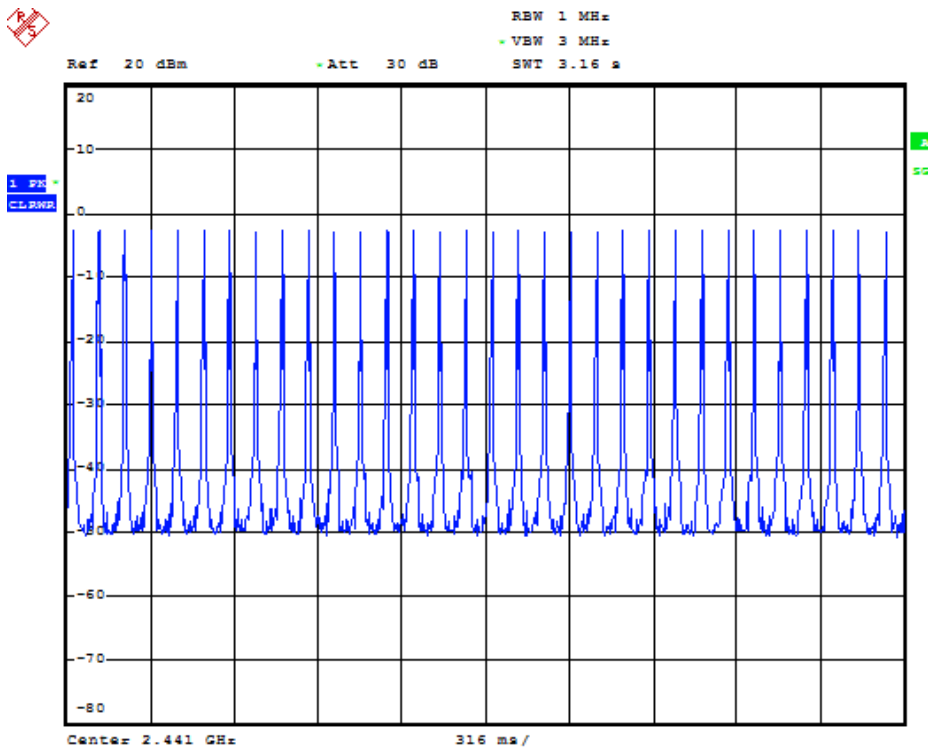
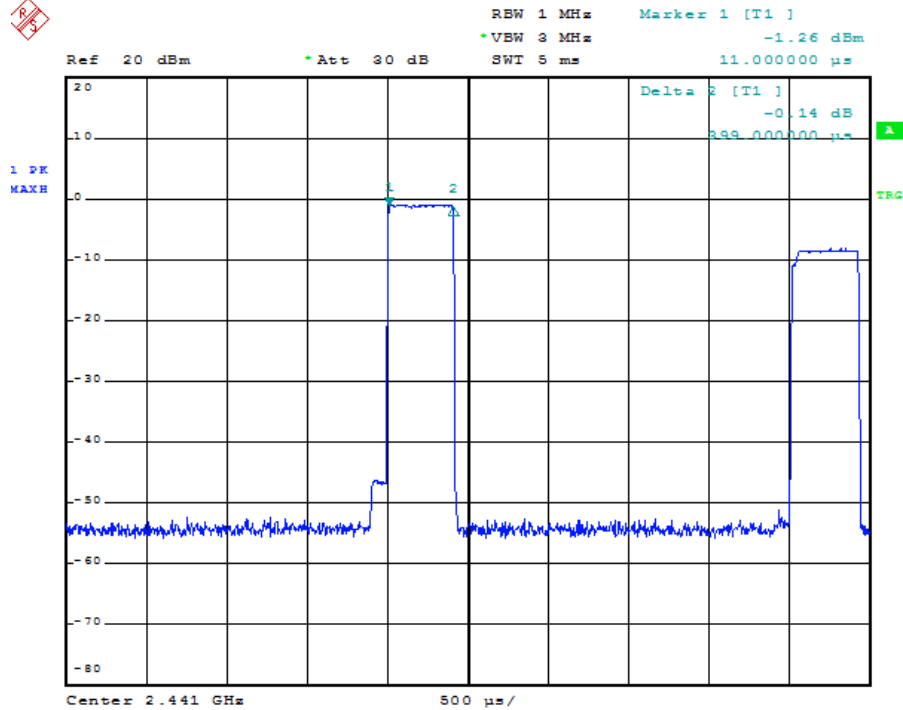

This document is issued by the Company subject to its General Conditions of Service printed overleaf, available on request or accessible at [www.sgs.com/terms\\_and\\_conditions.htm](http://www.sgs.com/terms_and_conditions.htm) and, for electronic format documents, subject to Terms and Conditions for Electronic Documents at [www.sgs.com/terms\\_e-document.htm](http://www.sgs.com/terms_e-document.htm). Attention is drawn to the limitation of liability, indemnification and jurisdiction issues defined therein. Any holder of this document is advised that information contained hereon reflects the Company's findings at the time of its intervention only and within the limits of Client's instructions, if any. The Company's sole responsibility is to its Client and this document does not exonerate parties to a transaction from exercising all their rights and obligations under the transaction documents. This document cannot be reproduced except in full, without prior written approval of the Company. Any unauthorized alteration, forgery or falsification of the content or appearance of this document is unlawful and offenders may be prosecuted to the fullest extent of the law. Unless otherwise stated the results shown in this test report refer only to the sample(s) tested and such sample(s) are retained for 90 days only



Test mode:DH3 channel:2441

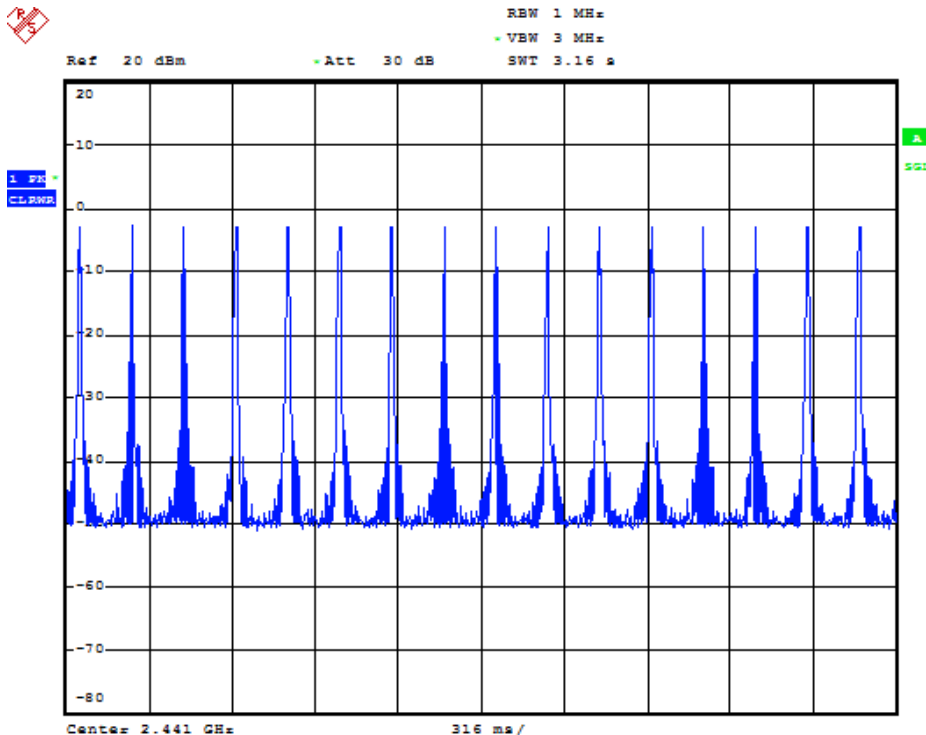
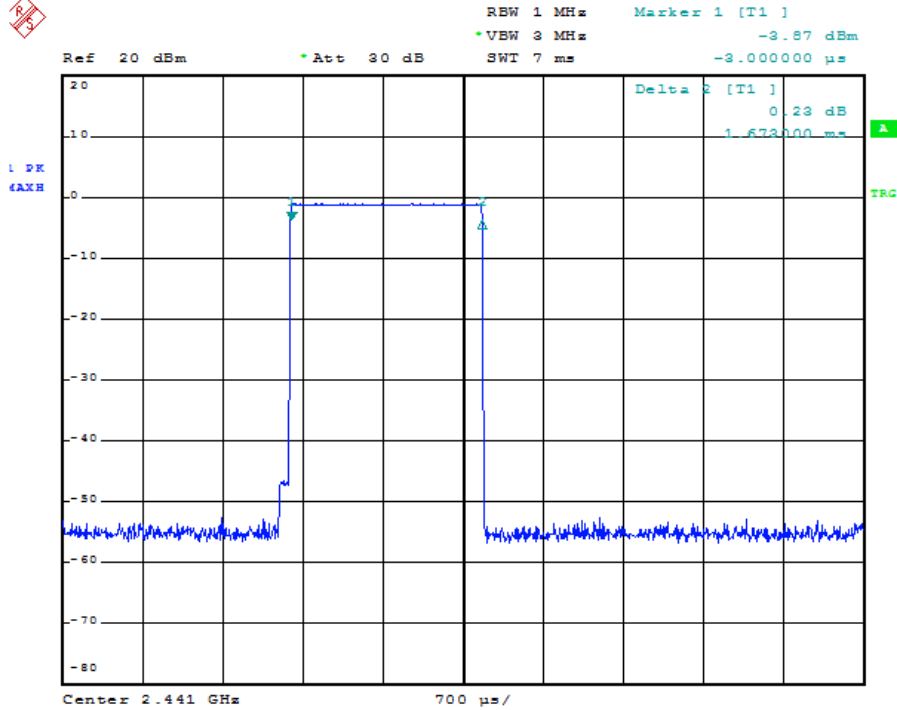

This document is issued by the Company subject to its General Conditions of Service printed overleaf, available on request or accessible at [www.sgs.com/terms\\_and\\_conditions.htm](http://www.sgs.com/terms_and_conditions.htm) and, for electronic format documents, subject to Terms and Conditions for Electronic Documents at [www.sgs.com/terms\\_e-document.htm](http://www.sgs.com/terms_e-document.htm). Attention is drawn to the limitation of liability, indemnification and jurisdiction issues defined therein. Any holder of this document is advised that information contained hereon reflects the Company's findings at the time of its intervention only and within the limits of Client's instructions, if any. The Company's sole responsibility is to its Client and this document does not exonerate parties to a transaction from exercising all their rights and obligations under the transaction documents. This document cannot be reproduced except in full, without prior written approval of the Company. Any unauthorized alteration, forgery or falsification of the content or appearance of this document is unlawful and offenders may be prosecuted to the fullest extent of the law. Unless otherwise stated the results shown in this test report refer only to the sample(s) tested and such sample(s) are retained for 90 days only

Test mode:DH5      channel:2441

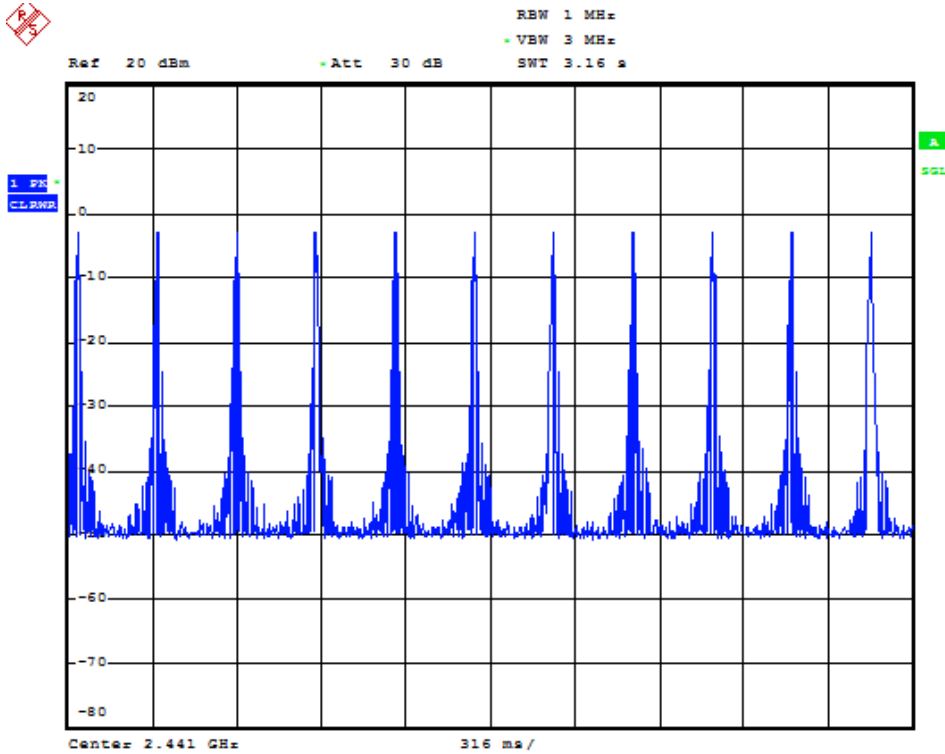
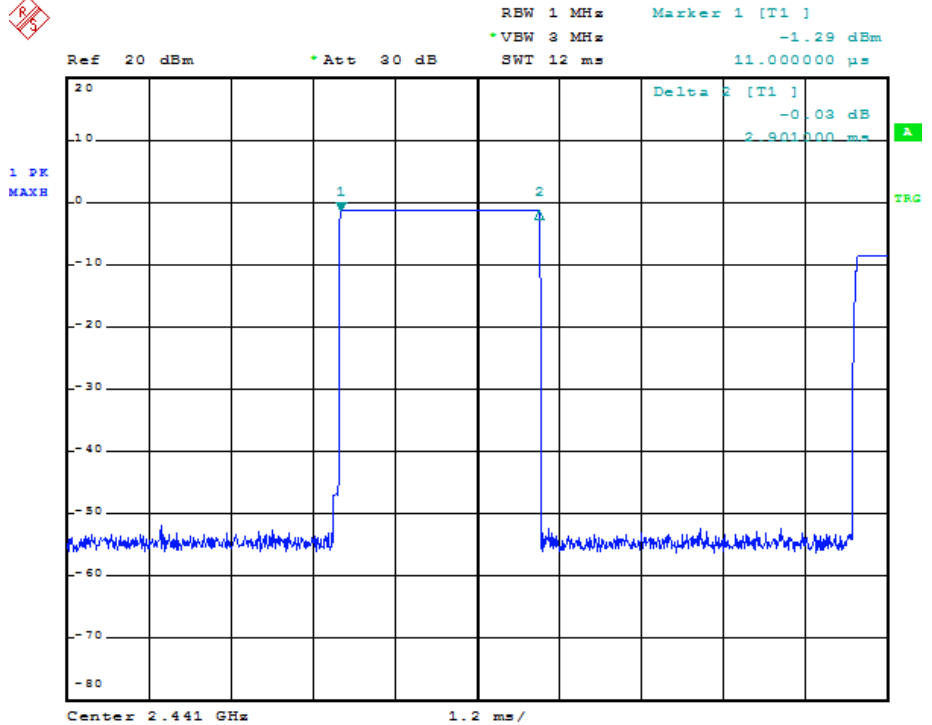

This document is issued by the Company subject to its General Conditions of Service printed overleaf, available on request or accessible at [www.sgs.com/terms\\_and\\_conditions.htm](http://www.sgs.com/terms_and_conditions.htm) and, for electronic format documents, subject to Terms and Conditions for Electronic Documents at [www.sgs.com/terms\\_e-document.htm](http://www.sgs.com/terms_e-document.htm). Attention is drawn to the limitation of liability, indemnification and jurisdiction issues defined therein. Any holder of this document is advised that information contained hereon reflects the Company's findings at the time of its intervention only and within the limits of Client's instructions, if any. The Company's sole responsibility is to its Client and this document does not exonerate parties to a transaction from exercising all their rights and obligations under the transaction documents. This document cannot be reproduced except in full, without prior written approval of the Company. Any unauthorized alteration, forgery or falsification of the content or appearance of this document is unlawful and offenders may be prosecuted to the fullest extent of the law. Unless otherwise stated the results shown in this test report refer only to the sample(s) tested and such sample(s) are retained for 90 days only

## 6.10 Conducted Spurious Emissions and Band-edge

**Test Configuration:**

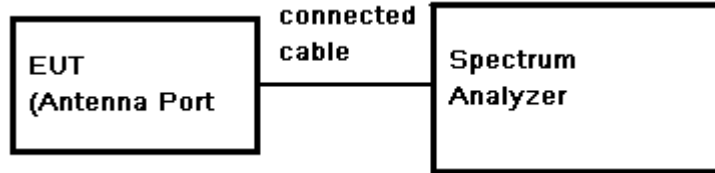

**Test Procedure:**

1. Remove the antenna from the EUT and then connect a low RF cable from the antenna port to the spectrum.
2. Set the spectrum analyzer: RBW = 100KHz. VBW >= RBW. Sweep = auto; Detector Function = Peak (Max. hold).

**Limit:**

(d) In any 100 kHz bandwidth outside the frequency band in which the spread spectrum or digitally modulated intentional radiator is operating. The radio frequency power that is produced by the intentional radiator shall be at least 20 dB below that in the 100 kHz bandwidth within the band that contains the highest level of the desired power. Based on either an RF conducted or a radiated measurement. Provided the transmitter demonstrates compliance with the peak conducted power limits.

**Test Result:**

Pass

### 6.10.1 Conducted spurious emission

Test plot as follows:

Test mode	channel: 2402
-----------	---------------

30MHz-3GHz:

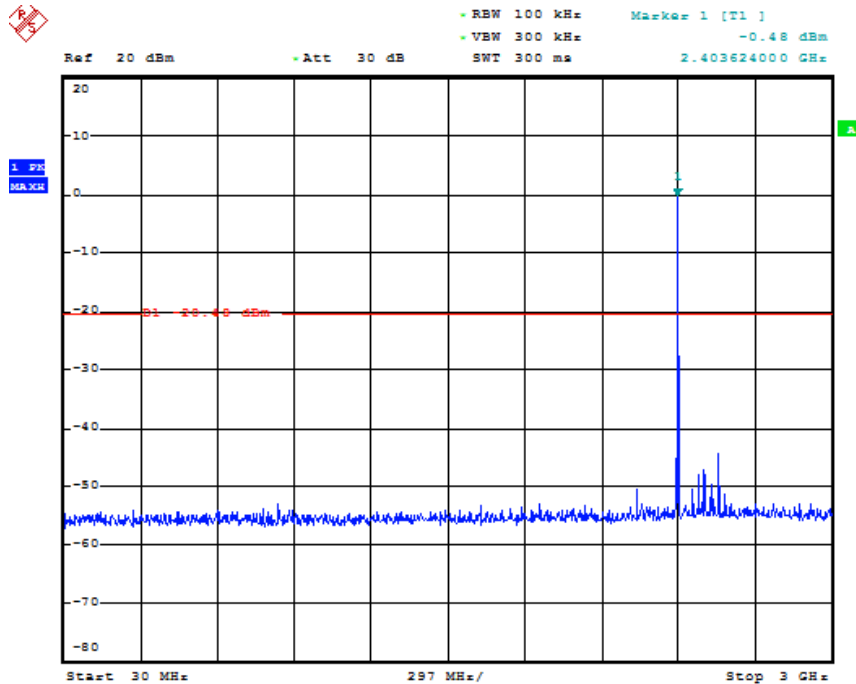

3GHz-25GHz:

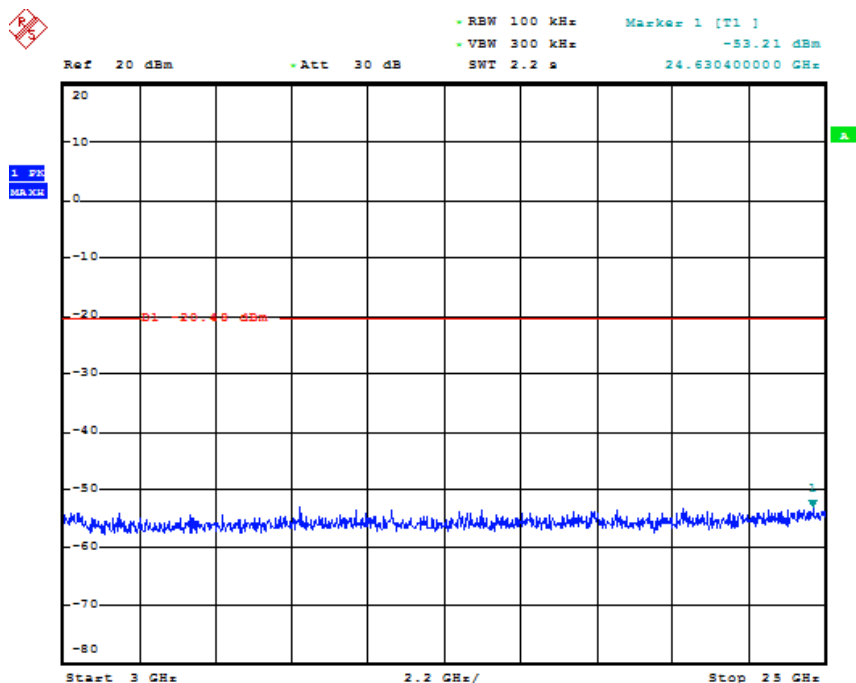

Test mode channel: 2441

30MHz-3GHz:

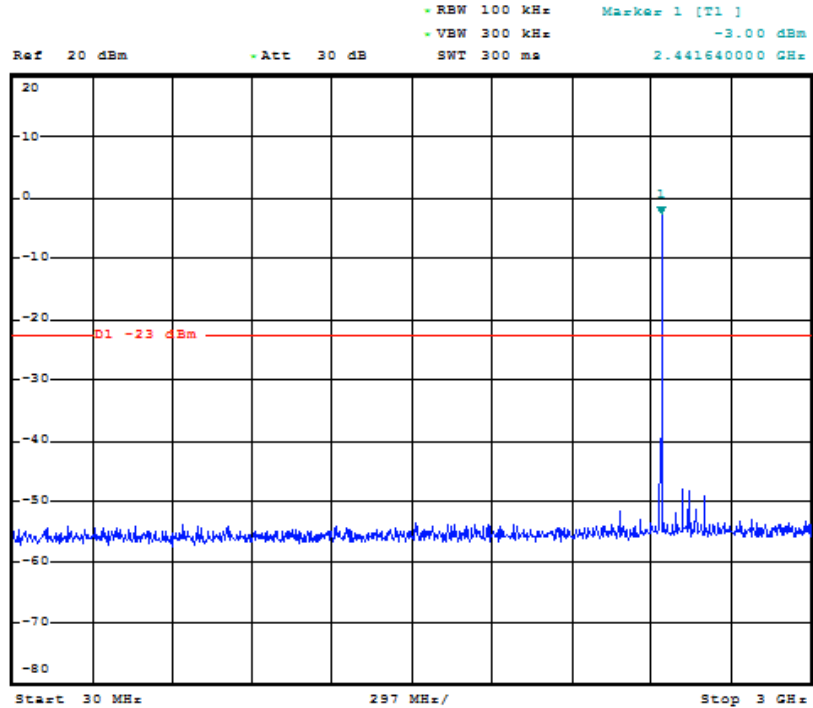

3GHz-25GHz:

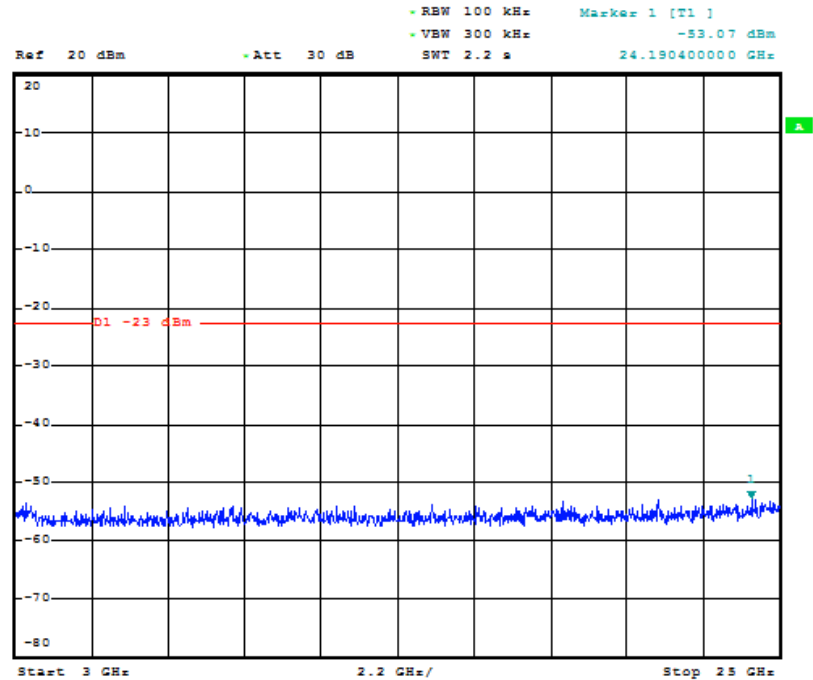

Test mode channel: 2480

30MHz-3GHz:

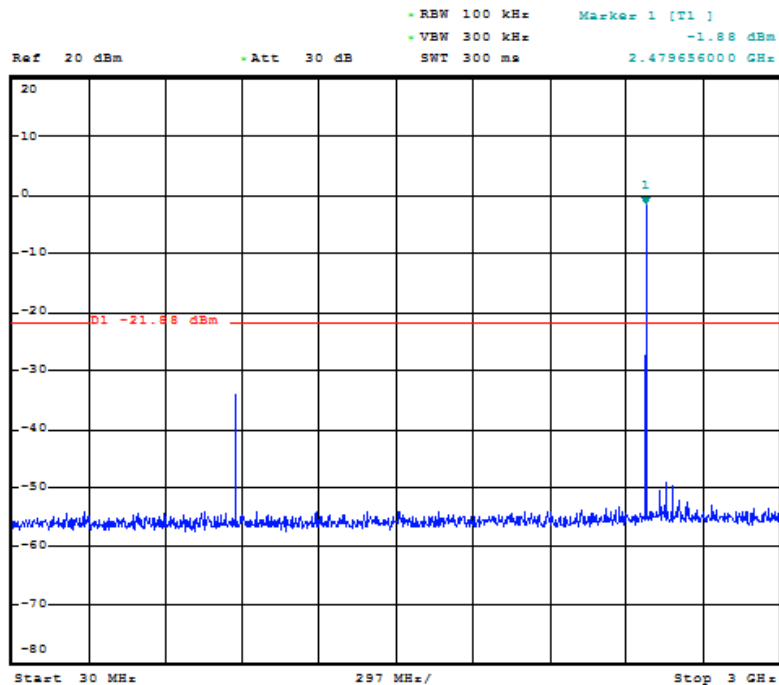

3GHz-25GHz:

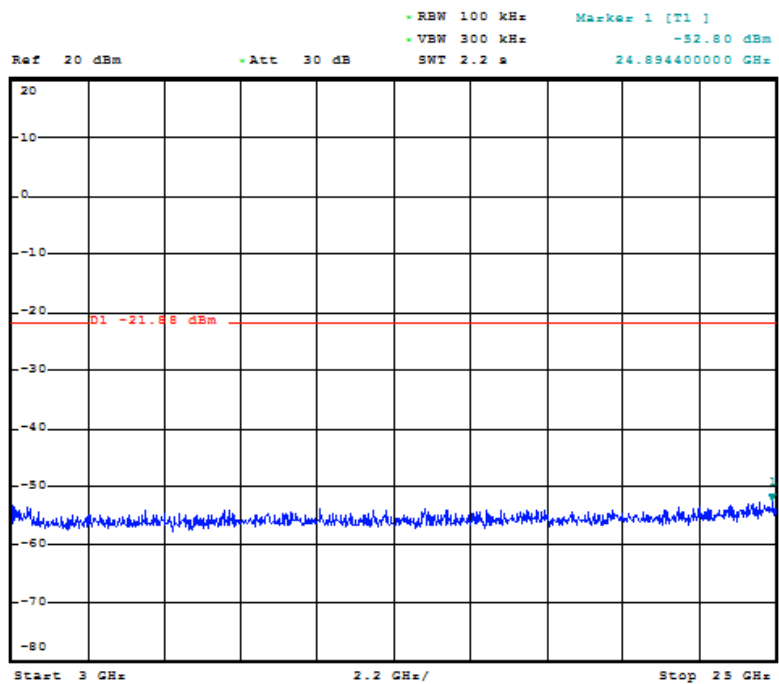



### 6.11 Radiated Spurious Emissions and Band-edge

**Frequency Range:** 9KHz to 25GHz

**Test site/setup:** Measurement Distance: 3m (Semi-Anechoic Chamber)

Test instrumentation set-up:

Frequency Range	Detector	RBW	VBW
0.009MHz-0.090MHz	Peak	10kHz	30kHz
0.009MHz-0.090MHz	Average	10kHz	30kHz
0.090MHz-0.110MHz	Quasi-peak	10kHz	30kHz
0.110MHz-0.490MHz	Peak	10kHz	30kHz
0.110MHz-0.490MHz	Average	10kHz	30kHz
0.490MHz -30MHz	Quasi-peak	10kHz	30kHz
30MHz-1GHz	Quasi-peak	100kHz	300kHz
Above 1GHz	Peak	RBW=1MHz	VBW≥RBW
	Average		VBW=10Hz

Sweep=Auto

**15.209 Limit:**

Frequency	Limit (dBuV/m)
0.009MHz-0.490MHz	128.5 ~ 93.8
0.490MHz-1.705MHz	73.8 ~63.0
1.705MHz-30MHz	69.5
30MHz-88MHz	40.0
88MHz-216MHz	43.5
216MHz-960MHz	46.0
960MHz-1GHz	54.0
Above 1GHz	54.0

Note: 15.35(b), Unless otherwise specified, the limit on peak radio frequency emissions is 20dB above the maximum permitted average emission limit applicable to the equipment under test. This peak limit applies to the total peak emission level radiated by the device.

**Test Configuration:** Receive antenna scan height 1 m - 4 m. polarization Vertical / Horizontal

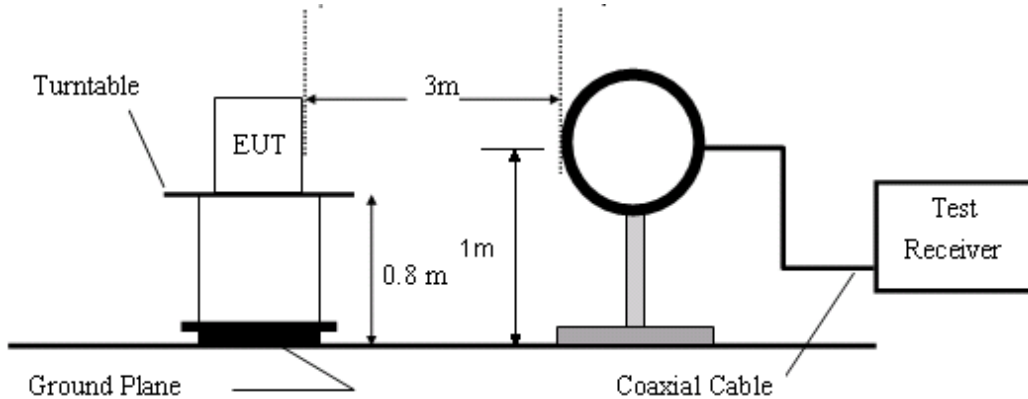

**Figure1. Below 30MHz radiated emissions test configuration**

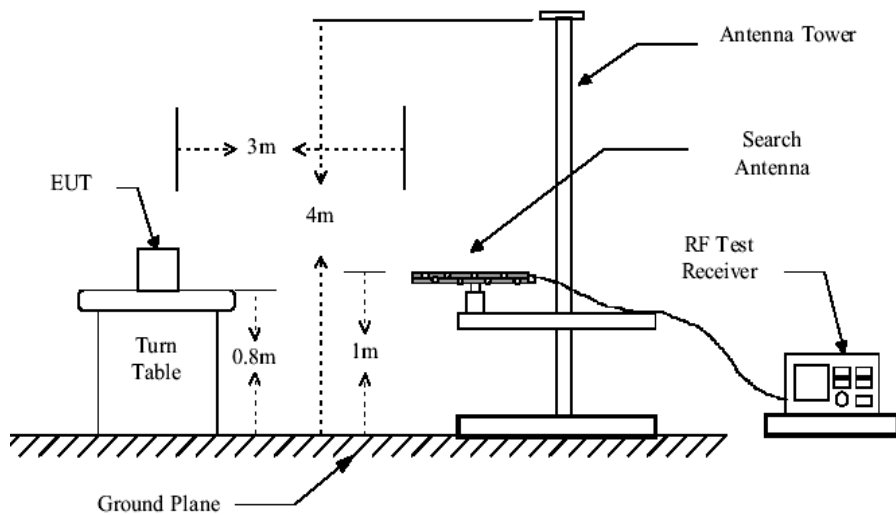

**Figure2. 30MHz to 1GHz radiated emissions test configuration**

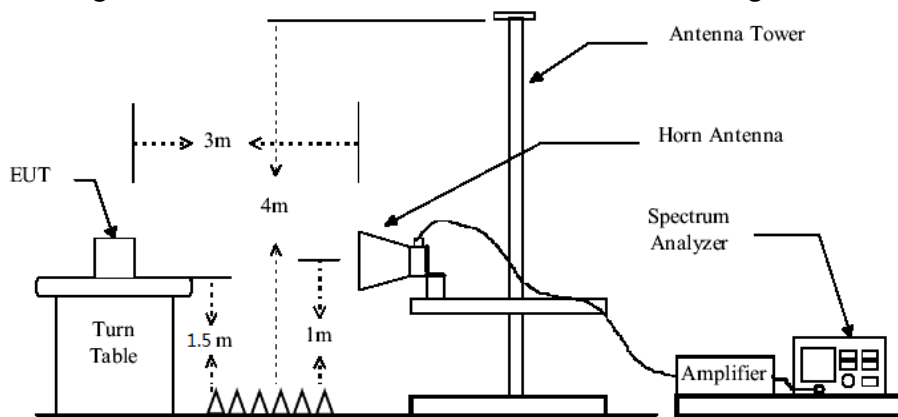

**Figure3. Above 1GHz radiated emissions test configuration**

**Test Procedure:**

- 1) The procedure used was ANSI Standard C63.10. The receiver was scanned from 9KHz to 25GHz. When an emission was found, the table was rotated to produce the maximum signal strength. An initial pre-scan was performed for in peak detection mode using the receiver. The EUT was measured for both the Horizontal and Vertical polarities and performed a pre-test three orthogonal planes. For intentional radiators, measurements of the variation of the input power or the radiated signal level of the fundamental frequency component of the emission, as appropriate, shall be performed with the supply voltage varied between 85% and 115% of the nominal rated supply voltage. The worst case emissions were reported.
- 2) Low noise amplifier was used below 1GHz, High pass Filter was used above 3GHz. Between 1G and 3GHz, we did not use any amplifier or filter.
- 3) Pre-test was performed on all modes, Compliance test was performed on worse case (GFSK mode).
  - a) Below 30 MHz, Test were performed for their spatial orthogonal(X, Y, Z), the worst test data (X orthogonal) was submitted.
  - b) For this intentional radiator operates below 25 GHz. the spectrum shall be investigated to the tenth harmonic of the highest fundamental frequency. And above the third harmonic of this intentional radiator, the disturbance is very low. So the test result only displays to 5rd harmonic.
  - c) As shown in Section, for frequencies above 1000MHz. the above field strength limits are based on average limits. However, the peak field strength of any emission shall not exceed the maximum permitted average limits specified above by more than 20 dB under any condition of modulation.
- 4) No spurious emissions were detected within 20dB of limit below 30MHz.

**Test Result:**

Pass

### 6.11.1 Radiated Spurious Emissions

30MHz-1GHz:

Item	Freq.	Read Level	Antenna Factor	Preamp Factor	Cable Loss	Result Level	Limit Line	Over Limit	Detector	Polarization
(Mark)	(MHz)	(dB $\mu$ V)	(dB/m)	(dB)	(dB)	(dB $\mu$ V/m)	(dB $\mu$ V/m)	(dB)		
1	48.84	48.08	13.86	28.80	1.13	34.27	40.00	-5.73	QP	VERTICAL
2	56.99	47.09	12.85	28.80	1.19	32.33	40.00	-7.67	QP	VERTICAL
3	73.62	50.63	10.68	28.80	1.31	33.82	40.00	-6.18	QP	VERTICAL
4	163.76	44.13	12.14	28.36	1.60	29.51	43.50	-13.99	QP	VERTICAL
5	193.09	43.51	11.00	28.20	1.73	28.04	43.50	-15.46	QP	VERTICAL
6	827.49	33.54	23.77	29.06	3.90	32.15	46.00	-13.85	QP	VERTICAL
1	48.84	34.23	13.86	28.80	1.13	20.42	40.00	-19.58	QP	HORIZONTAL
2	63.09	34.69	12.48	28.80	1.20	19.57	40.00	-20.43	QP	HORIZONTAL
3	125.01	34.52	11.85	28.58	1.32	19.11	43.50	-24.39	QP	HORIZONTAL
4	198.59	37.55	10.84	28.10	1.75	22.04	43.50	-21.46	QP	HORIZONTAL
5	300.37	34.74	13.50	27.90	2.25	22.59	46.00	-23.41	QP	HORIZONTAL
6	572.61	35.02	20.21	29.24	3.19	29.18	46.00	-16.82	QP	HORIZONTAL

Result Level = Read Level + Antenna Factor + Cable loss - Preamp Factor

Below is the plot of worst case on lowest channel:  
Vertical:

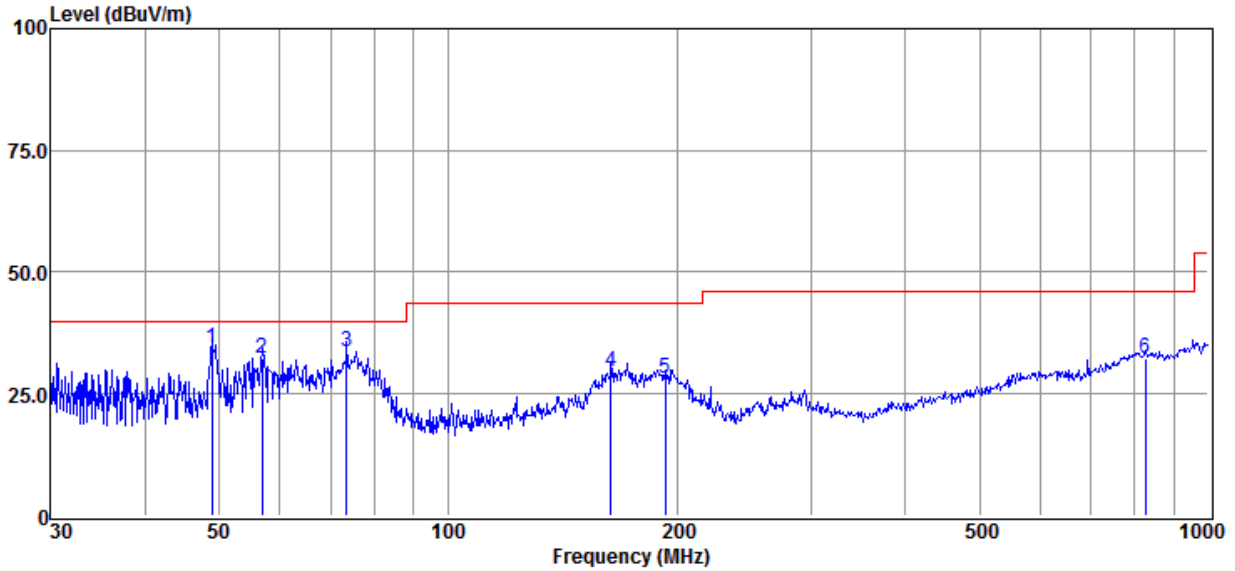

Horizontal:

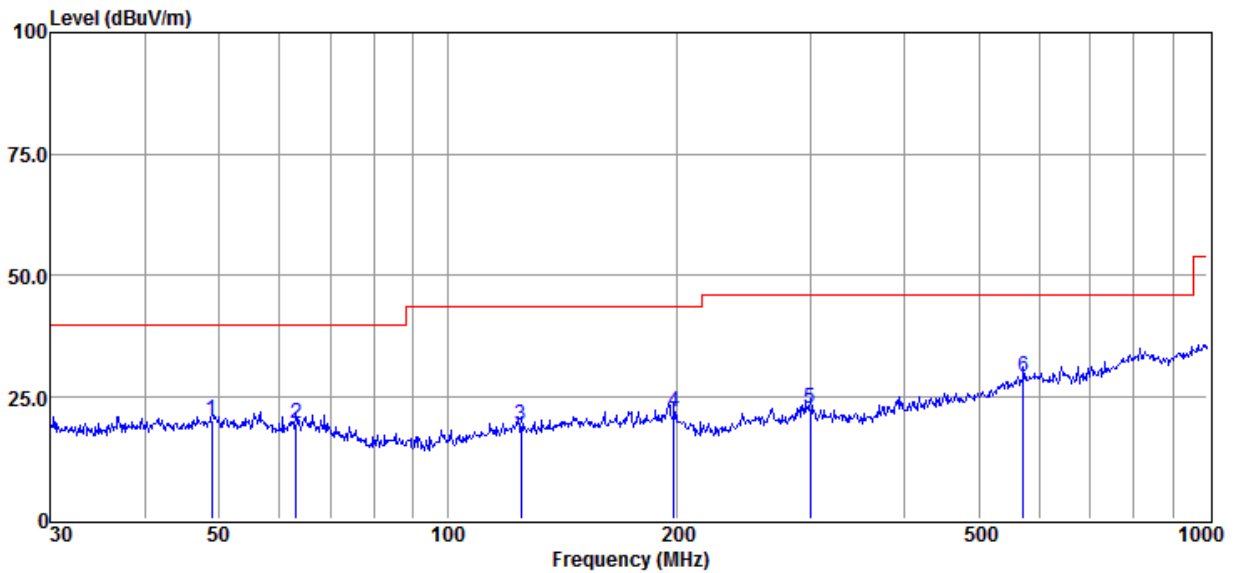

Above 1GHz:

**Lowest Channel(2402MHz)**

Mark	Frequency (MHz)	Reading (dBuV)	Factor (dB)	Emission (dBuV/m)	Limit (dBuV/m)	Over Limit (dB)	Detector	Polarization
1	4804	40.23	6.18	46.41	54	-7.59	peak	Horizontal
2	7206	36.04	10.63	46.67	54	-7.33	peak	Horizontal
3	9608	35.06	14.38	49.44	54	-4.56	peak	Horizontal
4	4804	36.37	6.18	42.55	54	-11.45	peak	Vertical
5	7206	35.86	10.63	46.49	54	-7.51	peak	Vertical
6	9608	31.53	14.38	45.91	54	-8.09	peak	Vertical

**Middle Channel(2441MHz)**

Mark	Frequency (MHz)	Reading (dBuV)	Factor (dB)	Emission (dBuV/m)	Limit (dBuV/m)	Over Limit (dB)	Detector	Polarization
1	4882	34.75	7	41.75	54	-12.25	peak	Horizontal
2	7323	36.72	11.13	47.85	54	-6.15	peak	Horizontal
3	9764	34.19	14.36	48.55	54	-5.45	peak	Horizontal
4	4882	37.88	7	44.88	54	-9.12	peak	Vertical
5	7323	32.8	11.13	43.93	54	-10.07	peak	Vertical
6	9764	33.6	14.36	47.96	54	-6.04	peak	Vertical

**Highest Channel(2480MHz)**

Mark	Frequency (MHz)	Reading (dBuV)	Factor (dB)	Emission (dBuV/m)	Limit (dBuV/m)	Over Limit (dB)	Detector	Polarization
1	4960	37.54	7.49	45.03	54	-8.97	peak	Horizontal
2	7440	38.25	11.65	49.9	54	-4.1	peak	Horizontal
3	9920	30.63	14.4	45.03	54	-8.97	peak	Horizontal
4	4960	36.81	7.49	44.3	54	-9.7	peak	Vertical
5	7440	36.59	11.65	48.24	54	-5.76	peak	Vertical
6	9920	30.89	14.4	45.29	54	-8.71	peak	Vertical

- Remark: 1) Emission = Receiver Reading + Factor  
 2) Factor = Antenna Factor + Cable Loss + Pre-amplifier Factor.  
 3) If the Peak value below the AV Limit, the AV test doesn't perform for this submission.

**6.11.2 Radiated Band edge  
Lowest Channel(2402MHz)**

Vertical:

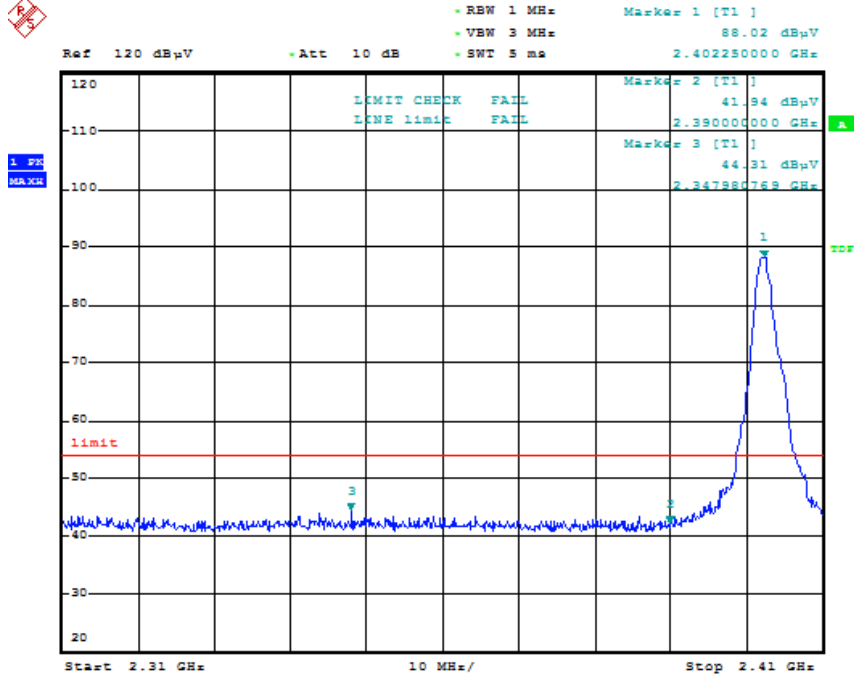

Horizontal:

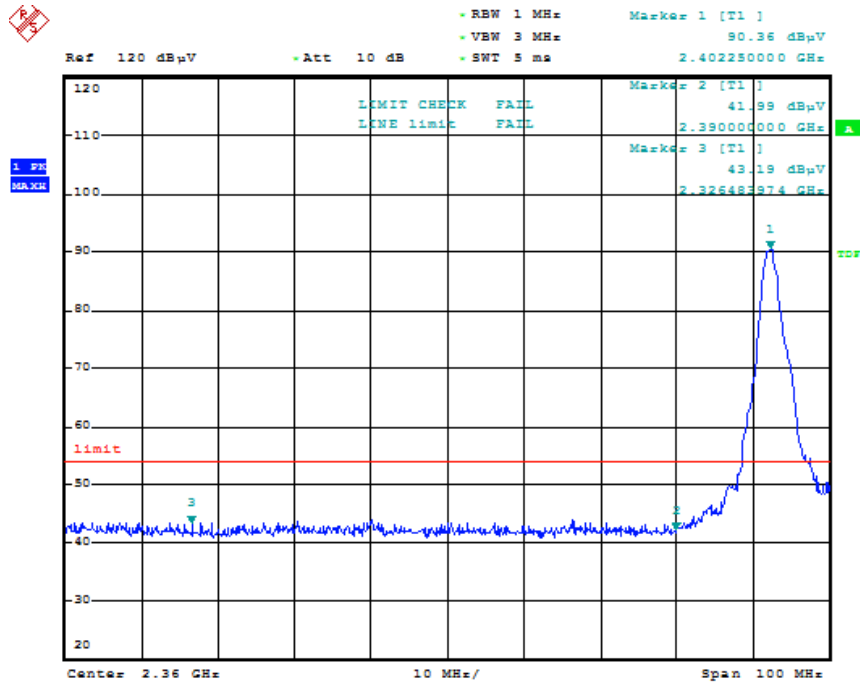

### Highest Channel(2480MHz)

Vertical:

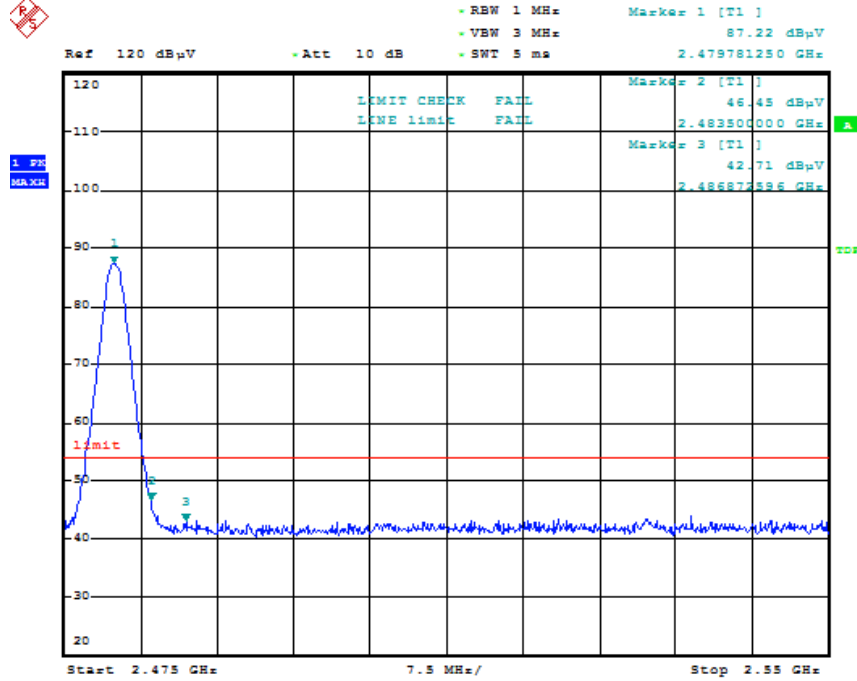

Horizontal:

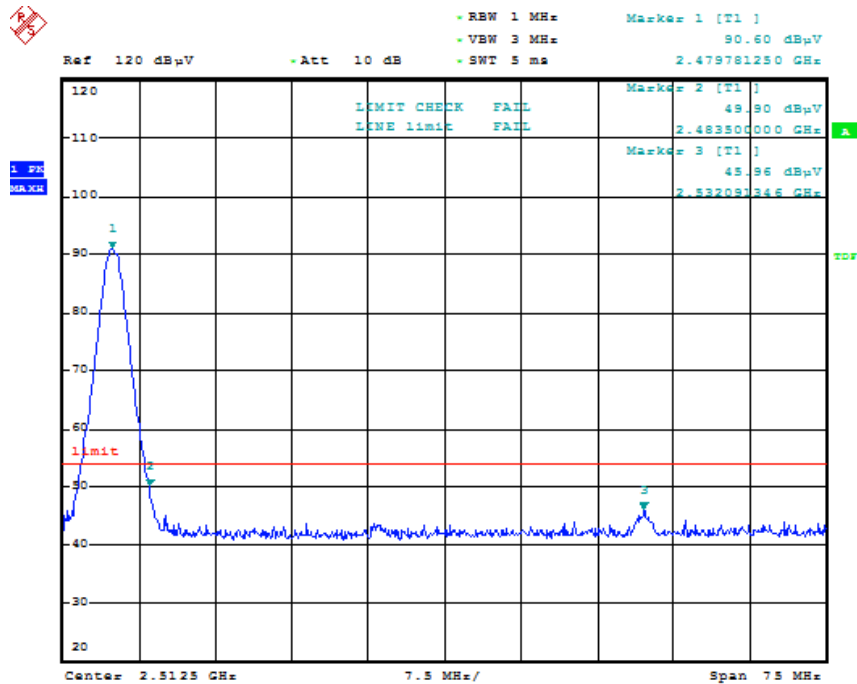





- Remark: 1). Test Level = Receiver Reading + Antenna Factor + Cable Loss- Preamplifier Factor  
2). If the Peak value below the AV Limit, the AV test doesn't perform for this submission.

All frequencies within the "Restricted bands" have been evaluated to compliance. Except as shown in paragraph of this section, only spurious emissions are permitted in any of the frequency bands listed below:

a. FCC Part 15, Subpart C Section 15.205 Restricted bands of operation.

MHz	MHz	MHz	GHz
0.090 - 0.110	16.42 - 16.423	399.9 - 410	4.5 - 5.15
<sup>1</sup> 0.495 - 0.505	16.69475 - 16.69525	608 - 614	5.35 - 5.46
2.1735 - 2.1905	16.80425 - 16.80475	960 - 1240	7.25 - 7.75
4.125 - 4.128	25.5 - 25.67	1300 - 1427	8.025 - 8.5
4.17725 - 4.17775	37.5 - 38.25	1435 - 1626.5	9.0 - 9.2
4.20725 - 4.20775	73 - 74.6	1645.5 - 1646.5	9.3 - 9.5
6.215 - 6.218	74.8 - 75.2	1660 - 1710	10.5 - 12.7
6.26775 - 6.26825	108 - 121.94	1718.8 - 1722.2	13.25 - 13.4
6.31175 - 6.31225	123 - 138	2200 - 2300	14.47 - 14.5
8.291 - 8.294	149.9 - 150.05	2310 - 2390	15.35 - 16.2
8.362 - 8.366	156.52475 - 156.52525	2483.5 - 2500	17.7 - 21.4
8.37625 - 8.38675	156.7 - 156.9	2655 - 2900	22.01 - 23.12
8.41425 - 8.41475	162.0125 - 167.17	3260 - 3267	23.6 - 24.0
12.29 - 12.293	167.72 - 173.2	3332 - 3339	31.2 - 31.8
12.51975 - 12.52025	240 - 285	3345.8 - 3358	36.43 - 36.5
12.57675 - 12.57725	322 - 335.4	3600 - 4400	
13.36 - 13.41			



b. RSS-Gen section 7.2.2 Restricted bands of operation

MHz	MHz	GHz
0.090-0.110	240-285	9.0-9.2
2.1735-2.1905	322-335.4	9.3-9.5
3.020-3.026	399.9-410	10.6-12.7
4.125-4.128	608-614	13.25-13.4
4.17725-4.17775	960-1427	14.47-14.5
4.20725-4.20775	1435-1626.5	15.35-16.2
5.677-5.683	1645.5-1646.5	17.7-21.4
6.215-6.218	1660-1710	22.01-23.12
6.26775-6.26825	1718.8-1722.2	23.6-24.0
6.31175-6.31225	2200-2300	31.2-31.8
8.291-8.294	2310-2390	36.43-36.5
8.362-8.366	2655-2900	Above 38.6
8.37625-8.38675	3260-3267	
8.41425-8.41475	3332-3339	
12.29-12.293	3345.8-3358	
12.51975-12.52025	3500-4400	
12.57675-12.57725	4500-5150	
13.36-13.41	5350-5460	
16.42-16.423	7250-7750	
16.69475-16.69525	8025-8500	
16.80425-16.80475		
25.5-25.67		
37.5-38.25		
73-74.6		
74.8-75.2		
108-138		
156.52475-156.52525		
156.7-156.9		

## 6.12 99% Occupied Bandwidth

**Test Configuration:**

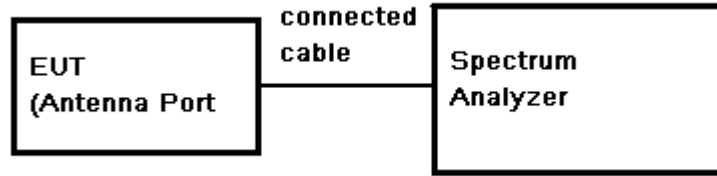

**Test Procedure:**

- 1) Remove the antenna from the EUT and then connect a low RF cable from the antenna port to the spectrum;
- 2) Set the spectrum analyzer: Span = approximately 2 to 3 times the 20dB bandwidth, centred on the hopping channel;
- 3) Set the spectrum analyzer: RBW  $\geq$  1% of the selected span (set 30 kHz). VBW  $\geq$  RBW. Sweep = auto; Detector Function = Peak. Trace = Max Hold.
- 4) Mark the peak frequency and 99% bandwidth points.

**Test Date:**

Test Frequency(MHz)	Bandwidth(MHz)
2402	0.996
2441	0.993
2480	0.996

**Test plot as follows:**

Test mode	channel: 2402
-----------	---------------

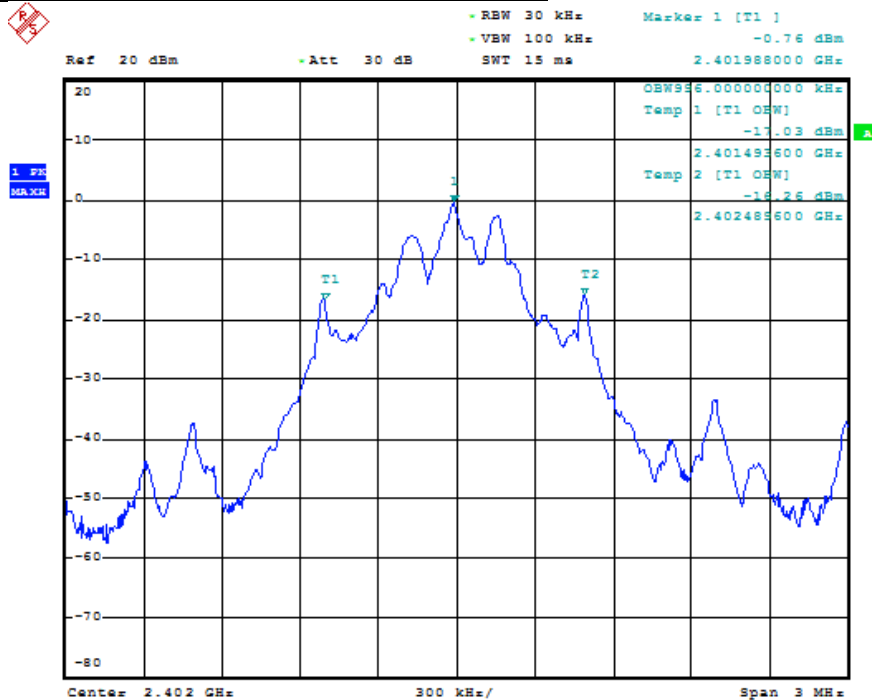

Test mode	channel: 2441
-----------	---------------

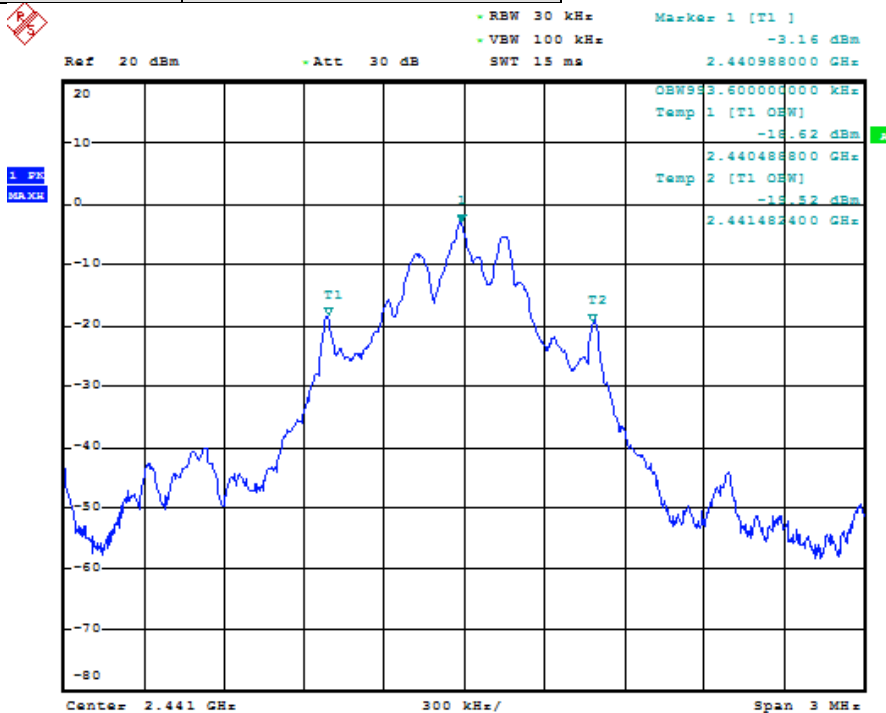

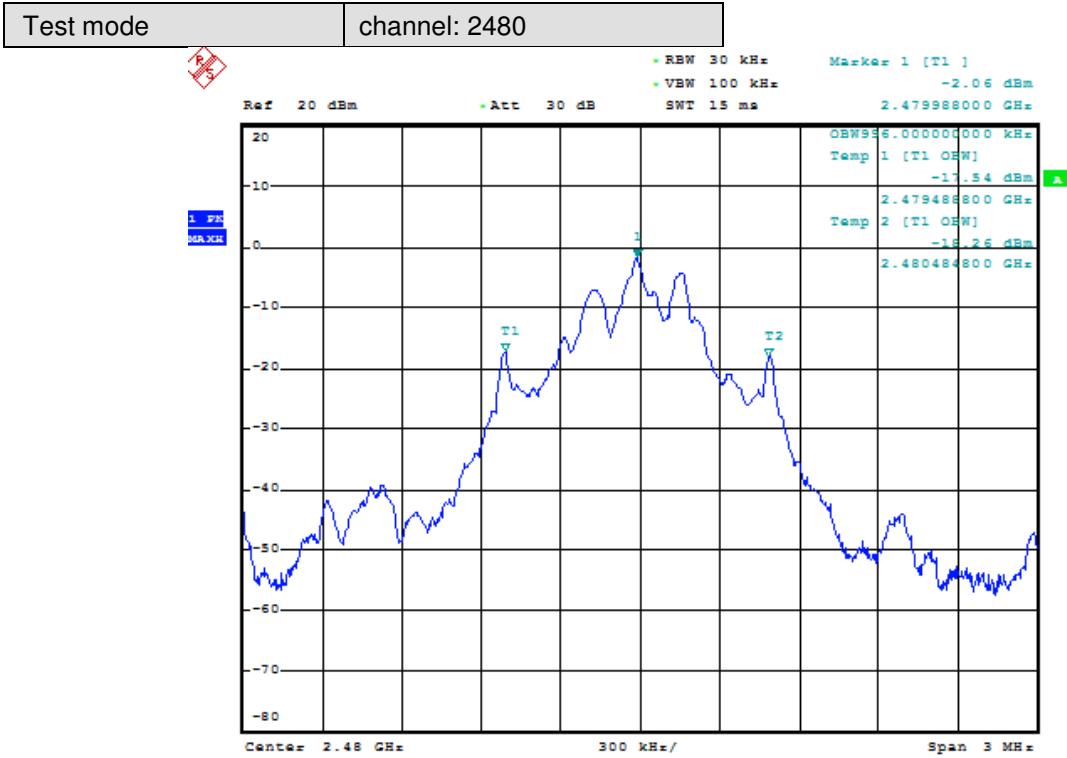

## 7 Test Setup Photographs

Refer to the < MAUI28G2 \_Test Setup photos-FCC>.

## 8 EUT Constructional Details

Refer to the < MAUI28G2 \_External Photos > & < MAUI28G2 \_Internal Photos>.

**--End of the Report--**