

72000122B 天线测试报告

1. 天线驻波比测试

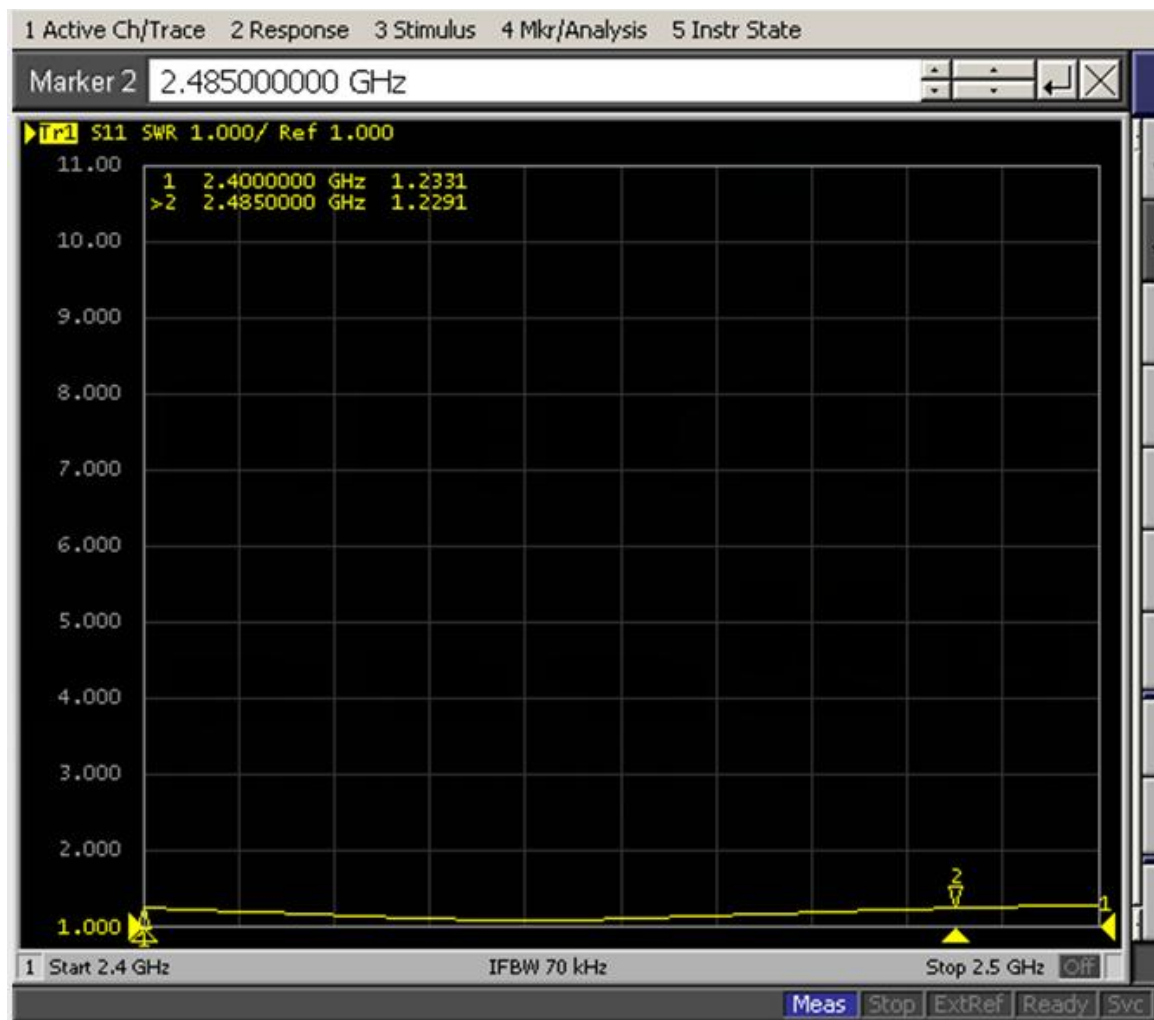

2. 天线暗室测试报告

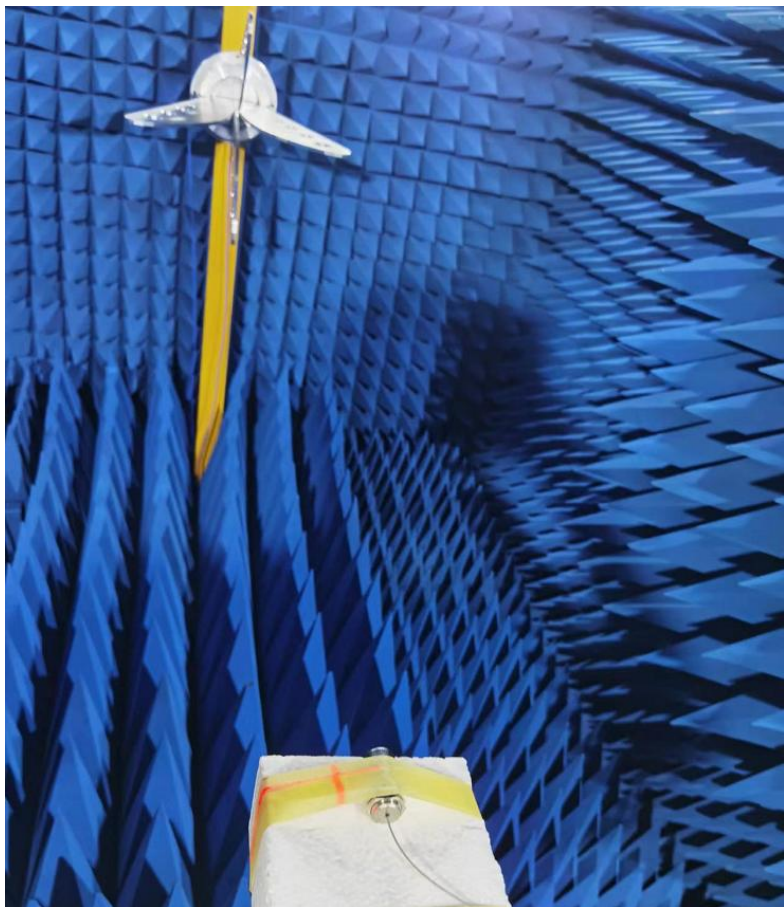

No.	Modification	modification date
1		
2		

Specification description

quantity

RF1.13 One gray wire with input impedance of 50 Ω, 400MM long connecting wire, one end with IPEX plug, and the other end with nut and gasket as shown in the figure, with nut and waterproof rubber gasket.

1

Electrical performance:

1. Frequency Range: 2400–2500MHz
2. Antenna Gain: Max 4.61dBi
3. Operating temperature: -40°C to 85°C
4. Degree of protection: IP65

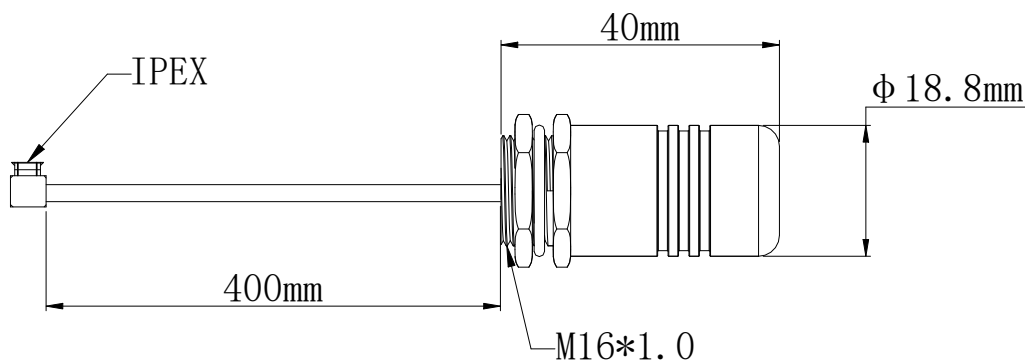

Controlled original/copy:

Company seal:

approval			size	MM
examine	黄集胜	22.03.04	page	1
author	张志朋	22.03.04	Revision	B版

Frequency ID	1	2	3	4	5	6	7	8	9	10	11	12	13	14	15	16	17	18	19	20	21
Frequency (MHz)	2400.0	2405.0	2410.0	2415.0	2420.0	2425.0	2430.0	2435.0	2440.0	2445.0	2450.0	2455.0	2460.0	2465.0	2470.0	2475.0	2480.0	2485.0	2490.0	2495.0	2500.0
Efficiency (dBi)	-2.74	-2.79	-2.69	-2.67	-2.66	-2.58	-2.67	-2.64	-2.70	-1.81	-1.85	-1.88	-1.92	-1.95	-1.93	-1.94	-1.93	-1.86	-1.83	-1.87	-1.83
Gain (dBi)	2.71	2.75	2.92	3.01	3.08	3.23	3.21	3.27	3.23	4.12	4.10	4.13	4.17	4.20	4.24	4.24	4.33	4.44	4.53	4.54	4.61
Efficiency (%)	53.26	52.58	53.79	54.08	54.25	55.22	54.12	54.39	53.73	65.94	65.36	64.86	64.29	63.87	64.15	63.90	64.16	65.13	65.58	64.99	65.65
Directivity (dB)	5.45	5.54	5.62	5.68	5.73	5.81	5.88	5.92	5.93	5.93	5.95	6.01	6.09	6.14	6.17	6.19	6.26	6.30	6.36	6.41	6.44
Peak Gain Position (Theta)	120.00	135.00	135.00	135.00	135.00	135.00	135.00	135.00	135.00	135.00	135.00	135.00	135.00	135.00	135.00	135.00	135.00	135.00	135.00	135.00	135.00
Peak Gain Position (Phi)	105.00	60.00	60.00	60.00	60.00	60.00	60.00	60.00	60.00	60.00	60.00	60.00	60.00	60.00	60.00	60.00	60.00	60.00	60.00	60.00	60.00
Efficiency ThetaPol (%)	36.30	36.57	37.73	37.84	37.59	38.47	38.11	38.63	37.67	45.61	45.17	45.24	45.46	45.17	44.76	43.99	44.47	45.82	46.38	45.53	45.62
Efficiency PhiPol (%)	16.96	16.01	16.07	16.24	16.66	16.75	16.01	15.76	16.06	20.33	20.20	19.62	18.83	18.70	19.38	19.91	19.69	19.32	19.20	19.46	20.03
Upper Hem. Efficiency (%)	16.18	15.99	16.44	16.62	16.71	17.06	16.80	16.98	16.82	20.70	20.55	20.36	20.14	20.05	20.16	20.05	20.13	20.47	20.59	20.35	20.51
Lower Hem. Efficiency (%)	37.08	36.59	37.35	37.46	37.54	38.16	37.31	37.41	36.91	45.24	44.81	44.50	44.15	43.82	43.99	43.85	44.03	44.67	44.99	44.65	45.14

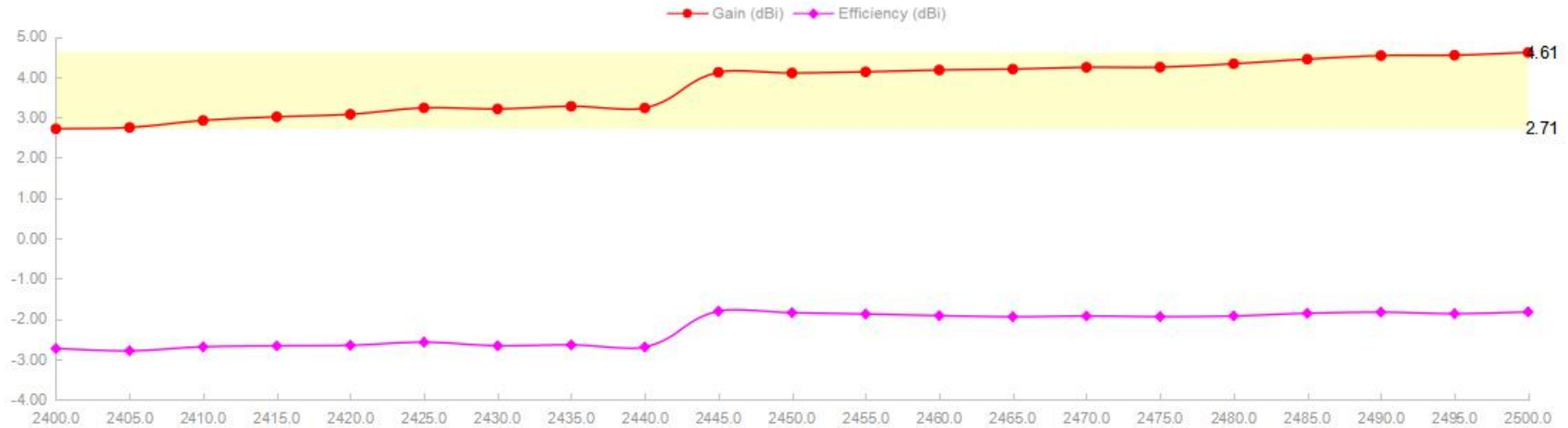

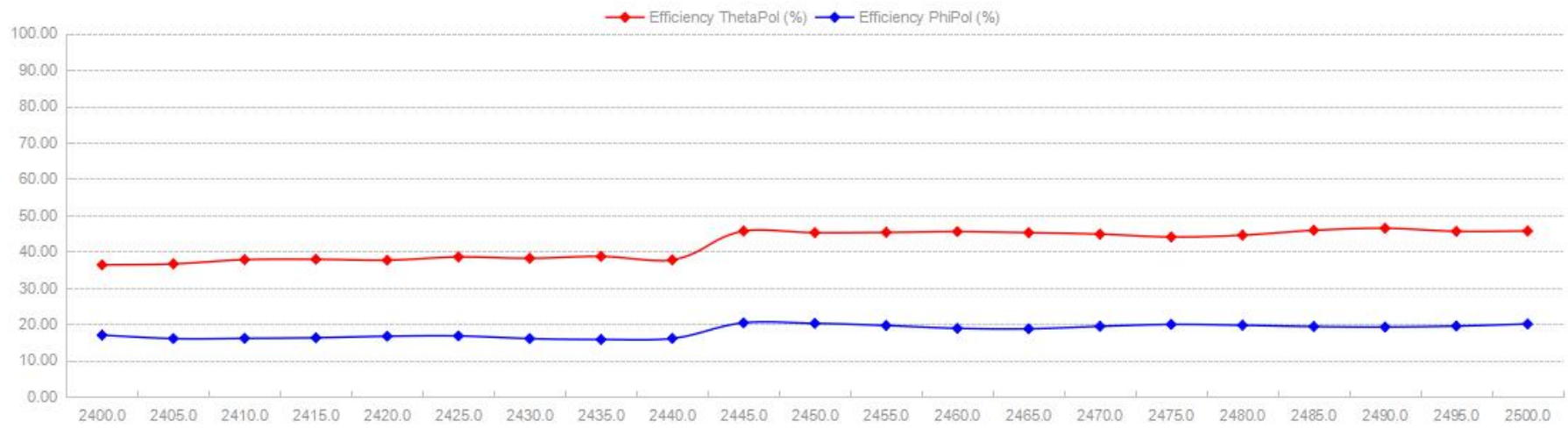

2400.0MHz H+V, Eff: 53.3%

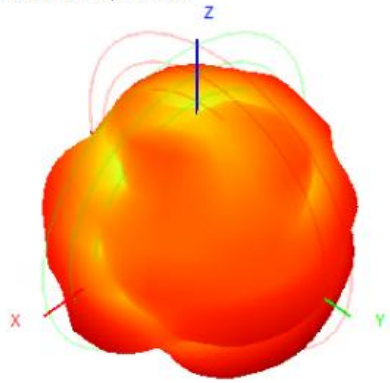

Back View

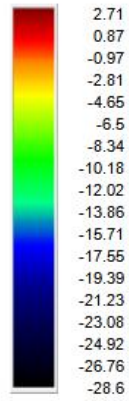
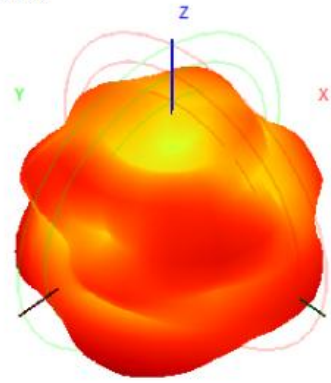

2410.0MHz H+V, Eff: 53.8%

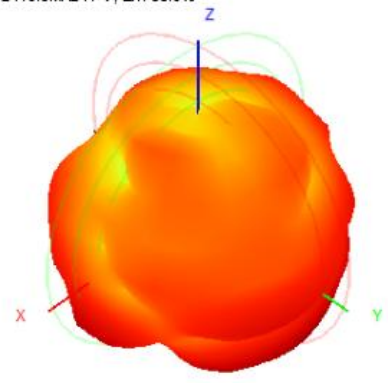

Back View

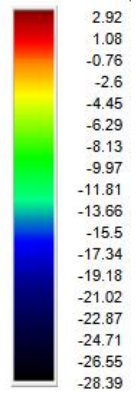
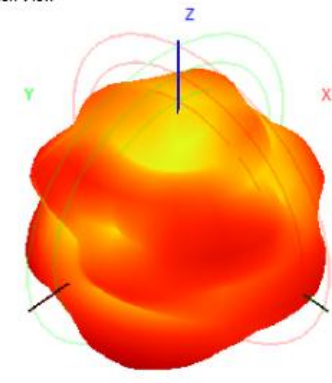

2405.0MHz H+V, Eff: 52.6%

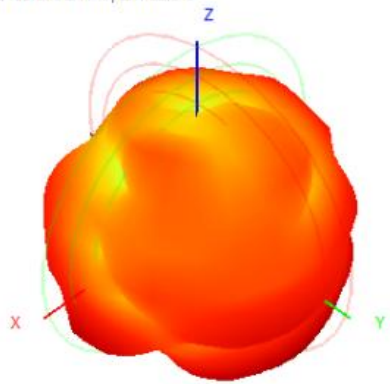

Back View

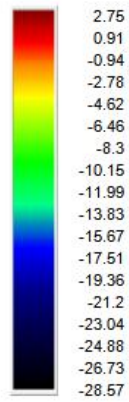
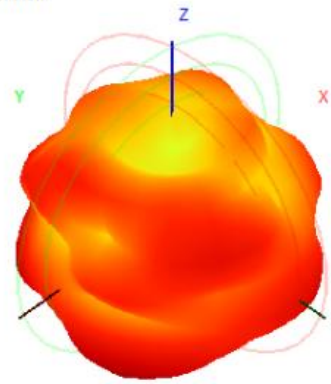

2415.0MHz H+V, Eff: 54.1%

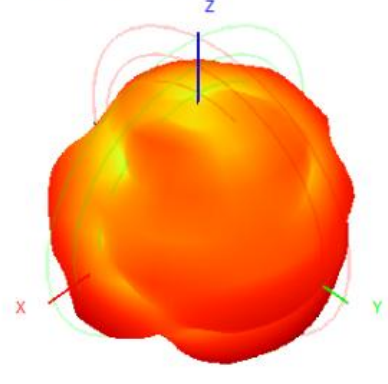

Back View

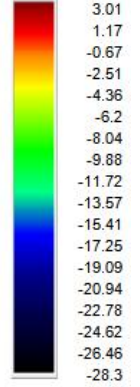
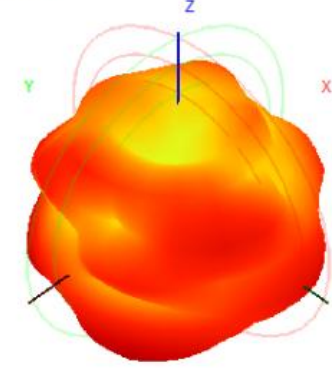

2420.0MHz H+V, Eff: 54.3%

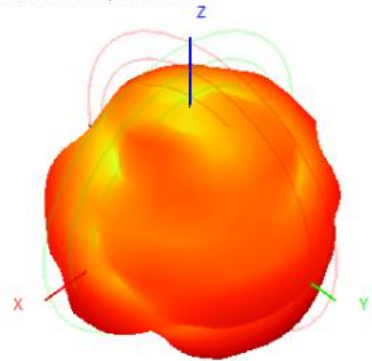

Back View

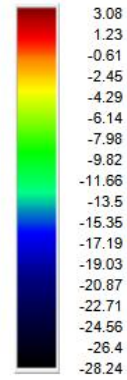
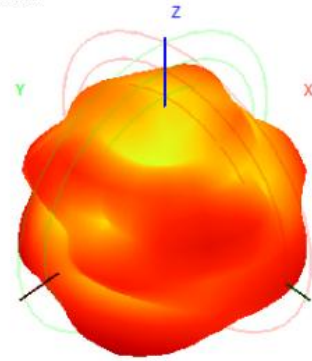

2430.0MHz H+V, Eff: 54.1%

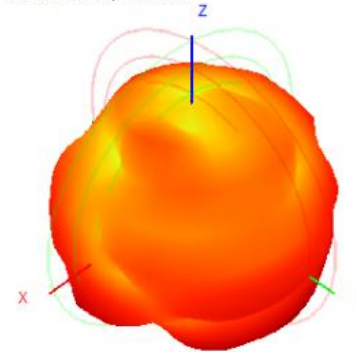

Back View

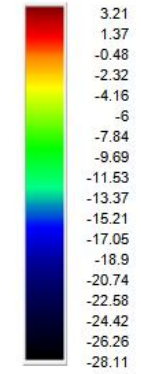
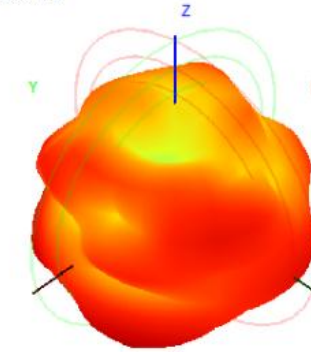

2425.0MHz H+V, Eff: 55.2%

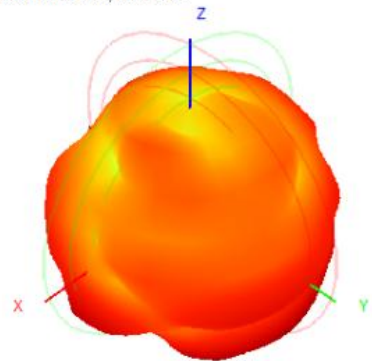

Back View

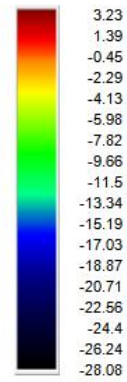
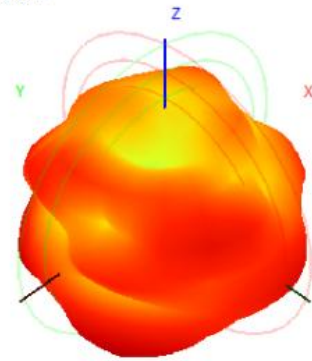

2435.0MHz H+V, Eff: 54.4%

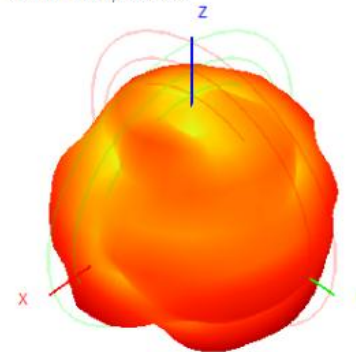

Back View

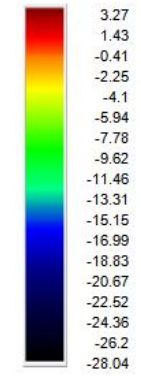
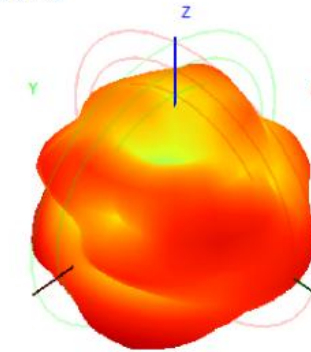

2440.0MHz H+V, Eff: 53.7%

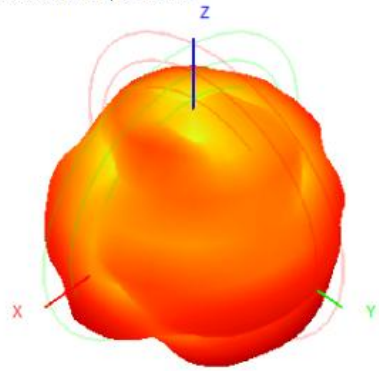

Back View

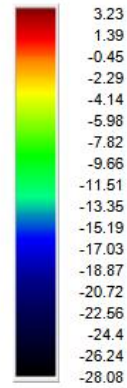
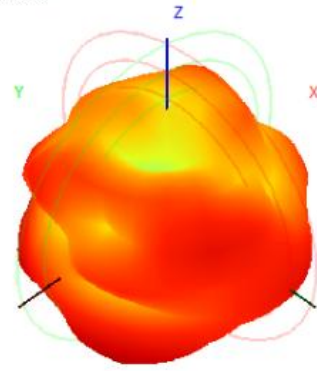

2450.0MHz H+V, Eff: 65.4%

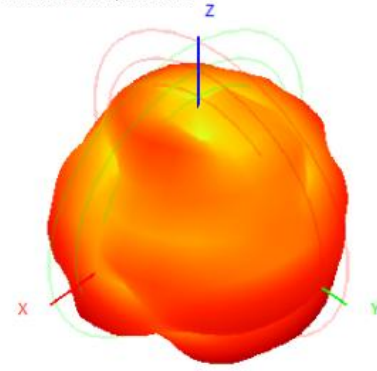

Back View

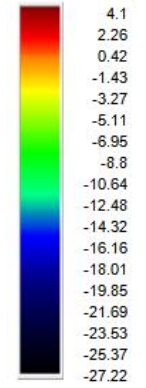
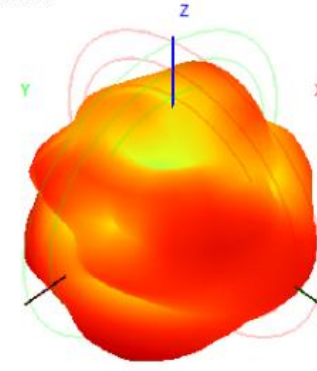

2445.0MHz H+V, Eff: 65.9%

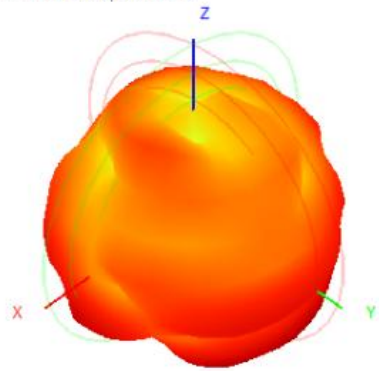

Back View

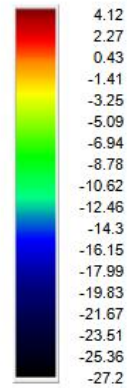
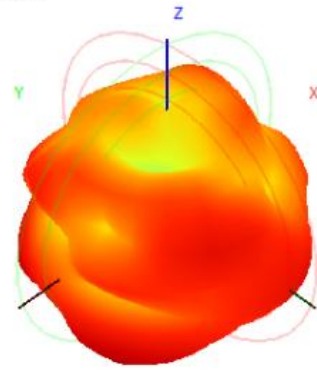

2455.0MHz H+V, Eff: 64.9%

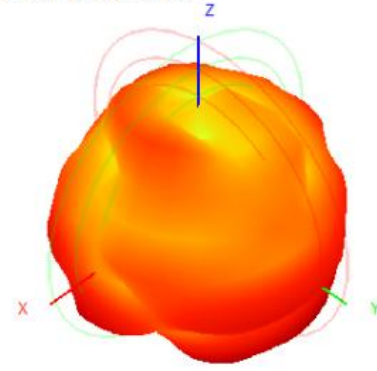

Back View

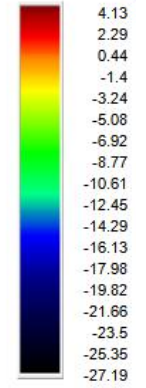
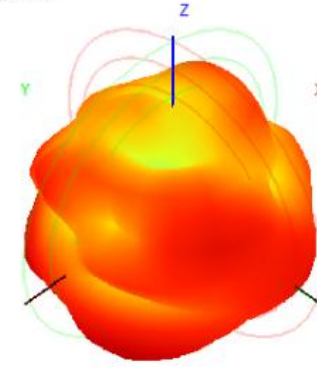

2460.0MHz H+V, Eff: 64.3%

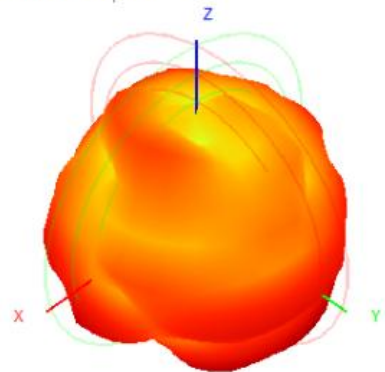

Back View

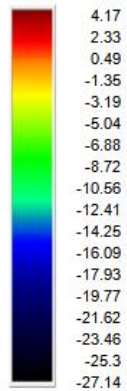
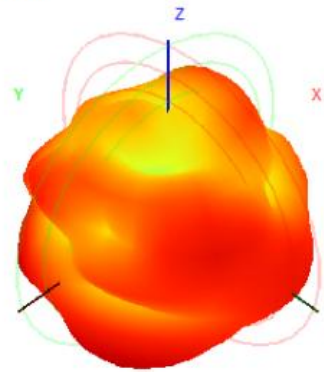

2470.0MHz H+V, Eff: 64.1%

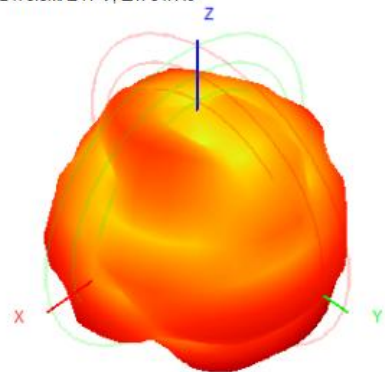

Back View

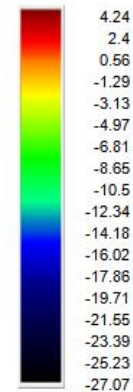
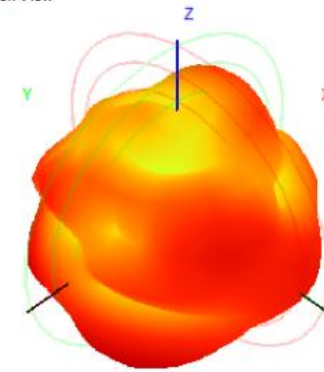

2465.0MHz H+V, Eff: 63.9%

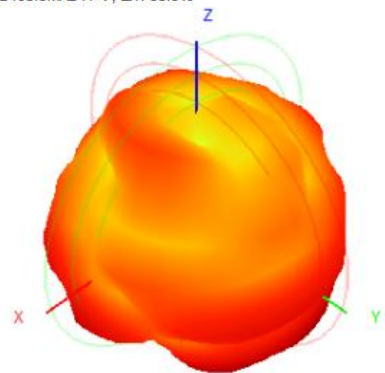

Back View

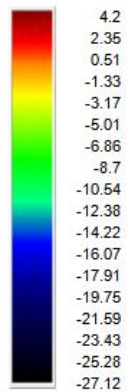
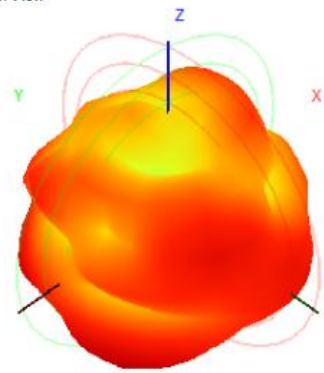

2475.0MHz H+V, Eff: 63.9%

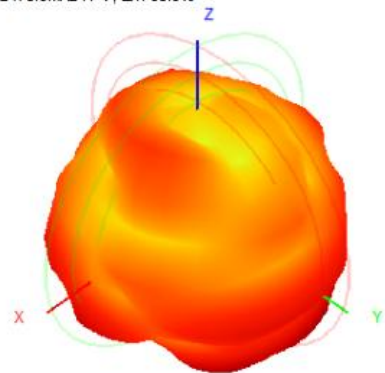

Back View

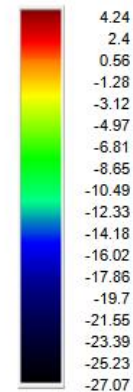
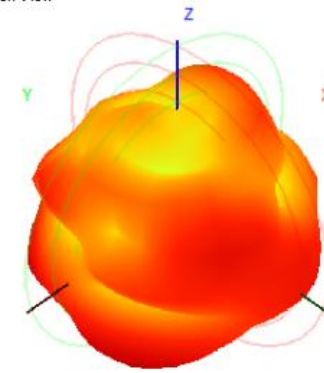

2480.0MHz H+V, Eff: 64.2%

Back View

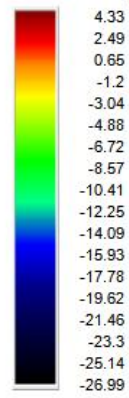
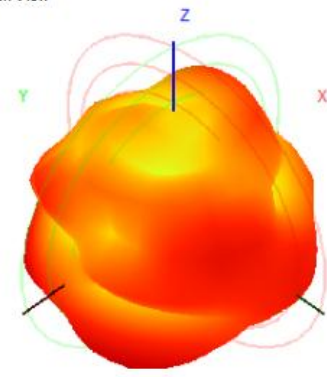
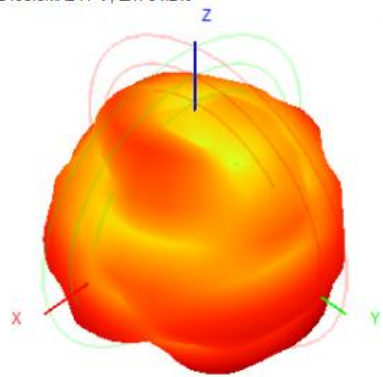

2490.0MHz H+V, Eff: 65.6%

Back View

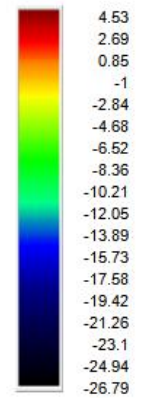
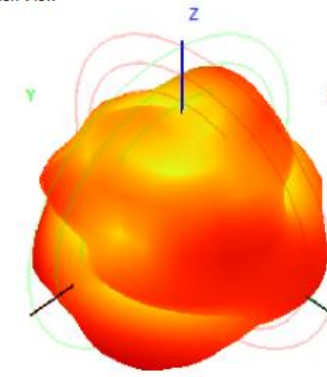
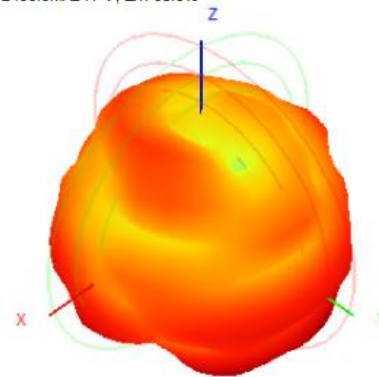

2485.0MHz H+V, Eff: 65.1%

Back View

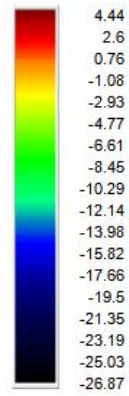
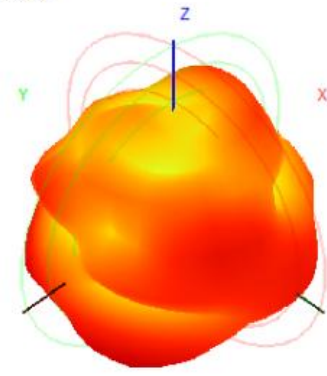
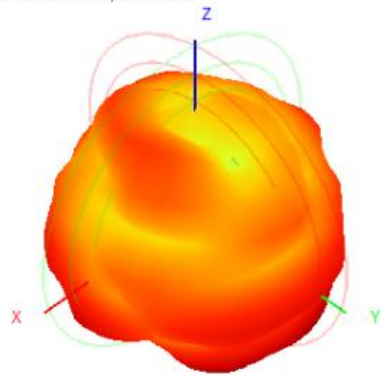

2495.0MHz H+V, Eff: 65.0%

Back View

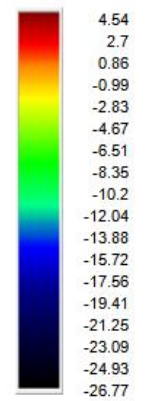
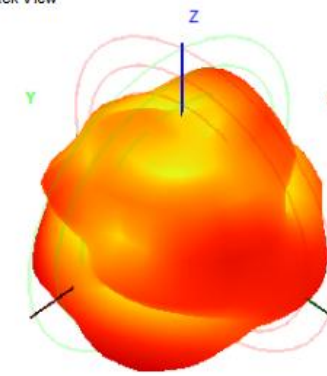
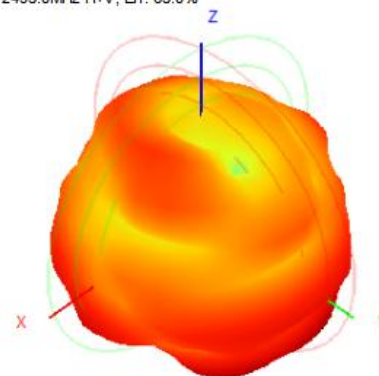

2500.0MHz H+V, Eff: 65.6%

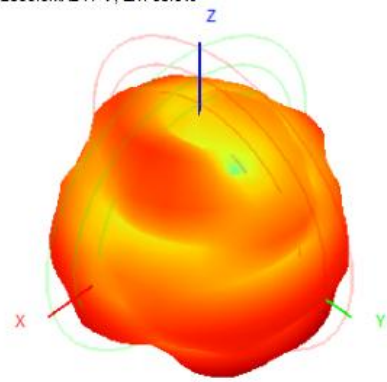

Back View

