

72000122B 天线测试报告

1. 天线驻波比测试

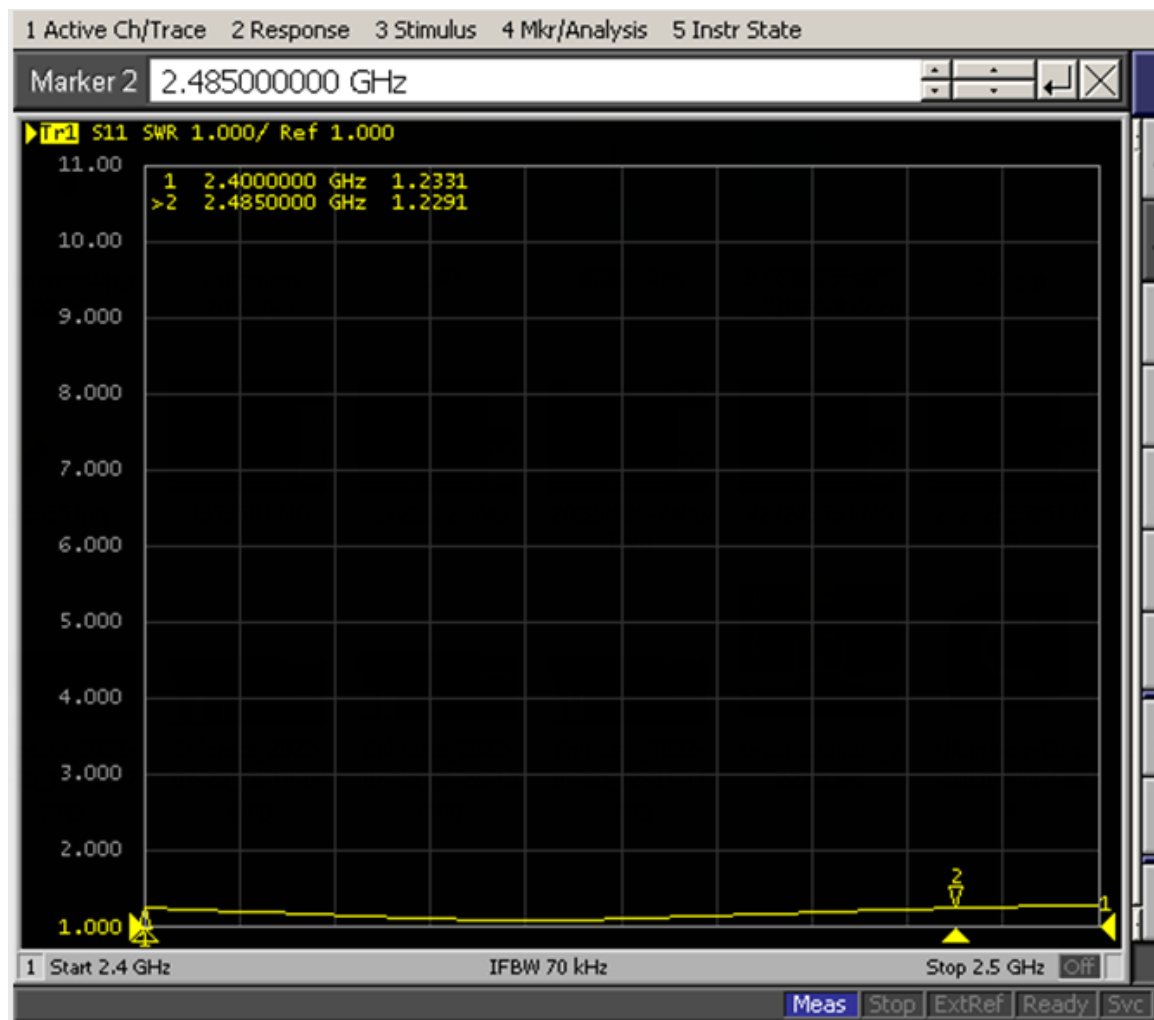

No.	Modification	modification date
1		
2		

Specification description

quantity

RF1.13 One gray wire with input impedance of 50 Ω, 400MM long connecting wire, one end with IPEX plug, and the other end with nut and gasket as shown in the figure, with nut and waterproof rubber gasket.

1

Electrical performance:

1. Frequency Range: 2400–2500MHz
2. Antenna Gain: Max 4.61dBi
3. Operating temperature: -40°C to 85°C
4. Degree of protection: IP65

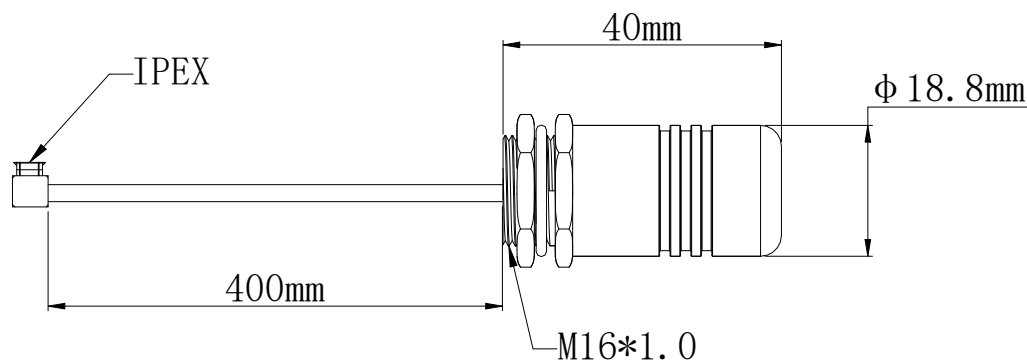

Controlled original/copy:

Company seal:

approval			size	MM
examine	黄集胜	22.03.04	page	1
author	张志朋	22.03.04	Revision	B版

2. 天线暗室测试报告

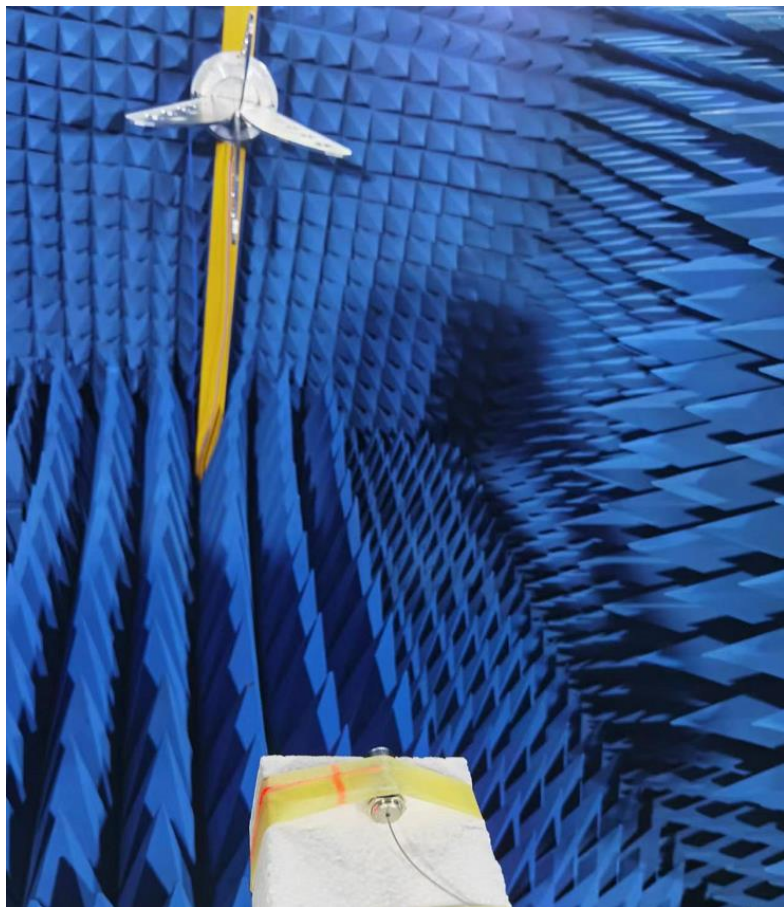

Frequency ID	1	2	3	4	5	6	7	8	9	10	11	12	13	14	15	16	17	18	19	20	21	
Frequency (MHz)	2400.0	2405.0	2410.0	2415.0	2420.0	2425.0	2430.0	2435.0	2440.0	2445.0	2450.0	2455.0	2460.0	2465.0	2470.0	2475.0	2480.0	2485.0	2490.0	2495.0	2500.0	
Efficiency (dBi)	-2.74	-2.79	-2.69	-2.67	-2.66	-2.58	-2.67	-2.64	-2.70	-1.81	-1.85	-1.88	-1.92	-1.95	-1.93	-1.94	-1.93	-1.86	-1.83	-1.87	-1.83	
Gain (dBi)	2.71	2.75	2.92	3.01	3.08	3.23	3.21	3.27	3.23	4.12	4.10	4.13	4.17	4.20	4.24	4.24	4.33	4.44	4.53	4.54	4.61	
Efficiency (%)	53.26	52.58	53.79	54.08	54.25	55.22	54.12	54.39	53.73	65.94	65.36	64.86	64.29	63.87	64.15	63.90	64.16	65.13	65.58	64.99	65.65	
Directivity (dB)	5.45	5.54	5.62	5.68	5.73	5.81	5.88	5.92	5.93	5.93	5.95	6.01	6.09	6.14	6.17	6.19	6.26	6.30	6.36	6.41	6.44	
Peak Gain Position (Theta)	120.00	135.00	135.00	135.00	135.00	135.00	135.00	135.00	135.00	135.00	135.00	135.00	135.00	135.00	135.00	135.00	135.00	135.00	135.00	135.00	135.00	135.00
Peak Gain Position (Phi)	105.00	60.00	60.00	60.00	60.00	60.00	60.00	60.00	60.00	60.00	60.00	60.00	60.00	60.00	60.00	60.00	60.00	60.00	60.00	60.00	60.00	60.00
Efficiency ThetaPol (%)	36.30	36.57	37.73	37.84	37.59	38.47	38.11	38.63	37.67	45.61	45.17	45.24	45.46	45.17	44.76	43.99	44.47	45.82	46.38	45.53	45.62	
Efficiency PhiPol (%)	16.96	16.01	16.07	16.24	16.66	16.75	16.01	15.76	16.06	20.33	20.20	19.62	18.83	18.70	19.38	19.91	19.69	19.32	19.20	19.46	20.03	
Upper Hem. Efficiency (%)	16.18	15.99	16.44	16.62	16.71	17.06	16.80	16.98	16.82	20.70	20.55	20.36	20.14	20.05	20.16	20.05	20.13	20.47	20.59	20.35	20.51	
Lower Hem. Efficiency (%)	37.08	36.59	37.35	37.46	37.54	38.16	37.31	37.41	36.91	45.24	44.81	44.50	44.15	43.82	43.99	43.85	44.03	44.67	44.99	44.65	45.14	

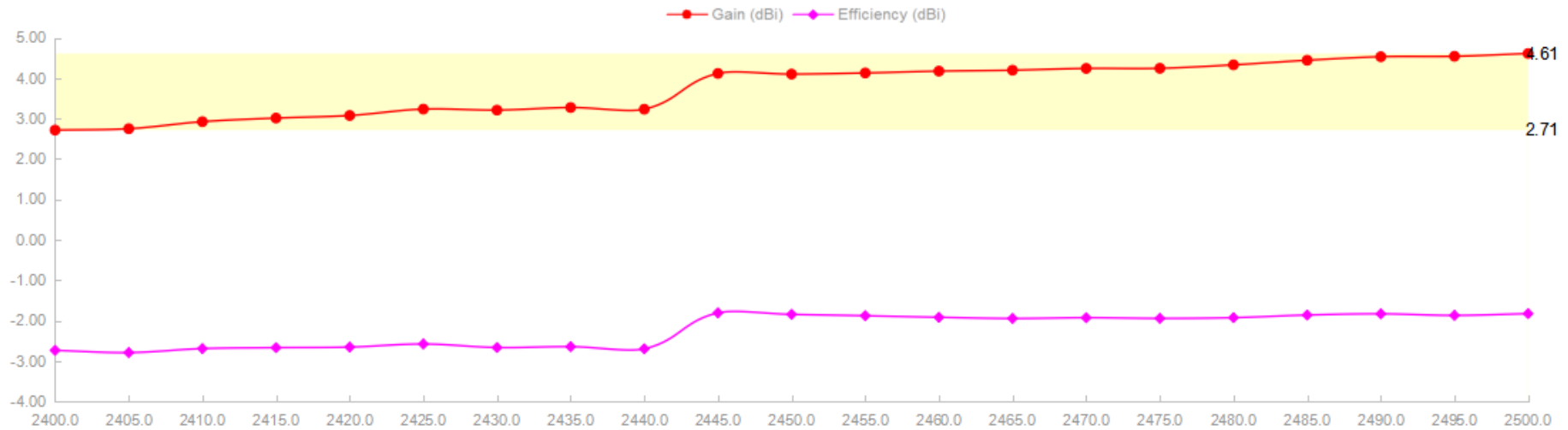

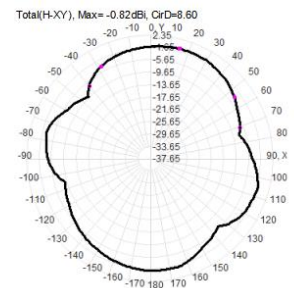
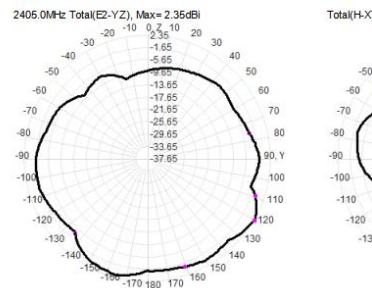
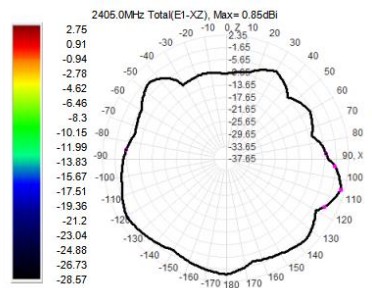
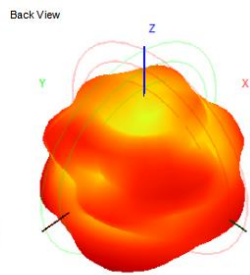
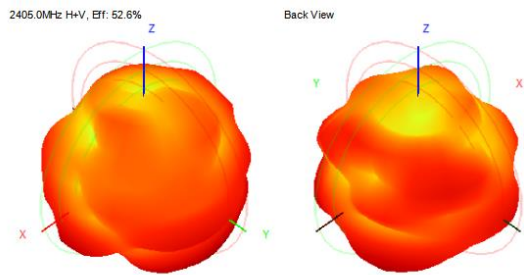
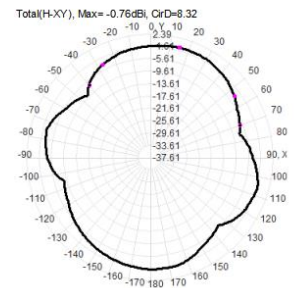
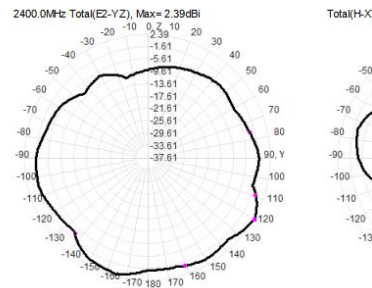
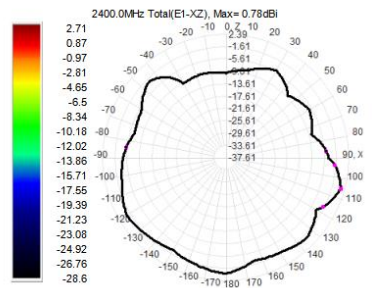
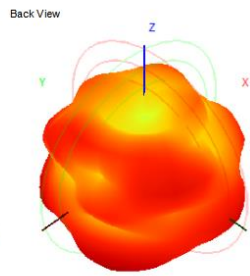
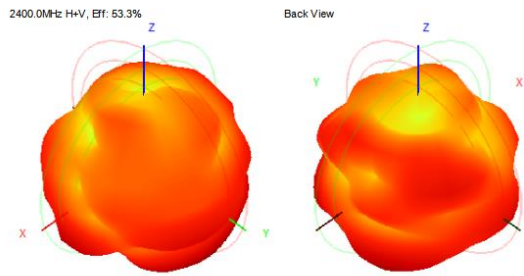
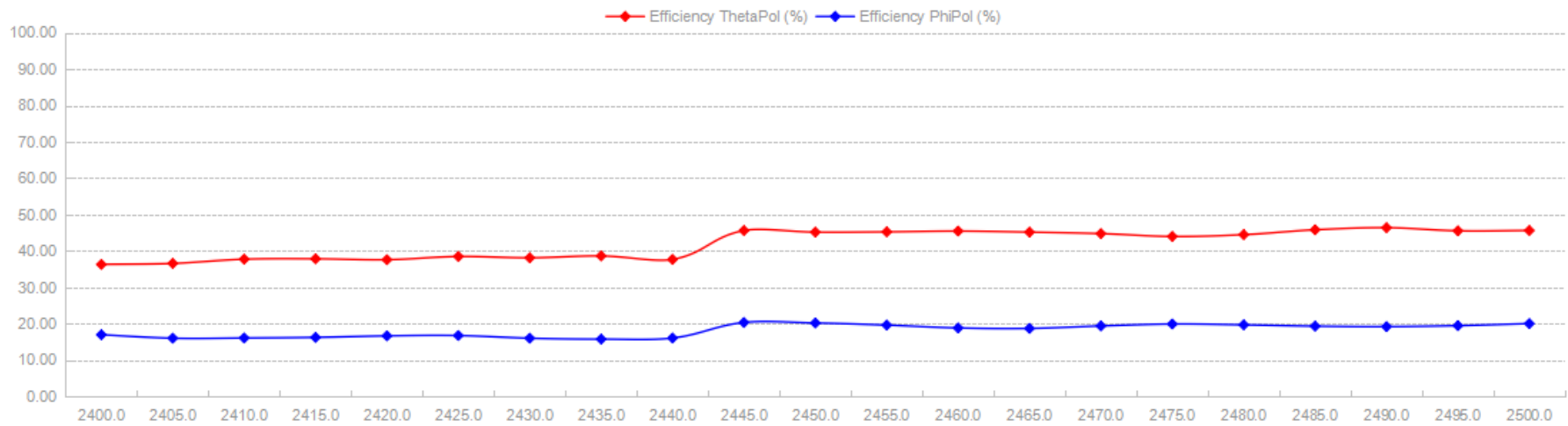

2410.0MHz H+V, Eff: 53.8%

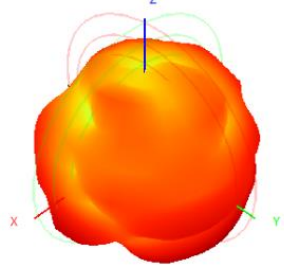

Back View

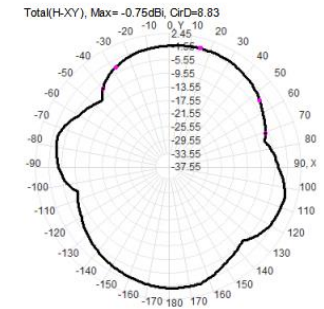
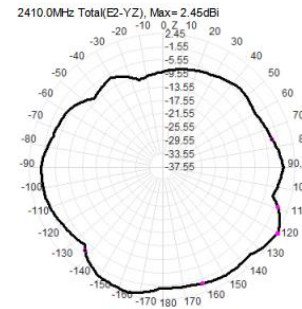
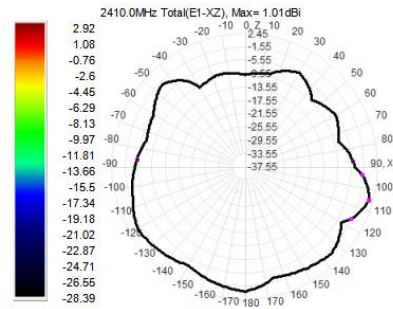
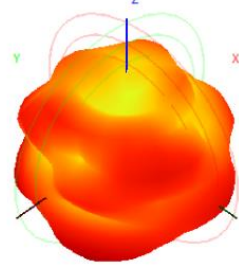

2415.0MHz H+V, Eff: 54.1%

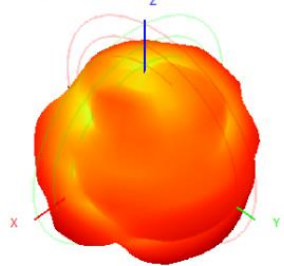

Back View

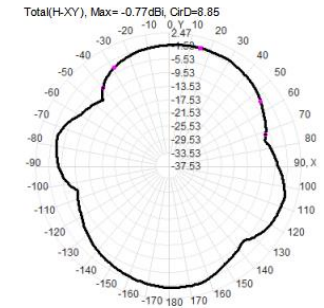
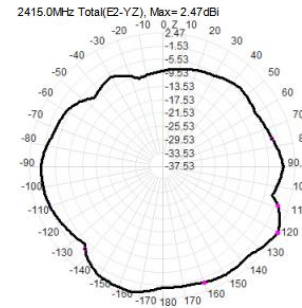
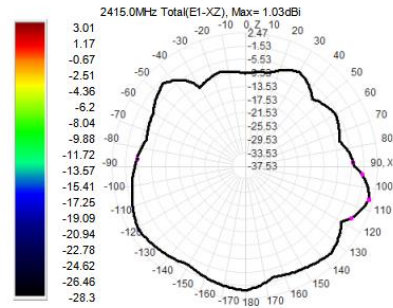
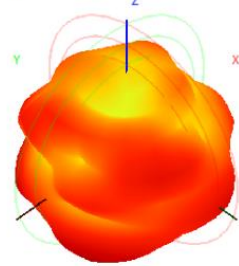

2420.0MHz H+V, Efr: 54.3%

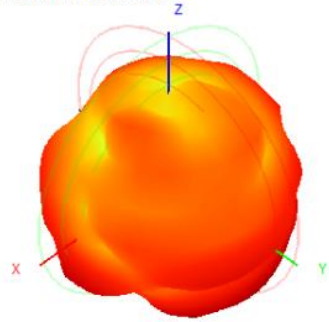

Back View

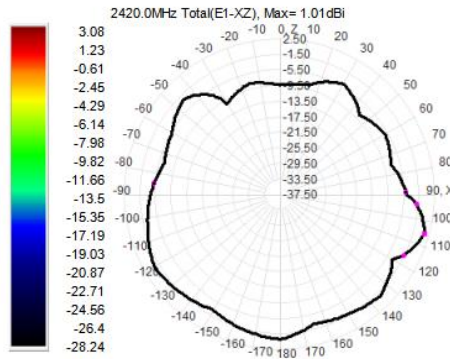
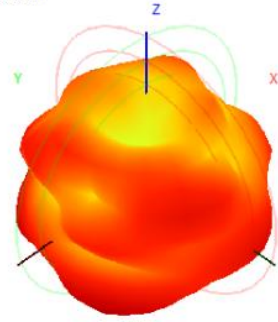

2420.0MHz Total(E2-YZ), Max= 2.50dBi

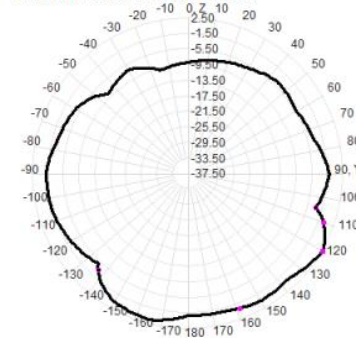

Total(H-XY), Max=-0.82dBi, CirD=8.83

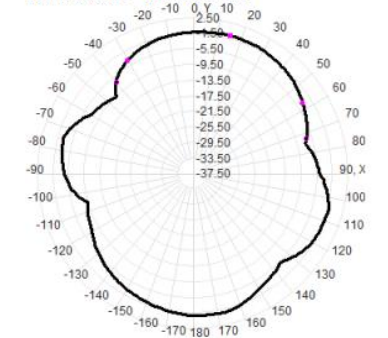

2425.0MHz H+V, Efr: 55.2%

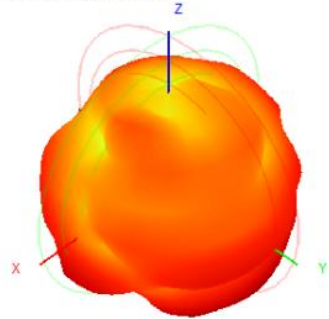

Back View

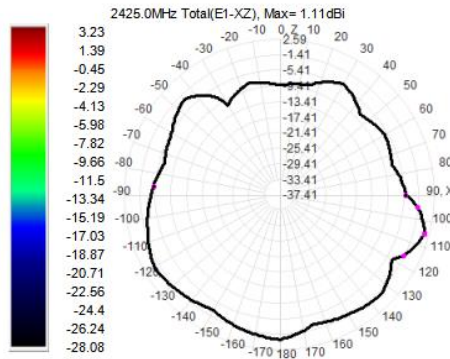
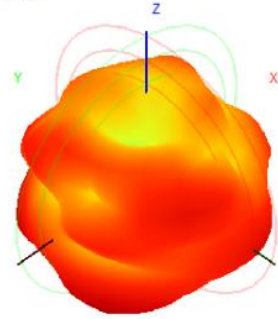

2425.0MHz Total(E2-YZ), Max= 2.59dBi

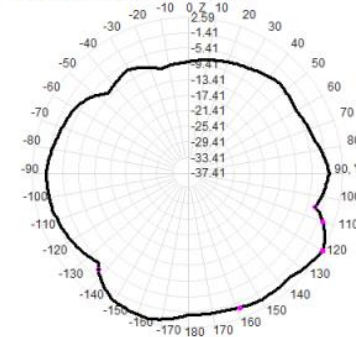

Total(H-XY), Max=-0.78dBi, CirD=8.75

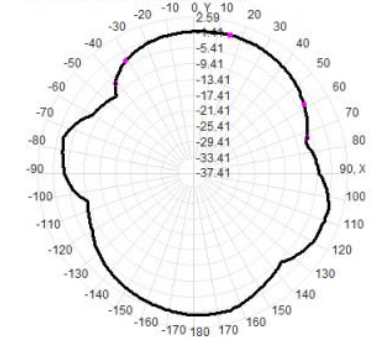

2430.0MHz H+V, Eff: 54.1%

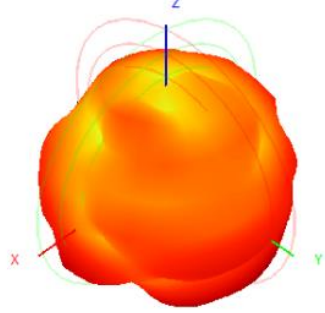

Back View

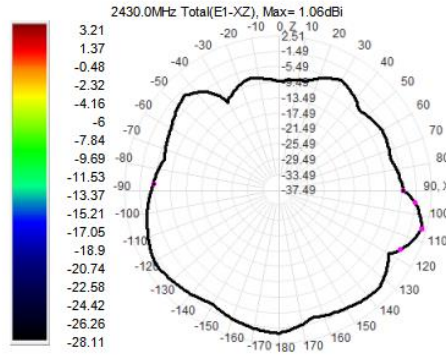
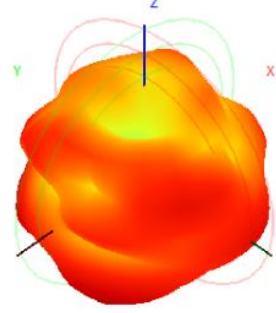

2430.0MHz Total(E2-YZ), Max= 2.51dBi

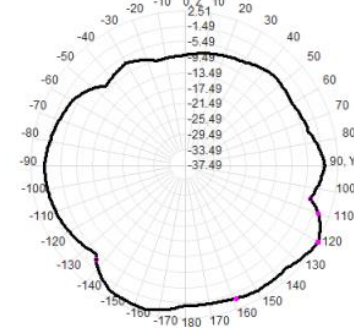

Total(H-XY), Max= -0.87dBi, CirD=8.90

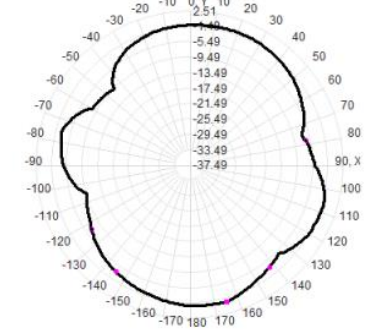

2435.0MHz H+V, Eff: 54.4%

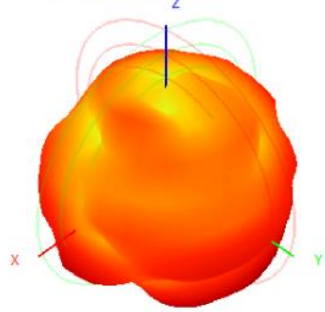

Back View

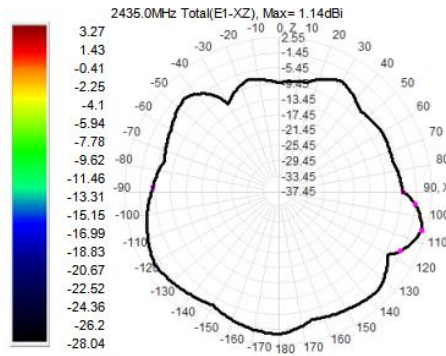
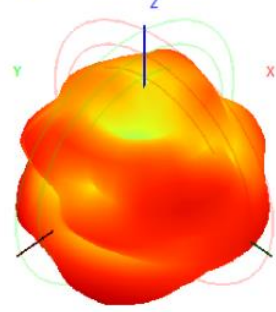

2435.0MHz Total(E2-YZ), Max= 2.55dBi

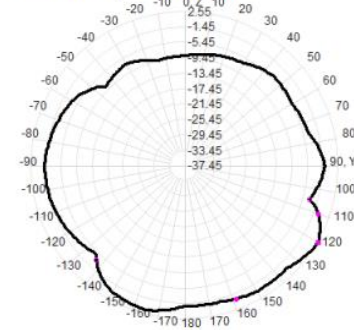

Total(H-XY), Max= -0.80dBi, CirD=9.15

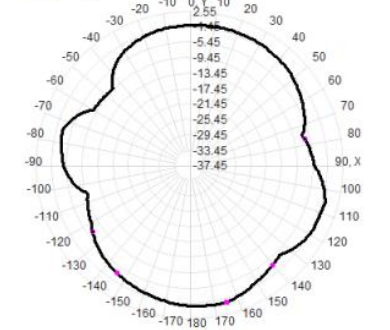

2440.0MHz H+V, Eff: 53.7%

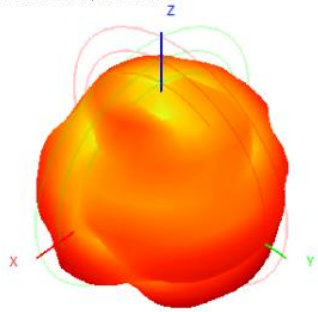

Back View

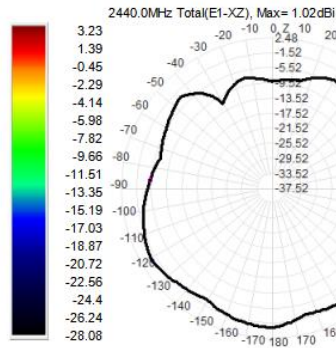
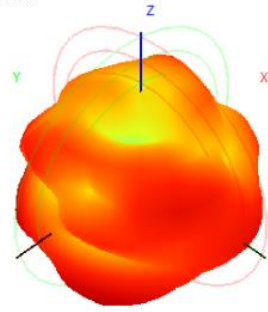

2440.0MHz Total(E2-YZ), Max= 2.48dBi

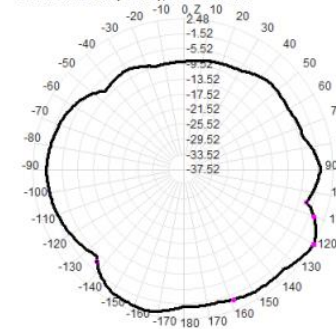

Total(H-XY), Max= -0.86dBi, CirD=9.11

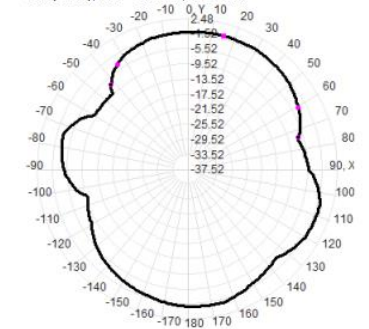

2445.0MHz H+V, Eff: 65.9%

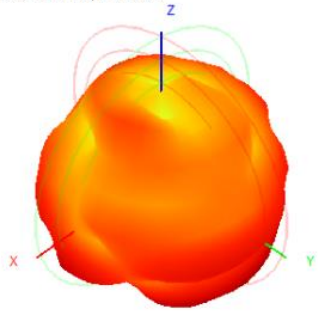

Back View

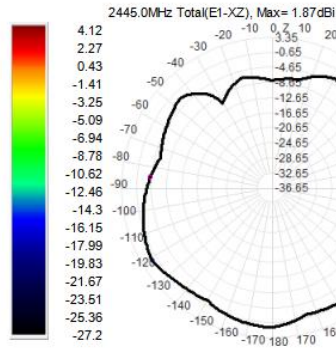
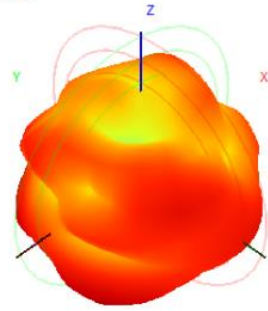

2445.0MHz Total(E2-YZ), Max= 3.35dBi

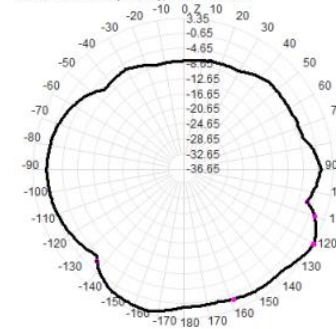

Total(H-XY), Max= 0.09dBi, CirD=9.07

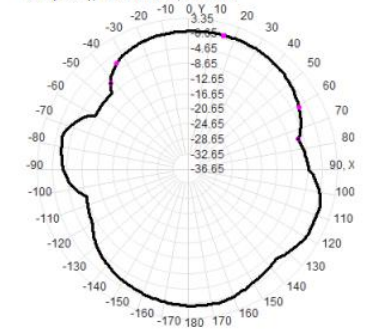

2450.0MHz H+V, Eff: 65.4%

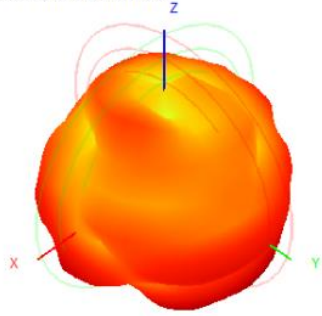

Back View

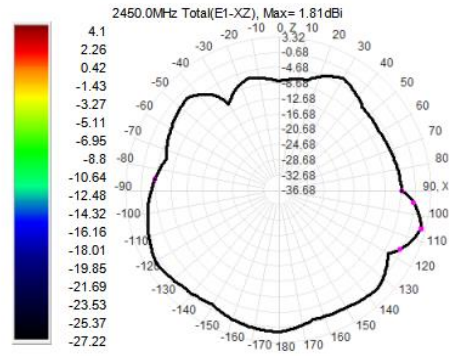
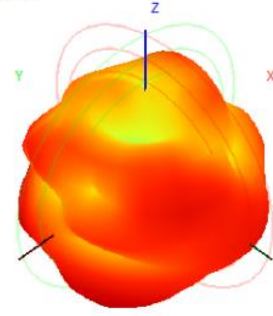

2450.0MHz Total(E2-YZ), Max= 3.32dBi

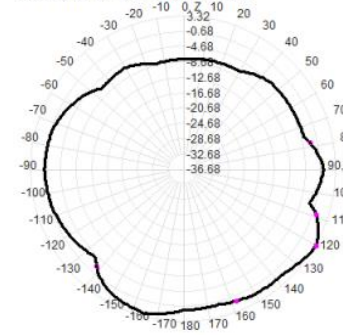

Total(H-XY), Max= 0.12dBi, CirD=9.11

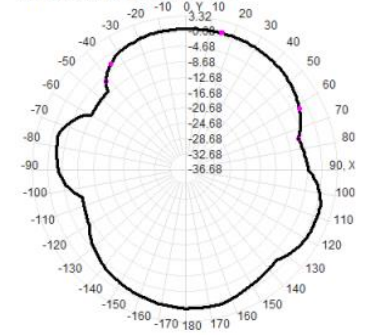

2455.0MHz H+V, Eff: 64.9%

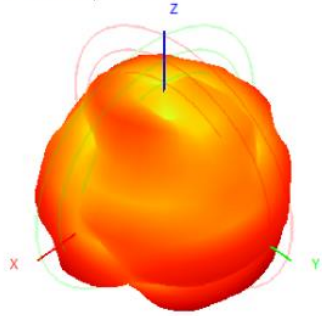

Back View

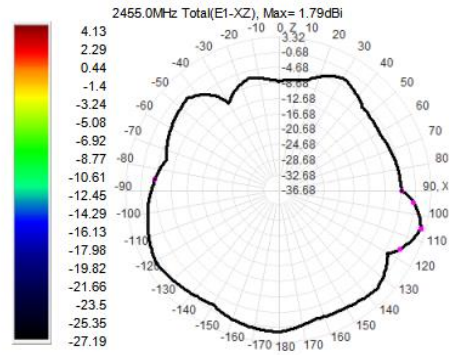
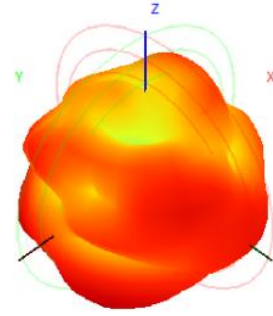

2455.0MHz Total(E2-YZ), Max= 3.32dBi

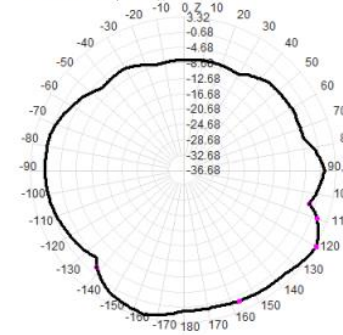

Total(H-XY), Max= 0.18dBi, CirD=9.35

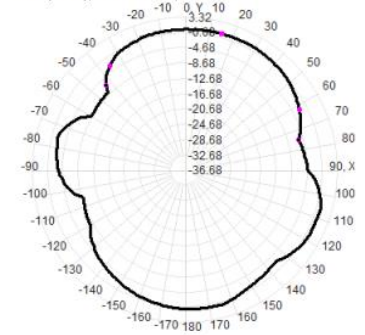

2460.0MHz H+V, Efr: 64.3%

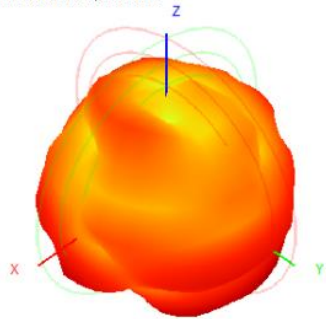

Back View

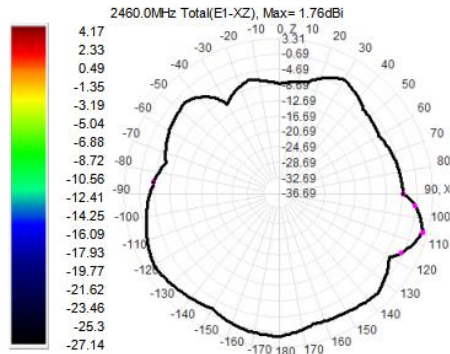
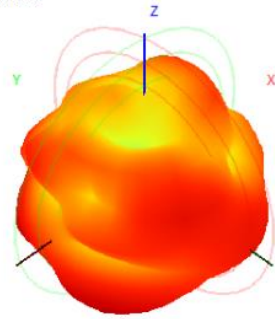

2460.0MHz Total(E2-YZ), Max= 3.31dBi

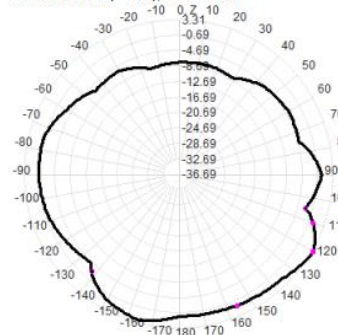

Total(H-XY), Max= 0.19dBi, CirD=9.65

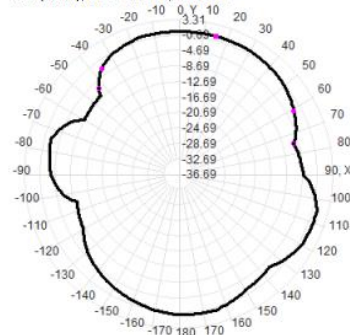

2465.0MHz H+V, Efr: 63.9%

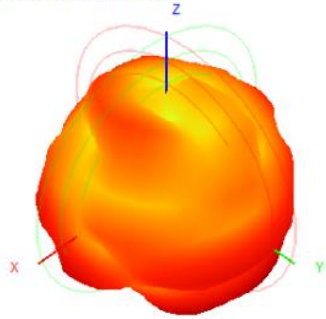

Back View

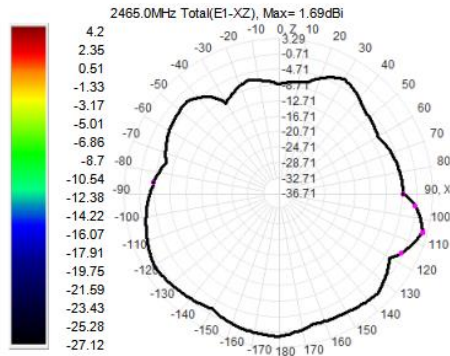
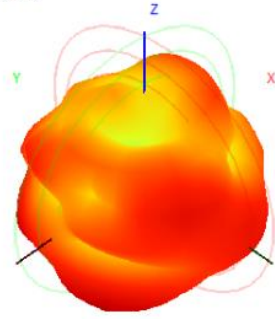

2465.0MHz Total(E2-YZ), Max= 3.29dBi

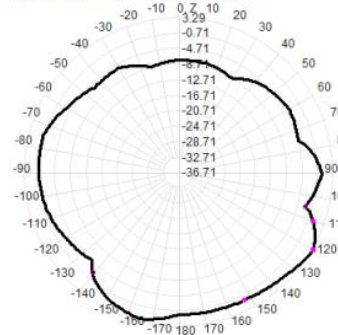

Total(H-XY), Max= 0.25dBi, CirD=9.84

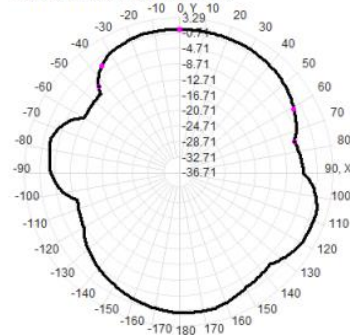

2470.0MHz H+V, Eff: 64.1%

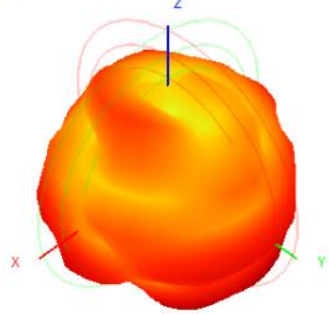

Back View

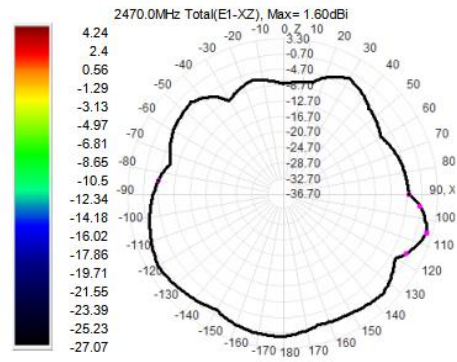
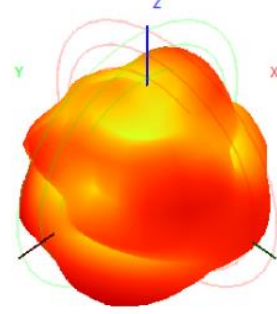

2470.0MHz Total(E2-YZ), Max= 3.30dBi

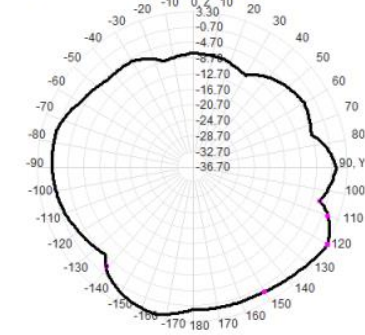

Total(H-XY), Max= 0.31dBi, CirD=9.90

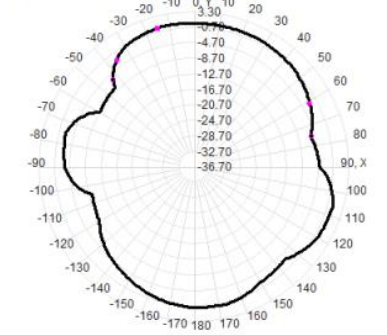

2475.0MHz H+V, Eff: 63.9%

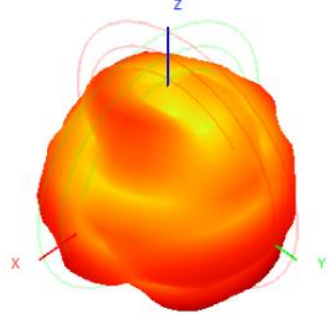

Back View

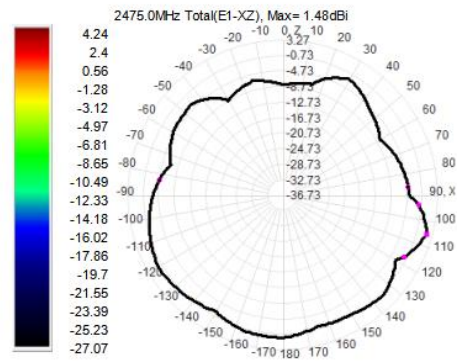
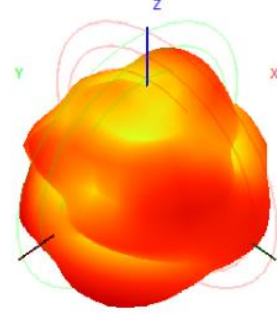

2475.0MHz Total(E2-YZ), Max= 3.27dBi

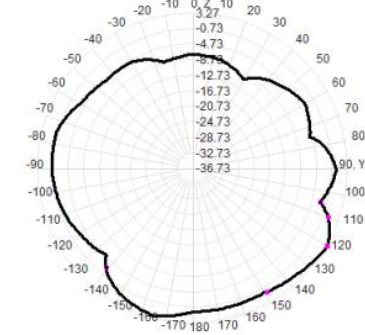

Total(H-XY), Max= 0.35dBi, CirD=10.00

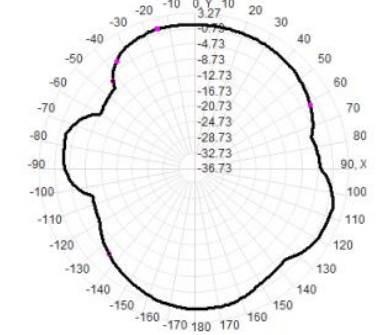

2480.0MHz H+V, Eff: 64.2%

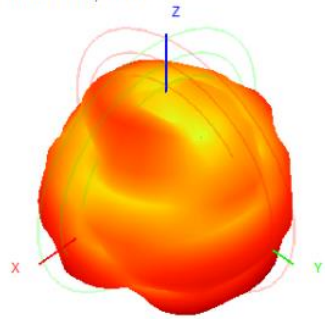

Back View

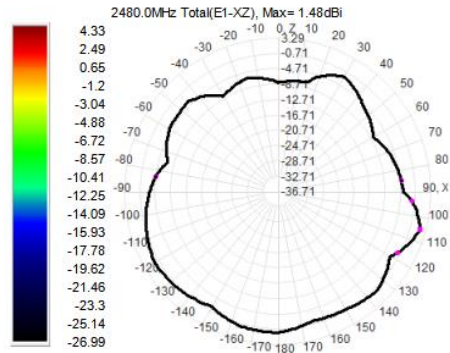
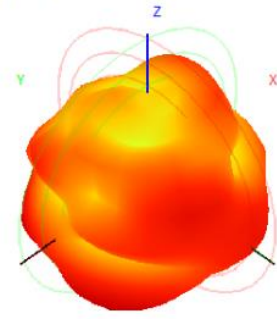

2480.0MHz Total(E2-YZ), Max= 3.29dBi

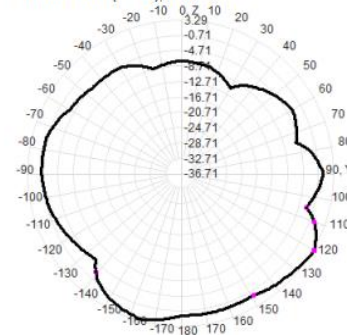

Total(H-XY), Max= 0.46dBi, CirD=10.29

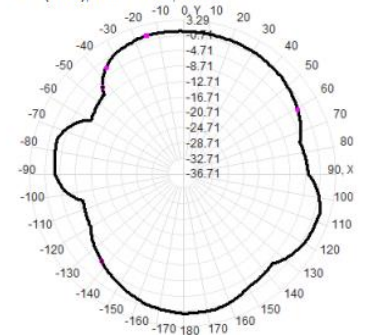

2485.0MHz H+V, Eff: 65.1%

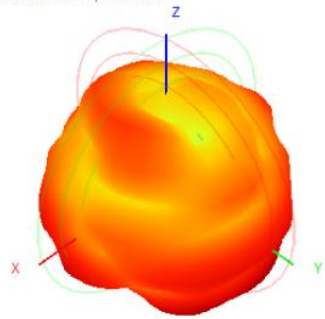

Back View

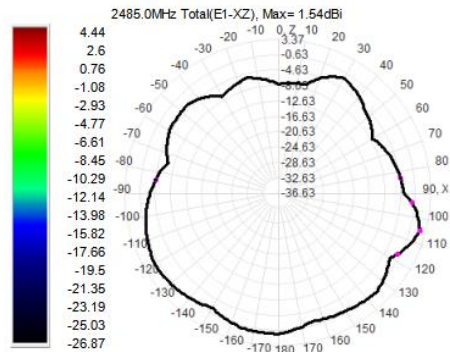
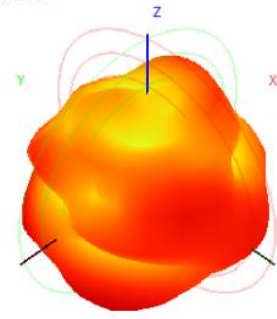

2485.0MHz Total(E2-YZ), Max= 3.37dBi

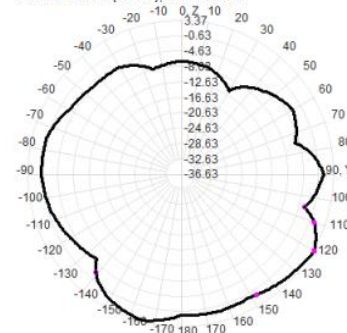

Total(H-XY), Max= 0.60dBi, CirD=10.64

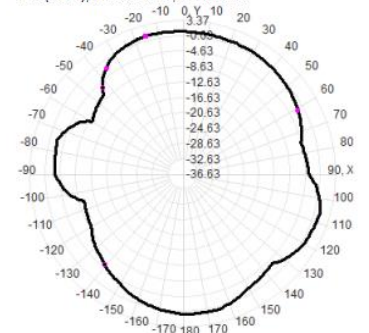

2490.0MHz H+V, Eff: 65.6%

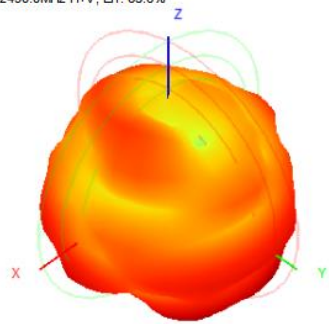

Back View

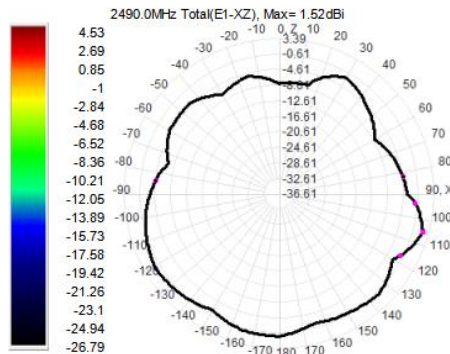
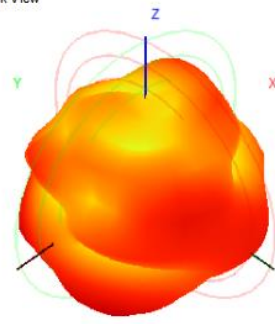

2490.0MHz Total(E2-YZ), Max= 3.39dBi

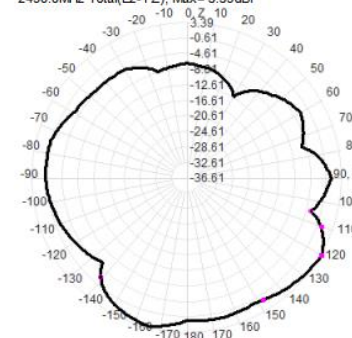

Total(H-XY), Max= 0.65dBi, CirD=10.85

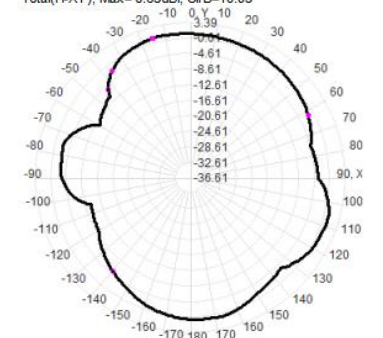

2495.0MHz H+V, Eff: 65.0%

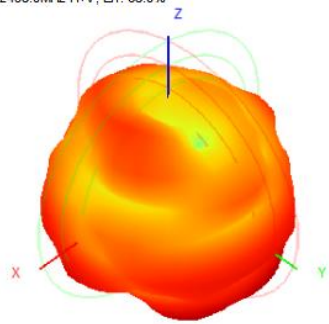

Back View

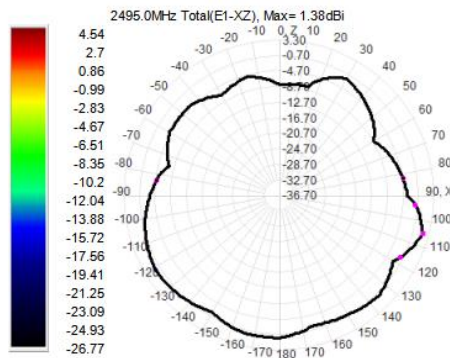
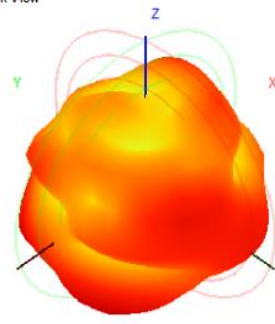

2495.0MHz Total(E2-YZ), Max= 3.30dBi

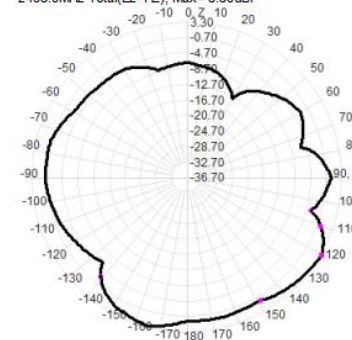

Total(H-XY), Max= 0.56dBi, CirD=10.86

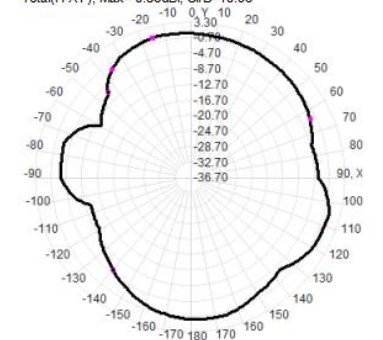

2500.0MHz H+V, Eff: 65.6%

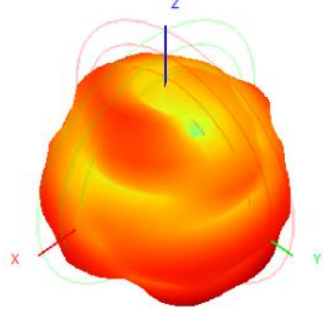

Back View

