

# FCC REPORT

## (LTE)

**Applicant:** JAINA MARKETING & ASSOCIATES

**Address of Applicant:** D- 170, Okhla Industrial Area, Phase - I New Delhi - 110020  
India

**Equipment Under Test (EUT)**

Product Name: Mobile Phone

Model No.: K9 Smart Plus 2GB, K9 Smart Plus

Trade mark: Karbonn

**FCC ID:** 2AFEWK9SMARTPLUS2GB

**Applicable standards:** FCC CFR Title 47 Part 2  
FCC CFR Title 47 Part 22 Subpart H

**Date of sample receipt:** 13 Jul., 2018

**Date of Test:** 16 Jul., to 25 Jul., 2018

**Date of report issued:** 26 Jul., 2018

**Test Result:** PASS\*

\*In the configuration tested, the EUT complied with the standards specified above.

Authorized Signature:



Bruce Zhang  
Laboratory Manager

This report details the results of the testing carried out on one sample. The results contained in this test report do not relate to other samples of the same product and does not permit the use of the CCIS product certification mark. The manufacturer should ensure that all products in series production are in conformity with the product sample detailed in this report.

This report may only be reproduced and distributed in full. If the product in this report is used in any configuration other than that detailed in the report, the manufacturer must ensure the new system complies with all relevant standards.

This document cannot be reproduced except in full, without prior written approval of the Company. Any unauthorized alteration, forgery or falsification of the content or appearance of this document is unlawful, and offenders may be prosecuted to the fullest extent of the law. Unless otherwise stated the results shown in this test report refer only to the sample(s) tested and such sample(s) are retained for 90 days only.

## 2. Version

Version No.	Date	Description
00	26 Jul., 2018	Original

**Tested by:**

*Carrey Chen*

**Date:**

26 Jul., 2018

\_\_\_\_\_  
**Test Engineer**

**Reviewed by:**

*Wimer Zhang*

**Date:**

26 Jul., 2018

\_\_\_\_\_  
**Project Engineer**

## 3. Contents

	Page
<b>1. COVER PAGE</b> .....	<b>1</b>
<b>2. VERSION</b> .....	<b>2</b>
<b>3. CONTENTS</b> .....	<b>3</b>
<b>4. TEST SUMMARY</b> .....	<b>4</b>
<b>5. GENERAL INFORMATION</b> .....	<b>5</b>
5.1 CLIENT INFORMATION.....	5
5.2 GENERAL DESCRIPTION OF E.U.T.....	5
5.3 TEST ENVIRONMENT AND MODE.....	7
5.4 DESCRIPTION OF SUPPORT UNITS.....	7
5.5 MEASUREMENT UNCERTAINTY.....	7
5.6 RELATED SUBMITTAL(S) / GRANT (S).....	7
5.7 LABORATORY FACILITY.....	7
5.8 LABORATORY LOCATION.....	8
5.9 TEST INSTRUMENTS LIST.....	8
<b>6. TEST RESULTS</b> .....	<b>9</b>
6.1 CONDUCTED OUTPUT POWER.....	9
6.2 PEAK-TO-AVERAGE RATIO.....	12
6.3 OCCUPY BANDWIDTH.....	15
6.4 OUT OF BAND EMISSION AT ANTENNA TERMINALS.....	25
6.5 ERP, EIRP MEASUREMENT.....	50
6.6 FIELD STRENGTH OF SPURIOUS RADIATION MEASUREMENT.....	54
6.7 FREQUENCY STABILITY V.S. TEMPERATURE MEASUREMENT.....	59
6.8 FREQUENCY STABILITY V.S. VOLTAGE MEASUREMENT.....	61
<b>7 TEST SETUP PHOTO</b> .....	<b>63</b>
<b>8 EUT CONSTRUCTIONAL DETAILS</b> .....	<b>64</b>

## 4. Test Summary

Test Items	Section in CFR 47	Result
RF Exposure (SAR)	Part 1.1307 Part 2.1093	Passed (Please refer to SAR Report)
RF Output Power	Part 2.1046 Part 22.913 (a)(2)	Pass
Peak-to-Average Ratio	Part 24.232 (d)	Pass
Modulation Characteristics	Part 2.1047	Pass
99% & -26 dB Occupied Bandwidth	Part 2.1049 Part 22.917(b)	Pass
Spurious Emissions at Antenna Terminal	Part 2.1051 Part 22.917(a)	Pass
Field Strength of Spurious Radiation	Part 2.1053 Part 22.917(a)	Pass
Out of band emission, Band Edge	Part 22.917(a)	Pass
Frequency stability vs. temperature	Part 22.355 Part 2.1055(a)(1)(b)	Pass
Frequency stability vs. voltage	Part 22.355 Part 2.1055(d)(2)	Pass

*Pass: The EUT complies with the essential requirements in the standard.*

## 5. General Information

### 5.1 Client Information

Applicant:	JAINA MARKETING & ASSOCIATES
Address:	D- 170, Okhla Industrial Area, Phase - I New Delhi - 110020 India
Manufacturer:	VSUN MOBILE PVT LTD
Address:	PLOT NO. 2 , N. H. NO. 8, ICD BAWAL, SECTOR - 8, BAWAL, DISTRICT - REWARI, HARYANA, India

### 5.2 General Description of E.U.T.

Product Name:	Mobile Phone
Model No.:	K9 Smart Plus 2GB, K9 Smart Plus
Operation Frequency range:	LTE Band 5: 824MHz-849MHz, RX: 869MHz-894MHz
Modulation type:	QPSK, 16QAM
Antenna type:	Internal Antenna
Antenna gain:	LTE Band 5: 1.2dBi
Power supply:	Rechargeable Li-ion Battery DC3.85V-2800mAh
AC adapter:	Model: UT-051A-5100 Input: AC100-240V, 50/60Hz, 0.2A Output: DC 5.0V, 1000mA
Remark:	The No.: K9 Smart Plus 2GB, K9 Smart Plus were identical inside, the electrical circuit design, layout, components used and internal wiring, with difference being model name different only.

**Operation Frequency List:**

LTE Band 5 (1.4MHz)		LTE Band 5 (3MHz)	
Channel	Frequency (MHz)	Channel	Frequency (MHz)
20407	824.70	20415	825.50
20408	824.80	20416	825.60
....	....	....	....
20524	836.40	20524	836.40
20525	836.50	20525	836.50
20526	836.60	20526	836.60
...	...	...	...
20642	848.20	20634	847.40
20643	848.30	20635	847.50
LTE Band 5 (5MHz)		LTE Band 5 (10MHz)	
Channel	Frequency (MHz)	Channel	Frequency (MHz)
20425	826.50	20450	829.00
20426	826.60	20451	829.10
....	....	....	....
20524	836.40	20524	836.40
20525	836.50	20525	836.50
20526	836.60	20526	836.60
...	...	...	...
20624	846.40	20599	839.90
20625	846.50	20600	844.00

Regards to the operating frequency range, the lowest frequency, the middle frequency, and the highest frequency of channel were selected to perform the test, and the selected channels as below:

LTE Band 5 (1.4MHz)			LTE Band 5 (3MHz)		
Channel:		Frequency (MHz)	Channel		Frequency (MHz)
Lowest channel	20407	824.70	Lowest channel	20415	825.50
Middle channel	20525	836.50	Middle channel	20525	836.50
Highest channel	20643	848.30	Highest channel	20635	847.50
LTE Band 5 (5MHz)			LTE Band 5 (10MHz)		
Channel		Frequency (MHz)	Channel		Frequency (MHz)
Lowest channel	20425	826.50	Lowest channel	20450	829.00
Middle channel	20525	836.50	Middle channel	20525	836.50
Highest channel	20625	846.50	Highest channel	20600	844.00

### 5.3 Test environment and mode

Operating Environment:	
Temperature:	Normal: 15°C ~ 35°C, Extreme: -30°C ~ +50°C
Humidity:	20 % ~ 75 % RH
Atmospheric Pressure:	1008 mbar
Voltage:	Nominal: 3.85Vdc, Extreme: Low 3.5Vdc, High 4.4Vdc
Test mode:	
LTE QPSK mode	Keep the EUT communication with simulated station in QPSK mode
LTE 16-QAM mode	Keep the EUT communication with simulated station in 16-QAM mode
Remark: The EUT has been tested under continuous transmitting mode. Channel Low, Mid and High for each type band with rated data rate were chosen for full testing. The field strength of spurious radiation emission was measured as EUT stand-up position (H mode) and lie down position (E1, E2 mode) for these modes with power adaptor, earphone and Data cable. Just the worst case position (H mode) shown in report.	

### 5.4 Description of Support Units

Test Equipment	Manufacturer	Model No.	Serial No.
Simulated Station	Anritsu	MT8820C	6201026545

### 5.5 Measurement Uncertainty

Parameters	Expanded Uncertainty
Radiated Emission (9kHz ~ 30MHz)	±2.76 dB (k=2)
Radiated Emission (30MHz ~ 1000MHz)	±4.28 dB (k=2)
Radiated Emission (1GHz ~ 18GHz)	±5.72 dB (k=2)
Radiated Emission (18GHz ~ 40GHz)	±2.88 dB (k=2)

### 5.6 Related Submittal(s) / Grant (s)

This is an original grant, no related submittals and grants.
--

### 5.7 Laboratory Facility

<p>The test facility is recognized, certified, or accredited by the following organizations:</p> <ul style="list-style-type: none"> <li>● <b>FCC - Registration No.: 727551</b> Shenzhen Zhongjian Nanfang Testing Co., Ltd. has been accredited as a testing laboratory by FCC (Federal Communications Commission). The Registration No. is 727551.</li> <li>● <b>IC - Registration No.: 10106A-1</b> The 3m Semi-anechoic chamber of Shenzhen Zhongjian Nanfang Testing Co., Ltd. has been Registered by Certification and Engineering Bureau of Industry Canada for radio equipment testing with Registration No.: 10106A-1.</li> <li>● <b>CNAS - Registration No.: CNAS L6048</b> Shenzhen Zhongjian Nanfang Testing Co., Ltd. is accredited to ISO/IEC 17025:2005 General Requirements for the Competence of Testing and Calibration laboratories for the competence of testing. The Registration No. is CNAS L6048.</li> <li>● <b>A2LA - Registration No.: 4346.01</b> This laboratory is accredited in accordance with the recognized International Standard ISO/IEC 17025:2005 General requirements for the competence of testing and calibration laboratories. The test scope can be found as below link: <a href="https://portal.a2la.org/scopepdf/4346-01.pdf">https://portal.a2la.org/scopepdf/4346-01.pdf</a></li> </ul>
---

## 5.8 Laboratory Location

Shenzhen Zhongjian Nanfang Testing Co., Ltd.  
 Address: No. B-C, 1/F., Building 2, Laodong No.2 Industrial Park, Xixiang Road,  
 Bao'an District, Shenzhen, Guangdong, China  
 Tel: +86-755-23118282, Fax: +86-755-23116366  
 Email: info@ccis-cb.com, Website: http://www.ccis-cb.com

## 5.9 Test Instruments list

Test Equipment	Manufacturer	Model No.	Serial No.	Cal. Date (mm-dd-yy)	Cal. Due date (mm-dd-yy)
3m SAC	SAEMC	9m*6m*6m	966	07-22-2017	07-21-2020
BiConiLog Antenna	SCHWARZBECK	VULB9163	497	03-16-2018	03-15-2019
Biconical Antenna	SCHWARZBECK	VUBA9117	359	06-22-2017	06-21-2020
Horn Antenna	SCHWARZBECK	BBHA9120D	916	03-16-2018	03-15-2019
Horn Antenna	SCHWARZBECK	BBHA9120D	1805	06-22-2017	06-21-2020
EMI Test Software	AUDIX	E3	6.110919b	N/A	N/A
Pre-amplifier	HP	8447D	2944A09358	03-07-2018	03-06-2019
Pre-amplifier	CD	PAP-1G18	11804	03-07-2018	03-06-2019
Spectrum analyzer	Rohde & Schwarz	FSP30	101454	03-07-2018	03-06-2019
EMI Test Receiver	Rohde & Schwarz	ESRP7	101070	03-07-2018	03-06-2019
Spectrum Analyzer	Agilent	N9020A	MY50510123	10-29-2017	10-28-2018
Signal Generator	Rohde & Schwarz	SMX	835454/016	03-07-2018	03-06-2019
Signal Generator	R&S	SMR20	1008100050	03-07-2018	03-06-2019
RF Switch Unit	MWRFTST	MW200	N/A	N/A	N/A
Cable	ZDECL	Z108-NJ-NJ-81	1608458	03-07-2018	03-06-2019
Cable	MICRO-COAX	MFR64639	K10742-5	03-07-2018	03-06-2019
Cable	SUHNER	SUCOFLEX100	58193/4PE	03-07-2018	03-06-2019
DC Power Supply	XinNuoEr	WYK-10020K	1409050110020	10-31-2017	10-30-2018
Temperature Humidity Chamber	HengPu	HPGDS-500	20140828008	09-24-2017	09-23-2018
Simulated Station	Rohde & Schwarz	CMW500	140493	06-24-2018	06-23-2019



## 6. Test results

### 6.1 Conducted Output Power

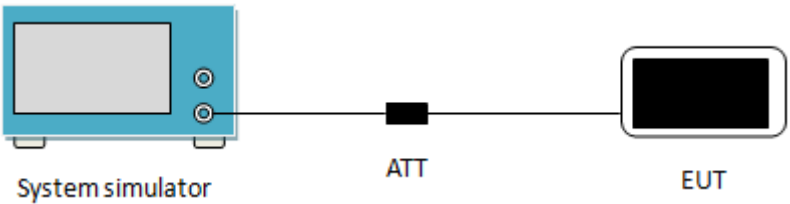
Test Requirement:	Part 22.913(a)(2)
Test Method:	ANSI/TIA-603-D 2010
Limit:	LTE Band 5: 7W
Test Setup:	 <p>The diagram illustrates the test setup. On the left is a blue 'System simulator' with a screen and two ports. A line connects it to a black 'ATT' (attenuator) block. Another line connects the 'ATT' to a black 'EUT' (Equipment Under Test) device.</p>
Test Procedure:	The transmitter output was connected to a calibrated attenuator, the other end of which was connected to the CMW500. Transmitter output power was read off in dBm.
Test Instruments:	Refer to section 5.9 for details
Test mode:	Refer to section 5.3 for details
Test results:	Passed

**Measurement Data:**

LTE Band	Bandwidth (MHz)	Modulation	RB Size	RB Offset	Average Power (dBm)		
					20407	20525	20643
					824.7MHz	836.5MHz	848.3MHz
5	1.4	QPSK	1	0	22.30	22.24	22.27
			1	2	22.48	22.42	22.17
			1	5	22.29	22.37	22.28
			3	0	22.46	22.52	22.33
			3	1	22.47	22.43	22.33
			3	2	22.40	22.51	22.35
		16QAM	6	0	21.42	21.59	21.33
			1	0	21.12	21.62	21.76
			1	2	21.72	21.38	21.67
			1	5	21.36	21.49	21.29
			3	0	21.36	21.64	21.32
			3	1	21.25	21.18	21.50
			3	2	21.84	21.80	21.64
			6	0	20.38	20.36	20.40
LTE Band	Bandwidth (MHz)	Modulation	RB Size	RB Offset	Average Power (dBm)		
					20415	20525	20635
					825.5MHz	836.5MHz	847.50MHz
5	3	QPSK	1	0	22.28	22.27	22.26
			1	7	22.38	22.39	22.21
			1	14	22.46	22.55	22.34
			8	0	21.48	21.59	21.52
			8	4	21.50	21.52	21.41
			8	7	21.61	21.49	21.46
		16QAM	15	0	21.61	21.44	21.53
			1	0	21.39	21.52	21.62
			1	7	21.40	21.33	21.29
			1	14	21.62	21.43	21.27
			8	0	20.34	20.35	20.38
			8	4	20.53	20.35	20.43
			8	7	20.53	20.32	20.36
			15	0	20.55	20.70	20.57
LTE Band	Bandwidth (MHz)	Modulation	RB Size	RB Offset	Average Power (dBm)		
					20425	20525	20625
					826.5MHz	836.5MHz	846.5MHz
5	5	QPSK	1	0	22.44	22.51	22.47
			1	12	22.50	22.46	22.47
			1	24	22.34	22.24	22.54
			12	0	21.39	21.52	21.50
			12	6	21.57	21.59	21.44
			12	11	21.55	21.43	21.36
		16QAM	25	0	21.56	21.54	21.45
			1	0	21.48	21.98	21.69
			1	12	21.13	21.57	21.67
			1	24	21.71	21.52	21.83
			12	0	20.33	20.63	20.84
			12	6	20.52	20.58	20.70
			12	11	20.30	20.44	20.58
			25	0	20.51	20.55	20.68

LTE Band	Bandwidth (MHz)	Modulation	RB Size	RB Offset	Average Power (dBm)		
					20450	20525	20600
					829.0MHz	836.5MHz	844.0MHz
5	10	QPSK	1	0	22.43	22.37	22.55
			1	24	22.53	22.35	22.37
			1	49	22.42	22.15	22.46
			25	0	21.58	21.68	21.38
			25	12	22.73	21.64	21.59
			25	24	21.48	22.45	21.32
			50	0	22.48	21.28	21.49
		16QAM	1	0	21.74	21.73	21.68
			1	24	21.43	21.89	21.43
			1	49	21.91	21.14	21.67
			25	0	20.67	20.60	20.53
			25	12	20.57	20.36	21.28
			25	24	20.50	20.50	20.73
			50	0	20.65	20.37	20.52

## 6.2 Peak-to-Average Ratio

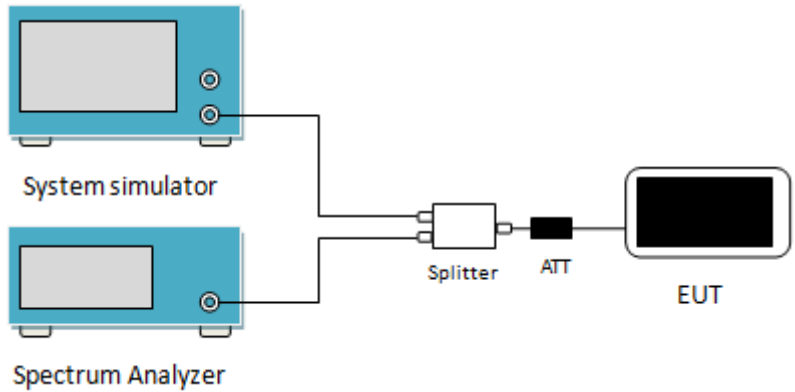
Test Requirement:	Part 24.232 (d)
Test Method:	ANSI/TIA-603-D 2010
Limit:	The peak-to-average ratio (PAR) of the transmission may not exceed 13 dB.
Test Setup:	 <p>The diagram shows a test setup for measuring Peak-to-Average Ratio (PAR). It consists of a System simulator and a Spectrum Analyzer connected to a Splitter. The Splitter is connected to an ATT (Attenuator), which is then connected to the EUT (Equipment Under Test).</p>
Test Procedure:	<ol style="list-style-type: none"> <li>1 The RF output of the transceiver was connected to a spectrum analyzer through appropriate attenuation.</li> <li>2 Set the CCDF option in spectrum analyzer, <math>RBW \geq OBW</math>,</li> <li>3 Set the EUT working in highest power level, measured and recorded the 0.1% as PAPR level.</li> <li>4 Repeat step 1~3 at other frequency and modulations.</li> </ol>
Test Instruments:	Refer to section 5.9 for details
Test mode:	Refer to section 5.3 for details
Test results:	Passed

Measurement Data (Worst case):

Bandwidth	Modulation	RB Size	RB Offset	PAPR
LTE Band 5 (Middle Channel)				
10MHz	QPSK	50	0	5.39
	16QAM	50	0	6.29

Test plots as below:

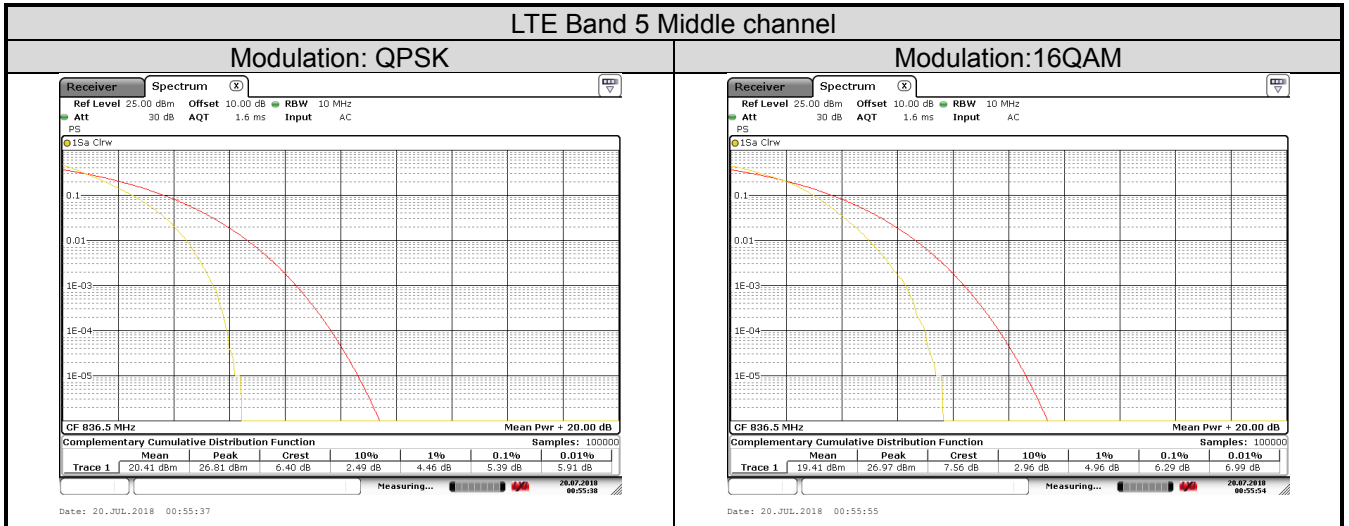

## 6.3 Occupy Bandwidth

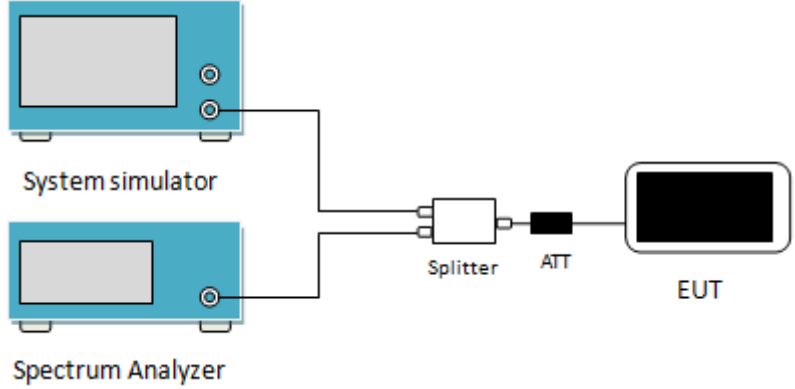
Test Requirement:	Part 22.917(b)
Test Method:	ANSI/TIA-603-D 2010
Test Setup:	 <p>The diagram illustrates the test setup. On the left, there are two blue rectangular units: the top one is labeled 'System simulator' and the bottom one is labeled 'Spectrum Analyzer'. Both have a screen and two ports on the right side. A single cable connects the two ports of the System simulator to the top port of a white 'Splitter'. Another cable connects the two ports of the Spectrum Analyzer to the bottom port of the Splitter. From the right side of the Splitter, a cable goes to a black 'ATT' (Attenuator), which is then connected to the 'EUT' (Equipment Under Test), represented by a black rectangular device with a screen.</p>
Test Procedure:	<ol style="list-style-type: none"> <li>1. The EUT's output RF connector was connected with a short cable to the spectrum analyzer</li> <li>2. RBW was set to about 1% ~ 5% of emission BW, VBW= 3 times RBW.</li> <li>3. -26dBc display line was placed on the screen (or 99% bandwidth), the occupied bandwidth is the delta frequency between the two points where the display line intersects the signal trace.</li> </ol>
Test Instruments:	Refer to section 5.9 for details
Test mode:	Refer to section 5.3 for details
Test results:	Passed

**Measurement Data:**

TE Band 5					
Bandwidth	Channel	Frequency (MHz)	Modulation	99% OBW (kHz)	-26dBcEBW (kHz)
1.4MHz	20407	824.7	16QAM	1104	1368
			QPSK	1104	1278
	20525	836.5	16QAM	1104	1314
			QPSK	1104	1290
	20643	848.3	16QAM	1098	1314
			QPSK	1104	1314
3MHz	20415	825.5	16QAM	2760	3360
			QPSK	2784	3408
	20525	836.50	16QAM	2761	3420
			QPSK	2796	3468
	20635	847.50	16QAM	2760	3396
			QPSK	2784	3444
5MHz	20425	826.50	16QAM	4500	4960
			QPSK	4520	5040
	20525	836.50	16QAM	4520	5000
			QPSK	4520	5020
	20625	846.50	16QAM	4500	4980
			QPSK	4500	5080
10MHz	20450	829.00	16QAM	9120	10320
			QPSK	9120	10560
	20525	836.50	16QAM	9120	10160
			QPSK	9120	10240
	20600	844.00	16QAM	9160	10240
			QPSK	9120	10240



Test plot as follows:  
LTE Band 5 part:

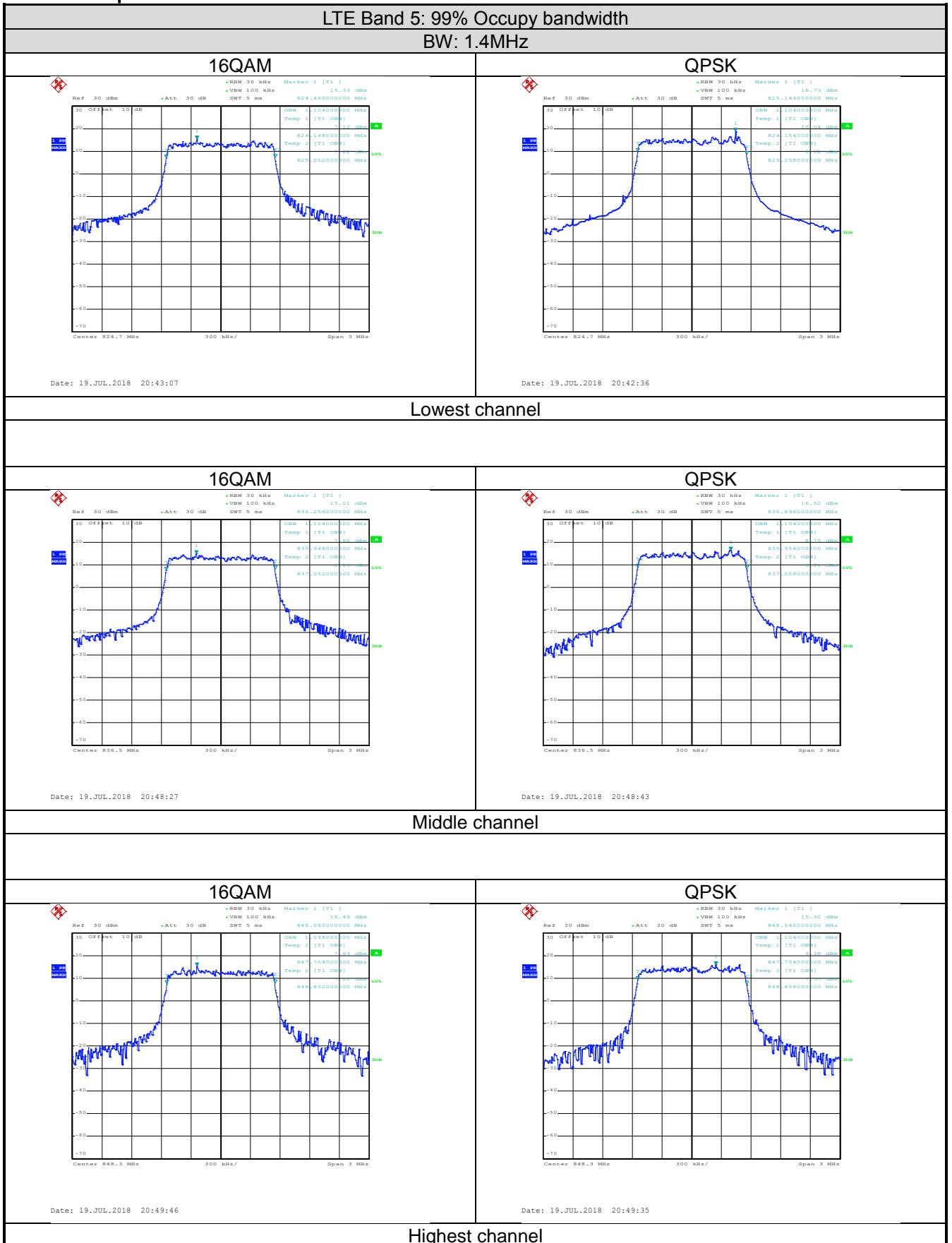

LTE Band 5: 99% Occupancy bandwidth  
 BW: 3MHz

16QAM

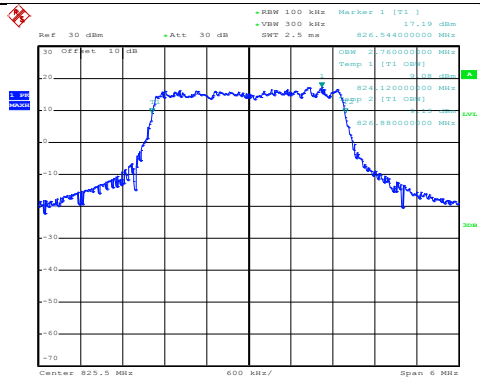

Date: 19.JUL.2018 20:53:19

QPSK

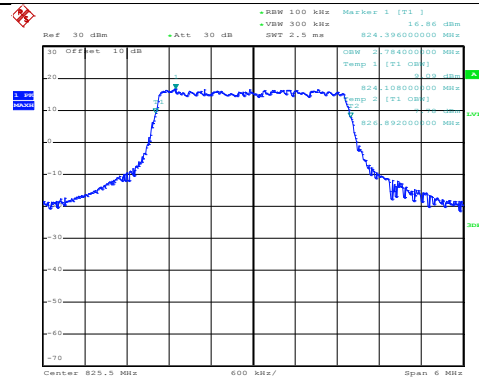

Date: 19.JUL.2018 20:52:50

Lowest channel

16QAM

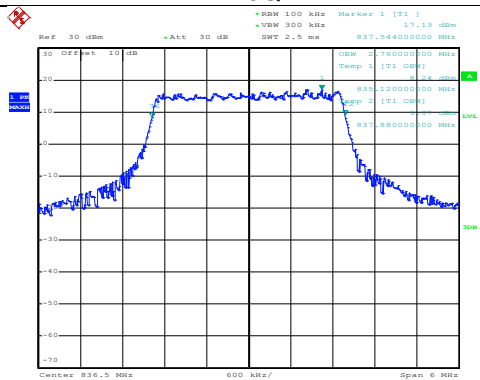

Date: 19.JUL.2018 20:57:45

QPSK

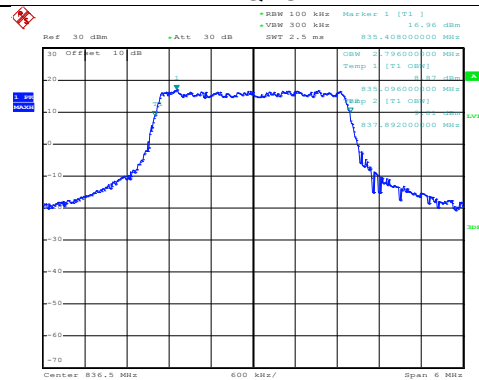

Date: 19.JUL.2018 20:57:27

Middle channel

16QAM

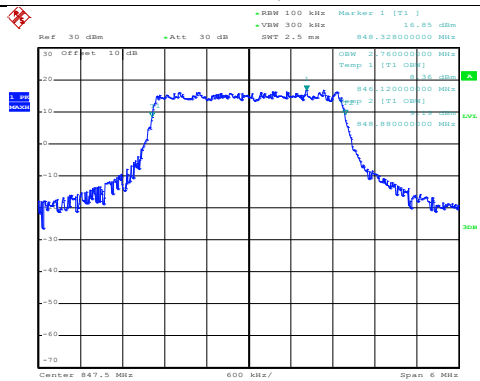

Date: 19.JUL.2018 20:59:19

QPSK

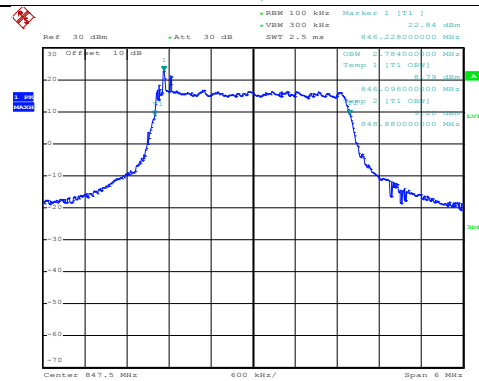

Date: 19.JUL.2018 20:58:59

Highest channel

LTE Band 5: 99% Occupancy bandwidth  
BW: 5MHz

16QAM

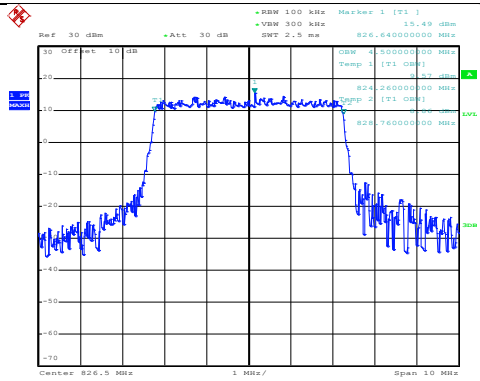

Date: 19.JUL.2018 21:38:51

QPSK

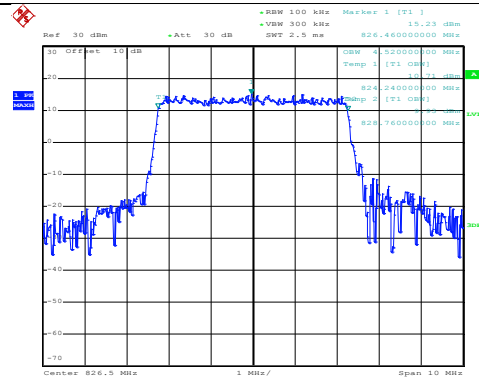

Date: 19.JUL.2018 21:38:38

Lowest channel

16QAM

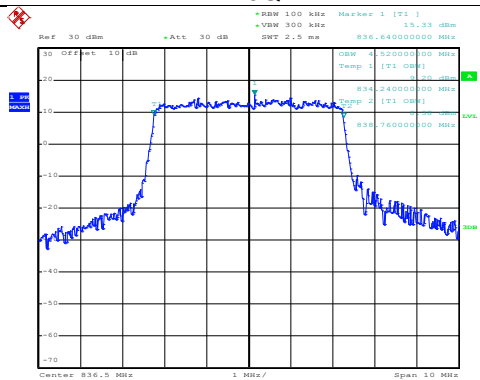

Date: 19.JUL.2018 21:41:06

QPSK

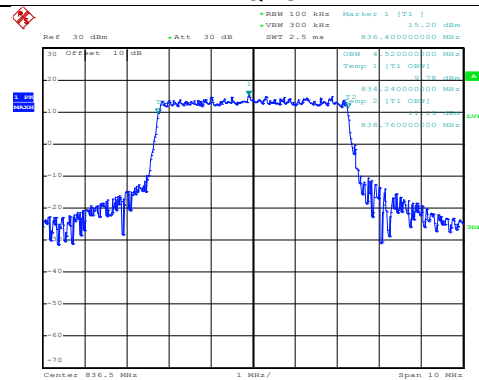

Date: 19.JUL.2018 21:41:24

Middle channel

16QAM

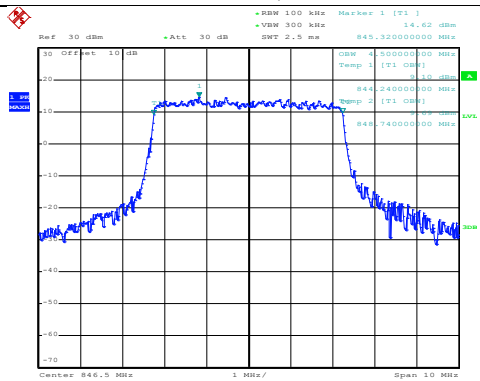

Date: 19.JUL.2018 21:42:23

QPSK

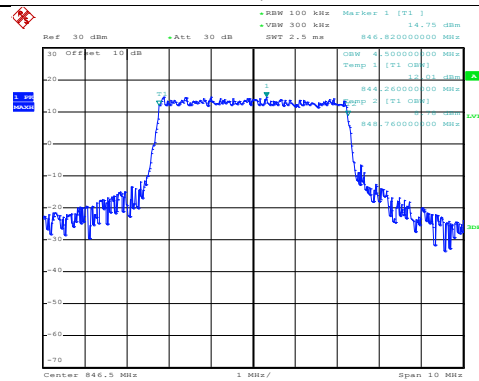

Date: 19.JUL.2018 21:42:00

Highest channel

LTE Band 5: 99% Occupancy bandwidth  
BW: 10MHz

16QAM

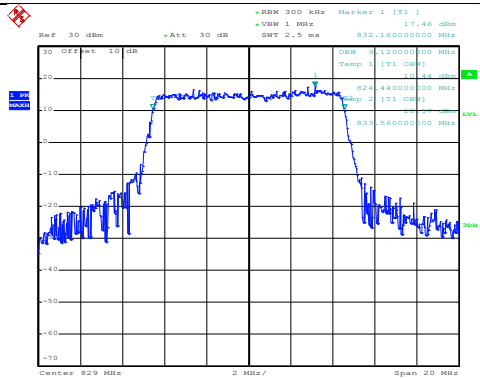

Date: 19.JUL.2018 21:35:47

QPSK

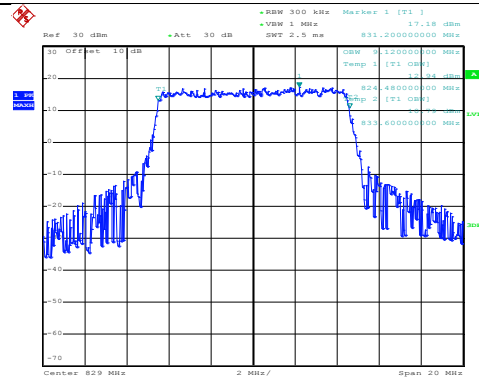

Date: 19.JUL.2018 21:35:56

Lowest channel

16QAM

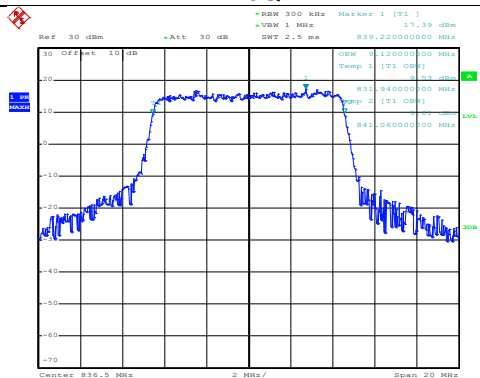

Date: 19.JUL.2018 21:36:31

QPSK

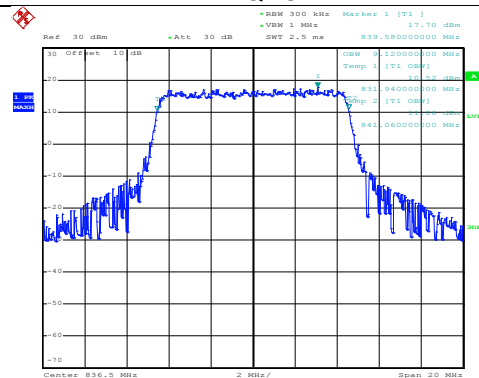

Date: 19.JUL.2018 21:36:14

Middle channel

16QAM

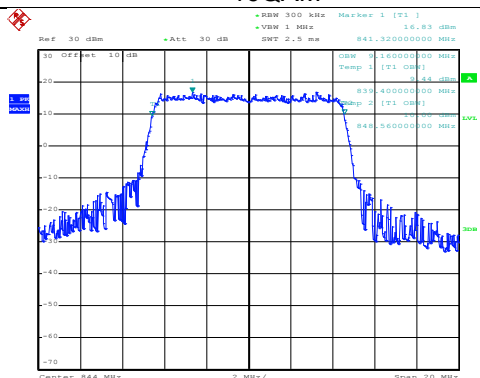

Date: 19.JUL.2018 21:37:45

QPSK

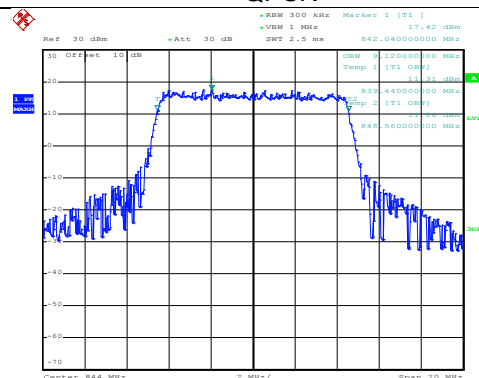

Date: 19.JUL.2018 21:37:56

Highest channel

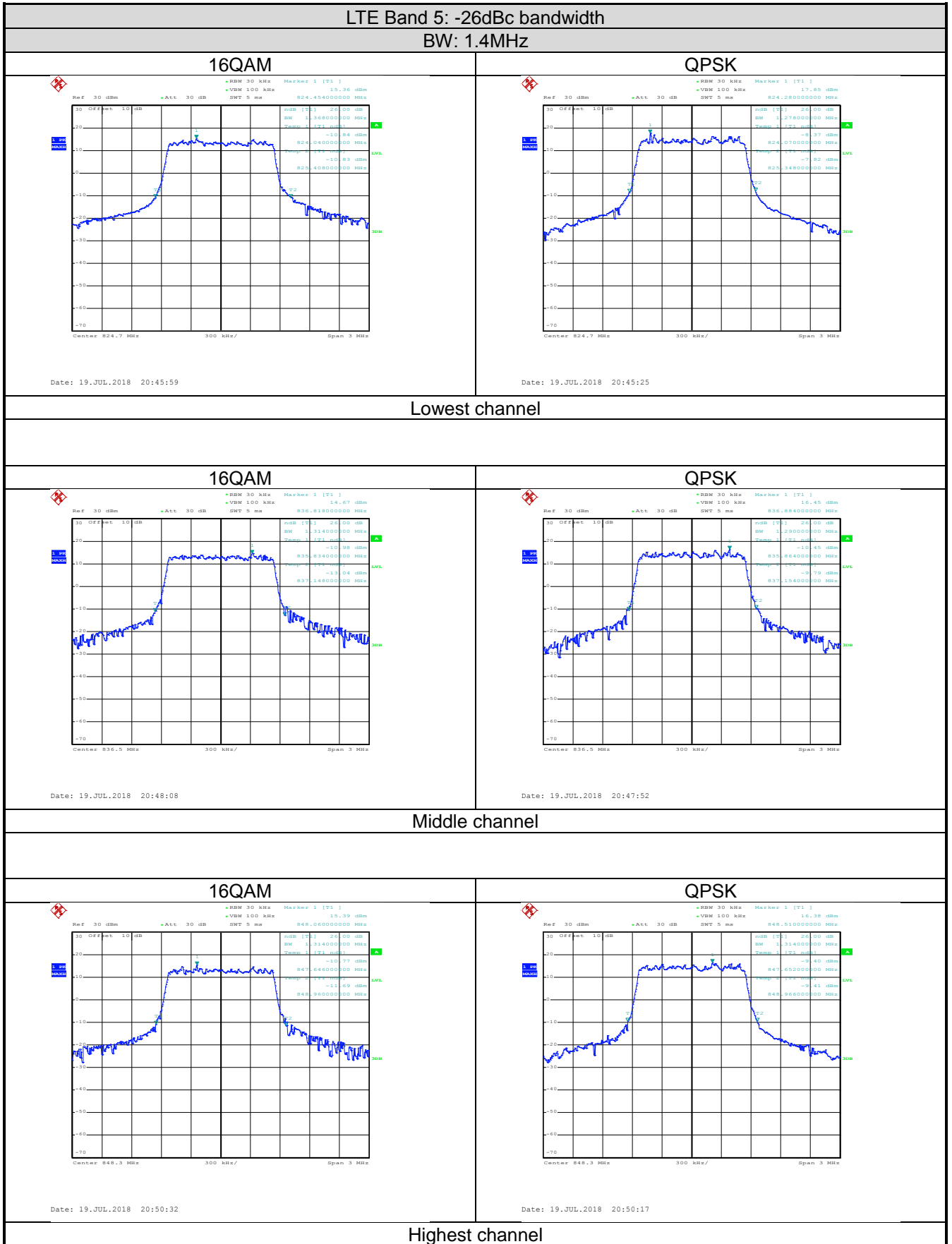

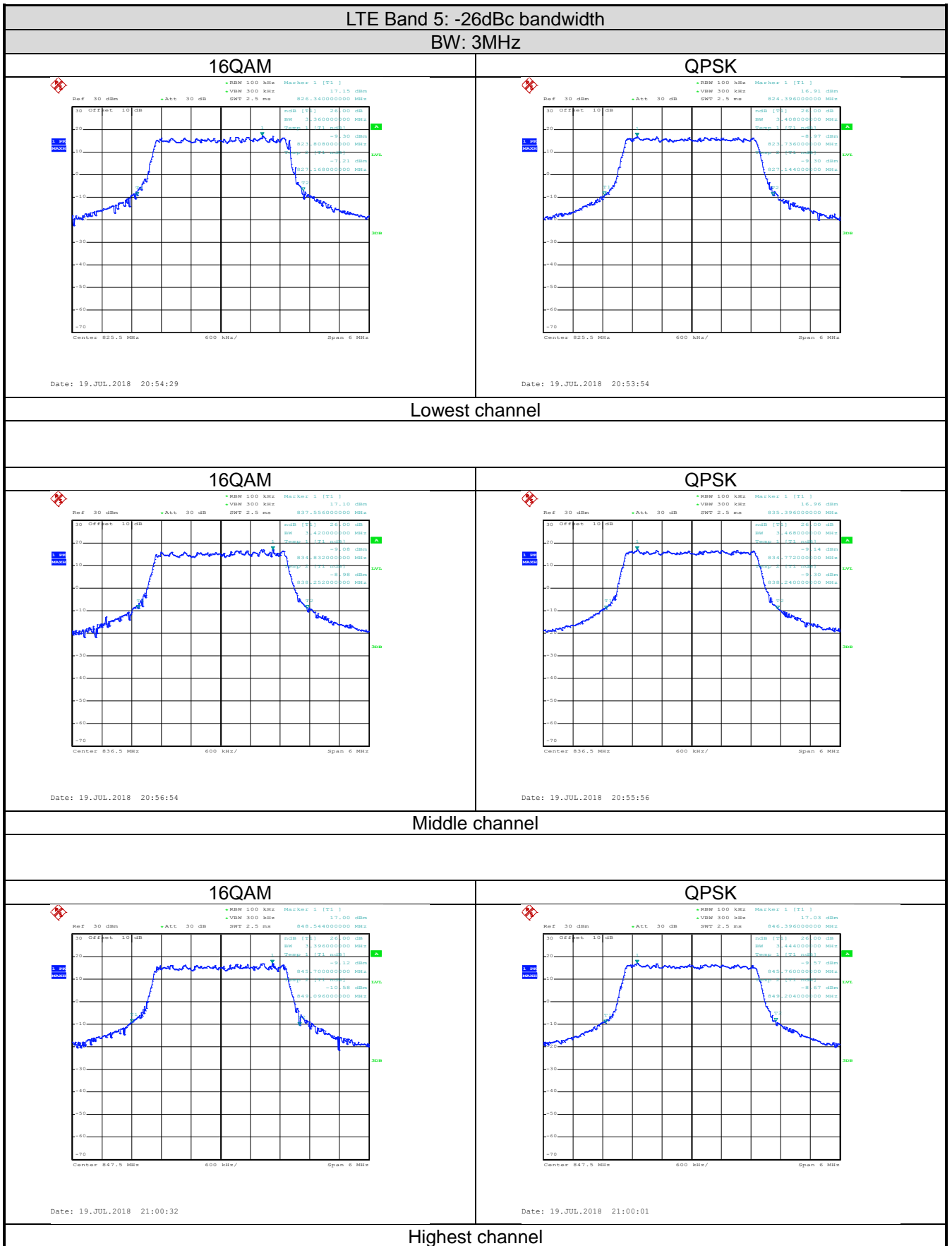

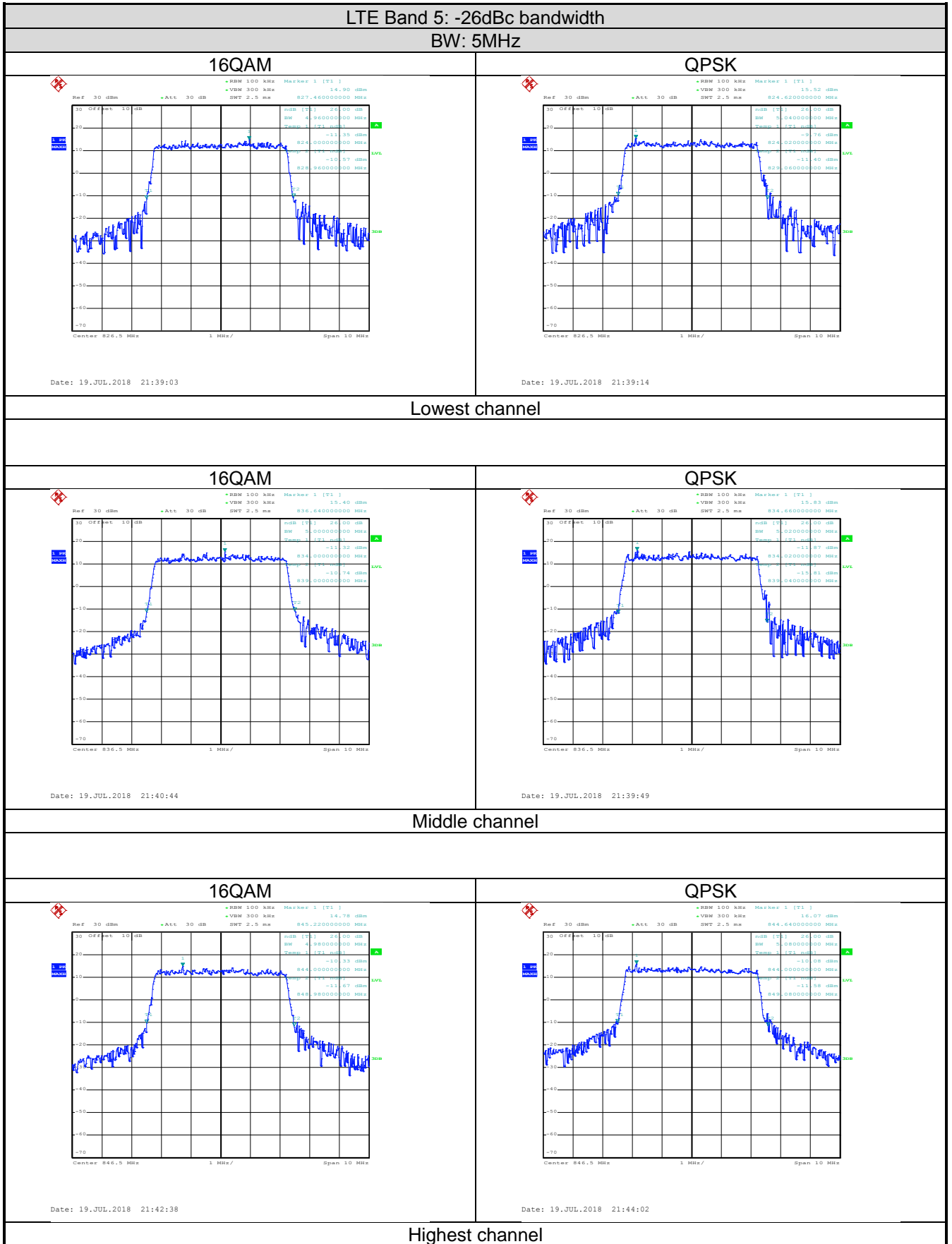

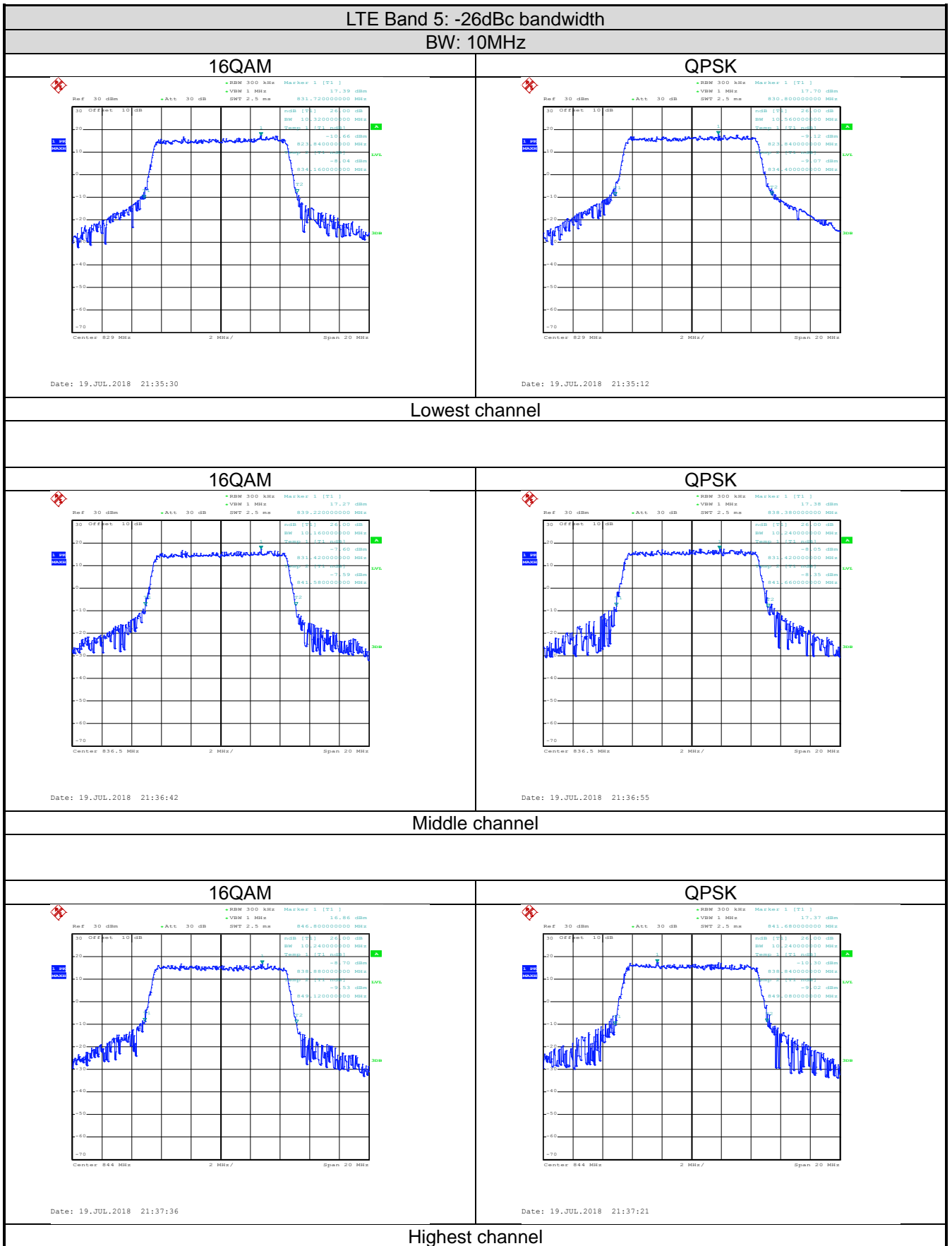



## 6.4 Out of band emission at antenna terminals

Test Requirement:	Part 22.917(b)
Test Method:	ANSI/TIA-603-D 2010
Limit:	LTE Band 5 The power of any emission outside a licensee's frequency block shall be attenuated below the transmitter power (P) in watts by at least $43 + 10 \log_{10}(P)$ dB (-13 dBm).
Test Setup:	
Test Procedure:	<ol style="list-style-type: none"> <li>1 The RF output of the transceiver was connected to a spectrum analyzer through appropriate attenuation.</li> <li>2 The resolution bandwidth of the spectrum analyzer was set at 100 kHz when below 1GHz, 1MHz when above 1 GHz; sufficient scans were taken to show the out of band Emissions if any up to 10th harmonic.</li> <li>3 For the out of band: Set the RBW=100 kHz, VBW=300 kHz when below 1 GHz, RBW =1 MHz, VBW=3 MHz when above 1 GHz, Start=30MHz, Stop= 10th harmonic.</li> <li>4 Band Edge Requirements: In the 1 MHz bands immediately outside and adjacent to the frequency block, a resolution bandwidth of at least 1 percent of the emission bandwidth of the fundamental emission of the transmitter may be employed to measure the out of band Emissions.</li> </ol>
Test Instruments:	Refer to section 5.9 for details
Test mode:	Refer to section 5.3 for details
Test results:	Passed
Remark:	Pre-scan all RB Size and offset, and found the RB Size and offset of worst case, so the report shows only the worst case test data.

Test plots as follows (Conducted spurious emission) (worst case):  
 LTE Band 5 part:

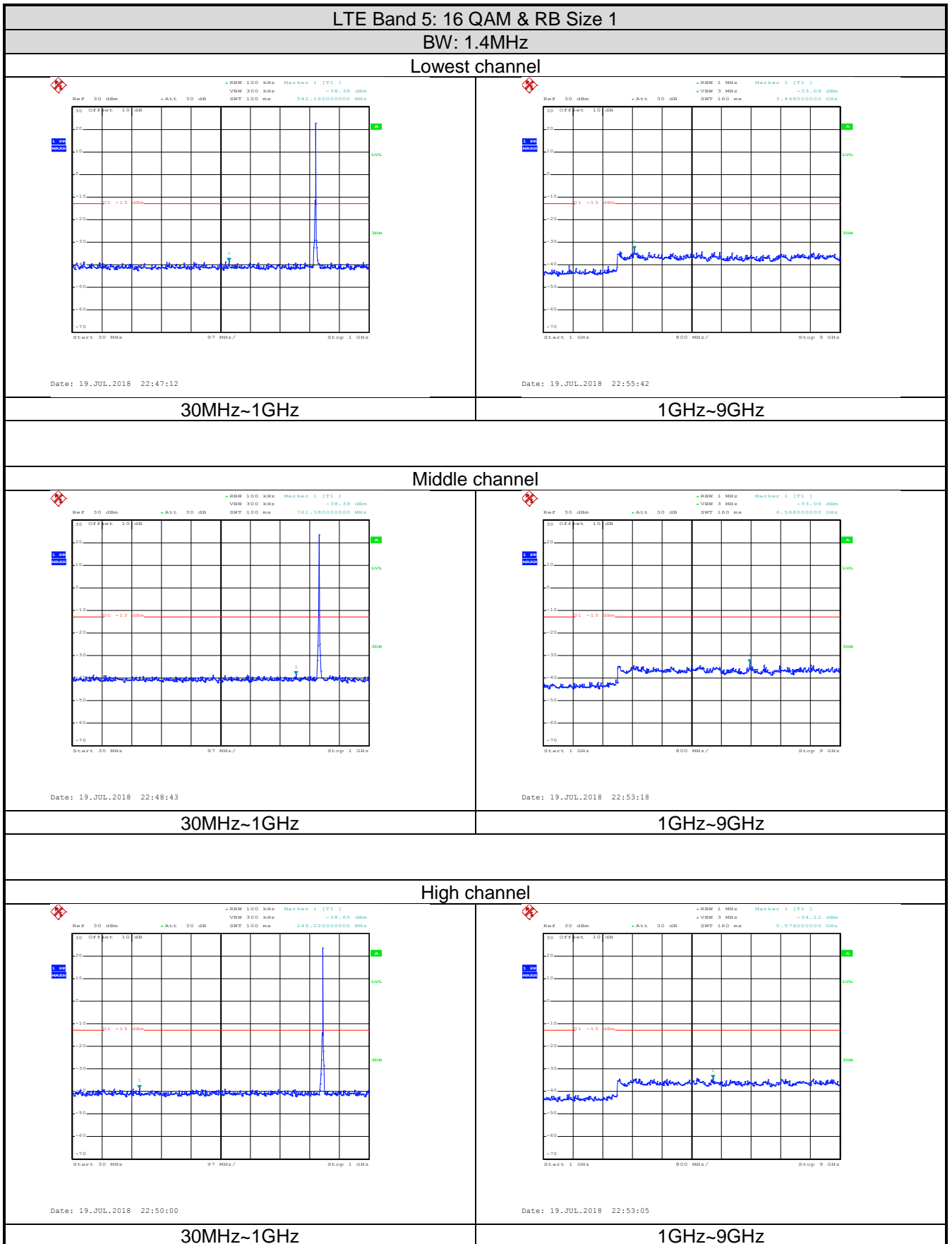

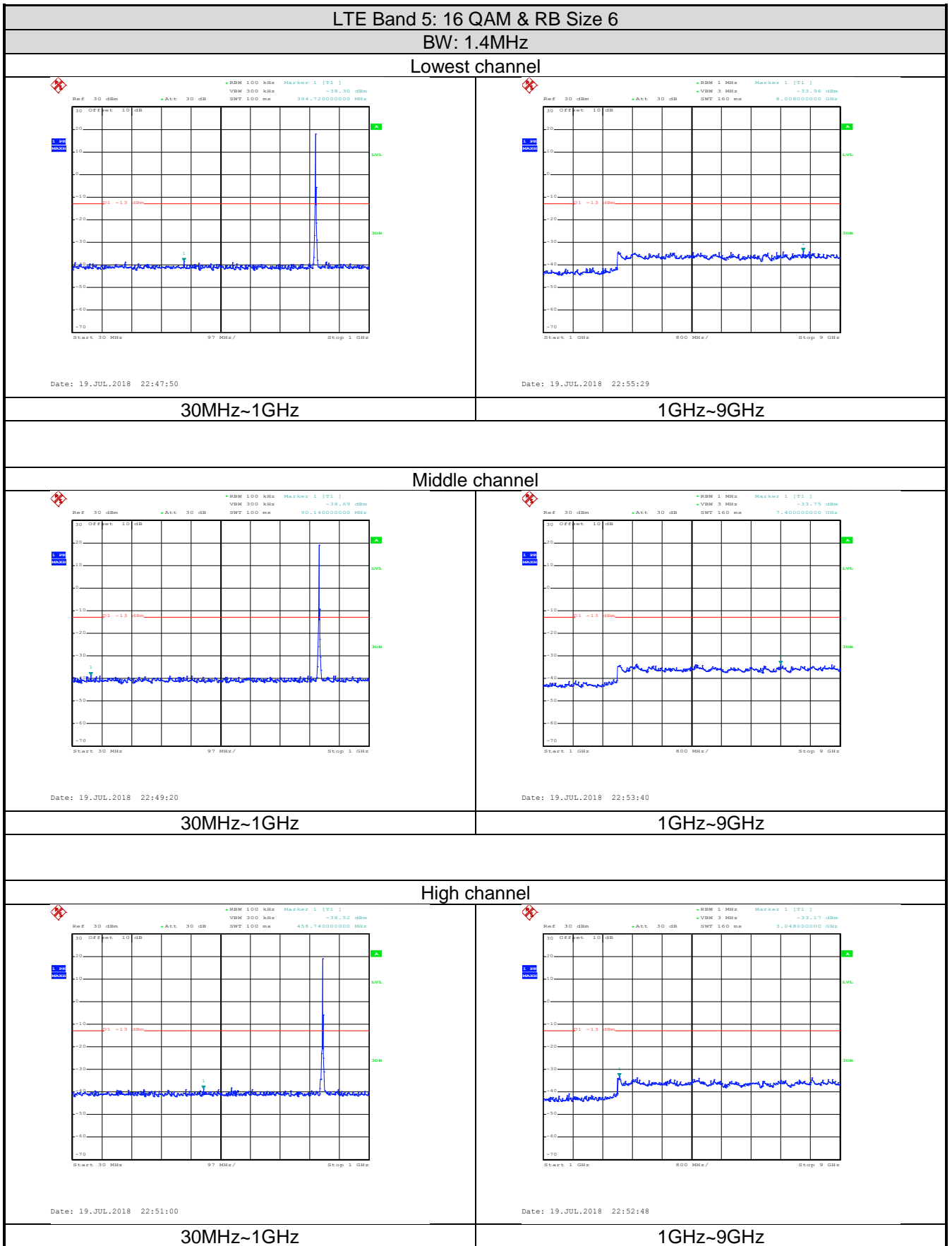

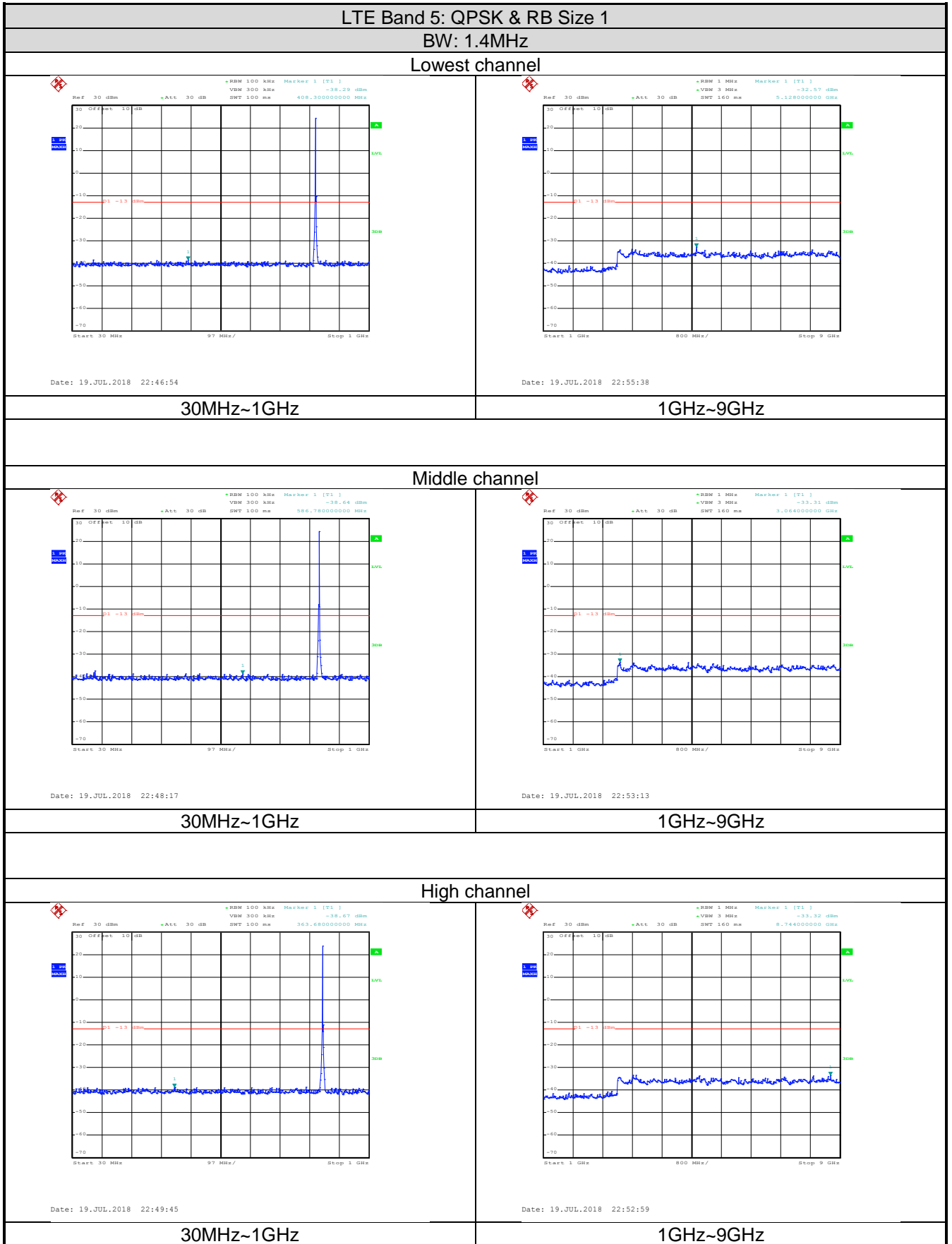

LTE Band 5: QPSK & RB Size 6

BW: 1.4MHz

Lowest channel

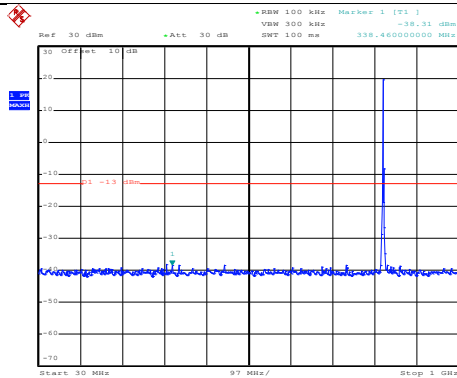

Date: 19.JUL.2018 22:47:36

30MHz~1GHz

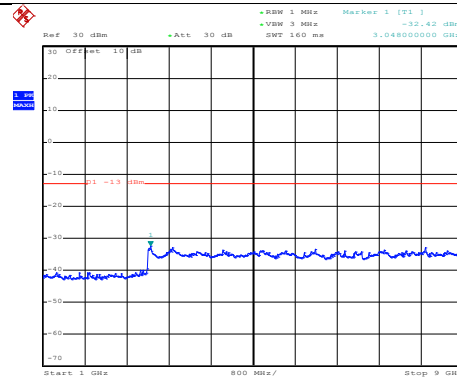

Date: 19.JUL.2018 22:55:23

1GHz~9GHz

Middle channel

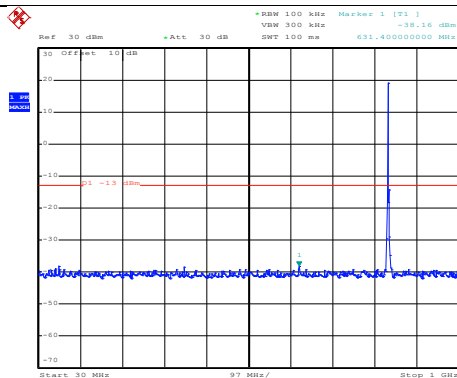

Date: 19.JUL.2018 22:49:01

30MHz~1GHz

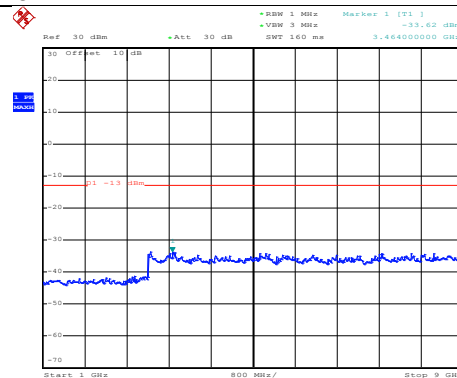

Date: 19.JUL.2018 22:53:28

1GHz~9GHz

High channel

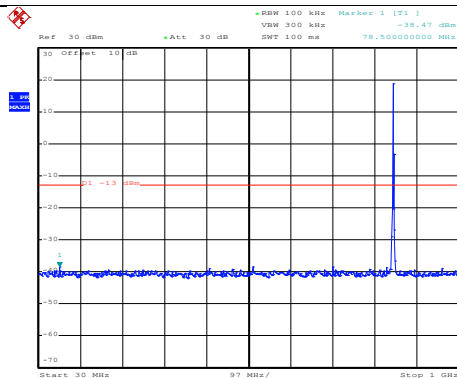

Date: 19.JUL.2018 22:50:42

30MHz~1GHz

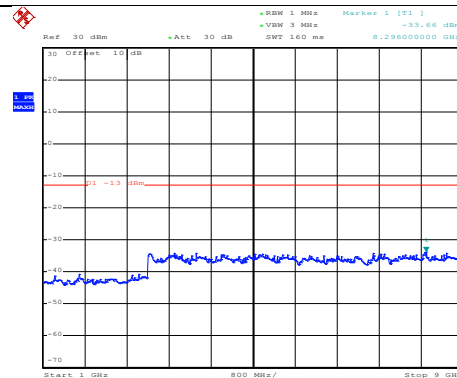

Date: 19.JUL.2018 22:52:40

1GHz~9GHz

**LTE Band 5: 16 QAM & RB Size 1**  
**BW: 3MHz**

**Lowest channel**

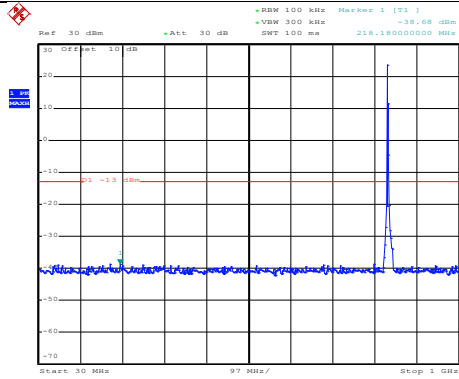

Date: 19.JUL.2018 23:08:09

**30MHz~1GHz**

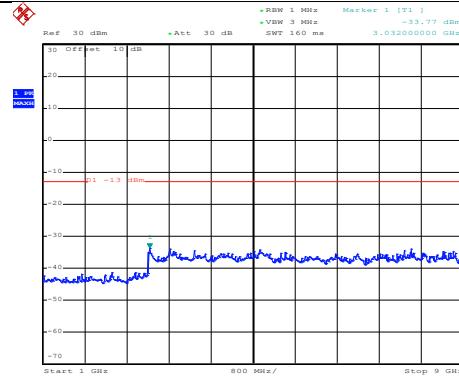

Date: 19.JUL.2018 22:55:59

**1GHz~9GHz**

**Middle channel**

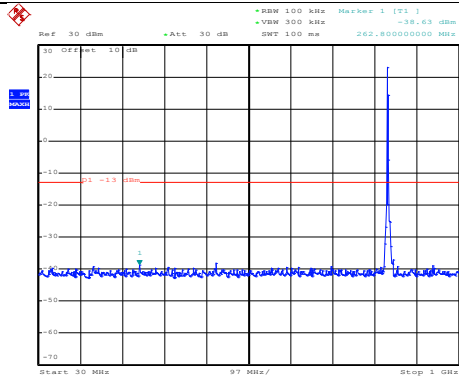

Date: 19.JUL.2018 23:08:44

**30MHz~1GHz**

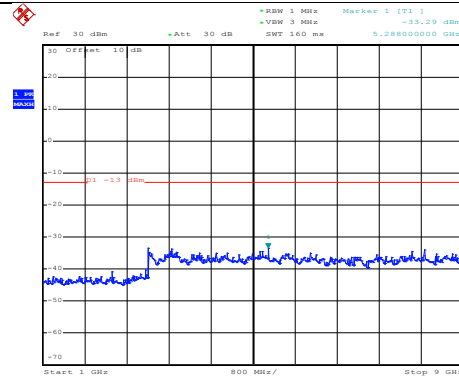

Date: 19.JUL.2018 22:56:50

**1GHz~9GHz**

**High channel**

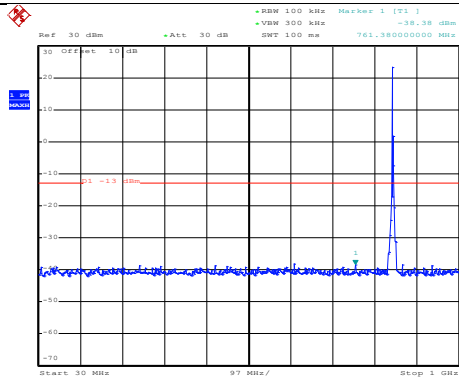

Date: 19.JUL.2018 23:10:08

**30MHz~1GHz**

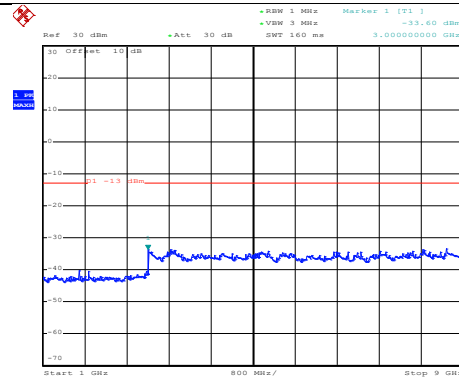

Date: 19.JUL.2018 22:57:15

**1GHz~9GHz**

**LTE Band 5: 16 QAM & RB Size 15**  
**BW: 3MHz**

**Lowest channel**

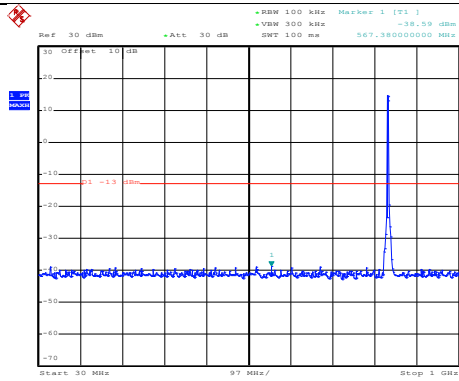

Date: 19.JUL.2018 23:07:27

**30MHz~1GHz**

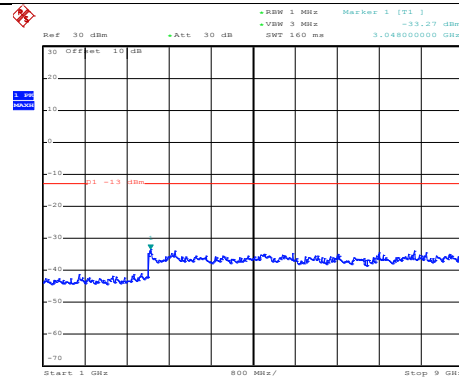

Date: 19.JUL.2018 22:56:19

**1GHz~9GHz**

**Middle channel**

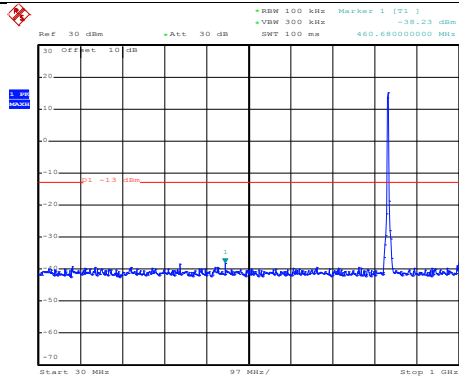

Date: 19.JUL.2018 23:09:18

**30MHz~1GHz**

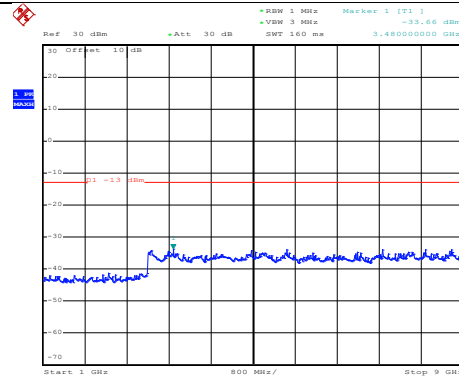

Date: 19.JUL.2018 22:56:34

**1GHz~9GHz**

**High channel**

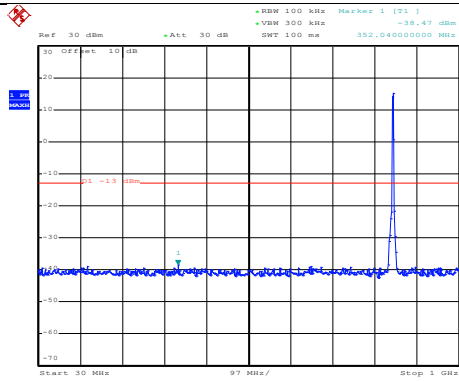

Date: 19.JUL.2018 23:10:43

**30MHz~1GHz**

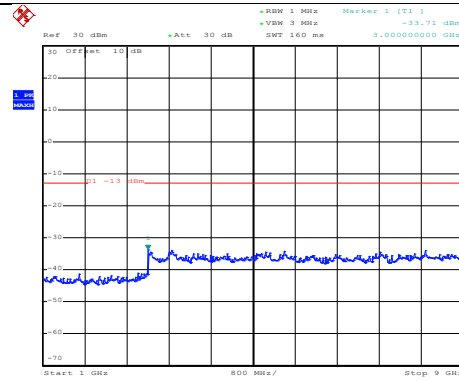

Date: 19.JUL.2018 22:57:28

**1GHz~9GHz**

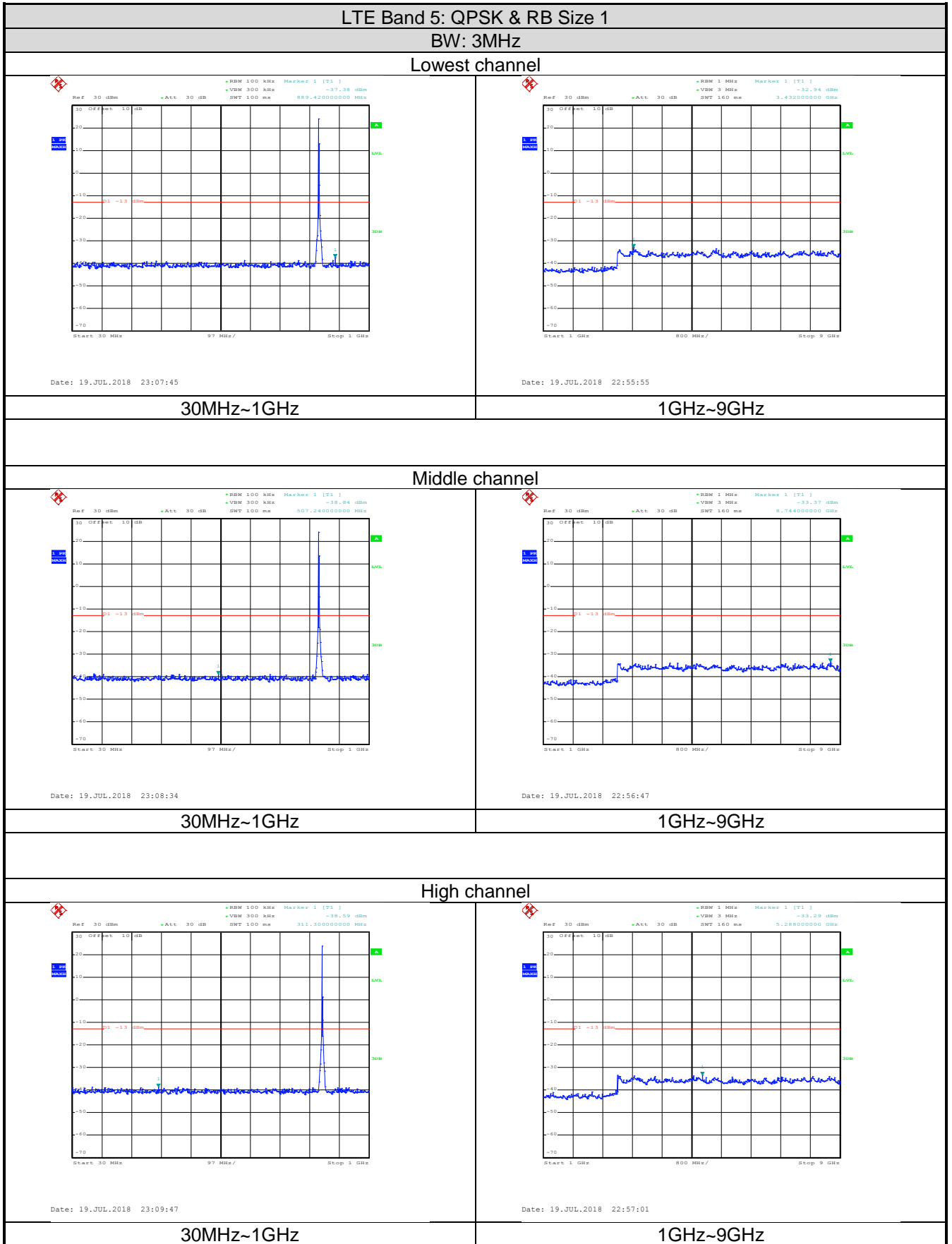



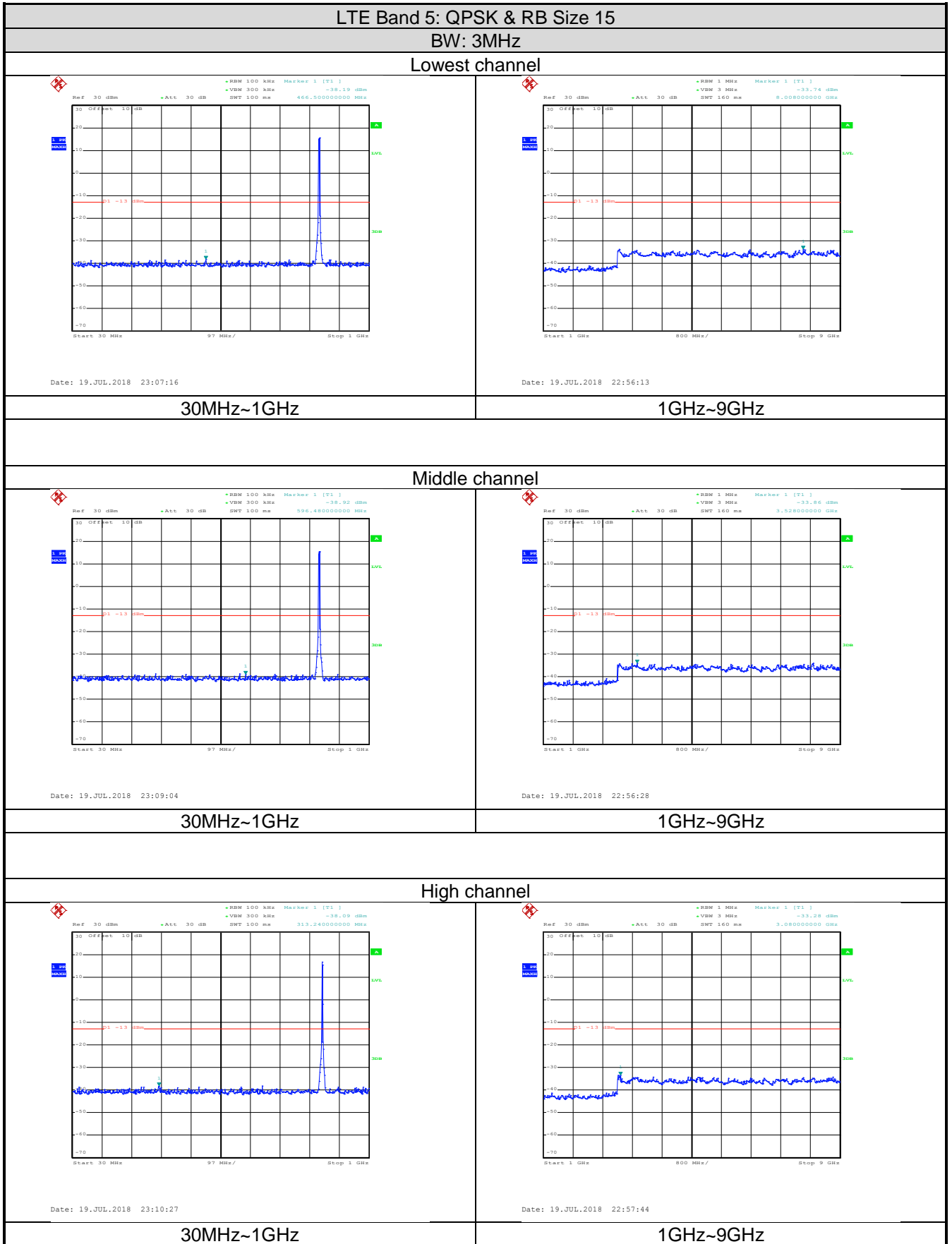

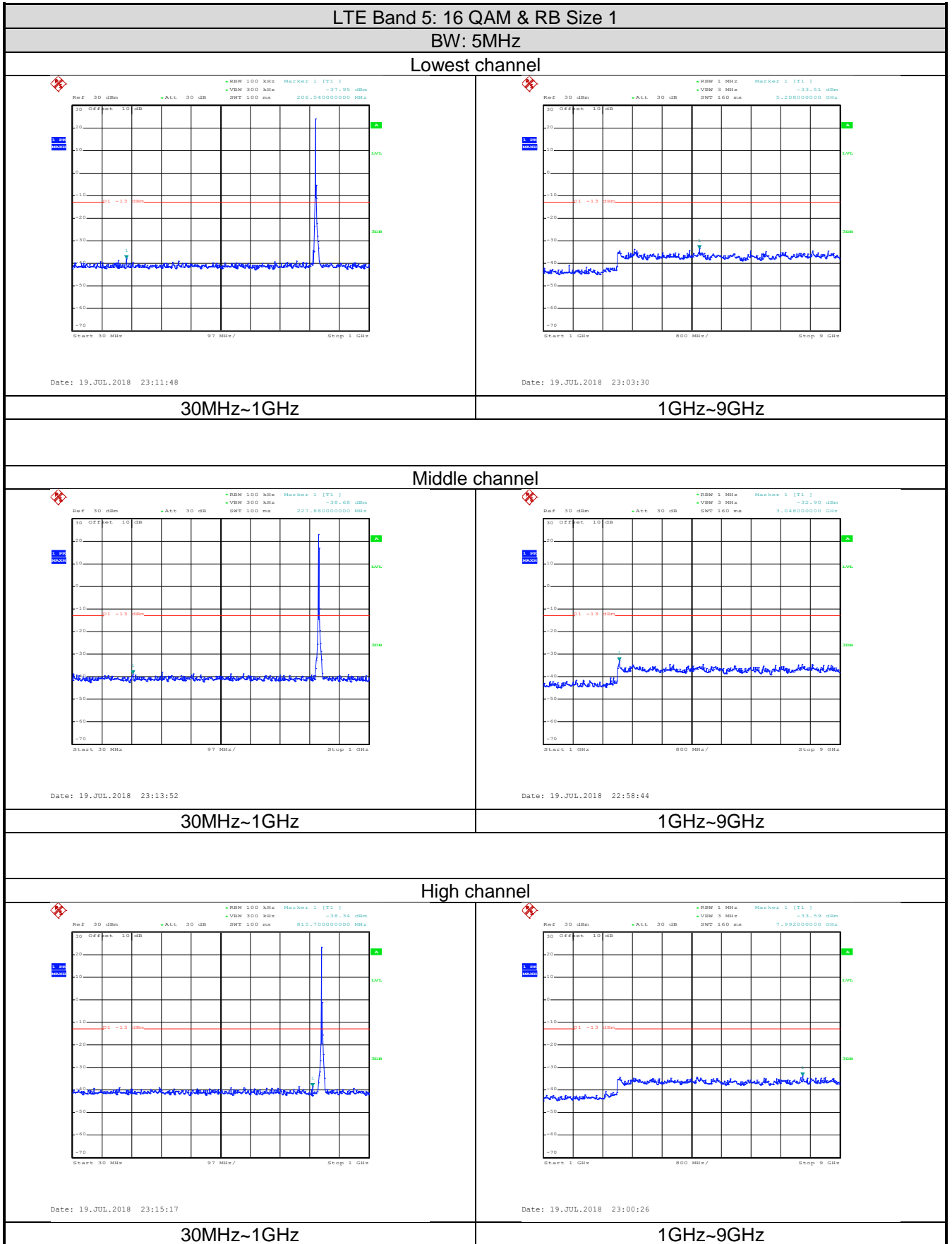

LTE Band 5: 16 QAM & RB Size 25

BW: 5MHz

Lowest channel

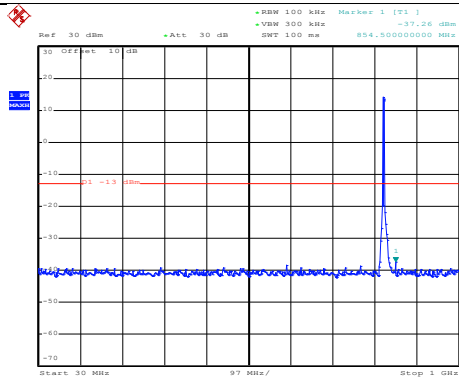

Date: 19.JUL.2018 23:13:02

30MHz~1GHz

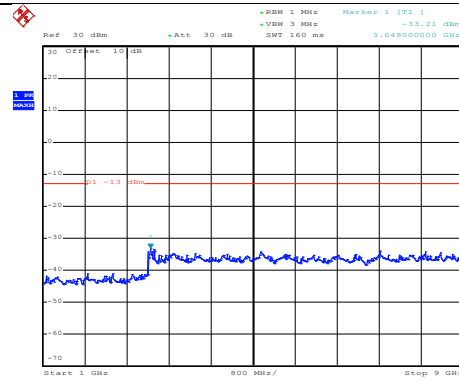

Date: 19.JUL.2018 23:03:47

1GHz~9GHz

Middle channel

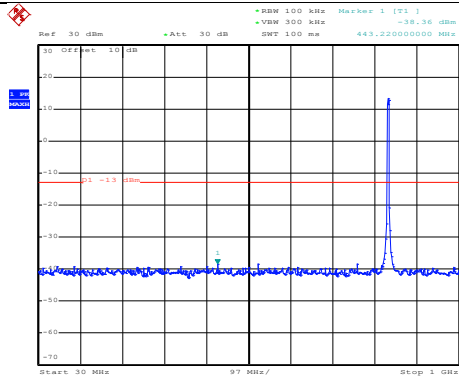

Date: 19.JUL.2018 23:14:24

30MHz~1GHz

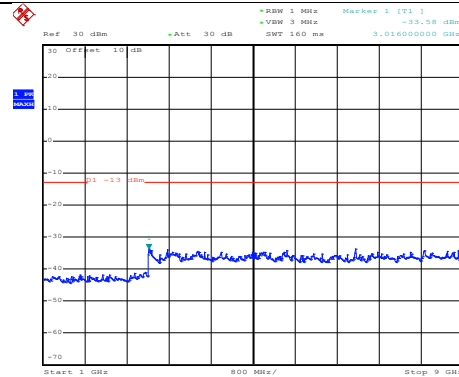

Date: 19.JUL.2018 22:59:00

1GHz~9GHz

High channel

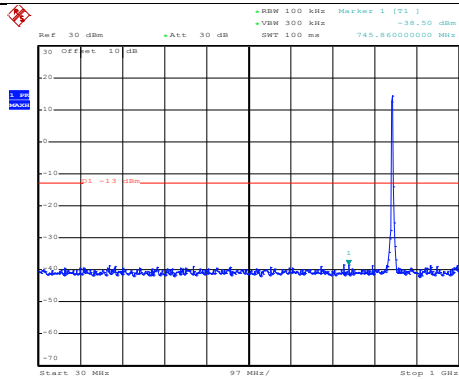

Date: 19.JUL.2018 23:15:57

30MHz~1GHz

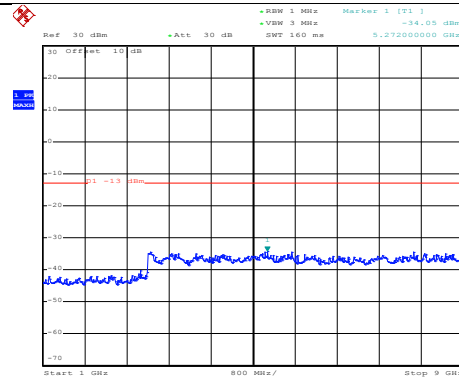

Date: 19.JUL.2018 22:58:20

1GHz~9GHz

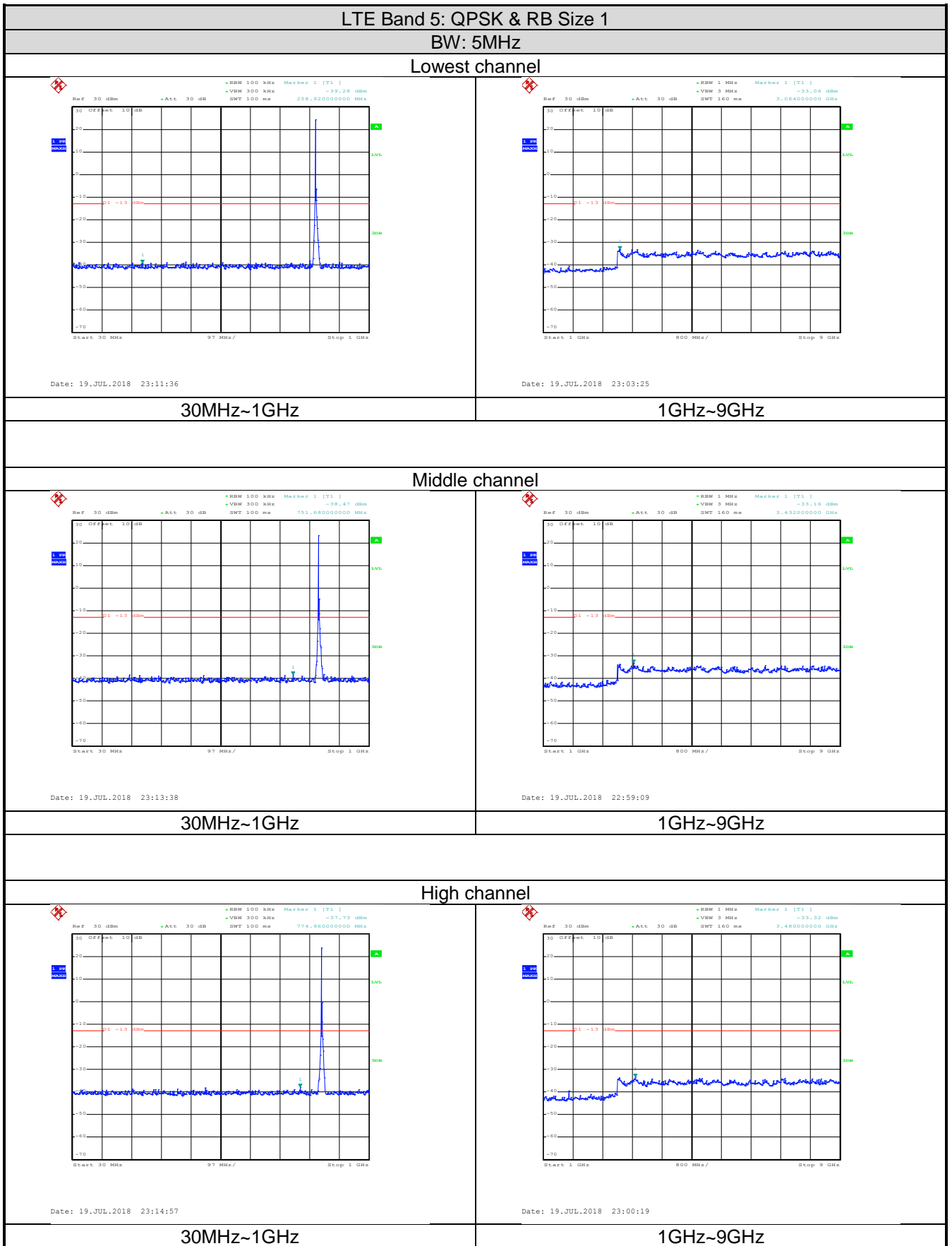

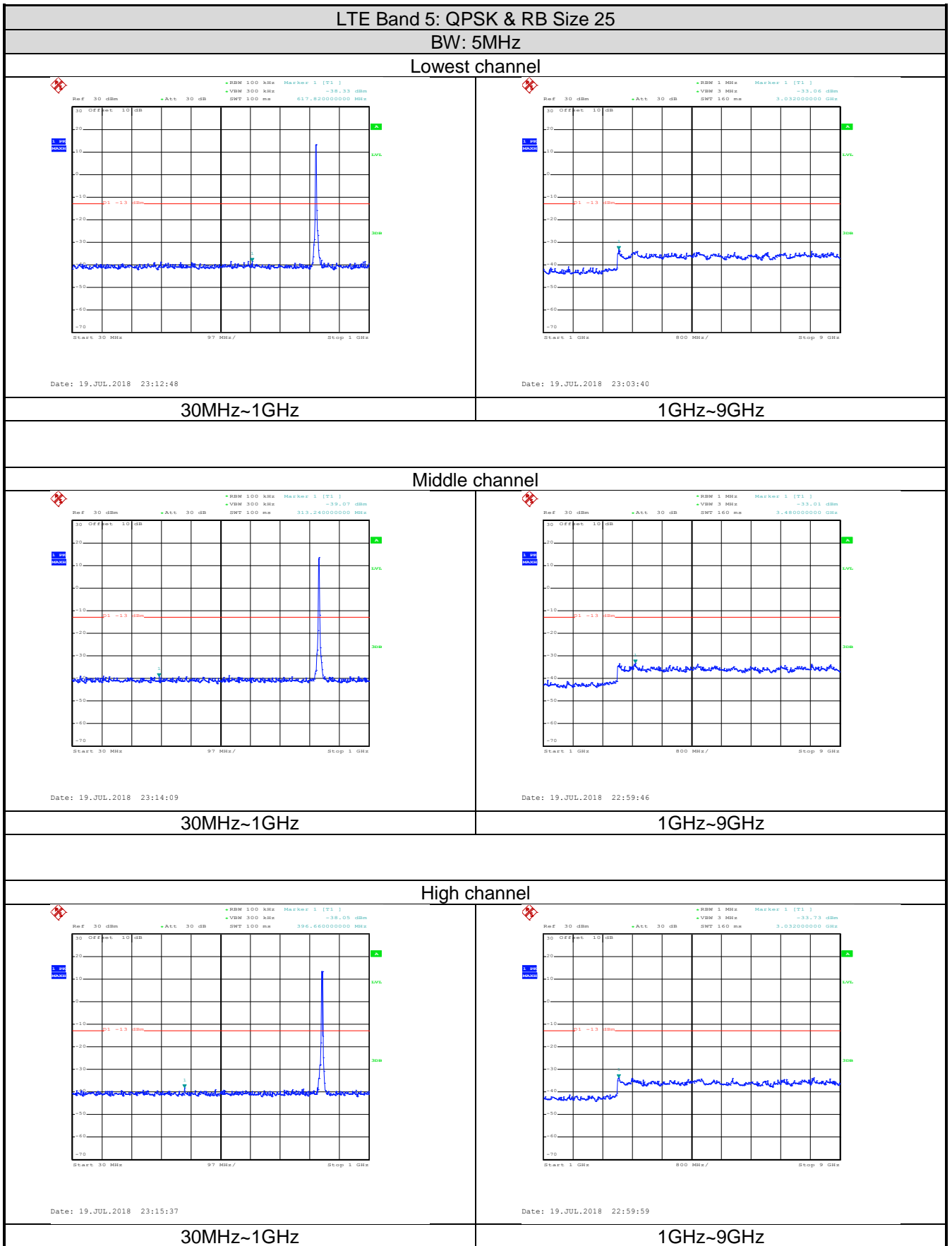

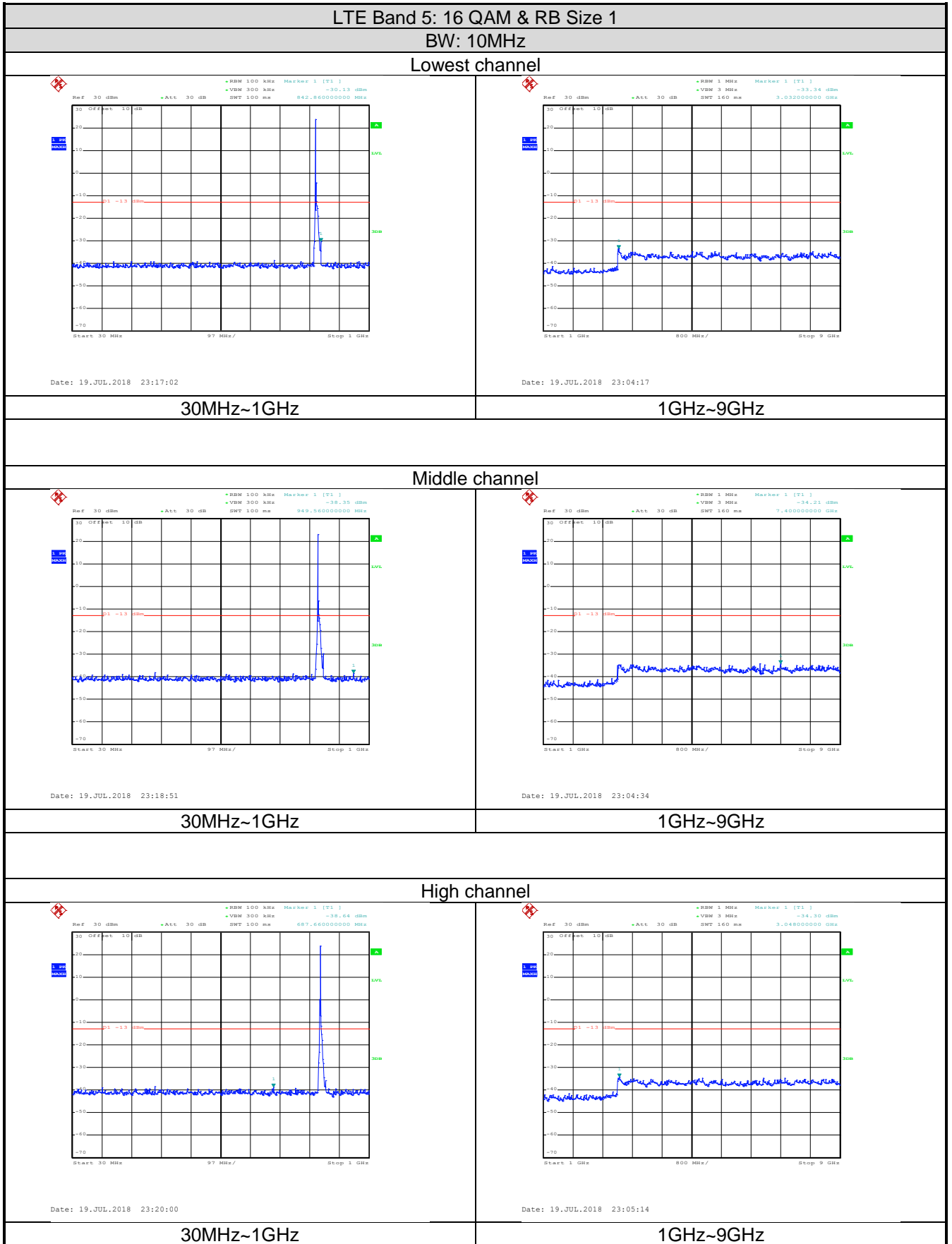

LTE Band 5: 16 QAM & RB Size 50

BW: 10MHz

Lowest channel

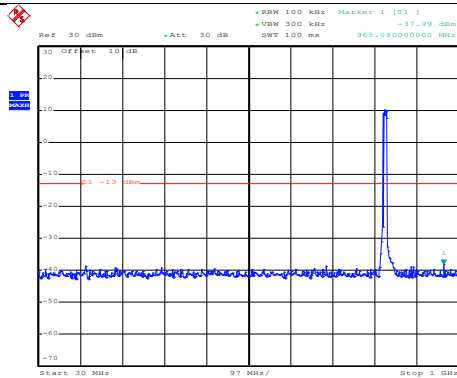

Date: 19.JUL.2018 23:17:45

30MHz~1GHz

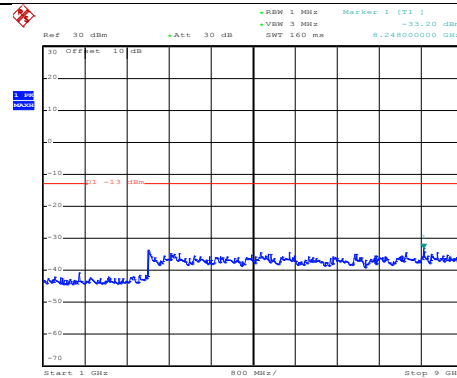

Date: 19.JUL.2018 23:04:04

1GHz~25GHz

Middle channel

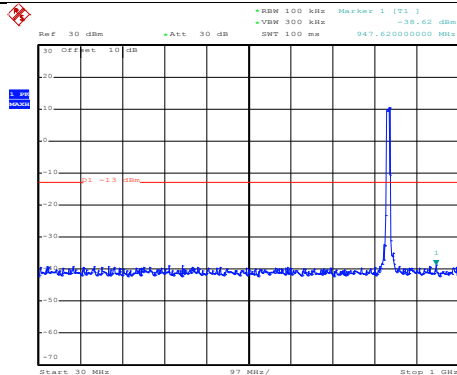

Date: 19.JUL.2018 23:19:22

30MHz~1GHz

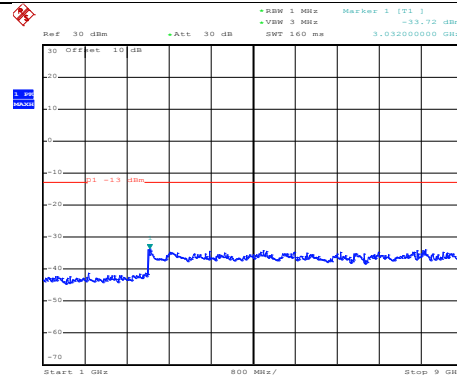

Date: 19.JUL.2018 23:04:51

1GHz~25GHz

High channel

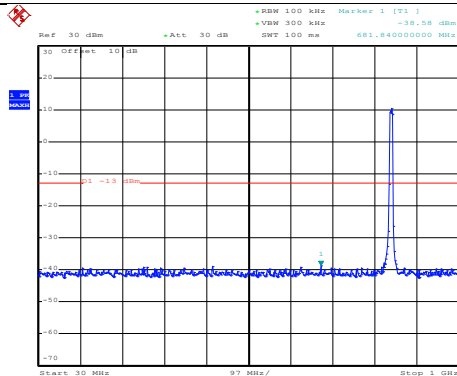

Date: 19.JUL.2018 23:20:33

30MHz~1GHz

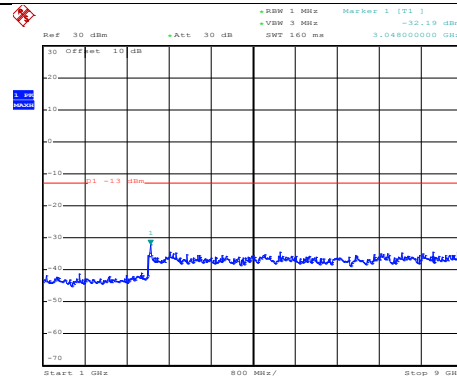

Date: 19.JUL.2018 23:05:02

1GHz~25GHz

LTE Band 5: QPSK & RB Size 1

BW: 10MHz

Lowest channel

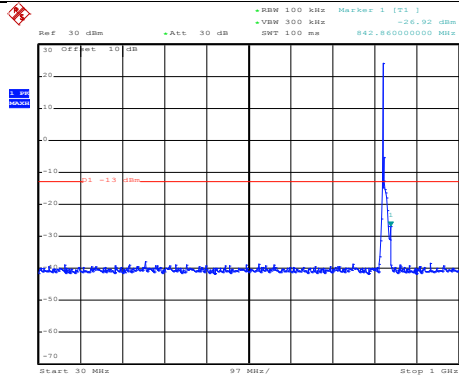

Date: 19.JUL.2018 23:16:46

30MHz~1GHz

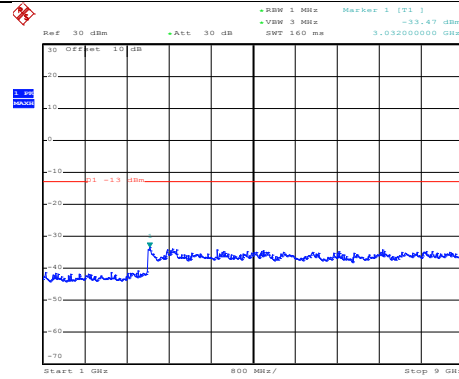

Date: 19.JUL.2018 23:04:13

1GHz~9GHz

Middle channel

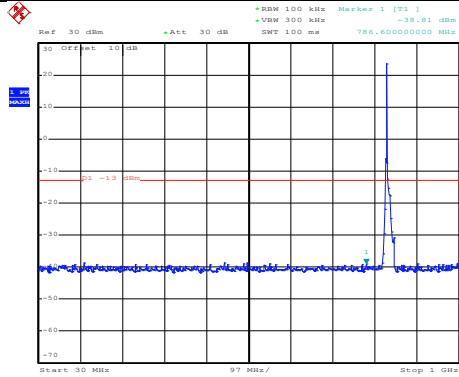

Date: 19.JUL.2018 23:18:18

30MHz~1GHz

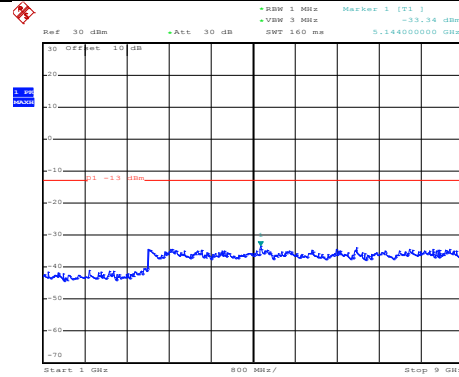

Date: 19.JUL.2018 23:04:28

1GHz~9GHz

High channel

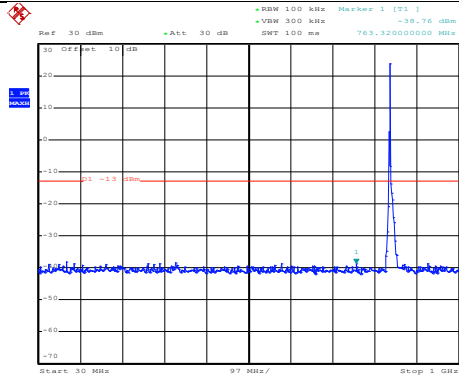

Date: 19.JUL.2018 23:19:47

30MHz~1GHz

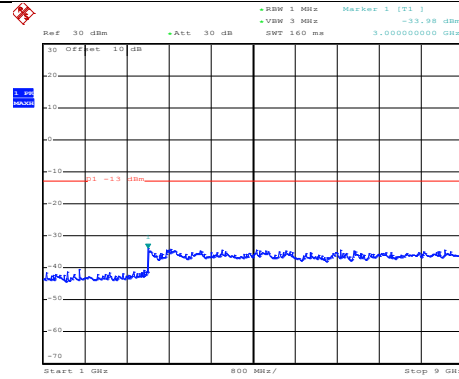

Date: 19.JUL.2018 23:05:10

1GHz~9GHz



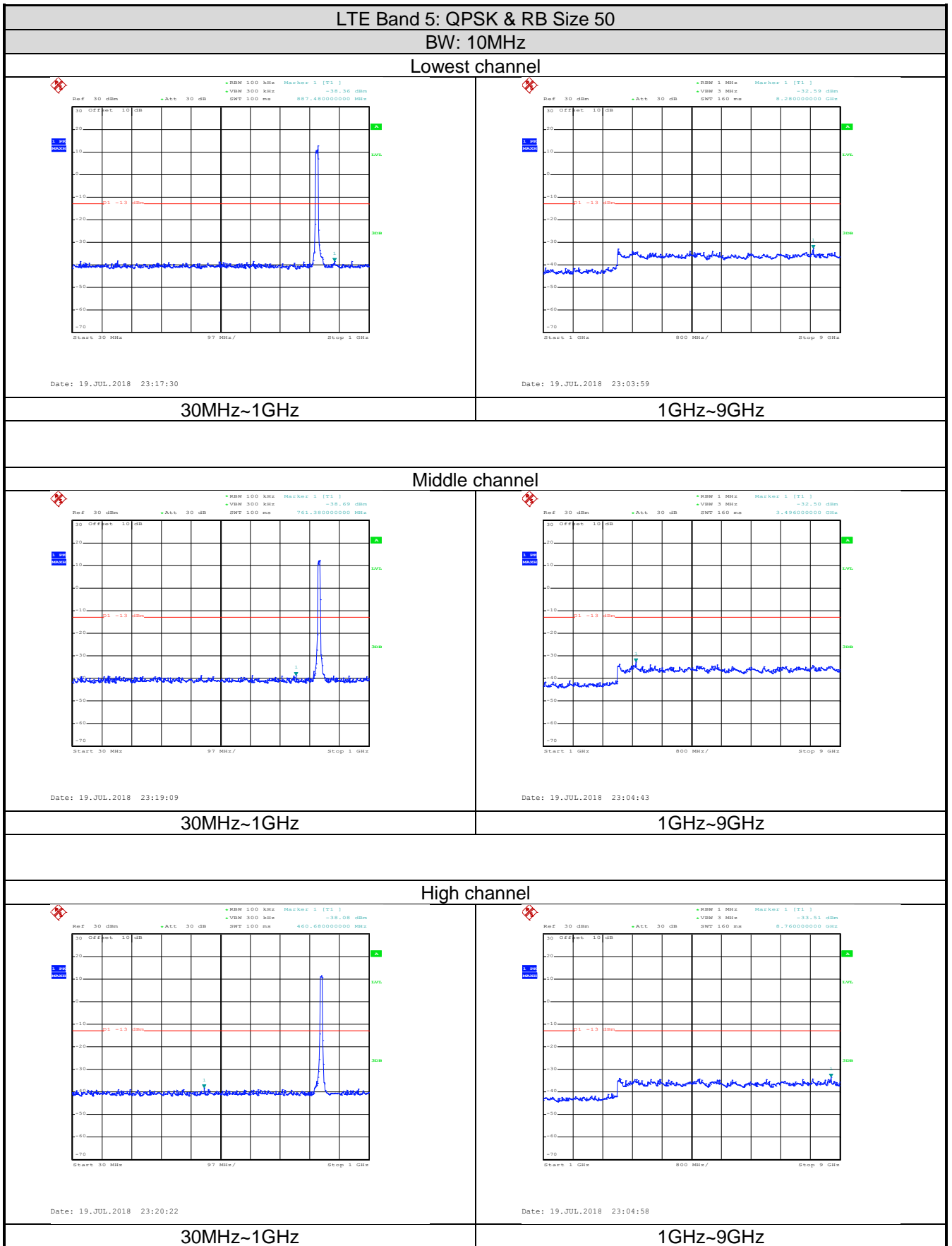

**Band edge emission:**

**LTE Band 5 part:**

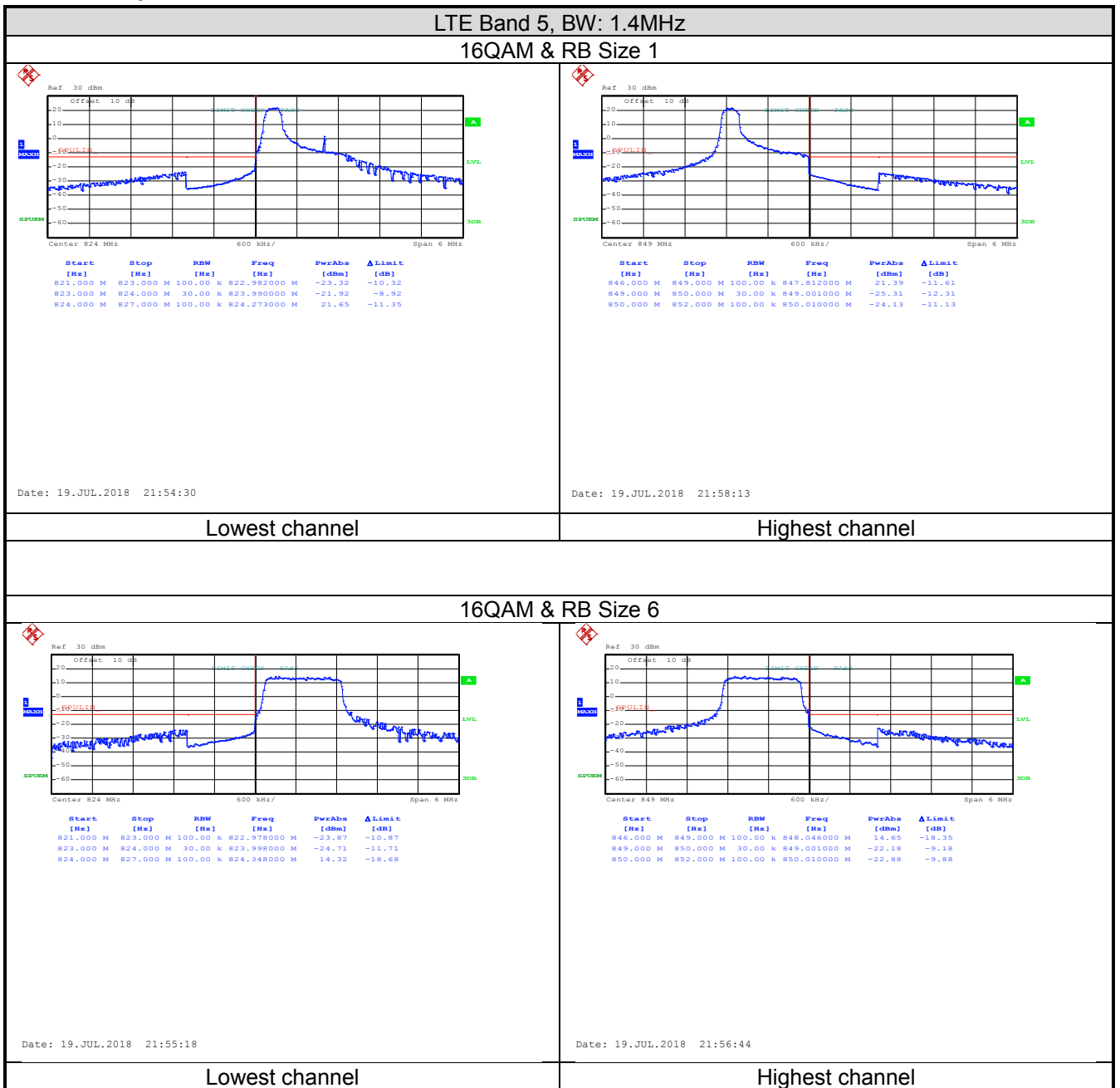

## LTE Band 5, BW: 1.4MHz QPSK & RB Size 1

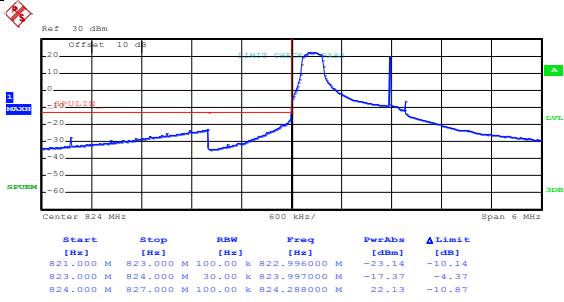

Date: 19.JUL.2018 21:53:40

Lowest channel

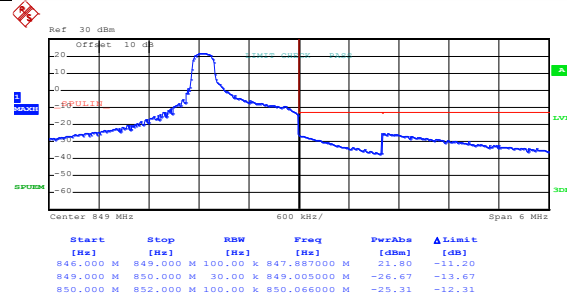

Date: 19.JUL.2018 21:57:41

Highest channel

## QPSK & RB Size 6

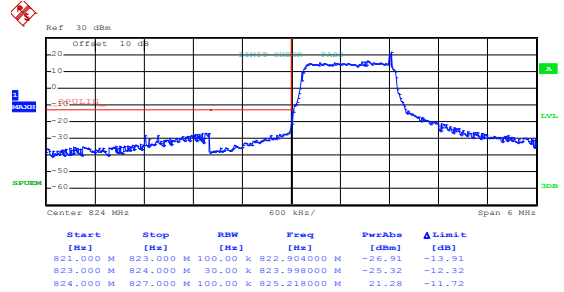

Date: 19.JUL.2018 21:55:00

Lowest channel

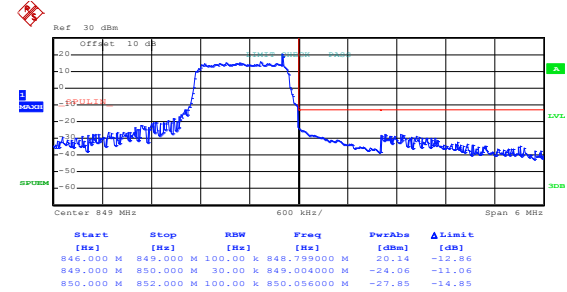

Date: 19.JUL.2018 21:57:04

Highest channel

LTE Band 5, BW: 3MHz  
16QAM & RB Size 1

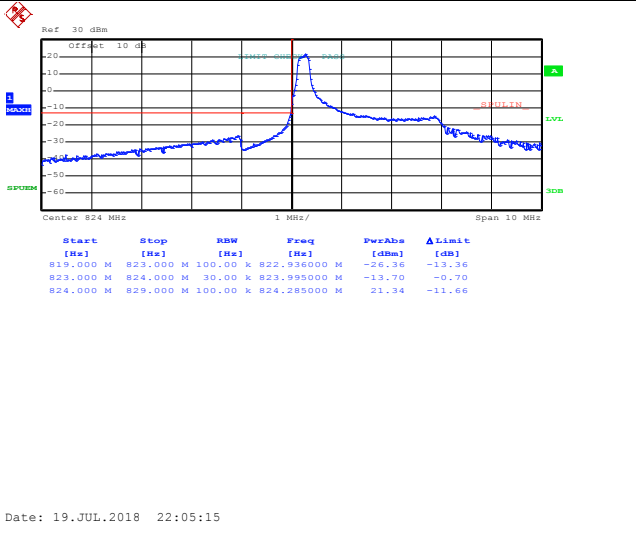

Lowest channel

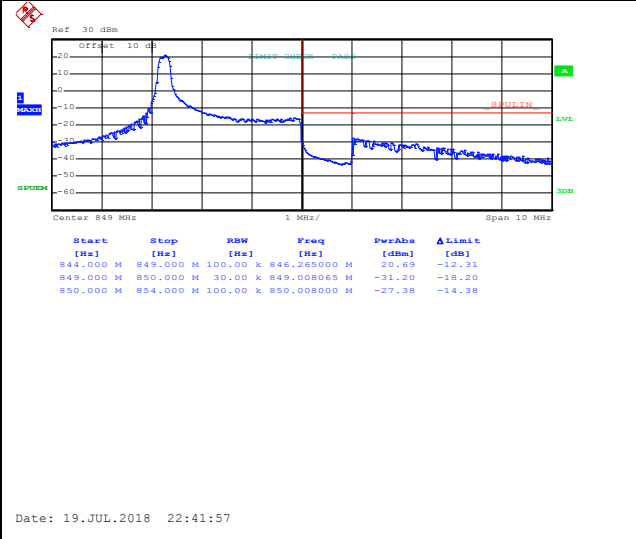

Highest channel

16QAM & RB Size 15

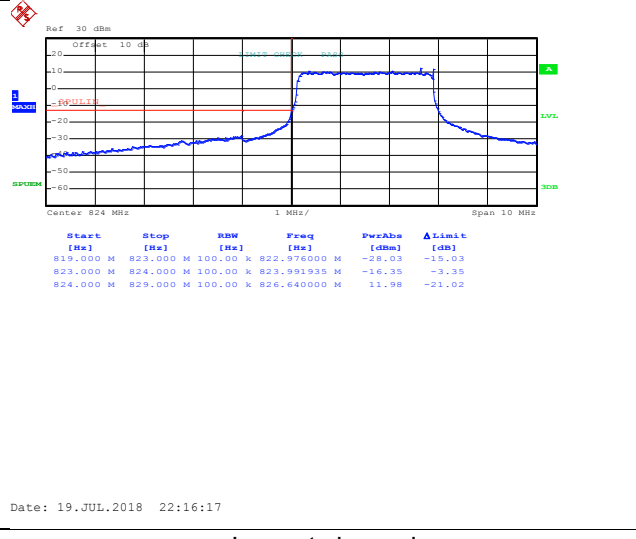

Lowest channel

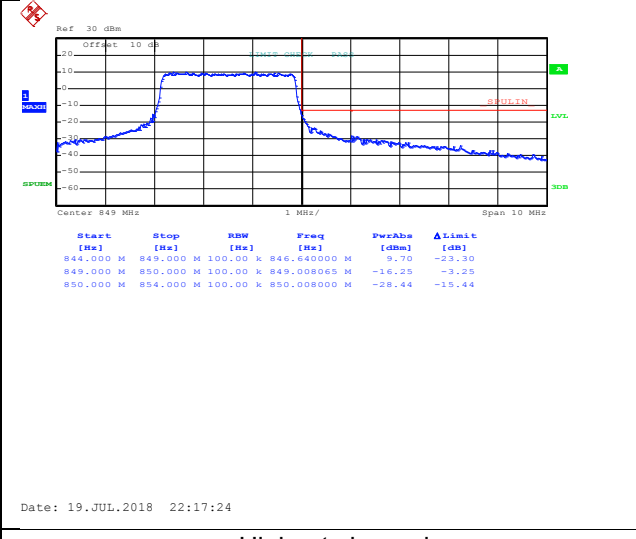

Highest channel

## LTE Band 5, BW: 3MHz QPSK & RB Size 1

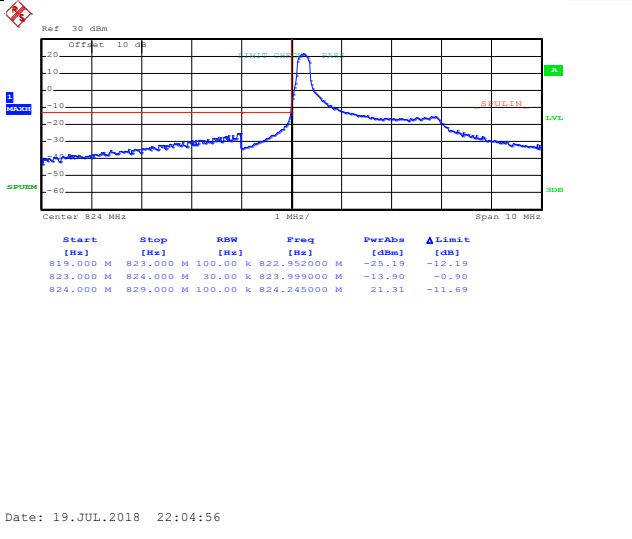

Lowest channel

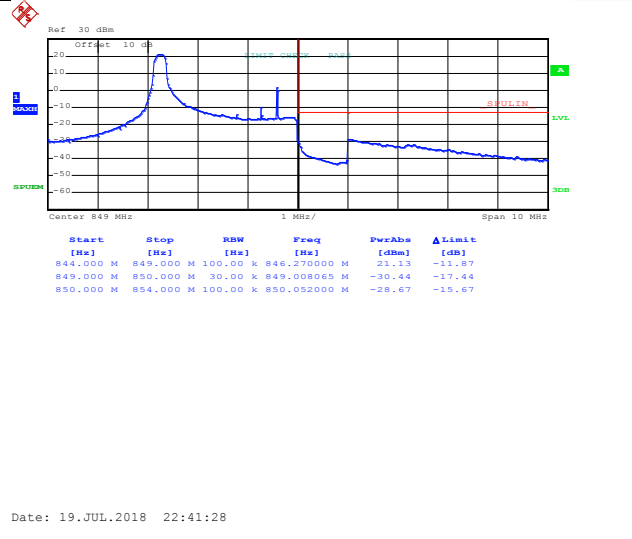

Highest channel

## QPSK & RB Size 15

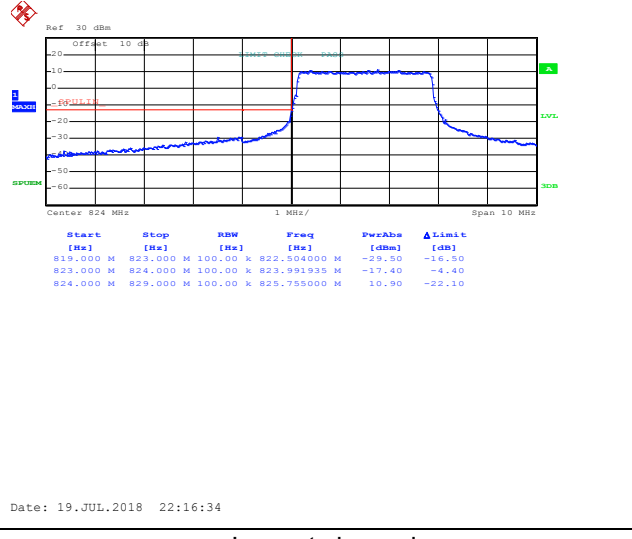

Lowest channel

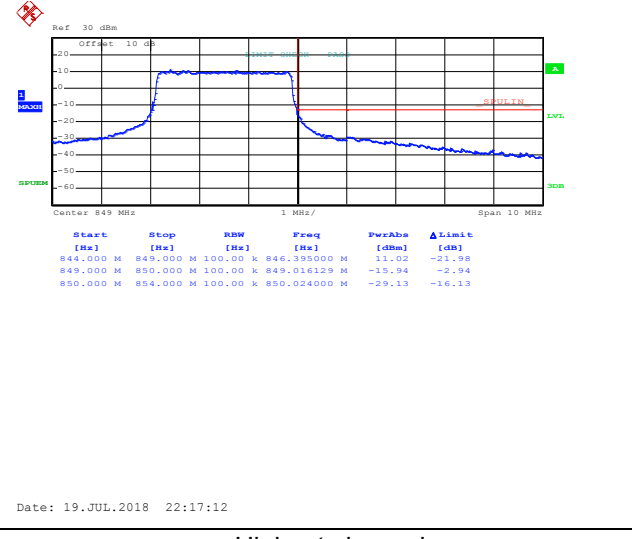

Highest channel

LTE Band 5, BW: 5MHz  
16QAM & RB Size 1

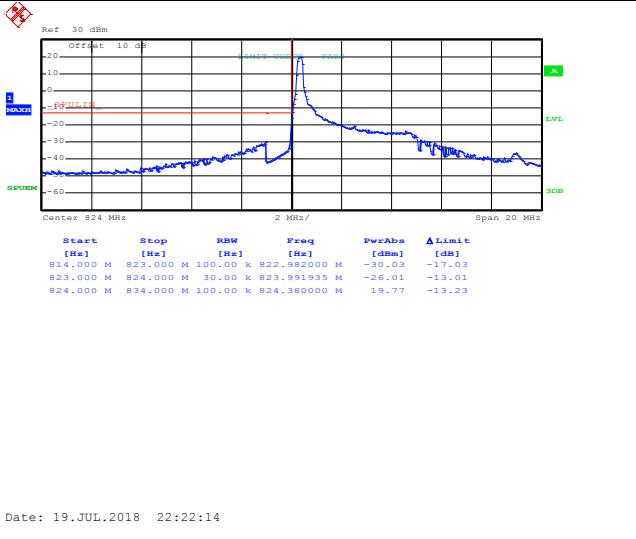

Lowest channel

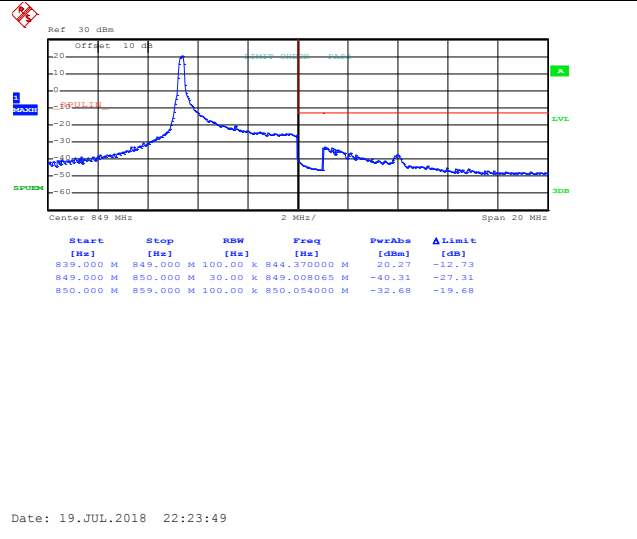

Highest channel

16QAM & RB Size 25

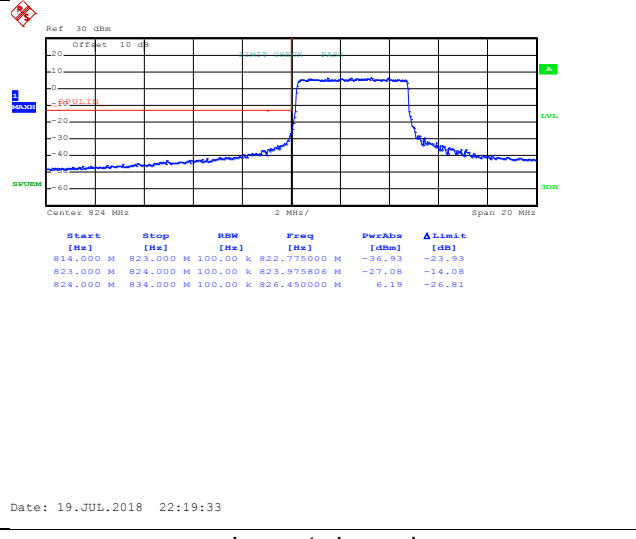

Lowest channel

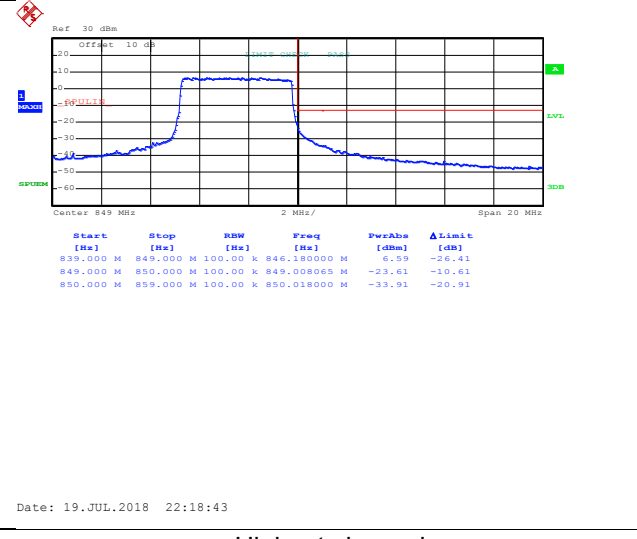

Highest channel

## LTE Band 5, BW: 5MHz QPSK & RB Size 1

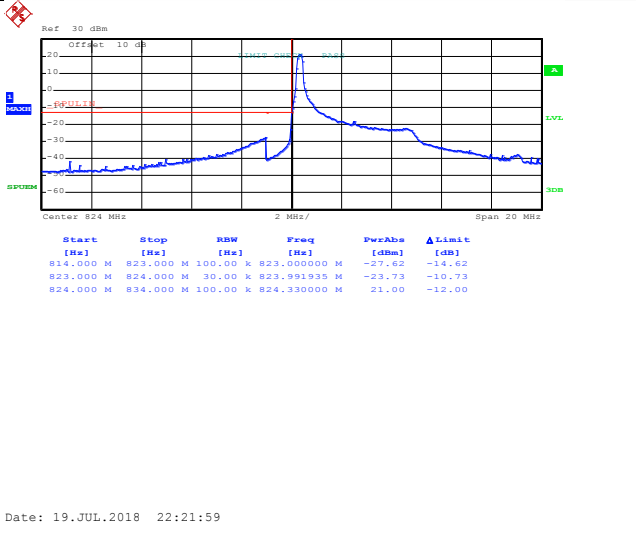

Lowest channel

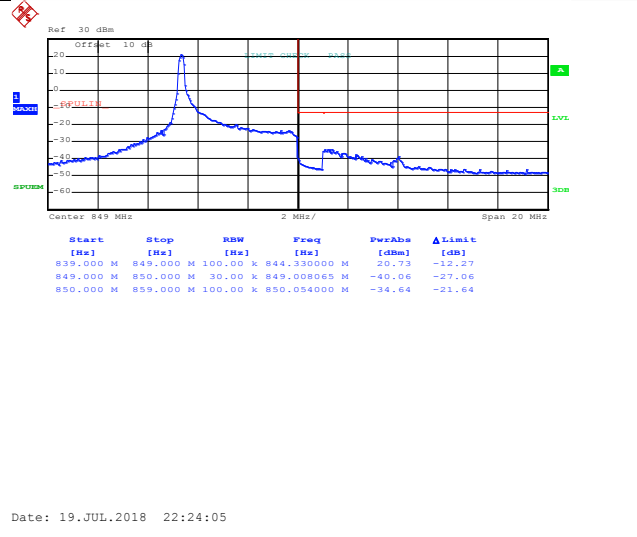

Highest channel

## QPSK & RB Size 25

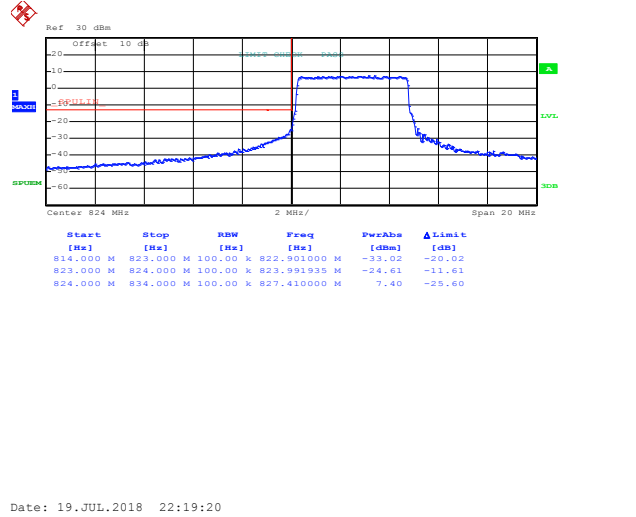

Lowest channel

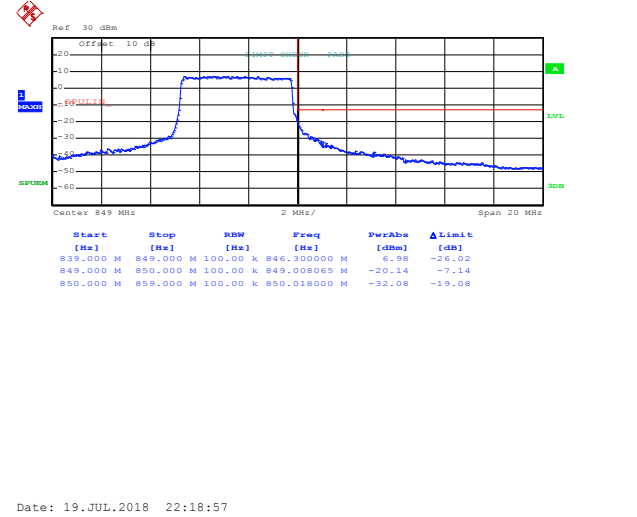

Highest channel

## LTE Band 5, BW: 10MHz 16QAM & RB Size 1

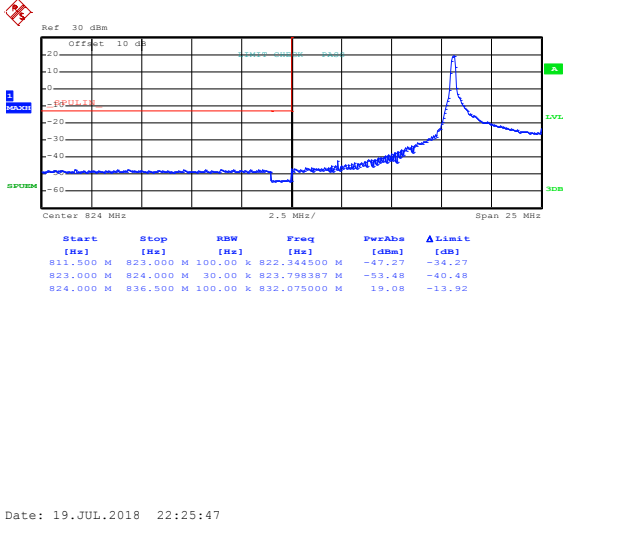

Lowest channel

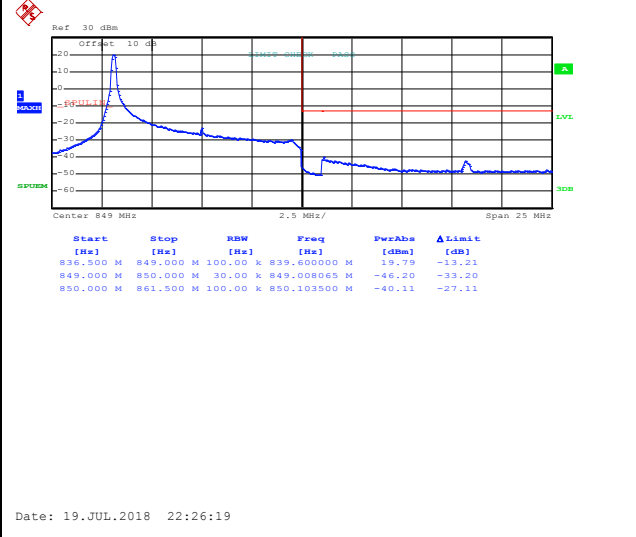

Highest channel

## 16QAM & RB Size 50

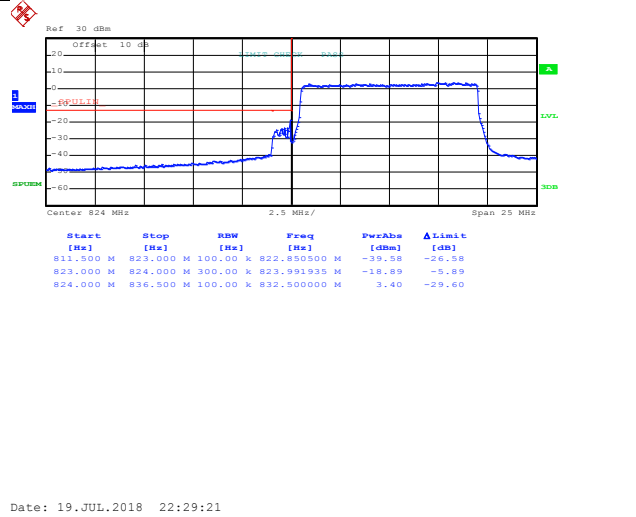

Lowest channel

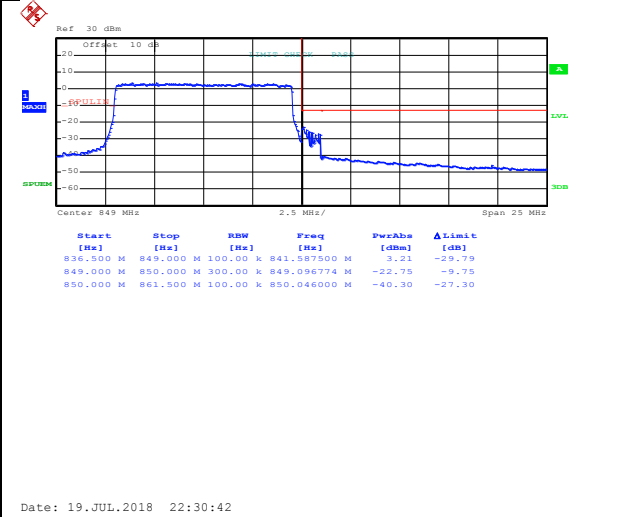

Highest channel



## LTE Band 5, BW: 10MHz QPSK & RB Size 1

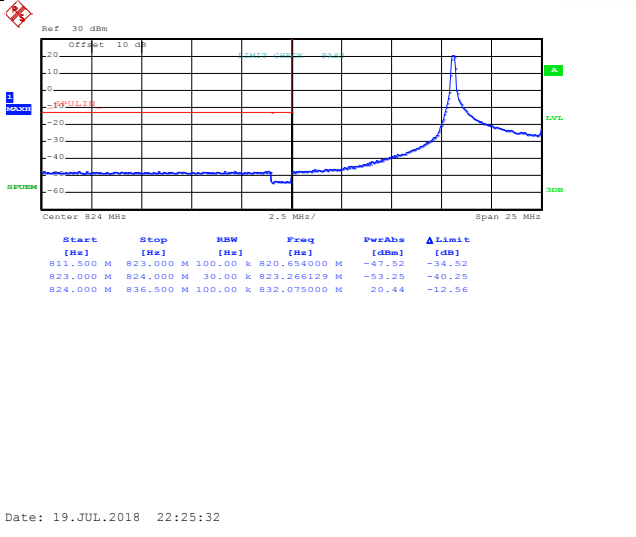

Lowest channel

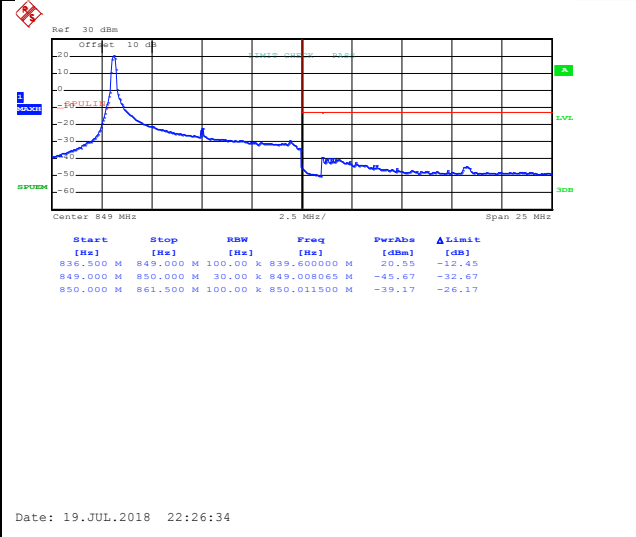

Highest channel

## QPSK & RB Size 50

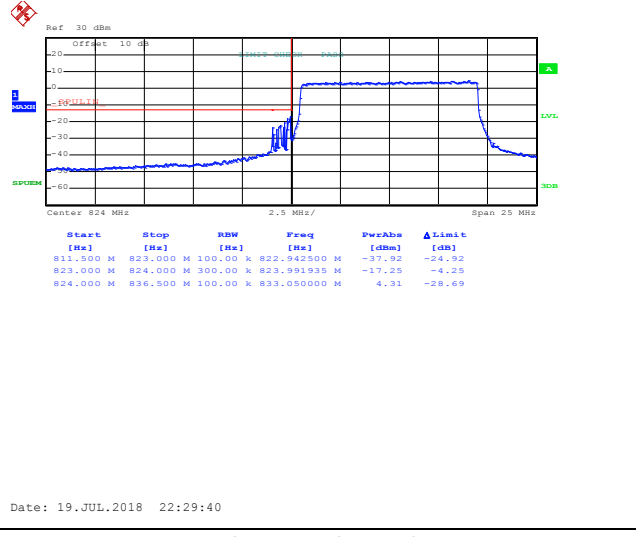

Lowest channel

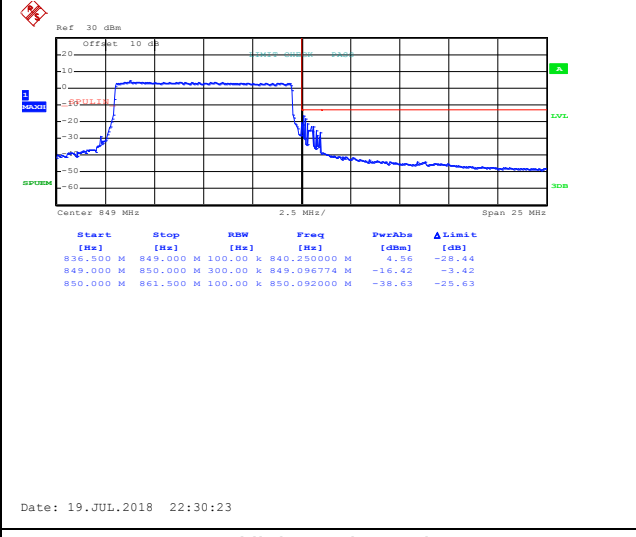

Highest channel

## 6.5 ERP, EIRP Measurement

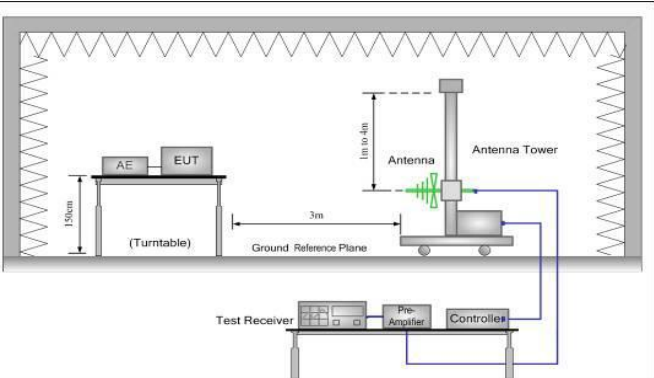
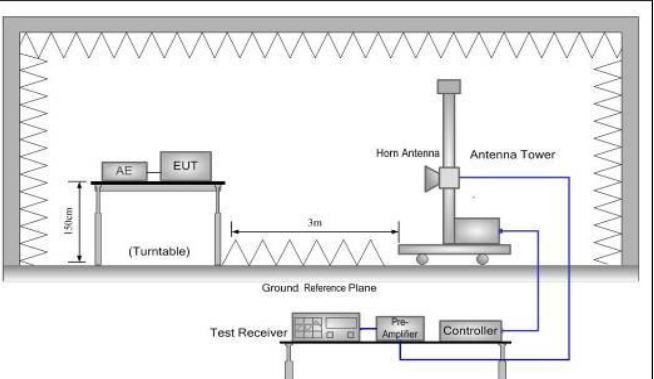
Test Requirement:	Part 22.913(a)(2)
Test Method:	ANSI/TIA-603-D 2010
Limit:	LTE Band 5: 7W EIRP
Test setup:	<p>Below 1GHz</p>  <p>Above 1GHz</p> 
Test Procedure:	<ol style="list-style-type: none"> <li>The EUT was placed on an non-conductive turntable using a non-conductive support. The radiated emission at the fundamental frequency was measured at 3 m with a test antenna and EMI spectrum analyzer.</li> <li>During the measurement, the EUT was communication with the station. The highest emission was recorded with the rotation of the turntable and the lowering of the test antenna from 4m to 1m. The reading was recorded and the field strength (E in dBuV/m) was calculated.</li> <li>ERP in frequency band below 1GHz were measured using a substitution method. The EUT was replaced by dipole antenna connected, the S.G. output was recorded and ERP was calculated as follows:  <math display="block">ERP = S.G. \text{ output (dBm)} + \text{Antenna Gain (dBd)} - \text{Cable Loss (dB)}</math> </li> <li>EIRP in frequency band above 1GHz were measured using a substitution method. The EUT was replaced by or horn antenna connected, the S.G. output was recorded and EIRP was calculated as follows:  <math display="block">EIRP = S.G. \text{ output (dBm)} + \text{Antenna Gain (dBi)} - \text{Cable Loss (dB)}</math> </li> <li>The worse case was relating to the conducted output power.</li> </ol>
Test Instruments:	Refer to section 5.9 for details
Test mode:	Refer to section 5.3 for details
Test results:	Passed

### Measurement Data:

**LTE Band 5 part:**

LTE Band 5							
Lowset channel							
Frequency (MHz)	UL Channel	Modulation	EUT Pol.	Antenna Pol.	ERP(dBm)	Limit (dBm)	Result
1.4MHz(RB size 1 & RB offset 0)							
824.70	20407	QPSK	H	V	22.61	33.00	Pass
				H	21.52		
824.70	20407	16QAM	H	V	22.51		
				H	21.36		
1.4MHz(RB size 3 & RB offset 0)							
836.50	20525	QPSK	H	V	22.43	33.00	Pass
				H	21.36		
836.50	20525	16QAM	H	V	22.37		
				H	21.23		
1.4MHz(RB size 6 & RB offset 0)							
848.30	20643	QPSK	H	V	22.14	33.00	Pass
				H	21.26		
848.30	20643	16QAM	H	V	22.25		
				H	21.03		
Middle channel							
Frequency (MHz)	UL Channel	Modulation	EUT Pol.	Antenna Pol.	ERP(dBm)	Limit (dBm)	Result
1.4MHz(RB size 1 & RB offset 0)							
825.5	20415	QPSK	H	V	20.88	30.00	Pass
				H	21.14		
825.5	20415	16QAM	H	V	20.69		
				H	21.03		
1.4MHz(RB size 3 & RB offset 0)							
836.50	20525	QPSK	H	V	20.41	30.00	Pass
				H	21.62		
836.50	20525	16QAM	H	V	20.13		
				H	20.89		
1.4MHz(RB size 6 & RB offset 0)							
847.50	20635	QPSK	H	V	20.24	30.00	Pass
				H	21.62		
847.50	20635	16QAM	H	V	20.63		
				H	20.14		

LTE Band 5							
Highest channel							
Frequency (MHz)	UL Channel	Modulation	EUT Pol.	Antenna Pol.	ERP(dBm)	Limit (dBm)	Result
1.4MHz(RB size 1 & RB offset 0)							
826.50	20425	QPSK	H	V	22.58	33.00	Pass
				H	20.82		
826.50	20425	16QAM	H	V	22.63		
				H	20.36		
1.4MHz(RB size 3 & RB offset 0)							
836.50	20525	QPSK	H	V	22.14	33.00	Pass
				H	20.36		
836.50	20525	16QAM	H	V	22.52		
				H	20.31		
1.4MHz(RB size 6 & RB offset 0)							
846.50	20625	QPSK	H	V	22.41	33.00	Pass
				H	20.63		
846.50	20625	16QAM	H	V	22.13		
				H	20.11		
Lowset channel							
Frequency (MHz)	UL Channel	Modulation	EUT Pol.	Antenna Pol.	ERP(dBm)	Limit (dBm)	Result
10MHz(RB size 1 & RB offset 0)							
829.00	20450	QPSK	H	V	22.85	33.00	Pass
				H	21.36		
829.00	20450	16QAM	H	V	22.34		
				H	21.31		
10MHz(RB size 25 & RB offset 0)							
836.50	20525	QPSK	H	V	22.16	33.00	Pass
				H	21.05		
836.50	20525	16QAM	H	V	22.13		
				H	21.11		
10MHz(RB size 50 & RB offset 0)							
844.00	20600	QPSK	H	V	22.14	33.00	Pass
				H	20.99		
844.00	20600	16QAM	H	V	22.03		
				H	20.86		

LTE Band 5							
Middle channel							
Frequency (MHz)	UL Channel	Modulation	EUT Pol.	Antenna Pol.	ERP(dBm)	Limit (dBm)	Result
10MHz(RB size 1 & RB offset 0)							
826.50	20425	QPSK	H	V	20.90	33.00	Pass
				H	21.63		
826.50	20425	16QAM	H	V	20.14		
				H	21.55		
10MHz(RB size 25 & RB offset 0)							
836.50	20525	QPSK	H	V	20.52	33.00	Pass
				H	21.16		
836.50	20525	16QAM	H	V	20.30		
				H	21.71		
10MHz(RB size 50 & RB offset 0)							
846.50	20625	QPSK	H	V	20.15	33.00	Pass
				H	21.22		
846.50	20625	16QAM	H	V	20.01		
				H	21.25		
High channel							
Frequency (MHz)	UL Channel	Modulation	EUT Pol.	Antenna Pol.	ERP(dBm)	Limit (dBm)	Result
10MHz(RB size 1 & RB offset 0)							
829.00	20450	QPSK	H	V	22.41	33.00	Pass
				H	20.34		
829.00	20450	16QAM	H	V	22.13		
				H	20.63		
10MHz(RB size 25 & RB offset 0)							
836.50	20525	QPSK	H	V	22.14	33.00	Pass
				H	20.52		
836.50	20525	16QAM	H	V	22.11		
				H	20.63		
10MHz(RB size 50 & RB offset 0)							
844.00	20600	QPSK	H	V	22.16	33.00	Pass
				H	20.31		
844.00	20600	16QAM	H	V	21.98		
				H	20.32		

## 6.6 Field strength of spurious radiation measurement

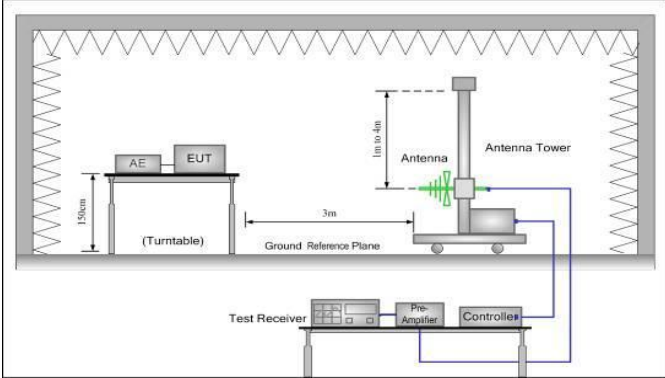
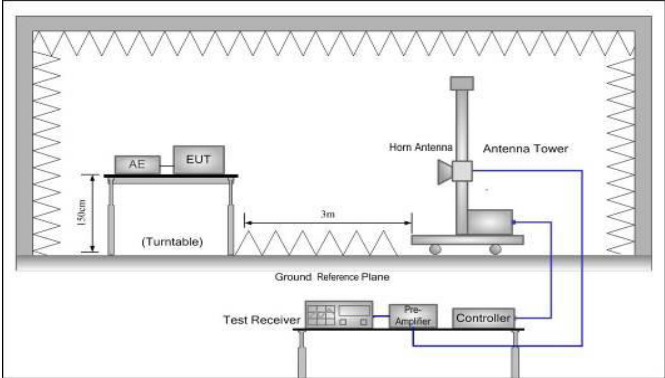
Test Requirement:	Part 22.917(b)
Test Method:	ANSI/TIA-603-D 2010
Limit:	LTE Band 5: The power of any emission outside a licensee's frequency block shall be attenuated below the transmitter power (P) in watts by at least $43 + 10 \log_{10}(P)$ dB (-13 dBm).
Test setup:	<p>Below 1GHz</p>  <p>Above 1GHz</p> 
Test Procedure:	<ol style="list-style-type: none"> <li>1. The EUT was placed on a non-conductive turntable using a non-conductive support. The radiated emission at the fundamental frequency was measured at 3 m with a test antenna and EMI spectrum analyzer.</li> <li>2. During the tests, the antenna height and the EUT azimuth were varied in order to identify the maximum level of emissions from the EUT. This maximization process was repeated with the EUT positioned in each of its three orthogonal orientations.</li> <li>3. The frequency range up to tenth harmonic was investigated for each of three fundamental frequency (low, middle and high channels). Once spurious emission was identified, the power of the emission was determined using the substitution method.</li> <li>4. The spurious emissions attenuation was calculated as the difference between radiated power at the fundamental frequency and the spurious emissions frequency.  <math display="block">ERP / EIRP = S.G. \text{ output (dBm)} + \text{Antenna Gain(dB/dBi)} - \text{Cable Loss (dB)}</math> </li> </ol>
Test Instruments:	Refer to section 5.9 for details
Test mode:	Refer to section 5.3 for details.
Test results:	Passed

**Measurement Data:**

**LTE Band 5 part:**

LTE Band 5, WB: 1.4MHz				
RB size 1 & RB offset 0				
Frequency (MHz)	Spurious Emission		Limit (dBm)	Result
	Polarization	Level (dBm)		
<b>Lowest Channel</b>				
1649.40	Vertical	-58.64	-13.00	Pass
2474.10	V	-51.31		
3298.80	V	-49.03		
1649.40	Horizontal	-57.94		
2474.10	H	-54.29		
3298.80	H	-48.26		
<b>Middle Channel</b>				
1673.00	Vertical	-56.12	-13.00	Pass
2509.50	V	-53.81		
3346.00	V	-48.42		
1673.00	Horizontal	-56.88		
2509.50	H	-53.97		
3346.00	H	-47.57		
<b>Highest Channel</b>				
1696.60	Vertical	-57.90	-13.00	Pass
2544.90	V	-53.53		
3393.20	V	-48.17		
1696.60	Horizontal	-58.38		
2544.90	H	-51.97		
3393.20	H	-49.58		
<p><i>Note:</i></p> <ol style="list-style-type: none"> <li><i>The emission levels of below 1 GHz are 20 dB lower than the limit so not show in this report.</i></li> <li><i>For above 1 GHz, all test modes were performed, and just the worst case shown in the report.</i></li> </ol>				

LTE Band 5, WB: 3MHz				
RB size 1 & RB offset 0				
Frequency (MHz)	Spurious Emission		Limit (dBm)	Result
	Polarization	Level (dBm)		
<b>Lowest Channel</b>				
1653.00	Vertical	-58.34	-13.00	Pass
2479.50	V	-51.26		
3306.00	V	-49.36		
1653.00	Horizontal	-57.21		
2479.50	H	-54.30		
3306.00	H	-48.93		
<b>Middle Channel</b>				
1673.00	Vertical	-55.16	-13.00	Pass
2509.50	V	-53.29		
3346.00	V	-48.37		
1673.00	Horizontal	-56.55		
2509.50	H	-53.71		
3346.00	H	-47.22		
<b>Highest Channel</b>				
1693.00	Vertical	-57.21	-13.00	Pass
2539.50	V	-53.99		
3386.00	V	-48.26		
1693.00	Horizontal	-58.71		
2539.50	H	-51.26		
3386.00	H	-49.38		
<p><i>Note:</i></p> <ol style="list-style-type: none"> <li><i>The emission levels of below 1 GHz are 20 dB lower than the limit so not show in this report.</i></li> <li><i>For above 1 GHz, all test modes were performed, and just the worst case shown in the report.</i></li> </ol>				



LTE Band 5, WB: 5MHz				
RB size 1 & RB offset 0				
Frequency (MHz)	Spurious Emission		Limit (dBm)	Result
	Polarization	Level (dBm)		
<b>Lowest Channel</b>				
1651.00	Vertical	-58.64	-13.00	Pass
2476.50	V	-51.49		
3302.00	V	-49.22		
1651.00	Horizontal	-57.35		
2476.50	H	-54.14		
3302.00	H	-48.22		
<b>Middle Channel</b>				
1673.00	Vertical	-56.58	-13.00	Pass
2509.50	V	-53.22		
3346.00	V	-48.24		
1673.00	Horizontal	-56.90		
2509.50	H	-53.20		
3346.00	H	-47.92		
<b>Highest Channel</b>				
1695.00	Vertical	-57.68	-13.00	Pass
2542.50	V	-53.21		
3390.00	V	-48.55		
1695.00	Horizontal	-58.29		
2542.50	H	-51.33		
3390.00	H	-49.31		
<p><i>Note:</i></p> <ol style="list-style-type: none"> <li><i>The emission levels of below 1 GHz are 20 dB lower than the limit so not show in this report.</i></li> <li><i>For above 1 GHz, all test modes were performed, and just the worst case shown in the report.</i></li> </ol>				

LTE Band 5, WB: 10MHz				
RB size 1 & RB offset 0				
Frequency (MHz)	Spurious Emission		Limit (dBm)	Result
	Polarization	Level (dBm)		
<b>Lowest Channel</b>				
1658.00	Vertical	-58.03	-13.00	Pass
2487.00	V	-51.34		
3316.00	V	-49.21		
1658.00	Horizontal	-57.21		
2487.00	H	-54.30		
3316.00	H	-48.92		
<b>Middle Channel</b>				
1673.00	Vertical	-56.92	-13.00	Pass
2509.50	V	-53.41		
3346.00	V	-48.92		
1673.00	Horizontal	-56.39		
2509.50	H	-53.71		
3346.00	H	-47.55		
<b>Highest Channel</b>				
1688.00	Vertical	-57.29	-13.00	Pass
2532.00	V	-53.92		
3376.00	V	-48.31		
1688.00	Horizontal	-58.59		
2532.00	H	-51.71		
3376.00	H	-49.33		
<p><i>Note:</i></p> <ol style="list-style-type: none"> <li><i>The emission levels of below 1 GHz are 20 dB lower than the limit so not show in this report.</i></li> <li><i>For above 1 GHz, all test modes were performed, and just the worst case shown in the report.</i></li> </ol>				

## 6.7 Frequency stability V.S. Temperature measurement

Test Requirement:	Part 22.355, Part 2.1055(a)(1)(b)
Test Method:	ANSI/TIA-603-D 2010
Limit:	±2.5ppm
Test setup:	
Test procedure:	<ol style="list-style-type: none"> <li>1. The equipment under test was connected to an external DC power supply and input rated voltage.</li> <li>2. RF output was connected to a frequency counter or spectrum analyzer via feed through attenuators.</li> <li>3. The EUT was placed inside the temperature chamber.</li> <li>4. Set the spectrum analyzer RBW low enough to obtain the desired frequency resolution and measure EUT 25°C operating frequency as reference frequency.</li> <li>5. Turn EUT off and set the chamber temperature to -30°C. After the temperature stabilized for approximately 30 minutes recorded the frequency.</li> <li>6. Repeat step measure with 10°C increased per stage until the highest temperature of +50°C reached</li> </ol>
Test Instruments:	Refer to section 5.9 for details
Test mode:	Refer to section 5.3 for details
Test results:	Passed

**Measurement Data (worst case):**

**LTE Band 5 part:**

Reference Frequency: LTE Band 5 (10MHz) Middle channel=20525 channel=836.50MHz					
Power supplied (Vdc)	Temperature (°C)	Frequency error		Limit (ppm)	Result
		Hz	ppm		
<b>QPSK</b>					
3.85	-30	198	0.236701	±2.5	Pass
	-20	155	0.185296		
	-10	163	0.194860		
	0	123	0.147041		
	10	188	0.224746		
	20	174	0.208010		
	30	114	0.136282		
	40	105	0.125523		
	50	150	0.179319		
<b>16QAM</b>					
3.85	-30	123	0.147041	±2.5	Pass
	-20	150	0.179319		
	-10	166	0.198446		
	0	122	0.145846		
	10	144	0.172146		
	20	140	0.167364		
	30	156	0.186491		
	40	133	0.158996		
	50	138	0.164973		
<i>Note: Only the worst case shown in the report.</i>					

## 6.8 Frequency stability V.S. Voltage measurement

Test Requirement:	Part 22.355, Part 2.1055(d)(2)
Test Method:	ANSI/TIA-603-D 2010
Limit:	±2.5ppm
Test setup:	
Test procedure:	<ol style="list-style-type: none"> <li>1. Set chamber temperature to 25°C. Use a variable DC power source to power the EUT and set the voltage to rated voltage.</li> <li>2. Set the spectrum analyzer RBW low enough to obtain the desired frequency resolution and recorded the frequency.</li> <li>3. Reduce the input voltage to specify extreme voltage variation (+/- 15%) and endpoint, record the maximum frequency change.</li> </ol>
Test Instruments:	Refer to section 5.9 for details
Test mode:	Refer to section 5.3 for details
Test results:	Passed

**Measurement Data (worst case):**

**LTE Band 5 part:**

Reference Frequency: LTE Band 5(10MHz) Middle channel=20525 channel=836.50MHz					
Temperature (°C)	Power supplied (Vdc)	Frequency error		Limit (ppm)	Result
		Hz	ppm		
QPSK					
25	4.40	98	0.117155	±2.5	Pass
	3.85	65	0.077705		
	3.50	74	0.088464		
16QAM					
25	4.40	80	0.095637	±2.5	Pass
	3.85	96	0.114764		
	3.50	48	0.057382		
<i>Note: Only the worst case shown in the report.</i>					