

FCC Test Report

Part 15 subpart C

Client Information:

Applicant : Chengdu XGimi Technology Co.,Ltd.
Applicant add.: 5F,Building A7,Tianfu Software Park, Tianfu Avenue,Hi-tech
Zone,Chengdu,China.

EUT Information:

EUT Name : LED Projector
Model No. : XEC09 (Refer to page 5)
Brand Name : XGIMI
FCC ID : 2AFENXEC09

Prepared By:

DongGuan NTEK Testing Technology Co., Ltd.
Add. : 5/F, Building 11, Creative Industry Center Park, No. 34 Guantai Road,
Guancheng District, Dong Guan, 523000, P.R.China
Date of Receipt: Sep. 25, 2015 Date of Test: Sep. 26~ Oct. 07, 2015
Date of Issue: Oct. 07, 2015 Test Result: **Pass**

Test procedure used: ANSI C63.4-2009

This device described above has been tested by DongGuan NTEK Testing Technology Co., Ltd., and the test results show that the equipment under test (EUT) is in compliance with the FCC requirements. And it is applicable only to the tested sample identified in the report.

*This test report must not be used by the client to claim product endorsement by any agency of the U.S. government.

Reviewed by: Yandy Xie
Yandy Xie

Approved by: Lori Mei
Lori Mei

1 Contents

Page

COVER PAGE	
1 CONTENTS	2
2 TEST SUMMARY	4
2.1 COMPLIANCE WITH FCC PART 15 SUBPART C	4
2.2 MEASUREMENT UNCERTAINTY	4
3 GENERAL INFORMATION	5
3.1 GENERAL DESCRIPTION OF EUT	5
3.2 DESCRIPTION OF TEST CONDITIONS	7
3.3 EUT PERIPHERAL LIST	8
3.4 TEST PERIPHERAL LIST	8
3.5 TEST LOCATION	8
4 EQUIPMENTS LIST FOR ALL TEST ITEMS	9
5 TEST RESULT	10
5.1 ANTENNA REQUIREMENT	10
5.1.1 Standard requirement	10
5.1.2 EUT Antenna	10
5.2 CONDUCTION EMISSIONS MEASUREMENT	11
5.2.1 Applied procedures / Limit	11
5.2.2 Test procedure	11
5.2.3 Test results	12
5.3 RADIATED EMISSIONS MEASUREMENT	14
5.3.1 Applied procedures / Limit	14
5.3.2 Test procedure	14
5.3.3 Test Result	15
5.3.4 TEST RESULTS (Restricted Bands Requirements)	43
5.4 BANDWIDTH TEST	47
5.4.1 Applied procedures / Limit	47
5.4.2 Test procedure	47
5.4.3 Deviation from standard	47
5.4.4 Test setup	47
5.4.5 Test results	48
5.5 MAXIMUM PEAK OUTPUT POWER	63
5.5.1 Applied procedures / Limit	63
5.5.2 Test procedure	63
5.5.3 Deviation from standard	63
5.5.4 Test setup	63
5.5.5 Test results	64
5.6 PEAK POWER SPECTRAL DENSITY	67
5.6.1 Applied procedures / Limit	67

5.6.2	Test procedure.....	67
5.6.3	Deviation from standard.....	67
5.6.4	Test setup	67
5.6.5	Test results	68
5.7	BAND EDGE	83
5.7.1	Applied procedures / Limit	83
5.7.2	Test procedure.....	83
5.7.3	Deviation from standard.....	83
5.7.4	Test setup	83
5.7.5	Test results	84

2 Test Summary

2.1 Compliance with FCC Part 15 subpart C

Test	Test Requirement	Standard Paragraph	Result
Antenna Requirement	FCC Part 15 C:2013	Section 15.247(c)	PASS
Conduction Emissions	FCC Part 15 C:2013	Section 15.207(a)	PASS
Radiated Emissions	FCC Part 15 C:2013	Section 15.247(d)	PASS
6 dB Bandwidth	FCC Part 15 C:2013	Section 15.247 (a)	PASS
Maximum Peak Output Power	FCC Part 15 C:2013	Section 15.247(b) KDB-558074 D01 v03r03 Clause 9.1.2	PASS
Peak Power Spectral Density	FCC Part 15 C:2013	Section 15.247(e)	PASS
Band edge	FCC Part 15 C:2013	Section 15.247(d)	PASS
Conducted Spurious Emissions	FCC Part 15 C:2013	Section 15.247(d)	PASS

2.2 Measurement Uncertainty

All measurements involve certain levels of uncertainties, The following measurements uncertainty Levels have estimated based on ANSI C63.4:2009, the maximum value of the uncertainty as below

No.	Item	Uncertainty
1	Conducted Emission Test	±1.38dB
2	Radiated Emission Test	±3.57dB

3 General Information

3.1 General Description of EUT

Manufacturer:	(1) Fujian Ruichi electronic technology CO., LTD. (2) TCL King electrical appliances (Chengdu) CO., LTD.
Manufacturer Address:	(1) No. C-09 land of the first planning about special automobile foundation in Quanzhou city of China. (2) Chengdu high-tech industrial development zone (west park), Chengdu, Sichuan, China
EUT Name:	LED Projector
Model No:	XEC09
Brand Name:	XGIMI
Serial No:	XEC10,XEC11,XEC12,XEC13,XEC14,XEC15,XEC16,XEC17,XEC18,XEC19, XEC20,XEC21,XEC22,XEC23,WEC59,WEC60,WEC61,WEC62,WEC63, WEC64,WEC65,WEC66,WEC67,WEC68,WEC69,WEC70,WEC71,WEC72, WEC73,WEC74,WEC75,WEC76,WEC77,WEC78,WEC79,WEC80,WEC81, WEC82,WEC83,WEC84,WEC85,WEC86,WEC87,WEC88
Operation frequency:	2412 MHz to 2462 MHz for 802.11b/g/n(HT20) 2422 MHz to 2452 MHz for 802.11n(HT40) 5745 MHz to 5825 MHz for 802.11a/n/ac
Channel Number:	11 Channels for 802.11b/g/n(HT20) 7 Channels for 802.11n(HT40)
Modulation Technology:	802.11b: DSSS(CCK/QPSK/BPSK) 802.11g/n: OFDM(BPSK/QPSK/16QAM/64QAM) 802.11a/n: OFDM(BPSK/QPSK/16QAM/64QAM) 802.11ac: OFDM(BPSK/QPSK/16QAM/64QAM/256QAM)
Channel Separation:	2.4G: 5 MHz, 5G: 10MHz
Antenna Type:	Integral
Antenna Gain:	2.0 dBi
Power Supply Range:	DC 19V from adapter
Power Supply:	DC 19V from adapter, AC 120V/60Hz for adapter
Power Cord:	1.5 m x 3 wires unscreened AC mains cable 1.8 m x 2 wires unscreened DC mains cable

Note:

- For a more detailed features description, please refer to the manufacturer's specifications or the User's Manual.

- (1) Test frequencies are lowest channel: 2412 MHz, middle channel: 2437 MHz and highest channel: 2462 MHz for 802.11b/g/n(HT20)

Channel List					
Channel	Frequency (MHz)	Channel	Frequency (MHz)	Channel	Frequency (MHz)
1	2412	5	2432	9	2452
2	2417	6	2437	10	2457
3	2422	7	2442	11	2462
4	2427	8	2447		

- (2) Test frequencies are lowest channel: 2422 MHz, middle channel: 2437 MHz and highest channel: 2452 MHz for 802.11n(HT40)

Channel List					
Channel	Frequency (MHz)	Channel	Frequency (MHz)	Channel	Frequency (MHz)
3	2422	6	2437	9	2452
4	2427	7	2442		
5	2432	8	2447		

- (3) Test frequencies are lowest channel: 5745 MHz, middle channel: 5785 MHz and highest channel: 5825 MHz for 5725-5850 Band.

Channel List					
Channel	Frequency (MHz)	Channel	Frequency (MHz)	Channel	Frequency (MHz)
149	5745	155	5775	161	5805
151	5755	157	5785	165	5825
153	5765	159	5795		

- According to the declaration of the applicant, the electrical circuit design, layout, components used and internal wiring were identical for above models, with only difference being the model no.. Therefore, only one model **XEC09** was tested in this report.
- The Data Rate of 802.11b/11 Mbps, 802.11g/54 Mbps, 802.11n(HT20)/MCS=7, 802.11n(HT40)/MCS=7 for 2.4GHz Band, 802.11a/54 Mbps, 802.11n(HT20)/MCS=7, 802.11n(HT40)/MCS=7, 802.11ac(HT20)/(MCS=8,NSS1), 802.11ac(HT40)/(MCS=9,NSS1), 802.11ac(HT80)/(MCS=9,NSS1) for 5GHz Band are the worst case.

3.2 Description of Test conditions

(1) EUT was tested in normal configuration (Please See following Block diagram)

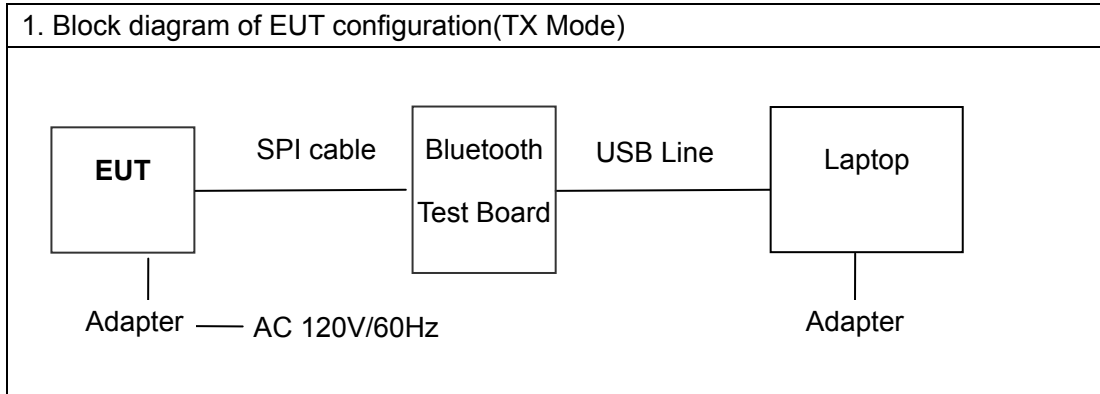

(2) E.U.T. test conditions:

15.31(e): For intentional radiators, measurements of the variation of the input power or the radiated signal level of the fundamental frequency component of the emission, as appropriate, shall be performed with the supply voltage varied between 85% and 115% of the nominal rated supply voltage. For battery operated equipment, the equipment tests shall be performed using a new battery.

(3) Test frequencies:

According to the 15.31(m) Measurements on intentional radiators or receivers, other than TV broadcast receivers, shall be performed and. If required reported for each band in which the device can be operated with the device operating at the number of frequencies in each band specified in the following table:

Frequency range over which device operates	Number of frequencies	Location in the range of operation
1 MHz or less	1	Middle
1 to 10 MHz	2	1 near top and 1 near bottom
More than 10 MHz	3	1 near top, 1 near middle and 1 near bottom

(4) Frequency range of radiated measurements:

According to the 15.33, The test range will be up to the tenth harmonic of the highest fundamental frequency .

3.3 EUT Peripheral List

No.	Equipment	Manufacturer	EMC Compliance	Model No.	Serial No.	Power cord	signal cable
1	Adapter	DELTA	CE, FCC	ADP-90 MD H	N/A	N/A	N/A
2	AC Line(adapt er)	N/A	N/A	N/A	N/A	1.5m /unshielded /detachable	N/A
3	DC Line(adapt er)	N/A	N/A	N/A	N/A	1.8m /unshielded /detachable	N/A
4	remote control	N/A	N/A	N/A	N/A	N/A	N/A

3.4 Test Peripheral List

No.	Equipment	Manufacturer	EMC Compliance	Model No.	Serial No.	Power cord	signal cable
1	Lap top	ASUS	N/A	X401A	X16-96072	N/A	N/A
2	Adapter (laptop)	ASUS	N/A	EXA0703 YH	N/A	1.8m/unshielded /detachable	N/A

3.5 Test Location

All tests were performed at:

NTEK Testing Technology Co., Ltd

1/F, Building E, Fenda Science Park, Sanwei Community, Xixiang Street

Bao' an District, Shenzhen P.R. China

The FCC Registration No. of NTEK Testing Technology Co., Ltd is 238937.

4 Equipments List for All Test Items

No	Test Equipment	Manufacturer	Model No	Serial No	Cal. Date	Cal. Due Date
1	Spectrum Analyzer	ADVANTEST	R3182	150900201	2014.10.16	2015.10.15
2	EMI Measuring Receiver	Schaffner	SCR3501	235	2014.10.16	2015.10.15
3	Low Noise Pre Amplifier	Tsj	MLA-10K01-B01-27	1205323	2015.09.08	2016.09.07
4	Low Noise Pre Amplifier	Tsj	MLA-0120-A02-34	2648A04738	2015.04.08	2016.04.07
5	TRILOG Super Broadband test Antenna	SCHWARZBECK	VULB9160	9160-3206	2015.07.05	2016.07.04
6	Broadband Horn Antenna	SCHWARZBECK	BBHA9120A	451	2015.07.05	2016.07.04
7	50Ω Coaxial Switch	Anritsu	MP59B	6200264416	2015.09.08	2016.09.07
8	EMI Test Receiver	R&S	ESCI	100124	2014.12.29	2015.12.28
9	LISN	Kyoritsu	KNW-242	8-837-4	2015.04.08	2016.04.07
10	LISN	Kyoritsu	KNW-407	8-1789-3	2015.04.08	2016.04.07
11	50Ω Coaxial Switch	Anritsu	MP59B	6200264417	2015.04.08	2016.04.07
12	Loop Antenna	ARA	PLA-1030/B	1029	2015.04.08	2016.04.07
13	Power Meter	Anritsu	ML2495A	1204008	2015.06.17	2016.06.16
14	EMI Test Receiver	Rohde & Schwarz	ESIB26	100394	2015.04.08	2016.04.07
15	Power sensor	Anritsu	MA2411B	1126168	2015.06.17	2016.06.16
16	Spectrum Analyzer	Agilent	E4407B	MY45108040	2015.09.08	2016.09.07

5 Test Result

5.1 Antenna Requirement

5.1.1 Standard requirement

15.203 requirement: For intentional device, according to 15.203: an intentional radiator shall be designed to ensure that no antenna other than that furnished by the responsible party shall be used with the device.

15.247(c) (1)(i) requirement: (i) Systems operating in the 2400-2483.5 MHz band and 5725-5850 MHz band that is used exclusively for fixed. Point-to-point operations may employ transmitting antennas with directional gain greater than 6dBi provided the maximum conducted output power of the intentional radiator is reduced by 1 dB for every 3 dB that the directional gain of the antenna exceeds 6dBi.

5.1.2 EUT Antenna

The 2.4GHz antenna is integrated on the main PCB and no consideration of replacement. Antenna gain is max 2.0 dBi from 2.4GHz to 2.5GHz.

The 5GHz antenna is integrated on the main PCB and no consideration of replacement. Antenna gain is max 2.0 dBi from 5.725 to 5.850GHz.

5.2 Conduction Emissions Measurement

5.2.1 Applied procedures / Limit

Frequency of Emission (MHz)	Conducted Limit (dB μ V)	
	Quasi-peak	Average
0.15-0.5	66 to 56 *	56 to 46 *
0.5-5	56	46
5-30	60	50

Note: Decreases with the logarithm of the frequency.

5.2.2 Test procedure

EUT was placed upon a wooden test table 0.8m above the horizontal metal reference plane and 0.4m from the vertical ground plane, and it was connected to an AMN. The closest distance between the boundary of the EUT and the surface of the AMN is 0.8m. All peripherals were connected to another AMN, and placed at a distance of 10cm from each other. A spectrum and receiver was connected to the RF output port of the AMN. Both average and quasi-peak value were detected.

5.2.3 Test results

EUT:	LED Projector	Model Name. :	XEC09
Temperature:	26 °C	Relative Humidity:	54%
Pressure:	1010hPa	Test Date :	2015-09-30
Test Mode:	TX	Phase :	Line
Test Voltage :	DC 19V from adapter, AC 120V/60Hz for adapter		

Level(dBuV)

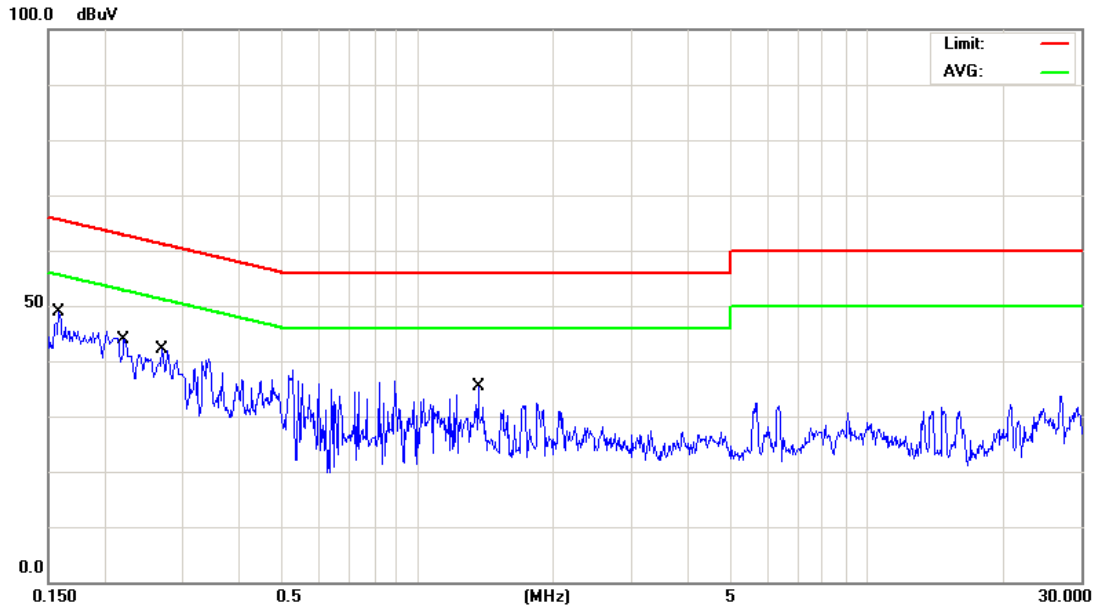

Measure data:

No.	Mk.	Freq. MHz	Reading Level dBuV	Correct Factor dB	Measure- ment dBuV	Limit dBuV	Over dB	Detector
1		0.1580	45.96	2.94	48.90	65.56	-16.66	QP
2	*	0.1580	38.36	2.94	41.30	55.56	-14.26	AVG
3		0.2220	32.59	1.94	34.53	52.74	-18.21	AVG
4		0.2700	40.25	1.80	42.05	61.12	-19.07	QP
5		1.3619	25.29	9.96	35.25	56.00	-20.75	QP
6		1.3619	20.09	9.96	30.05	46.00	-15.95	AVG

EUT:	LED Projector	Model Name. :	XEC09
Temperature:	26 °C	Relative Humidity:	54%
Pressure:	1010hPa	Test Date :	2015-09-30
Test Mode:	TX	Phase :	Neutral
Test Voltage :	DC 19V from adapter, AC 120V/60Hz for adapter		

Level(dBμV)

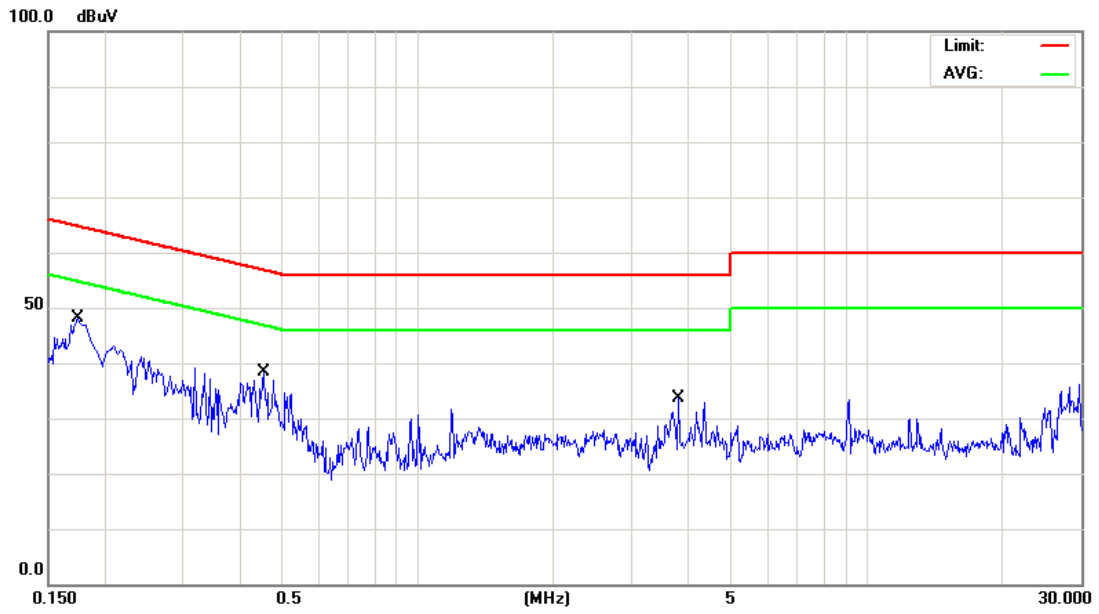

Measure result:

No.	Mk.	Freq.	Reading	Correct	Measure-	Limit	Over	
		MHz	Level	Factor	ment			Detector
			dBμV	dB	dBμV	dBμV	dB	
1		0.1737	45.77	2.45	48.22	64.78	-16.56	QP
2	*	0.1737	37.99	2.45	40.44	54.78	-14.34	AVG
3		0.4515	32.09	6.21	38.30	56.85	-18.55	QP
4		0.4515	23.52	6.21	29.73	46.85	-17.12	AVG
5		3.8180	23.55	10.05	33.60	56.00	-22.40	QP
6		3.8180	15.74	10.05	25.79	46.00	-20.21	AVG

5.3 Radiated Emissions Measurement

5.3.1 Applied procedures / Limit

15.247(d) In any 100 kHz bandwidth outside the frequency band in which the spread spectrum or digitally modulated intentional radiator is operating, the radio frequency power that is produced by the intentional radiator shall be at least 20 dB below that in the 100 kHz bandwidth within the band that contains the highest level of the desired power, based on either an RF conducted or a radiated measurement, provided the transmitter demonstrates compliance with the peak conducted power limits. If the transmitter complies with the conducted power limits based on the use of RMS averaging over a time interval, as permitted under paragraph (b)(3) of this section, the attenuation required under this paragraph shall be 30 dB instead of 20 dB. Attenuation below the general limits specified in Section 15.209(a) is not required. In addition, radiated emissions which fall in the restricted bands, as defined in Section 15.205(a), must also comply with the radiated emission limits specified in Section 15.209(a) (see Section 15.205(c)).

Frequency of Emission (MHz)	Field Strength		Measurement Distance (meters)
	$\mu\text{V/m}$	$\text{dB}\mu\text{V/m}$	
0.009-0.49	2400/F(kHz)		300
0.49-1.705	24000/F(kHz)		30
1.705-30	30		30
30-88	100	40	3
88-216	150	43.5	3
216-960	200	46	3
Above 960	500	54	3

5.3.2 Test procedure

EUT was placed upon a wooden test table which was placed on the turn table 0.8m above the horizontal metal ground plane, and operating in the mode as mentioned above. A receiving antenna was placed 3m away from the EUT. During testing, turn around the turn table and move the antenna from 1m to 4m to find the maximum field-strength reading. All peripherals were placed at a distance of 10cm between each other. Both horizontal and vertical antenna polarities were tested and performed pretest to three orthogonal axis. The worst case emissions were reported.

5.3.3 Test Result

There is not detected below 30MHz.

EUT:	LED Projector	Model Name :	XEC09
Temperature:	25 °C	Test Data	2015-09-30
Pressure:	1010 hPa	Relative Humidity:	60%
Test Mode :	TX	Test Voltage :	DC 19V from adapter, AC 120V/60Hz for adapter
Measurement Distance	3 m	Frenqucy Range	30MHz to 1GHz
RBW/VBW	100KHz / 300KHz for spectrum, RBW=120KHz for receiver.		

(a) Antenna polarization: Horizontal

Peak scan

Level (dB μ V/m)

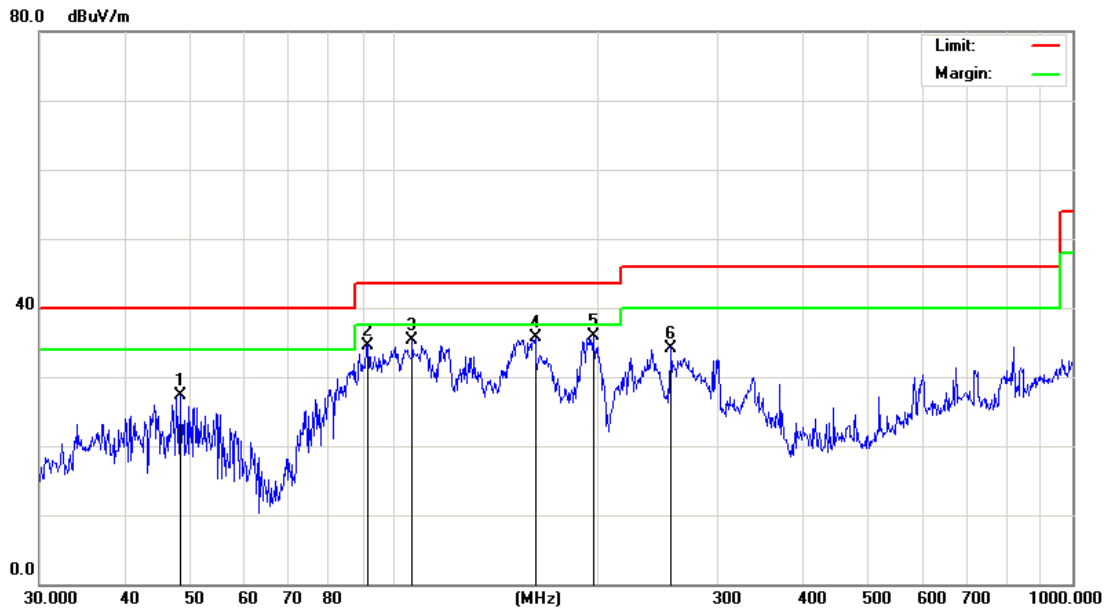

Quasi-peak measurement

No.	Mk.	Freq.	Reading Level	Correct Factor	Measure-ment	Limit	Over	Detector
		MHz	dB μ V	dB	dB μ V/m	dB μ V/m	dB	
1		48.3318	45.70	-18.40	27.30	40.00	-12.70	peak
2		91.4949	52.80	-18.20	34.60	43.50	-8.90	peak
3		106.3850	48.90	-13.50	35.40	43.50	-8.10	peak
4		161.4740	50.68	-14.88	35.80	43.50	-7.70	peak
5	*	196.5098	50.74	-14.79	35.95	43.50	-7.55	peak
6		255.6230	45.15	-10.95	34.20	46.00	-11.80	peak

(b) Antenna polarization: vertical

Peak scan

Level (dB μ V/m)

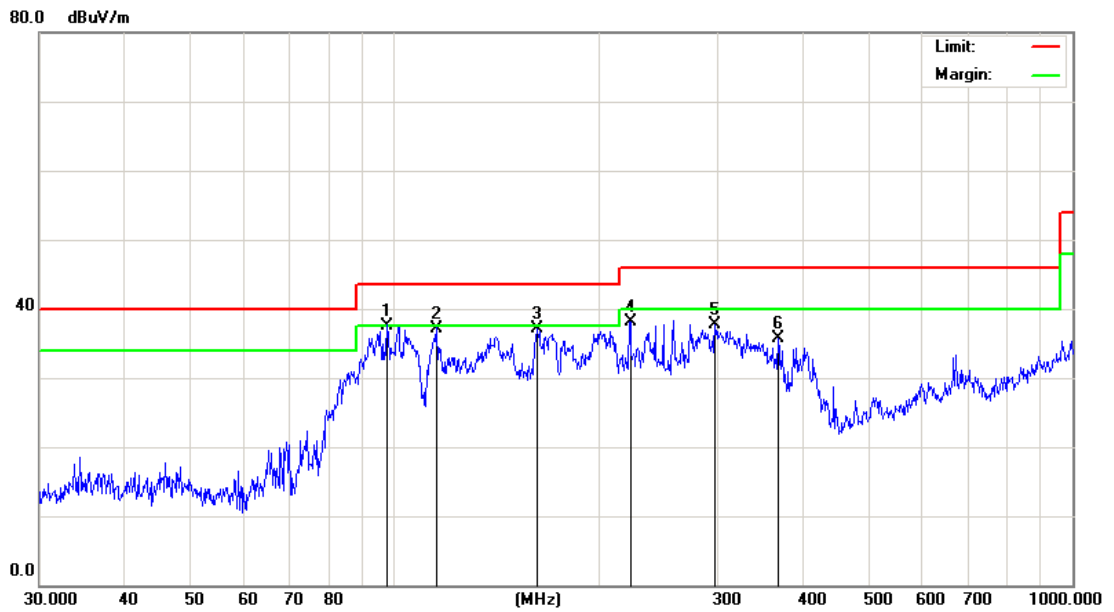

Quasi-peak measurement

No.	Mk.	Freq. MHz	Reading Level dB μ V	Correct Factor dB	Measure- ment dB μ V/m	Limit dB μ V/m	Over dB	Detector
1	*	97.4560	53.88	-16.28	37.60	43.50	-5.90	peak
2		115.3204	52.33	-15.13	37.20	43.50	-6.30	peak
3		162.6106	51.78	-14.68	37.10	43.50	-6.40	peak
4		222.9501	51.79	-13.65	38.14	46.00	-7.86	peak
5		297.2241	47.51	-9.85	37.66	46.00	-8.34	peak
6		368.1116	43.37	-7.57	35.80	46.00	-10.20	peak

Note: '*' means the worst case

Measurement Level = Reading Level + Factor

Factor = Antenna Factor + Cable Loss – Pre-amplifier

For 2.4GHz Band:

EUT:	LED Projector	Model Name :	XEC09
Temperature:	25 °C	Test Data	2015-09-30
Pressure:	1010 hPa	Relative Humidity:	60%
Test Mode :	802.11b	Test Voltage :	DC 19V from adapter, AC 120V/60Hz for adapter
Measurement Distance	3 m	Frenqucy Range	1GHz to 25GHz
RBW/VBW	1MHz/1MHz for Peak, 1MHz/10Hz for Average.		

1~25 GHz Harmonics & Spurious Emissions. Peak & Average Measurement

Vertical Measurement:

Frequency (MHz)	Reading Level (dB μ V)	factor (dB)	Emission Level (dB μ V/m)	Limit (dB μ V/m)	Margin (dB)	Antenna polarization
4824.000	43.20	5.08	48.28	74.00	-25.72	peak
4824.000	27.52	5.08	32.60	54.00	-21.40	AVG
7236.000	42.29	7.16	49.45	74.00	-24.55	peak
7236.000	26.98	7.16	34.14	54.00	-19.86	AVG

Horizontal Measurement:

Frequency (MHz)	Reading Level (dB μ V)	factor (dB)	Emission Level (dB μ V/m)	Limit (dB μ V/m)	Margin (dB)	Antenna polarization
4824.000	42.26	5.08	47.34	74.00	-26.66	peak
4824.000	28.09	5.08	33.17	54.00	-20.83	AVG
7236.000	42.05	7.16	49.21	74.00	-24.79	peak
7236.000	27.10	7.16	34.26	54.00	-19.74	AVG

Note: 8~25GHz at least have 20dBm margin. No recording in the test report.

Measurement Level = Reading Level + Factor

Factor = Antenna Factor + Cable Loss – Pre-amplifier

Lowest Channel : 2412 MHz

1~25 GHz Harmonics & Spurious Emissions. Peak & Average Measurement

Vertical Measurement:

Frequency (MHz)	Reading Level (dB μ V)	factor (dB)	Emission Level (dB μ V/m)	Limit (dB μ V/m)	Margin (dB)	Antenna polarization
4874.000	43.95	5.13	49.08	74.00	-24.92	peak
4874.000	29.10	5.13	34.23	54.00	-19.77	AVG
7311.000	42.32	7.49	49.81	74.00	-24.19	peak
7311.000	27.67	7.49	35.16	54.00	-18.84	AVG

Horizontal Measurement:

Frequency (MHz)	Reading Level (dB μ V)	factor (dB)	Emission Level (dB μ V/m)	Limit (dB μ V/m)	Margin (dB)	Antenna polarization
4874.000	43.45	5.13	48.58	74.00	-25.42	peak
4874.000	30.38	5.13	35.51	54.00	-18.49	AVG
7311.000	42.93	7.49	50.42	74.00	-23.58	peak
7311.000	27.78	7.49	35.27	54.00	-18.73	AVG

Note: 8~25GHz at least have 20dBm margin. No recording in the test report.

Measurement Level = Reading Level + Factor

Factor = Antenna Factor + Cable Loss – Pre-amplifier

Middle Channel : 2437 MHz

1~25 GHz Harmonics & Spurious Emissions. Peak & Average Measurement

Vertical Measurement:

Frequency (MHz)	Reading Level (dB μ V)	factor (dB)	Emission Level (dB μ V/m)	Limit (dB μ V/m)	Margin (dB)	Antenna polarization
4924.000	44.20	5.18	49.38	74.00	-24.62	peak
4924.000	31.25	5.18	36.43	54.00	-17.57	AVG
7386.000	43.42	7.82	51.24	74.00	-22.76	peak
7386.000	26.48	7.82	34.30	54.00	-19.70	AVG

Horizontal Measurement:

Frequency (MHz)	Reading Level (dB μ V)	factor (dB)	Emission Level (dB μ V/m)	Limit (dB μ V/m)	Margin (dB)	Antenna polarization
4924.000	45.57	5.18	50.75	74.00	-23.25	peak
4924.000	31.80	5.18	36.98	54.00	-17.02	AVG
7386.000	42.73	7.82	50.55	74.00	-23.45	peak
7386.000	26.55	7.82	34.37	54.00	-19.63	AVG

Note: 8~25GHz at least have 20dBm margin. No recording in the test report.

Measurement Level = Reading Level + Factor

Factor = Antenna Factor + Cable Loss – Pre-amplifier

Highest Channel : 2462 MHz

EUT:	LED Projector	Model Name :	XEC09
Temperature:	25 °C	Test Data	2015-09-30
Pressure:	1010 hPa	Relative Humidity:	60%
Test Mode :	802.11g	Test Voltage :	DC 19V from adapter, AC 120V/60Hz for adapter
Measurement Distance	3 m	Frenqucy Range	1GHz to 25GHz
RBW/VBW	1MHz/1MHz for Peak, 1MHz/10Hz for Average.		

1~25 GHz Harmonics & Spurious Emissions. Peak & Average Measurement

Vertical Measurement:

Frequency (MHz)	Reading Level (dB μ V)	factor (dB)	Emission Level (dB μ V/m)	Limit (dB μ V/m)	Margin (dB)	Antenna polarization
4824.000	43.59	5.08	48.67	74.00	-25.33	peak
4824.000	27.99	5.08	33.07	54.00	-20.93	AVG
7236.000	42.46	7.16	49.62	74.00	-24.38	peak
7236.000	27.05	7.16	34.21	54.00	-19.79	AVG

Horizontal Measurement:

Frequency (MHz)	Reading Level (dB μ V)	factor (dB)	Emission Level (dB μ V/m)	Limit (dB μ V/m)	Margin (dB)	Antenna polarization
4824.000	43.32	5.08	48.40	74.00	-25.60	peak
4824.000	28.72	5.08	33.80	54.00	-20.20	AVG
7236.000	42.11	7.16	49.27	74.00	-24.73	peak
7236.000	27.28	7.16	34.44	54.00	-19.56	AVG

Note: 8~25GHz at least have 20dBm margin. No recording in the test report.

Measurement Level = Reading Level + Factor

Factor = Antenna Factor + Cable Loss – Pre-amplifier

Lowest Channel : 2412 MHz

1~25 GHz Harmonics & Spurious Emissions. Peak & Average Measurement

Vertical Measurement:

Frequency (MHz)	Reading Level (dB μ V)	factor (dB)	Emission Level (dB μ V/m)	Limit (dB μ V/m)	Margin (dB)	Antenna polarization
4874.000	43.46	5.13	48.59	74.00	-25.41	peak
4874.000	29.33	5.13	34.46	54.00	-19.54	AVG
7311.000	42.54	7.49	50.03	74.00	-23.97	peak
7311.000	27.77	7.49	35.26	54.00	-18.74	AVG

Horizontal Measurement:

Frequency (MHz)	Reading Level (dB μ V)	factor (dB)	Emission Level (dB μ V/m)	Limit (dB μ V/m)	Margin (dB)	Antenna polarization
4874.000	43.08	5.13	48.21	74.00	-25.79	peak
4874.000	30.67	5.13	35.80	54.00	-18.20	AVG
7311.000	42.49	7.49	49.98	74.00	-24.02	peak
7311.000	27.58	7.49	35.07	54.00	-18.93	AVG

Note: 8~25GHz at least have 20dBm margin. No recording in the test report.

Measurement Level = Reading Level + Factor

Factor = Antenna Factor + Cable Loss – Pre-amplifier

Middle Channel : 2437 MHz

1~25 GHz Harmonics & Spurious Emissions. Peak & Average Measurement

Vertical Measurement:

Frequency (MHz)	Reading Level (dB μ V)	factor (dB)	Emission Level (dB μ V/m)	Limit (dB μ V/m)	Margin (dB)	Antenna polarization
4924.000	44.55	5.18	49.73	74.00	-24.27	peak
4924.000	31.37	5.18	36.55	54.00	-17.45	AVG
7386.000	43.56	7.82	51.38	74.00	-22.62	peak
7386.000	26.94	7.82	34.76	54.00	-19.24	AVG

Horizontal Measurement:

Frequency (MHz)	Reading Level (dB μ V)	factor (dB)	Emission Level (dB μ V/m)	Limit (dB μ V/m)	Margin (dB)	Antenna polarization
4924.000	45.69	5.18	50.87	74.00	-23.13	peak
4924.000	31.07	5.18	36.25	54.00	-17.75	AVG
7386.000	42.37	7.82	50.19	74.00	-23.81	peak
7386.000	26.21	7.82	34.03	54.00	-19.97	AVG

Note: 8~25GHz at least have 20dBm margin. No recording in the test report.

Measurement Level = Reading Level + Factor

Factor = Antenna Factor + Cable Loss – Pre-amplifier

Highest Channel : 2462 MHz

EUT:	LED Projector	Model Name :	XEC09
Temperature:	25 °C	Test Data	2015-09-30
Pressure:	1010 hPa	Relative Humidity:	60%
Test Mode :	802.11n(HT20)	Test Voltage :	DC 19V from adapter, AC 120V/60Hz for adapter
Measurement Distance	3 m	Frenqucy Range	1GHz to 25GHz
RBW/VBW	1MHz/1MHz for Peak, 1MHz/10Hz for Average.		

1~25 GHz Harmonics & Spurious Emissions. Peak & Average Measurement

Vertical Measurement:

Frequency (MHz)	Reading Level (dB μ V)	factor (dB)	Emission Level (dB μ V/m)	Limit (dB μ V/m)	Margin (dB)	Antenna polarization
4824.000	44.12	5.08	49.20	74.00	-24.80	peak
4824.000	28.09	5.08	33.17	54.00	-20.83	AVG
7236.000	42.67	7.16	49.83	74.00	-24.17	peak
7236.000	27.58	7.16	34.74	54.00	-19.26	AVG

Horizontal Measurement:

Frequency (MHz)	Reading Level (dB μ V)	factor (dB)	Emission Level (dB μ V/m)	Limit (dB μ V/m)	Margin (dB)	Antenna polarization
4824.000	43.67	5.08	48.75	74.00	-25.25	peak
4824.000	28.27	5.08	33.35	54.00	-20.65	AVG
7236.000	42.48	7.16	49.64	74.00	-24.36	peak
7236.000	27.59	7.16	34.75	54.00	-19.25	AVG

Note: 8~25GHz at least have 20dBm margin. No recording in the test report.

Measurement Level = Reading Level + Factor

Factor = Antenna Factor + Cable Loss – Pre-amplifier

Lowest Channel : 2412 MHz

1~25 GHz Harmonics & Spurious Emissions. Peak & Average Measurement

Vertical Measurement:

Frequency (MHz)	Reading Level (dB μ V)	factor (dB)	Emission Level (dB μ V/m)	Limit (dB μ V/m)	Margin (dB)	Antenna polarization
4874.000	43.76	5.13	48.89	74.00	-25.11	peak
4874.000	30.21	5.13	35.34	54.00	-18.66	AVG
7311.000	42.01	7.49	49.50	74.00	-24.50	peak
7311.000	27.64	7.49	35.13	54.00	-18.87	AVG

Horizontal Measurement:

Frequency (MHz)	Reading Level (dB μ V)	factor (dB)	Emission Level (dB μ V/m)	Limit (dB μ V/m)	Margin (dB)	Antenna polarization
4874.000	43.88	5.13	49.01	74.00	-24.99	peak
4874.000	30.97	5.13	36.10	54.00	-17.90	AVG
7311.000	42.18	7.49	49.67	74.00	-24.33	peak
7311.000	27.04	7.49	34.53	54.00	-19.47	AVG

Note: 8~25GHz at least have 20dBm margin. No recording in the test report.

Measurement Level = Reading Level + Factor

Factor = Antenna Factor + Cable Loss – Pre-amplifier

Middle Channel : 2437 MHz

1~25 GHz Harmonics & Spurious Emissions. Peak & Average Measurement

Vertical Measurement:

Frequency (MHz)	Reading Level (dB μ V)	factor (dB)	Emission Level (dB μ V/m)	Limit (dB μ V/m)	Margin (dB)	Antenna polarization
4924.000	44.78	5.18	49.96	74.00	-24.04	peak
4924.000	31.57	5.18	36.75	54.00	-17.25	AVG
7386.000	43.72	7.82	51.54	74.00	-22.46	peak
7386.000	26.64	7.82	34.46	54.00	-19.54	AVG

Horizontal Measurement:

Frequency (MHz)	Reading Level (dB μ V)	factor (dB)	Emission Level (dB μ V/m)	Limit (dB μ V/m)	Margin (dB)	Antenna polarization
4924.000	45.24	5.18	50.42	74.00	-23.58	peak
4924.000	31.37	5.18	36.55	54.00	-17.45	AVG
7386.000	42.08	7.82	49.90	74.00	-24.10	peak
7386.000	26.41	7.82	34.23	54.00	-19.77	AVG

Note: 8~25GHz at least have 20dBm margin. No recording in the test report.

Measurement Level = Reading Level + Factor

Factor = Antenna Factor + Cable Loss – Pre-amplifier

Highest Channel : 2462 MHz

EUT:	LED Projector	Model Name :	XEC09
Temperature:	25 °C	Test Data	2015-09-30
Pressure:	1010 hPa	Relative Humidity:	60%
Test Mode :	802.11n(HT40)	Test Voltage :	DC 19V from adapter, AC 120V/60Hz for adapter
Measurement Distance	3 m	Frenqucy Range	1GHz to 25GHz
RBW/VBW	1MHz/1MHz for Peak, 1MHz/10Hz for Average.		

1~25 GHz Harmonics & Spurious Emissions. Peak & Average Measurement

Vertical Measurement:

Frequency (MHz)	Reading Level (dB μ V)	factor (dB)	Emission Level (dB μ V/m)	Limit (dB μ V/m)	Margin (dB)	Antenna polarization
4844.000	45.21	5.11	50.32	74.00	-23.68	peak
4844.000	28.77	5.11	33.88	54.00	-20.12	AVG
7266.000	42.17	7.29	49.46	74.00	-24.54	peak
7266.000	27.58	7.29	34.87	54.00	-19.13	AVG

Horizontal Measurement:

Frequency (MHz)	Reading Level (dB μ V)	factor (dB)	Emission Level (dB μ V/m)	Limit (dB μ V/m)	Margin (dB)	Antenna polarization
4844.000	43.46	5.11	48.57	74.00	-25.43	peak
4844.000	28.50	5.11	33.61	54.00	-20.39	AVG
7266.000	42.98	7.29	50.27	74.00	-23.73	peak
7266.000	27.86	7.29	35.15	54.00	-18.85	AVG

Note: 8~25GHz at least have 20dBm margin. No recording in the test report.

Measurement Level = Reading Level + Factor

Factor = Antenna Factor + Cable Loss – Pre-amplifier

Lowest Channel : 2422 MHz

1~25 GHz Harmonics & Spurious Emissions. Peak & Average Measurement

Vertical Measurement:

Frequency (MHz)	Reading Level (dB μ V)	factor (dB)	Emission Level (dB μ V/m)	Limit (dB μ V/m)	Margin (dB)	Antenna polarization
4874.000	43.26	5.13	48.39	74.00	-25.61	peak
4874.000	30.69	5.13	35.82	54.00	-18.18	AVG
7311.000	42.33	7.49	49.82	74.00	-24.18	peak
7311.000	27.52	7.49	35.01	54.00	-18.99	AVG

Horizontal Measurement:

Frequency (MHz)	Reading Level (dB μ V)	factor (dB)	Emission Level (dB μ V/m)	Limit (dB μ V/m)	Margin (dB)	Antenna polarization
4874.000	43.77	5.13	48.90	74.00	-25.10	peak
4874.000	30.82	5.13	35.95	54.00	-18.05	AVG
7311.000	42.46	7.49	49.95	74.00	-24.05	peak
7311.000	27.55	7.49	35.04	54.00	-18.96	AVG

Note: 8~25GHz at least have 20dBm margin. No recording in the test report.

Measurement Level = Reading Level + Factor

Factor = Antenna Factor + Cable Loss – Pre-amplifier

Middle Channel : 2437 MHz

1~25 GHz Harmonics & Spurious Emissions. Peak & Average Measurement

Vertical Measurement:

Frequency (MHz)	Reading Level (dB μ V)	factor (dB)	Emission Level (dB μ V/m)	Limit (dB μ V/m)	Margin (dB)	Antenna polarization
4904.000	44.73	5.16	49.89	74.00	-24.11	peak
4904.000	31.66	5.16	36.82	54.00	-17.18	AVG
7356.000	43.35	7.69	51.04	74.00	-22.96	peak
7356.000	26.22	7.69	33.91	54.00	-20.09	AVG

Horizontal Measurement:

Frequency (MHz)	Reading Level (dB μ V)	factor (dB)	Emission Level (dB μ V/m)	Limit (dB μ V/m)	Margin (dB)	Antenna polarization
4904.000	45.13	5.16	50.29	74.00	-23.71	peak
4904.000	31.14	5.16	36.30	54.00	-17.70	AVG
7356.000	42.59	7.69	50.28	74.00	-23.72	peak
7356.000	26.83	7.69	34.52	54.00	-19.48	AVG

Note: 8~25GHz at least have 20dBm margin. No recording in the test report.

Measurement Level = Reading Level + Factor

Factor = Antenna Factor + Cable Loss – Pre-amplifier

Highest Channel : 2452 MHz

For 5GHz Band:

EUT:	LED Projector	Model Name :	XEC09
Temperature:	25 °C	Test Data	2015-09-30
Pressure:	1010 hPa	Relative Humidity:	60%
Test Mode :	802.11a	Test Voltage :	DC 19V from adapter, AC 120V/60Hz for adapter
Measurement Distance	3 m	Frenqucy Range	1GHz to 25GHz
RBW/VBW	1MHz/1MHz for Peak, 1MHz/10Hz for Average.		

1~25 GHz Harmonics & Spurious Emissions. Peak & Average Measurement

Vertical Measurement:

Frequency (MHz)	Reading Level (dB μ V)	factor (dB)	Emission Level (dB μ V/m)	Limit (dB μ V/m)	Margin (dB)	Antenna polarization
11490.000	36.44	16.82	53.26	74.00	-20.74	peak
11490.000	24.27	16.82	41.09	54.00	-12.91	AVG
17235.000	26.64	22.93	49.57	74.00	-24.43	peak
17235.000	15.39	22.93	38.32	54.00	-15.68	AVG

Horizontal Measurement:

Frequency (MHz)	Reading Level (dB μ V)	factor (dB)	Emission Level (dB μ V/m)	Limit (dB μ V/m)	Margin (dB)	Antenna polarization
11490.000	37.05	16.82	53.87	74.00	-20.13	peak
11490.000	25.88	16.82	42.70	54.00	-11.30	AVG
17235.000	28.62	22.93	51.55	74.00	-22.45	peak
17235.000	17.43	22.93	40.36	54.00	-13.64	AVG

Note: 8~25GHz at least have 20dBm margin. No recording in the test report.

Measurement Level = Reading Level + Factor

Factor = Antenna Factor + Cable Loss – Pre-amplifier

Lowest Channel : 5745 MHz

1~25 GHz Harmonics & Spurious Emissions. Peak & Average Measurement

Vertical Measurement:

Frequency (MHz)	Reading Level (dB μ V)	factor (dB)	Emission Level (dB μ V/m)	Limit (dB μ V/m)	Margin (dB)	Antenna polarization
11570.000	35.95	16.71	52.66	74.00	-21.34	peak
11570.000	24.88	16.71	41.59	54.00	-12.41	AVG
17355.000	25.93	24.37	50.30	74.00	-23.70	peak
17355.000	15.51	24.37	39.88	54.00	-14.12	AVG

Horizontal Measurement:

Frequency (MHz)	Reading Level (dB μ V)	factor (dB)	Emission Level (dB μ V/m)	Limit (dB μ V/m)	Margin (dB)	Antenna polarization
11570.000	36.68	16.71	53.39	74.00	-20.61	peak
11570.000	26.51	16.71	43.22	54.00	-10.78	AVG
17355.000	27.43	24.37	51.80	74.00	-22.20	peak
17355.000	16.26	24.37	40.63	54.00	-13.37	AVG

Note: 8~25GHz at least have 20dBm margin. No recording in the test report.

Measurement Level = Reading Level + Factor

Factor = Antenna Factor + Cable Loss – Pre-amplifier

Middle Channel : 5785 MHz

1~25 GHz Harmonics & Spurious Emissions. Peak & Average Measurement

Vertical Measurement:

Frequency (MHz)	Reading Level (dB μ V)	factor (dB)	Emission Level (dB μ V/m)	Limit (dB μ V/m)	Margin (dB)	Antenna polarization
11650.000	35.68	16.61	52.29	74.00	-21.71	peak
11650.000	24.49	16.61	41.10	54.00	-12.90	AVG
17475.000	25.58	25.01	50.59	74.00	-23.41	peak
17475.000	14.73	25.01	39.74	54.00	-14.26	AVG

Horizontal Measurement:

Frequency (MHz)	Reading Level (dB μ V)	factor (dB)	Emission Level (dB μ V/m)	Limit (dB μ V/m)	Margin (dB)	Antenna polarization
11650.000	35.88	16.61	52.49	74.00	-21.51	peak
11650.000	25.64	16.61	42.25	54.00	-11.75	AVG
17475.000	26.55	25.01	51.56	74.00	-22.44	peak
17475.000	16.21	25.01	41.22	54.00	-12.78	AVG

Note: 8~25GHz at least have 20dBm margin. No recording in the test report.

Measurement Level = Reading Level + Factor

Factor = Antenna Factor + Cable Loss – Pre-amplifier

Highest Channel 165: 5825 MHz

EUT:	LED Projector	Model Name :	XEC09
Temperature:	25 °C	Test Data	2015-09-30
Pressure:	1010 hPa	Relative Humidity:	60%
Test Mode :	802.11n(HT20)	Test Voltage :	DC 19V from adapter, AC 120V/60Hz for adapter
Measurement Distance	3 m	Frenqucy Range	1GHz to 25GHz
RBW/VBW	1MHz/1MHz for Peak, 1MHz/10Hz for Average.		

1~25 GHz Harmonics & Spurious Emissions. Peak & Average Measurement

Vertical Measurement:

Frequency (MHz)	Reading Level (dB μ V)	factor (dB)	Emission Level (dB μ V/m)	Limit (dB μ V/m)	Margin (dB)	Antenna polarization
11490.000	36.77	16.82	53.59	74.00	-20.41	peak
11490.000	24.60	16.82	41.42	54.00	-12.58	AVG
17235.000	26.52	22.93	49.45	74.00	-24.55	peak
17235.000	15.45	22.93	38.38	54.00	-15.62	AVG

Horizontal Measurement:

Frequency (MHz)	Reading Level (dB μ V)	factor (dB)	Emission Level (dB μ V/m)	Limit (dB μ V/m)	Margin (dB)	Antenna polarization
11490.000	37.21	16.82	54.03	74.00	-19.97	peak
11490.000	25.40	16.82	42.22	54.00	-11.78	AVG
17235.000	28.38	22.93	51.31	74.00	-22.69	peak
17235.000	17.61	22.93	40.54	54.00	-13.46	AVG

Note: 8~25GHz at least have 20dBm margin. No recording in the test report.

Measurement Level = Reading Level + Factor

Factor = Antenna Factor + Cable Loss – Pre-amplifier

Lowest Channel : 5745 MHz

1~25 GHz Harmonics & Spurious Emissions. Peak & Average Measurement

Vertical Measurement:

Frequency (MHz)	Reading Level (dB μ V)	factor (dB)	Emission Level (dB μ V/m)	Limit (dB μ V/m)	Margin (dB)	Antenna polarization
11570.000	35.99	16.71	52.70	74.00	-21.30	peak
11570.000	24.43	16.71	41.14	54.00	-12.86	AVG
17355.000	25.52	24.37	49.89	74.00	-24.11	peak
17355.000	15.17	24.37	39.54	54.00	-14.46	AVG

Horizontal Measurement:

Frequency (MHz)	Reading Level (dB μ V)	factor (dB)	Emission Level (dB μ V/m)	Limit (dB μ V/m)	Margin (dB)	Antenna polarization
11570.000	36.68	16.71	53.39	74.00	-20.61	peak
11570.000	26.52	16.71	43.23	54.00	-10.77	AVG
17355.000	27.43	24.37	51.80	74.00	-22.20	peak
17355.000	16.17	24.37	40.54	54.00	-13.46	AVG

Note: 8~25GHz at least have 20dBm margin. No recording in the test report.

Measurement Level = Reading Level + Factor

Factor = Antenna Factor + Cable Loss – Pre-amplifier

Middle Channel : 5785 MHz

1~25 GHz Harmonics & Spurious Emissions. Peak & Average Measurement

Vertical Measurement:

Frequency (MHz)	Reading Level (dB μ V)	factor (dB)	Emission Level (dB μ V/m)	Limit (dB μ V/m)	Margin (dB)	Antenna polarization
11650.000	35.74	16.61	52.35	74.00	-21.65	peak
11650.000	24.69	16.61	41.30	54.00	-12.70	AVG
17475.000	25.82	25.01	50.83	74.00	-23.17	peak
17475.000	14.92	25.01	39.93	54.00	-14.07	AVG

Horizontal Measurement:

Frequency (MHz)	Reading Level (dB μ V)	factor (dB)	Emission Level (dB μ V/m)	Limit (dB μ V/m)	Margin (dB)	Antenna polarization
11650.000	35.90	16.61	52.51	74.00	-21.49	peak
11650.000	25.46	16.61	42.07	54.00	-11.93	AVG
17475.000	26.86	25.01	51.87	74.00	-22.13	peak
17475.000	16.50	25.01	41.51	54.00	-12.49	AVG

Note: 8~25GHz at least have 20dBm margin. No recording in the test report.

Measurement Level = Reading Level + Factor

Factor = Antenna Factor + Cable Loss – Pre-amplifier

Highest Channel : 5825 MHz

EUT:	LED Projector	Model Name :	XEC09
Temperature:	25 °C	Test Data	2015-09-30
Pressure:	1010 hPa	Relative Humidity:	60%
Test Mode :	802.11n(HT40)	Test Voltage :	DC 19V from adapter, AC 120V/60Hz for adapter
Measurement Distance	3 m	Frenqucy Range	1GHz to 25GHz
RBW/VBW	1MHz/1MHz for Peak, 1MHz/10Hz for Average.		

1~25 GHz Harmonics & Spurious Emissions. Peak & Average Measurement

Vertical Measurement:

Frequency (MHz)	Reading Level (dB μ V)	factor (dB)	Emission Level (dB μ V/m)	Limit (dB μ V/m)	Margin (dB)	Antenna polarization
11510.000	36.43	16.78	53.21	74.00	-20.79	peak
11510.000	24.82	16.78	41.60	54.00	-12.40	AVG
17265.000	27.53	23.29	50.82	74.00	-23.18	peak
17265.000	16.09	23.29	39.38	54.00	-14.62	AVG

Horizontal Measurement:

Frequency (MHz)	Reading Level (dB μ V)	factor (dB)	Emission Level (dB μ V/m)	Limit (dB μ V/m)	Margin (dB)	Antenna polarization
11510.000	36.97	16.78	53.75	74.00	-20.25	peak
11510.000	25.11	16.78	41.89	54.00	-12.11	AVG
17265.000	28.23	23.29	51.52	74.00	-22.48	peak
17265.000	17.46	23.29	40.75	54.00	-13.25	AVG

Note: 8~25GHz at least have 20dBm margin. No recording in the test report.

Measurement Level = Reading Level + Factor

Factor = Antenna Factor + Cable Loss – Pre-amplifier

Lowest Channel : 5755 MHz

1~25 GHz Harmonics & Spurious Emissions. Peak & Average Measurement

Vertical Measurement:

Frequency (MHz)	Reading Level (dB μ V)	factor (dB)	Emission Level (dB μ V/m)	Limit (dB μ V/m)	Margin (dB)	Antenna polarization
11590.000	35.77	16.69	52.46	74.00	-21.54	peak
11590.000	24.59	16.69	41.28	54.00	-12.72	AVG
17385.000	25.80	24.73	50.53	74.00	-23.47	peak
17385.000	14.08	24.73	38.81	54.00	-15.19	AVG

Horizontal Measurement:

Frequency (MHz)	Reading Level (dB μ V)	factor (dB)	Emission Level (dB μ V/m)	Limit (dB μ V/m)	Margin (dB)	Antenna polarization
11590.000	36.62	16.69	53.31	74.00	-20.69	peak
11590.000	26.18	16.69	42.87	54.00	-11.13	AVG
17385.000	26.73	24.73	51.46	74.00	-22.54	peak
17385.000	15.39	24.73	40.12	54.00	-13.88	AVG

Note: 8~25GHz at least have 20dBm margin. No recording in the test report.

Measurement Level = Reading Level + Factor

Factor = Antenna Factor + Cable Loss – Pre-amplifier

Highest Channel : 5795 MHz

EUT:	LED Projector	Model Name :	XEC09
Temperature:	25 °C	Test Data	2015-09-30
Pressure:	1010 hPa	Relative Humidity:	60%
Test Mode :	802.11ac(HT20)	Test Voltage :	DC 19V from adapter, AC 120V/60Hz for adapter
Measurement Distance	3 m	Frenqucy Range	1GHz to 25GHz
RBW/VBW	1MHz/1MHz for Peak, 1MHz/10Hz for Average.		

1~25 GHz Harmonics & Spurious Emissions. Peak & Average Measurement

Vertical Measurement:

Frequency (MHz)	Reading Level (dB μ V)	factor (dB)	Emission Level (dB μ V/m)	Limit (dB μ V/m)	Margin (dB)	Antenna polarization
11490.000	35.57	16.82	52.39	74.00	-21.61	peak
11490.000	24.72	16.82	41.54	54.00	-12.46	AVG
17235.000	26.60	22.93	49.53	74.00	-24.47	peak
17235.000	15.81	22.93	38.74	54.00	-15.26	AVG

Horizontal Measurement:

Frequency (MHz)	Reading Level (dB μ V)	factor (dB)	Emission Level (dB μ V/m)	Limit (dB μ V/m)	Margin (dB)	Antenna polarization
11490.000	36.54	16.82	53.36	74.00	-20.64	peak
11490.000	25.42	16.82	42.24	54.00	-11.76	AVG
17235.000	28.76	22.93	51.69	74.00	-22.31	peak
17235.000	17.69	22.93	40.62	54.00	-13.38	AVG

Note: 8~25GHz at least have 20dBm margin. No recording in the test report.

Measurement Level = Reading Level + Factor

Factor = Antenna Factor + Cable Loss – Pre-amplifier

Lowest Channel : 5745 MHz

1~25 GHz Harmonics & Spurious Emissions. Peak & Average Measurement

Vertical Measurement:

Frequency (MHz)	Reading Level (dB μ V)	factor (dB)	Emission Level (dB μ V/m)	Limit (dB μ V/m)	Margin (dB)	Antenna polarization
11570.000	36.04	16.71	52.75	74.00	-21.25	peak
11570.000	23.03	16.71	39.74	54.00	-14.26	AVG
17355.000	25.86	24.37	50.23	74.00	-23.77	peak
17355.000	15.44	24.37	39.81	54.00	-14.19	AVG

Horizontal Measurement:

Frequency (MHz)	Reading Level (dB μ V)	factor (dB)	Emission Level (dB μ V/m)	Limit (dB μ V/m)	Margin (dB)	Antenna polarization
11570.000	35.43	16.71	52.14	74.00	-21.86	peak
11570.000	26.22	16.71	42.93	54.00	-11.07	AVG
17355.000	26.50	24.37	50.87	74.00	-23.13	peak
17355.000	16.37	24.37	40.74	54.00	-13.26	AVG

Note: 8~25GHz at least have 20dBm margin. No recording in the test report.

Measurement Level = Reading Level + Factor

Factor = Antenna Factor + Cable Loss – Pre-amplifier

Middle Channel : 5785 MHz

1~25 GHz Harmonics & Spurious Emissions. Peak & Average Measurement

Vertical Measurement:

Frequency (MHz)	Reading Level (dB μ V)	factor (dB)	Emission Level (dB μ V/m)	Limit (dB μ V/m)	Margin (dB)	Antenna polarization
11650.000	35.74	16.61	52.35	74.00	-21.65	peak
11650.000	24.51	16.61	41.12	54.00	-12.88	AVG
17475.000	25.62	25.01	50.63	74.00	-23.37	peak
17475.000	14.59	25.01	39.60	54.00	-14.40	AVG

Horizontal Measurement:

Frequency (MHz)	Reading Level (dB μ V)	factor (dB)	Emission Level (dB μ V/m)	Limit (dB μ V/m)	Margin (dB)	Antenna polarization
11650.000	35.88	16.61	52.49	74.00	-21.51	peak
11650.000	25.43	16.61	42.04	54.00	-11.96	AVG
17475.000	25.69	25.01	50.70	74.00	-23.30	peak
17475.000	16.43	25.01	41.44	54.00	-12.56	AVG

Note: 8~25GHz at least have 20dBm margin. No recording in the test report.

Measurement Level = Reading Level + Factor

Factor = Antenna Factor + Cable Loss – Pre-amplifier

Highest Channel : 5825 MHz

EUT:	LED Projector	Model Name :	XEC09
Temperature:	25 °C	Test Data	2015-09-30
Pressure:	1010 hPa	Relative Humidity:	60%
Test Mode :	802.11ac(HT40)	Test Voltage :	DC 19V from adapter, AC 120V/60Hz for adapter
Measurement Distance	3 m	Frenqucy Range	1GHz to 25GHz
RBW/VBW	1MHz/1MHz for Peak, 1MHz/10Hz for Average.		

1~25 GHz Harmonics & Spurious Emissions. Peak & Average Measurement

Vertical Measurement:

Frequency (MHz)	Reading Level (dB μ V)	factor (dB)	Emission Level (dB μ V/m)	Limit (dB μ V/m)	Margin (dB)	Antenna polarization
11510.000	35.37	16.78	52.15	74.00	-21.85	peak
11510.000	24.52	16.78	41.30	54.00	-12.70	AVG
17265.000	27.69	23.29	50.98	74.00	-23.02	peak
17265.000	16.33	23.29	39.62	54.00	-14.38	AVG

Horizontal Measurement:

Frequency (MHz)	Reading Level (dB μ V)	factor (dB)	Emission Level (dB μ V/m)	Limit (dB μ V/m)	Margin (dB)	Antenna polarization
11510.000	36.44	16.78	53.22	74.00	-20.78	peak
11510.000	25.30	16.78	42.08	54.00	-11.92	AVG
17265.000	28.27	23.29	51.56	74.00	-22.44	peak
17265.000	17.58	23.29	40.87	54.00	-13.13	AVG

Note: 8~25GHz at least have 20dBm margin. No recording in the test report.

Measurement Level = Reading Level + Factor

Factor = Antenna Factor + Cable Loss – Pre-amplifier

Lowest Channel : 5755 MHz

1~25 GHz Harmonics & Spurious Emissions. Peak & Average Measurement

Vertical Measurement:

Frequency (MHz)	Reading Level (dB μ V)	factor (dB)	Emission Level (dB μ V/m)	Limit (dB μ V/m)	Margin (dB)	Antenna polarization
11590.000	35.28	16.69	51.97	74.00	-22.03	peak
11590.000	24.60	16.69	41.29	54.00	-12.71	AVG
17385.000	25.37	24.73	50.10	74.00	-23.90	peak
17385.000	14.64	24.73	39.37	54.00	-14.63	AVG

Horizontal Measurement:

Frequency (MHz)	Reading Level (dB μ V)	factor (dB)	Emission Level (dB μ V/m)	Limit (dB μ V/m)	Margin (dB)	Antenna polarization
11590.000	36.55	16.69	53.24	74.00	-20.76	peak
11590.000	25.18	16.69	41.87	54.00	-12.13	AVG
17385.000	26.24	24.73	50.97	74.00	-23.03	peak
17385.000	15.54	24.73	40.27	54.00	-13.73	AVG

Note: 8~25GHz at least have 20dBm margin. No recording in the test report.

Measurement Level = Reading Level + Factor

Factor = Antenna Factor + Cable Loss – Pre-amplifier

Highest Channel : 5795 MHz

EUT:	LED Projector	Model Name :	XEC09
Temperature:	25 °C	Test Data	2015-09-30
Pressure:	1010 hPa	Relative Humidity:	60%
Test Mode :	802.11ac(HT80)	Test Voltage :	DC 19V from adapter, AC 120V/60Hz for adapter
Measurement Distance	3 m	Frenqucy Range	1GHz to 25GHz
RBW/VBW	1MHz/1MHz for Peak, 1MHz/10Hz for Average.		

1~25 GHz Harmonics & Spurious Emissions. Peak & Average Measurement

Vertical Measurement:

Frequency (MHz)	Reading Level (dB μ V)	factor (dB)	Emission Level (dB μ V/m)	Limit (dB μ V/m)	Margin (dB)	Antenna polarization
11550.000	36.58	16.73	53.31	74.00	-20.69	peak
11550.000	25.44	16.73	42.17	54.00	-11.83	AVG
17325.000	26.30	24.01	50.31	74.00	-23.69	peak
17325.000	15.15	24.01	39.16	54.00	-14.84	AVG

Horizontal Measurement:

Frequency (MHz)	Reading Level (dB μ V)	factor (dB)	Emission Level (dB μ V/m)	Limit (dB μ V/m)	Margin (dB)	Antenna polarization
11550.000	36.62	16.73	53.35	74.00	-20.65	peak
11550.000	25.17	16.73	41.90	54.00	-12.10	AVG
17325.000	26.83	24.01	50.84	74.00	-23.16	peak
17325.000	16.66	24.01	40.67	54.00	-13.33	AVG

Note: 8~25GHz at least have 20dBm margin. No recording in the test report.

Measurement Level = Reading Level + Factor

Factor = Antenna Factor + Cable Loss – Pre-amplifier

Channel: 5775 MHz

5.3.4 TEST RESULTS (Restricted Bands Requirements)

EUT:	LED Projector	Model Name :	XEC09
Temperature:	24 °C	Relative Humidity:	51%
Pressure:	1010 hPa	Test Voltage :	DC 19V from adapter, AC 120V/60Hz for adapter
Note:	For 2.4GHz Band: 1. The transmitter was setup to transmit at the lowest channel . Then the field strength was measured at 2310-2390 MHz. 2. The transmitter was setup to transmit at the highest channel . Then the field strength was measured at 2483.5-2500 MHz. 3. The data of 2390MHz and 2483.5MHz was the worst. For 5GHz Band: 1. The field strength was measured at 5350-5460 MHz.		

For 2.4GHz Band:

802.11b								
Freq. (MHz)	Ant.Pol. H/V	Reading		Ant/CF CF(dB)	Act		Limit	
		Peak (dBuv)	AV (dBuv)		Peak (dBuv/m)	AV (dBuv/m)	Peak (dBuv/m)	AV (dBuv/m)
2390.00	V	40.14	28.77	-5.79	34.35	22.98	74.00	54.00
2390.00	H	40.58	28.33	-5.79	34.79	22.54	74.00	54.00
2483.50	V	41.32	30.77	-4.98	36.34	25.79	74.00	54.00
2483.50	H	41.66	30.22	-4.98	36.68	25.24	74.00	54.00

802.11g								
Freq. (MHz)	Ant.Pol. H/V	Reading		Ant/CF CF(dB)	Act		Limit	
		Peak (dBuv)	AV (dBuv)		Peak (dBuv/m)	AV (dBuv/m)	Peak (dBuv/m)	AV (dBuv/m)
2390.00	V	39.52	28.43	-5.79	33.73	22.64	74.00	54.00
2390.00	H	39.51	28.74	-5.79	33.72	22.95	74.00	54.00
2483.50	V	40.66	30.24	-4.98	35.68	25.26	74.00	54.00
2483.50	H	41.15	30.89	-4.98	36.17	25.91	74.00	54.00

802.11n(HT20)								
Freq. (MHz)	Ant.Pol. H/V	Reading		Ant/CF CF(dB)	Act		Limit	
		Peak (dBuv)	AV (dBuv)		Peak (dBuv/m)	AV (dBuv/m)	Peak (dBuv/m)	AV (dBuv/m)
2390.00	V	39.74	28.66	-5.79	33.95	22.87	74.00	54.00
2390.00	H	39.58	28.39	-5.79	33.79	22.60	74.00	54.00
2483.50	V	40.44	30.10	-4.98	35.46	25.12	74.00	54.00
2483.50	H	41.22	30.49	-4.98	36.24	25.51	74.00	54.00

802.11n(HT40)								
Freq. (MHz)	Ant.Pol. H/V	Reading		Ant/CF CF(dB)	Act		Limit	
		Peak (dBuv)	AV (dBuv)		Peak (dBuv/m)	AV (dBuv/m)	Peak (dBuv/m)	AV (dBuv/m)
2390.00	V	39.51	28.63	-5.79	33.72	22.84	74.00	54.00
2390.00	H	40.18	30.51	-5.79	34.39	24.72	74.00	54.00
2483.50	V	40.25	30.43	-4.98	35.27	25.45	74.00	54.00
2483.50	H	41.33	30.85	-4.98	36.35	25.87	74.00	54.00

For 5GHz Band:

802.11a								
Freq. (MHz)	Ant.Pol. H/V	Reading		Ant/CF CF(dB)	Act		Limit	
		Peak (dBuv)	AV (dBuv)		Peak (dBuv/m)	AV (dBuv/m)	Peak (dBuv/m)	AV (dBuv/m)
5350.000	V	34.60	23.53	4.30	38.90	27.83	74.00	54.00
5350.000	H	32.48	21.53	4.30	36.78	25.83	74.00	54.00
5460.000	V	35.20	25.13	4.00	39.20	29.13	74.00	54.00
5460.000	H	34.55	24.47	4.00	38.55	28.47	74.00	54.00

802.11n(HT20)								
Freq. (MHz)	Ant.Pol. H/V	Reading		Ant/CF CF(dB)	Act		Limit	
		Peak (dBuv)	AV (dBuv)		Peak (dBuv/m)	AV (dBuv/m)	Peak (dBuv/m)	AV (dBuv/m)
5350.000	V	34.66	23.70	4.30	38.96	28.00	74.00	54.00
5350.000	H	32.58	21.49	4.30	36.88	25.79	74.00	54.00
5460.000	V	35.81	25.53	4.00	39.81	29.53	74.00	54.00
5460.000	H	34.38	24.42	4.00	38.38	28.42	74.00	54.00

802.11n(HT40)								
Freq. (MHz)	Ant.Pol. H/V	Reading		Ant/CF CF(dB)	Act		Limit	
		Peak (dBuv)	AV (dBuv)		Peak (dBuv/m)	AV (dBuv/m)	Peak (dBuv/m)	AV (dBuv/m)
5350.000	V	34.47	23.29	4.30	38.77	27.59	74.00	54.00
5350.000	H	33.46	22.58	4.30	37.76	26.88	74.00	54.00
5460.000	V	35.52	25.34	4.00	39.52	29.34	74.00	54.00
5460.000	H	34.18	24.46	4.00	38.18	28.46	74.00	54.00

802.11ac(HT20)								
Freq. (MHz)	Ant.Pol. H/V	Reading		Ant/CF CF(dB)	Act		Limit	
		Peak (dBuv)	AV (dBuv)		Peak (dBuv/m)	AV (dBuv/m)	Peak (dBuv/m)	AV (dBuv/m)
5350.000	V	34.59	23.90	4.30	38.89	28.20	74.00	54.00
5350.000	H	32.67	21.87	4.30	36.97	26.17	74.00	54.00
5460.000	V	35.23	25.42	4.00	39.23	29.42	74.00	54.00
5460.000	H	34.42	24.57	4.00	38.42	28.57	74.00	54.00

802.11ac(HT40)								
Freq. (MHz)	Ant.Pol. H/V	Reading		Ant/CF CF(dB)	Act		Limit	
		Peak (dBuv)	AV (dBuv)		Peak (dBuv/m)	AV (dBuv/m)	Peak (dBuv/m)	AV (dBuv/m)
5350.000	V	34.60	23.15	4.30	38.90	27.45	74.00	54.00
5350.000	H	33.54	22.62	4.30	37.84	26.92	74.00	54.00
5460.000	V	35.15	25.49	4.00	39.15	29.49	74.00	54.00
5460.000	H	34.69	24.55	4.00	38.69	28.55	74.00	54.00

802.11ac(HT80)								
Freq. (MHz)	Ant.Pol. H/V	Reading		Ant/CF CF(dB)	Act		Limit	
		Peak (dBuv)	AV (dBuv)		Peak (dBuv/m)	AV (dBuv/m)	Peak (dBuv/m)	AV (dBuv/m)
5350.000	V	34.58	23.27	4.30	38.88	27.57	74.00	54.00
5350.000	H	33.82	22.53	4.30	38.12	26.83	74.00	54.00
5460.000	V	35.49	25.10	4.00	39.49	29.10	74.00	54.00
5460.000	H	34.33	24.48	4.00	38.33	28.48	74.00	54.00

Remark:

- (1) Radiated emissions measured in frequency range above 1000MHz were made with an instrument using Peak detector mode
- (2) EUT Orthogonal Axis:
"X" - denotes Laid on Table; "Y" - denotes Vertical Stand; "Z" - denotes Side Stand
- (3) During the measurements above 1 GHz it is taken care of that the EUT is always within the 3 dB cone of radiation BW of the used antenna
- (4) Corr.Factor = Antenna Factor + Cable Loss – Pre-amplifier.
- (5) No any other emission which falls in restricted bands can be detected and be reported.

Test result: The unit does meet the FCC requirements.

5.4 BANDWIDTH TEST

5.4.1 Applied procedures / Limit

15.247 (a)(2) Systems using digital modulation techniques may operate in the 902-928 MHz, 2400-2483.5MHz, 5725-5850MHz. The minimum 6 dB bandwidth shall be at least 500 kHz.

5.4.2 Test procedure

- a. The EUT was directly connected to the spectrum analyzer and antenna output port as show in the block diagram below.
- b. Spectrum Setting: RBW= 100KHz, VBW \geq 3*RBW, Sweep time = Auto Detector
Function=Peak..

5.4.3 Deviation from standard

No deviation.

5.4.4 Test setup

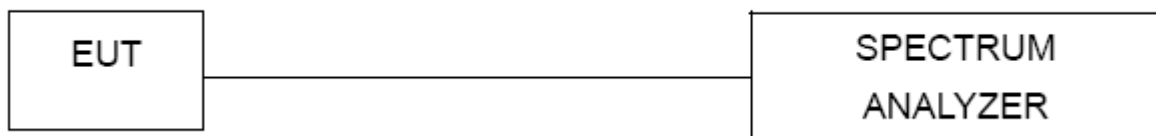

5.4.5 Test results

For 2.4GHz Band:

Channel No.	Frequency (MHz)	Mode	Measured 6dB bandwidth (MHz)	Limit	Result
1	2412	802.11b	10.161	≥500KHz	Pass
6	2437		10.160		Pass
11	2462		10.162		Pass
1	2412	802.11g	16.600	≥500KHz	Pass
6	2437		16.591		Pass
11	2462		16.600		Pass
1	2412	802.11n (HT20)	17.864	≥500KHz	Pass
6	2437		17.835		Pass
11	2462		17.831		Pass
3	2422	802.11n (HT40)	36.497	≥500KHz	Pass
6	2437		36.500		Pass
9	2452		36.505		Pass

Test result: The unit does meet the FCC requirements.

For 5GHz Band:

Channel No.	Frequency (MHz)	Mode	Measured 6dB bandwidth (MHz)	Limit	Result
149	5745	802.11a	16.588	≥500KHz	Pass
157	5785		16.564		Pass
165	5825		16.573		Pass
149	5745	802.11n(HT20)	17.855	≥500KHz	Pass
157	5785		17.845		Pass
165	5825		17.802		Pass
149	5755	802.11n(HT40)	36.541	≥500KHz	Pass
157	5795		36.142		Pass
149	5745	802.11ac(HT20)	17.793	≥500KHz	Pass
157	5785		17.773		Pass
165	5825		17.787		Pass
149	5755	802.11ac(HT40)	36.521	≥500KHz	Pass
157	5795		36.540		Pass
155	5775	802.11ac(HT80)	76.026	≥500KHz	Pass

Test result: The unit does meet the FCC requirements.

Result plot as follows:

802.11b/2412MHz

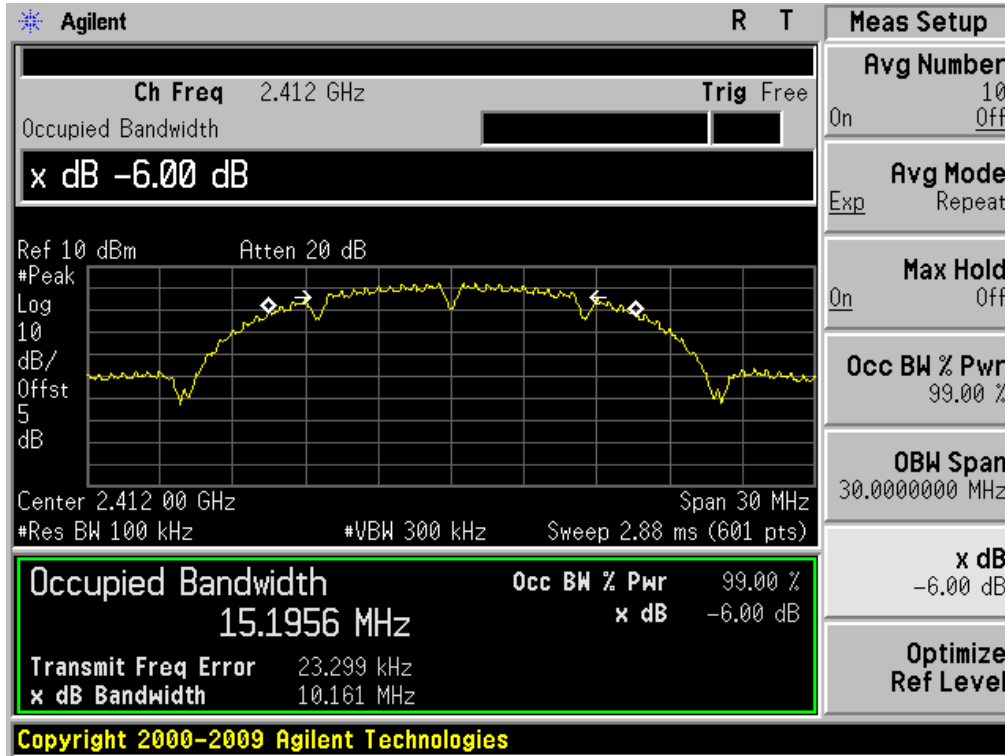

802.11b/2437MHz

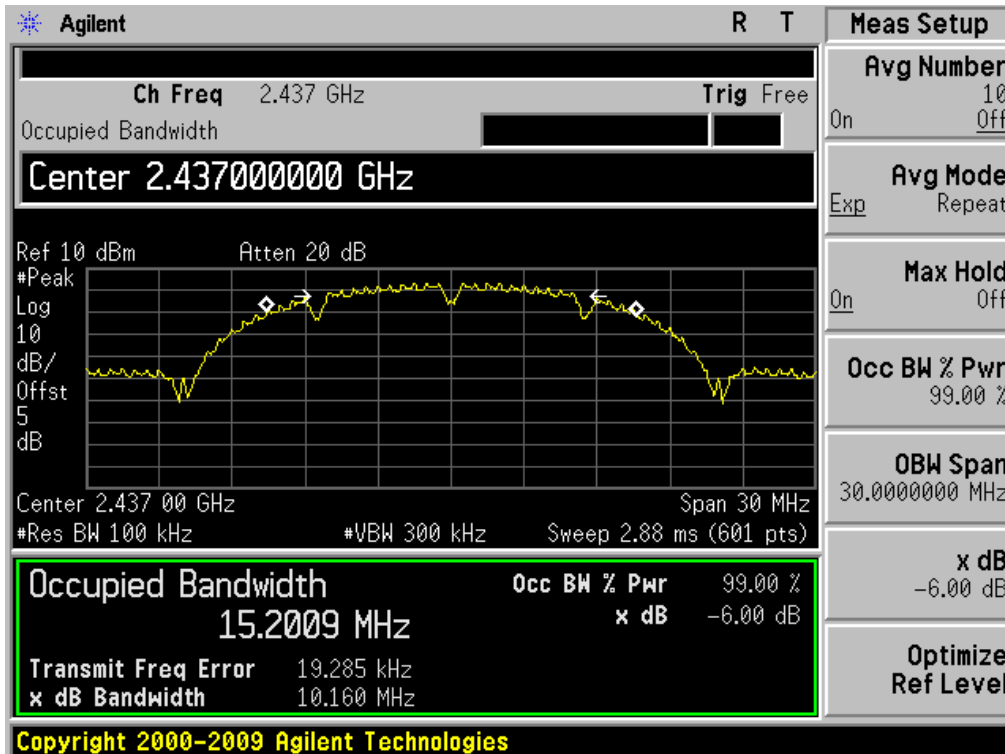

802.11b/2462MHz

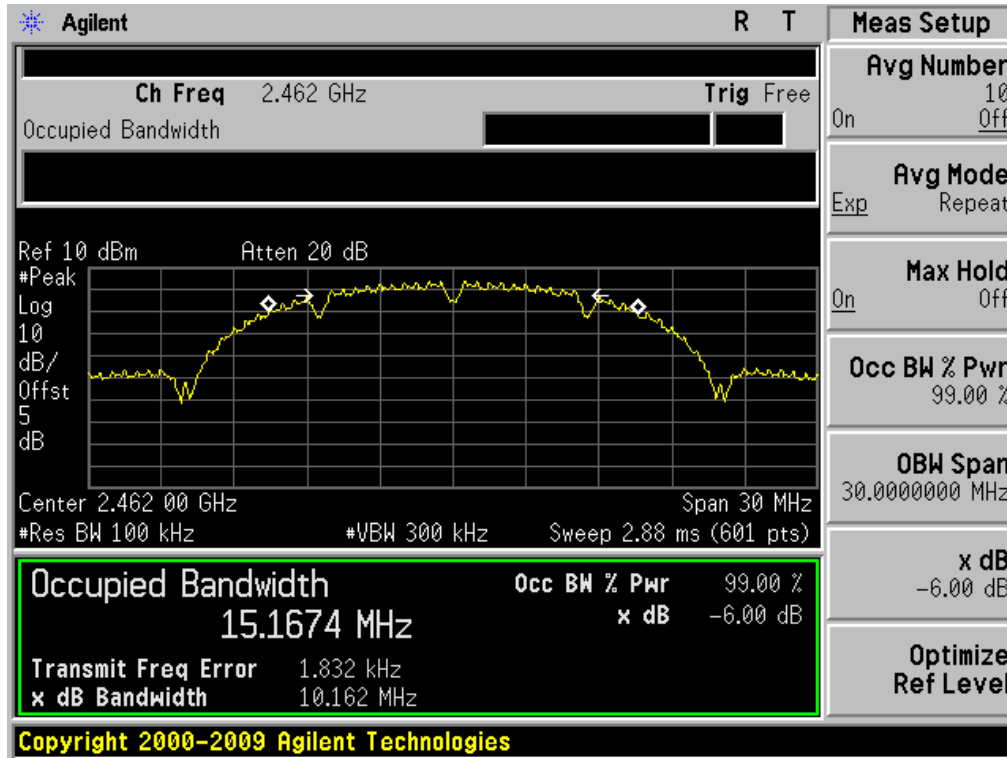

802.11g/2412MHz

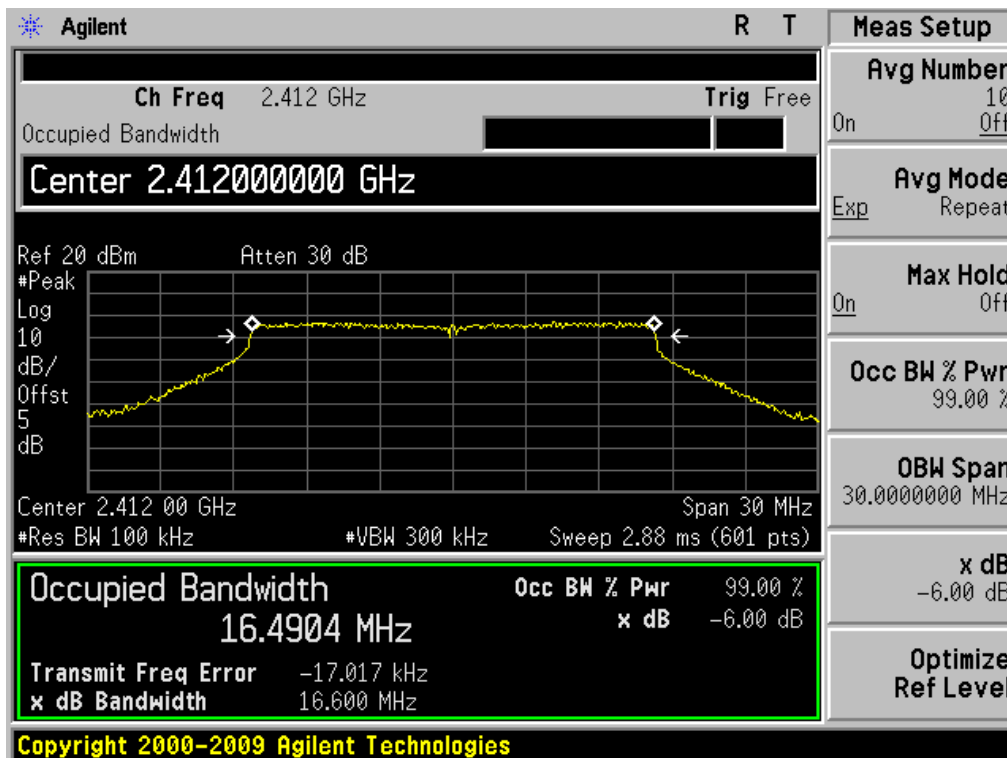

802.11g/2437MHz

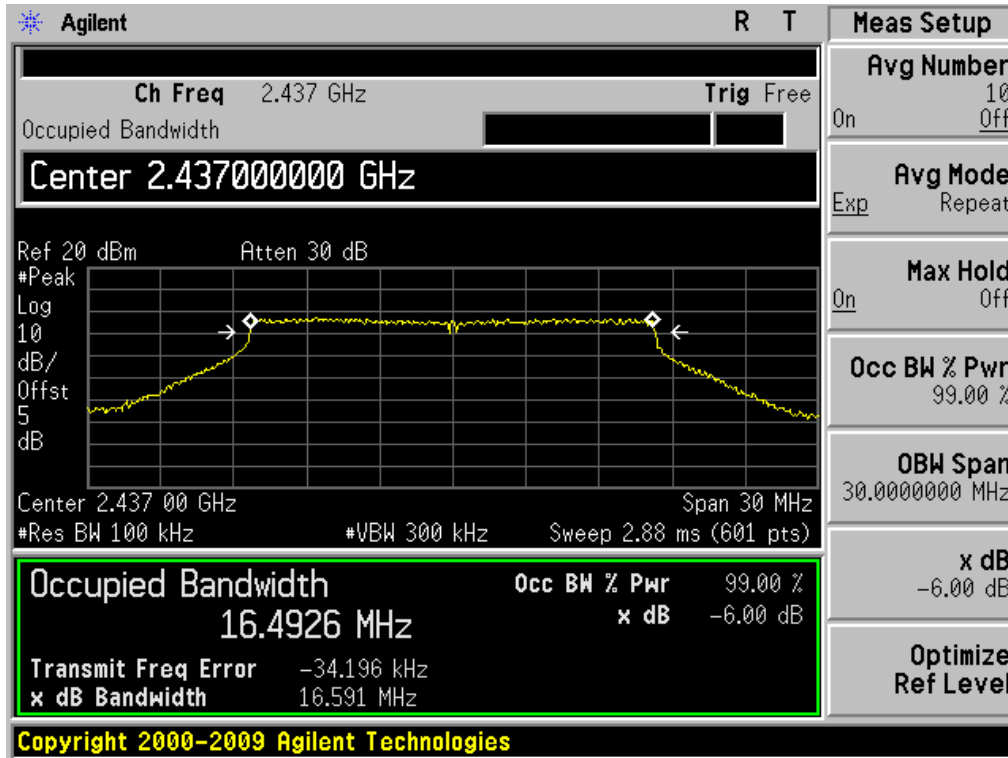

802.11g/2462MHz

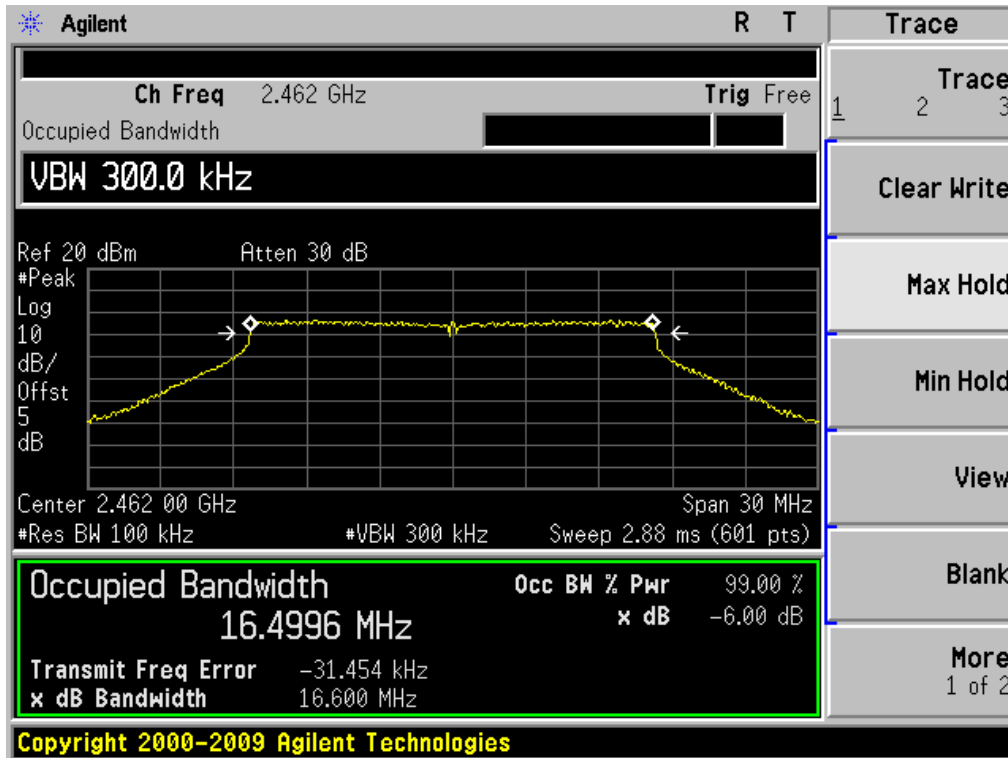

802.11n(HT20)/2412MHz

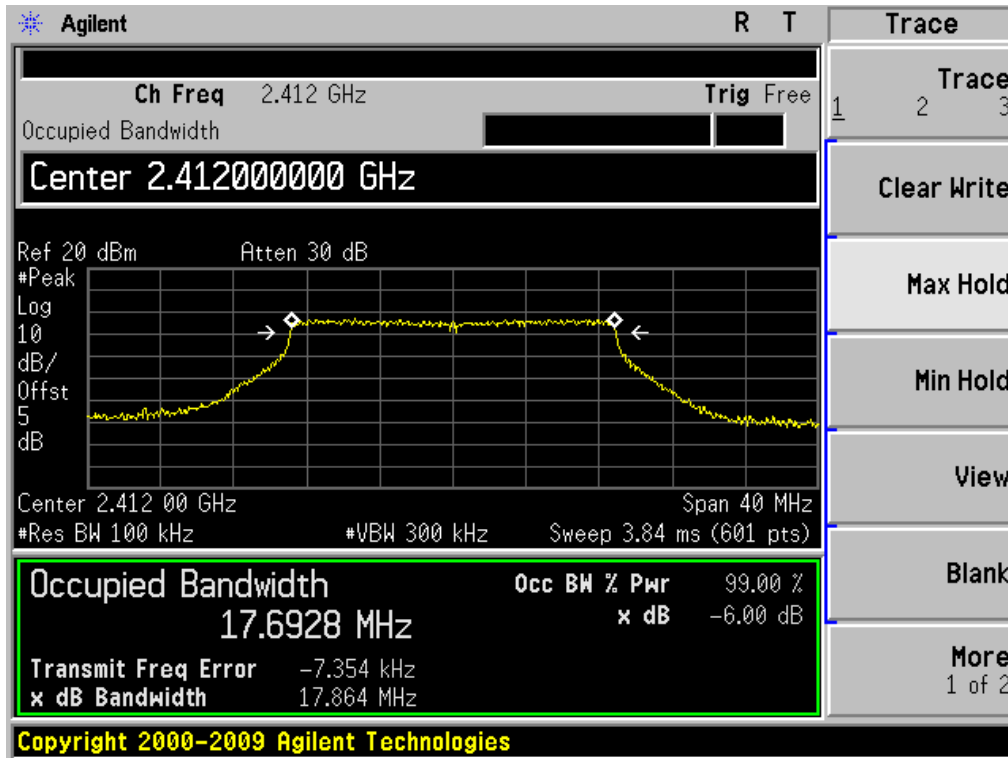

802.11n(HT20)/2437MHz

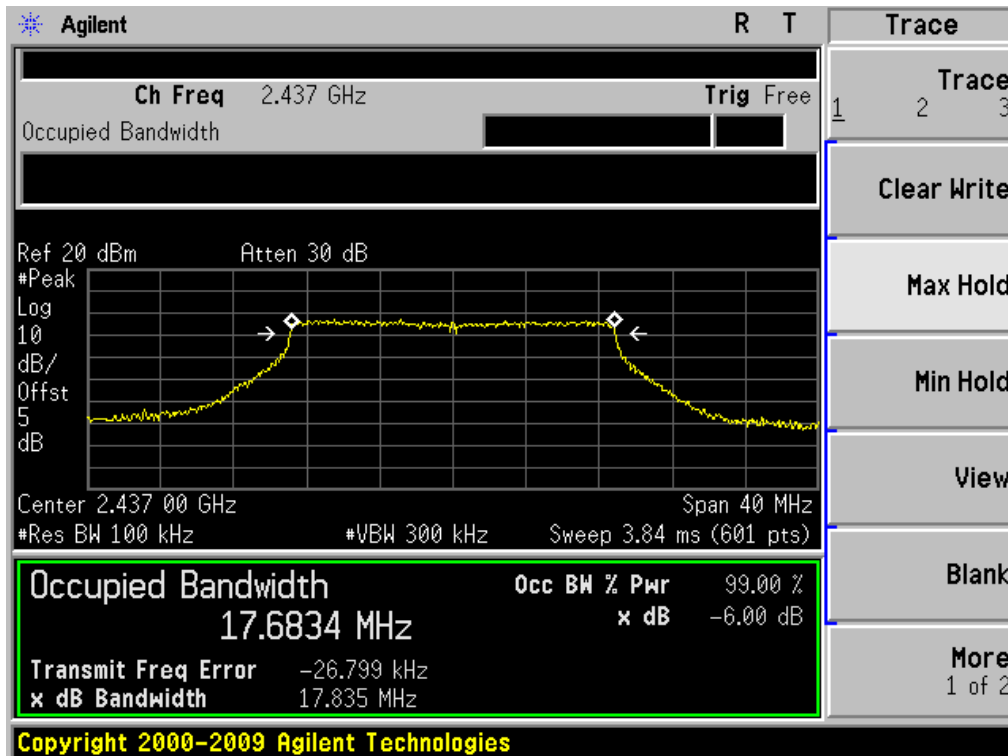

802.11n(HT20)/2462MHz

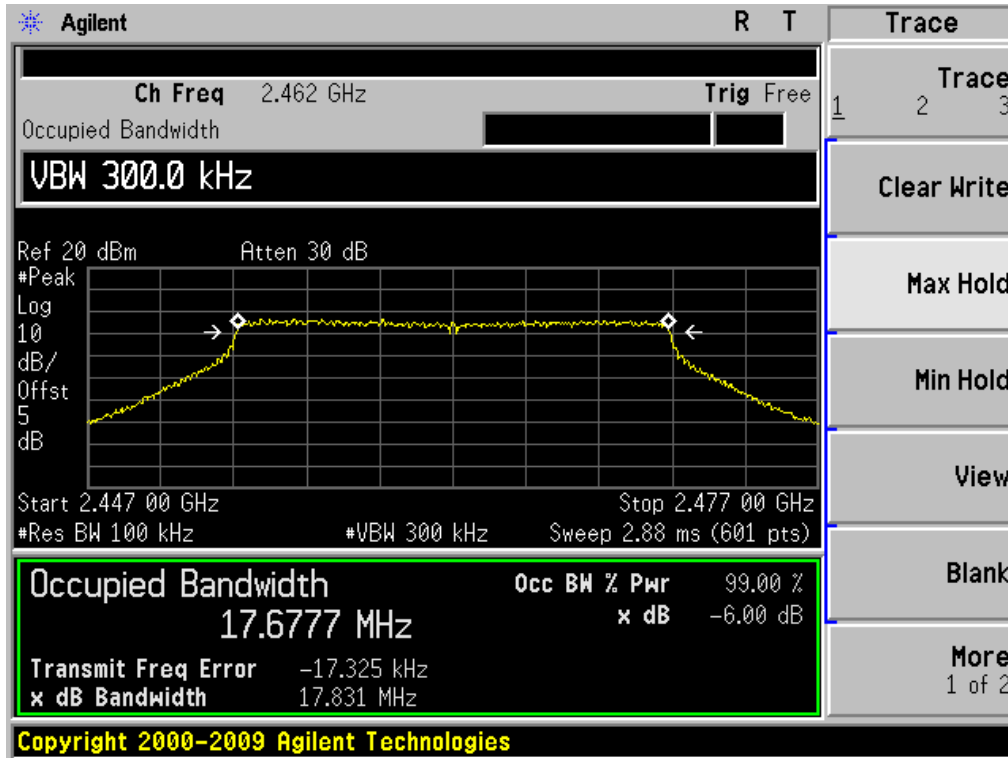

802.11n(HT40)/2422MHz

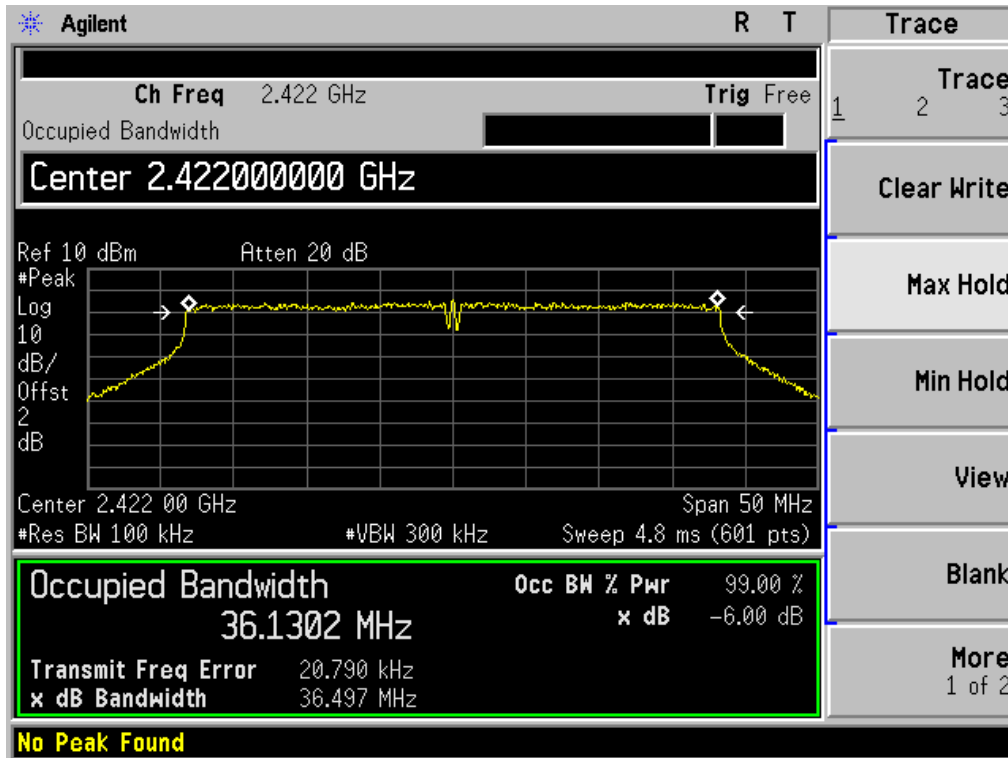

802.11n(HT40)/2437MHz

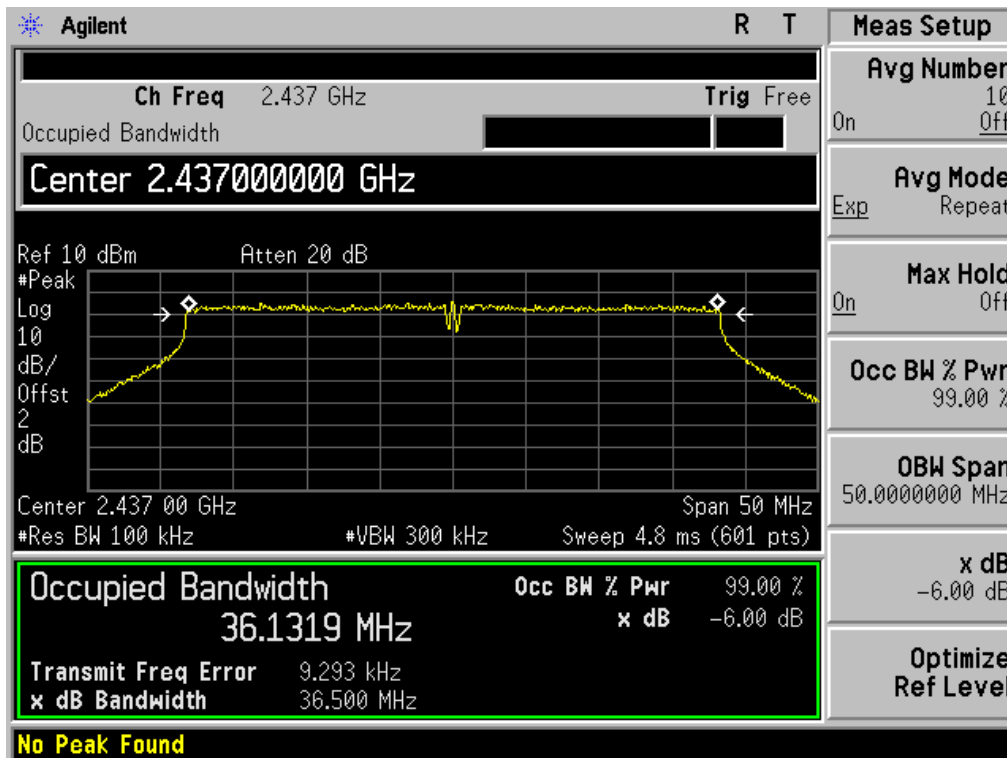

802.11n(HT40)/2452MHz

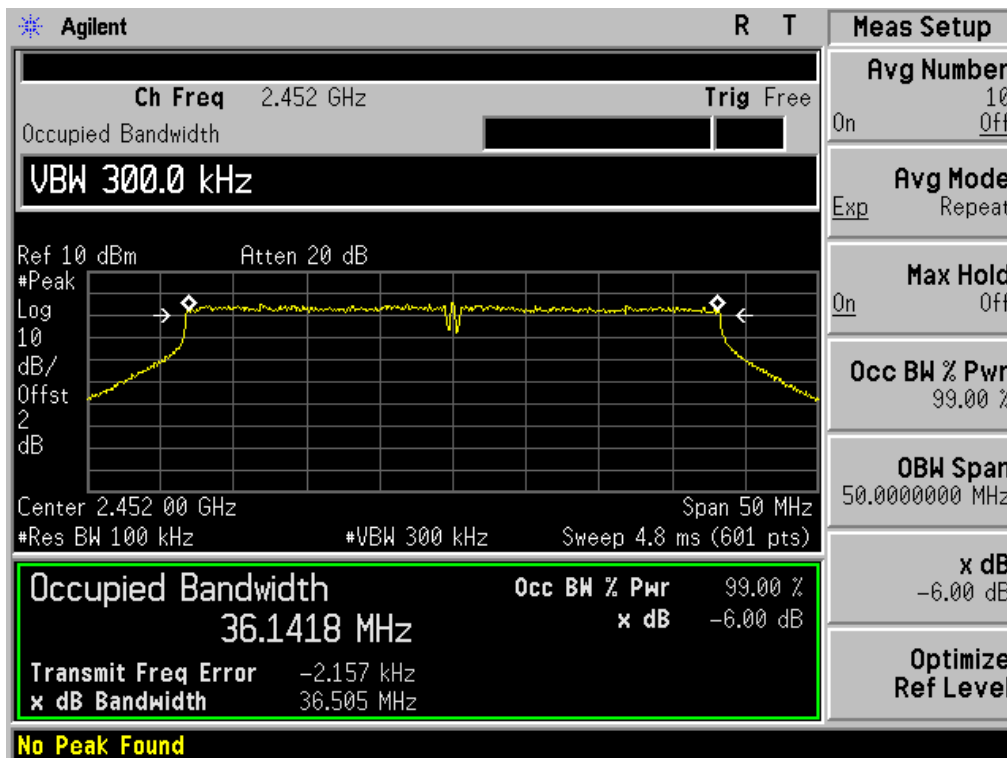

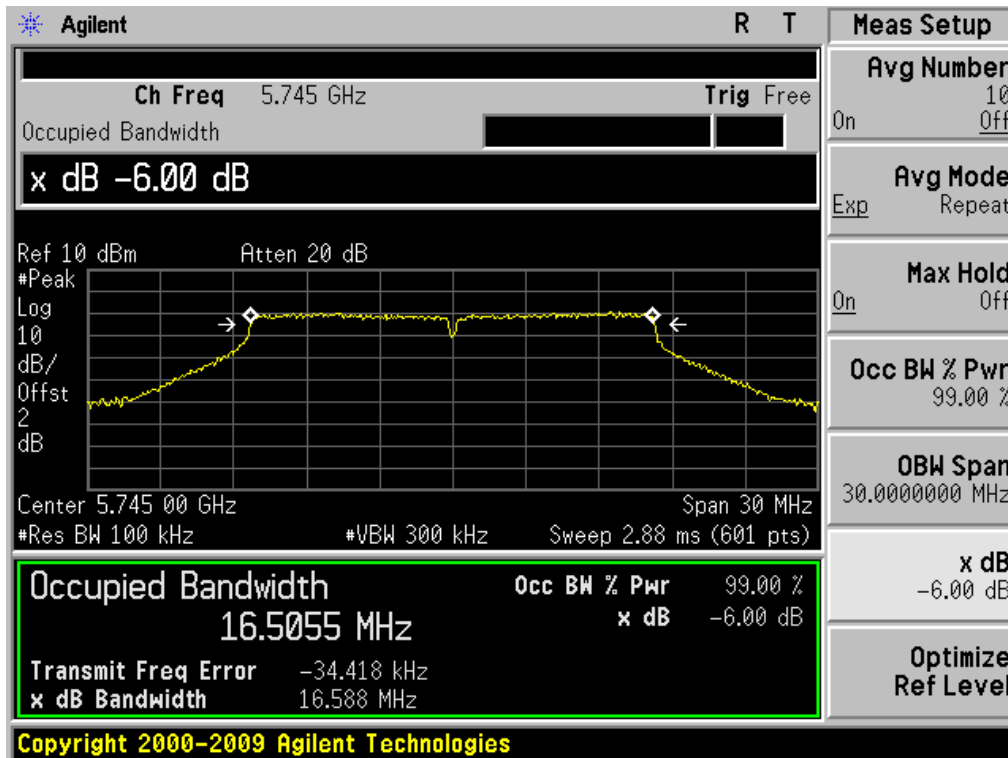
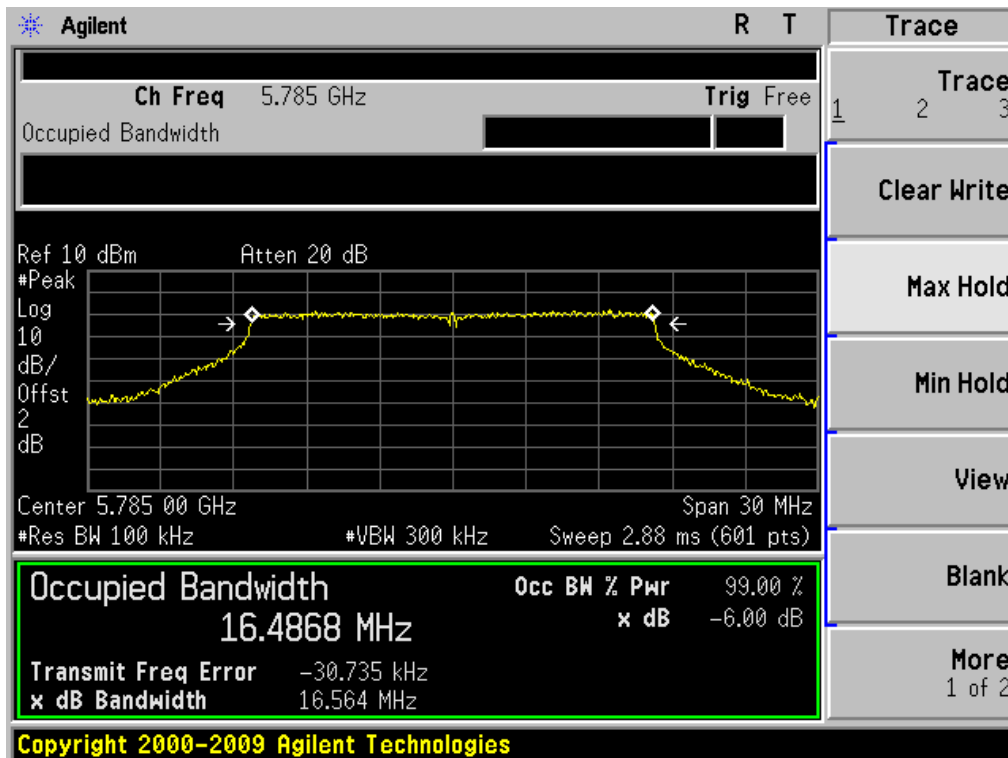
802.11a/5745MHz

802.11a/5785MHz

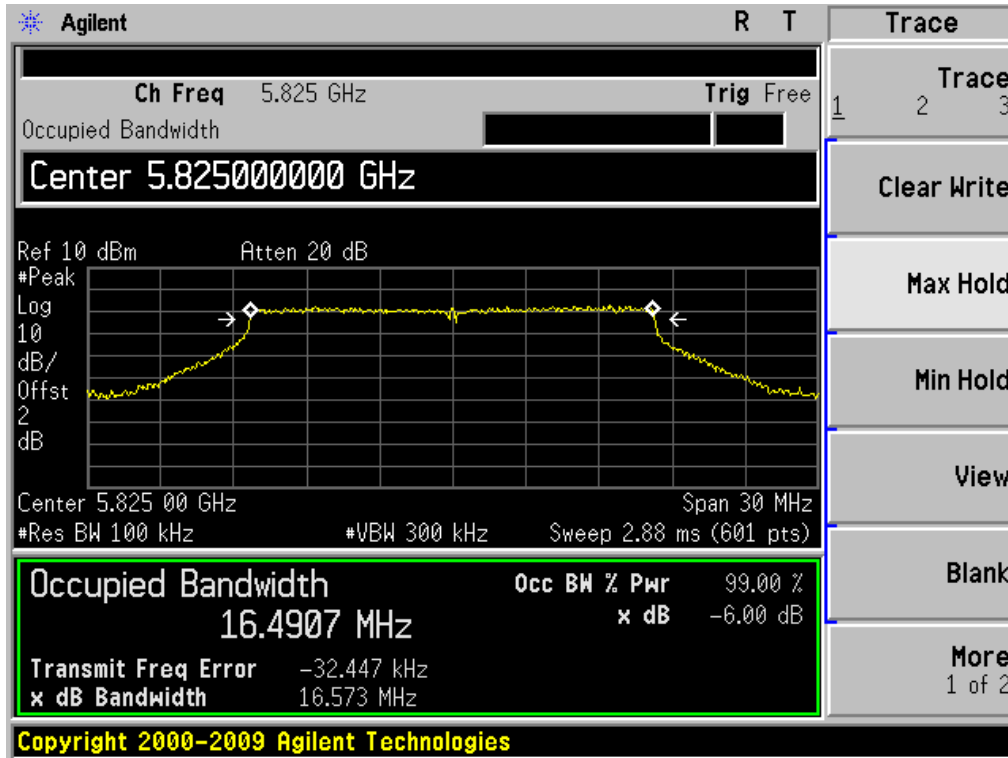
802.11a/5825MHz

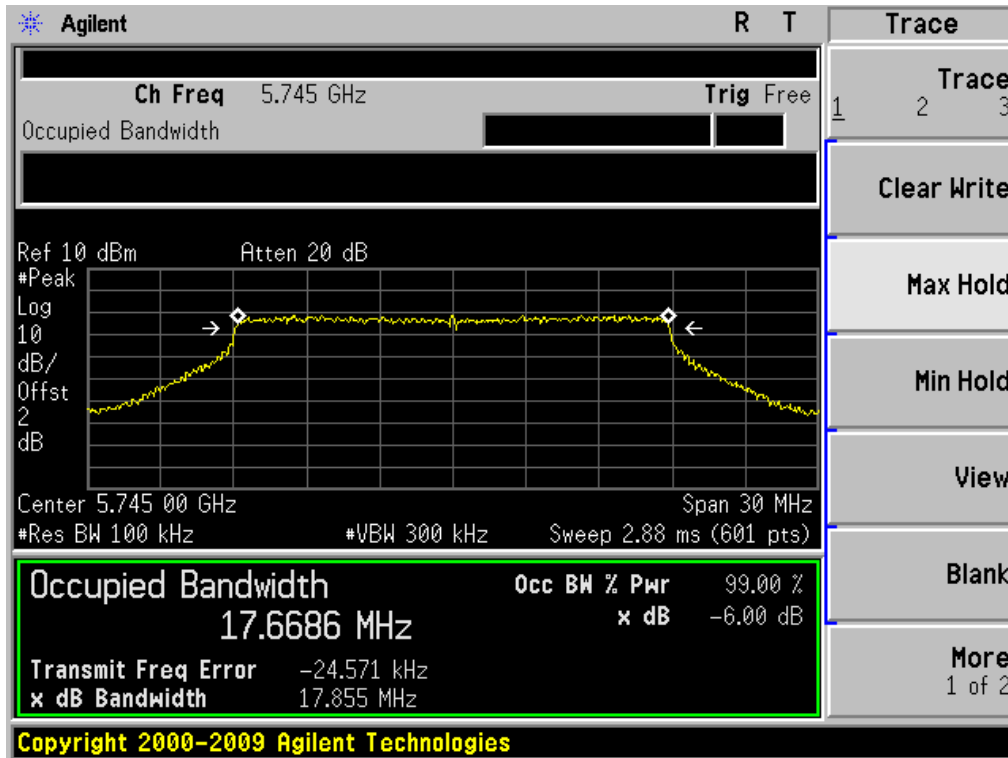

802.11n(HT20)/5745MHz

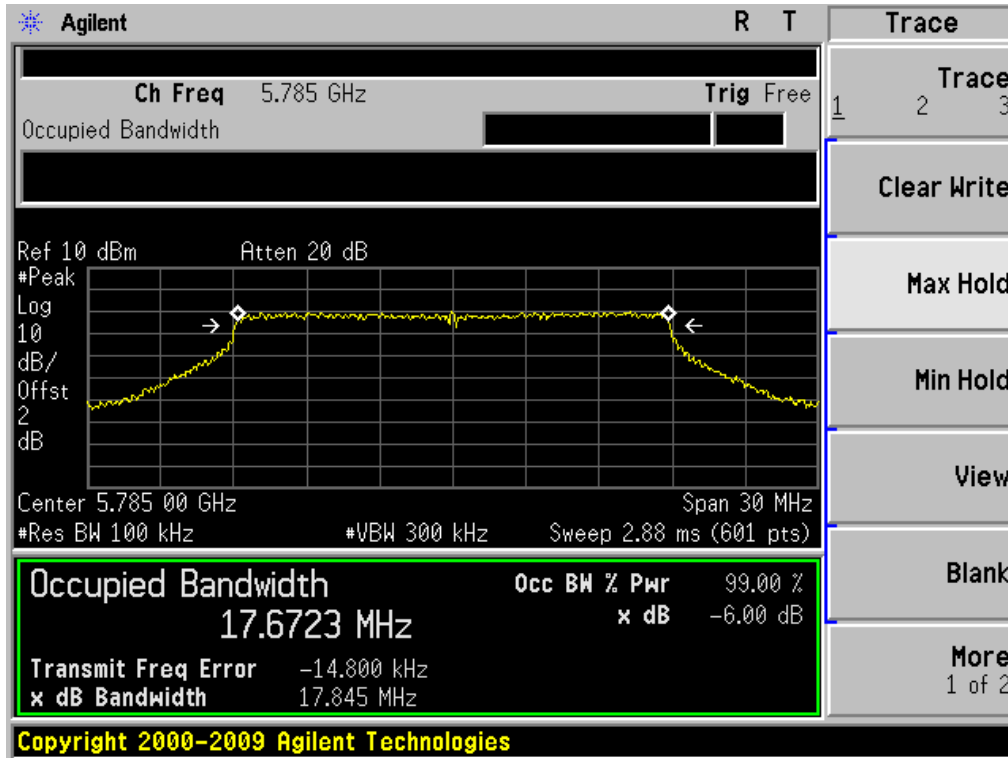
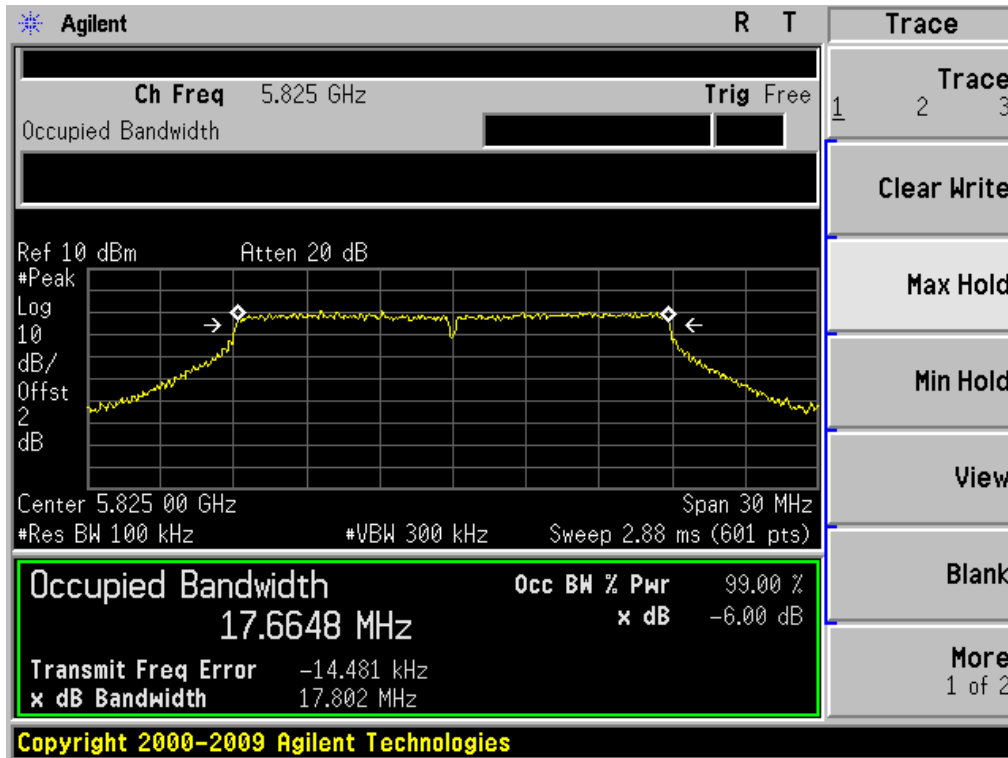

802.11n(HT20)/5785MHz

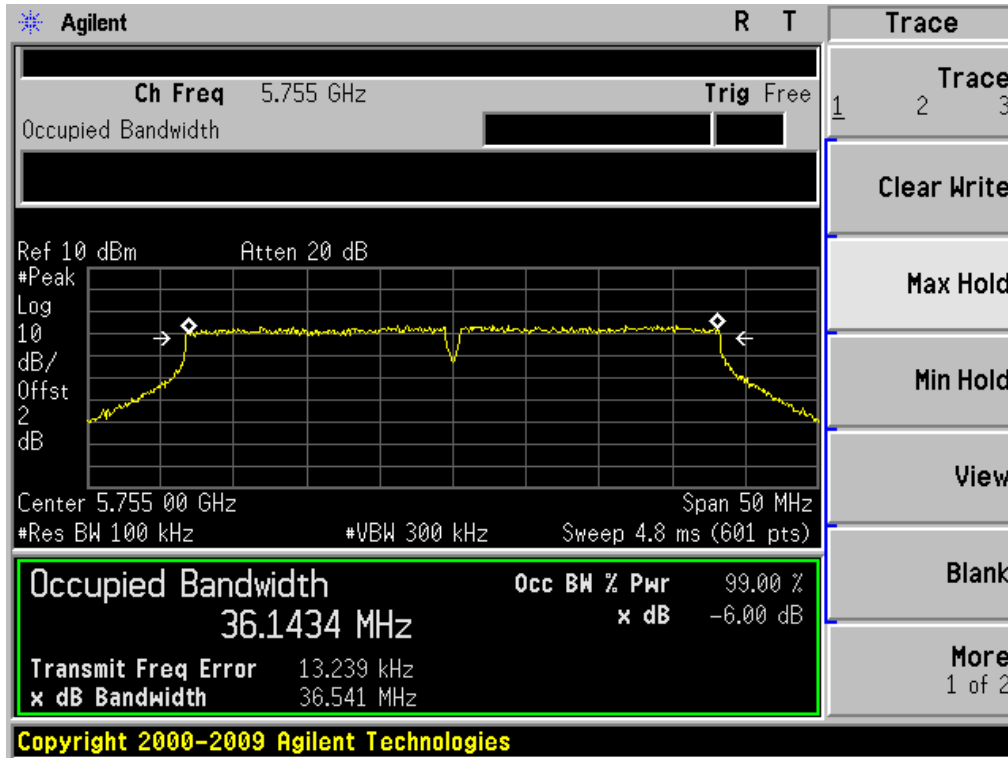
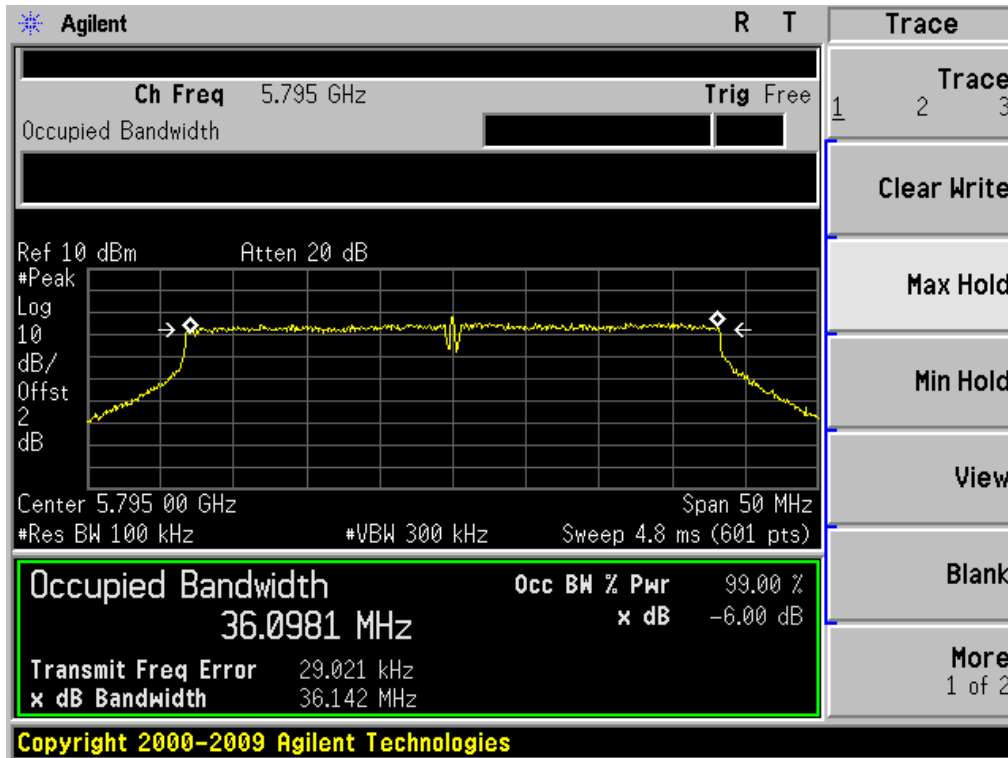
802.11n(HT20)/5825MHz

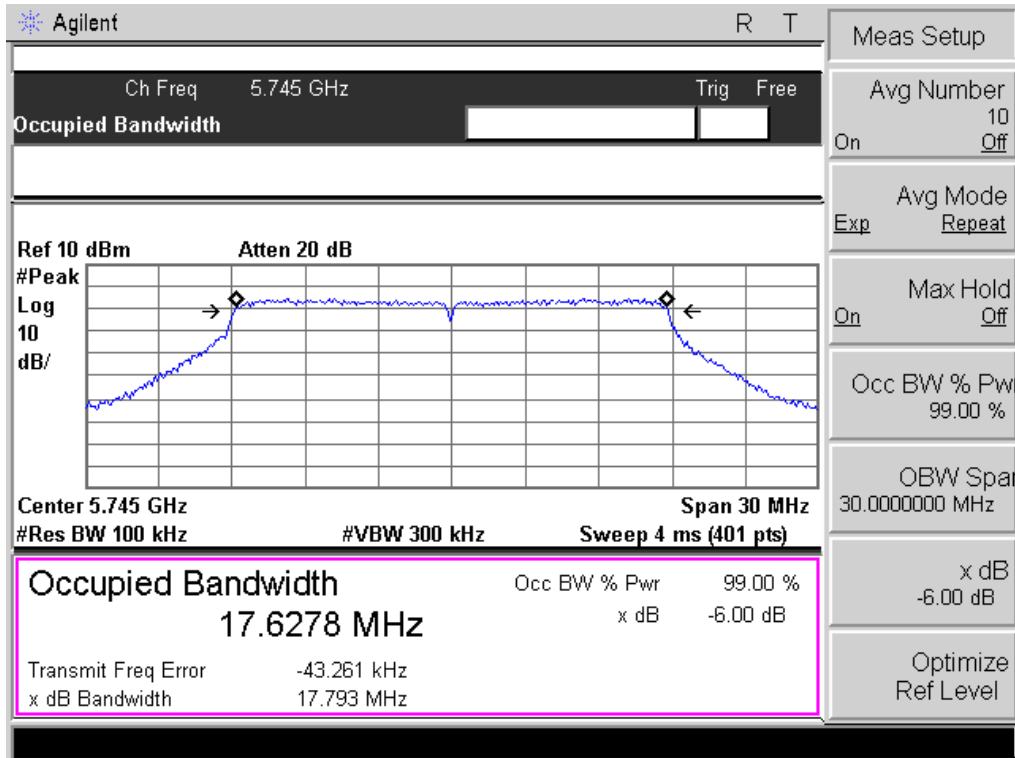
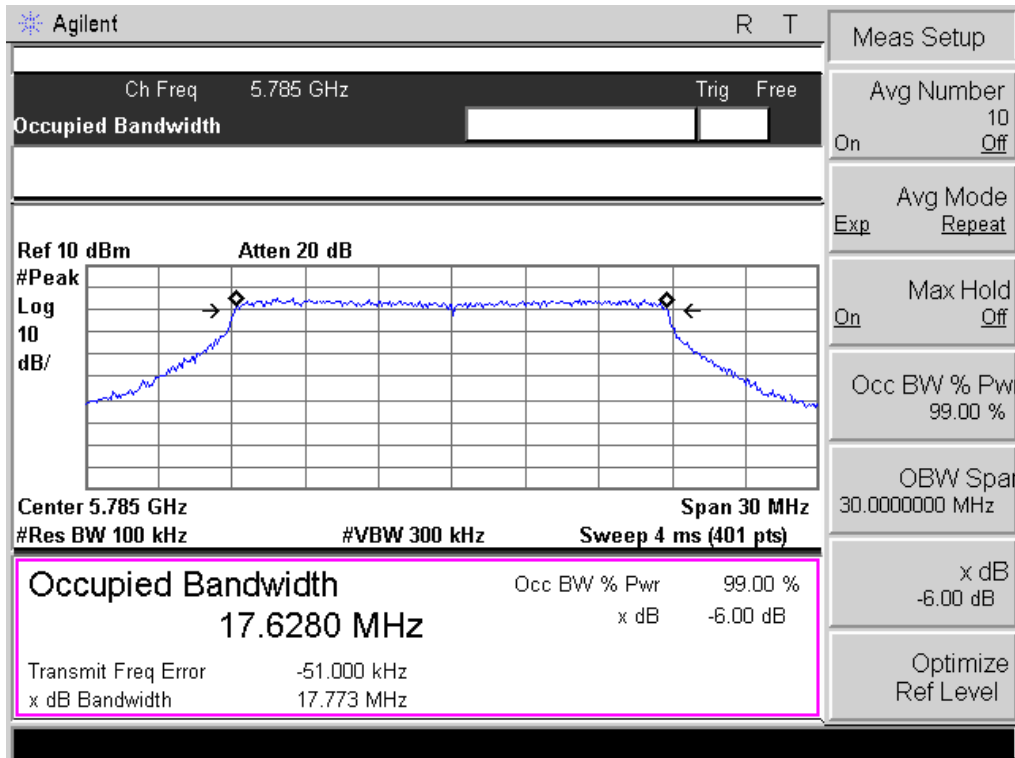
802.11n(HT40)/5755MHz

802.11n(HT40)/5795MHz

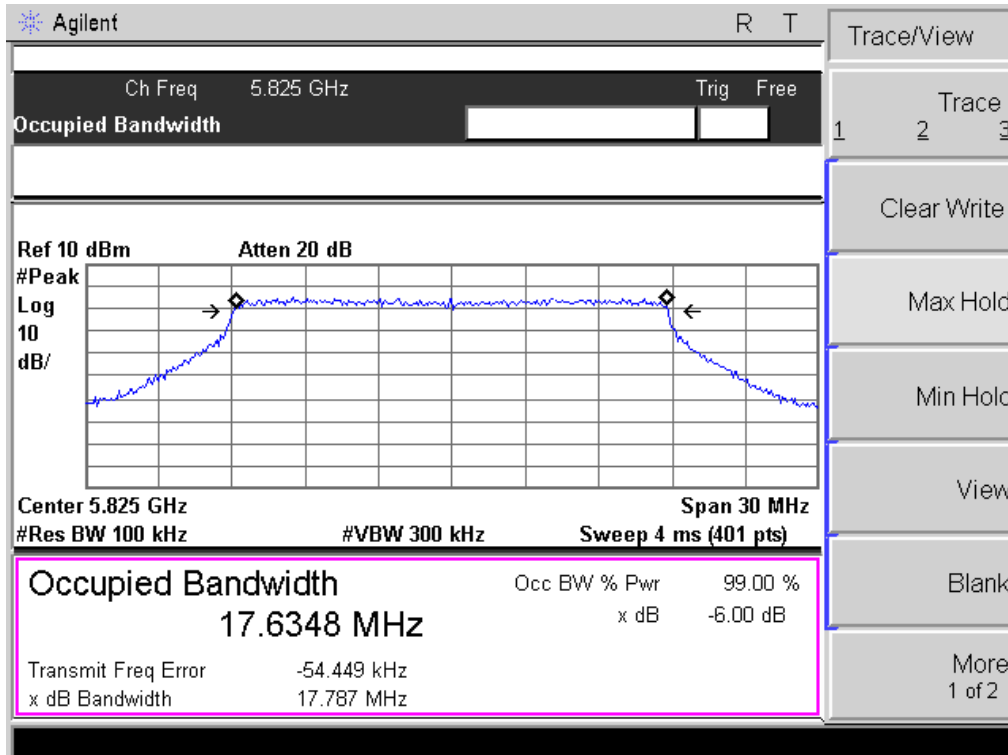
802.11ac(HT20)/5745MHz

802.11ac(HT20)/5785MHz

802.11ac(HT20)/5825MHz

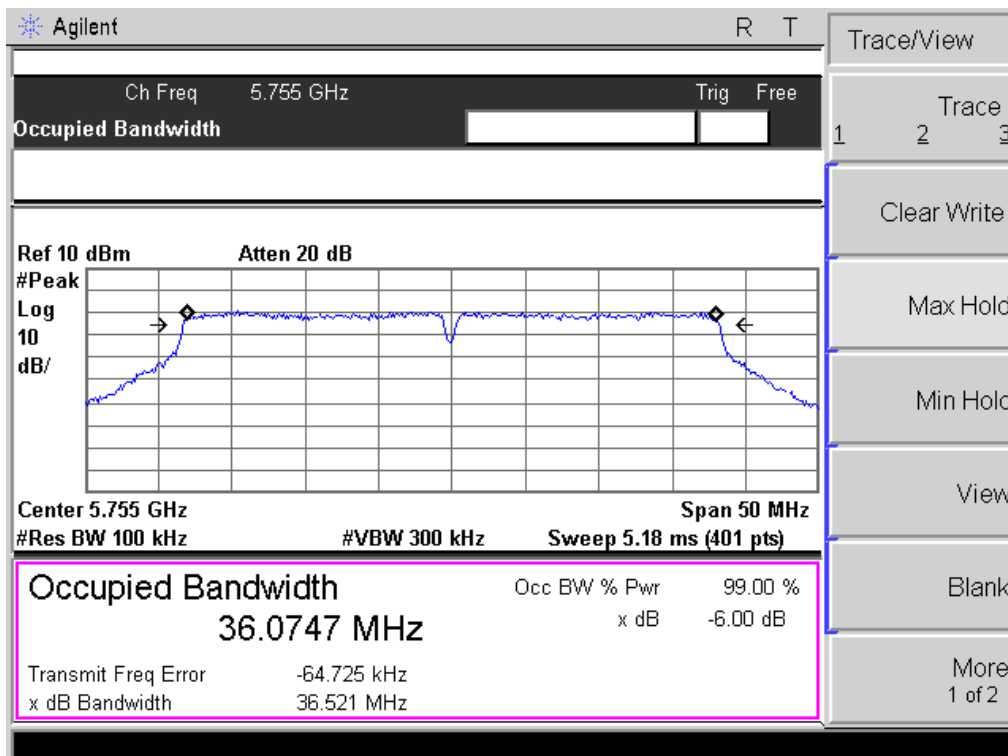

802.11ac(HT40)/5755MHz

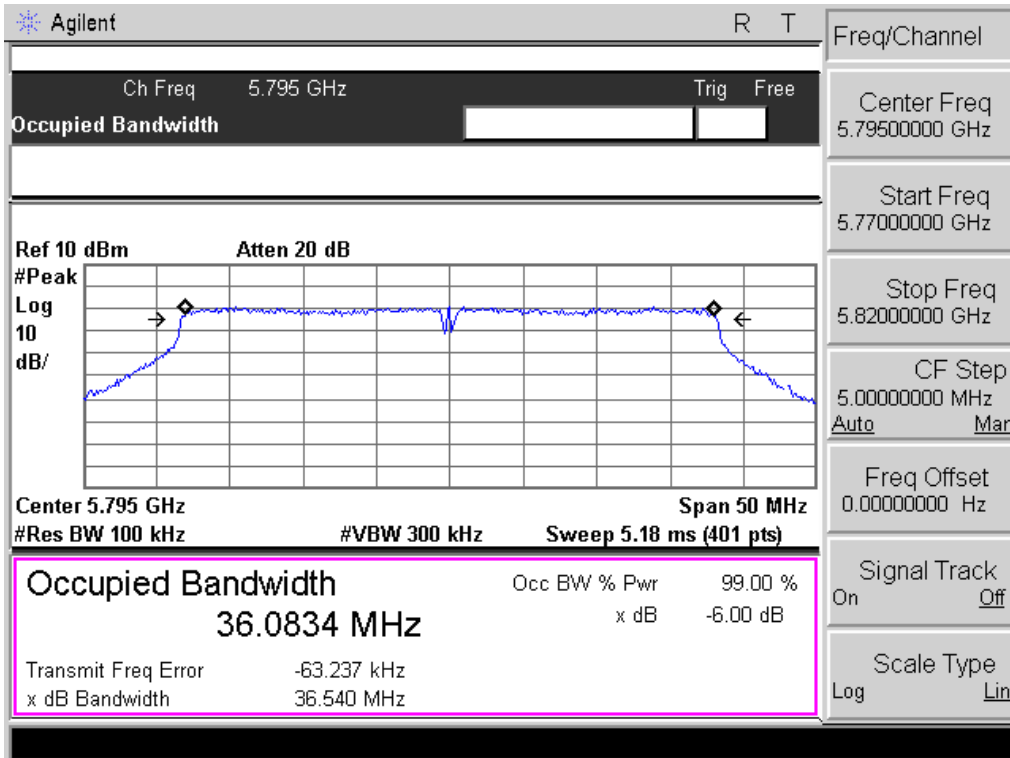
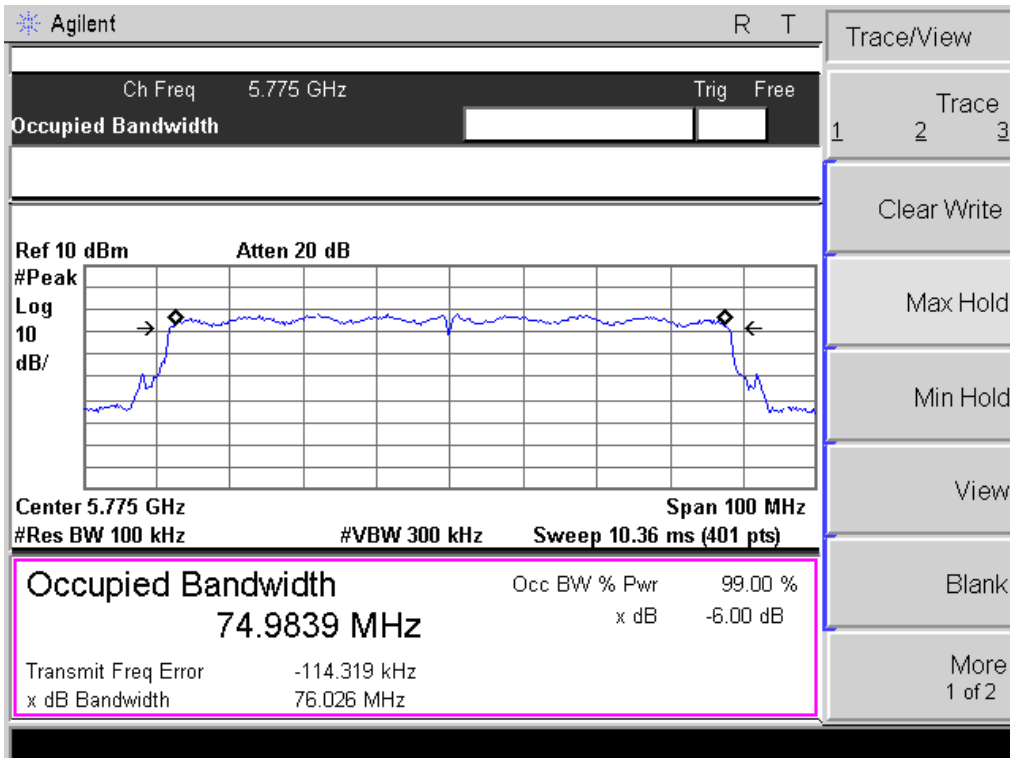

802.11ac(HT40)/5795MHz

802.11ac(HT80)/5775MHz

5.5 Maximum Peak Output Power

5.5.1 Applied procedures / Limit

15.247 (b)(3) For systems using digital modulation in the 902-928 MHz, 2400-2483.5 MHz, and 5725-5850 MHz band: 1 Watt.

5.5.2 Test procedure

FCC/KDB-558074 D01 v03r03 Clause 9.1.2.

- (1) Connected the antenna port to the broadband peak RF power meter, Allow the transmitted power to stabilize, record the max peak value.
- (2) The EUT should be transmitting at its maximum data rate.
- (3) The above procedure shall be repeated at the lowest, the middle, and the highest frequency of the stated frequency range with modulated mode. also shall be performed at different modes of operation.

For 802.11ac(HT80):

- (1) The EUT was directly connected to the spectrum analyzer and antenna output port as show in the block diagram below.
- (2) Spectrum Setting: RBW= 1MHz, VBW= 3MHz, Sweep time = Auto.

5.5.3 Deviation from standard

No deviation.

5.5.4 Test setup

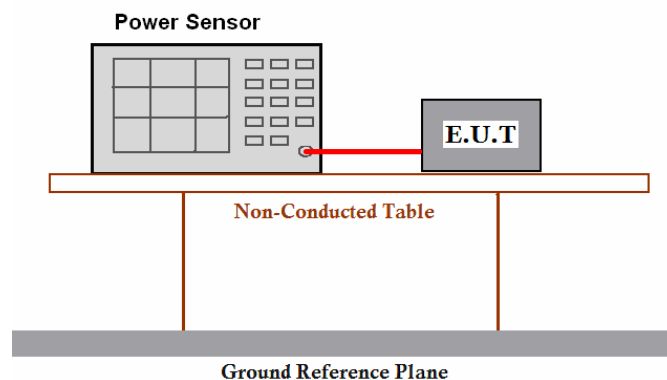

5.5.5 Test results

For 2.4GHz Band:

Channel No.	Frequency (MHz)	Mode	Measured Power (dBm)	Limit	Result
1	2412	802.11b	11.79	1W(30dBm)	Pass
6	2437		11.12		Pass
11	2462		9.09		Pass
1	2412	802.11g	9.66		Pass
6	2437		9.02		Pass
11	2462		9.95		Pass
1	2412	802.11n (HT20)	10.20		Pass
6	2437		8.97		Pass
11	2462		8.31		Pass
3	2422	802.11n (HT40)	7.75		Pass
6	2437		7.43		Pass
9	2452		7.25		Pass

Remark: Level = Read Level + Cable Loss.

The unit does meet the FCC requirements.

For 5GHz Band:

Channel No.	Frequency (MHz)	Mode	Measured Power (dBm)	Limit	Result
149	5745	802.11a	4.21	1W(30dBm)	Pass
157	5785		4.56		Pass
165	5825		4.87		Pass
149	5745	802.11n(HT20)	4.17		Pass
157	5785		4.73		Pass
165	5825		4.00		Pass
149	5755	802.11n(HT40)	3.52		Pass
157	5795		3.27		Pass
149	5745	802.11ac(HT20)	6.32		Pass
157	5785		6.13		Pass
165	5825		6.27		Pass
149	5755	802.11ac(HT40)	5.46		Pass
157	5795		5.70		Pass
155	5775	802.11ac(HT80)	7.04		Pass

Test result: The unit does meet the FCC requirements.

802.11ac(HT80)

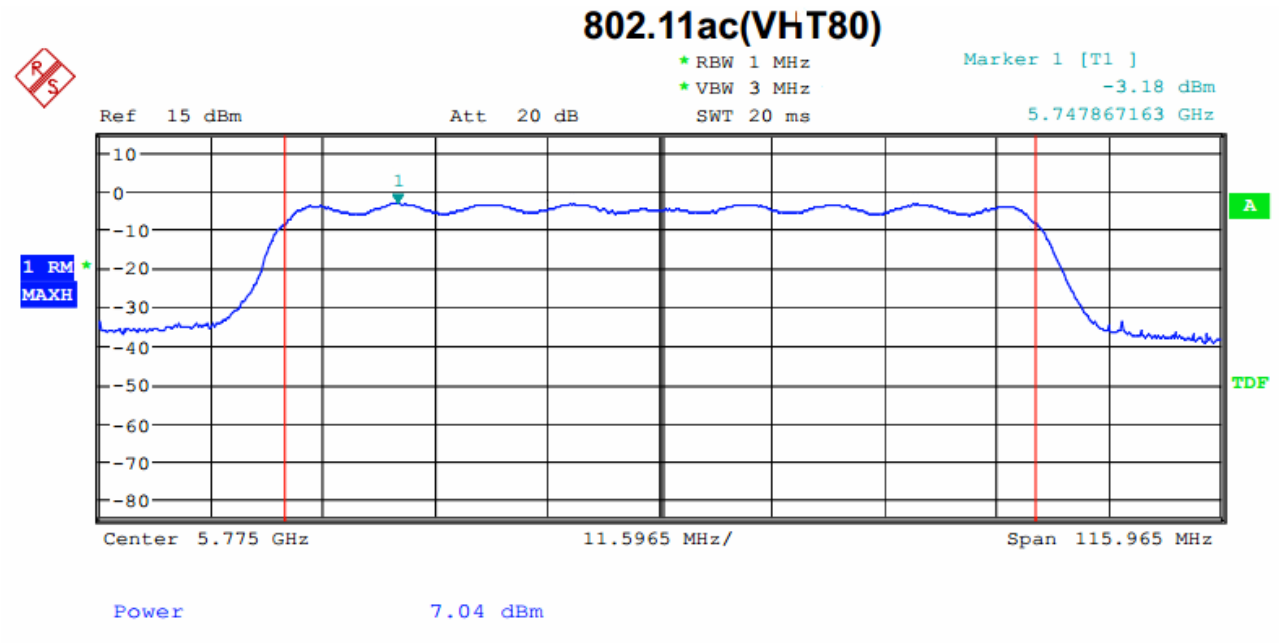

5.6 Peak Power Spectral Density

5.6.1 Applied procedures / Limit

15.247 (e) For digitally modulated systems, the power spectral density conducted from the intentional radiator to the antenna shall not be greater than 8 dBm in any 3 kHz band during any time interval of continuous transmission.

5.6.2 Test procedure

- (1) Connected the antenna port to the Spectrum Analyzer, set the Spectrum Analyzer as
CENTER FREQUENCY = Frequency from Power Spectral Density Test Matrix (see 6.10.2)
SPAN = 20 MHz (For devices with a nominal 40 MHz BW, 50 MHz span will be needed)
REFERENCE LEVEL = 20 dBm, ATTENUATION = 0 dB (add internal attenuation, if necessary)
SWEEP TIME = Coupled, RBW = 3 kHz, VBW = 10 kHz, DETECTOR = Peak
- (2) The EUT should be transmitting at its maximum data rate. Allow the trace to stabilize. Use the marker-to-peak function to set the marker to the peak of the emission. The indicated level is the peak output power.
- (3) The above procedure shall be repeated at the lowest, the middle, and the highest frequency of the stated frequency range with modulated mode. also shall be performed at different modes of operation

5.6.3 Deviation from standard

No deviation.

5.6.4 Test setup



5.6.5 Test results

For 2.4GHz Band:

Channel No.	Frequency (MHz)	Mode	Measured Peak Power Spectral Density (dBm/3KHz)	Limit	Result
1	2412	802.11b	4.08	8dBm/3KHz	Pass
6	2437		4.28		Pass
11	2462		4.31		Pass
1	2412	802.11g	-1.50		Pass
6	2437		-1.47		Pass
11	2462		-1.45		Pass
1	2412	802.11n (HT20)	-1.43		Pass
6	2437		-1.54		Pass
11	2462		-1.31		Pass
3	2422	802.11n (HT40)	-7.13		Pass
6	2437		-6.89		Pass
9	2452		-6.64		Pass

Test result: Level = Read Level + Cable Loss.

The unit does meet the FCC requirements.

For 5GHz Band:

Channel No.	Frequency (MHz)	Mode	Measured Peak Power Spectral Density (dBm/3KHz)	Limit	Result
149	5745	802.11a	-0.18	8dBm/3KHz	Pass
157	5785		0.33		Pass
165	5825		0.07		Pass
149	5745	802.11n(HT20)	-0.51		Pass
157	5785		-0.10		Pass
165	5825		-0.60		Pass
149	5755	802.11n(HT40)	-3.73		Pass
157	5795		-4.14		Pass
149	5745	802.11ac(HT20)	-1.31		Pass
157	5785		-0.27		Pass
165	5825		-1.77		Pass
149	5755	802.11ac(HT40)	-4.86		Pass
157	5795		-5.22		Pass
155	5775	802.11ac(HT80)	-7.39		Pass

Test result: Level = Read Level + Cable Loss.

The unit does meet the FCC requirements.

Result plot as follows:

802.11b/lowest

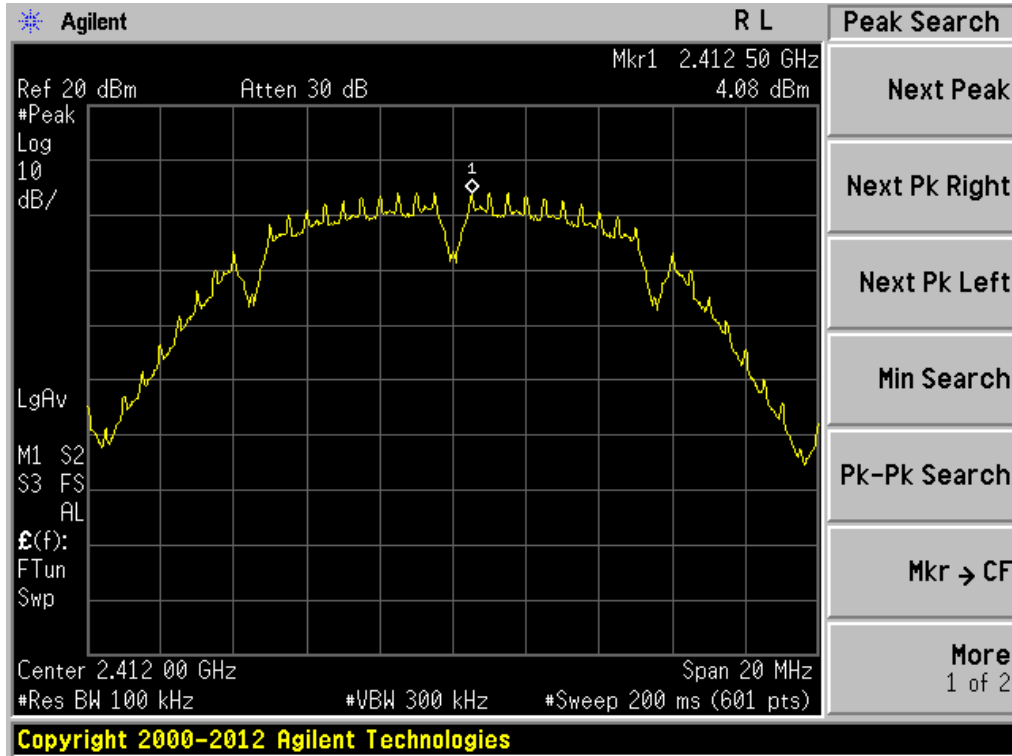

802.11b/middle

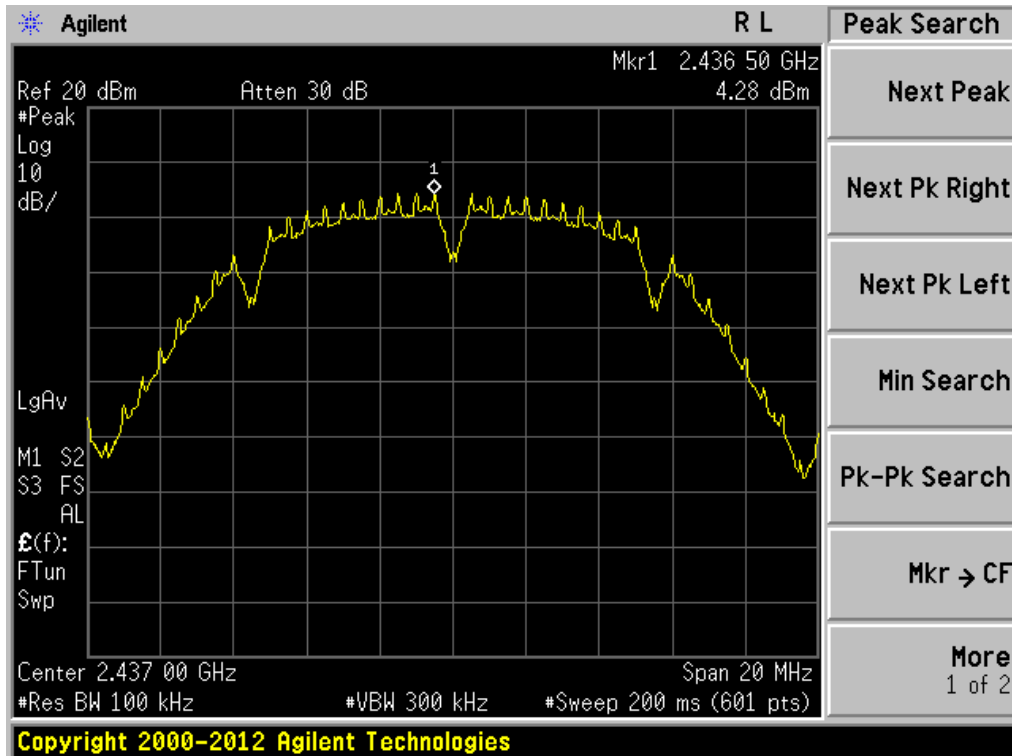

802.11b/highest

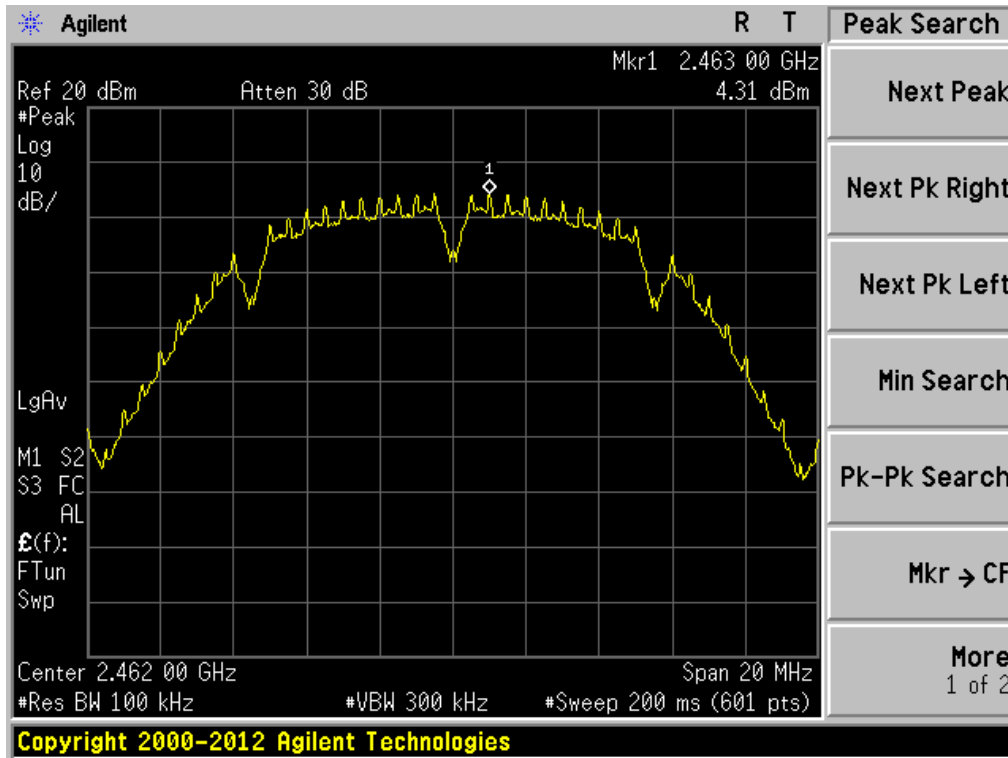

802.11g/lowest

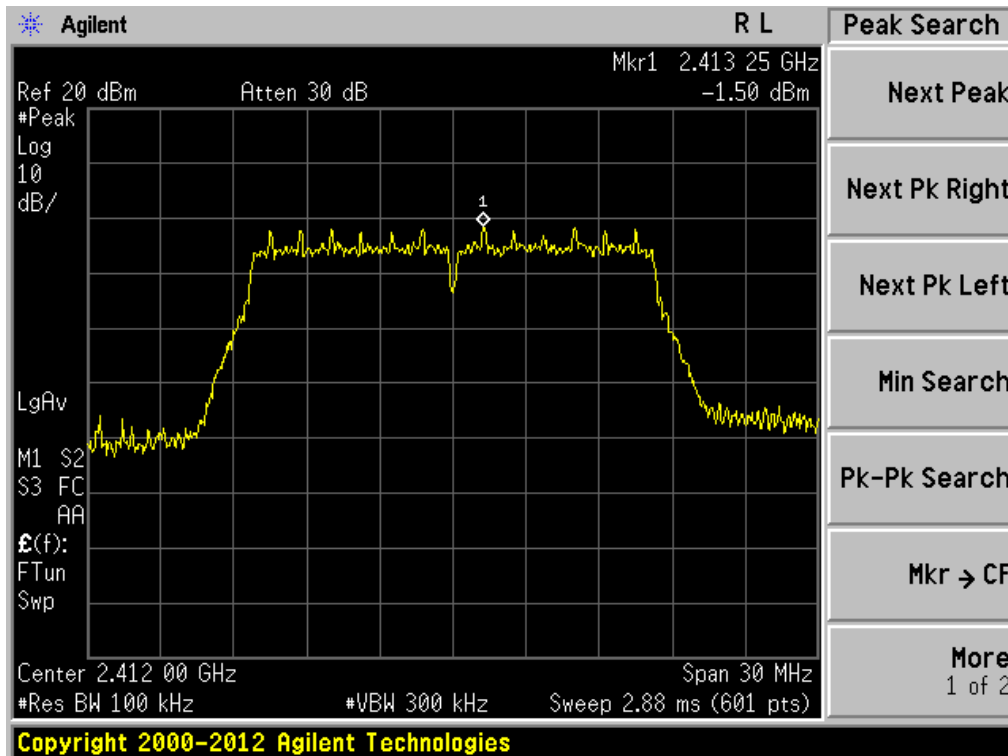

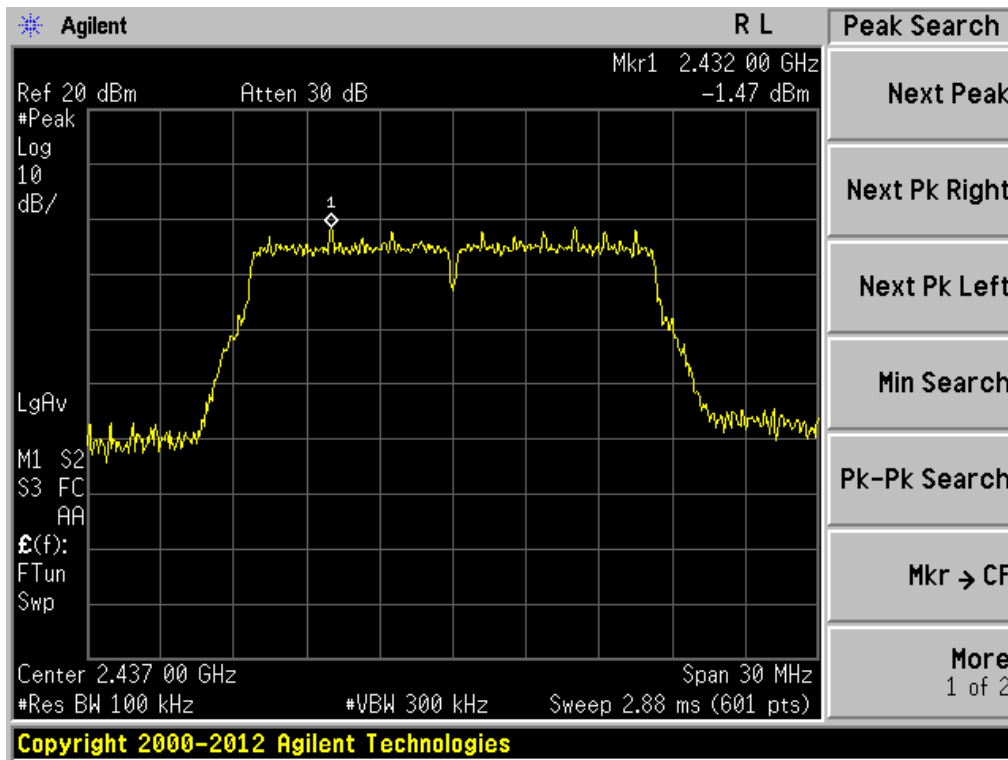
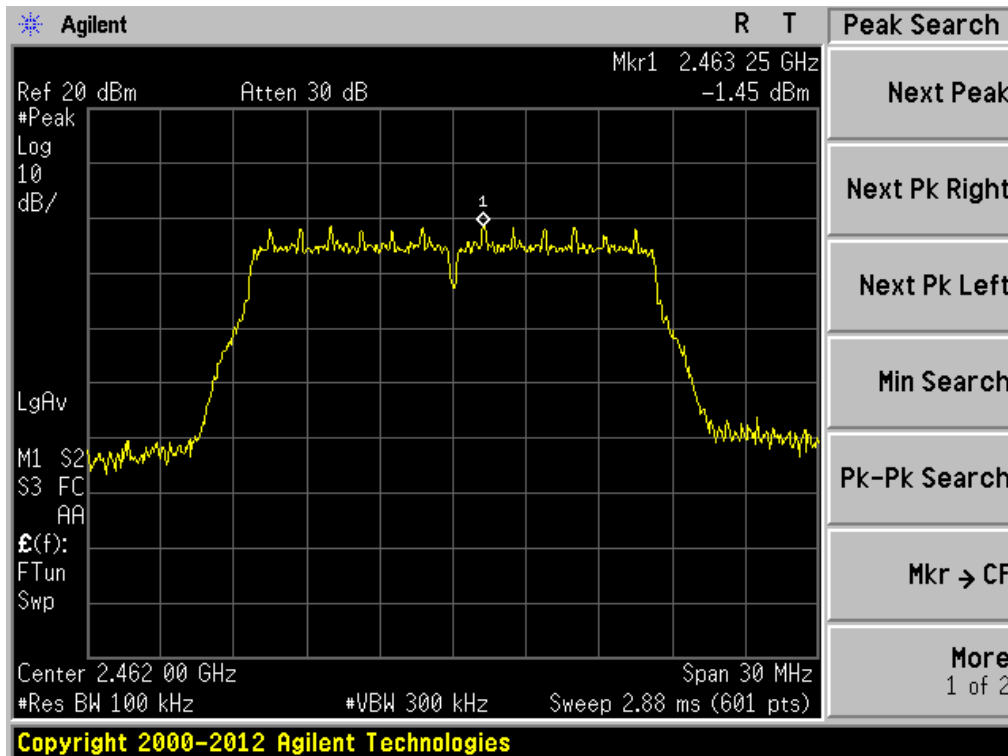
802.11g/middle

802.11g/highest

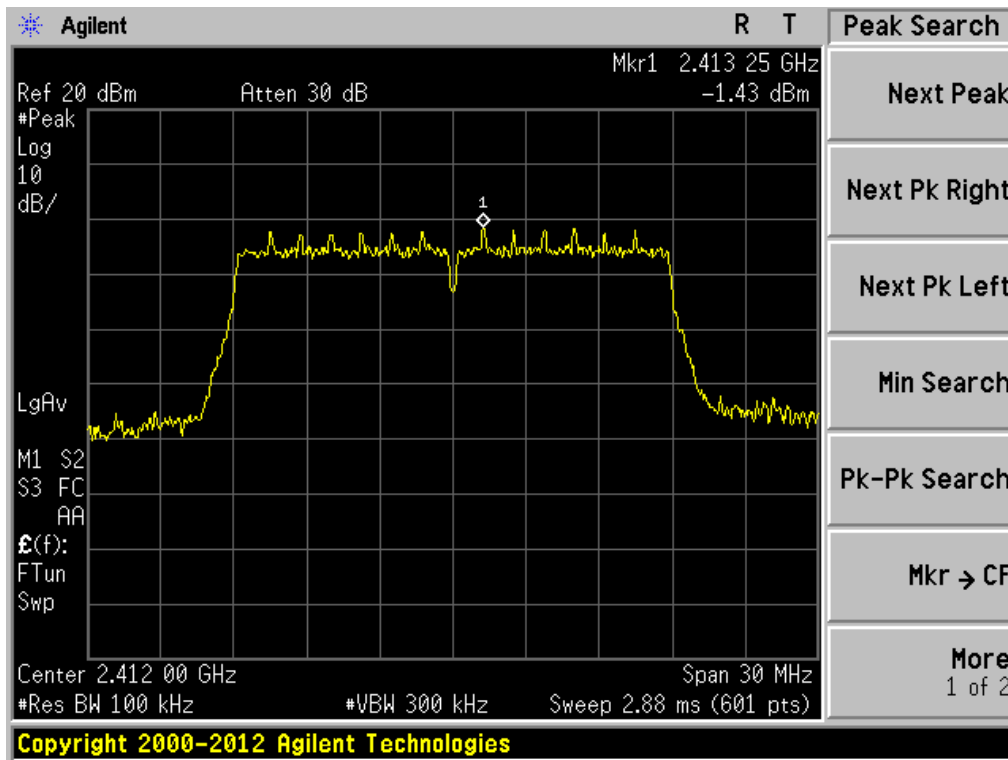
802.11n(HT20)/lowest

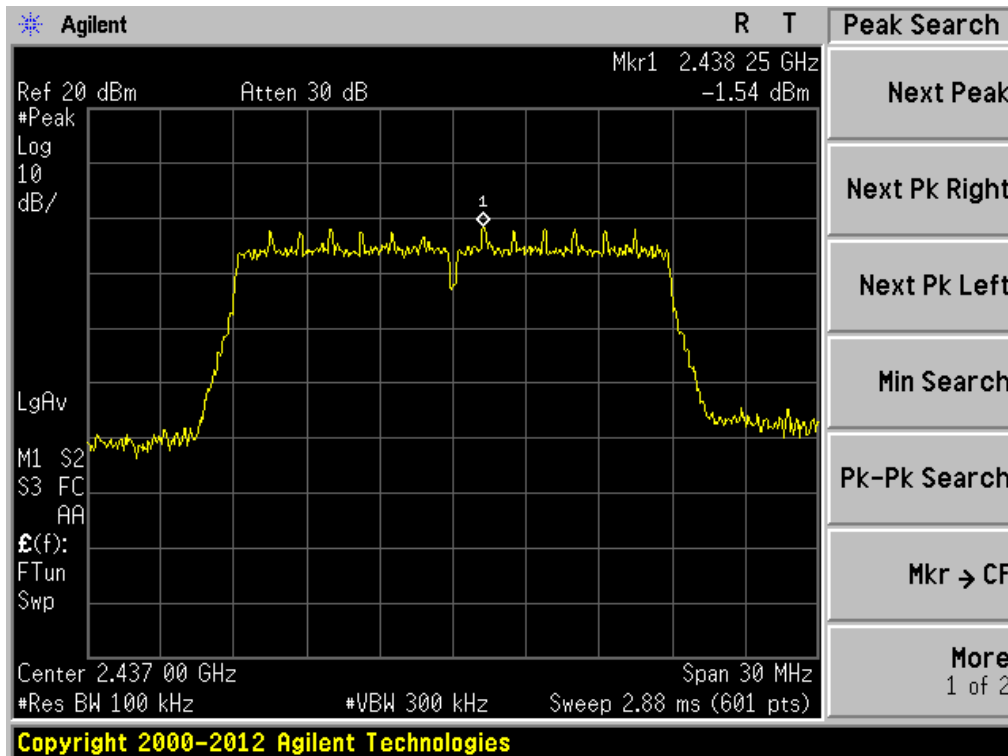

802.11n(HT20)/middle



802.11n(HT20)/highest

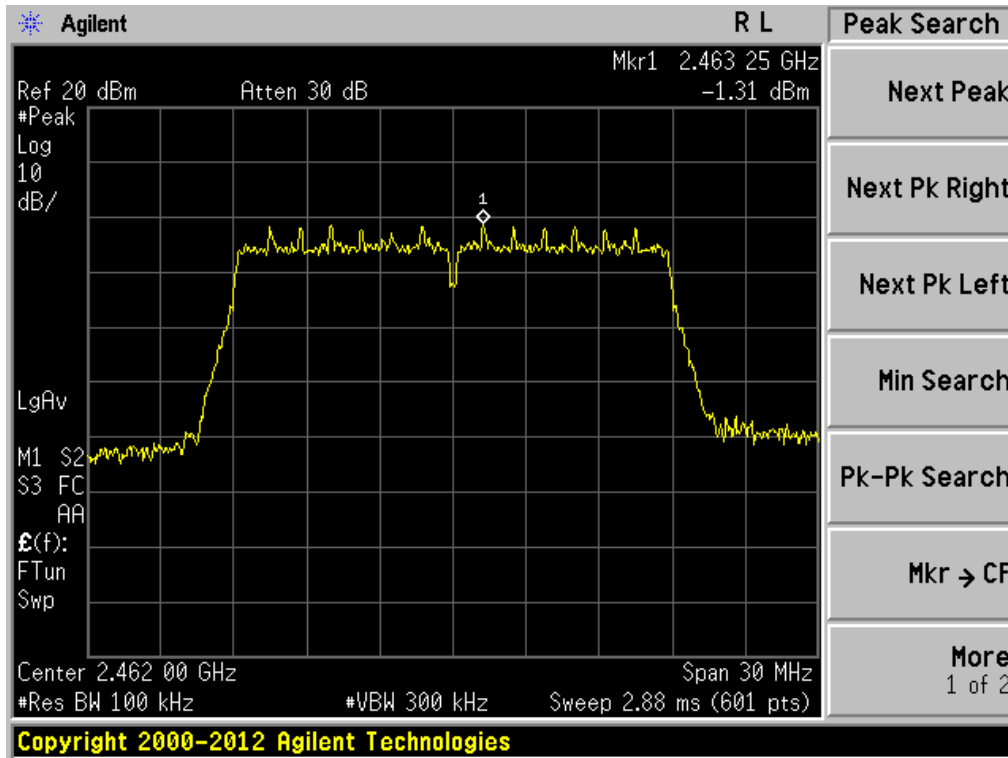

802.11n(HT40)/lowest

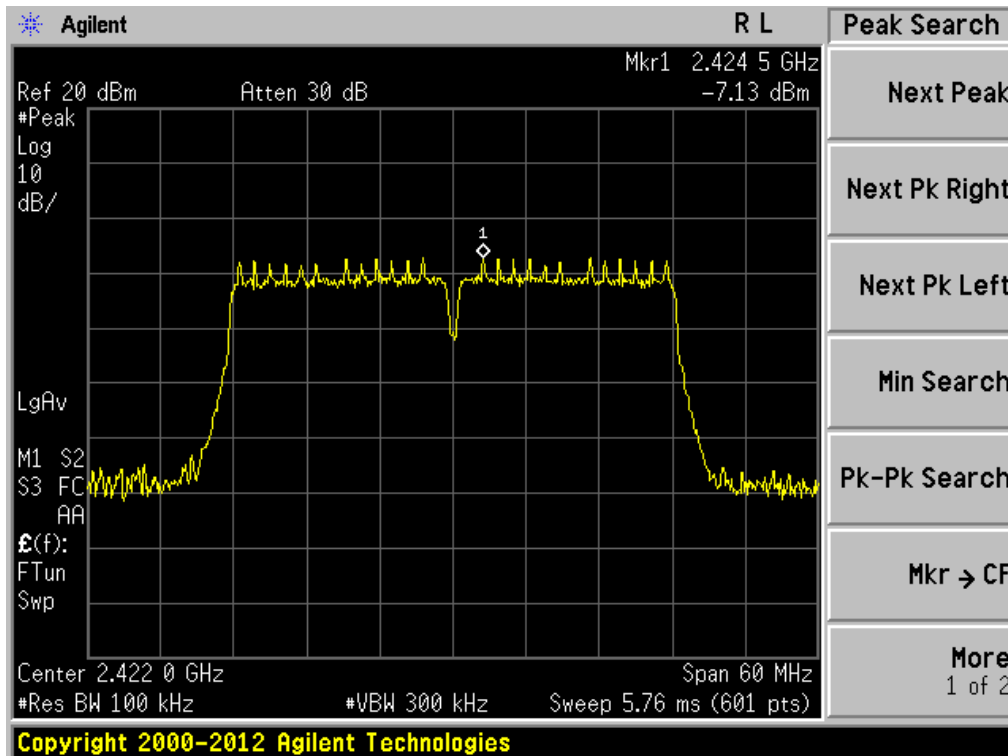

802.11n(HT40)/middle

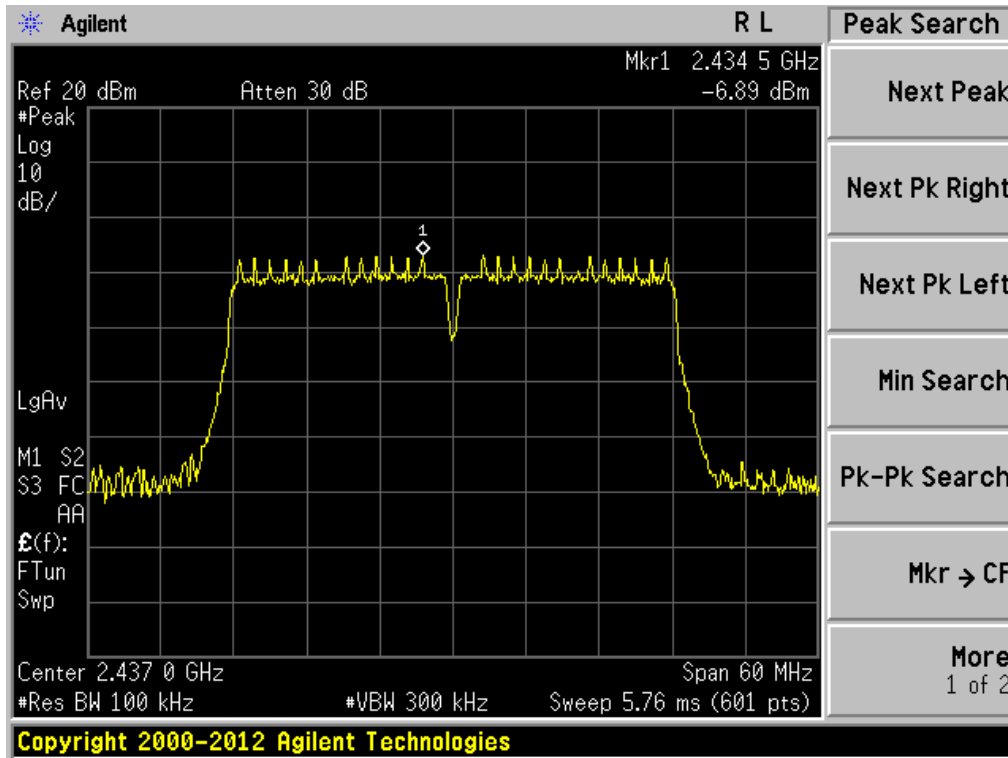

802.11n(HT40)/highest

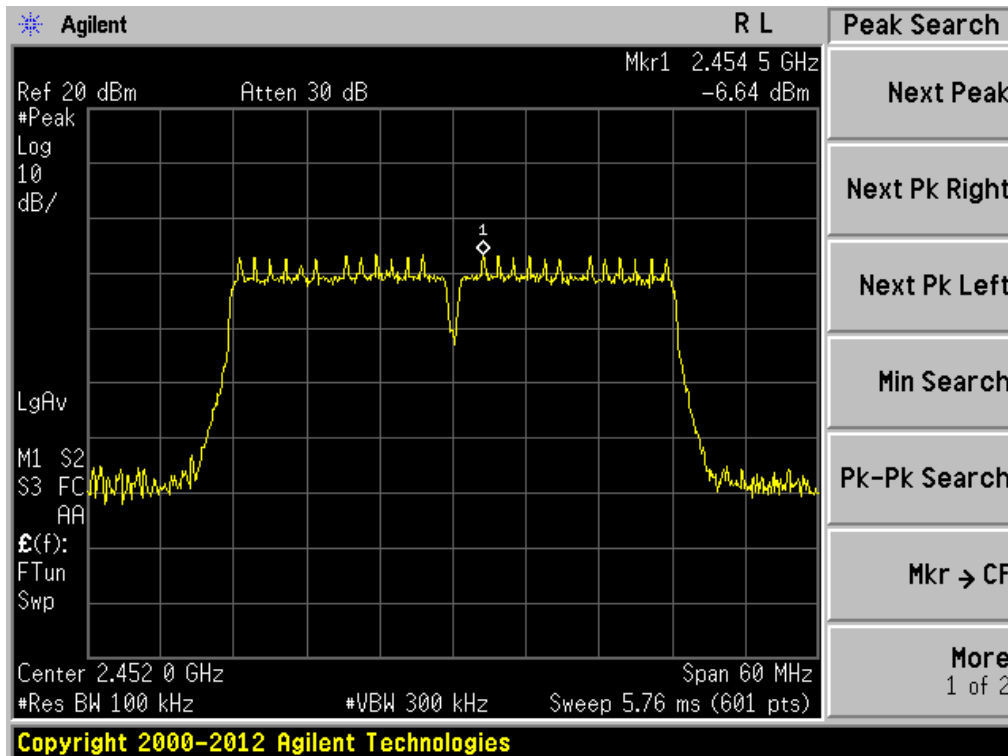

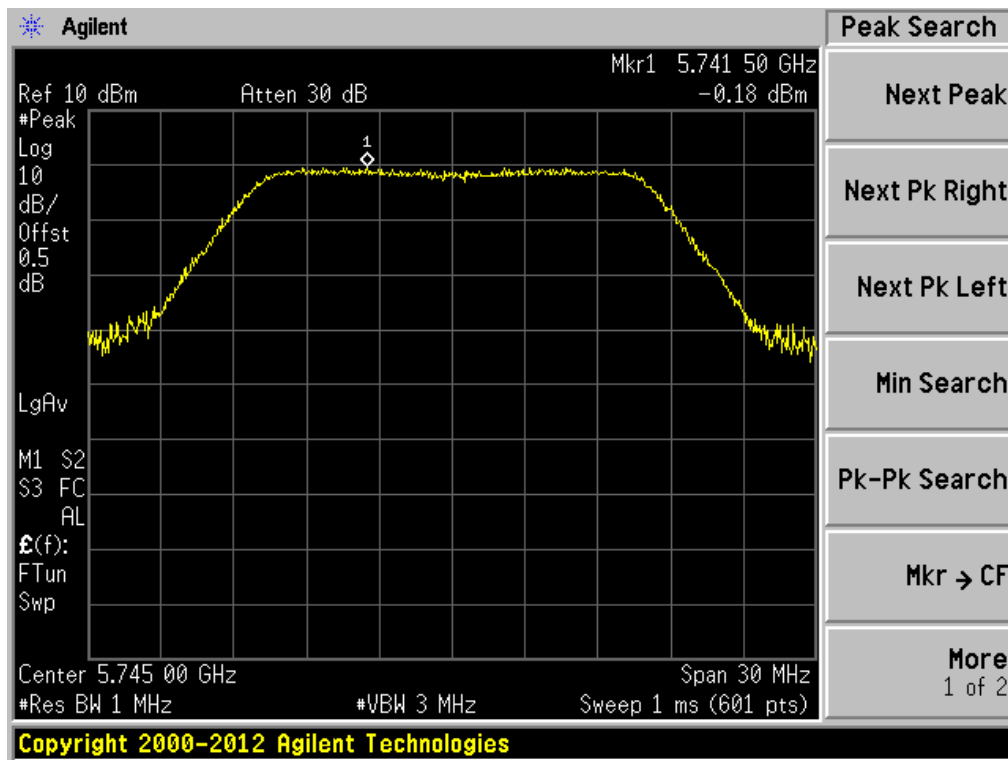
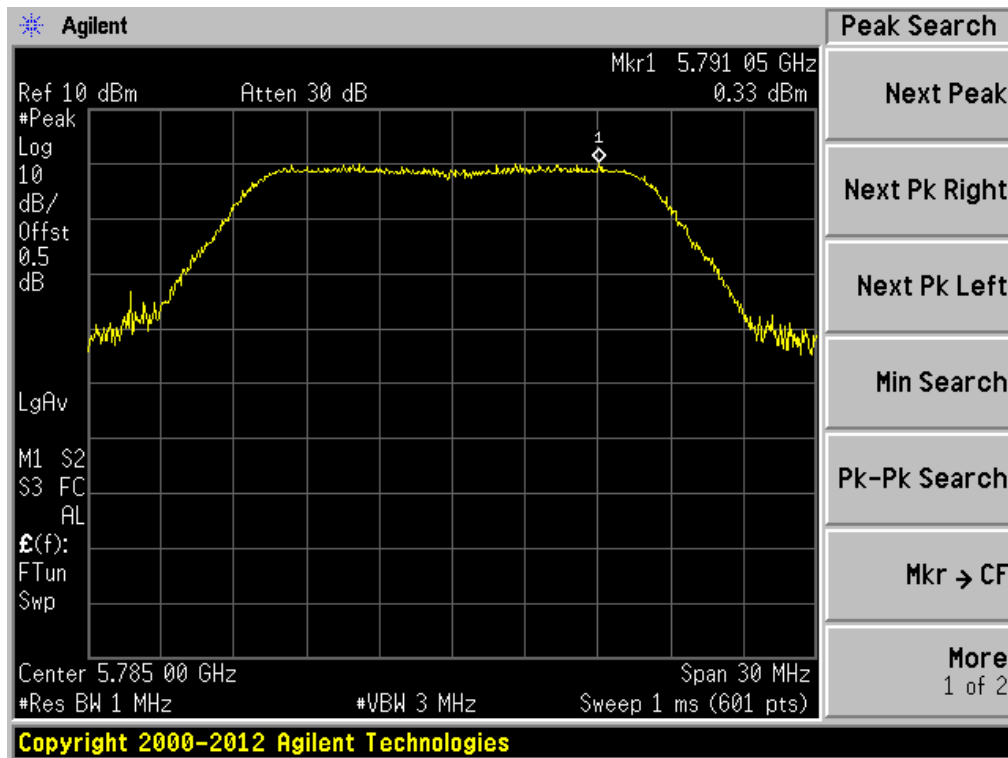
802.11a/lowest

802.11a/middle

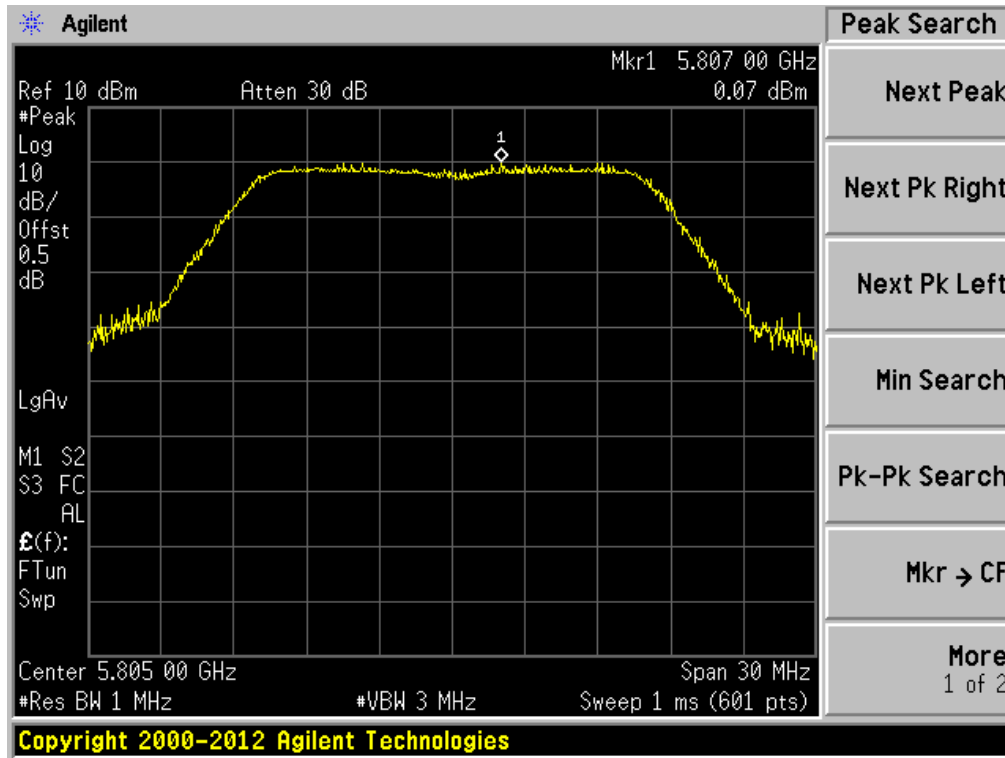
802.11a/highest

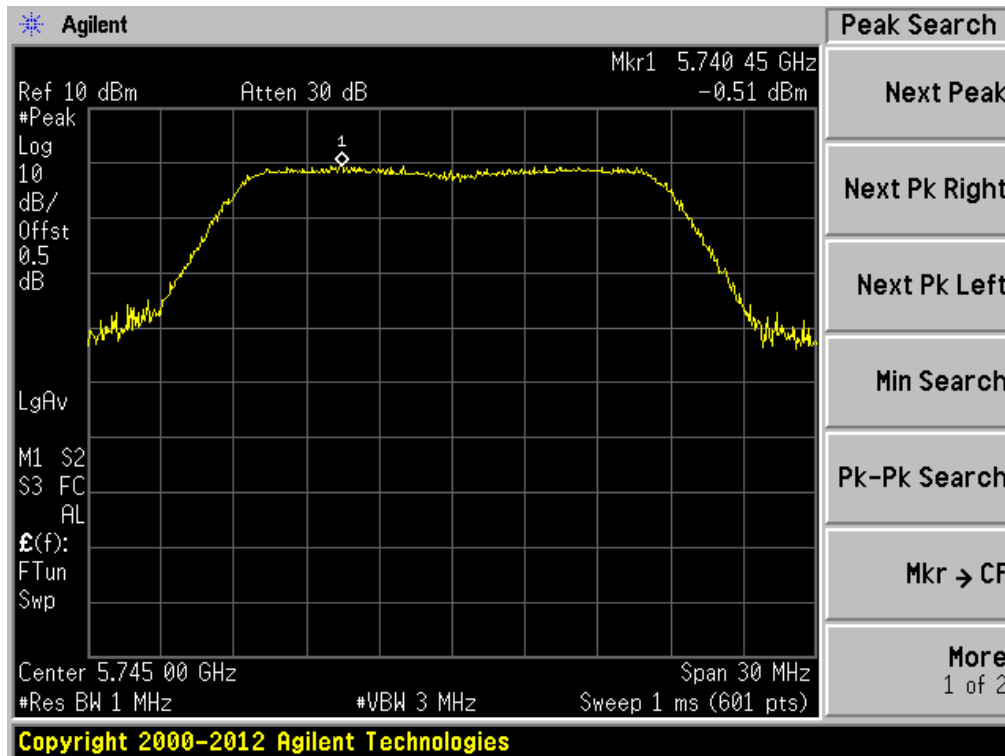

802.11n(HT20)/lowest

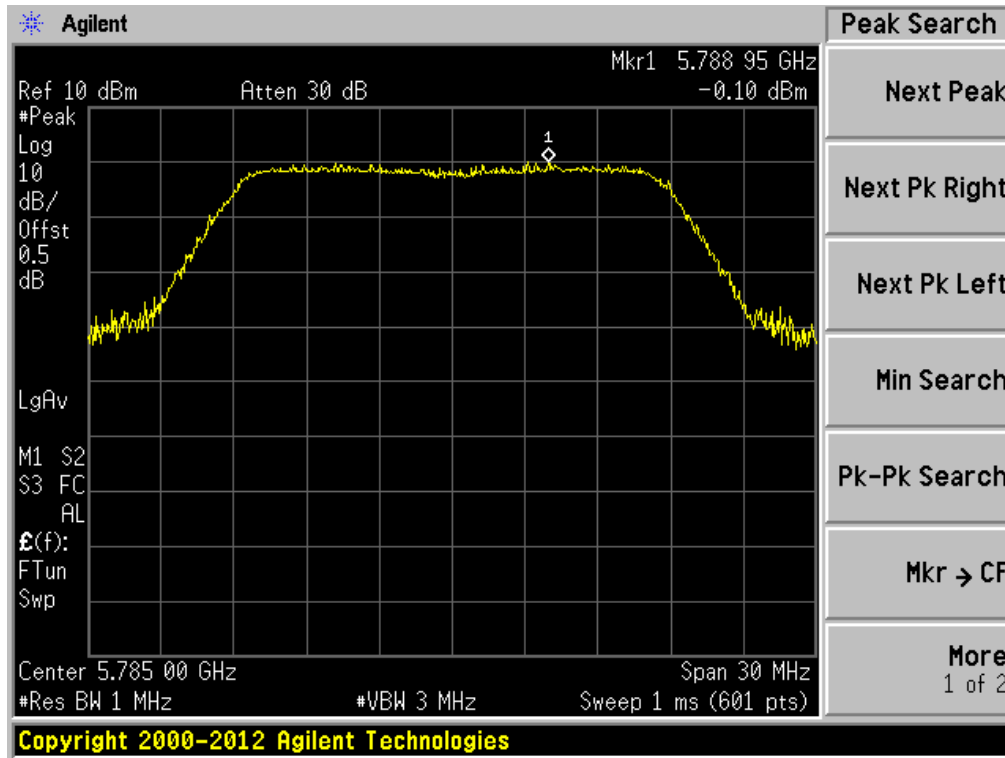
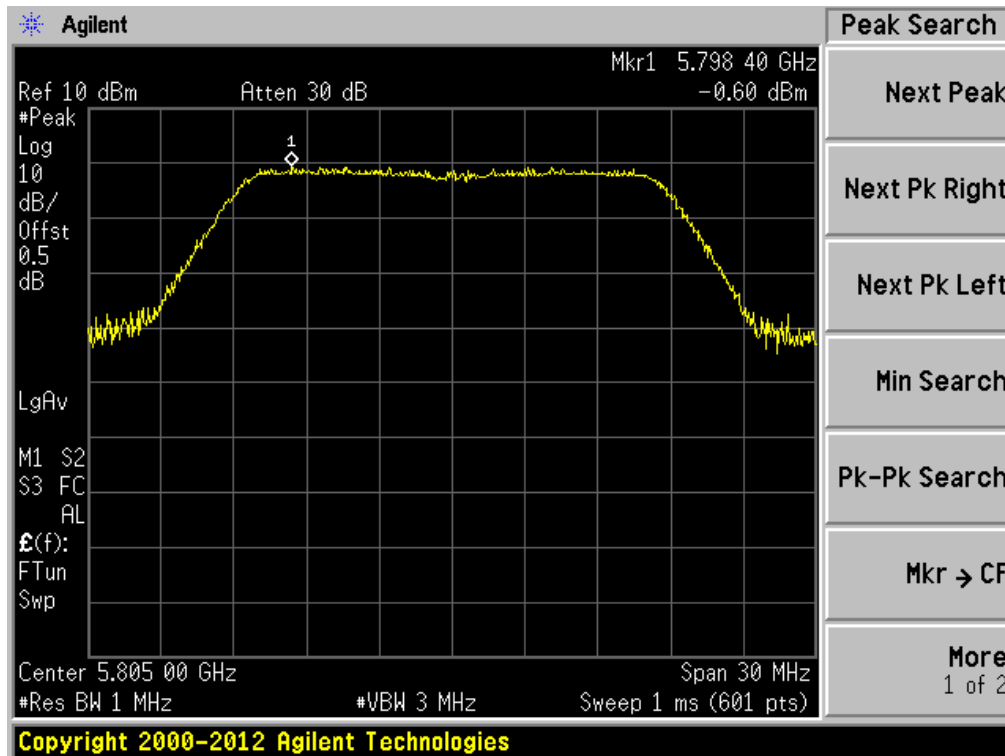

802.11n(HT20)/middle

802.11n(HT20)/highest

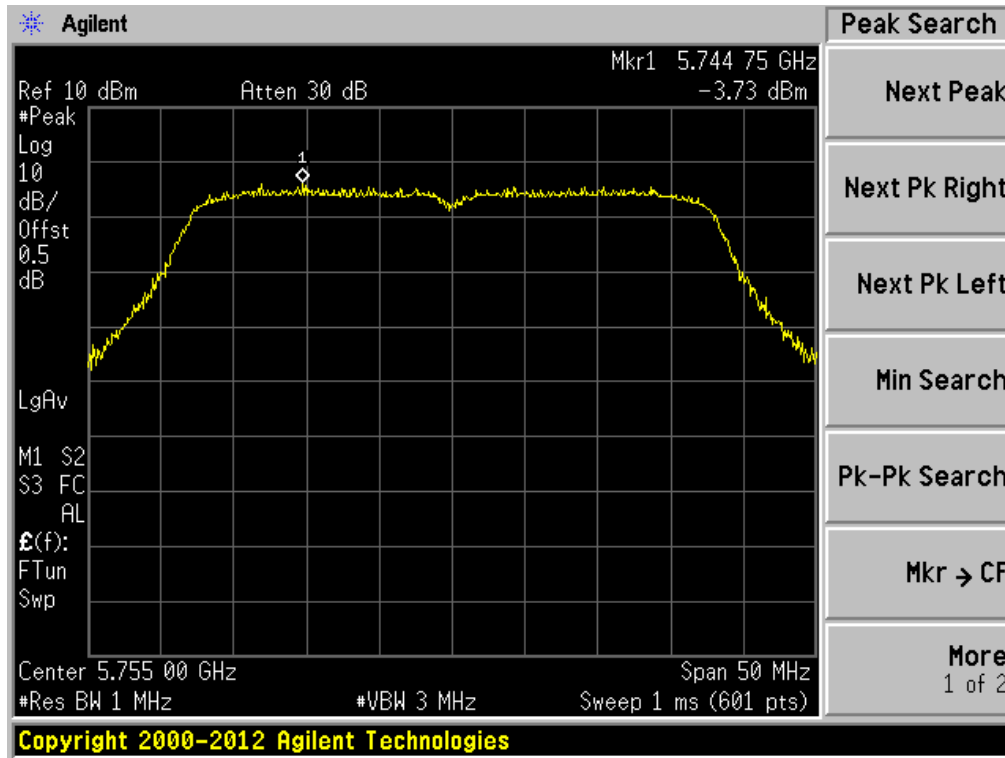
802.11n(HT40)/lowest

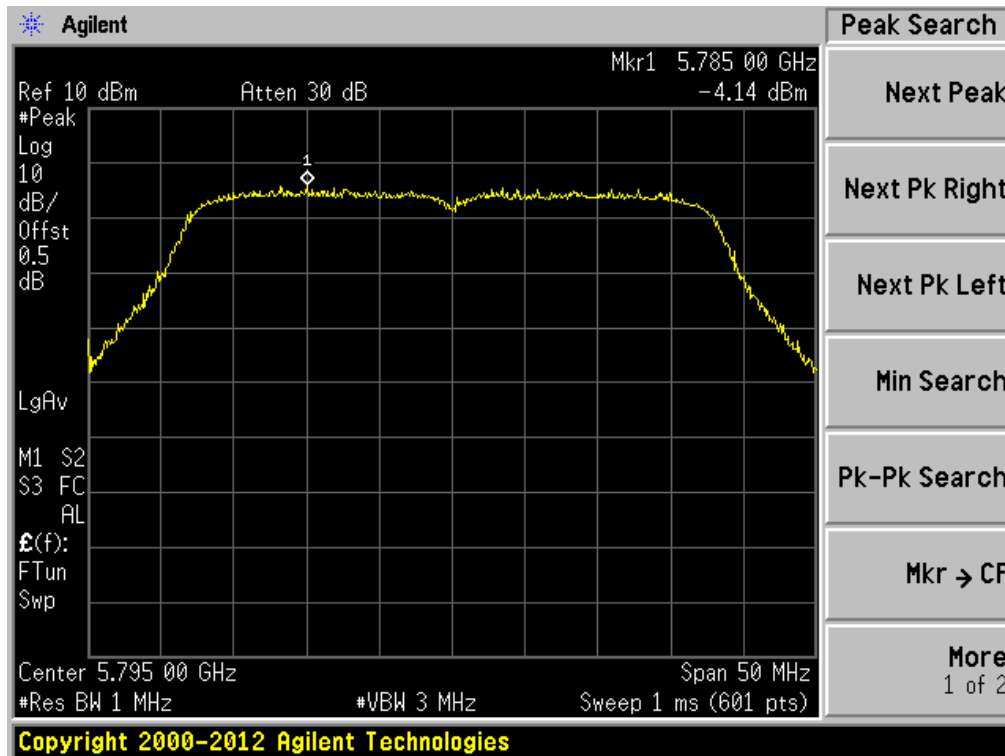

802.11n(HT40)/highest



802.11ac(HT20)/lowest

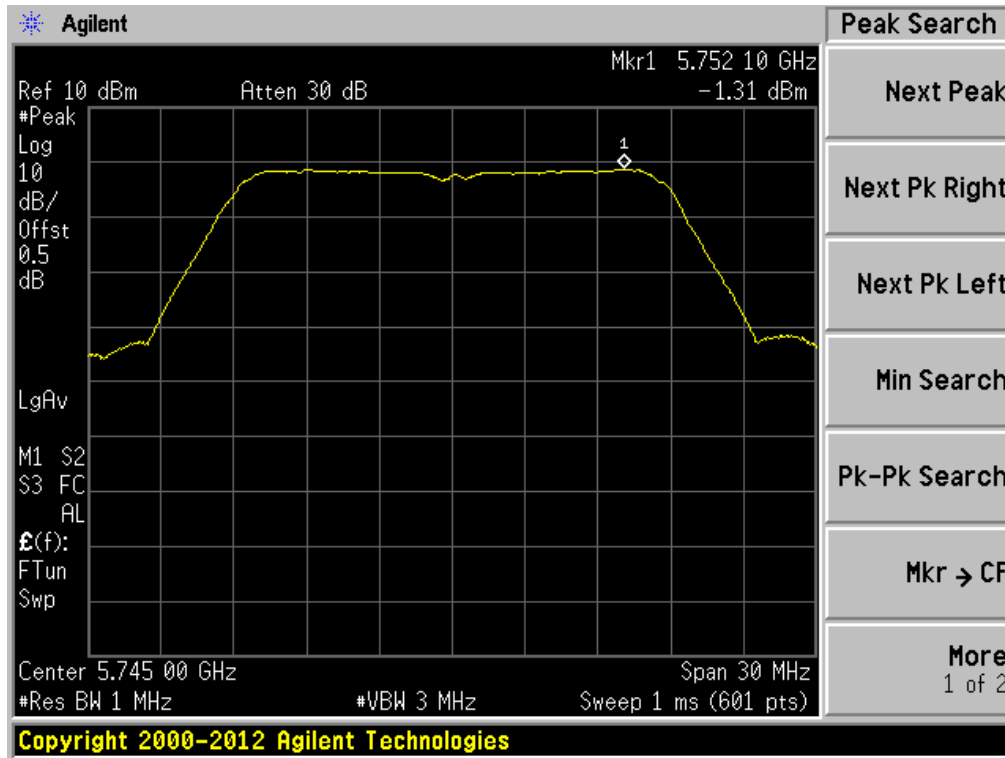

802.11ac(HT20)/middle

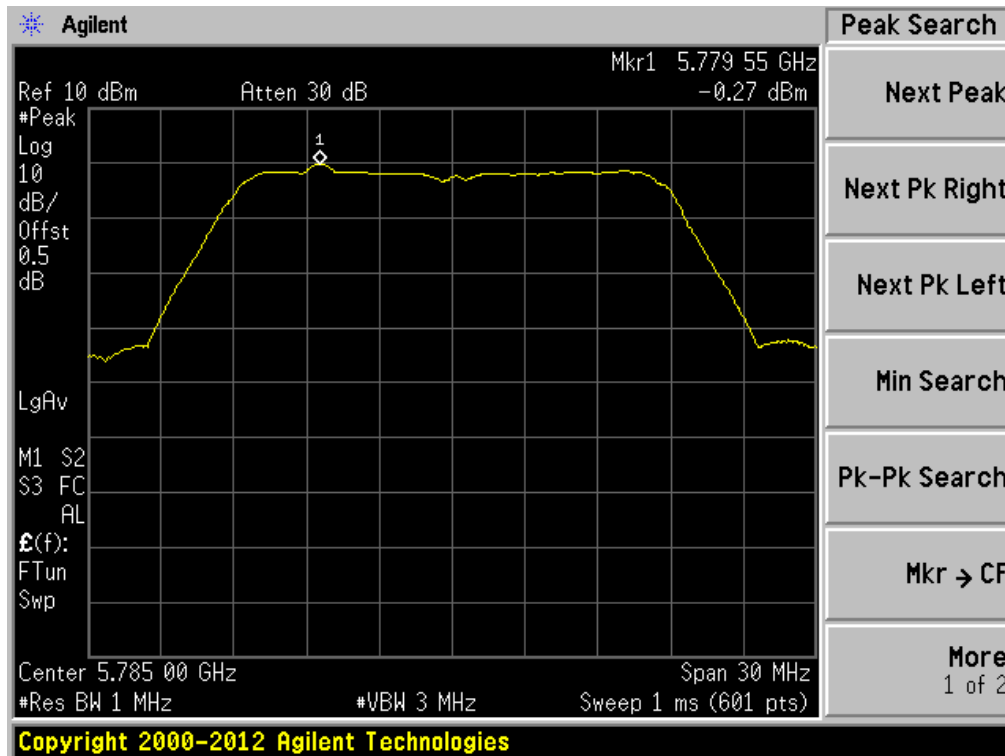

802.11ac(HT20)/highest

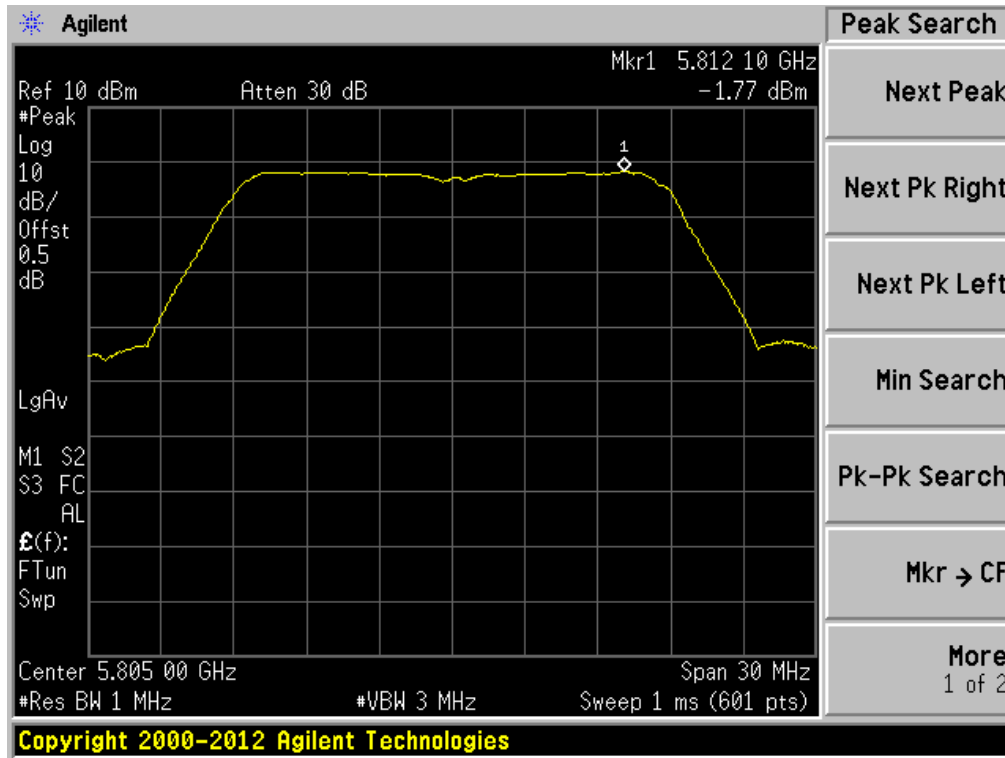

802.11ac(HT40)/lowest

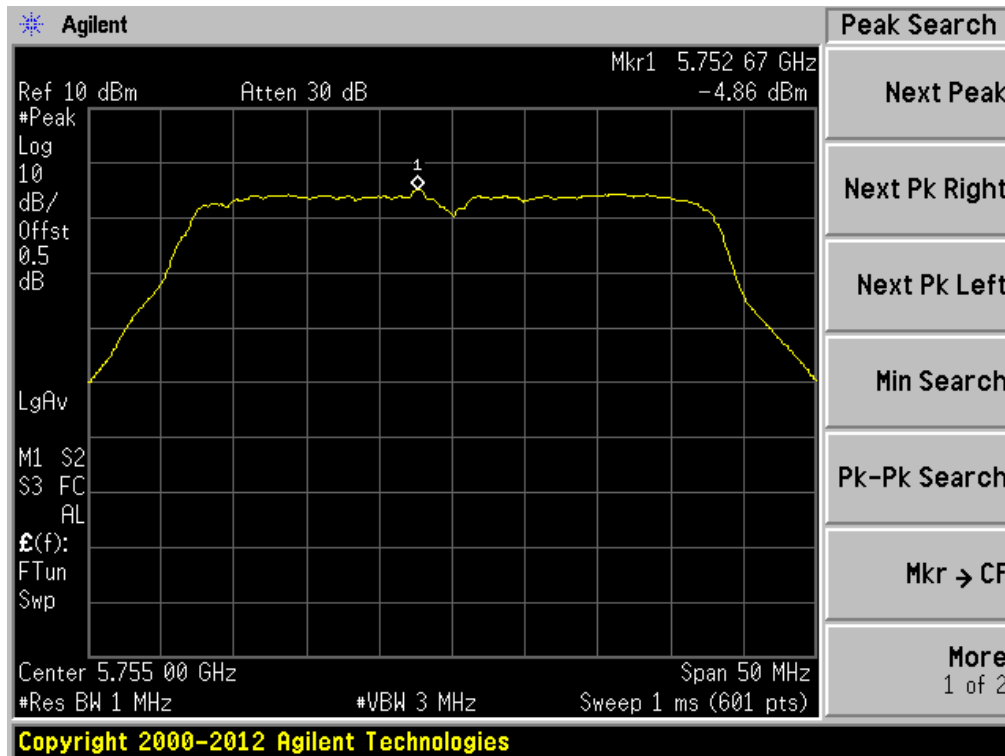

802.11ac(HT40)/highest

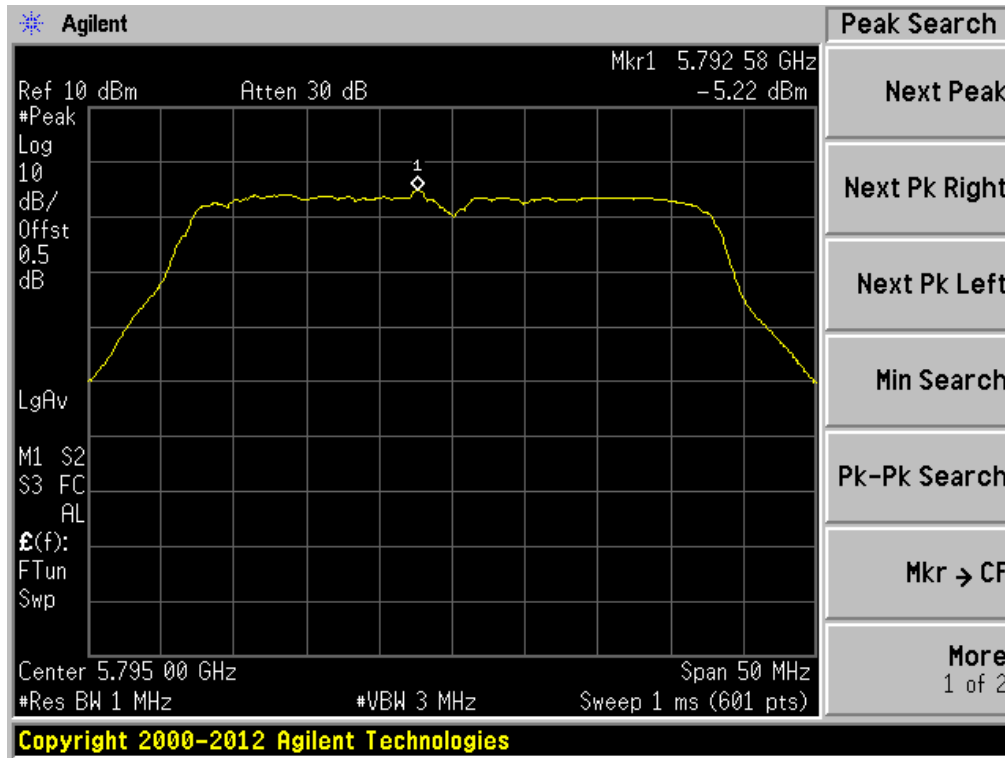

802.11ac(HT80)

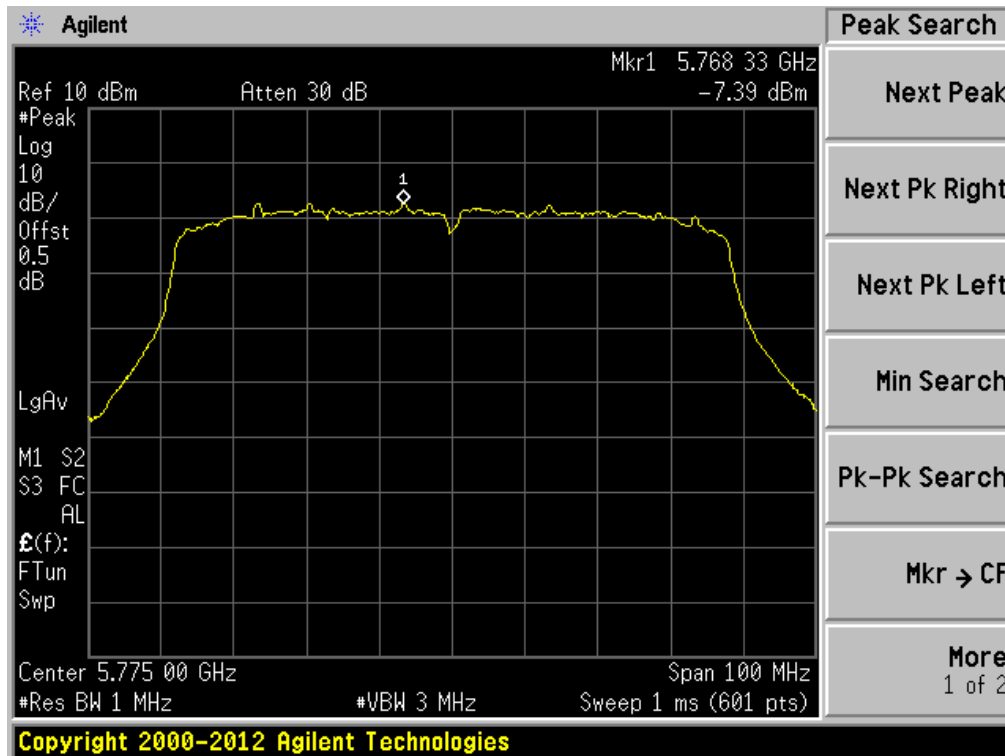

5.7 Band edge

5.7.1 Applied procedures / Limit

15.247(d) In any 100 kHz bandwidth outside the frequency band in which the spread spectrum or digitally modulated intentional radiator is operating. The radio frequency power that is produced by the intentional radiator shall be at least 30 dB below that in the 100 kHz bandwidth within the band that contains the highest level of the desired power. Based on either an RF conducted or a radiated measurement. Provided the transmitter demonstrates compliance with the peak conducted power limits.

5.7.2 Test procedure

- a. The EUT was directly connected to the spectrum analyzer and antenna output port as show in the block diagram below.
- b. Spectrum Setting: RBW=100kHz, VBW \geq RBW, Sweep time=Auto, Detector Function=Peak.

5.7.3 Deviation from standard

No deviation.

5.7.4 Test setup

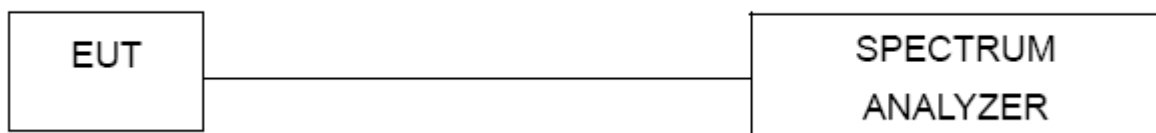

5.7.5 Test results

Result plot as follows:

2.4GHz

802.11b/lowest channel

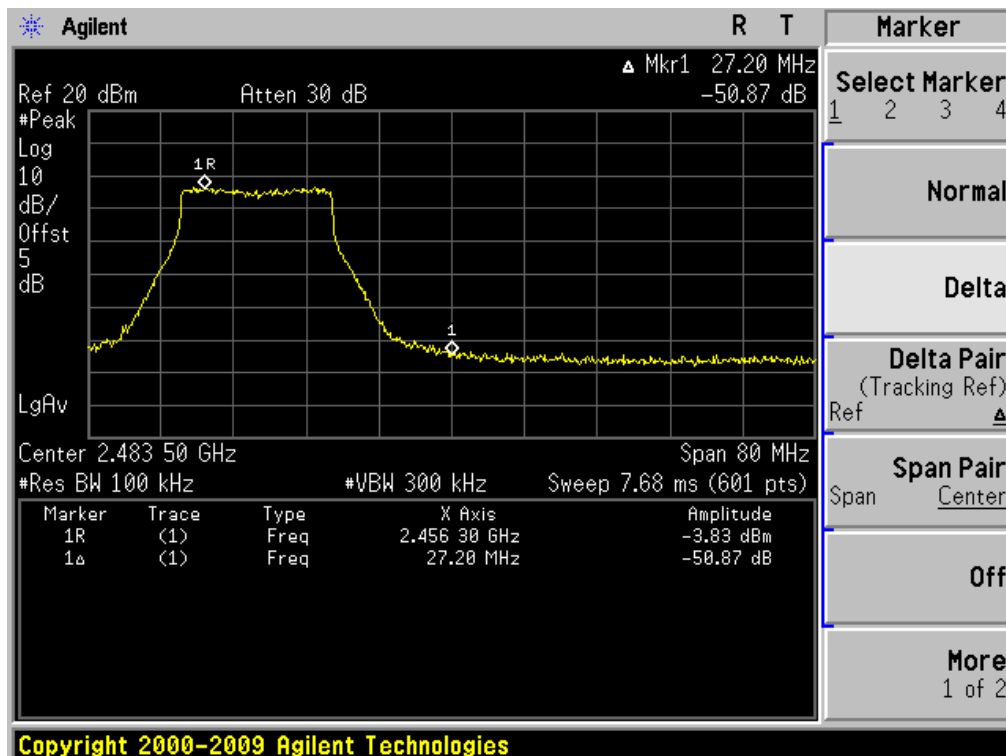
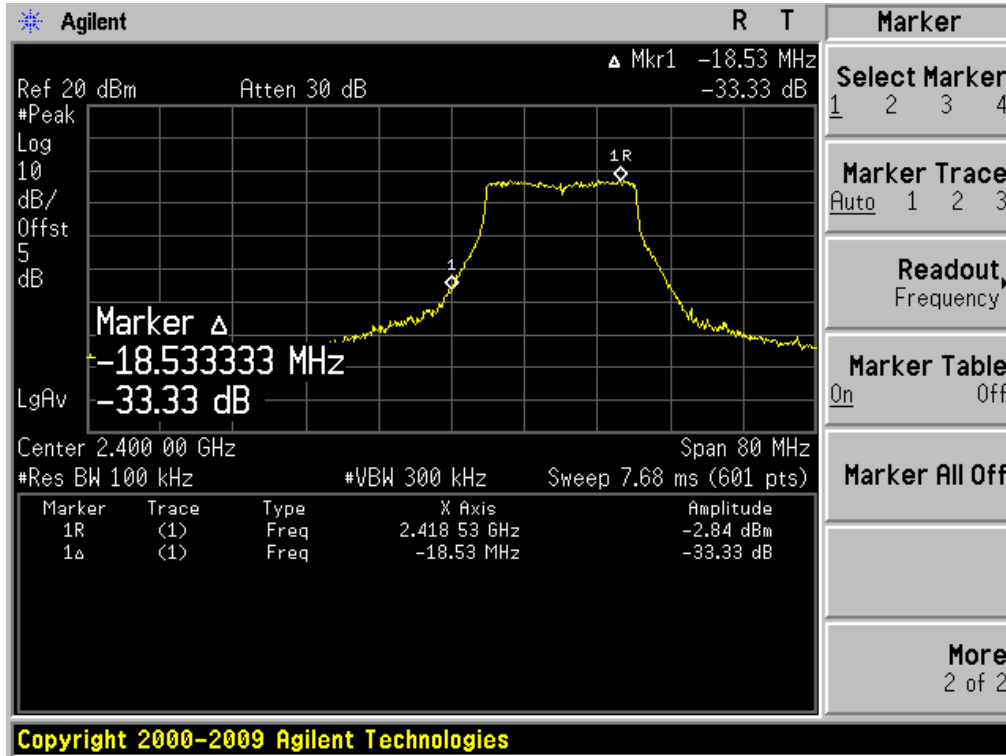

802.11g/lowest channel

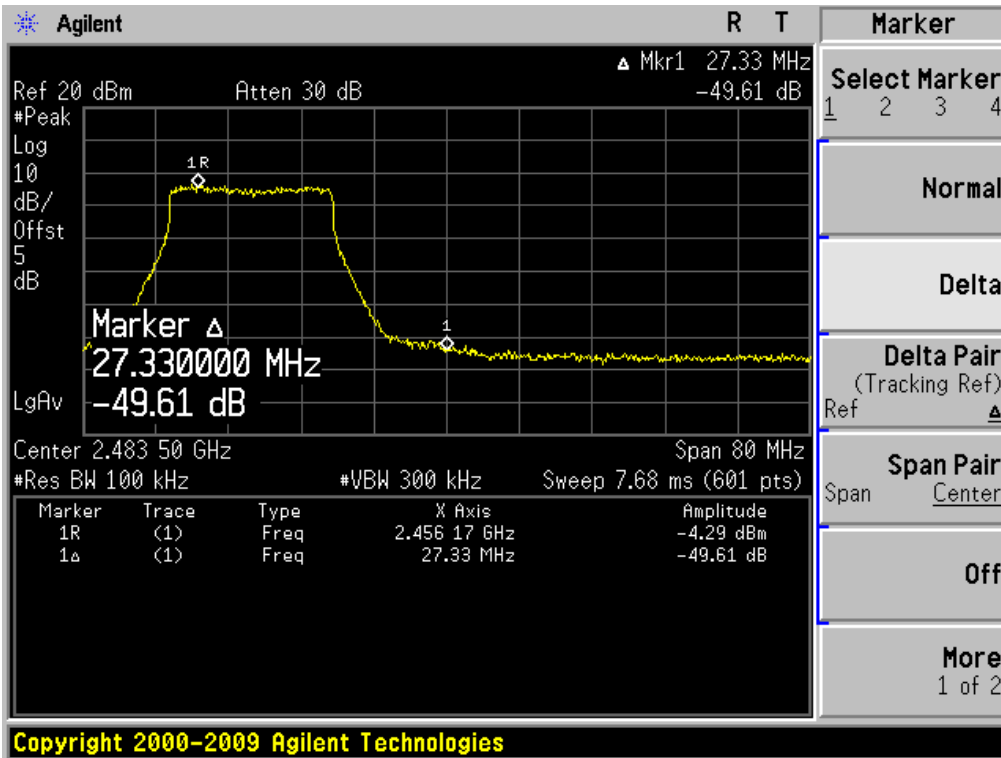
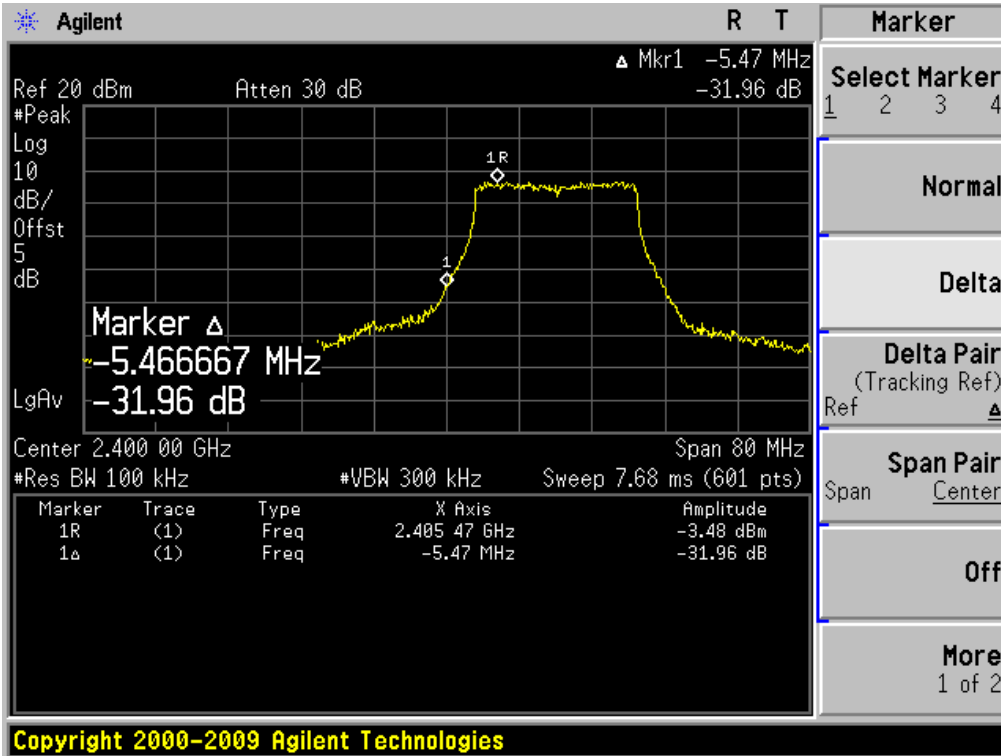

802.11n(HT20)/lowest channel

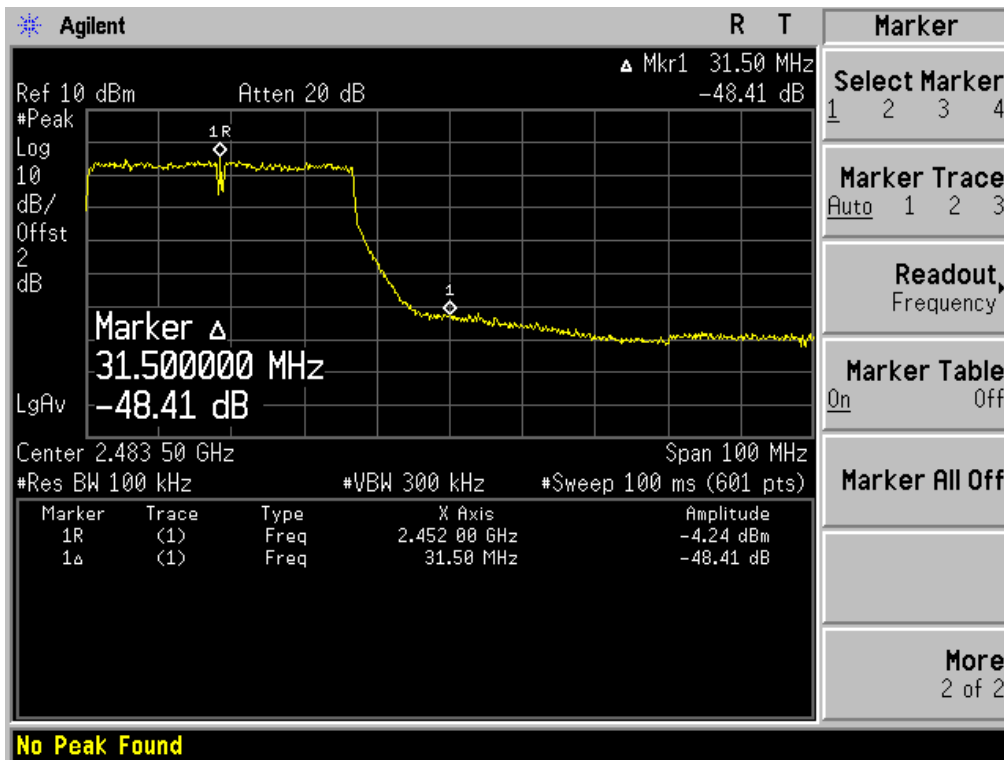
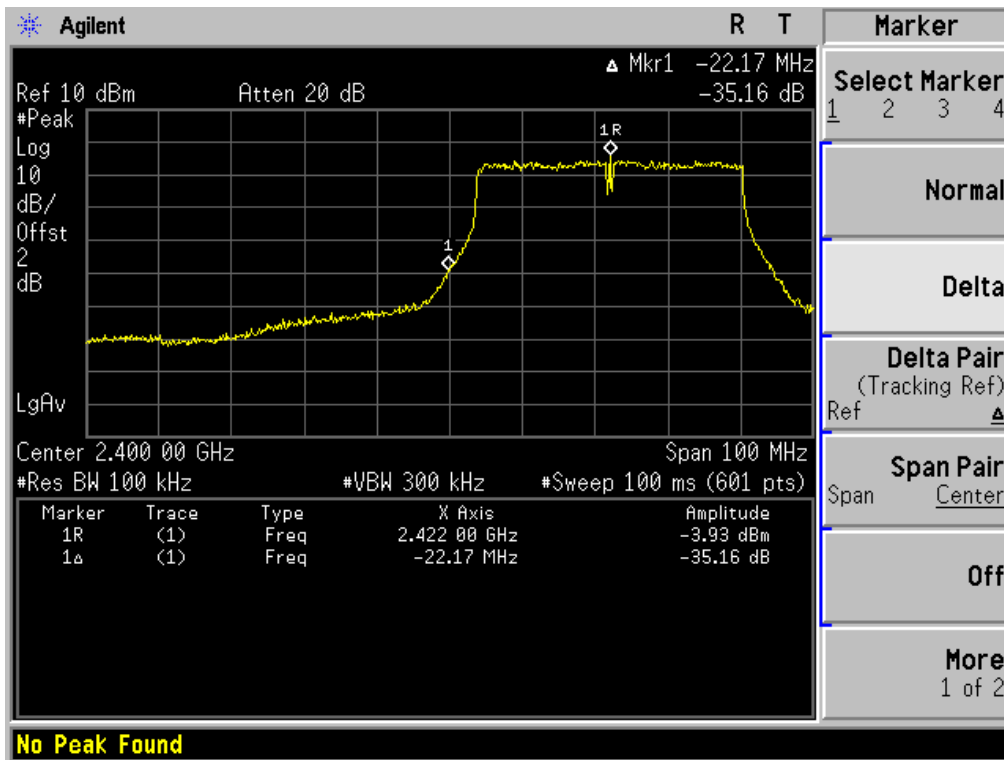

802.11n(HT40)/lowest channel

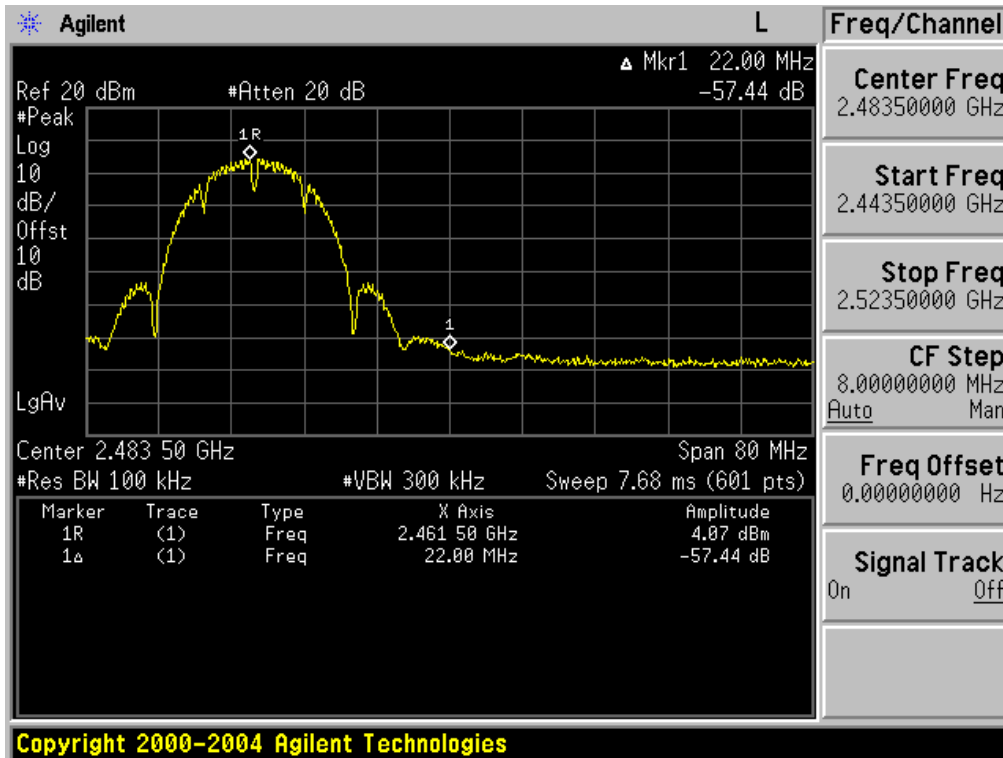
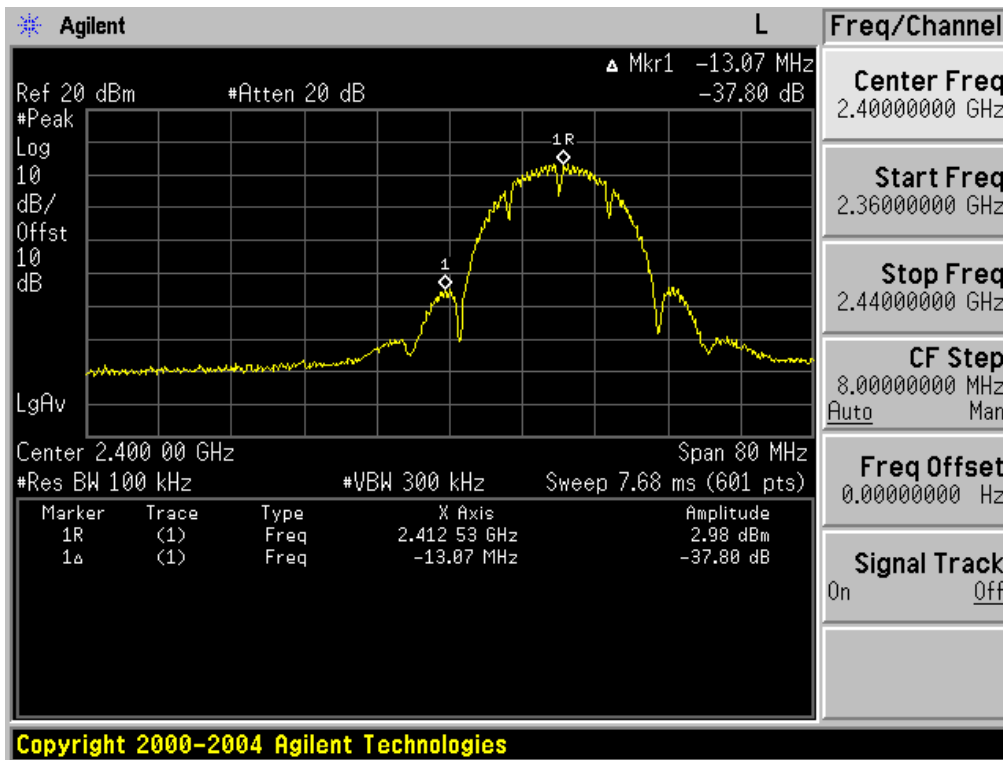

5GHz

802.11a/lowest channel

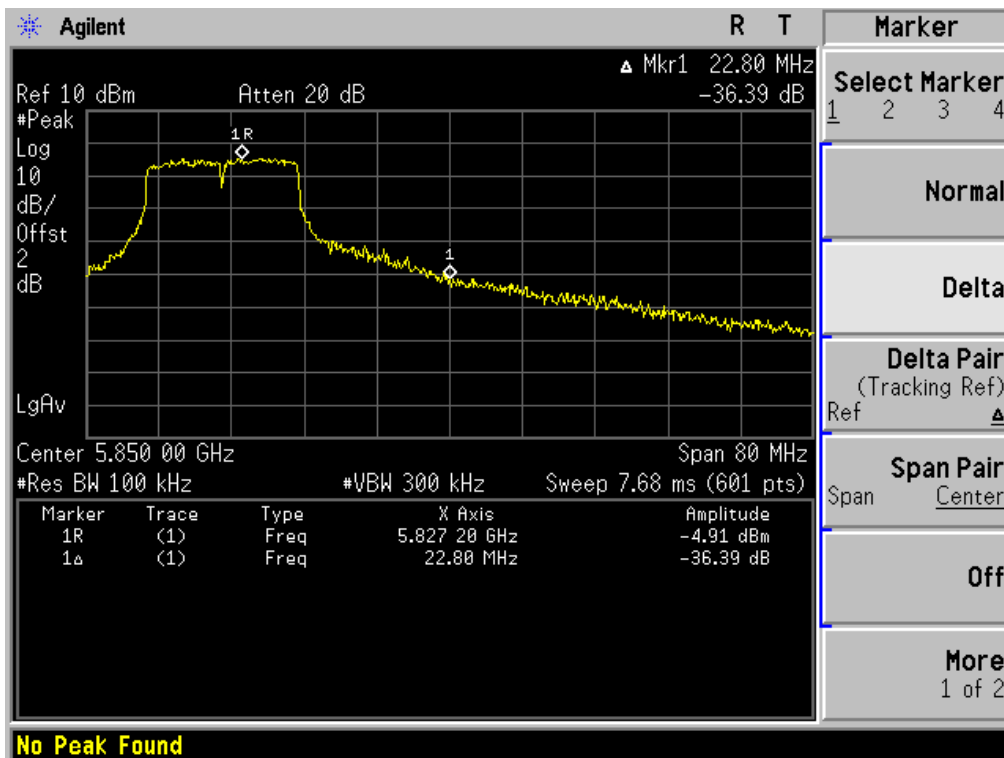
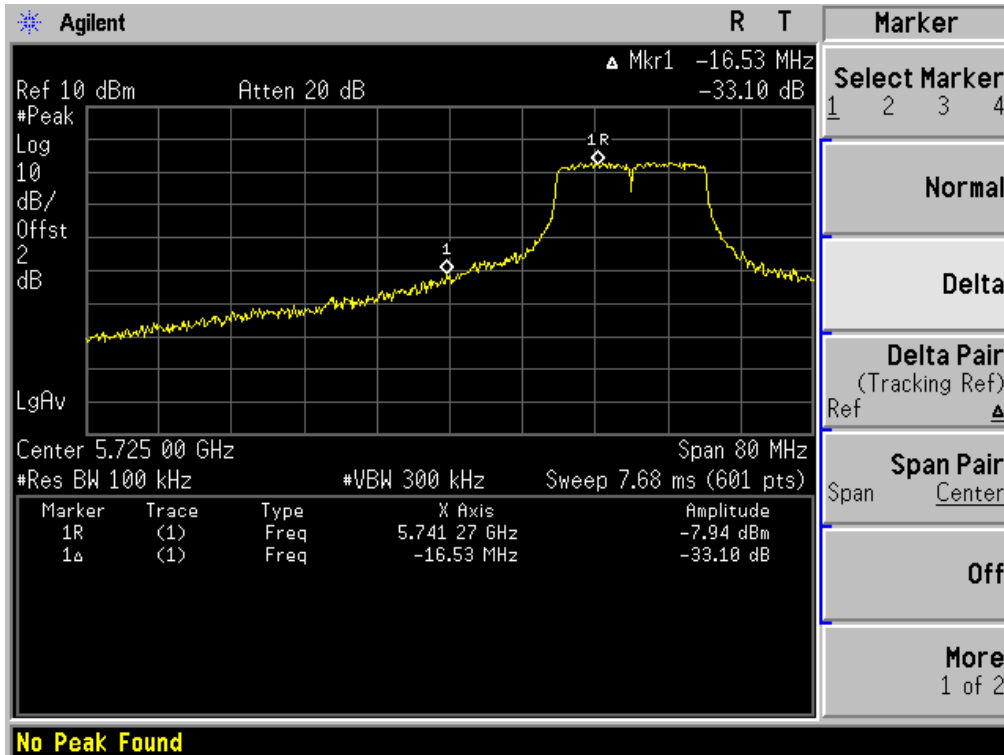

802.11n(HT20)/lowest channel

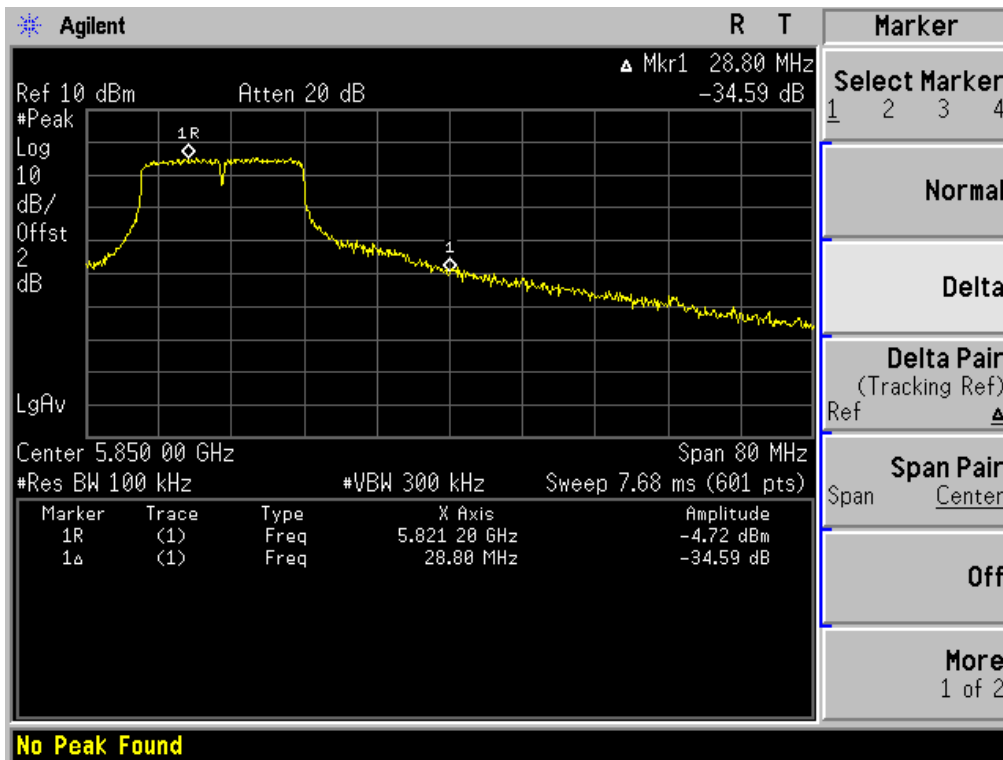
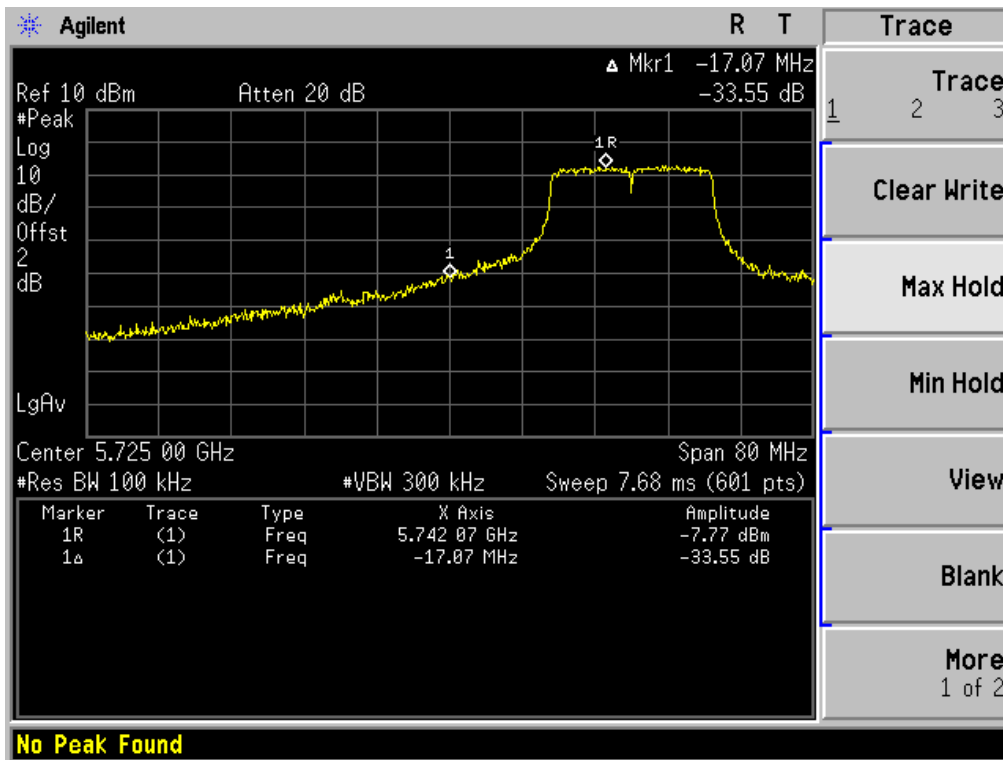

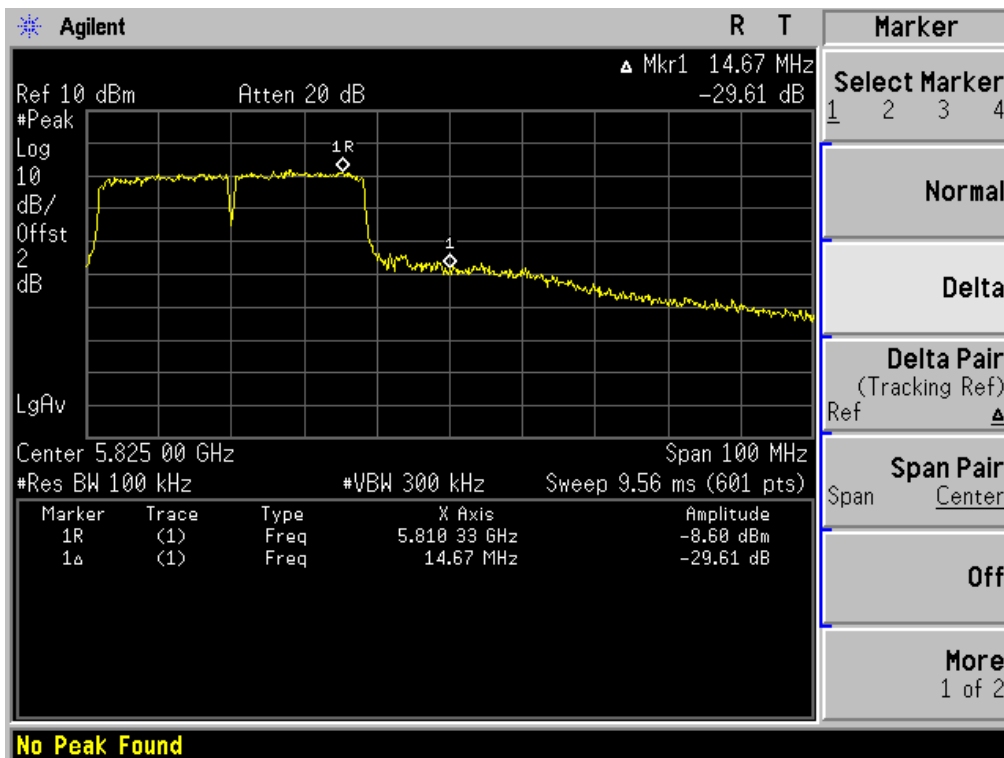
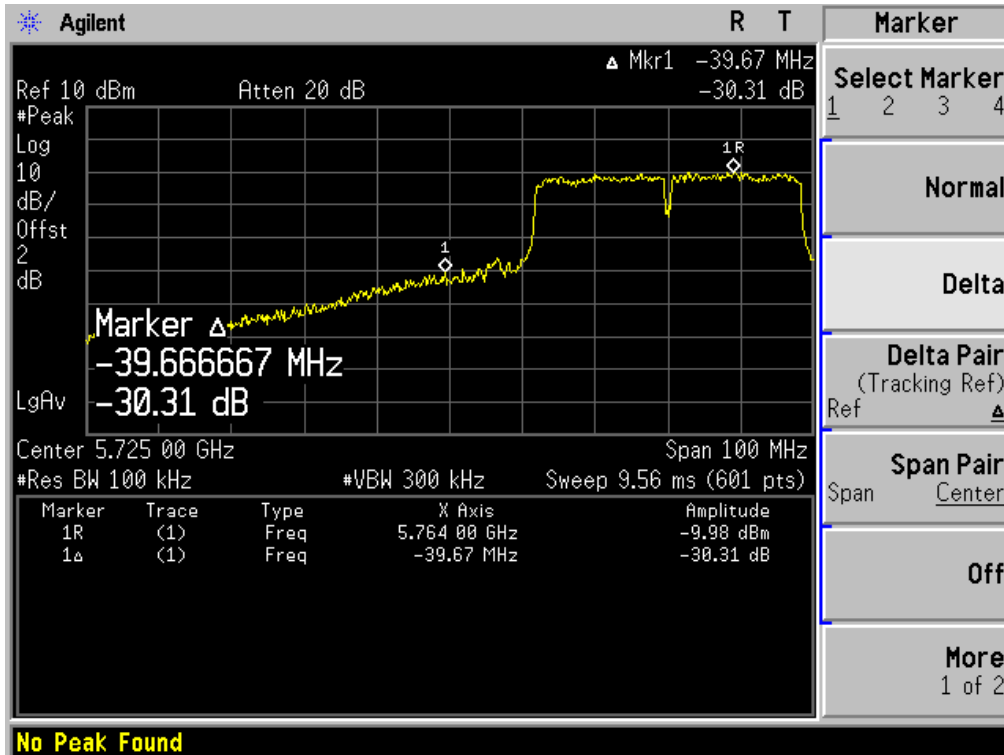
802.11n(HT40)/lowest channel

802.11ac(HT20)/lowest channel

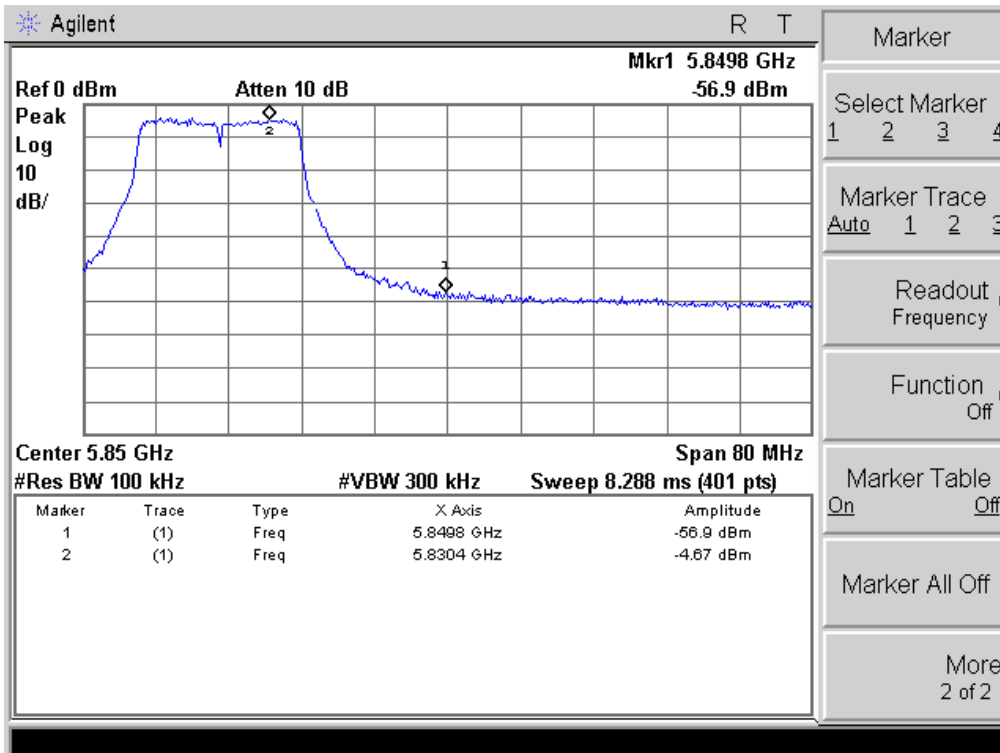
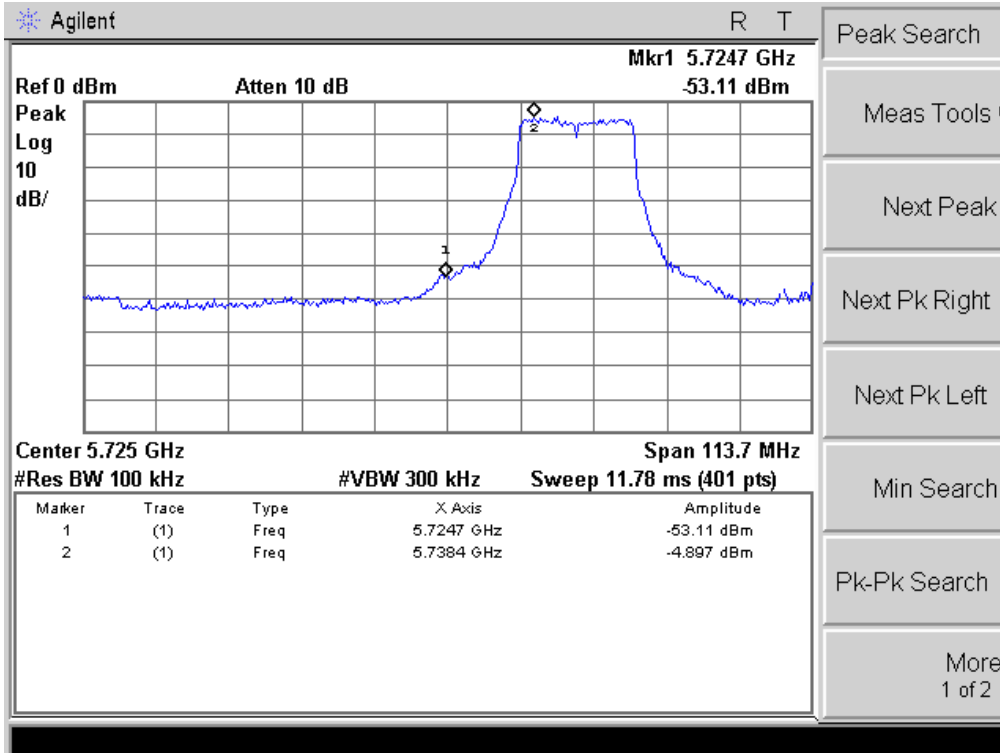

802.11ac(HT40)/Highest channel

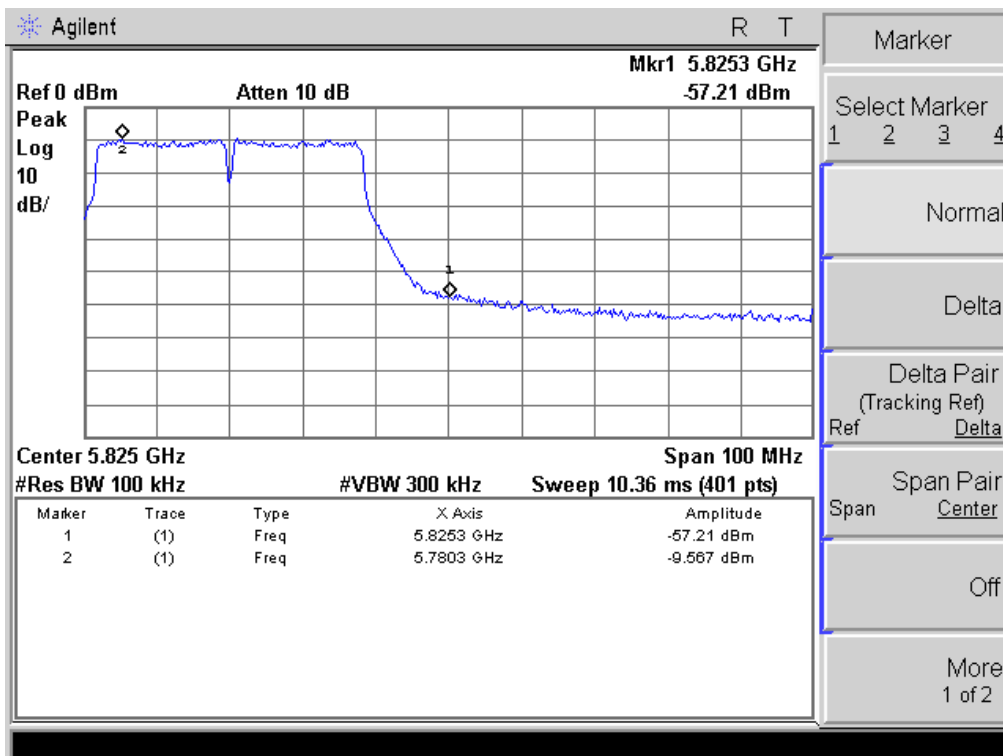
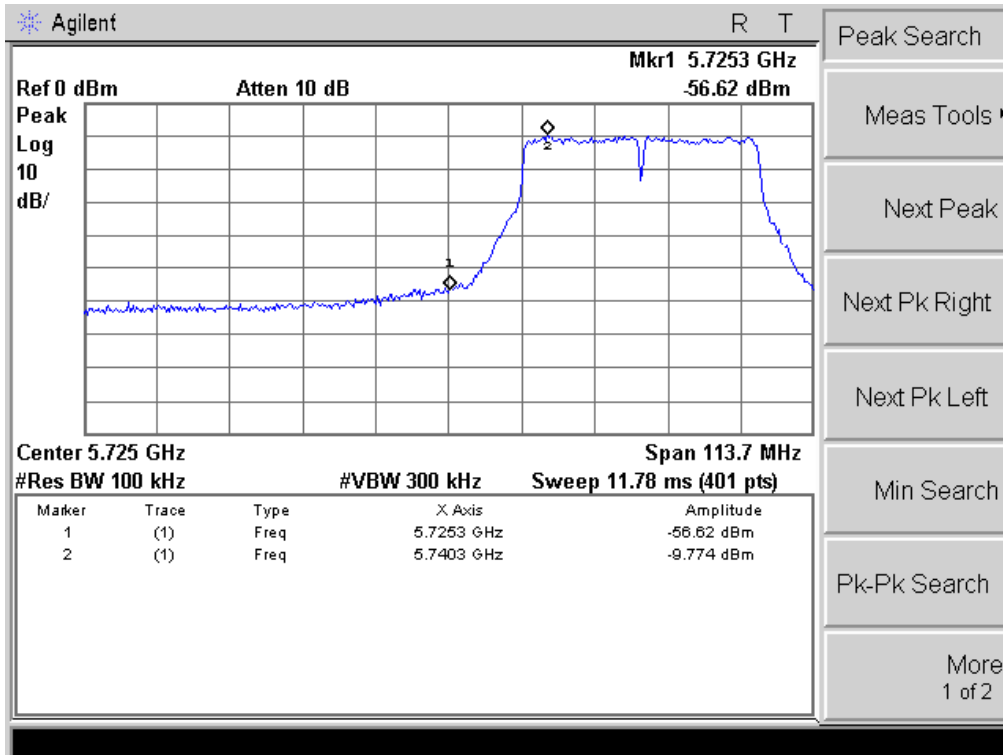

802.11ac(HT80)

