



FCC RADIO TEST REPORT

FCC ID:2AFEJ-H16WT

Product : Graphic Tablet (Pen Tablet)

Trade Name : 
The logo for Huion, consisting of a stylized blue and green crown-like shape above the word 'HUION' in blue capital letters.

Model Name : G10T

Serial Model : Q9K; Q11K; Q13K; S8R; S10R; S12R;
G8T;G12T; G14T; DWH69; WH1409; W58.

Report No. : NTEK- 2016NT08318693F1

Prepared for

Shenzhen Huion Animation Technology Co.,Ltd
Building 28, Quater 4, HuaiDeCuiGang Industrial Park, Fuyong Street,
Bao'anDistrict, Shenzhen, China

Prepared by

Shenzhen NTEK Testing Technology Co., Ltd.
1/F, Building E, Fenda Science Park, Sanwei Community,Xixiang Street
Bao'an District, Shenzhen 518126 P.R. China
Tel.: +86-755-6115 6588 Fax.: +86-755-6115 6599
Website:<http://www.ntek.org.cn>

TEST RESULT CERTIFICATION

Applicant's name : Shenzhen Huion Animation Technology Co.,Ltd
Address : Building 28, Quater 4, HuaiDeCuiGang Industrial Park, Fuyong Street, Bao'anDistrict, Shenzhen, China

Manufacture's Name..... : Shenzhen Huion Animation Technology Co.,Ltd
Address : Building 28, Quater 4, HuaiDeCuiGang Industrial Park, Fuyong Street, Bao'anDistrict, Shenzhen, China

Product description

Product name : Graphic Tablet (Pen Tablet)
Model and/or type reference : G10T
Serial Model : Q9K; Q11K; Q13K; S8R; S10R; S12R; G8T;G12T; G14T; DWH69; WH1409; W58.
Rating(s) : AC 120V/60Hz

Standards : FCC Part15.249 01 Oct. 2015

Test procedure ANSI C63.10-2013

This device described above has been tested by NTEK, and the test results show that the equipment under test (EUT) is in compliance with the FCC requirements. And it is applicable only to the tested sample identified in the report.

This report shall not be reproduced except in full, without the written approval of NTEK, this document may be altered or revised by NTEK, personnel only, and shall be noted in the revision of the document.

Date of Test :
Date (s) of performance of tests : 31 Aug. 2016 ~21 Sep. 2016
Date of Issue..... : 21 Sep. 2016
Test Result..... : **Pass**

Testing Engineer : 

 (Allen Liu)

Technical Manager : 

 (Brown Lu)

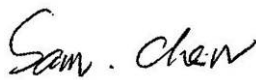
Authorized Signatory : 

 (Sam Chen)

Table of Contents	Page
1 . SUMMARY OF TEST RESULTS	4
1.1 TEST FACILITY	5
1.2 MEASUREMENT UNCERTAINTY	5
2 . GENERAL INFORMATION	6
2.1 GENERAL DESCRIPTION OF EUT	6
2.2 DESCRIPTION OF TEST MODES	8
2.3 BLOCK DIGRAM SHOWING THE CONFIGURATION OF SYSTEM TESTED	9
2.4 DESCRIPTION OF SUPPORT UNITS(CONDUCTED MODE)	10
2.5 EQUIPMENTS LIST FOR ALL TEST ITEMS	11
3 . ANTENNA REQUIREMENT	12
3.1 STANDARD REQUIREMENT	12
3.2 EUT ANTENNA	12
3.3 CONDUCTED EMISSION MEASUREMENT	13
3.3.1 POWER LINE CONDUCTED EMISSION LIMITS	13
3.3.2 TEST PROCEDURE	14
3.3.3 DEVIATION FROM TEST STANDARD	14
3.3.4 TEST SETUP	14
3.2.5 TEST RESULT	15
3.4 RADIATED EMISSION MEASUREMENT	19
3.4.1 RADIATED EMISSION LIMITS	19
3.4.2 TEST PROCEDURE	20
3.4.3 DEVIATION FROM TEST STANDARD	20
3.4.4 TEST SETUP	21
3.4.5 TEST RESULTS (BLOW 30MHZ)	23
3.4.6 TEST RESULTS (BETWEEN 30 – 1000 MHZ)	24
3.4.7 TEST RESULTS (ABOVE 1000 MHZ)	26
3.4.8 TEST RESULTS (RESTRICTED BANDS REQUIREMENTS)	28
4 . BANDWIDTH TEST	35
4.1 TEST PROCEDURE	35
4.2 DEVIATION FROM STANDARD	35
4.3 TEST SETUP	35
4.4 TEST RESULTS	36
5 . EUT TEST PHOTO	38
APPENDIX-PHOTOGRAPHS OF EUT CONSTRUCTIONAL DETAILS	

1. SUMMARY OF TEST RESULTS

Test procedures according to the technical standards:

FCC Part15, Subpart C (15.249)			
Standard Section	Test Item	Judgment	Remark
15.207	Conducted Emission	Pass	
15.203	Antenna Requirement	Pass	
15.249	Radiated Spurious Emission	Pass	
15.249	Fundamental Measurement	Pass	
15.249(d)	Band Edge Emission	pass	
15.249	Occupied Bandwidth	Pass	

1.1 TEST FACILITY

NTEK Testing Technology Co., Ltd

Add. : 1/F, Building E, Fenda Science Park, Sanwei Community, Xixiang Street, Bao'an District, Shenzhen P.R. China.

FCC FRN Registration No.:238937; IC Registration No.:9270A-1

CNAS Registration No.:L5516

1.2 MEASUREMENT UNCERTAINTY

The reported uncertainty of measurement $y \pm U$, where expanded uncertainty U is based on a standard uncertainty multiplied by a coverage factor of $k=2$, providing a level of confidence of approximately 95 %.

No.	Item	Uncertainty
1	Conducted Emission Test	$\pm 1.38\text{dB}$
2	RF power,conducted	$\pm 0.16\text{dB}$
3	Spurious emissions,conducted	$\pm 0.21\text{dB}$
4	All emissions,radiated(<1G)	$\pm 4.68\text{dB}$
5	All emissions,radiated(>1G)	$\pm 4.89\text{dB}$
6	Temperature	$\pm 0.5^{\circ}\text{C}$
7	Humidity	$\pm 2\%$

2. GENERAL INFORMATION

2.1 GENERAL DESCRIPTION OF EUT

Equipment	Graphic Tablet (Pen Tablet)	
Trade Name		
Model Name	G10T	
Serial Model	Q9K、Q11K、Q13K、S8R、S10R、S12R、G8T、G12T、G14T、DWH69、WH1409、W58	
Model Difference	All the model are the same circuit and RF module, except the model No. and colour.	
Product Description	The EUT is a Graphic Tablet (Pen Tablet)	
	Operation Frequency:	2402-2480MHz
	Modulation Type:	GFSK
	Antenna Designation:	FPCB Antenna
	Antenna Gain(Peak)	-3.12 dBi
Based on the application, features, or specification exhibited in User's Manual, the EUT is considered as an ITE/Computing Device. More details of EUT technical specification, please refer to the User's Manual.		
Channel List	Please refer to the Note 2.	
Adapter	N/A	
Battery	DC 3.7V 2500mAh	

Note:

1. For a more detailed features description, please refer to the manufacturer's specifications or the User's Manual.

2.

Channel	Frequency (MHz)
00	2402
01	2404.
.	.
.	.
19	2440
20	2442
.	.
.	.
39	2480

3.

Table for Filed Antenna

Ant	Brand	Model Name	Antenna Type	Connector	Gain (dBi)	NOTE
.						
1	N/A	N/A	FPCB Antenna	N/A	-3.12	Antenna

2.2 DESCRIPTION OF TEST MODES

To investigate the maximum EMI emission characteristics generates from EUT, the test system was pre-scanning tested base on the consideration of following EUT operation mode or test configuration mode which possible have effect on EMI emission level. Each of these EUT operation mode(s) or test configuration mode(s) mentioned above was evaluated respectively.

Pretest Mode	Description
Mode 1	CH 01/19/39
Mode 2	Link Mode

Note:

- (1) The measurements are performed at the highest, middle, lowest available channels.
- (2) EUT built-in battery-powered, fully-charged battery use of the test battery

2.3 BLOCK DIGRAM SHOWING THE CONFIGURATION OF SYSTEM TESTED

Conducted Emission Test

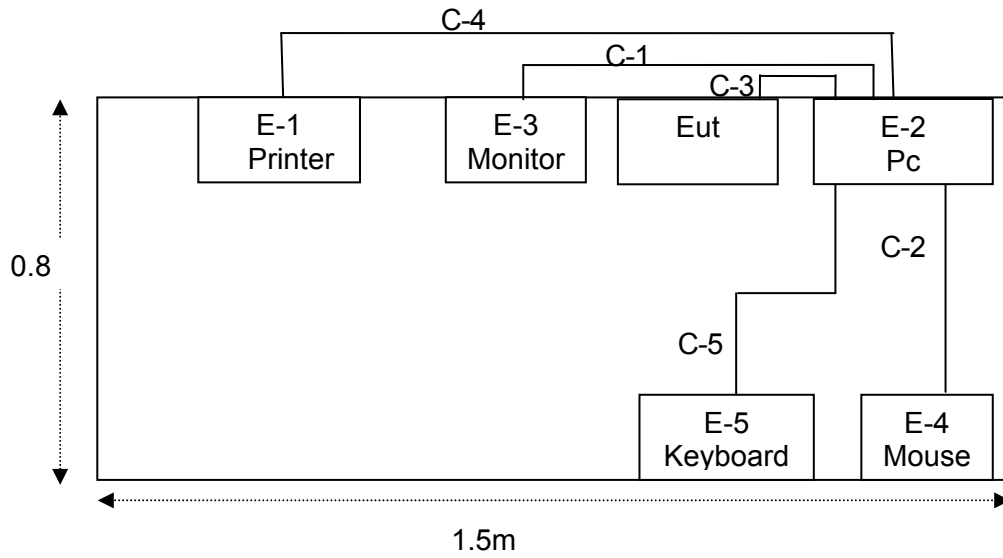

Radiated Spurious Emission Test

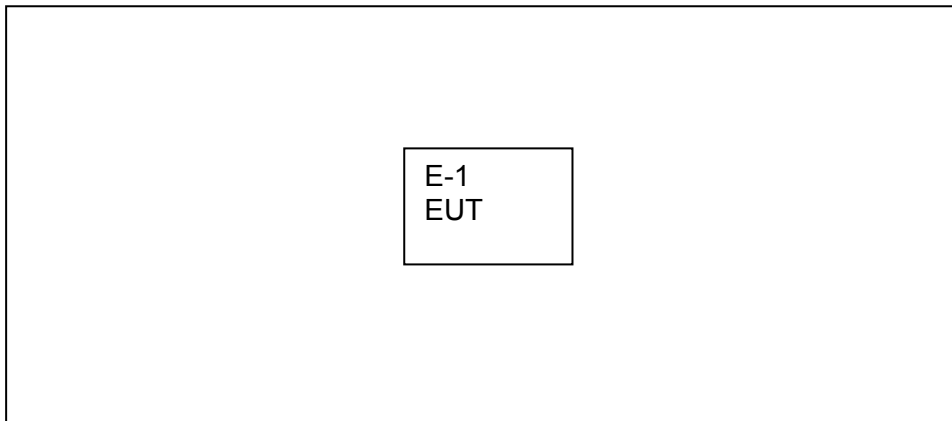

2.4 DESCRIPTION OF SUPPORT UNITS(CONDUCTED MODE)

The EUT has been tested as an independent unit together with other necessary accessories or support units. The following support units or accessories were used to form a representative test configuration during the tests.

Item	Equipment	Mfr/Brand	Model/Type No.	Series No.	Note
E-1	Printer	Canon	L11121E	LBP2900	
E-2	Personal computer	DELL	FT4Y23X	34413561645	PC
E-3	Monitor	DELL	IN2020MB	cn-0y6mhx-74261-11f-67es	
E-4	Mouse	DELL	MS111-P	cn-011d3v-71581-11e-1th7	
E-5	KEYBOARD	DELL	N/A	N/A	

Item	Shielded Type	Ferrite Core	Length	Note
C-1	USB Cable	NO	NO	1.0m
C-2	USB Cable	NO	NO	1.5m
C-3	USB Cable	NO	NO	1.5m
C-4	RS232	YES	NO	1.0m
C-5	USB Cable	NO	NO	1.5m

Note:

- (1) The support equipment was authorized by Declaration of Confirmation.
- (2) For detachable type I/O cable should be specified the length in cm in 『Length』 column.

2.5 EQUIPMENTS LIST FOR ALL TEST ITEMS**Radiation Test equipment**

Item	Kind of Equipment	Manufacturer	Type No.	Serial No.	Calibrated until
1	Spectrum Analyzer	Agilent	E4407B	160400005	Jul. 06. 2017
2	Test Receiver	R&S	ESPI	101318	Jul. 06. 2017
3	Bilog Antenna	TESEQ	CBL6111D	31216	Jul. 06. 2017
4	50Ω Coaxial Switch	Anritsu	MP59B	6200264416	Jul. 06. 2017
5	Spectrum Analyzer	ADVANTEST	R3132	150900201	Jul. 06. 2017
6	Horn Antenna	EM	EM-AH-10180	2011071402	Jul. 06. 2017
7	Horn Ant	Schwarzbeck	BBHA 9170	9170-181	Jul. 06. 2017
8	Amplifier	EM	EM-30180	060538	Jul. 06. 2017
9	Loop Antenna	ARA	PLA-1030/B	1029	Jul. 06. 2017
10	Power Meter	R&S	NRVS	100696	Jul. 06. 2017

Conduction Test equipment

Item	Kind of Equipment	Manufacturer	Type No.	Serial No.	Calibrated until
1	Test Receiver	R&S	ESCI	101160	Jul. 06. 2017
2	LISN	R&S	ENV216	101313	Jul. 06. 2017
3	LISN	EMCO	3816/2	00042990	Jul. 06. 2017
4	50Ω Coaxial Switch	Anritsu	MP59B	6200264417	Jul. 06. 2017
5	Passive Voltage Probe	R&S	ESH2-Z3	100196	Jul. 06. 2017
6	Absorbing clamp	R&S	MOS-21	100423	Jul. 06. 2017

3. ANTENNA REQUIREMENT

3.1 STANDARD REQUIREMENT

15.203 requirement: For intentional device, according to 15.203: an intentional radiator shall be designed to ensure that no antenna other than that furnished by the responsible party shall be used with the device.

3.2 EUT ANTENNA

The EUT antenna is permanent attached antenna. It comply with the standard requirement.

3.3 CONDUCTED EMISSION MEASUREMENT

3.3.1 POWER LINE CONDUCTED EMISSION Limits (Frequency Range 150KHz-30MHz)

FREQUENCY (MHz)	Class A (dBuV)		Class B (dBuV)		Standard
	Quasi-peak	Average	Quasi-peak	Average	
0.15 -0.5			66 - 56 *	56 - 46 *	CISPR
0.50 -5.0			56.00	46.00	CISPR
5.0 -30.0			60.00	50.00	CISPR

0.15 -0.5			66 - 56 *	56 - 46 *	FCC
0.50 -5.0			56.00	46.00	FCC
5.0 -30.0			60.00	50.00	FCC

Note:

- (1) The tighter limit applies at the band edges.
- (2) The limit of " * " marked band means the limitation decreases linearly with the logarithm of the frequency in the range.

TEST CONFIGURATION

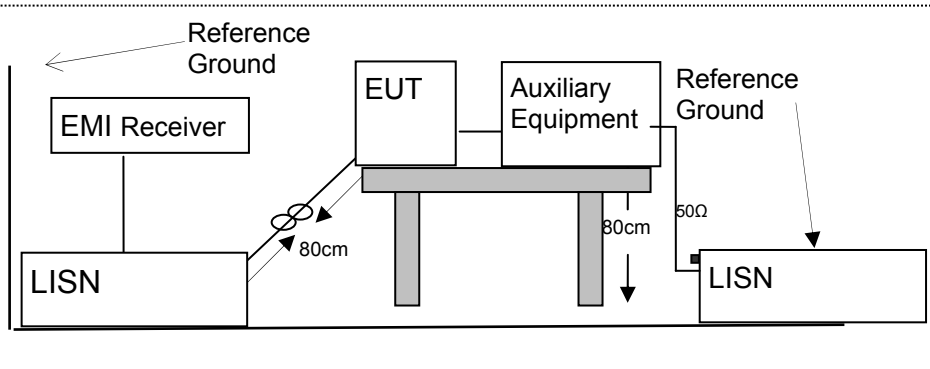

The following table is the setting of the receiver

Receiver Parameters	Setting
Attenuation	10 dB
Start Frequency	0.15 MHz
Stop Frequency	30 MHz
IF Bandwidth	9 kHz

3.3.2 TEST PROCEDURE

- a. The EUT was placed 0.4 meters from the horizontal ground plane with EUT being connected to the power mains through a line impedance stabilization network (LISN). All other support equipments powered from additional LISN(s). The LISN provide 50 Ohm/ 50uH of coupling impedance for the measuring instrument.
- b. Interconnecting cables that hang closer than 40 cm to the ground plane shall be folded back and forth in the center forming a bundle 30 to 40 cm long.
- c. I/O cables that are not connected to a peripheral shall be bundled in the center. The end of the cable may be terminated, if required, using the correct terminating impedance. The overall length shall not exceed 1 m.
- d. LISN at least 80 cm from nearest part of EUT chassis.
- e. For the actual test configuration, please refer to the related Item –EUT Test Photos.

3.3.3 DEVIATION FROM TEST STANDARD

No deviation

3.3.4 TEST SETUP

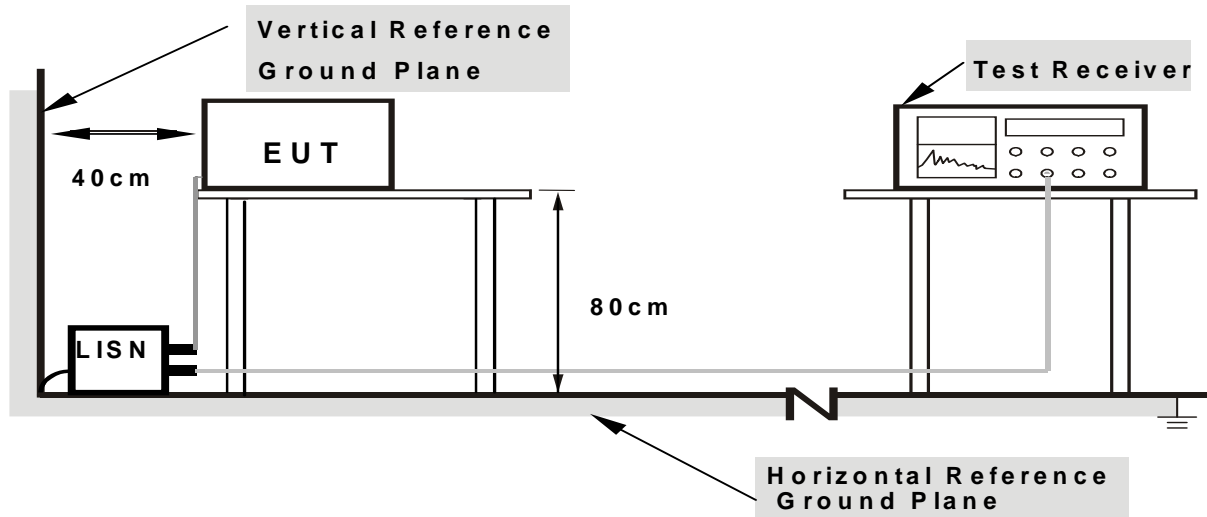

Note: 1. Support units were connected to second LISN.

2. Both of LISNs (AMN) are 80 cm from EUT and at least 80 cm from other units and other metal planes

3.2.5 TEST RESULT

EUT :	Graphic Tablet (Pen Tablet)	Model Name. :	G10T
Temperature :	26 °C	Relative Humidity :	54%
Pressure :	1010hPa	Phase :	L
Test Voltage :	AC 120V/60Hz	Test Mode :	Mode 2

Frequency (MHz)	Reading Level (dBμV)	Correct Factor (dB)	Measure-ment (dBμV)	Limits (dBμV)	Margin (dB)	Remark
0.15	39.54	10.12	49.66	65.99	-16.33	QP
0.15	19.97	10.12	30.09	55.99	-25.90	AVG
0.202	33.39	10.13	43.52	63.52	-20.00	QP
0.202	28.82	10.13	38.95	53.52	-14.57	AVG
0.802	25.28	9.81	35.09	56.00	-20.91	QP
0.802	13.21	9.81	23.02	46.00	-22.98	AVG
1.1019	25.71	9.86	35.57	56.00	-20.43	QP
1.1019	23.41	9.86	33.27	46.00	-12.73	AVG
19.0419	35.50	10.07	45.57	60.00	-14.43	QP
19.0419	15.07	10.07	25.14	50.00	-24.86	AVG
25.154	34.97	10.15	45.12	60.00	-14.88	QP
25.154	13.63	10.15	23.78	50.00	-26.22	AVG

Remark:

1. All readings are Quasi-Peak and Average values.
2. Factor = Insertion Loss + Cable Loss.

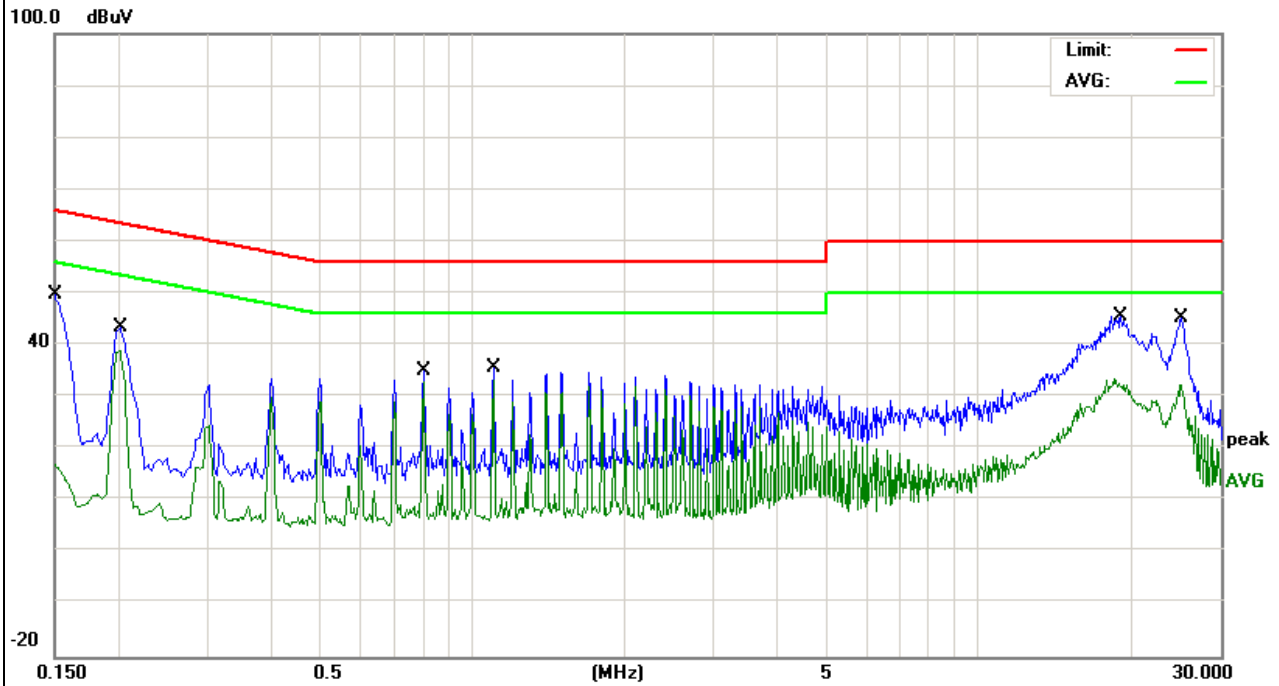

EUT :	Graphic Tablet (Pen Tablet)	Model Name. :	G10T
Temperature :	26 °C	Relative Humidity :	54%
Pressure :	1010hPa	Phase :	N
Test Voltage :	AC 120V/60Hz	Test Mode :	Mode 2

Frequency (MHz)	Reading Level (dBμV)	Correct Factor (dB)	Measure-ment (dBμV)	Limits (dBμV)	Margin (dB)	Remark
0.15	39.89	10.08	49.97	65.99	-16.02	QP
0.15	21.83	10.08	31.91	55.99	-24.08	AVG
0.202	31.69	10.02	41.71	63.52	-21.81	QP
0.202	16.33	10.02	26.35	53.52	-27.17	AVG
0.502	26.01	9.83	35.84	56.00	-20.16	QP
0.502	15.29	9.83	25.12	46.00	-20.88	AVG
0.802	26.36	9.84	36.20	56.00	-19.80	QP
0.802	10.30	9.84	20.14	46.00	-25.86	AVG
16.5339	37.12	9.96	47.08	60.00	-12.92	QP
16.5339	12.36	9.96	22.32	50.00	-27.68	AVG
25.0419	33.25	10.14	43.39	60.00	-16.61	QP
25.0419	11.33	10.14	21.47	50.00	-28.53	AVG

Remark:

1. All readings are Quasi-Peak and Average values.
2. Factor = Insertion Loss + Cable Loss.

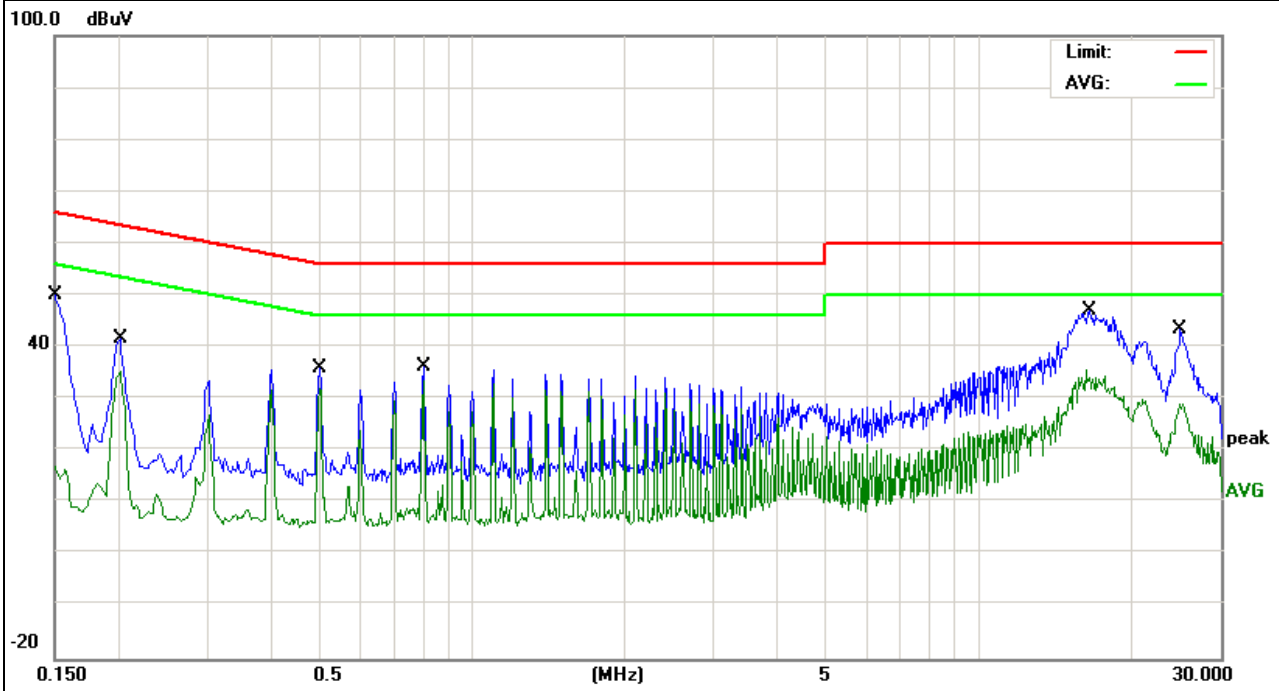

EUT :	Graphic Tablet (Pen Tablet)	Model Name. :	G10T
Temperature :	26 °C	Relative Humidity :	54%
Pressure :	1010hPa	Phase :	L
Test Voltage :	AC 240V/60Hz	Test Mode :	Mode 2

Frequency (MHz)	Reading Level (dBμV)	Correct Factor (dB)	Measure-ment (dBμV)	Limits (dBμV)	Margin (dB)	Remark
0.202	34.39	10.13	44.52	63.52	-19.00	QP
0.202	29.91	10.13	40.04	53.52	-13.48	AVG
0.502	27.47	9.81	37.28	56.00	-18.72	QP
0.502	20.31	9.81	30.12	46.00	-15.88	AVG
0.802	26.41	9.81	36.22	56.00	-19.78	QP
0.802	19.74	9.81	29.55	46.00	-16.45	AVG
1.106	25.07	9.86	34.93	56.00	-21.07	QP
1.106	21.63	9.86	31.49	46.00	-14.51	AVG
18.3779	35.18	10.05	45.23	60.00	-14.77	QP
18.3779	23.97	10.05	34.02	50.00	-15.98	AVG
25.206	34.84	10.15	44.99	60.00	-15.01	QP
25.206	15.54	10.15	25.69	50.00	-24.31	AVG

Remark:

1. All readings are Quasi-Peak and Average values.
2. Factor = Insertion Loss + Cable Loss.

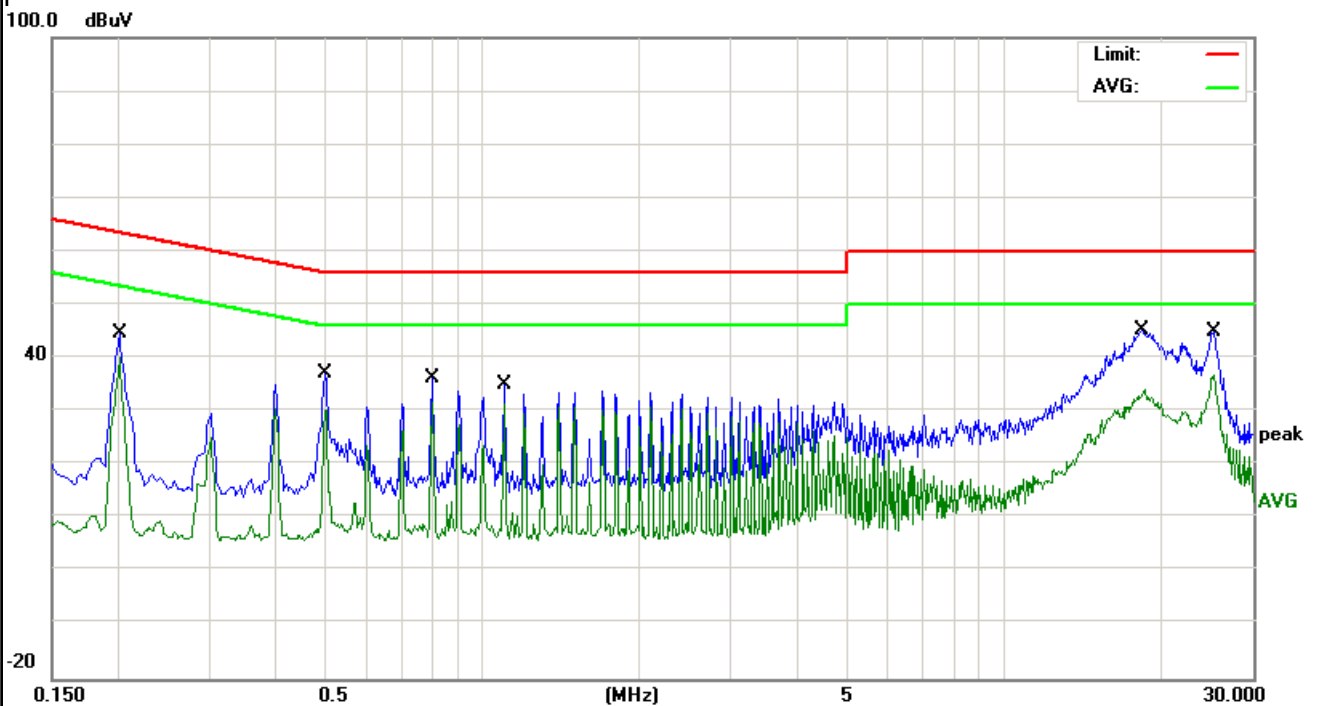

EUT :	Graphic Tablet (Pen Tablet)	Model Name. :	G10T
Temperature :	26 °C	Relative Humidity :	54%
Pressure :	1010hPa	Phase :	N
Test Voltage :	AC 240V/60Hz	Test Mode :	Mode 2

Frequency (MHz)	Reading Level (dBμV)	Correct Factor (dB)	Measure-ment (dBμV)	Limits (dBμV)	Margin (dB)	Remark
0.202	31.56	10.02	41.58	63.52	-21.94	QP
0.202	23.53	10.02	33.55	53.52	-19.97	AVG
0.402	26.4	10.06	36.46	57.81	-21.35	QP
0.402	16.41	10.06	26.47	47.81	-21.34	AVG
0.502	28.45	9.83	38.28	56.00	-17.72	QP
0.502	18.53	9.83	28.36	46.00	-17.64	AVG
0.8059	25.53	9.84	35.37	56.00	-20.63	QP
0.8059	19.6	9.84	29.44	46.00	-16.56	AVG
1.106	24.91	9.88	34.79	56.00	-21.21	QP
1.106	16.66	9.88	26.54	46.00	-19.46	AVG
18.898	36.11	10.03	46.14	60.00	-13.86	QP
18.898	24.59	10.03	34.62	50.00	-15.38	AVG

Remark:

1. All readings are Quasi-Peak and Average values.
2. Factor = Insertion Loss + Cable Loss.

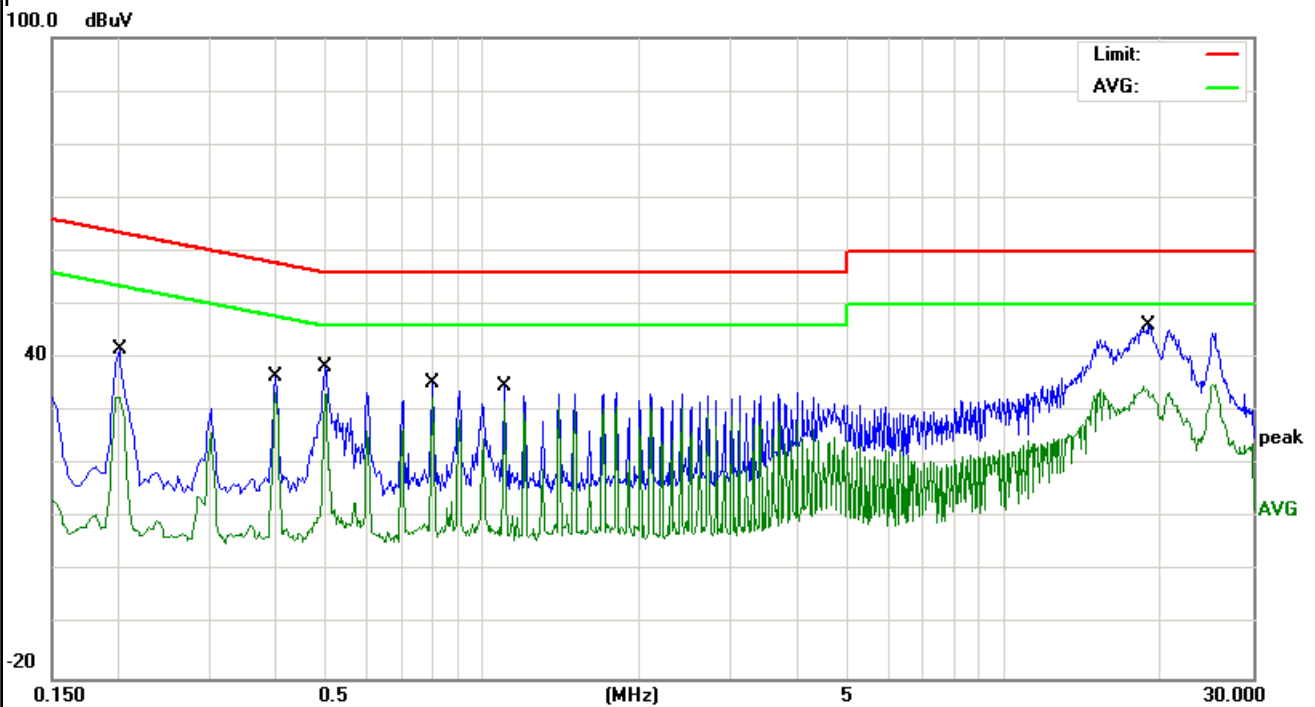

3.4 RADIATED EMISSION MEASUREMENT

3.4.1 Radiated Emission Limits (FCC 15.209)

Frequencies (MHz)	Field Strength (micorvolts/meter)	Measurement Distance (meters)
0.009~0.490	2400/F(KHz)	300
0.490~1.705	24000/F(KHz)	30
1.705~30.0	30	30
Frequency (MHz)	Limit (dBuV)	
30~88	40	3
88~216	43.5	3
216~960	46	3
960 -10000	54.00	3
*902 - 928	94.00	3

Note:

- (1) The tighter limit applies at the band edges.
- (2) Emission level (dBuV/m)=20log Emission level (uV/m).
- (3) *Note: This is the limit for the fundamental frequency.

LIMITS OF RADIATED EMISSION MEASUREMENT (FCC 15.249)

Frequency of Emission (MHz)	Field Strength of fundamental ((millivolts /meter)	Field Strength of Harmonics (microvolts/meter)
2400-2483.5	50	500

Notes:

- (1) Emissions radiated outside of the specified frequency bands, except for harmonics, shall be attenuated by at least 50 dB below the level of the fundamental or to the general radiated emission limits in Section 15.209, whichever is the lesser attenuation.

Spectrum Parameter	Setting
Attenuation	Auto
Start Frequency	1000 MHz
Stop Frequency	10th carrier harmonic
RB / VB (emission in restricted band)	1MHz / 1MHz for Peak

Receiver Parameter	Setting
Attenuation	Auto
Start ~ Stop Frequency	9kHz~150kHz / RB 200Hz for QP
Start ~ Stop Frequency	150kHz~30MHz / RB 9kHz for QP
Start ~ Stop Frequency	30MHz~1000MHz / RB 120kHz for QP

3.4.2 TEST PROCEDURE

- a. The measuring distance of at 3 m shall be used for measurements at frequency up to 1GHz. For frequencies above 1GHz, any suitable measuring distance may be used.
- b. The EUT was placed on the top of a rotating table 0.8 m for below 1GHz and 1.5m for above 1GHz the ground at a 3 meter open area test site. The table was rotated 360 degrees to determine the position of the highest radiation.
- c. The height of the equipment or of the substitution antenna shall be 0.8 m for below 1GHz and 1.5m for above 1GHz; the height of the test antenna shall vary between 1 m to 4 m. Both horizontal and vertical polarizations of the antenna are set to make the measurement.
- d. The initial step in collecting conducted emission data is a spectrum analyzer peak detector mode pre-scanning the measurement frequency range. Significant peaks are then marked and then Quasi Peak detector mode re-measured.
- e. If the Peak Mode measured value compliance with and lower than Quasi Peak Mode Limit, the EUT shall be deemed to meet QP Limits and then no additional QP Mode measurement performed.
- f. For the actual test configuration, please refer to the related Item –EUT Test Photos.

Note:

Both horizontal and vertical antenna polarities were tested and performed pretest to three orthogonal axis. The worst case emissions were reported

3.4.3 DEVIATION FROM TEST STANDARD

No deviation

3.4.4 TEST CONFIGURATION

(A) Radiated Emission Test-Up Frequency Below 30MHz

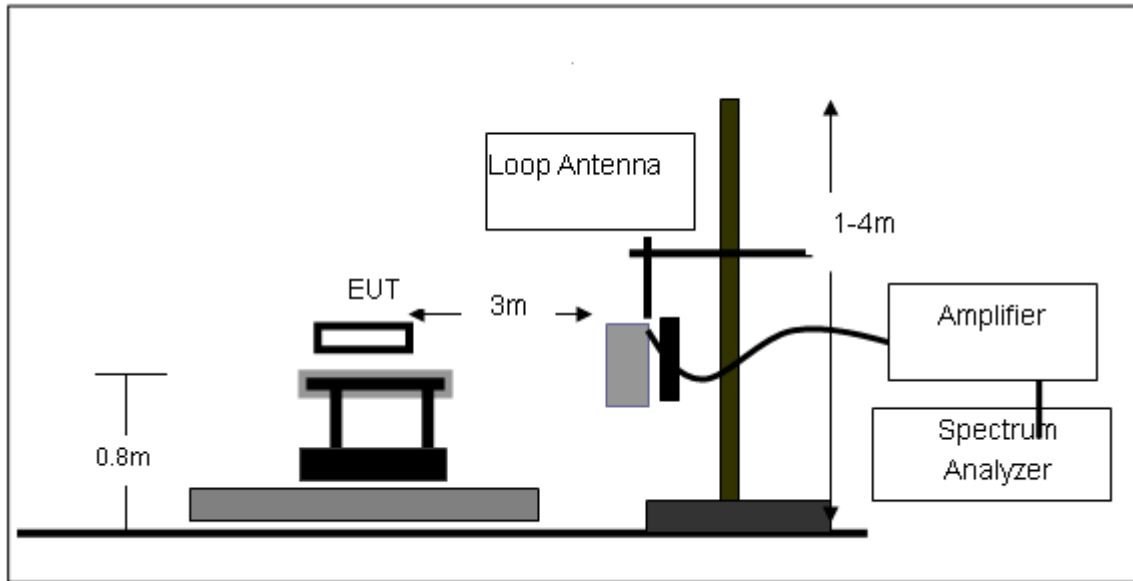

(B) Radiated Emission Test-Up Frequency 30MHz~1GHz

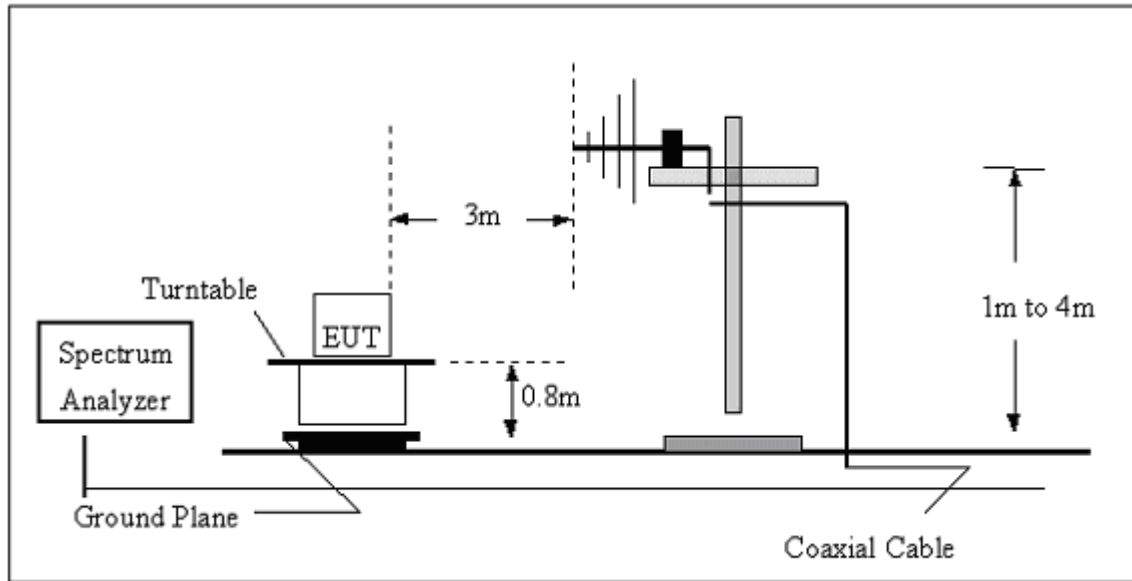

(C) Radiated Emission Test-Up Frequency Above 1GHz

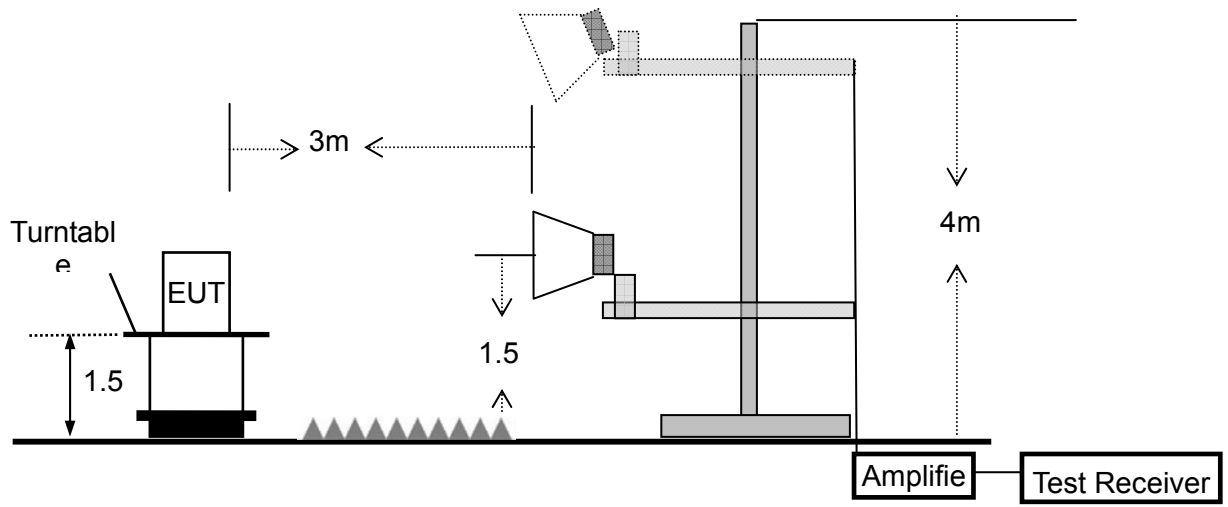

3.4.5 TEST RESULTS (Blow 30MHZ)

EUT :	Graphic Tablet (Pen Tablet)	Model Name. :	G10T
Temperature :	20 °C	Relative Humidity :	48%
Pressure :	1010 hPa	Test Voltage :	AC 120V/60Hz
Test Mode :	TX	Polarization :	--

Freq.	Reading	Limit	Margin	State
(MHz)	(dBuV/m)	(dBuV/m)	(dB)	P/F
--	--	--	--	N/A
--	--	--	--	N/A

NOTE:

The amplitude of spurious emissions which are attenuated by more than 20dB below the permissible value has no need to be reported.

Distance extrapolation factor = $20 \log (\text{specific distance}/\text{test distance})(\text{dB})$;

Limit line = specific limits(dBuv) + distance extrapolation factor.

3.4.6 TEST RESULTS (BETWEEN 30 – 1000 MHZ)

EUT :	Graphic Tablet (Pen Tablet)	Model Name :	G10T
Temperature :	20 °C	Relative Humidity :	48%
Pressure :	1010 hPa	Test Voltage :	AC 120V/60Hz
Test Mode :	TX	Polarization :	Vertical

Frequency (MHz)	Meter Reading (dBμV)	Factor (dB)	Emission Level (dBμV/m)	Limits (dBμV/m)	Margin (dB)	Detector Type
36.8953	18.58	17.08	35.66	40.00	-4.34	QP
121.5485	26.85	11.65	38.50	43.50	-5.00	QP
134.0882	26.59	12.05	38.64	43.50	-4.86	QP
183.8437	22.26	13.11	35.37	43.50	-8.13	QP
301.4224	17.83	13.89	31.72	46.00	-14.28	QP
665.8035	19.96	22.00	41.96	46.00	-4.04	QP

Remark:

1. Factor = Antenna Factor + Cable Loss – Pre-amplifier.

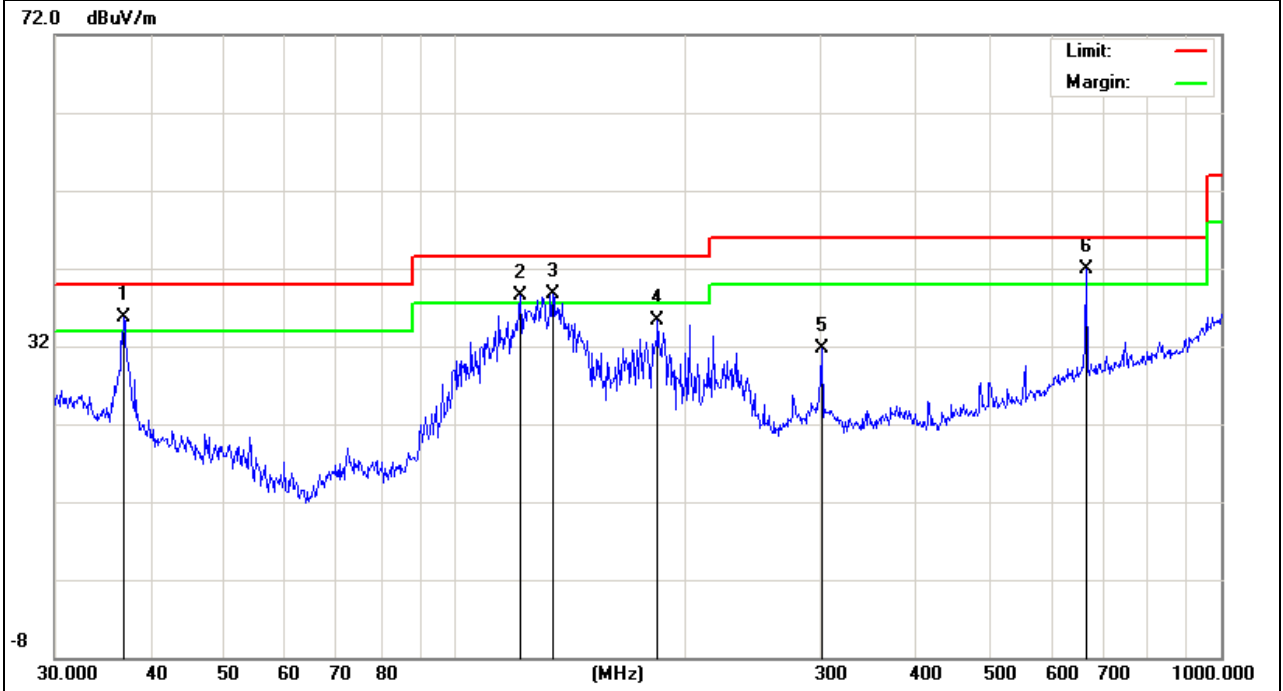

EUT :	Graphic Tablet (Pen Tablet)	Model Name :	G10T
Temperature :	20 °C	Relative Humidity :	48%
Pressure :	1010 hPa	Test Voltage :	AC 120V/60Hz
Test Mode :	TX	Polarization :	Horizontal

Frequency (MHz)	Meter Reading (dBµV)	Factor (dB)	Emission Level (dBµV/m)	Limits (dBµV/m)	Margin (dB)	Detector Type
124.569	16.27	11.75	28.02	43.50	-15.48	QP
178.1327	21.22	13.30	34.52	43.50	-8.98	QP
233.3487	22.17	12.02	34.19	46.00	-11.81	QP
305.68	16.01	14.08	30.09	46.00	-15.91	QP
414.7223	15.14	15.98	31.12	46.00	-14.88	QP
668.1422	13.62	22.06	35.68	46.00	-10.32	QP

Remark:

1. Factor = Antenna Factor + Cable Loss – Pre-amplifier.

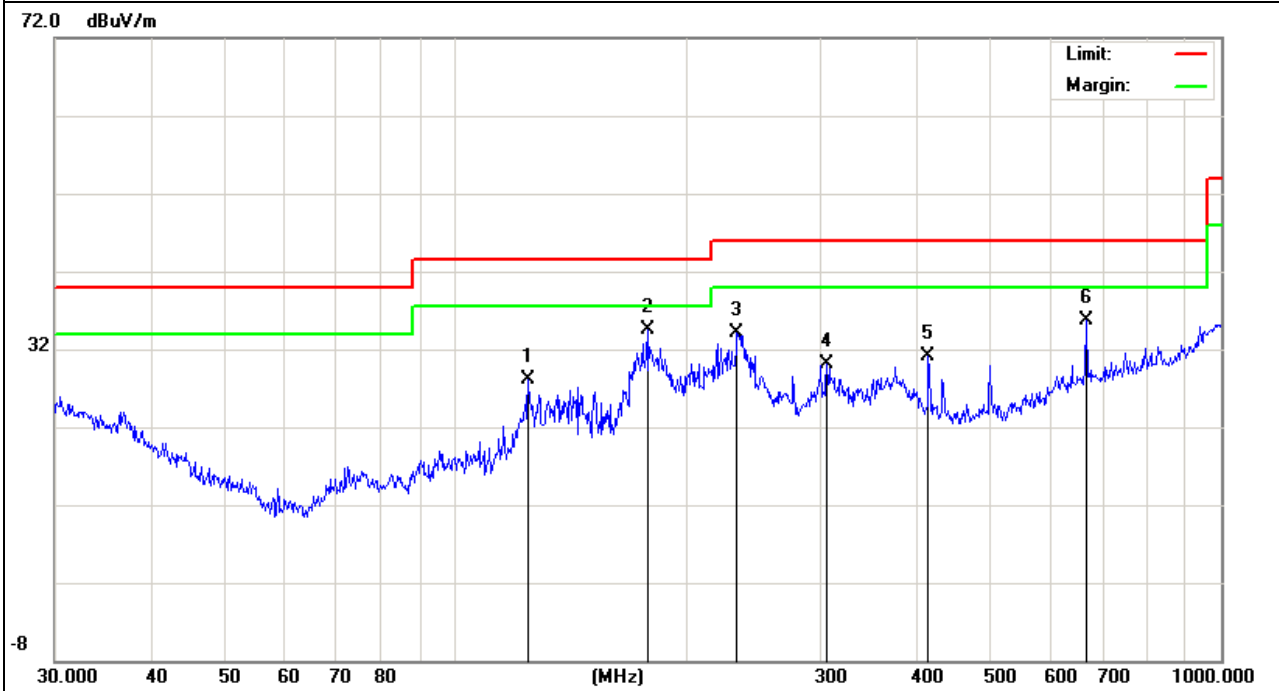

3.4.7 TEST RESULTS (ABOVE 1000 MHZ)

EUT :	Graphic Tablet (Pen Tablet)	Model Name :	G10T
Temperature :	20 °C	Relative Humidity :	48%
Pressure :	1010 hPa	Test Voltage :	AC 120V/60Hz
Test Mode :	TX-2402MHz	Polarization :	Horizontal

Frequency (MHz)	Meter Reading (dBµV)	Factor (dB)	Emission Level (dBµV/m)	Limits (dBµV/m)	Margin (dB)	Detector Type
2402.5	80.21	-10.14	70.07	114.00	-43.93	peak
2402.5	72.16	-10.14	62.02	94.00	-31.98	AVG
4825	48.38	-2.46	45.92	74.00	-28.08	peak
4825	39.04	-2.46	36.58	54.00	-17.42	AVG
7205	41.81	-0.27	41.54	74.00	-32.46	peak
7205	33.51	-0.27	33.24	54.00	-20.76	AVG

Remark:
 Factor = Antenna Factor + Cable Loss – Pre-amplifier.
 No emission above 18GHz.

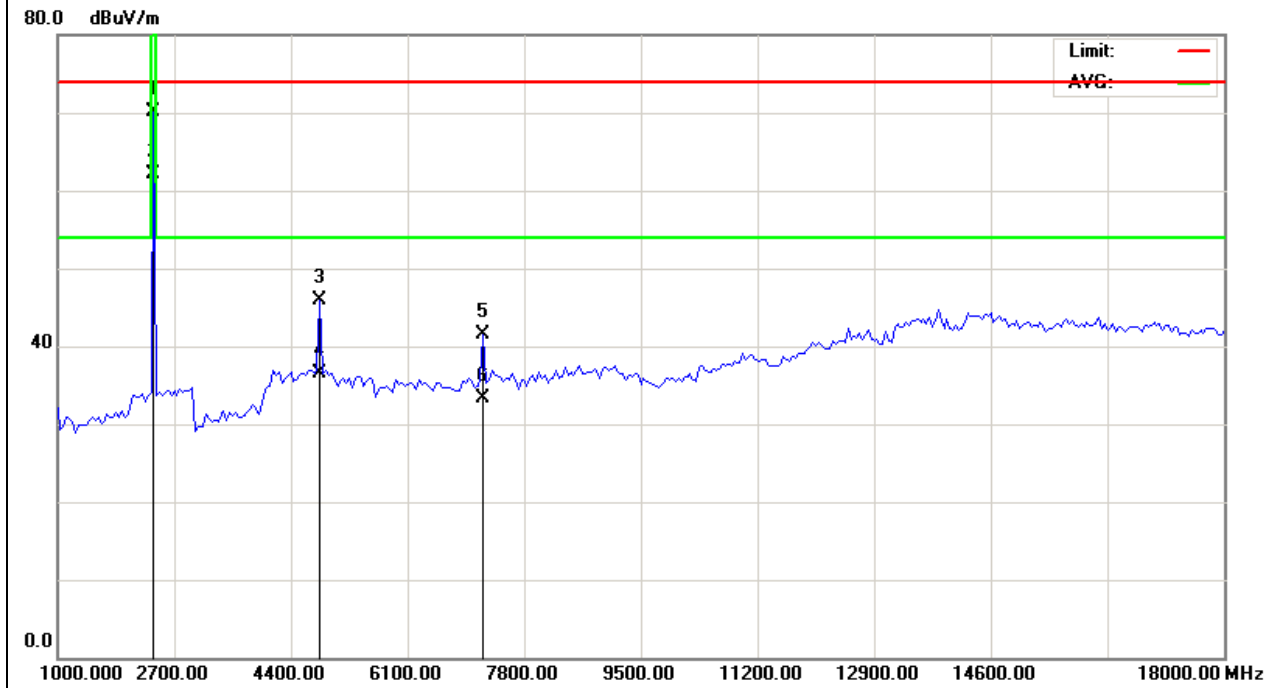

EUT :	Graphic Tablet (Pen Tablet)	Model Name :	G10T
Temperature :	20 °C	Relative Humidity :	48%
Pressure :	1010 hPa	Test Voltage :	AC 120V/60Hz
Test Mode :	TX-2402MHz	Polarization :	Vertical

Frequency (MHz)	Meter Reading (dBμV)	Factor (dB)	Emission Level (dBμV/m)	Limits (dBμV/m)	Margin (dB)	Detector Type
2402.5	77.06	-10.14	66.92	114.0 0	-47.08	peak
2402.5	62.26	-10.14	52.12	94.00	-41.88	AVG
4187.5	46.39	-5.08	41.31	74.00	-32.69	peak
4187.5	35.19	-5.08	30.11	54.00	-23.89	AVG
8395	36.60	1.32	37.92	74.00	-36.08	peak
8395	14.01	1.32	15.33	54.00	-38.67	AVG

Remark:
 Factor = Antenna Factor + Cable Loss – Pre-amplifier.
 No emission above 18GHz.

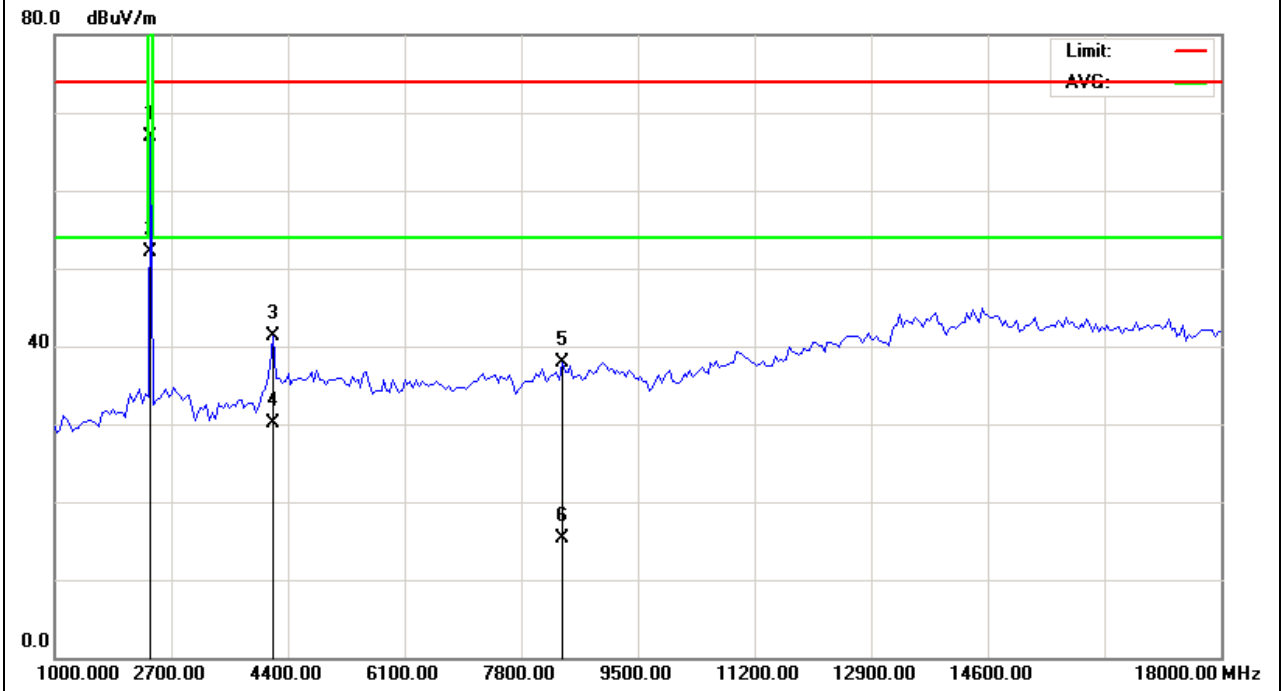

Note: EUT Pre-scan X/Y/Z orientation, only worst case is presented in the report(X orientation).

3.4.8 TEST RESULTS (RESTRICTED BANDS REQUIREMENTS)

EUT :	Graphic Tablet (Pen Tablet)	Model Name :	G10T
Temperature :	20 °C	Relative Humidity :	48%
Pressure :	1010 hPa	Test Voltage :	AC 120V/60Hz
Test Mode :	TX-2402MHz	Polarization :	Horizontal

Frequency (MHz)	Meter Reading (dBµV)	Factor (dB)	Emission Level (dBµV/m)	Limits (dBµV/m)	Margin (dB)	Detector Type
2399.635	66.7	-10.09	56.61	74	-17.39	peak
2399.635	36.16	-10.09	26.07	54	-27.93	AVG
2400	64.64	-10.09	54.55	74	-19.45	peak
2400	36.48	-10.09	26.39	54	-27.61	AVG

Remark:
Factor = Antenna Factor + Cable Loss – Pre-amplifier.

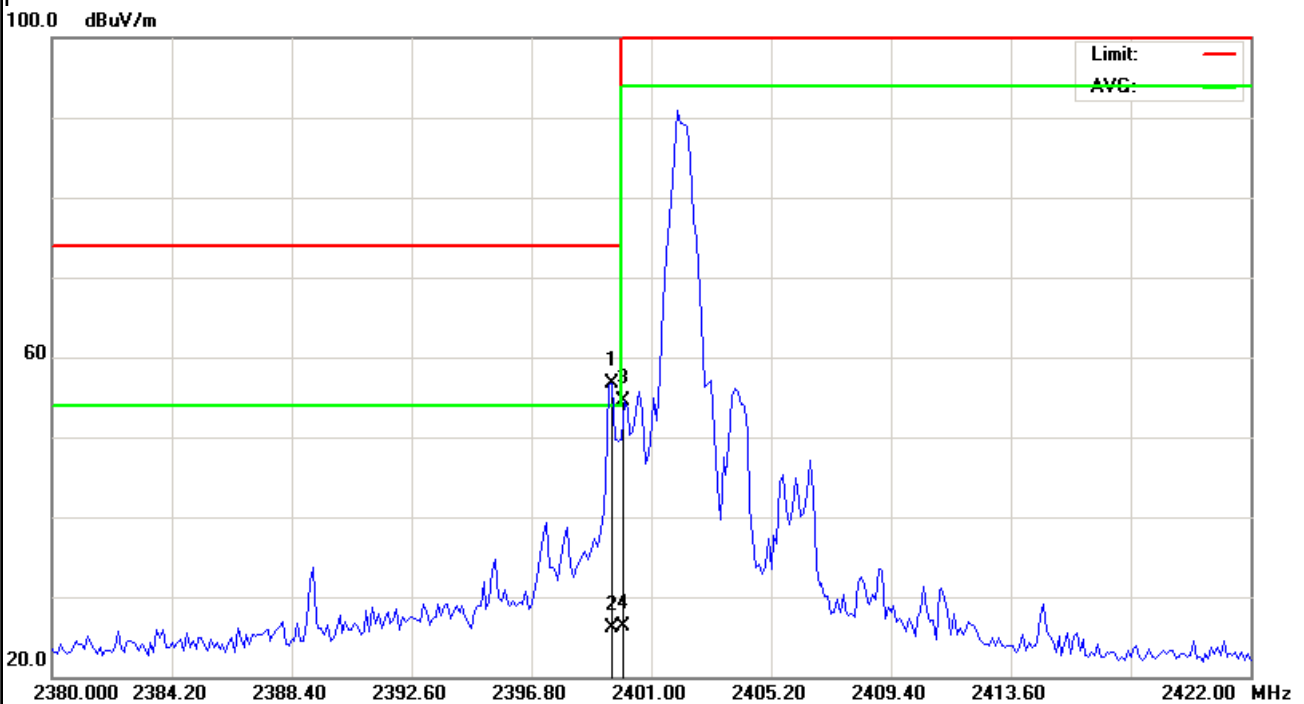

EUT :	Graphic Tablet (Pen Tablet)	Model Name :	G10T
Temperature :	20 °C	Relative Humidity :	48%
Pressure :	1010 hPa	Test Voltage :	AC 120V/60Hz
Test Mode :	TX-2402MHz	Polarization :	Vertical

Frequency (MHz)	Meter Reading (dBμV)	Factor (dB)	Emission Level (dBμV/m)	Limits (dBμV/m)	Margin (dB)	Detector Type
2399.635	56.16	-10.09	46.07	74	-27.93	peak
2399.635	39.23	-10.09	29.14	54	-24.86	AVG
2400.58	56.99	-10.1	46.89	74	-27.11	peak
2400.58	30.62	-10.1	20.52	54	-33.48	AVG

Remark:
 Factor = Antenna Factor + Cable Loss – Pre-amplifier.

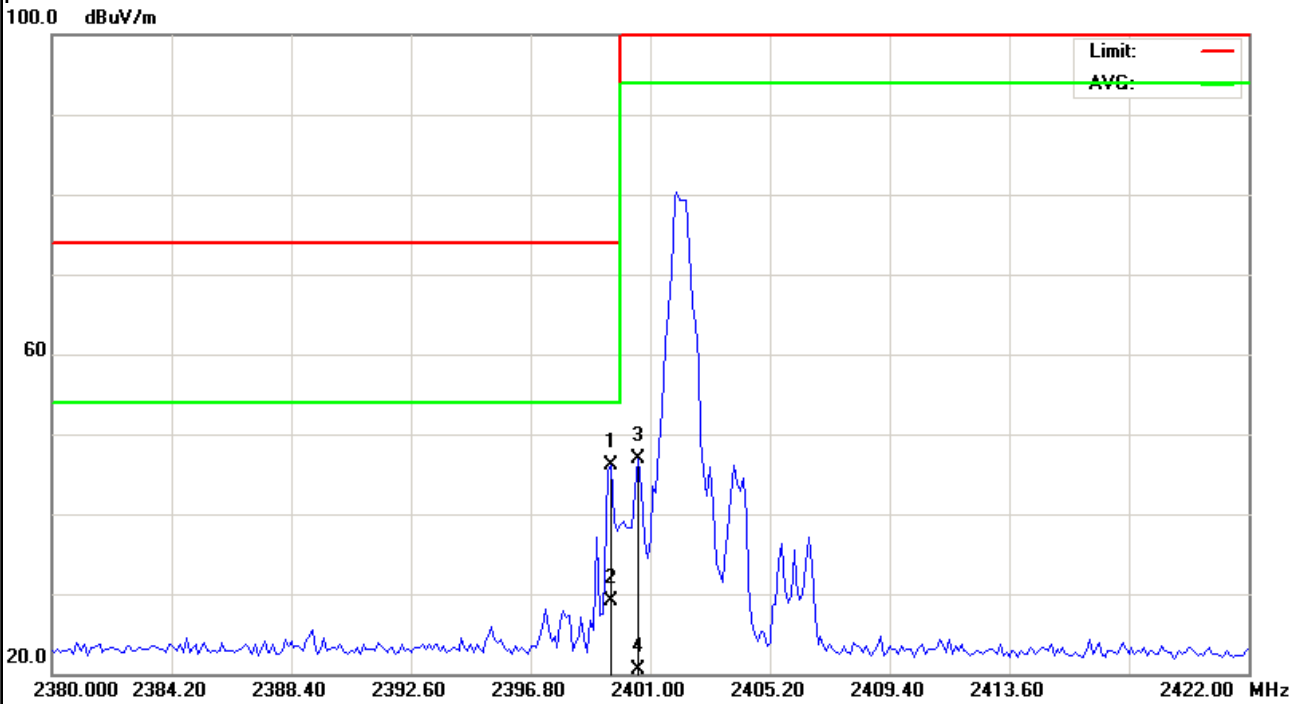

EUT :	Graphic Tablet (Pen Tablet)	Model Name :	G10T
Temperature :	20 °C	Relative Humidity :	48%
Pressure :	1010 hPa	Test Voltage :	AC 120V/60Hz
Test Mode :	TX-2440MHz	Polarization :	Horizontal

Frequency (MHz)	Meter Reading (dBμV)	Factor (dB)	Emission Level (dBμV/m)	Limits (dBμV/m)	Margin (dB)	Detector Type
2445	83.53	-10.97	72.56	114	-41.44	peak
2445	73.32	-10.97	62.35	94	-31.65	AVG
4867.5	40.06	-2.36	37.7	74	-36.3	peak
4867.5	22.61	-2.36	20.25	54	-33.75	AVG
14515.00 0	-2.61	48.34	45.73	74	-28.27	peak
14515	-27.32	48.34	21.02	54	-32.98	AVG

Remark:
Factor = Antenna Factor + Cable Loss – Pre-amplifier.

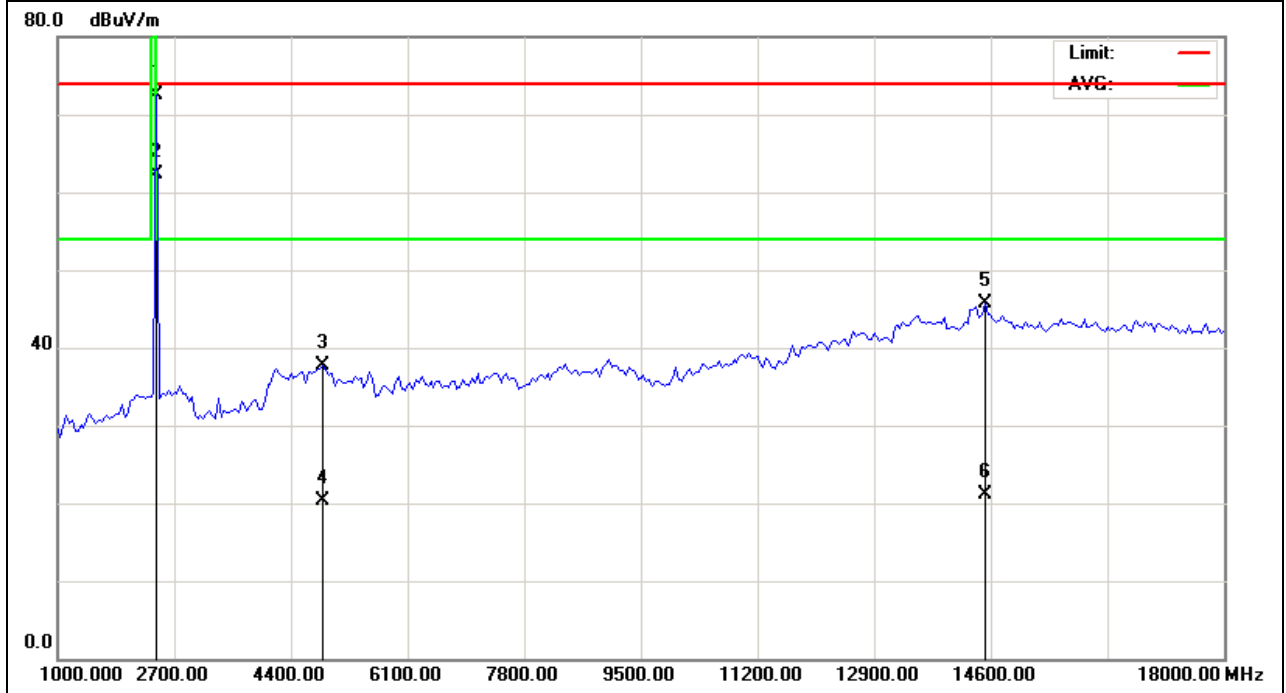

EUT :	Graphic Tablet (Pen Tablet)	Model Name :	G10T
Temperature :	20 °C	Relative Humidity :	48%
Pressure :	1010 hPa	Test Voltage :	AC 120V/60Hz
Test Mode :	TX-2440MHz	Polarization :	Vertical

Frequency (MHz)	Meter Reading (dBμV)	Factor (dB)	Emission Level (dBμV/m)	Limits (dBμV/m)	Margin (dB)	Detector Type
2445	83.42	-10.97	72.45	114	-41.55	peak
2445	70.99	-10.97	60.02	94	-33.98	AVG
5547.5	38.74	-1.86	36.88	74	-37.12	peak
5547.5	21.97	-1.86	20.11	54	-33.89	AVG
7332.5	39.81	-0.09	39.72	74	-34.28	peak
7332.5	23.44	-0.09	23.35	54	-30.65	AVG

Remark:
 Factor = Antenna Factor + Cable Loss – Pre-amplifier.

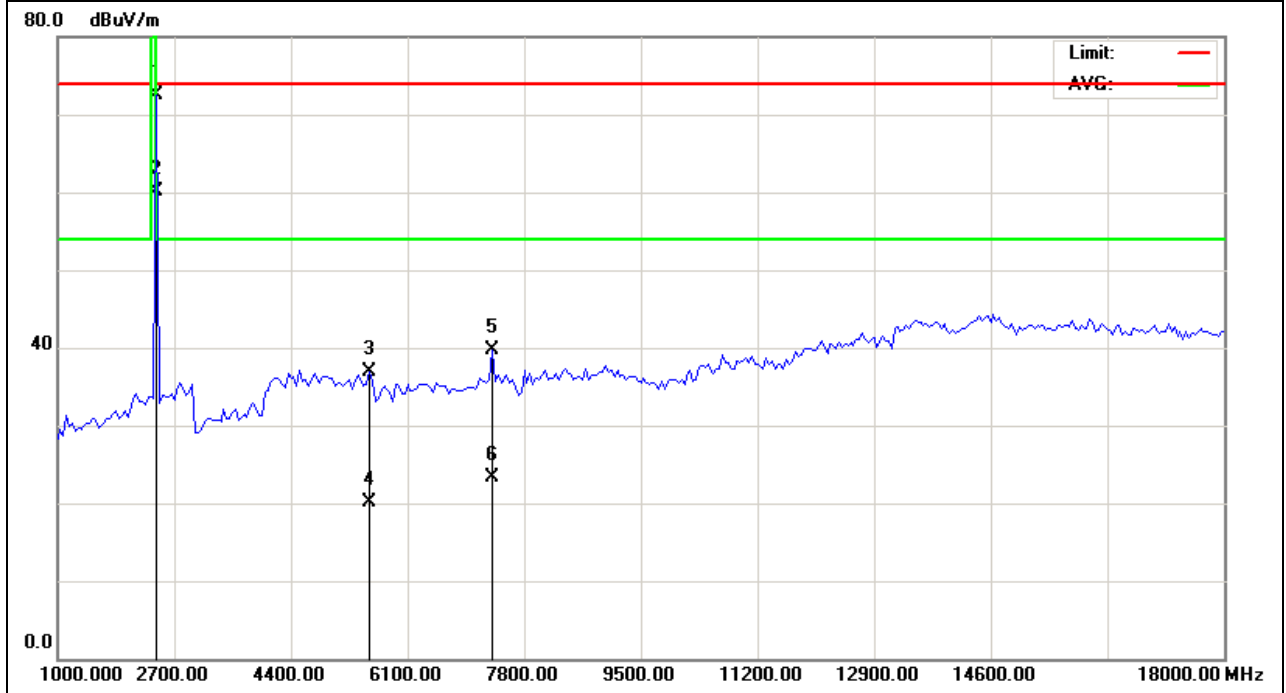

EUT :	Graphic Tablet (Pen Tablet)	Model Name :	G10T
Temperature :	20 °C	Relative Humidity :	48%
Pressure :	1010 hPa	Test Voltage :	AC 120V/60Hz
Test Mode :	TX-2480MHz	Polarization :	Horizontal

Frequency (MHz)	Meter Reading (dBμV)	Factor (dB)	Emission Level (dBμV/m)	Limits (dBμV/m)	Margin (dB)	Detector Type
2402.5	82.78	-10.14	72.64	114	-41.36	peak
2402.5	72.25	-10.14	62.11	94	-31.89	AVG
4145	42.11	-4.97	37.14	74	-36.86	peak
4145	29.09	-4.97	24.12	54	-29.88	AVG
5547.5	38.51	-1.86	36.65	74	-37.35	peak
5547.5	21.96	-1.86	20.1	54	-33.9	AVG

Remark:
Factor = Antenna Factor + Cable Loss – Pre-amplifier.

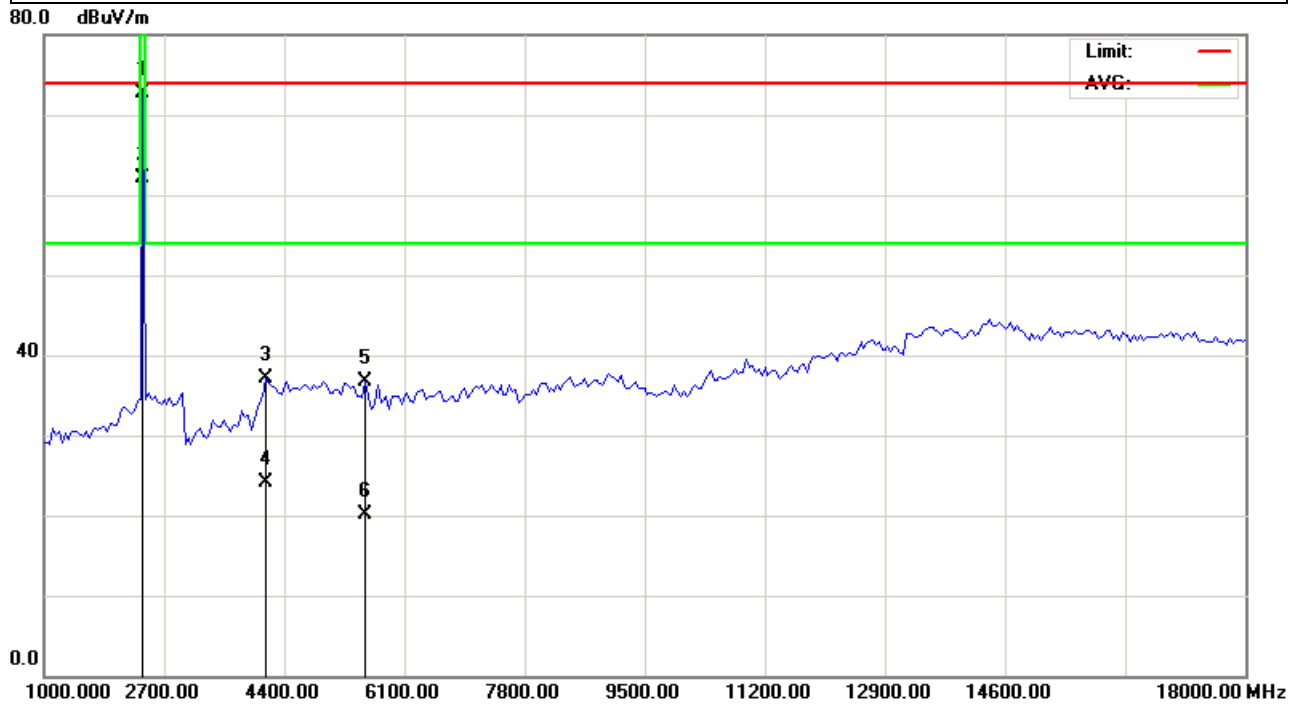

EUT :	Graphic Tablet (Pen Tablet)	Model Name :	G10T
Temperature :	20 °C	Relative Humidity :	48%
Pressure :	1010 hPa	Test Voltage :	AC 120V/60Hz
Test Mode :	TX-2480MHz	Polarization :	Vertical

Frequency (MHz)	Meter Reading (dBμV)	Factor (dB)	Emission Level (dBμV/m)	Limits (dBμV/m)	Margin (dB)	Detector Type
2481.6	55.33	-10.99	44.34	74	-29.66	peak
2481.6	31.09	-10.99	20.1	54	-33.9	AVG
2483.5	33.96	-10.99	22.97	74	-51.03	peak
2483.5	21.31	-10.99	10.32	54	-43.68	AVG

Remark:
Factor = Antenna Factor + Cable Loss – Pre-amplifier.

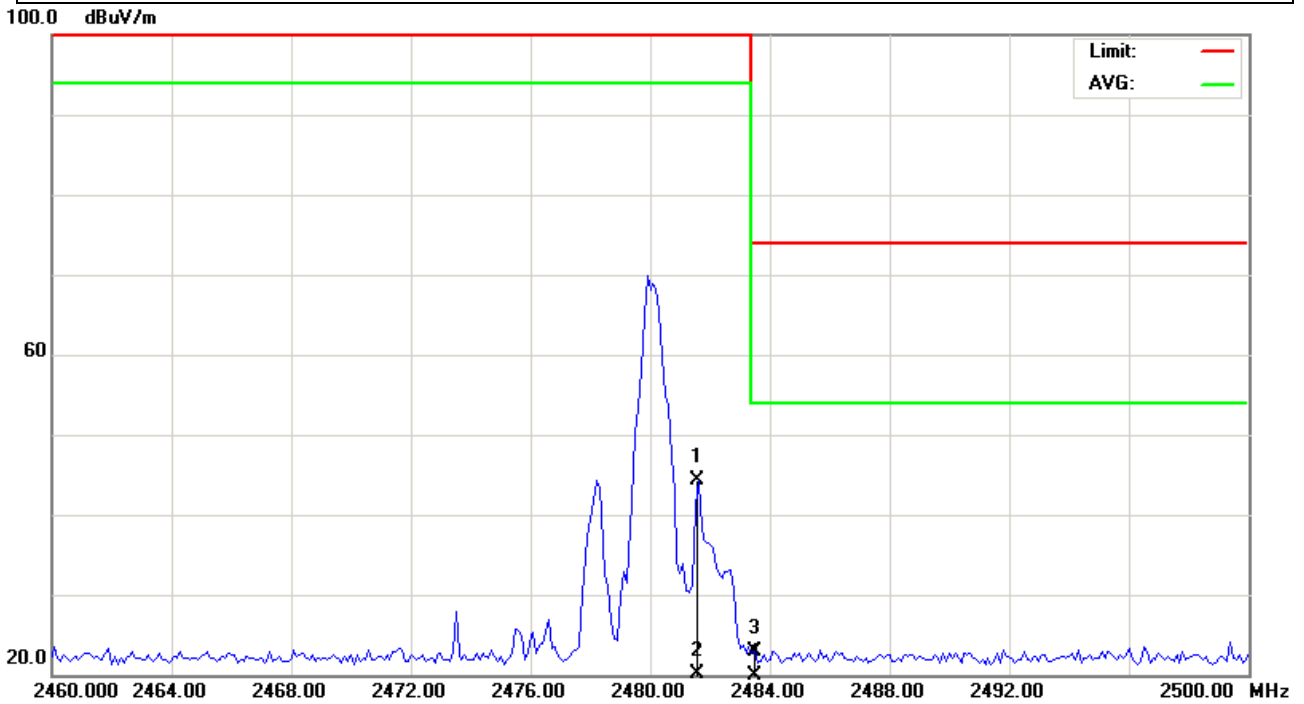

EUT :	Graphic Tablet (Pen Tablet)	Model Name :	G10T
Temperature :	20 °C	Relative Humidity :	48%
Pressure :	1010 hPa	Test Voltage :	AC 120V/60Hz
Test Mode :	TX-2480MHz	Polarization :	Horizontal

Frequency (MHz)	Meter Reading (dBμV)	Factor (dB)	Emission Level (dBμV/m)	Limits (dBμV/m)	Margin (dB)	Detector Type
2481.6	61.44	-10.99	50.45	74	-23.55	peak
2481.6	40.23	-10.99	29.24	54	-24.76	AVG
2483.5	35.47	-10.99	24.48	74	-49.52	peak
2483.5	21.2	-10.99	10.21	54	-43.79	AVG

Remark:
Factor = Antenna Factor + Cable Loss – Pre-amplifier.

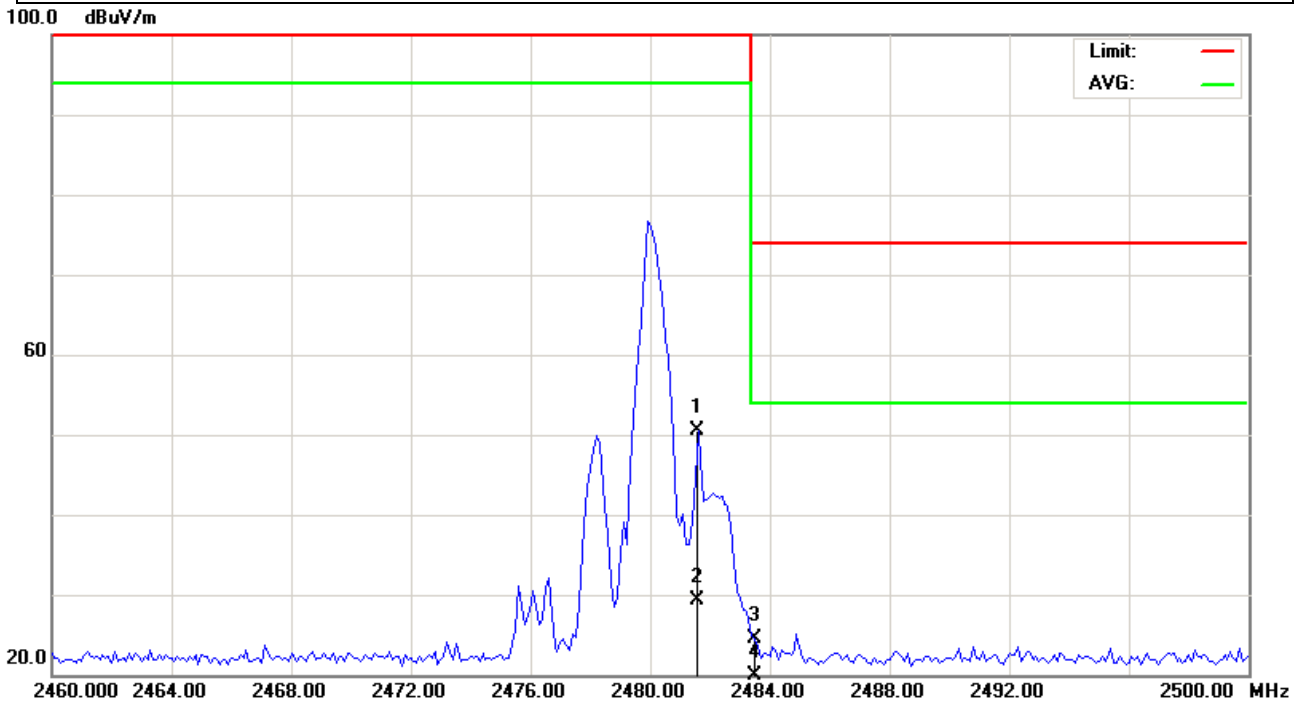

4. BANDWIDTH TEST

4.1 TEST PROCEDURE

- a. The EUT was directly connected to the spectrum analyzer and antenna output port as show in the block diagram below,
- b. Spectrum Setting : RBW= 100KHz, VBW \geq RBW, Sweep time = Auto.

4.2 DEVIATION FROM STANDARD

No deviation.

4.3 TEST SETUP

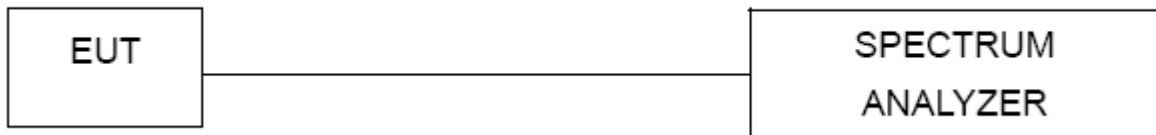

4.4 TEST RESULTS

EUT :	Graphic Tablet (Pen Tablet)	Model Name :	G10T
Temperature :	26 °C	Relative Humidity :	53%
Pressure :	1020 hPa	Test Power :	AC 120V/60Hz
Test Mode :	TX		

Test Channel	Frequency (MHz)	20 dBc Bandwidth (MHz)
CH01	2402	1.113
CH19	2440	1.100
CH39	2480	1.089

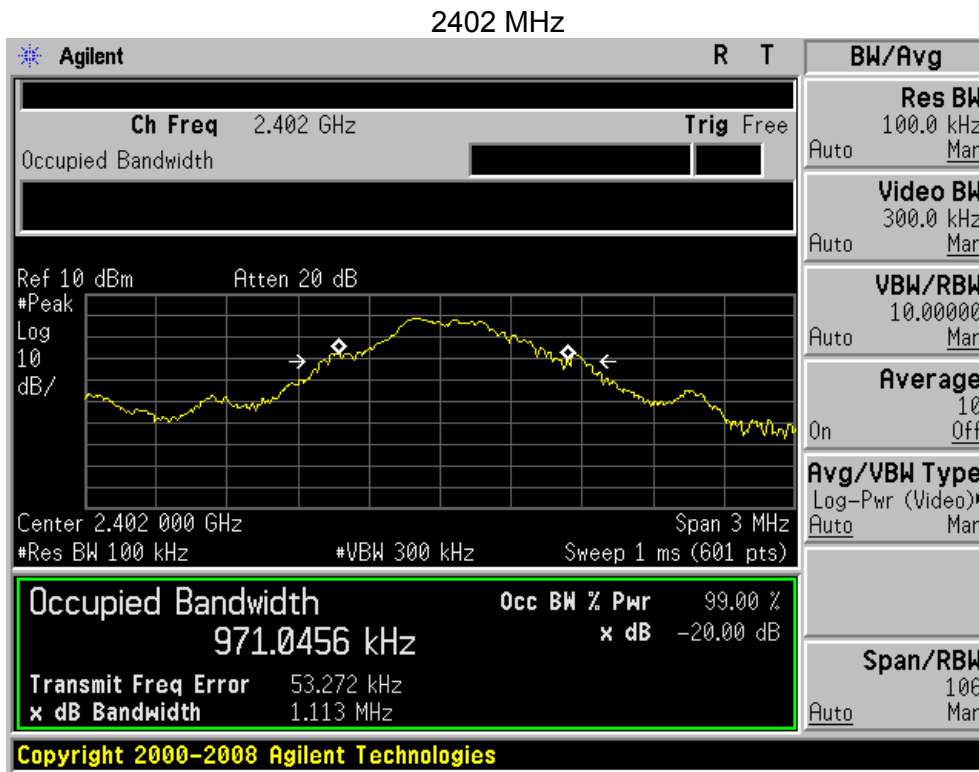

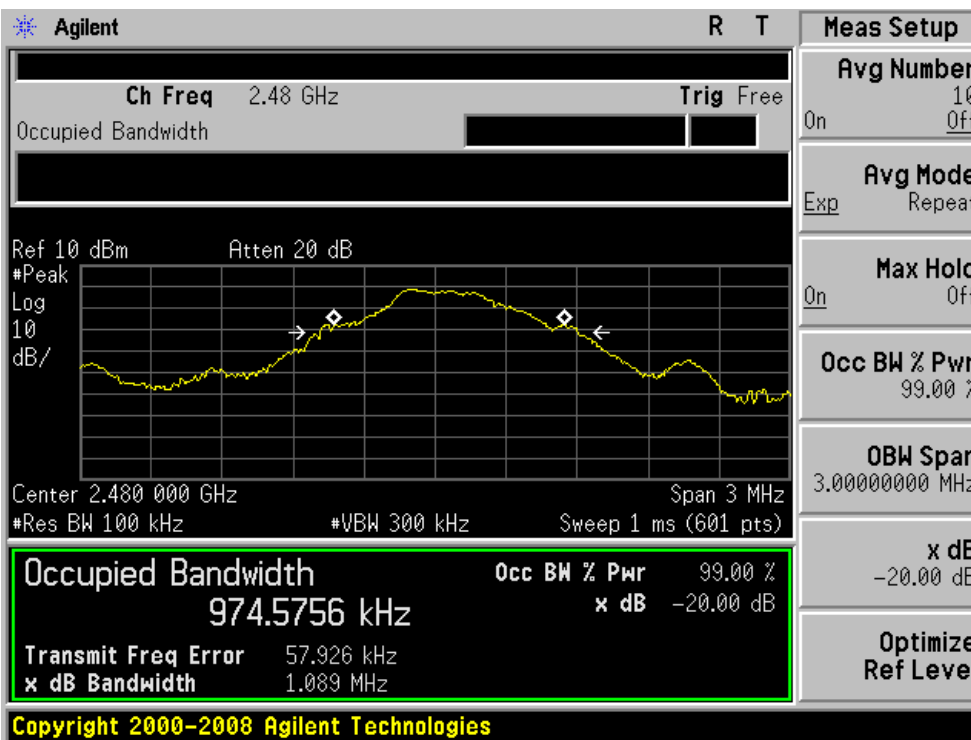
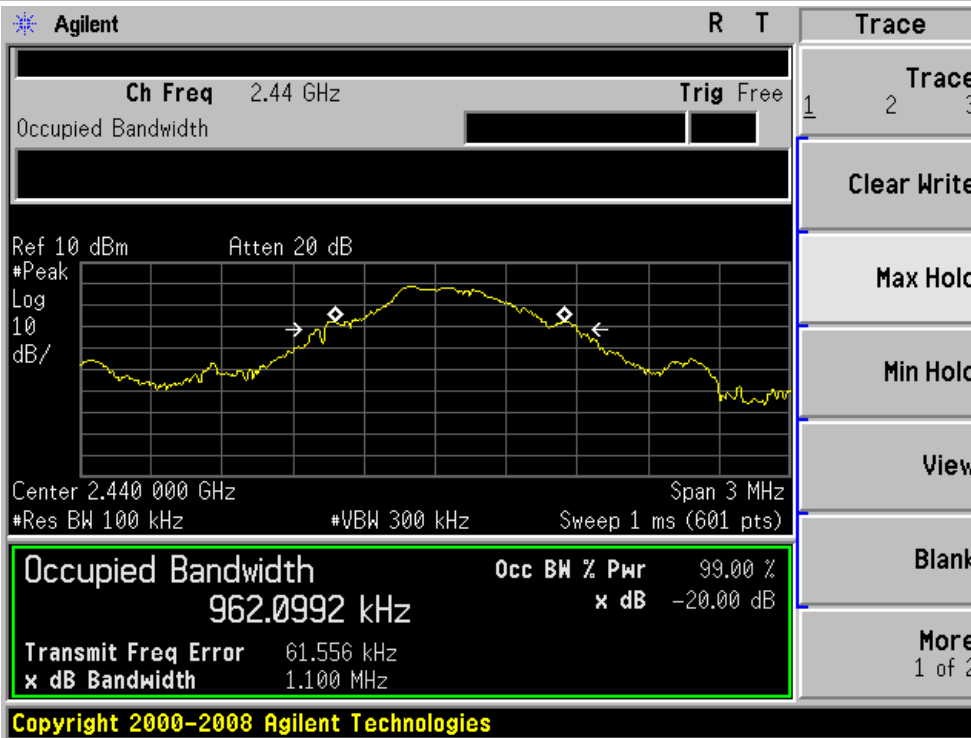

5. EUT TEST PHOTO

Radiated Measurement Photos

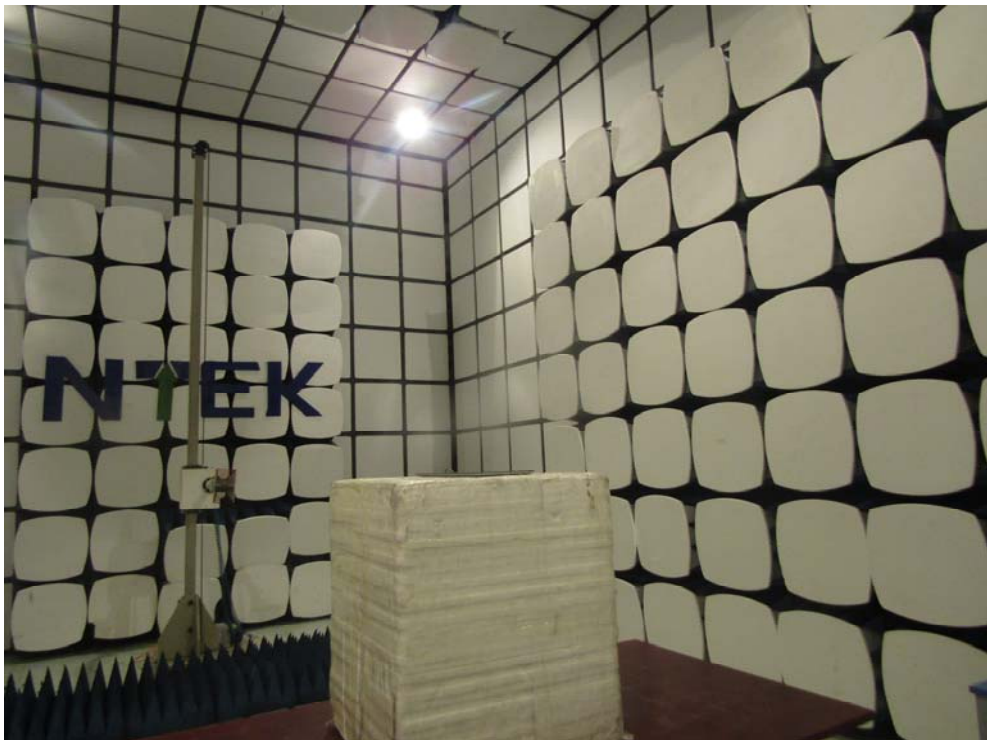
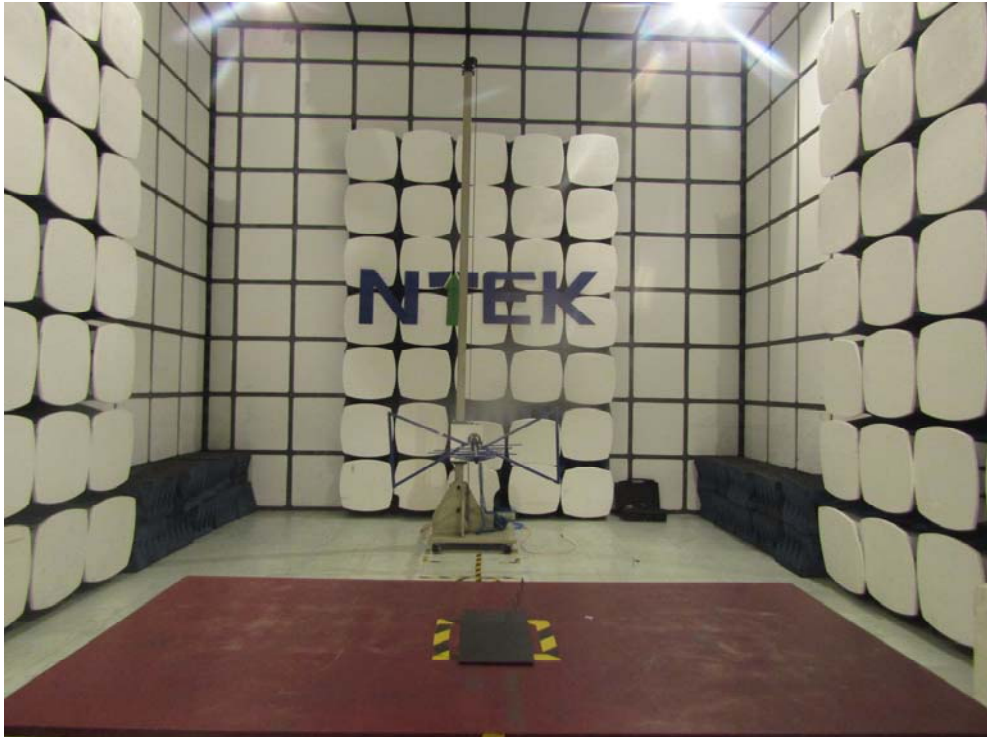

Conducted Measurement Photos

