

39GHz_L 5G Wireless Optical DAS Operating Manual

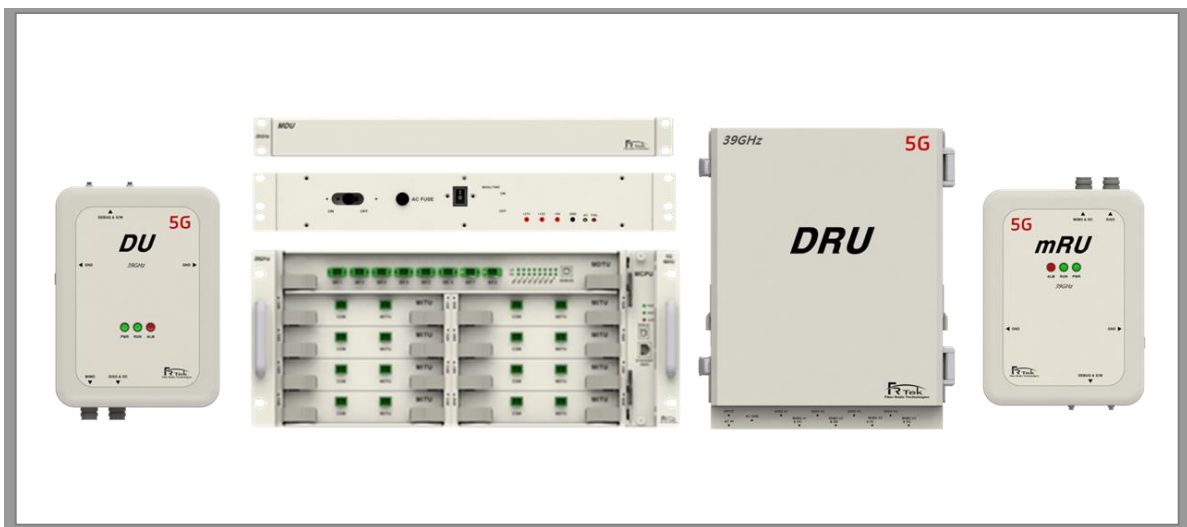

Document Reference

Company:	Fiber Radio Technologies
Version:	Ver 1.0
Document Status:	Release 1
Issue Date:	2021. 03.
Department:	R&D Group 2
Author Manager:	Jun Hyun, Lee

▪ Copyright

The copyright of this manual is from FRTek Co., Ltd.

This manual may not be reproduced, distributed, modified on any form without the consent of FRTek Co., Ltd

Unauthorized disclosure, distribution, copying or use of the information contained in this document in whole or in part without authority is strictly prohibited.

▪ Trademark

The trademarks mentioned in this manual are registered trademarks of the respective company.

Please read this service manual before installation and operation. Use the system only in accordance with contents of this manual.

- The specification and information regarding the products in this manual are subject to change due to updates to system functionality or system revision changes without notice. For the latest revision of this manual or for technical inquiries, please contact below :

Company Address : 181 Metro Drive, Suite 580, San Jose, CA 95110

Homepage : <http://www.frtek.com>

Contact for technical inquires or troubleshooting.

Telephone : 330-622-2911 or 510-390-1939

Revision History

Version	Issue Date	Details of Revision	Author	Authorizing Manager
V 1.0	March 19, 2021.	Original	Jun Hyun, Lee	

This manual is produced by R&D Group 2 Printed in FRTek.

Contents

Chapter 1. Safety & Certification Notice	8
1.1 FCC Warning Statements	9
1.1.1 FCC Part 15.105 statement	9
1.1.2 FCC Part 15.21 statement	9
1.1.3 Health and Safety Warnings	9
1.2 Certification Notice	12
 Chapter 2. System Overview.....	 13
2.1 System Overview	14
2.1.1 Overview	14
2.1.2 Design Consideration	15
2.2 System Network Configuration	16
 Chapter 3. System Configuration.....	 17
3.1 DU Configuration	18
3.2 MDU Configuration.....	19
3.3 MPSU Configuration	20
3.4 MHU Configuration.....	21
3.5 MDU, MPSU, MHU Wiring.....	22
3.6 DRU Configuration.....	24
3.7 mRU Configuration	25
 Chapter 4. System Specification	 26
4.1 System Specification	27
4.1.1 Downlink Specification.....	27
4.1.2 Uplink Specification	27
4.2 Equipment Specification	28
4.2.1 Structure.....	28

4.2.2 Manufacturing and Processing	28
4.2.3 Material and Component.....	29
4.3 Electrical Specification	30
4.4 Environmental Specification	30
Chapter 5. Local GUI(Graphical User Interface)	31
5.1 GUI Configuration	32
5.1.1 DU Main Screen	32
5.1.2 MDU Main Screen	34
5.1.3 MHU Main Screen	36
5.1.4 DRU Main Screen	37
5.1.5 mRU Main Screen.....	39

Figures

Figure 1. Network Configuration..... 16

Figure 2. DU Configuration..... 18

Figure 3. MDU Configuration. 19

Figure 4. MPSU Configuration. 20

Figure 5. MHU Configuration. 21

Figure 6. MDU, MPSU, MHU wiring method – RF Cable. 22

Figure 7. MDU, MPSU, MHU Wiring Method - Harness..... 22

Figure 8. DRU Configuration. 24

Figure 9. mRU Configuration..... 25

Figure 10. DU Main Screen. 32

Figure 11. MDU Main Screen. 34

Figure 12. MHU Main Screen. 36

Figure 13. DRU Main Screen..... 38

Figure 14. mRU Main Screen. 39

Used Abbreviations

DAS	D istributed A ntenna S ystem
DU	D onor U nit
MDU	M HU to D U interface U nit
MPSU	M HU P ower S upply U nit
MHU	M aster H ub U nit
DRU	D igital R emote U nit
mRU	m mWave R emote U nit
GUI	G raphical U ser I nterface
SISO	S ingle I nput S ingle O utput
MIMO	M ultiple I nput M ultiple O utput
ACLR	A djacent C hannel L eakage P ower R atio
ALC	A uto L evel C ontrol
EVM	E rror V ector M agnitude
3GPP	3 rd G eneration P artnership P roject

Chapter 1

Safety & Certification Notice

-
- 1.1 FCC Warning Statements**
 - 1.2 Certification Notice**

Safety & Certification Notice

1.1 FCC Warning Statements

1.1.1 FCC Part 15.105 statement

- This equipment has been tested and found to comply with the limits for a Class A digital device.
- These limits are designed to provide reasonable protection against harmful interference when the equipment is operated in a commercial environment.
- This equipment generates, uses, and can radiate radio frequency energy and, if not installed and used in accordance with the instruction manual, may cause harmful interference to radio communications.
- Operation of this equipment in a residential area is likely to cause harmful interference in which case the user will be required to correct the interference at his own expense.

1.1.2 FCC Part 15.21 statement

- Any changes or modifications not expressly approved by the party responsible for compliance could void the user's authority to operate this equipment

1.1.3 Health and Safety Warnings

- This system can be operated by approved operator only and operator should observe the warning sentence of operating manual.
- The operator who can install, operate or handle related system service should acquaint themselves this manual.
- Control and configuration of this system should be set up according to purpose of use(Refer to the manufacturer's product information), it has to be satisfied prescribed request items.
- Operator should turn off the main power switch before installing system, maintenance and related works.
- If this product is disassembled intentionally, it can bring electric shock, breakdown, malfunction and static with losing life and property. Do not disassemble, repair and modify product.

- This system cover should be (door) securely fastened in open position, e.g. by tying it up, at outdoor work in order to prevent door from slamming due to wind causing bodily harm or damage.
- Due to power dissipation, the remote unit may reach a very high temperature. Do not operate this equipment on or close to flammable materials. Use caution when servicing the unit.
- Use this equipment only for the purpose specified by the manufacturer. Do not carry out any modifications or fit any spare parts, which are not sold or recommended by the manufacturer. This could cause fires, electric shock or other injuries.
- Read and obey all the warning labels attached to the unit. Make sure that all warning labels are kept in a legible condition.
- It is the responsibility of the network provider to implement prevention measures to avoid health hazards associated with radiation from the antenna(s) connected to the unit.
- Do not use any solvents, chemicals, or cleaning solutions containing alcohol, ammonia, or abrasives.
- Although the remote unit is internally protected against overvoltage, it is strongly recommended to ground (earth) the antenna cables close to the repeater's antenna connectors for protection against atmospheric discharge.



Warning

Obey all general and regional installation and safety regulations relating to work on high voltage installations, as well as regulations covering correct use of tools and personal protective equipment.



Warning

Use of unauthorized antennas, cables, and /or coupling devices not conforming with ERP/EIRP and /or indoor-only restrictions is prohibited.



Warning

Laser radiation! Do not stare into the beam; do not view it directly or with optical instruments.



Warning

Please be informed that the temperature of the surface is too high. Please be careful. The label is attached to the front of the equipment and the PSU (Power Supply Unit).

• **FCC WARNING**

This equipment generates or uses radio frequency energy. Changes or modifications to this equipment may cause harmful interference unless the modifications are expressly approved in the instruction manual. The user could lose the authority to operate this equipment if an unauthorized change or modification is made.

• **[FCC] BOOSTER WARNING LABEL**

WARNING. This is **NOT** a **CONSUMER** device. It is designed for installation by **FCC LICENSEES** and **QUALIFIED INSTALLERS**. You **MUST** have an **FCC LICENSE** or express consent of an FCC License to operate this device. Unauthorized use may result in significant forfeiture penalties, including penalties in excess of \$100,000 for each continuing violation.

1.2 Certification Notice

Specification or recommendation about Antennas is not available or not mention in this manual. As per default antennas, cables or coupling devices, contact www.frtek.com for further information.

For **PLUGGABLE EQUIPMENT**, the socket-outlet shall be installed near the equipment and shall be easily accessible.

- **FCC** : This equipment complies with the applicable sections of Title 47 CFR Parts 15,22,24 and 27.5
- **UL** : This equipment complies with UL Standard for safety for information technology equipment, including electrical business equipment.
- **FDA/CDRH** : This equipment uses a LASER according to FDA/CDRH Rules. This product conforms to all applicable standards of 21 CFR Chapter 1, Subchapter J, Part 1040.



Note

RESTRICTED ACCESS LOCATION: location for equipment where both of the following apply:

- access can only be gained by **SERVICE PERSONS** or by **USERS** who have been instructed about the reason for the restrictions applied to the location and about any precautions that shall be taken; and
- access is through the use of a **TOOL** or lock and key, or other means of security, and is controlled by authority responsible for the location

Chapter 2

System Overview

-
- 2.1 System Overview**
 - 2.2 System Network Configuration**

System Overview

2.1 System Overview

2.1.1 Overview

39GHz_L(Low Band, 37GHz) 5G Wireless Optic DAS is a 5G DAS(Distributed Antenna System) system to provide high quality communication and smooth data communication service indoors/outdoors. This system can service mmWave 37GHz frequency band service, and can be used for public and private facilities..

39GHz_L 5G Wireless Optic DAS system installation location :

- Shopping mall
- Hotel
- Campus
- Airport
- Subway
- Stadium and convention center

This system helps improve in-building/outdoor wireless environments with poor telecommunication conditions, and lets users have telecommunication service regardless of the area.

System frequency :

- mmWave 37GHz SISO/MIMO
(37.6GHz ~ 38.6GHz, BW 1GHz)

This system can be extended with Star-Connection network. Configured with up to 8 optic branch, 1 optic branch is connected with 4 service units.

39GHz_L 5G Wireless Optic DAS main pros and characteristics can be summarized as below.

- Next generation mobile telecommunication service support
 - US mmWave 37GHz 5G service.
 - Total 1GHz bandwidth support.
- Scalability

- Support optical fiber port.
- Star-Connection structure.
- In-building and outdoor service.
- GUI support for all system control/monitoring on network.
- Low OPEX / CAPEX
 - Small design.
 - Easy installation and maintenance.

2.1.2 Design Consideration

39GHz_L 5G Wireless Optic DAS is configured as below, and the model names are as below.

Item	Model	Type	Remark
DU	FRM-DU39DL	Enclosure type	
MDU	FRM-MDU39L	19" Rack type	
MPSU	FRM-MPSU	19" Rack type	
MHU	FRM-MHU39	19" Rack type	
DRU	FRM-DRU39	Enclosure type	
mRU	FRM-mRU39DL	Enclosure type	

This system wirelessly receives 37GHz 5G base station signals at the DU, amplifies the signal and provides 5G service through the mRU. The sync module on the MDU extracts the TDD sync signal from the signal received from the base station and provides to each unit.

The module on each unit is designed to be easily separated for easy module replacement and maintenance. Also, the DU and DRU, mRU are designed on a IP66 structure to protect from dust, contaminants and insects for outdoor use.

2.2 System Network Configuration

39GHz_L 5G Wireless Optic DAS basic network configuration is as below.

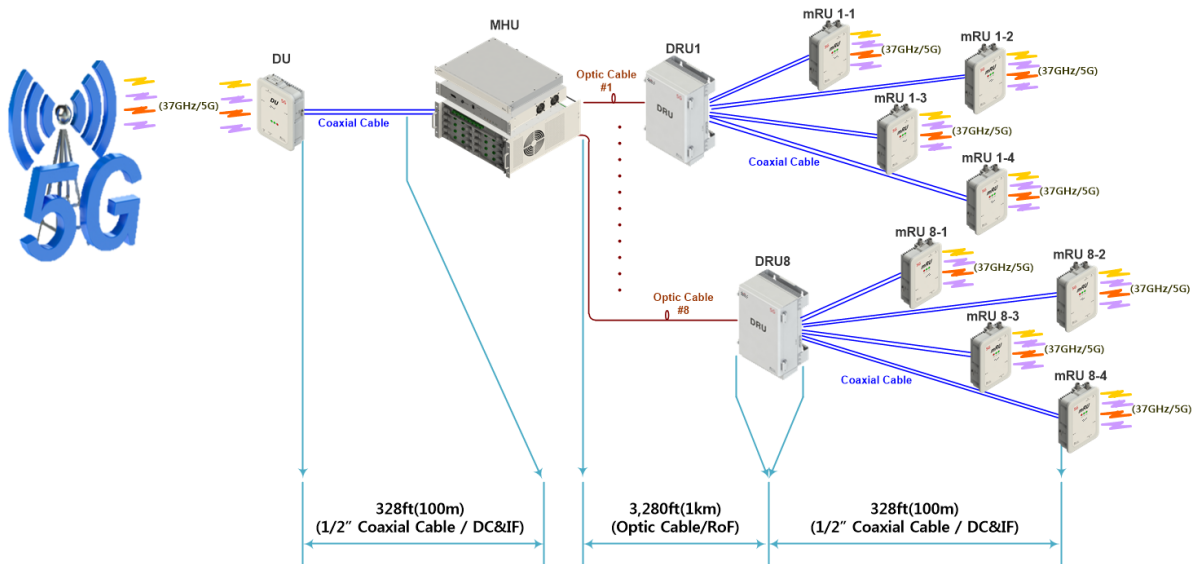

Figure 1. Network Configuration.

This system receives 37GHz 5G base station signal at the DU wirelessly, amplifies signal and provides 5G service through mRU.

This system is configured with the DU, MDU, MPSU, MHU, DRU, and mRU. MPSU is the unit supplying power to MDU and MHU. The MPSU and MDU, MHU are connected through RF cable and harness. Also, the DU, MDU and DRU, mRU are connected with 2 coaxial cables each, the MHU and DRU are connected with 1 fiber optic cable.

Each unit has an attenuator for cable loss compensation. Through this compensation attenuator the coaxial cable can be connected up to 328ft(100m), and the fiber optic cable up to 3,280ft(1km).

Chapter 3

System Configuration

-
- 3.1 DU Configuration**
 - 3.2 MDU Configuration**
 - 3.3 MPSU Configuration**
 - 3.4 MHU Configuration**
 - 3.5 MDU, MPSU MHU Wiring**
 - 3.6 DRU Configuration**
 - 3.7 mRU Configuration**

System Configuration

3.1 DU Configuration

DU is created as one enclosure, and has a mounting bracket on the back side for wall installation. The DU receives 5G base station signal wirelessly and converts into IF frequency(Downlink). Also, it converts the IF frequency into 37GHz RF signal through coaxial cable, and radiates the 5G signal to the base station through antenna.

DU is configured with DPSU, DBTU, mmWave Module, DCPU module, and is supplied from the MDU 37V power through the SISO port. And for system grounding the side is configured with AWG 6 ground terminal.

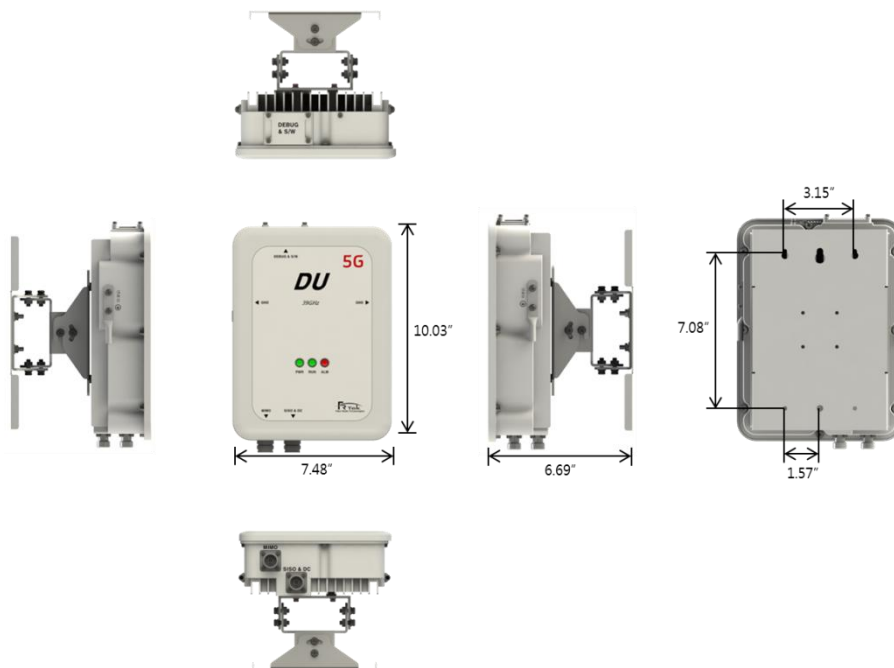

Figure 2. DU Configuration.

Warning

Since the DC 37V applied through Bias-T must be input through SISO port, SISO and MIMO must be correctly distinguished when connecting coaxial cable.

3.2 MDU Configuration

The MDU is an interface unit for DU communication and interlink, and designed to be installed on a 19 inch rack. MDU is connected with 2 coaxial cables(SISO, MIMO), the MPSU and MHU are connected with RF cable/harness.

The MDU sends DC 37V voltage supplied from the MPSU to the DU as Bias-T, and sends the received IF signal from the MHU to the DU, or sends the received IF signal from the DU to the MHU. Also, sync module is configured within the MDU, and extracts sync signal from the signal received from the DU and sends to each unit.

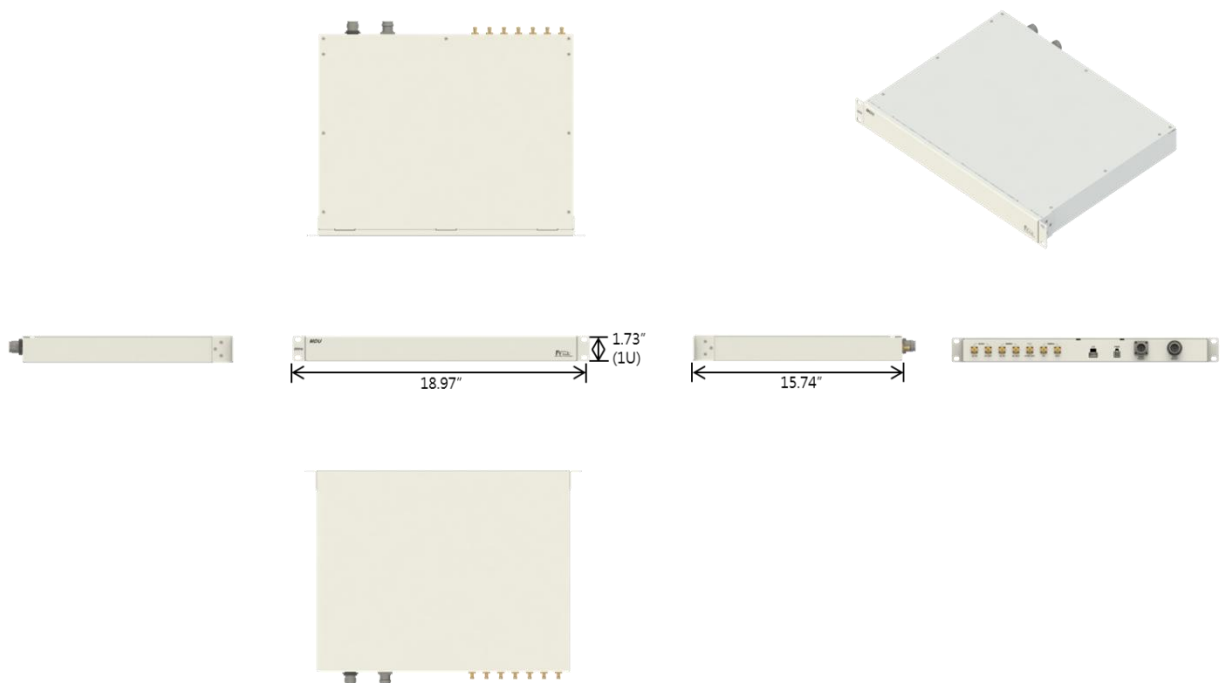

Figure 3. MDU Configuration.

3.3 MPSU Configuration

The MPSU is a unit to supply power to MDU and MHU, designed to install on 19 inch rack. It inputs AC 120V power, and has DC 6V, DC 12V, DC 24V, DC 37V output voltage. DC 6V supplies to MDU through harness, and DC 12V and DC 24V are supplied to MHU through harness. And DC 37V is supplied to the MDU through coaxial cable.

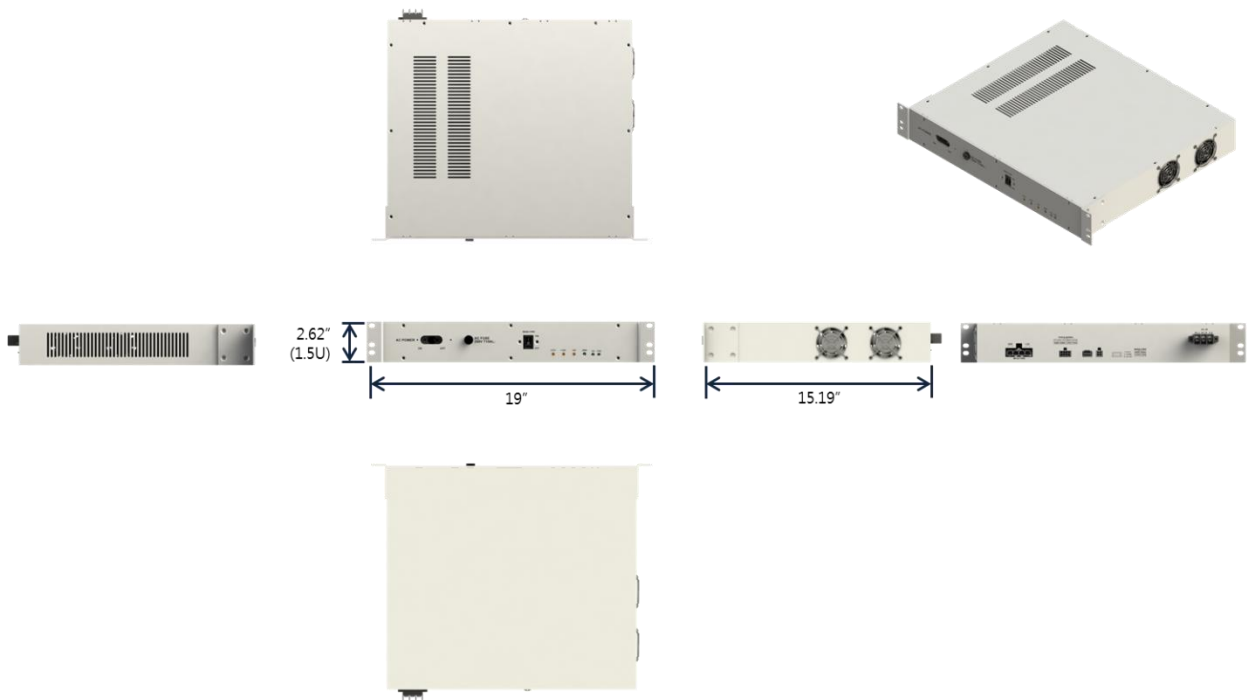

Figure 4. MPSU Configuration.

 **Warning**

When turning the power off for MPSU, turn off the AC switch configured on the front part of the MPSU, and separate the AC IN cable configured on the back part of the MPSU from the outlet.

3.4 MHU Configuration

The MHU is configured with modules like MDTU, MCPU, MITU. MHU is connected to the MDU with RF cable and connected to the DRU through fiber optic cable. Power is supplied from the MPSU, has AWG 6 ground terminal on the side for system grounding. Also, when using 19" outdoor enclosure it can be operated outdoors, and is designed to be small considering installation location space and installer convenience.

MHU functions can be explained as the following.

- Change IF signal received from the MDU into optic signal (Downlink)
- Change analog optic signal received from DRU into IF signal (Uplink)
- Analog Optic signal monitoring function through OTX/ORX alarm.
- Star-connection method through 8 optic branches.

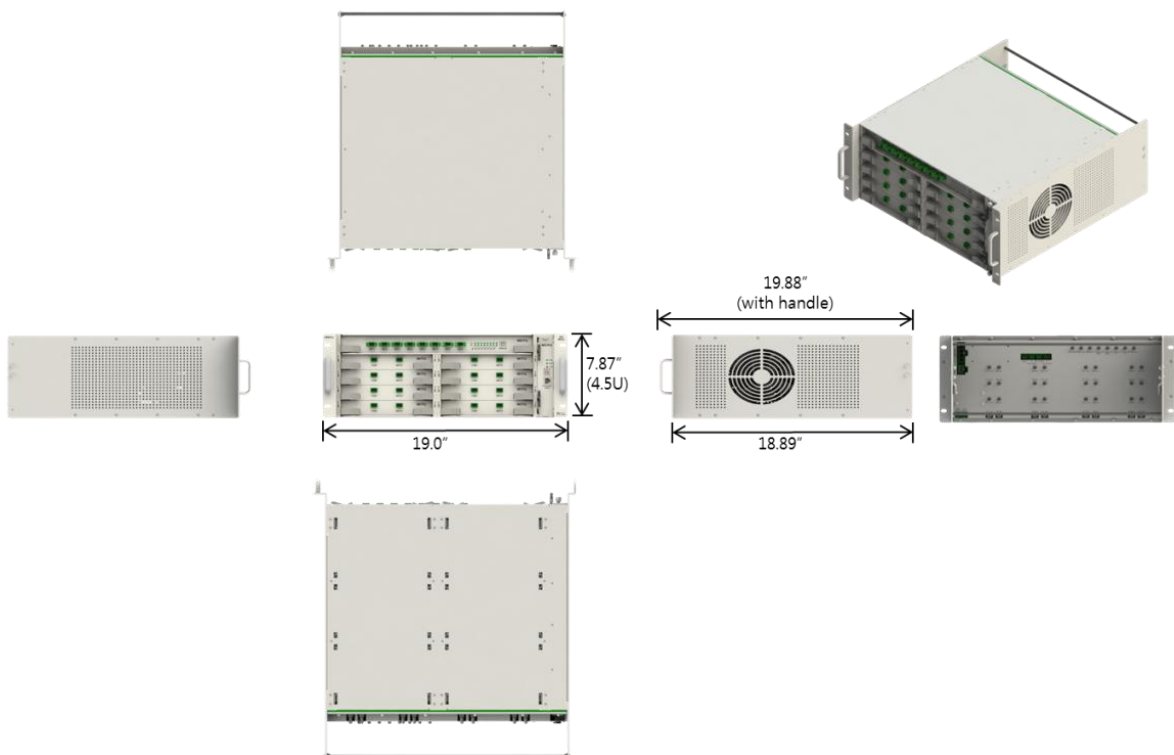

Figure 5. MHU Configuration.

3.5 MDU, MPSU, MHU Wiring

The MDU and MPSU, MHU are connected with multiple RF cables and harness. Especially when connecting power harness from the MPSU, it must be connected accurately. The MDU and MPSU, MHU cable connection is as below.

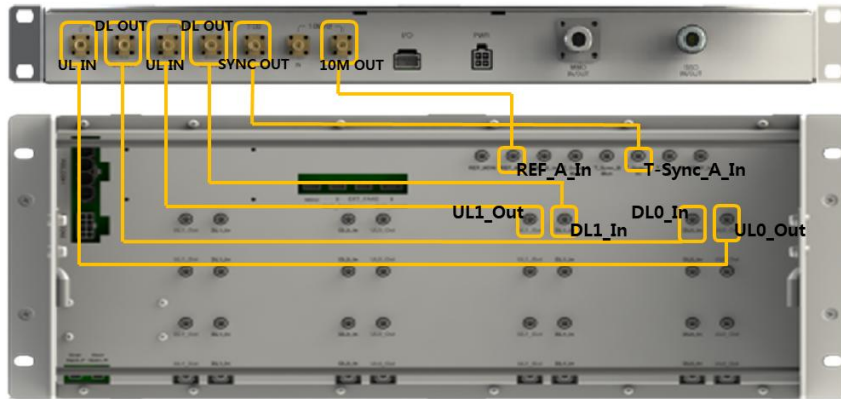

Figure 6. MDU, MPSU, MHU wiring method – RF Cable.

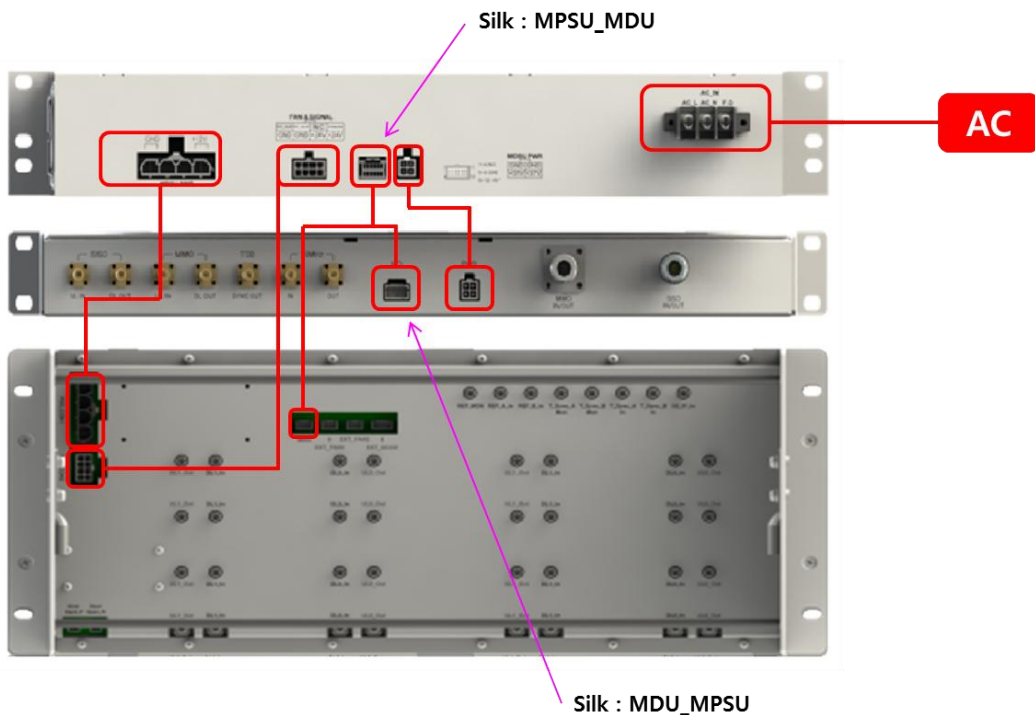

Figure 7. MDU, MPSU, MHU Wiring Method - Harness.

 **Warning**

When there is no divider between MDU and MHU, the MDU SISO UL IN / DL OUT, MIMO UL IN/DL OUT SMA port must be connected with 10dB attenuator.

 **Warning**

When connecting MPSU AC In cable, check AC_L, AC_N, F.G silk and connect accurately.

 **Warning**

When connecting MDU, MPSU, MHU data communication harness, you must check silk and connect as above picture. The harness connector with 'MPSU_MDU' silk must be connected to the MPSU, and the harness connector with 'MDU_MPSU' silk must be connected to the MDU.

 **Warning**

System GND must be connected a main protective earthing terminal in the equipment to an earth point in the building installation for protective earthing.

3.6 DRU Configuration

The DRU converts optic signal received from the MHU into IF signal and sends to mRU, or converts IF signal received from the mRU into analog optic signal and sends to MHU. DRU can be connected with up to 4 mRUs, each MIMO port is configured with Bias-T and supplies DC 37V to mRU. Also, sends CPU communication data and 10MHz Ref. signal, TDD sync signal, MIMO IF signal through MIMO port, and sends SISO IF signal through SISO port.

DU is created as enclosure for waterproof, and can be installed in-building/outdoors. Uses AC 120V power, and is configured with AWG 6 ground terminal for system grounding..

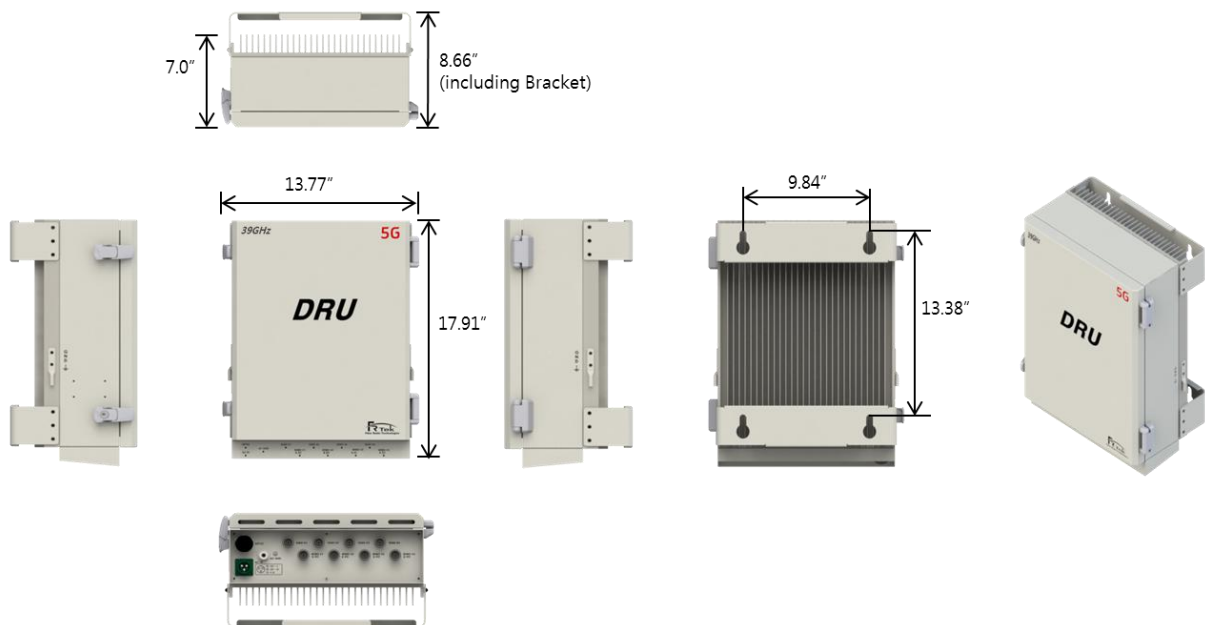

Figure 8. DRU Configuration.

Warning

When installing DRU, side lugs must be grounded and permanently connected.

3.7 mRU Configuration

The mRU is created as one enclosure, back side is configured with mounting bracket for wall installation. mRU converts IF frequency received from the DRU into 37GHz RF frequency and radiates 5G signal through antenna. (Downlink). Also, converts 37GHz RF signal received from UE into IF frequency and send to DRU through coaxial cable.

mRU is configured with mPSU, mBTU, mmWave Module, mCPU modules, and is supplied 37V power from the DRU through MIMO port. For system grounding side part is configured with AWG 6 ground terminal.

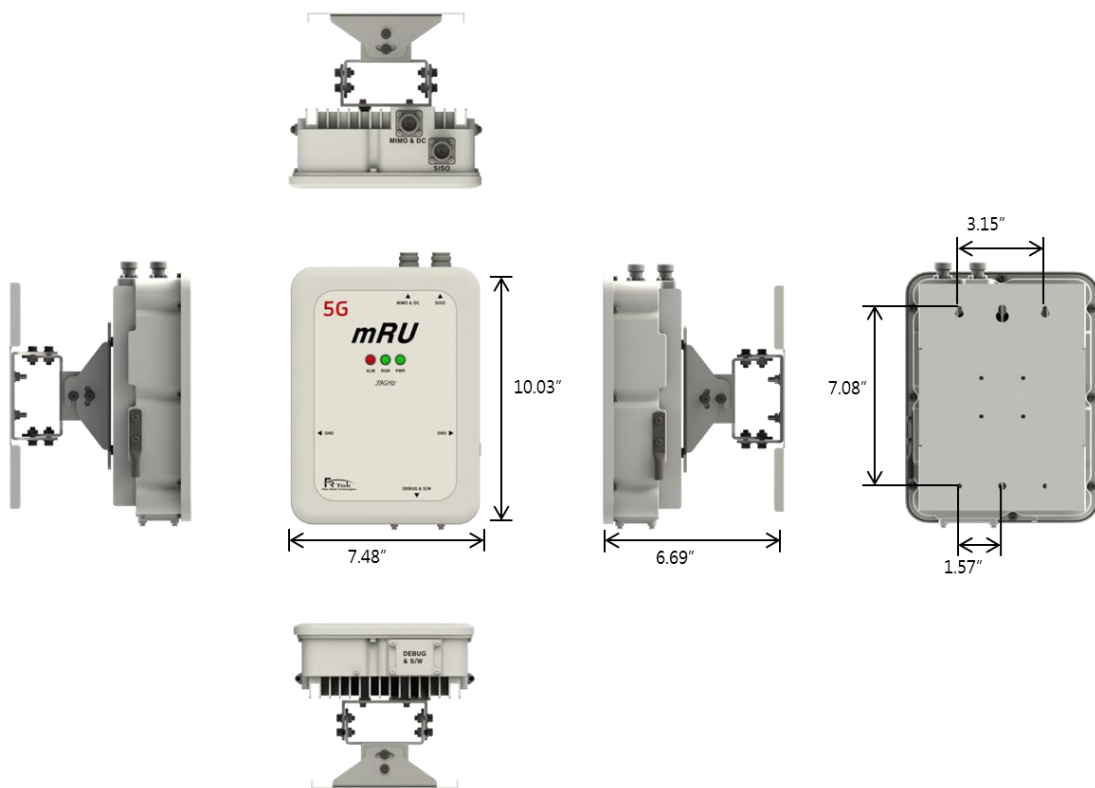

Figure 9. mRU Configuration.

Warning

DC 37V through Bias-T must be input through MIMO port, so SISO and MIMO must be accurately distinguished when connecting coaxial cable.

Chapter 4

System Specification

-
- 4.1 System Specification**
 - 4.2 Equipment Specification**
 - 4.3 Electrical Specification**
 - 4.4 Environmental Specification**
 - 4.5 Antenna Specification**

System Specification

4.1 System Specification

39GHz_L 5G Wireless Optical DAS is a 2X2 MIMO equipment for US 5G NR service, and is designed to operate on mmWave 37GHz frequency band with 1GHz bandwidth. This system satisfies the following functions and performances, and for items not mentioned satisfies 3GPP performance standard..

- This system DU transmit/receives RF signal wirelessly with base station, the mRU is installed on radio shaded areas to eliminate radio shading areas.
- The system wireless quality for 5G NR service satisfies at least 80% or more of base station wireless quality.
- When UE moves to allocated base station it supports continuous hand over.

4.1.1 Downlink Specification

Item	Specification	
	DU DL (Input Part)	mRU DL (Output Part)
Input Frequency	38.1GHz ±500MHz	IF ±500MHz
Output Frequency	IF ±500MHz	38.1GHz ±500MHz
Input Level	-55dBm ~ -35dBm	-
Output Level	-	+20dBm
ACLR	≥ 28dBc	

4.1.2 Uplink Specification

Item	Specification	
	DU UL (Output Part)	mRU UL (Input Part)
Input Frequency	IF ±500MHz	38.1GHz ±500MHz
Output Frequency	38.1GHz ±500MHz	IF ±500MHz
Input Level	-	-55dBm ~ -35dBm
Output Level	+20dBm	-
ACLR	≥ 28dBc	

4.2 Equipment Specification

4.2.1 Structure

Item	Type	Option
DU	Enclosure type	In-building/outdoor
MDU	19"Rack type	Indoor
MPSU	19"Rack type	Indoor
MHU	19"Rack type	Indoor
DRU	Enclosure type	In-building/outdoor
mRU	Enclosure type	In-building/outdoor

- Each unit of the 39GHz_L 5G Wireless Optical DAS is designed with consideration for installation location space and user convenience, and the design should be beautiful.
- 39GHz_L 5G Wireless Optical DAS MHU can use internal Fan.
- Each unit's components of the 39GHz_L 5G Wireless Optical DAS must be modularized, installed in a structure so each component can be easily mounted and detached between each other for easy replacement and maintenance.
- Each unit of the 39GHz_L 5G Wireless Optical DAS is designed so dust, contaminants and insects cannot penetrate.
- In order to prevent body damage during maintenance, all parts of the cabinet is smoothed out.

4.2.2 Manufacturing and Processing

- Sealing materials are strong on heat, and do not get torn or damaged by chemicals.
- Each unit's internal/external wiring of the 39GHz_L 5G Wireless Optical DAS is designed with lapping method or connector connection method, and can withstand vibration.
- Each unit's printed circuit board used for the components of the 39GHz_L 5G Wireless Optical DAS are made of glass epoxy resin or a more equivalent product, has beautiful soldering, has electrical insulation treatment to prevent corrosion and contamination and to reduce the insulation resistance between wires due to accumulation of moisture and dust.
- The internal, external surface of painted cabinets have the same color, the cabinet exterior is designed to withstand blistering, peeling and cracking for over 5 years.

4.2.3 Material and Component

- Passive devices used for each unit of the 39GHz_L 5G Wireless Optical DAS has stable characteristics on frequency and temperature change, and active devices are industrial or equivalent semiconductors, and integrated circuits are solidified devices.
- Wires used for each unit of the 39GHz_L 5G Wireless Optical DAS are flame-retardant coated wiring with sufficient current capacity and breakdown voltage.
- Coaxial cable for connecting each unit of the 39GHz_L 5G Wireless Optical DAS are aluminum or copper sheathed cables..
- All metals used for each unit of the 39GHz_L 5G Wireless Optical DAS are built to withstand not only common corrosion but also stress corrosion and cracking.
- The used plastic are insoluble in solvents, and is created to not change color, crack, or melt when exposed to ammonia..
- Plastic is created to not crack when exposed to materials used for cable production (ex : insulators, filling compound).
- The enclosure, component, PCB, solder, cable of each unit of the 39GHz_L 5G Wireless Optical DAS comply with RoHS.

4.3 Electrical Specification

- Power supplied to MPSU, DRU operates normally on commercial power supply (AC120/60Hz).
- There is overvoltage and over current protection function for the power supply.
- When after momentary power outage occurs, RF set value automatically returns to the status right before the power outage.
- Equipment grounding is located on both sides of the enclosure.
- All components used on 39GHz_L 5G Wireless Optical DAS satisfies EMI terms of FCC title 47, part 15, subject J, class A.
- Grounding strap to ground the grounding wire of #6AWG must be attached to the enclosure.

4.4 Environmental Specification

- No condensation traces may appear inside the unit when proceeding specified temperature and humidity test.
- It should be designed to prevent internal condensation and deterioration due to humidity and internal/external temperature difference.
- When proceeding specified vibration test, system performance and equipment damage should not occur.
- When proceeding specified waterproof test, there should be no trace of moisture penetration inside the unit.
- Environment test should be conducted in accordance with room temperature operation standard (indoor only, outdoor standard when using enclosure).
- Environment test item and method repetition period should follow operator environmental test procedure..

39GHz_L 5G Wireless Optical DAS main environment test conditions are as below.

Item		Apply condition	Performance request
Operation environment test	In-building	- Temperature : -10 ~ +50°C - Humidity : 0 ~ 90% RH	- Output change : within ±3dB - Enclosure inside/outside to have no issue
	Outdoor	- Temperature : -25 ~ +55°C - Humidity : 0 ~ 90% RH	- Output change : within ±3dB - Enclosure inside/outside to have no issue

Chapter 5

Local GUI(Graphical User Interface)

5.1 GUI Configuration

Local GUI(Graphical User Interface)

“ Chapter 5 is used to provide users operating the 39GHz_L 5G Wireless Optical DAS on product information and setting methods. The Repeater manager using the operation manual should have experience on repeater system structure operation and expert knowledge on repeating system. ”

- GUI program is created for system control and monitoring.
- GUI program uses USB-B type port configured on each equipment CPU for communication.
- User can control and monitor the entire system operation status through main screen of each unit.

5.1 GUI Configuration

5.1.1 DU Main Screen

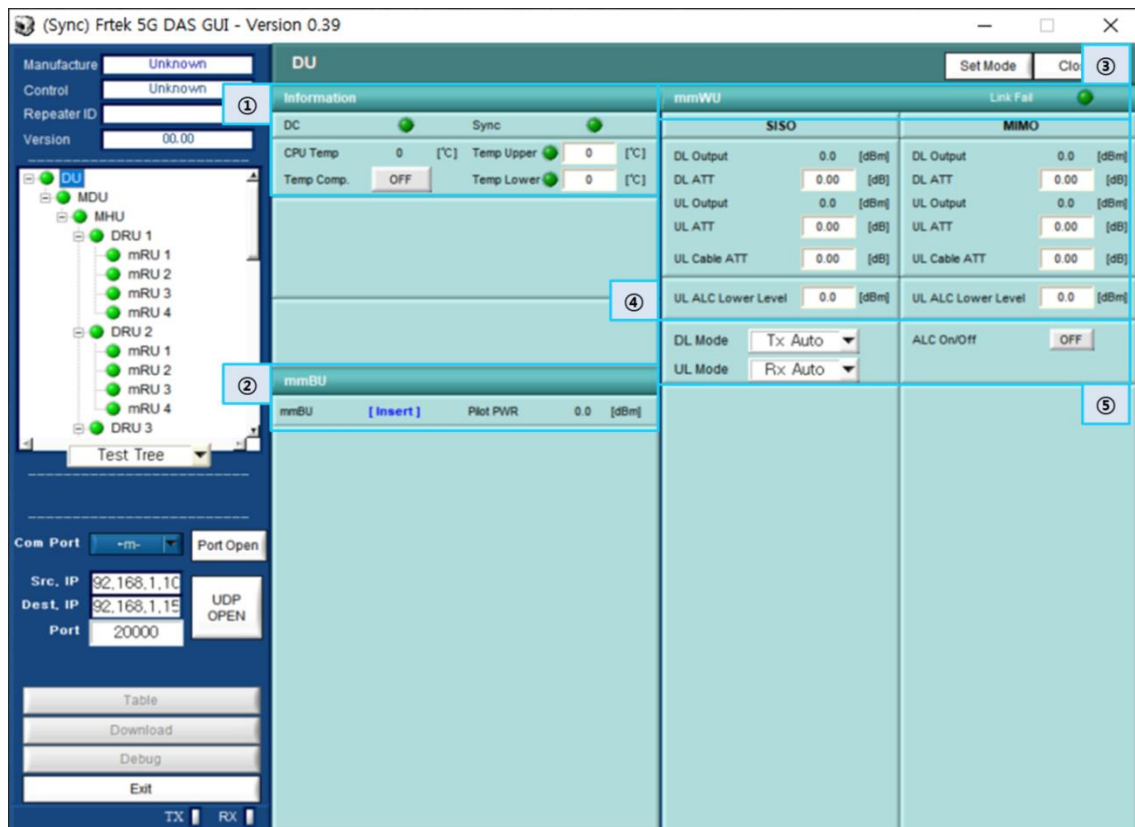

Figure 10. DU Main Screen.

① Information

This item is configured with 'DC alarm' that can monitor status of the DC 37V supplied through Bias-T. Also, it can monitor enclosure temperature status, and has 'Temp Comp' implemented which can set the temperature table input value applicability.

② mmBU

This item can monitor the status of the BTU within the DU. The BTU is a module that transmit/receives voltage from the Bias-T, MDU communication data, 10MHz Ref signal, TDD sync signal.

③ mmWU

This item can monitor the status of the mmWave module configured within the DU. It can monitor the communication status between CPU and mmWave module, and module insert status. Also, when the 10MHz Ref. signal is not applied normally the 'PLL Alarm' occurs, and when this 'PLL Alarm' occurs the 'Status' item alarm turns red.

④ RF Part

This item can monitor the 37GHz RF input signal and signal level each from the base station and MDU. Also it has threshold value setting item for 'ALC(Auto Level Control) function.

It is configured with an attenuator that can compensate the uplink loss of the cable connected with the DU and MDU, and can compensate up to 12dB.

⑤ Function

This item can on/off the 'ALC' function according to the detected input signal value and threshold value, and can set the TDD sync signal mode from the MDU.

- Auto : Set sync signal to 'Auto Mode' and switch.
- Tx CW : Output to low level to set sync signal as 'DL Fix Mode'.
- Rx CW : Output to high level to set sync signal as 'UL Fix Mode'.

5.1.2 MDU Main Screen

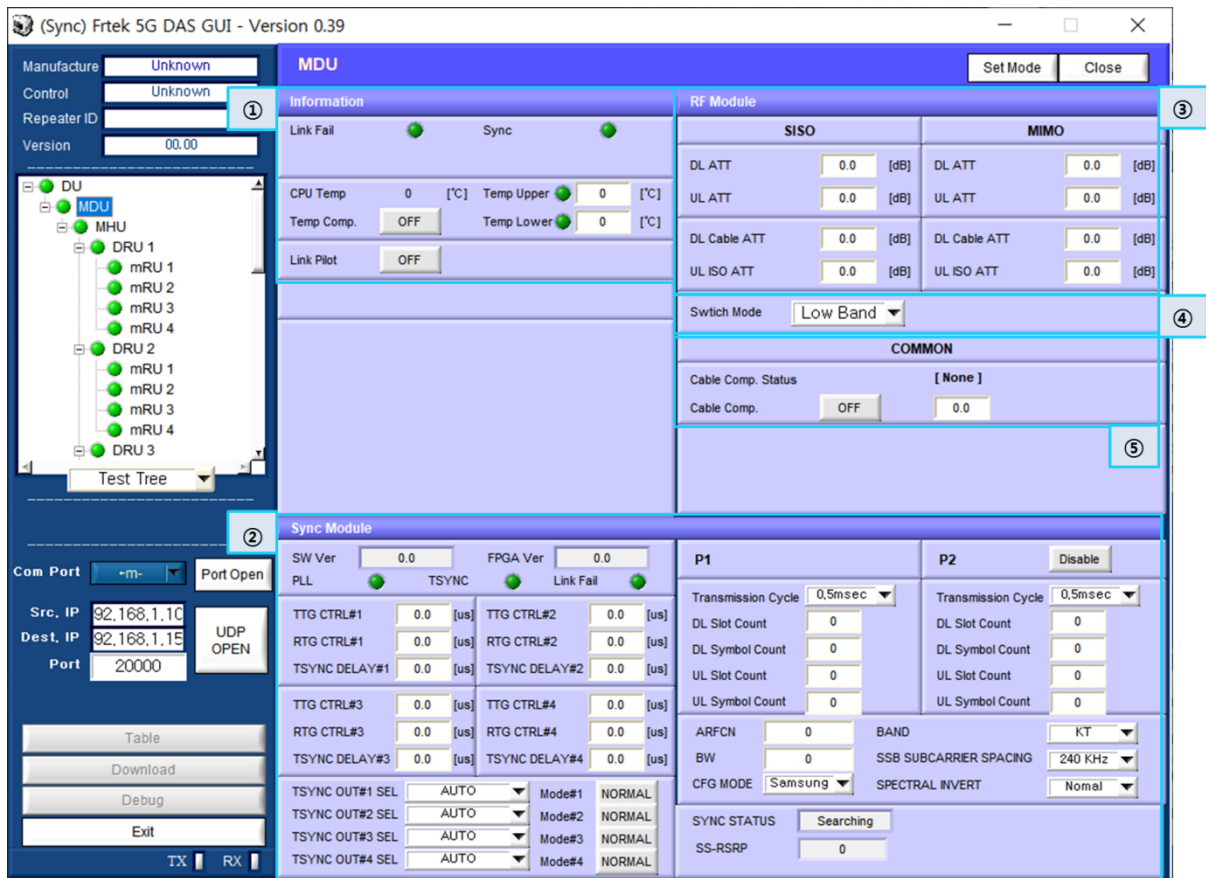

Figure 11. MDU Main Screen.

① Information

This item is configured with 'DC' alarm that can monitor status of the DC 37V supplied from the Bias-T, and 'Link Fail' alarm that can check the connection status with DU. Also, it can monitor enclosure temperature status, and is implemented with 'Temp Comp' item that can set the temperature table input value applicability.

On the item below 'Link Pilot' button is used form 'Cable Comp' function so the use does not control this item.

② TDD Module

This item can monitor status and control TDD sync module within the MDU. When sync module extracts the sync signal the 'TSYNC' alarm is cleared.

③ RF Part

This item monitors IF input signal and controls signal level from the DU and MHU. Also, it is configured with an attenuator that can compensate downlink loss of the cable connecting DU and MDU, and can compensate up to 12dB. And can adjust up to 10dB with attenuator to secure uplink isolation.

④ Switch Mode

This system can basically service all 1GHz bandwidth, but situation may occur of only servicing 'Low Band' or 'High Band'. This item is implemented for this situation.

- Bypass : Service all 1GHz bandwidth
- Low Band : Filter and service on low band frequency out of the 1GHz bandwidth
- High Band : Filter and service on high band frequency out of the 1GHz bandwidth

⑤ Cable Comp. Function

This item below has 'Cable Comp' function implemented. When turning this function on, cable compensate attenuator is automatically set to auto measure coaxial cable loss between connected DU and MDU.

5.1.3 MHU Main Screen

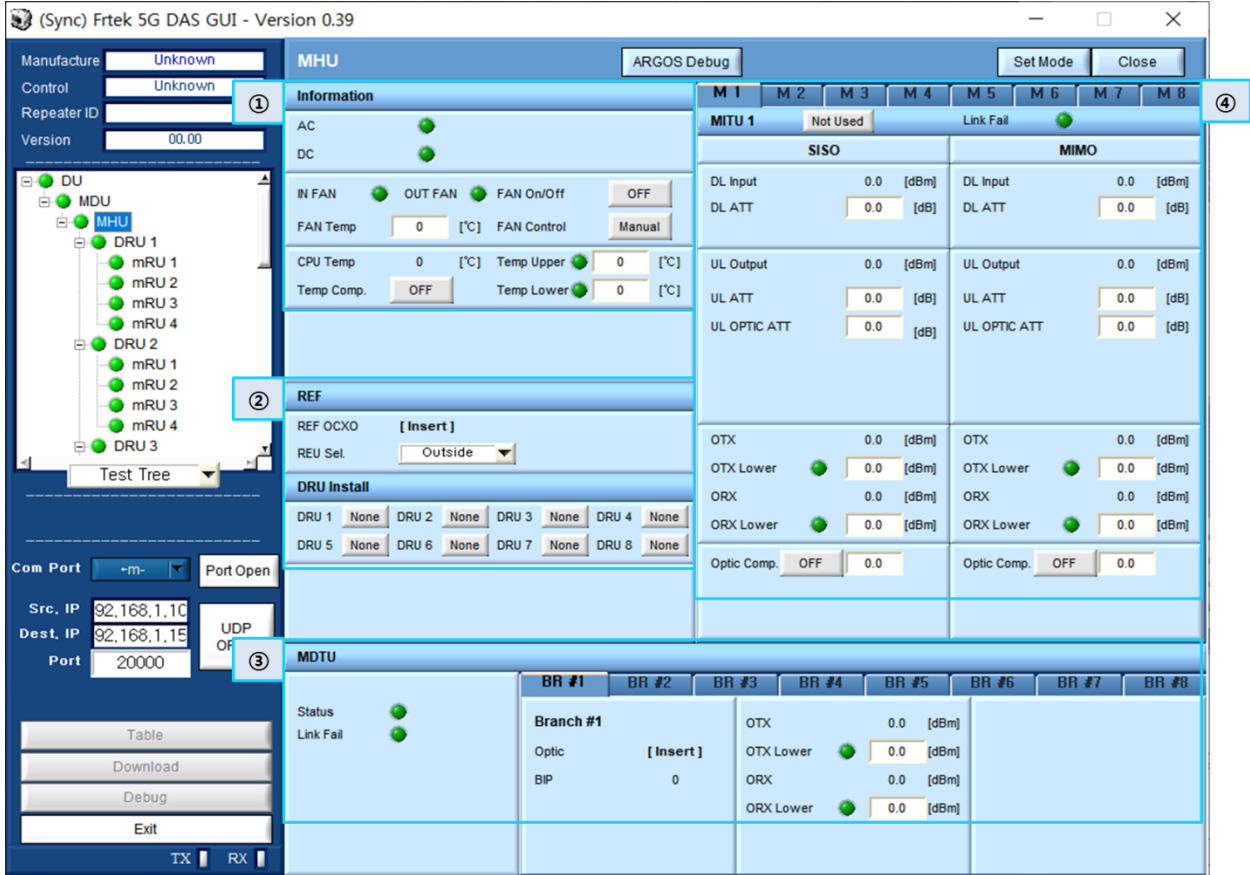

Figure 12. MHU Main Screen.

① Information

This item is configured with status monitor alarm of DC power from MHU and AC input power of MPSU, and is implemented with 'Temp Comp.' item that can monitor enclosure temperature status and temperature table input value applicability.

MCPU module is configured with fan, this item has the function to turn fan on/off or automatically turn on the fan when temperature.

② REF

This item can set installation status of the DRU connected to the 8-branch. When 2 DRUs are installed, set 'DRU 1' and 'DRU 2' into 'Install' and then you can check the DRU 1 and DRU 2 applied

on the 'GUI Tree'.

③ DTU

This item monitors overall status of the MDTU status. It can monitor status of 'OTX' and 'ORX' value and alarm setting per optic branch, and is configured with 'Link Fail' alarm to check MDTU 'Status' of communication status.

④ MITU

This item is configured with an attenuator that can monitor and set power level of the IF signal received from the MDU and DRU. Also, it is configured with 'OTX' alarm and 'ORX' alarm that can monitor status or strength of the converted analog optic signal transmit/reception.

Also, it is configured with an attenuator to compensate uplink loss of fiber optic cable, and implemented with 'Optic Comp.' function which is similar to 'Cable Comp.'. When turning this function on, cable compensate attenuator is automatically set by auto measuring fiber optic cable loss connected between MHU and DRU.

5.1.4 DRU Main Screen

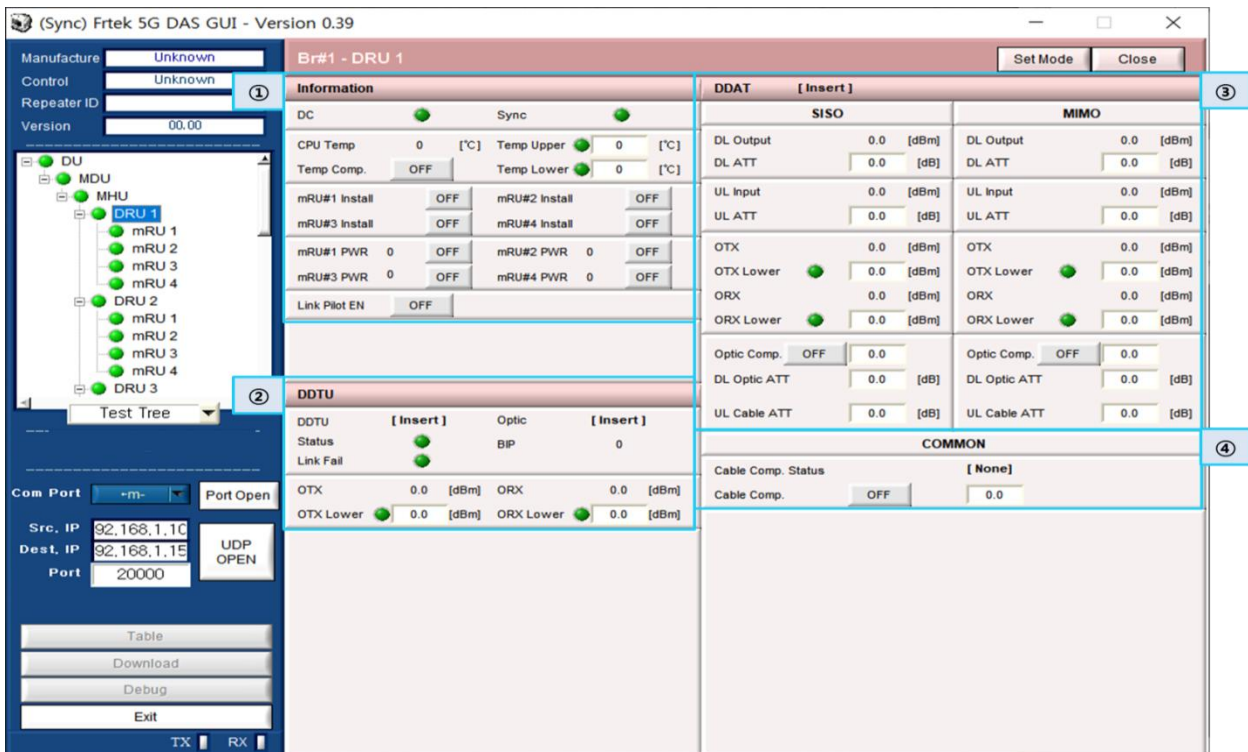

Figure 13. DRU Main Screen.

① **Information**

This item is configured with 'DC' alarm to monitor status of DC 37V supplied through the Bias-T, and is implemented with 'Temp Comp.' to monitor the enclosure temperature and set temperature table input value applicability. Also, it sets mRU status, and has Bias-T DC 37V on/off switch. When there are 2 mRUs connected in the system, put 'mRU#1 Install' and 'mRU#2 Install' on and then can check mRU 1 and mRU 2 applied on the 'GUI Tree'. Also when you turn 'mRU#1 Install' and 'mRU#2 Install' on and supply DC power to mRU, mRU will normally connect and you can check mRU 1 and mRU 2 status on the 'GUI Tree' as alarm clear(green).

This item below 'Link Pilot' button is used for 'Cable Comp.' function so user does not control this item.

② **DDTU**

This item can monitor overall status of DDTU status. It can monitor status and set alarm of connected optic branch 'OTX' and 'ORX' value, and is configured with 'Link Fail' alarm to check DDTU 'Status' or communication status..

③ **MITU**

This item is configured with an attenuator that can monitor IF signal strength or power level received from the MHU and mRU. Also it is configured with 'OTX' alarm and 'ORX' alarm to monitor strength and status of converted analog optic signal transmit/reception.

Also, it is configured with an attenuator to compensate downlink loss of fiber optic cable, and is implemented with same function on the DRU as the MHU 'Optic Comp.'. When turning this function on, cable compensate attenuator is automatically set by automatically measuring fiber optic cable loss connected between MHU and DRU.

④ **Cable Comp. Function**

This item is the same function as MDU 'Cable Comp' function. When turning this function on, cable compensate attenuator is automatically set by automatically measuring fiber optic cable loss

connected between DRU and mRU.

5.1.5 mRU Main Screen

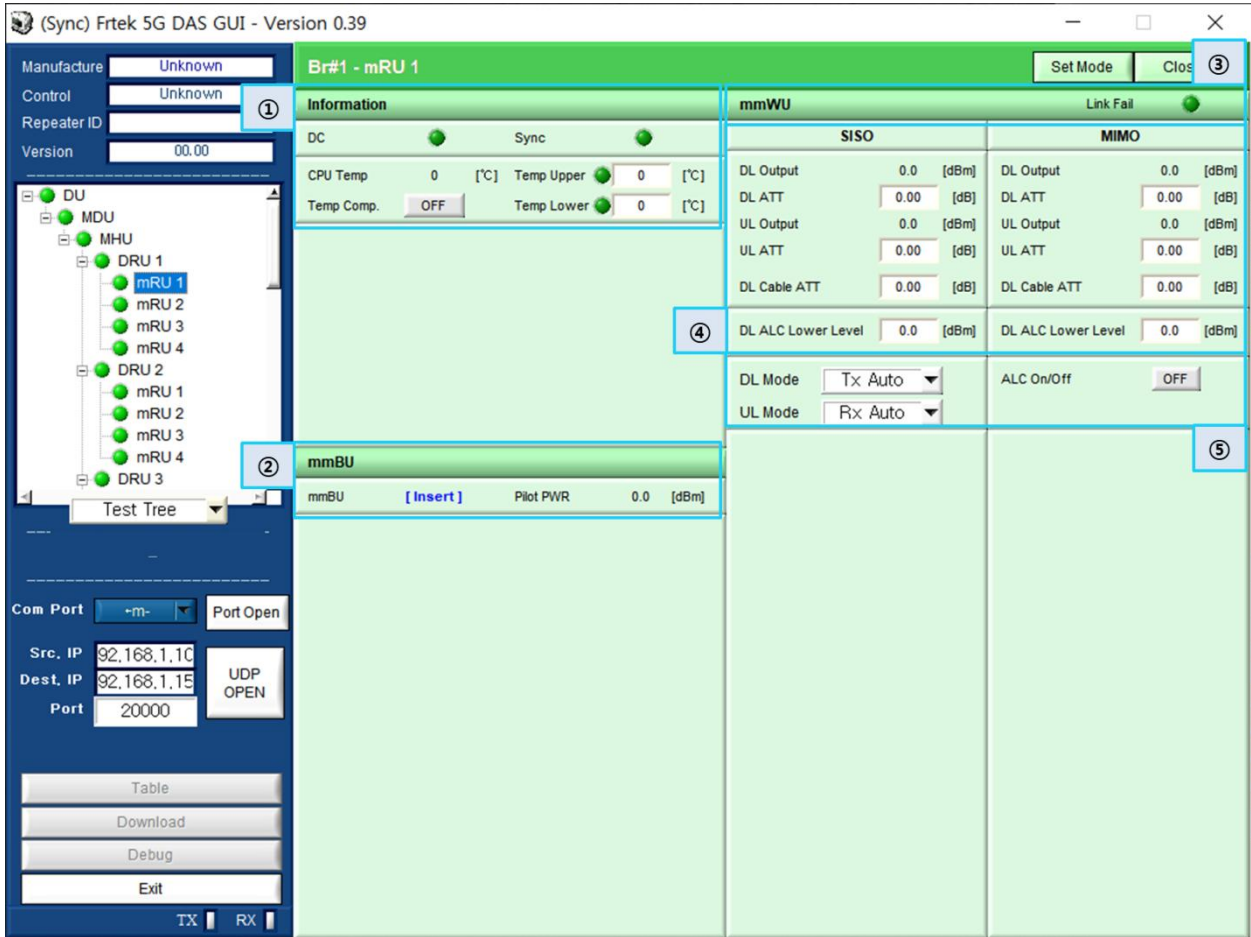

Figure 14. mRU Main Screen.

① Information

This item is configured with 'DC' alarm to monitor status of DC 37V supplied from Bias-T. Also, it is implemented with 'Temp Comp' to monitor enclosure temperature status, and set temperature table input value applicability.

② mmBU

This item can monitor status of BTU within mRU. BTU is a module that transmit/receives voltage from bias-T, DRU communication data, 10MHz Ref signal, TDD sync signal.

③ mmWU

This item can monitor status of mmWave module within DU. It can monitor communication status or module insert status between CPU and mmWave module. Also, when 10MHz Ref signal is not normal, the 'PLL' alarm within the mmWave module occurs, and when this 'PLL' alarm occurs the 'Status' item alarm turns red.

④ RF Part

This item can monitor RF input signal and control signal level received from the DRU and the UE. It is also configured with threshold value set item for 'ALC(Auto Level Control)' function.

Also, it is configured with an attenuator that can compensate cable downlink loss connected between mRU and DRU, and can compensate up to 12dB.

⑤ Function

This item can turn on/off 'ALC(Auto Level Control)' function according to the threshold value and detected input signal value, and can set TDD sync signal mode received from the DRU.

- Auto : Sets sync signal to 'Auto Mode' and switch.
- Tx CW : Output low level to set sync signal to 'DL Fix Mode'
- Rx CW : Output high level to set sync signal to 'UL Fix Mode'

39GHz_L 5G Wireless Optical DAS Operating Manual

Fiber Radio Technologies CO., LTD.
All rights reserved.

- Copyright © FRTEK Co., Ltd. All rights reserved.
- Without any authorization of FRTEK Co., Ltd., the disclosure, distribution, reproduction and reuse of all or part of the information in this manual to the 3rd party are strictly prohibited

