

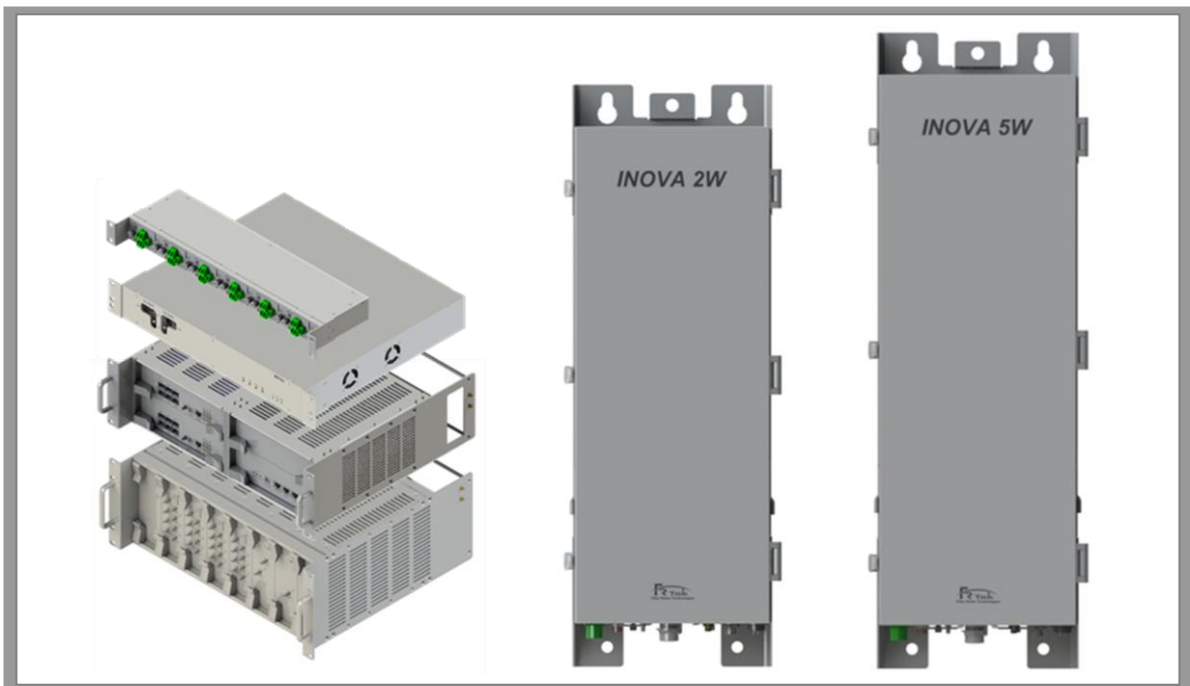

INOVA DAS Operating Manual



Document Reference

Company:	Fiber Radio Technologies
Version:	Ver 1.2
Document Status:	Release 1
Issue Date:	2018. 10.
Department:	R&D Group 2
Author Manager:	Jun Hyun, Lee

▪ **Copyright**

The copyright of this manual is from FRTek Co., Ltd.

This manual may not be reproduced, distributed, modified on any form without the consent of FRTek Co., Ltd

Unauthorized disclosure, distribution, copying or use of the information contained in this document in whole or in part without authority is strictly prohibited.

▪ **Trademark**

The trademarks mentioned in this manual are registered trademarks of the respective company.

Please read this service manual before installation and operation. Use the system only in accordance with contents of this manual.

- The specification and information regarding the products in this manual are subject to change due to updates to system functionality or system revision changes without notice. For the latest revision of this manual or for technical inquiries, please contact below :

Company Address : 181 Metro Drive, Suite 580, San Jose, CA 95110

Homepage : <http://www.frtek.com>

Contact for technical inquires or troubleshooting.

Telephone : 330-622-2911 or 510-390-1939

Revision History

Version	Issue Date	Details of Revision	Author	Authorizing Manager
V 1.0	18. 09. 12.	Original	Jun Hyun, Lee	
V 1.1	18. 10. 17.	1 st Revision	Jun Hyun, Lee	
V 1.2	18. 10. 22.	2 nd Revision	Jun Hyun, Lee	

This manual is produced by R&D Group 2 Printed in FRTek.

Contents

Chapter 1. Safety & Certification Notice	11
1.1 FCC Warning Statements	12
1.1.1 FCC Part 15.105 statement	12
1.1.2 FCC Part 15.21 statement	12
1.1.3 Health and Safety Warnings	12
1.2 Certification Notice	17
Chapter 2. System Overview.....	18
2.1 System Overview	19
2.1.1 Overview	19
2.1.2 INOVA DAS Design Considerations	20
2.2 System Network Configuration	22
Chapter 3. System Configuration.....	23
3.1 MHU Configuration.....	24
3.1.1 MWDM(MHU Wavelength Division Module) Figure and Configuration.....	24
3.1.2 MPSU(MHU Power Supply Unit) Figure and Configuration	26
3.1.3 MDRU(MHU Digital Reference Unit) Figure and Configuration	27
3.1.4 MBIU(MHU Baseband Interface Unit) Figure and Configuration	28
3.2 ROU 2W Configuration	30
3.3 ROU 5W Configuration	32
Chapter 4. System Specification	35
4.1 System Specification	36
4.1.1 System Specification per Frequency Band – 700MHz.....	36
4.1.2 System Specification per Frequency Band – 850MHz.....	37
4.1.3 System Specification per Frequency Band – 1.9GHz.....	38
4.1.4 System Specification per Frequency Band – 2.1GHz.....	39
4.1.5 System Specification per Frequency Band – 2.3GHz.....	40

4.1.6 System Specification per Frequency Band – 2.5GHz.....	41
4.1.7 System Specification per Frequency Band – 2.6GHz.....	42
4.2 Organization Specification.....	43
4.2.1 Structure and Type.....	43
4.2.2 Manufacturing and Processing.....	43
4.2.3 Materials and Components.....	44
4.3 Electrical Specification.....	44
4.4 Environmental Specification.....	45
Chapter 5. System Installation.....	46
5.1 Tools.....	47
5.2 MHU Installation.....	48
5.2.1 Product Installation.....	48
5.2.2 Ground Cable Connection.....	50
5.2.3 Power Cable Connection.....	51
5.3 ROU 2W Installation.....	52
5.3.1 Product Installation.....	52
5.3.2 Ground Cable Connection.....	54
5.3.3 Antenna Connection.....	54
5.3.4 Power Cable Connection.....	55
5.3.5 Optic Cable Connection.....	55
5.4 ROU 5W Installation.....	56
5.4.1 Product Installation.....	56
5.4.2 Ground Cable Connection.....	57
5.4.3 Antenna Connection.....	58
5.4.4 Power Cable Connection.....	59
5.4.5 Optic Cable Connection.....	59
5.5 2.5GHz, 2.6GHz Setting Method.....	60
Chapter 6. Local GUI(Graphical User Interface).....	62
6.1 Local GUI Main Screen.....	63
6.2 Local GUI MHU Screen.....	67
6.2.1 MHU Main Screen.....	67

6.2.2 MHU Main Screen per Frequency	69
6.3 Local GUI ROU Screen	76
6.3.1 ROU Main Screen	76
6.3.2 MHU Main Screen per Frequency	78
 Chapter 7. Alarm and Corrective Action	 87
7.1 Alarm Phenomenon and Solution	88
7.1.1 AC Alarm (MHU, ROU)	88
7.1.2 LD Alarm (MHU, ROU)	88
7.1.3 PD Alarm (MHU, ROU)	88
7.1.4 TX/RX PLL Alarm (MHU, ROU)	89
7.1.5 Internal FAN Alarm (MHU, ROU).....	89
7.1.6 External FAN Alarm (ROU).....	89
7.1.7 TX S/D(High) Alarm (ROU)	89
7.1.8 DTU Alarm (MHU, ROU).....	90
7.1.9 DTU Link Fail Alarm (MHU, ROU).....	90
7.1.10 VSWR Alarm (ROU).....	90
7.1.11 Over Temp (ROU)	91

Figures

Figure 1. Basic Network Configuration.	22
Figure 2. Optional Extended Network Configuration.....	22
Figure 3. MWDM.....	25
Figure 4. MWDM Port Configuration.	25
Figure 5. MPSU.....	26
Figure 6. MPSU Port Configuration.	26
Figure 7. MDRU.....	27
Figure 8. MDRU Port Configuration.....	28
Figure 9. MBIU.....	29
Figure 10. MBIU Port Configuration.	29
Figure 11. ROU 2W.	31
Figure 12. ROU 2W Port Configuration.....	31
Figure 13. ROU 5W.	33
Figure 14. ROU 5W Port Configuration.....	34
Figure 15. Within 19" Rack, MHU installation.	49
Figure 16. MHU Cable Connection.	49
Figure 17. MHU-MDRU, MBIU Ground Cable Connection.	50
Figure 18. Ground Cable Information.....	51
Figure 19. MHU-MPSU Power Cable.....	52
Figure 20. ROU 2W needed Door space.....	52
Figure 21. ROU 2W Anchor Bolt Assemble.	53
Figure 22. ROU 2W Wall Installation Assemble.....	53
Figure 23. ROU 2W Ground Cable Connection.....	54
Figure 24. ROU 2W Antenna and Cable Connection.	54
Figure 25. ROU 2W Power Cable.	55

Figure 26. ROU 2W Optic Cable Connection.....	55
Figure 27. ROU 5W Needed Door Space.	56
Figure 28. ROU 5W Anchor Bolt Assemble.	56
Figure 29. ROU 5W Wall Face Installation Assemble.....	57
Figure 30. ROU 5W Ground Cable Connection.....	57
Figure 31. ROU 5W Antenna and Cable Connection.	58
Figure 32. ROU 5W Power Cable.	59
Figure 33. ROU 5W Optic Cable Connection.....	59
Figure 34. ROU 5W Waterproof Type Optic Connector.....	60
Figure 35. For 2.5GHz Service, Insert 2.5GHz MRFU/RRFU Module.....	60
Figure 36. For 2.6GHz Service, Insert 2.6GHz MRFU/RRFU Module.....	61
Figure 37. Local GUI initial screen.....	63
Figure 38. Local GUI Main Screen.	64
Figure 39. Spectrum Analyzer Window Screen.....	65
Figure 40. Time Advance Window Screen.	65
Figure 41. Reset Window Screen.	66
Figure 42. Download Window Screen.....	66
Figure 43. Local GUI MHU Screen.	67
Figure 44. MHU Install Screen.....	68
Figure 45. 700MHz MHU Band Information Screen.	69
Figure 46. 850MHz MHU Band Information Screen.	70
Figure 47. 1.9GHz MHU Band Information Screen.	71
Figure 48. 2.1GHz MHU Band Information Screen.	72
Figure 49. 2.3GHz MHU Band Information Screen.	73
Figure 50. 2.5GHz MHU Band Information Screen.	74
Figure 51. 2.6GHz MHU Band Information Screen.	75
Figure 52. Local GUI ROU Screen.	76
Figure 53. ROU PIMD Screen.....	77

Figure 54. 700MHz ROU Band Information Screen.	78
Figure 55. 850MHz ROU Band Information Screen.	79
Figure 56. 1.9GHz ROU Band Information Screen.	80
Figure 57. 2.1GHz ROU Band Information Screen.	81
Figure 58. 2.3GHz ROU Band Information Screen.	83
Figure 59. 2.5GHz ROU Band Information Screen.	84
Figure 60. 2.6GHz ROU Band Information Screen.	85

Used Abbreviations

DAS	D istributed A ntenna S ystem
EMS	E lement M anagement S ystem
MHU	M aster H ub U nit
ROU	R emote O ptic U nit
PSU	P ower S upply U nit
HPA	H igh P ower A mp
SFP	T he S mall form- F actor P luggable
GUI	G raphical U ser I nterface
SMR	S pecialized M obile R adio
TBD	T o B e D etermined
USB	U niversal S erial B us
VSWR	V oltage S tanding W ave R atio
ACLR	A djacent C hannel L eakage P ower R atio
ALC	A uto L evel C ontrol
EVM	E rror V ector M agnitude
3GPP	3 rd G eneration P artnership P roject

Chapter 1

Safety & Certification Notice

-
- 1.1 FCC Warning Statements**
 - 1.2 Certification Notice**

Safety & Certification Notice

1.1 FCC Warning Statements

1.1.1 FCC Part 15.105 statement

- This equipment has been tested and found to comply with the limits for a Class A digital device.
- These limits are designed to provide reasonable protection against harmful interference when the equipment is operated in a commercial environment.
- This equipment generates, uses, and can radiate radio frequency energy and, if not installed and used in accordance with the instruction manual, may cause harmful interference to radio communications.
- Operation of this equipment in a residential area is likely to cause harmful interference in which case the user will be required to correct the interference at his own expense.

1.1.2 FCC Part 15.21 statement

- Any changes or modifications not expressly approved by the party responsible for compliance could void the user's authority to operate this equipment

1.1.3 Health and Safety Warnings

- This system can be operated by approved operator only and operator should observe the warning sentence of operating manual.
- The operator who can install, operate or handle related system service should acquaint themselves this manual.
- Control and configuration of this system should be set up according to purpose of use (Refer to the manufacturer's product information), it has to be satisfied prescribed request items.
- Operator should turn off the main power switch before installing system, maintenance and related works.
- If this product is disassembled intentionally, it can bring electric shock, breakdown, malfunction and static with losing life and property. Do not disassemble, repair and modify product.
- This system cover should be (door) securely fastened in open position, e.g. by tying it up, at outdoor

- work in order to prevent door from slamming due to wind causing bodily harm or damage.
- Due to power dissipation, the remote unit may reach a very high temperature. Do not operate this equipment on or close to flammable materials. Use caution when servicing the unit.
 - Use this equipment only for the purpose specified by the manufacturer. Do not carry out any modifications or fit any spare parts, which are not sold or recommended by the manufacturer. This could cause fires, electric shock or other injuries.
 - Read and obey all the warning labels attached to the unit. Make sure that all warning labels are kept in a legible condition.
 - It is the responsibility of the network provider to implement prevention measures to avoid health hazards associated with radiation from the antenna(s) connected to the unit.
 - Do not use any solvents, chemicals, or cleaning solutions containing alcohol, ammonia, or abrasives.
 - Although the remote unit is internally protected against overvoltage, it is strongly recommended to ground (earth) the antenna cables close to the repeater's antenna connectors for protection against atmospheric discharge.

- Home/ personal use are prohibited

 **Warning**

Obey all general and regional installation and safety regulations relating to work on high voltage installations, as well as regulations covering correct use of tools and personal protective equipment.

 **Warning**

Use of unauthorized antennas, cables, and /or coupling devices not conforming with ERP/EIRP and /or indoor-only restrictions is prohibited.

 **Warning**

Laser radiation! Do not stare into the beam; do not view it directly or with optical instruments.



Please be informed that the temperature of the surface is too high. Please be careful. The label is attached to the front of the equipment and the PSU (Power Supply Unit).

• **INFORMATION TO THE USER**

The head end unit must always be connected to the Base Station using a direct cabled connection. This system has not been approved for use with a wireless connection via server antenna to the base station.



When external fan installed in the bottom of the enclosure operate, please keep at regular intervals to prevent danger. If you want to detach it, you must have access after operation of fan off.

• **[FCC] BOOSTER WARNING LABEL**

WARNING. This is **NOT** a **CONSUMER** device. It is designed for installation by **FCC LICENSEES** and **QUALIFIED INSTALLERS**. You **MUST** have an **FCC LICENSE** or express consent of an FCC License to operate this device. Unauthorized use may result in significant forfeiture penalties, including penalties in excess of \$100,000 for each continuing violation.

• **[IC] BOOSTER WARNING LABEL**

WARNING: This is **NOT** a **CONSUMER** device. It is designed for installation by an installer approved by an **ISED licensee**. You **MUST** have an **ISED LICENCE** or the express consent of an ISED licensee to operate this device.

• **PART 27.5**

Antennas must be installed in accordance with FCC requirement. The height of the antenna above average terrain (HAAT) must not exceed limit in the following table.

Antennas must be installed in accordance with FCC 27.50 and 24, and SRSP 503, SRSP 510, SRSP 513 and SRSP 517. With 17dBi gain antennas the height of the antenna above average terrain (HAAT) must not exceed 4127.8m (INOVA 2W) and 2618.019m (INOVA 5W)

• **NOTICE**

This equipment's simple information are :

- Gain : 53dB@ROU2W, 57dB@ROU5W
- Bandwidth : 28MHz@700M, 32MHz@850M, 65MHz@1.9G, 70MHz@2.1G, 10MHz@2.3G, 195M@2.5G, 70MHz@2.6G
- Output Power : 33dB@ROU2W, 37dB@ROU5W
- Input / Output impedances : 50 ohm

The Manufacturer's rated output power of this equipment is for single carrier operation. For situations when multiple carrier signals are present, the rating would have to be reduced by 3.5 dB, especially where the output signal is re-radiated and can cause interference to adjacent band users. This power reduction is to be by means of input power or gain reduction and not by an attenuator at the output of the device.

• **[FCC] RF Exposure Statement**

The antenna(s) must be installed such that a minimum separation distance of at least 1.5 m (For INOVA 2W) or 2.5 m (For INOVA 5W) is maintained between the radiator (antenna) and all persons at all times. This device must not be co-located or operating in conjunction with any other antenna or transmitter.

• **[IC] RSS-GEN, Sec. 7.1.2 – (transmitters)**

Under Industry Canada regulations, this radio transmitter may only operate using an antenna of a type and maximum (or lesser) gain approved for the transmitter by Industry Canada. To reduce potential radio interference to other users, the antenna type and its gain should be so chosen that the equivalent isotropically radiated power (e.i.r.p.) is not more than that necessary for successful communication.

Conformément à la réglementation d'Industrie Canada, le présent émetteur radio peut fonctionner avec une antenne d'un type et d'un gain maximal (ou inférieur) approuvé pour l'émetteur par Industrie Canada.

Dans le but de réduire les risques de brouillage radioélectrique à l'intention des autres utilisateurs, il faut choisir le type d'antenne et son gain de sorte que la puissance isotrope rayonnée équivalente (p.i.r.e.) ne dépasse pas l'intensité nécessaire à l'établissement d'une communication satisfaisante.

- **RSS-GEN, Sec. 7.1.2 – (detachable antennas)**

This radio transmitter (identify the device by certification number, or model number if Category II) has been approved by Industry Canada to operate with the antenna types listed below with the maximum permissible gain and required antenna impedance for each antenna type indicated. Antenna types not included in this list, having a gain greater than the maximum gain indicated for that type, are strictly prohibited for use with this device.

Le présent émetteur radio (identifier le dispositif par son numéro de certification ou son numéro de modèle s'il fait partie du matériel de catégorie I) a été approuvé par Industrie Canada pour fonctionner avec les types d'antenne énumérés ci-dessous et ayant un gain admissible maximal et l'impédance requise pour chaque type d'antenne. Les types d'antenne non inclus dans cette liste, ou dont le gain est supérieur au gain maximal indiqué, sont strictement interdits pour l'exploitation de l'émetteur.

- **RF Radiation Exposure**

This equipment complies with RF radiation exposure limits set forth for an uncontrolled environment. This equipment should be installed and operated with a minimum distance of 1.5 m (For INOVA 2W) or 2.5 m (For INOVA 5W) between the radiator and your body. This transmitter must not be co-located or operating in conjunction with any other antenna or transmitter. RF exposure will be addressed at time of installation and the use of higher gain antennas require larger separation distances.

- **RSS-102 RF Exposure**

L'antenne (ou les antennes) doit être installée de façon à maintenir à tout instant une distance minimum de au moins 1.5 m (For INOVA 2W) or 2.5 m (For INOVA 5W) entre la source de radiation (l'antenne) et toute personne physique.

Cet appareil ne doit pas être installé ou utilisé en conjonction avec une autre antenne ou émetteur.

1.2 Certification Notice

Specification or recommendation about Antennas is not available or not mention in this manual. As per default antennas, cables or coupling devices, contact www.frtek.com for further information.

For PLUGGABLE EQUIPMENT, the socket-outlet shall be installed near the equipment and shall be easily accessible.

- **FCC** : This equipment complies with the applicable sections of Title 47 CFR Parts 15,22,24 and 27.5
- **UL** : This equipment complies with UL Standard for safety for information technology equipment, including electrical business equipment.
- **FDA/CDRH** : This equipment uses a LASER according to FDA/CDRH Rules. This product conforms to all applicable standards of 21 CFR Chapter 1, Subchapter J, Part 1040.

Chapter 2

System Overview

-
- 2.1 **System Overview**
 - 2.2 **System Network Configuration**

System Overview

2.1 System Overview

2.1.1 Overview

INOVA DAS is a system that can provide high quality telecommunication quality and data telecommunication service both in-building and outdoor. Also, this system is a DAS(Distributed Antenna System) system, a digital system capable of accommodating a plurality of frequency bands, available for public and private facilities.

INOVA DAS system can be installed in :

- Shopping Malls
- Hotels
- Campus
- Airports
- Subways
- Stadiums and convention centers, etc

INOVA DAS helps improve poor telecommunication in-building/outdoor wireless environments. This system provides telecommunication service to every corner of the building, and allows the user to use telecommunication service regardless of the location. Also, INOVA DAS supports worldwide telecommunication standards and public interface protocols.

System capable frequencies :

- 700MHz(LTE)
- 850MHz(CDMA, UMTS, LTE)
- 1.9GHz(UMTS, LTE)
- 2.1GHz(UMTS, LTE)
- 2.3GHz(LTE)
- 2.5GHz(TD-LTE) or 2.6GHz(LTE)

INOVA DAS is configured with standardized modules. The coverage of specific frequency band can be ensured by mounting the unit module of the frequency. Also, since multiple signals can be transmitted through optic cable, additional hardware modification is not needed.

The main characteristics and features of INOVA DAS can be summarized as below.

- Scalability
 - Supports optic fiber port.
 - Star or cascade structure of network configuration is available.
 - in-building or outdoor service is available.
 - EMS support of remote control/monitoring for all network configured MHU and ROU.
- Structure
 - Modular frequency upgrade.
 - Plug-in type module.
- Multi-band, multi-operator support
 - One ROU supports up to 6 frequency band service.
 - 2.6GHz frequency band service for Canada operators available.
 - Multi-operator support for one frequency band available.
- Low OPEX / CAPEX
 - Miniaturized design.
 - Easy installation and maintenance.
- Technology improvements
 - RF direct conversion technology by applying RF 1Chip.
 - Sectorization function for Alpha or Beta sector service.
 - 1Gbps Ethernet telecommunication function available for various applications.
 - Node Isolation function implementation to prevent service disconnection of lower node. (ROU)

2.1.2 INOVA DAS Design Considerations

INOVA DAS is configured as below, and the model name is as the following.

INOVA DAS	Model Name	Type	Remark
MHU	FR-RLWFMHUUC	19" Rack type	
ROU 2W	FR-RLWFDO33UC	Enclosure type	
ROU 5W	FR-RLWFDO37UC	Enclosure type	

INOVA DAS is a digital optic repeater system capable of multi-band, multi-operator, and can extend wireless service for in-building and outdoor areas. This system can accommodate up to 6 bands. It is designed to support 700MHz(28MHz) LTE service, 850MHz(32MHz) CDMA & UMTS & LTE service, 1.9GHz (65MHz) UMTS & LTE service, 2.1GHz(70MHz) UMTS & LTE service, 2.3GHz(10MHz) LTE service, 2.5GHz(195MHz) TD-LTE service or 2.6GHz(70MHz) LTE service.

Service Band		Single	Extend	Remark
ROU 2W/5W	700MHz	○	○	
	850MHz	○	○	
	1.9GHz	○	○	
	2.1GHz	○	○	
	2.3GHz	○	○	
	2.5GHz or 2.6GHz	○	○	USA : 2.5GHz support Canada : 2.6GHz support

INOVA DAS is configured with MWDM, MPSU, MDRU, MBIU, each unit is connected with Harness, RF cable, and optic cable. Each component is modularized, and can be easily mounted/dismounted, designed for simple module replacement and maintenance. Also, each unit is designed to withstand vibration test standard (IEC 60068-2-6:2007), and ROU 5W is designed for outdoor use with structure (IP66) to block dust, pollutant and insects.

Item	MHU	ROU 2W	ROU 5W
Input Power	88V~132V (60Hz)	88V~132V (60Hz)	88V~132V (60Hz)
Interface(Input)	RF	Optic	Optic
Interface(Output)	Optic	RF	RF
Service Capability	CDMA, UMTS, LTE, TD-LTE	CDMA, UMTS, LTE, TD-LTE	CDMA, UMTS, LTE, TD-LTE
Type	In-building	In-building	In-building/outdoor
Cascade Function	X	8	8

2.2 System Network Configuration

INOVA DAS basic network configuration and optical extend configuration is as below picture.

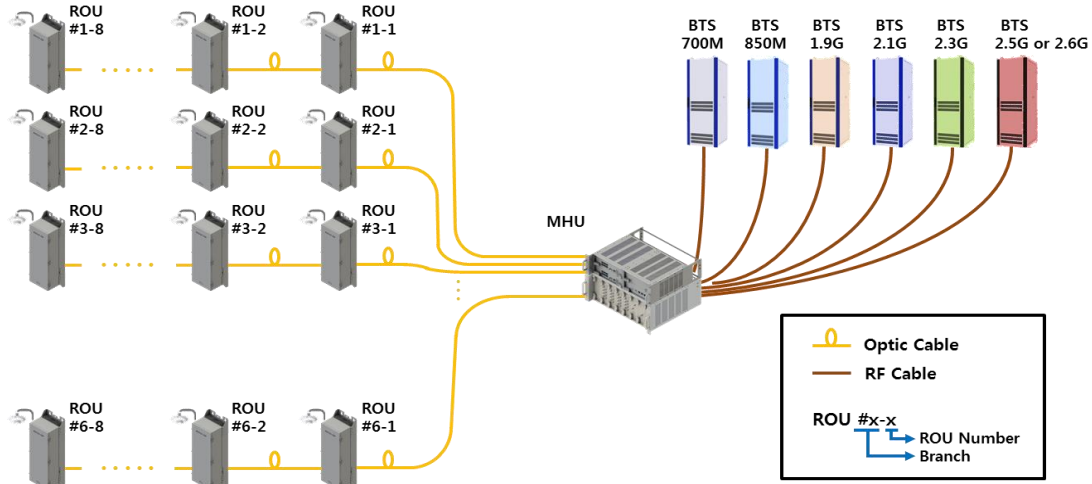

Figure 1. Basic Network Configuration.

The MHU is connected to the base station with RF cable, and the lower ROU equipment is connected with optic cable. Each branch of the MHU can be operated by cascade connection with each 8 ROUs, and 1 MHU can connect up to 48 ROUs.

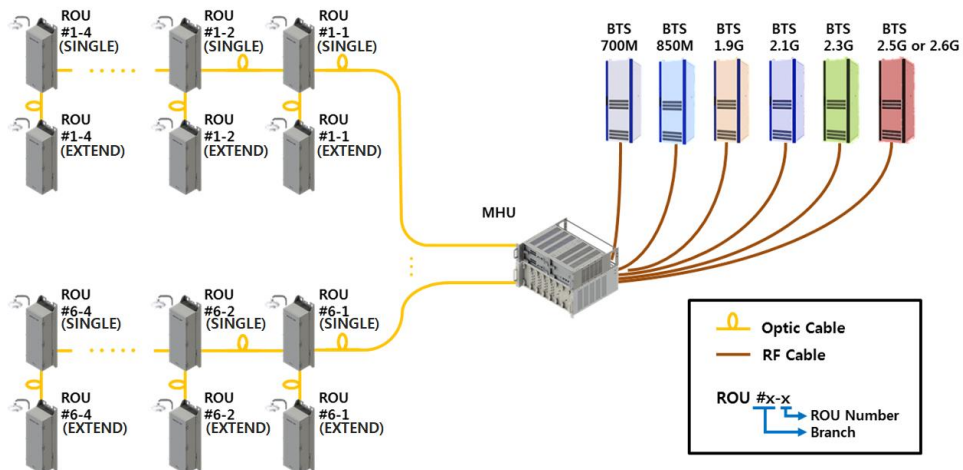

Figure 2. Optical Extended Network Configuration.

For service extension, extended ROU is connected by optic cable with Single ROU(Main), one branch can operate up to 8 ROUs, so up to 4 stages of cascade is available for extend configuration.

Chapter 3

System Configuration

-
- 3.1 MHU Configuration**
 - 3.2 ROU 2W Configuration**
 - 3.3 ROU 5W Configuration**

System Configuration

3.1 MHU Configuration

MHU is configured with MWDM(MHU Wavelength Division Module), MPSU(MHU Power Supply Unit), MDRU(MHU Digital Reference Unit), MBIU(MHU Baseband Interface Unit), base station is connected by wire and lower ROUs are connected through optic cable. The power of MDRU and MBIU, which are MHU's module components, is supplied by MPSU, and AWG 6 ground terminal is configured on the side for system grounding. Also, when using 19" external enclosure, the structure is designed to operate outdoors, and for the installation site and convenience of the operator, the equipment is designed as small as possible.

MHU functions can be simply described as the following.

- RF signal received from the base station converted into digital optic signal and transmitted. (Downlink)
- Digital optic signal received from ROU converted into RF signal and transmitted. (Uplink)
- 700MHz, 850MHz, 1.9GHz, 2.1GHz, 2.3GHz, 2.5GHz or 2.6GHz service support.
- extension function support for all frequencies through additional MDTU and MBIU.
- 10MHz clock supply function. (Basic: external 10MHz, option: internal 10MHz)
- 2.5GHz TDD synchronization signal supply function. (Basic: external TDD Sync, option: internal TDD Sync)
- 1Gbps Ethernet port implementation for various use.

MHU basically has single as main. When only single service is needed, one MDTU of MDRU is attached for single service, and only one set of MBIU is configured for service. On the other hand, when extended is configured, 2 MDTUs of MDRU are attached and 2 sets of MBIUs are configured.

3.1.1 MWDM (MHU Wavelength Division Module) Figure and Configuration

MWDM is a module for sectorization function, and can be configured up to 6 WDMs. Each optic branch is configured with an optic connector that is connected with alpha-sector MHU, an optic connector that is connected with beta-sector MHU, and an optic connector that can transmit to lower ROU with 4 optic signals.

Below picture shows the MWDM figure.

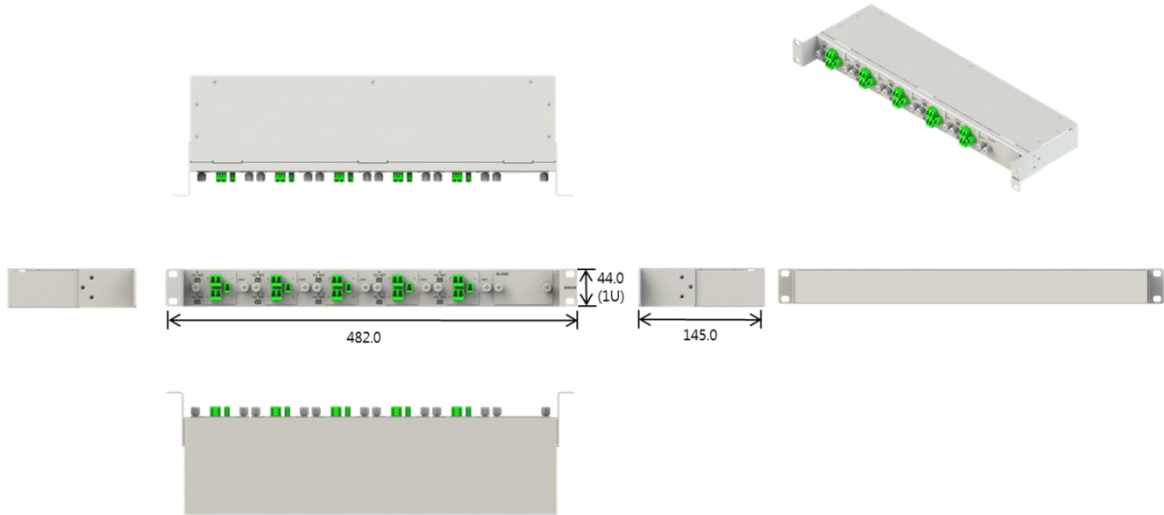

Figure 3. MWDM.

Item	Content	Remark
Size	19" 1U	
Weight	Approx. 4kg	
Input Interface	Alpha/Beta Single Optic 12C Alpha/Beta Extend Optic 12C	
Output Interface	Optic 6C	

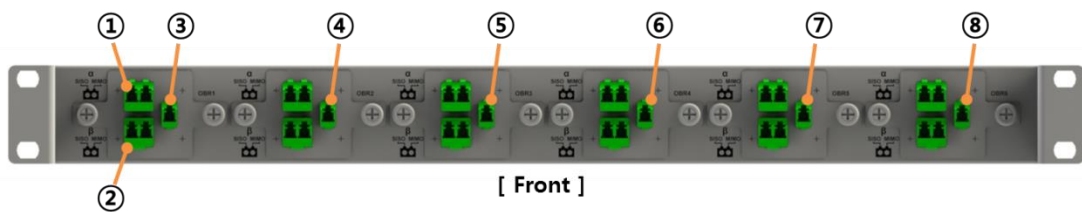

Figure 4. MWDM Port Configuration.

No	Content
①	Alpha-sector Single and Extend MDTU optic signal receive/transmit port
②	Beta-sector Single and Extend MDTU optic signal receive/transmit port
③~⑧	Optic Branch 1 st ~ 6 th port connecting to lower ROU

3.1.2 MPSU(MHU Power Supply Unit) Figure and Configuration

MPSU supplies AC 120V from external distribution board and supplies power to MDRU and MBIU, which are units of the MHU. Below picture shows the MPSU figure.

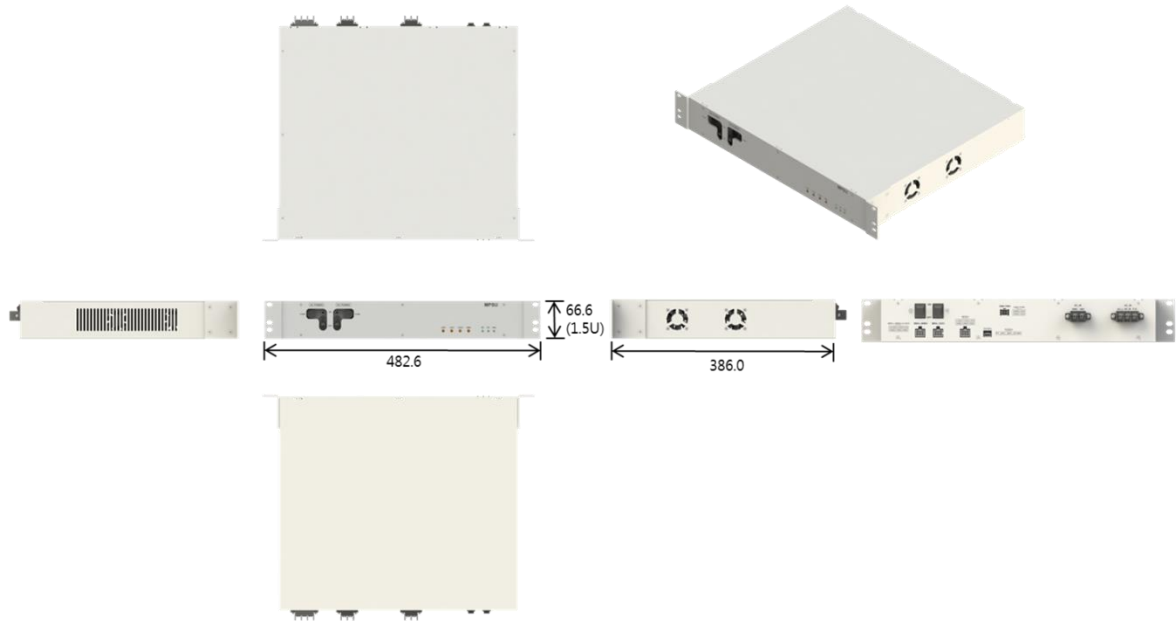

Figure 5. MPSU.

Item	Content	Remark
Size	19" 1.5U	
Weight	Approx. 9kg	
Input power	AC 120V (60Hz), DC -48V	
Output power	DC +5.6V, +12V, +24V	

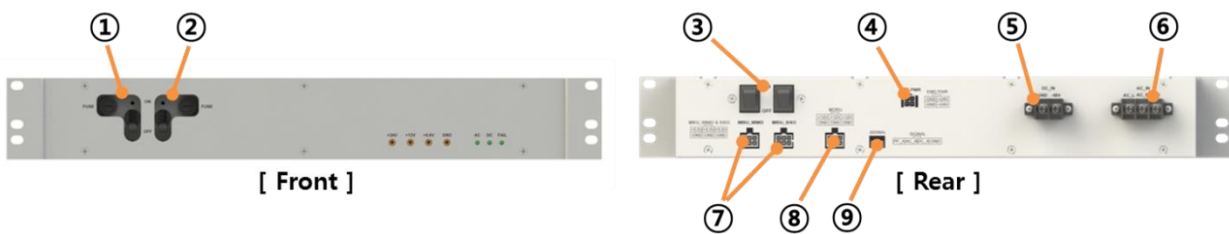

Figure 6. MPSU Port Configuration.

No	Content
①	AC power ON/OFF switch (AC 120V, 60Hz)
②	DC power ON/OFF switch (DC -48V)
③	single MBIU and Extend MBIU power switch (DC +5.6V)
④	EMS power supply port (DC+24V)
⑤	DC power supply port (DC -48V)
⑥	MPSU AC power port (AC 120V, 60Hz)
⑦	MBIU power supply port
⑧	MDRU power supply port (DC +12V)
⑨	PSU status alarm (AC, DC, FAN alarm) port

3.1.3 MDRU (MHU Digital Reference Unit) Figure and Configuration

MDRU is configured with MCPMU, OCXO modules. MDTU slot is configured with a total of 2, basically uses the one slot on top, and both MDTU slots are inserted when ROU is extended. OCXO module autonomously supplies 10MHz reference signals, and when 10MHz reference signal is supplied externally OCXO module may not be configured. MCPMU is a module for status monitoring and control of MHU and ROU, service status can be controlled through GIU.

Below picture shows the MDRU figure.

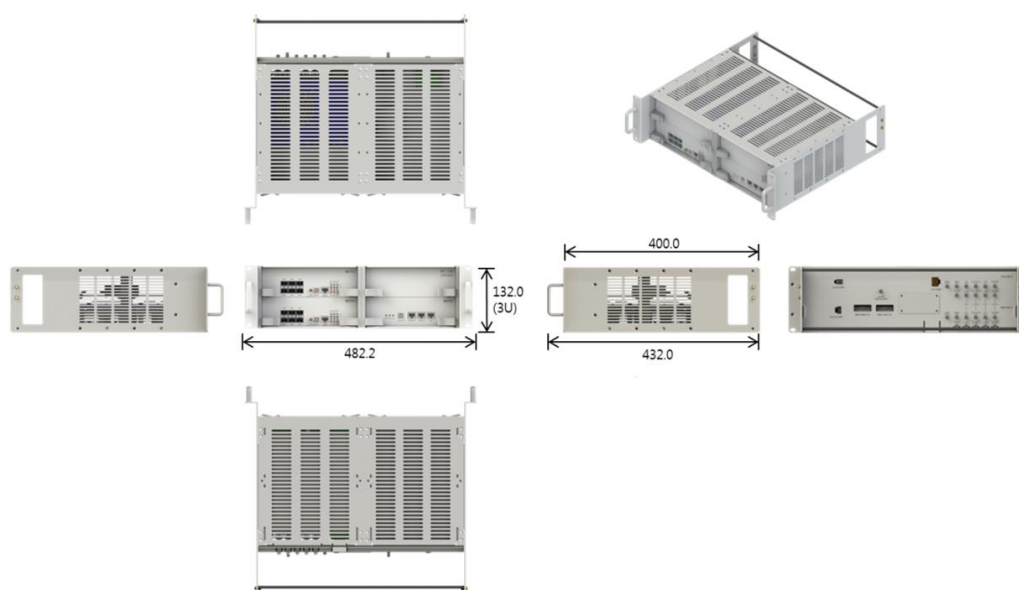

Figure 7. MDRU.

Item	Content	Remark
Size	19" 3U	
Weight	Approx. 13kg	
Input Power	DC +5.6V, +12V	
Input Interface	Analog RF Signal	
Output Interface	single Optic 6C, Extend Optic 6C	Optic 6C @MDTU 1EA

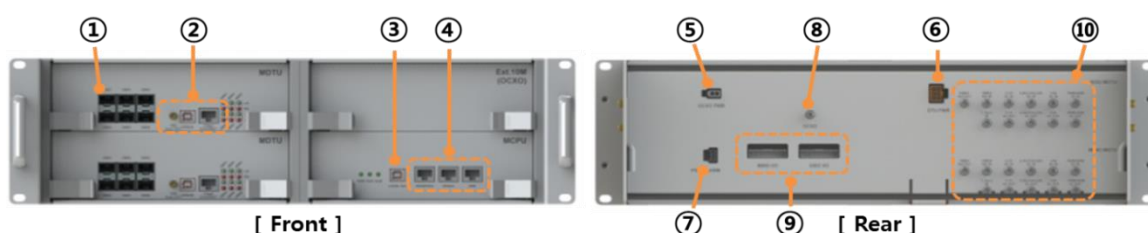

Figure 8. MDRU Port Configuration.

No	Port	Content
①	Optic module port	Slot to insert optic module for optic telecommunication with ROU
②	MDTU port	TDD Sync. Output port, Debug port for GUI connection, 1Gbps port
③	GUI port	Debug port for GUI connection
④	MCPU port	Port for Web GUI connection, Ethernet port for EMS connection, spare port
⑤	DC +5.6V port	Power port connecting with MPSU (DC +5.6V)
⑥	DC +12V port	Power port connecting with MPSU (DC +12V)
⑦	PSU alarm port	MPSU Alarm port connecting with MPSU
⑧	10M Ref. port	RF port with output of 10M reference signal created at internal OCXO unit
⑨	UART port	UART port connecting with MBIU for GUI control
⑩	RF port	RF port connecting with MBIU (top: single MBIU connection, below: Extend MBIU connection)

3.1.4 MBIU (MHU Baseband Interface Unit) Figure and Configuration

MBIU is configured with RF module for each frequency band, and 700MHz, 850MHz, 1.9GHz, 2.1GHz, 2.3GHz MRFU (MHU RF Unit) is basically inserted. For the last MRFU, US inserts 2.5GHz MRFU and Canada inserts 2.6GHz MRFU.

1.9GHz and 2.1GHz MRFU of MBIU is connected to MDTU through RF cable. However, 700MHz and

850MHz are combined into one signal through combiner and connected to MDTU, 2.3GHz and 2.5GHz or 2.3GHz and 2.6GHz are also combined into one signal through combiner and connected to MDTU. Below picture shows the MBIU figure.

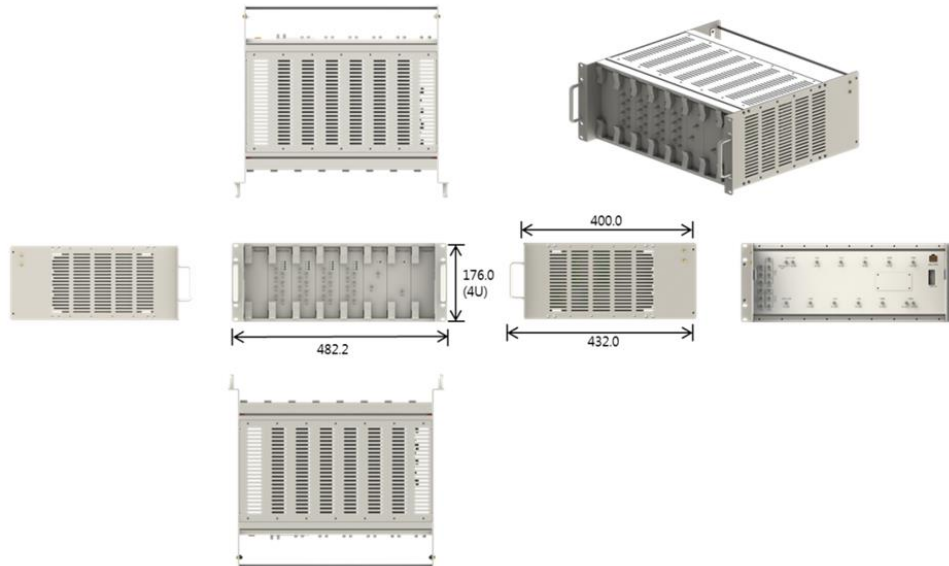

Figure 9. MBIU.

Item	Content	Remark
Size	19" 4U	
Weight	Approx. 20kg	
Input Power	DC +5.6V	
Input Interface	Analog RF Signal	
Output Interface	Analog RF Signal	

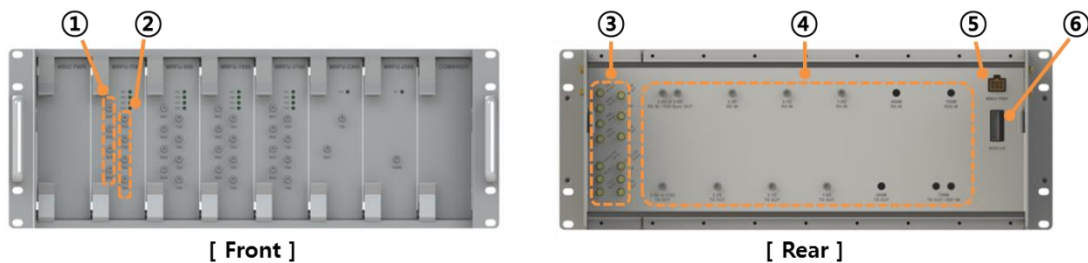

Figure 10. MBIU Port Configuration.

No	Port	Content
①	TX port	TX port that receives signal from base station

②	RX port	RX port that receives signal from base station
③	Combiner port	700M&850M Combiner T/RX port and 2.3G&2.5/2.6G Combiner T/RX port
④	MRFU T/RX Port	TX/RX port of MRFU for each frequency band
⑤	MBIU power port	Port that receives power from MPSU (DC +5.6V)
⑥	MBIU UART port	Port connected to MCPU for each band control and monitoring

3.2 ROU 2W Configuration

ROU 2W is a structure that can be used in-building, enclosure is minimized considering installation space and operator's convenience. ROU 2W is configured with RPSU, RDTU, RCPU, 6 RRFUs(ROU RF unit) and supports up to 6 frequency bands.

ROU functions can be simply described as the following.

- Function to convert digital optic signal into RF signal, amplify and service through antenna. (Downlink)
- Function to convert RF signal into digital signal, and transmit to upper equipment. (Uplink)
- 700MHz, 850MHz, 1.9GHz, 2.1GHz, 2.3GHz, 2.5GHz or 2.6GHz service support.
- Node Isolation function and System Delay Equalizer function
- 1Gbps Ethernet port implementation for various use.

Below picture shows the ROU 2W figure.

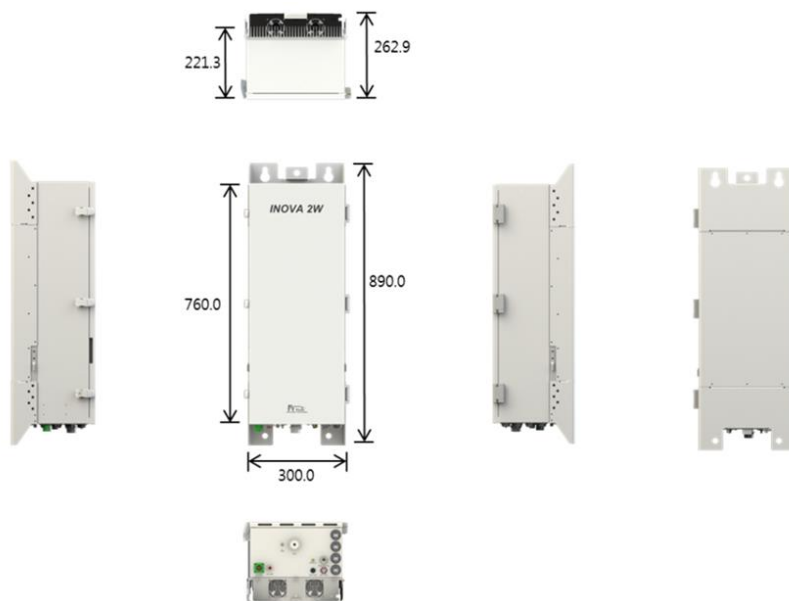

Figure 11. ROU 2W.

Item	Content	Remark
Size	300 * 890 * 262.9 (W * H * D)	Including bracket
Weight	Approx. 39kg	
Input power	AC 120V (60Hz)	
Environment	In-building type	

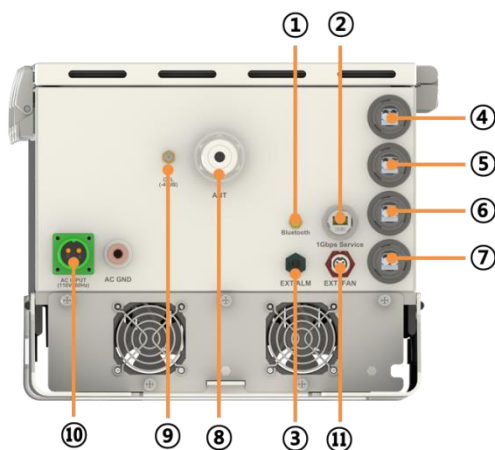

Figure 12. ROU 2W Port Configuration.

No	Content
①	Bluetooth antenna port
②	1Gbps service port
③	External alarm port
④	MHU/ROU Single OPTIC port
⑤	MHU/ROU Extend OPTIC port
⑥	Reserved OPTIC port (Single Sectorization or 5G interlink)
⑦	Reserved OPTIC port (Extend Sectorization or 5G interlink)
⑧	ANT port
⑨	Coupling port
⑩	AC power input port
⑪	EXT FAN input port

3.3 ROU 5W Configuration

ROU 5W is a structure for in-building and outdoor, minimized enclosure considering installation space and operator's convenience. ROU 5W, same as ROU 2W, is configured with RPSU, RDTU, RCPU, 6 RRFUs(ROU RF unit), and supports up to 6 frequency bands. Also, functions of ROU 5W are the same as ROU 2W.

Below picture shows the ROU 5W figure.

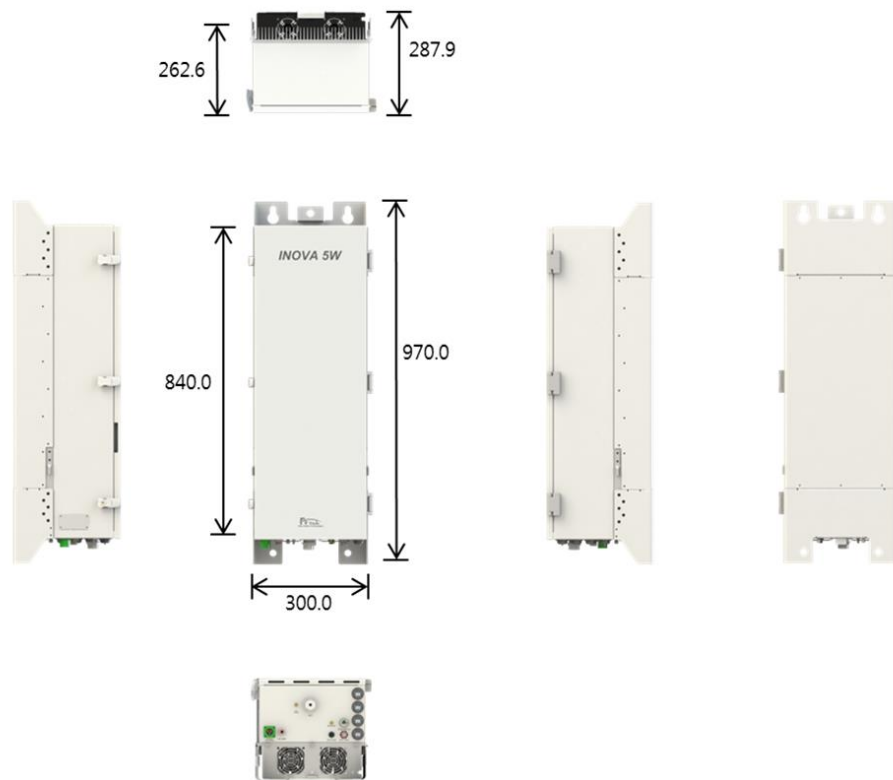

Figure 13. ROU 5W.

Item	Content	Remark
Size	300 * 970 * 287.9 (W * H * D)	Including bracket
Weight	Approx. 50kg	
Input power	AC 120V (60Hz)	
Environment	In-building/outdoor type	

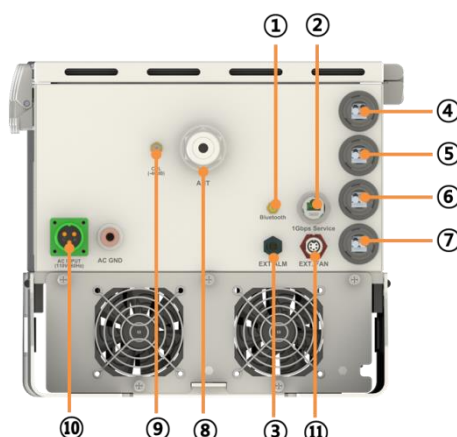

Figure 14. ROU 5W Port Configuration.

No	Content
①	Bluetooth antenna port
②	1Gbps service port
③	External alarm port
④	MHU/ROU Single OPTIC port
⑤	MHU/ROU Extend OPTIC port
⑥	Reserved OPTIC port (Single Sectorization or 5G interlink)
⑦	Reserved OPTIC port (Extend Sectorization or 5G interlink)
⑧	ANT port
⑨	Coupling port
⑩	AC power input port
⑪	EXT FAN input port

Warning

Maximum output for ROU 5W differs from each frequency band, should be operated with reference to system specification.

Warning

When HPA is ON through ROU GUI for service, connection status between ROU output port and antenna must be checked.

Chapter 4

System Specification

-
- 4.1 System Specification**
 - 4.2 Organization Specification**
 - 4.3 Electrical Specification**
 - 4.4 Environmental Specification**

System Specification

4.1 System Specification

INOVA DAS is an US/Canada DAS equipment, supports 700MHz, 850MHz, 1.9GHz, 2.1GHz, 2.3GHz, 2.5GHz or 2.6GHz frequency bands, and all frequency bands are designed for ROU extension. INOVA DAS satisfies the following function and performance characteristics, and specifications not mentioned all satisfy the functions and performance requests of "3GPP TS25.104", "3GPP TS25.106", "3GPP TS 36.104". Also, ROU 2W and ROU 5W are designed as the same specification, except for the forward direction output level.

INOVA DAS has the basic functions of the following.

- MHU is connected with base station by RF(wire) access, and connected to ROU with one optic cable. ROU is installed in shaded area to eliminate radio shaded areas. (Optic: 10Gbps support available)
- Wireless quality of CDMA, UMTS, LTE, TD-LTE service is equal as base station wireless quality.
- When moving terminal enters neighboring base station, this system supports continuous handover.

4.1.1 System Specification per Frequency Band – 700MHz

- Frequency characteristics

Item		Performance requirements	Remark
Frequency Band	Forward direction	728 ~ 756MHz	BW : 28MHz LTE service support
	Reverse direction	698 ~ 716MHz 777 ~ 786MHz	

- Input/output characteristics

Item		Performance requirements	Remark
Output level	ROU 2W forward direction	+30dBm/Total	1W@ROU 2W 2W@ROU 5W
	ROU 5W forward direction	+33dBm/Total	
	Reverse direction	0dBm/Total	

- Noise figure and spurious emission characteristics

Item		Performance requirements	Remark
System noise figure (NF)	Reverse direction	Below 7dB	Maximum gain
Spurious emission (within band)	±5.05MHz	Below -14dBm	Maximum output RBW 100KHz
	±10.05MHz	Below -14dBm	
	±15.5MHz	Below -16dBm	
ACLR	BW _{channel}	45dBc	
	2 * BW _{channel}	45dBc	

- Other performance requirements

Item	Performance requirements	Remark
VSWR	Below 1.5 : 1	
Transmit/receive separation	Over 100dBc	

4.1.2 System Specification per Frequency Band – 850MHz

- Frequency characteristics

Item		Performance requirements	Remark
Frequency Band	Forward direction	862 ~ 894MHz	BW : 32MHz CDMA, UMTS, LTE service support
	Reverse direction	817 ~ 849MHz	

- Output characteristics

Item		Performance requirements	Remark
Output level	ROU 2W forward direction	+30dBm/Total	1W@ROU 2W 2W@ROU 5W
	ROU 5W forward direction	+33dBm/Total	
	Reverse direction	0dBm/Total	

- Noise figure and spurious emission characteristics

Item		Performance requirements	Remark
System noise figure (NF)	Reverse direction	Below 7dB	Maximum gain
Spurious emission	±5.05MHz	Below -14dBm	Maximum output

(within band)	$\pm 10.05\text{MHz}$	Below -14dBm	RBW 100KHz
	$\pm 15.5\text{MHz}$	Below -16dBm	
ACLR	BW_{channel}	45dBc	
	$2 * BW_{\text{channel}}$	45dBc	

- Other performance requirements

Item	Performance requirements	Remark
VSWR	Below 1.5 : 1	
Transmit/receive separation	Over 100dBc	

4.1.3 System Specification per Frequency Band – 1.9GHz

- Frequency characteristics

Item	Performance requirements	Remark
Frequency Band	Forward direction	1930 ~ 1995MHz
	Reverse direction	1850 ~ 1915MHz
		BW : 65MHz UMTS, LTE service support

- Output characteristics

Item	Performance requirements	Remark
Output level	ROU 2W forward direction	+33dBm/Total
	ROU 5W forward direction	+37dBm/Total
	Reverse direction	0dBm/Total
		2W@ROU 2W 5W@ROU 5W

- Noise figure and spurious emission characteristics

Item	Performance requirements	Remark
System noise figure (NF)	Reverse direction	Below 7dB
Spurious emission (within band)	$\pm 5.05\text{MHz}$	Below -14dBm
	$\pm 10.05\text{MHz}$	Below -14dBm
	$\pm 15.5\text{MHz}$	Below -16dBm
ACLR	BW_{channel}	45dBc
	$2 * BW_{\text{channel}}$	45dBc
		Maximum gain
		Maximum output RBW 100KHz

- Other performance requirements

Item	Performance requirements	Remark
VSWR	Below 1.5 : 1	
Transmit/receive separation	Over 100dBc	

4.1.4 System Specification per Frequency Band – 2.1GHz

- Frequency characteristics

Item	Performance requirements	Remark
Frequency Band	Forward direction	2110 ~ 2180MHz
	Reverse direction	1710 ~ 1780MHz
		BW : 70MHz UMTS, LTE service support

- Output characteristics

Item	Performance requirements	Remark
Output level	ROU 2W forward direction	+33dBm/Total
	ROU 5W forward direction	+37dBm/Total
	Reverse direction	0dBm/Total
		2W@ROU 2W 5W@ROU 5W

- Noise figure and spurious emission characteristics

Item	Performance requirements	Remark
System noise figure (NF)	Reverse direction	Below 7dB
Spurious emission (within band)	±5.05MHz	Below -14dBm
	±10.05MHz	Below -14dBm
	±15.5MHz	Below -16dBm
ACLR	BW _{channel}	45dBc
	2 * BW _{channel}	45dBc
		Maximum gain
		Maximum output RBW 100KHz

- Other performance requirements

Item	Performance requirements	Remark
VSWR	Below 1.5 : 1	
Transmit/receive separation	Over 100dBc	

4.1.5 System Specification per Frequency Band – 2.3GHz

- Frequency characteristics

Item		Performance requirements	Remark
Frequency Band	Forward direction	2350 ~ 2360MHz	BW : 10MHz LTE service support
	Reverse direction	2305 ~ 2315MHz	

- Output characteristics

Item		Performance requirements	Remark
Output level	ROU 2W forward direction	+30dBm/Total	1W@ROU 2W 2W@ROU 5W
	ROU 5W forward direction	+33dBm/Total	
	Reverse direction	0dBm/Total	

- Noise figure and spurious emission characteristics

Item		Performance requirements	Remark
System noise figure (NF)	Reverse direction	Below 7dB	Maximum gain
Spurious emission (within band)	±5.05MHz	Below -14dBm	Maximum output RBW 100KHz
	±10.05MHz	Below -14dBm	
	±15.5MHz	Below -16dBm	
ACLR	BW _{channel}	45dBc	
	2 * BW _{channel}	45dBc	

- Other performance requirements

Item		Performance requirements	Remark
VSWR		Below 1.5 : 1	
Transmit/receive separation		Over 100dBc	

4.1.6 System Specification per Frequency Band – 2.5GHz

- Frequency characteristics

Item		Performance requirements	Remark
Frequency Band	Forward direction	2496 ~ 2690MHz	BW : 195MHz
	Reverse direction	2496 ~ 2690MHz	TD-LTE service support

- Output characteristics

Item		Performance requirements	Remark
Output level	ROU 2W forward direction	+33dBm/Total	2W@ROU 2W 5W@ROU 5W
	ROU 5W forward direction	+37dBm/Total	
	Reverse direction	0dBm/Total	

- Noise figure and spurious emission characteristics

Item		Performance requirements	Remark
System noise figure (NF)	Reverse direction	Below 7dB	Maximum gain
Spurious emission (within band)	±5.05MHz	Below -14dBm	Maximum output RBW 100KHz
	±10.05MHz	Below -14dBm	
	±15.5MHz	Below -16dBm	
ACLR	BW _{channel}	45dBc	
	2 * BW _{channel}	45dBc	

- Other performance requirements

Item		Performance requirements	Remark
VSWR		Below 1.5 : 1	
Transmit/receive separation		Over 100dBc	

4.1.7 System Specification per Frequency Band – 2.6GHz

- Frequency characteristics

Item		Performance requirements	Remark
Frequency Band	Forward direction	2620 ~ 2690MHz	BW : 70MHz LTE service support
	Reverse direction	2500 ~ 2570MHz	

- Output characteristics

Item		Performance requirements	Remark
Output level	ROU 2W forward direction	+33dBm/Total	2W@ROU 2W 5W@ROU 5W
	ROU 5W forward direction	+37dBm/Total	
	Reverse direction	0dBm/Total	

- Noise figure and spurious emission characteristics

Item		Performance requirements	Remark
System noise figure (NF)	Reverse direction	Below 7dB	Maximum gain
Spurious emission (within band)	±5.05MHz	Below -14dBm	Maximum output RBW 100KHz
	±10.05MHz	Below -14dBm	
	±15.5MHz	Below -16dBm	
ACLR	BW _{channel}	45dBc	
	2 * BW _{channel}	45dBc	

- Other performance requirements

Item	Performance requirements	Remark
VSWR	Below 1.5 : 1	
Transmit/receive separation	Over 100dBc	

4.2 Organization Specification

4.2.1 Structure and Type

Item	Type	Option
MHU	19"Rack type	In-building type
ROU 2W	Enclosure type	In-building type
ROU 5W	Enclosure type	In-building/outdoor type

- MHU, ROU of INOVA DAS should be designed considering installation space and operator's convenience, and the structure design should be elegant.
- INOVA DAS can use internal and external FAN. (Only internal FAN for MHU)
- Components of INOVA DAS should be modular, installation should be made in a structure that each component can be easily mounted and dismounted, and should be easy to replace and maintain.
- Each equipment of INOVA DAS is designed in a structure to block dust, pollutant and insects.
- Each equipment of INOVA DAS is designed to withstand vibration test standard.
- All parts of the cabinet should be smoothly treated in order to prevent personal physical injury during maintenance.
- INOVA DAS provides Timing Advance function for network optimization.

4.2.2 Manufacturing and Processing

- Sealing materials have a very strong thermal properties, and are not torn or damaged by chemicals.
- Internal/external wiring of INOVA DAS is designed elegantly with lapping method or connector connecting method, and can withstand vibration.
- Printed circuit board of INOVA DAS is made of glass epoxy resin or equivalent products, soldering area is exquisite, appearance after soldering is elegant, and has electricity insulator film in order to prevent reduction of insulation resistance due to corrosion, pollutant, and accumulation of dust and moisture.
- Internal/external surface of painted cabinet has the same color, cabinet exterior is designed to withstand blistering, peeling and cracking for 5 years.
- INOVA DAS is designed and manufactured considering methods for emission carbon reduction. (power consumption reduction, material reduction, etc)

4.2.3 Materials and Components

- Passive devices used in INOVA DAS have stable characteristics on frequency and temperature change, active devices are industrial or equivalent semiconductors, and integrated circuits are solid-state devices.
- Wires used in INOVA DAS are tolerance coated wiring with sufficient current capacity and withstands voltage.
- Coaxial line used to connect each component of INOVA DAS are shielded cable of aluminum or copper cladding.
- All metal used in INOVA DAS are designed to withstand not only the generally known corrosion, but also local corrosion including stress corrosion and cracking.
- Plastic used should be insoluble to solvent, and is designed to be free from cracking, molting, and color change when exposed to ammonia.
- Plastic is designed not to crack when exposed to materials(ex-insulators, filling compound) used for cable manufacturing.
- Enclosure, components, PCB, solder, cables follow RoHS(Restriction to hazardous substances).

4.3 Electrical Specification

- Power supplied to MHU, ROU operates normally on commercial power supply (AC120/60Hz).
- There is overvoltage and over current protection function for the power supply.
- When after momentary power outage occurs, RF set value automatically returns to the status right before the power outage.
- Withstand voltage of primary side power terminal and enclosure ground on input/output terminal is DC 2.75KV for one minute, and leakage current is within 100mA.
- Withstand voltage of primary side power terminal and secondary side ground on input/output terminal is DC 4.25KV for one minute, and leakage current is within 100mA.
- Leakage current on phase(120V) is within 3.5mA.
- Surge should not be abnormal when more than 2KV voltage is applied on AC input terminal.
- Equipment grounding is located on both sides of the enclosure.
- Fuse should be visually confirmable(MHU, ROU 10W), and should be replaceable without equipment disassemble.

- All components used on INOVA DAS satisfies EMI terms of FCC title 47, part 15, subject J, class A.
- Grounding strap to ground the grounding wire of #6AWG must be attached to the enclosure.

4.4 Environmental Specification

- No condensation marks should occur inside the equipment when specified temperature and humidity tests are performed.
- INOVA DAS should be designed to have no internal condensation or deterioration due to humidity and internal, external temperature differences, even when it is not normally operated.
- When performing specified vibration test, system performance or mechanical damage should not occur.
- When performing specified waterproof test, there should be no moisture penetration inside the equipment.
- MHU environment test should be performed in accordance to ambient temperature operation standards(in-building standard, for external enclosure outdoor standard).
- Environment test items and method repetition cycle item should be in accordance to operator environment test procedure.

Main environment test conditions for INOVA DAS are as the following.

Item		Conditions	Performance Requirements
Environment test	In-building	- Temperature : -10 ~ +50°C - Humidity : 0 ~ 90% RH	- Output change : within ±3dB - No problem inside/outside enclosure
	Outdoor	- Temperature : -25 ~ +55°C - Humidity : 0 ~ 90% RH	- Output change : within ±3dB - No problem inside/outside enclosure
Vibration test		- 10 ~ 150Hz, gravitational acceleration 1G (IEC 60068-2-6)	- No system performance change - No problem inside/outside enclosure
Noise test		- GR-65-Core(4.6), Level 2	- Below 65dBA (When using external Fan)

Chapter 5

System Installation

-
- 5.1 Tools**
 - 5.2 MHU Installation**
 - 5.3 ROU 2W Installation**
 - 5.4 ROU 5W Installation**
 - 5.5 2.5GHz, 2.6GHz Setting Method**









System Installation

“ This manual is to provide product installation method and product information to the user operating the INOVA DAS system, the repeater manager who uses the operation manual needs to require professional knowledge and experience on construction operation of repeater systems. ”











This chapter explains how to connect power cables and how to install each equipment and optic cable. It specifically describes MHU(MWDM, MPSU, MDRU, MBIU), ROU 2W, ROU 5W installation method and cable connecting method.

5.1 Tools

Tools needed for installation are as below.

No.	Tools	No.	Tools
1	ESD Gloves	2	Torque Wrench Set
			
3	33mm Torque Wrench	4	+, 3Φ Screw Driver
			
5	Wire Stripper	6	Wire Cutter
			
7	Rubber Mallet	8	Digital Multi-meter
			

Other cables and components needed for installation are as below.

No.	Tools	No.	Tools
1	AC Cable	2	INOVA Harness Cable
			
3	INOVA RF Cable	4	Ground Wire Line
			
5	Optic Connector Cleaner	6	LC-type Optic Fiber
			
7	Optic Module	8	SMA Cable
			
9	ANT RF Cable	10	Bracket Bolt/Nut
			

5.2 MHU Installation

5.2.1 Product Installation

MHU is configured with MWDM, MPSU, MDRU, MBIU, all units are designed as 19" rack type. According to cable configuration, installation must be made in the order of MWDM, MPSU, MDRU, MBIU, and it is recommended to slightly open between each unit when installing.

 **Recommendation**

When installing MPSU, MDRU, and MBIU to 19" rack, it is recommended to install them at 1U intervals.

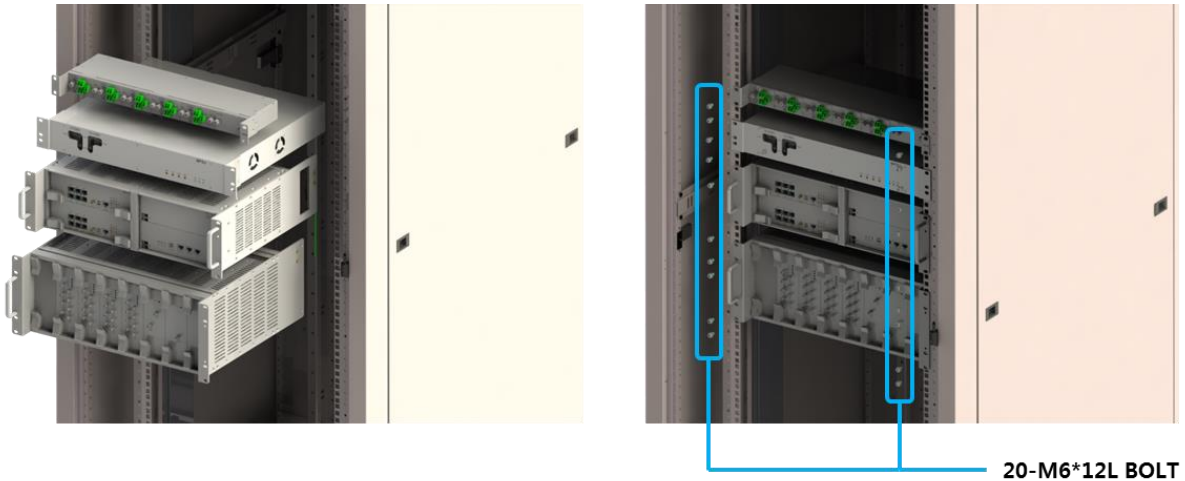

Figure 15. Within 19" Rack, MHU installation.

Align the MHU(MWDM, MPSU, MDRU, MBIU) to rack installation location, when installation location is confirmed, use fixing screws to fix MHU to rack. For fixing screws use M6*12L bolt to fix.

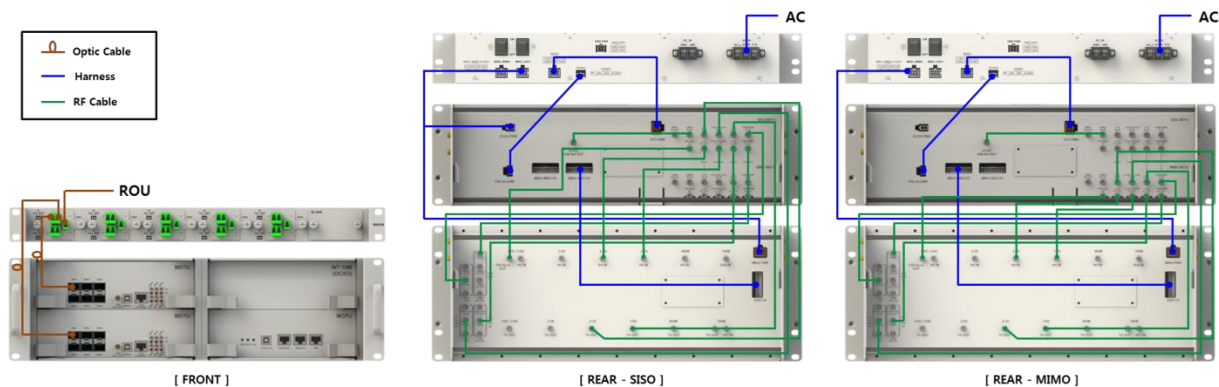

Figure 16. MHU Cable Connection.

Above figure shows cable connection of MHU. MWDM and MDRU are connected with optic cable, MWDM and ROU are connected by optic cable. MPSU supplies power to MDRU and MBIU through harness, MDRU and MBIU are connected between harness and RF cable. MBIU basically operates with

single so cable is configured as the center figure, however if additional Extend MBIU is installed, one additional MBIU is configured to the existing MHU and additional cable is connected, just like the right side figure.

Caution

When installing MHU, make sure that the power switch and distribution board switch on the front of the MPSU are OFF before proceeding.

5.2.2 Ground Cable Connection

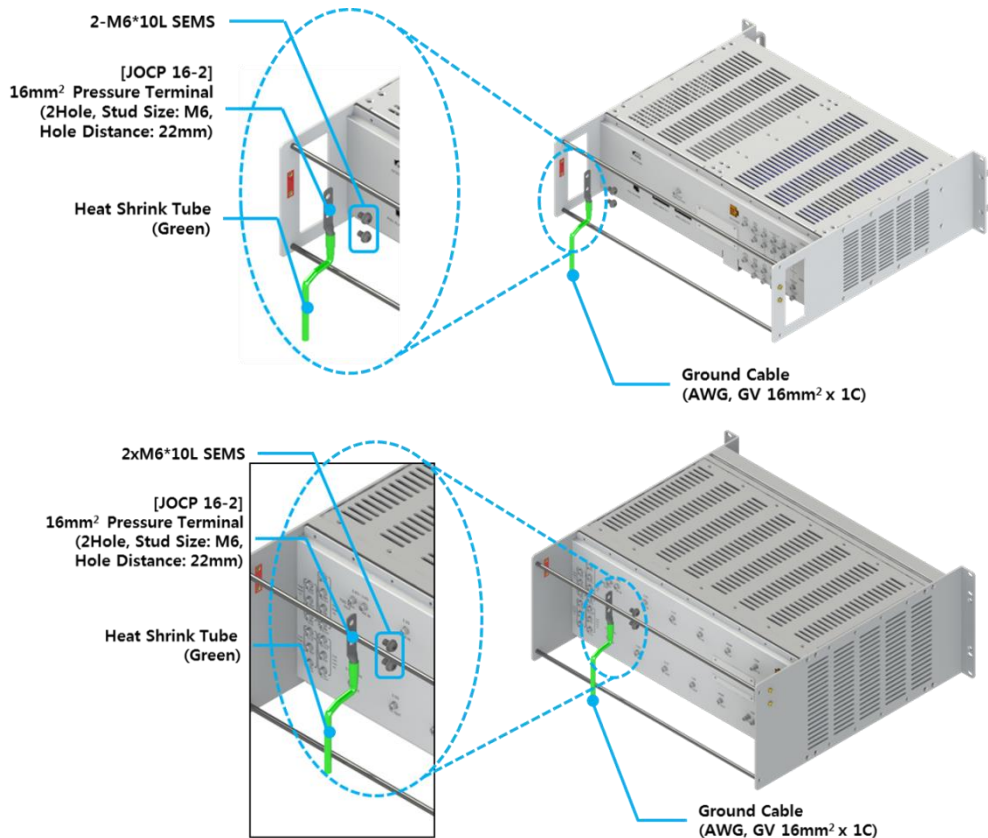

Figure 17. MHU-MDRU, MBIU Ground Cable Connection.

For stable system operation on MHU, grounding cable is connected with system grounding terminal. "AWG, GV 16mm²*1C" is used for grounding cable, and it is assembled by matching location to the back side of MDRU, MBIU using M6*10L SEMS Bolt.

Location	Solderless Terminal	High Pressure Heat Shrink Tube Color/Length	Fastening Material
Inner Ground Bar	16mm ² , Ring Type Hole diameter : 5.3mm	Green/40mm	M5 SEMS
Indoor Rack Frame Ground	16mm ² , Ring Type Hole diameter : 6.3mm	Green/40mm	M5 SEMS

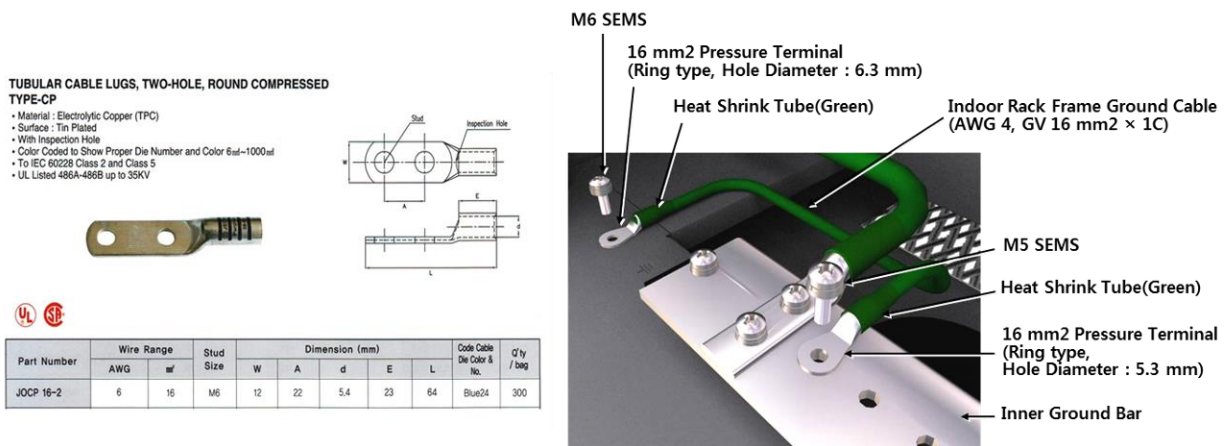

Figure 18. Ground Cable Information.

Use 19" rack equipment ground cable to connect with grounding bar, connect grounding bar with opposite direction of grounding cable connected to MHU. Afterwards connect to grounding wire within building.

5.2.3 Power Cable Connection

MPSU uses AC120V (60Hz) as main power, power cable includes plug. Below is the pin specifications for the AC power cable, when connecting power, polarity of each pin should be checked.

Name	Description	Length(mm)	Color
AC_H	AC Hot	1800	White
AC-N	AC Neutral	1800	Black
F.G	Frame Ground	1800	Green

MHU power cable figure is as below, part connected to MPSU is configured with O-ring type. After accurately connecting polarity described above, turn on the power switch of MPSU.



Figure 19. MHU-MPSU Power Cable.

 **Caution**

When connecting to power cable, the polarity of each power port must be correctly recognized and connected. After all cabling process is completed, check connection status and turn power ON.

5.3 ROU 2W Installation

5.3.1 Product Installation

ROU 2W is configured to one enclosure, can be installed to wall through mounting bracket.

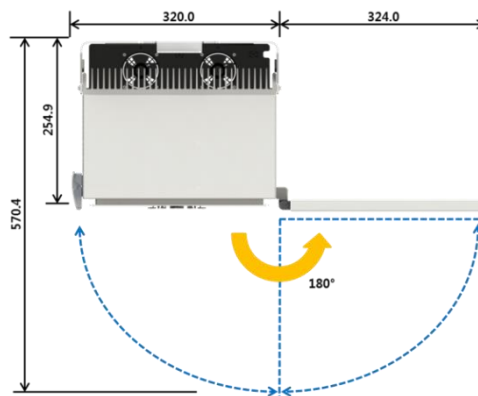

Figure 20. ROU 2W needed Door space.

Since ROU 2W is configured with door, for ease of process, 324mm space on the equipment right side must be secured, and more than 570mm installation space is needed from installation wall.

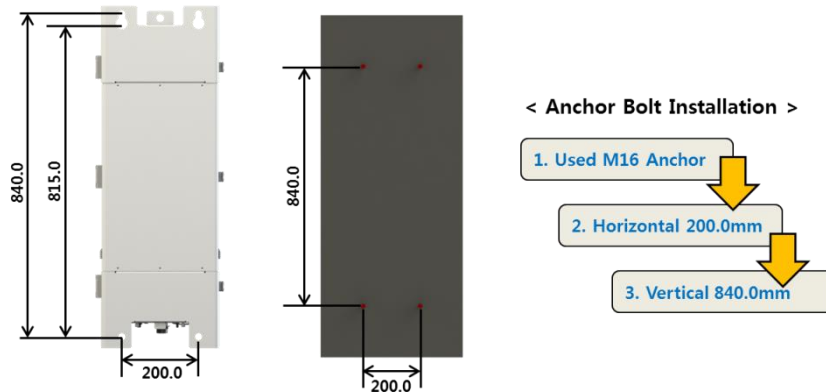

Figure 21. ROU 2W Anchor Bolt Assemble.

Above figure is a simple drawing for the wall face. For wall installation of ROU 2W, use anchor bolt to fix.

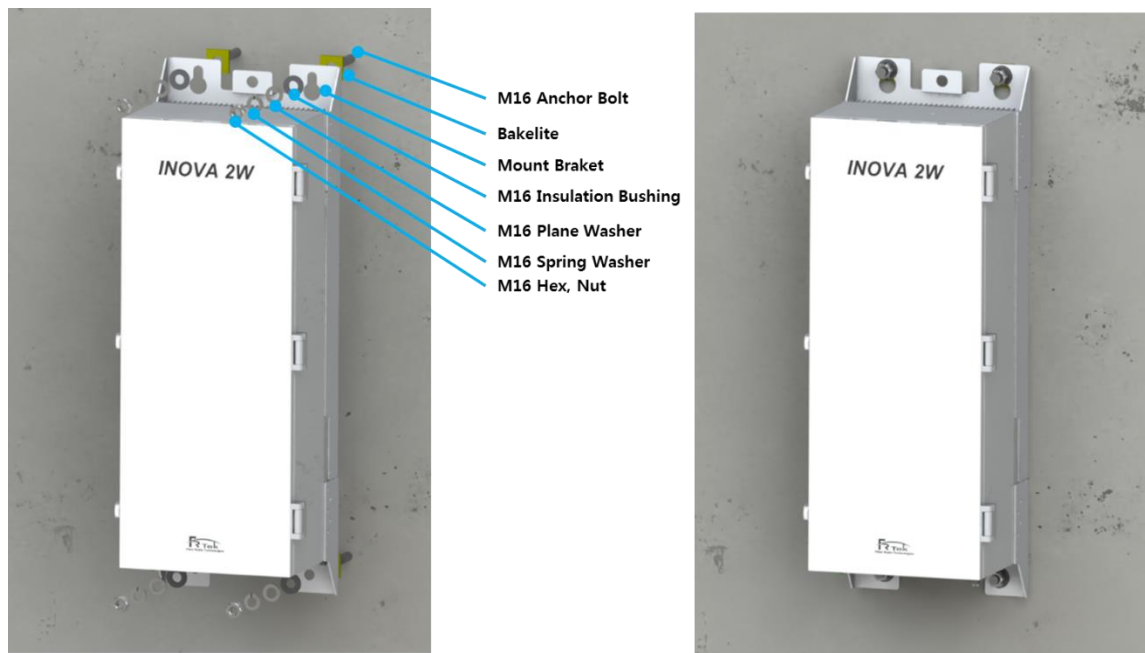

Figure 22. ROU 2W Wall Installation Assemble.

Above figure is the assemble drawing of ROU 2W's wall installation. The assemble orders are as below.

1. Insert bakelite to M16 Anchor Bolt, and locate ROU 2W according to M16 Anchor Bolt location.
2. Insert M16 Insulation Bushing, M16 Plane Washer, and M16 Spring Washer.
3. Tighten M16 Hex, Nut using spanner.

5.3.2 Ground Cable Connection

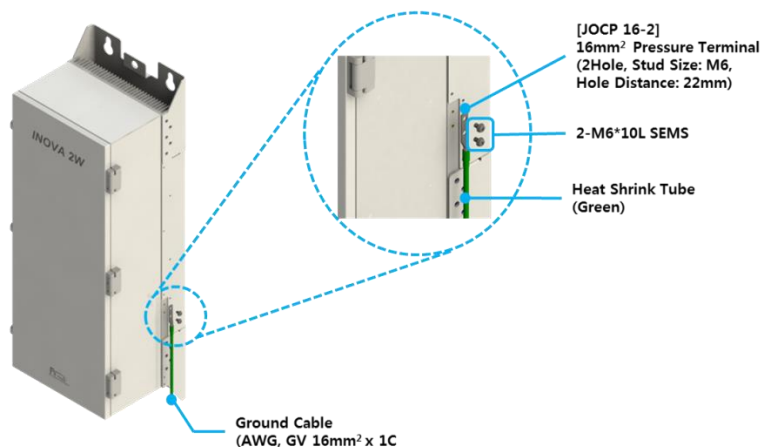

Figure 23. ROU 2W Ground Cable Connection.

Enclosure grounding and building grounding is connected in order to stable and protect ROU 2W equipment from electrical danger.

5.3.3 Antenna Connection

ROU is installed on shaded area to support continuous telecommunication service. One antenna port that can accommodate all frequency bands is configured on the bottom side of ROU 2W, and antenna connector is a DIN-type connector.

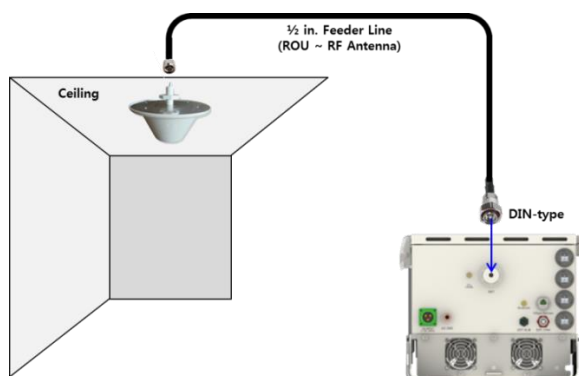

Figure 24. ROU 2W Antenna and Cable Connection.

Above drawing shows antenna connection of ROU 2W. Since ROU 2W is used outdoors, it generally uses Omni antenna, and this antenna is installed on the ceiling for operation.

 **Caution**

Antenna used for ROU 2W must be operator approved or a certified product, antenna type can be selected according to installation environment.

5.3.4 Power Cable Connection

ROU 2W uses AC120V(60Hz) as main power, and power cable includes plug. Below is the pin specification of AC power cable, when connecting power, polarity of each pin must be checked.

MS Connector	Pin Name	Name	Description	Length(mm)
	A	AC_H	AC Hot	1800
	B	AC-N	AC Neutral	1800
	C	F.G	Frame Ground	1800



Figure 25. ROU 2W Power Cable.

5.3.5 Optic Cable Connection

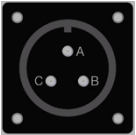
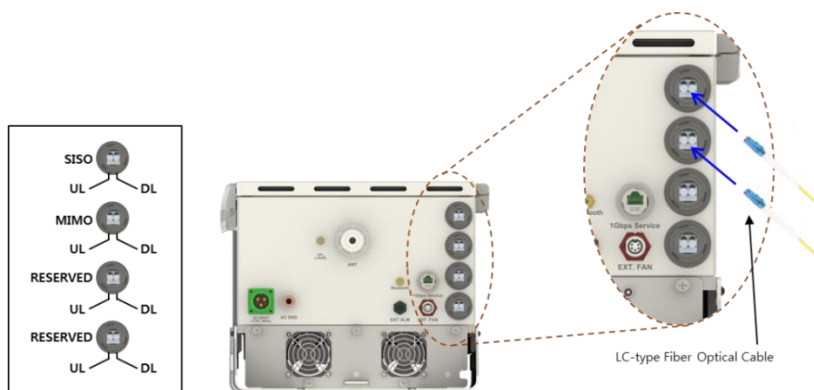

Figure 26. ROU 2W Optic Cable Connection.

Since ROU 2W is in-building equipment, it does not necessarily have to use waterproof optic cable. ROU 2W is configured with a total of 4 optic ports. First optic port for single operation is generally connected to MHU, and also used for cascade network expansion through lower ROU installation.

Second optic port is used for expansion, third and fourth port are configured for spare optic ports. Optic cable connected from MHU or upper ROU is connected with first optic port for service operation.

5.4 ROU 5W Installation

5.4.1 Product Installation

ROU 5W is configured with one enclosure, installation on wall is available through mounting bracket.

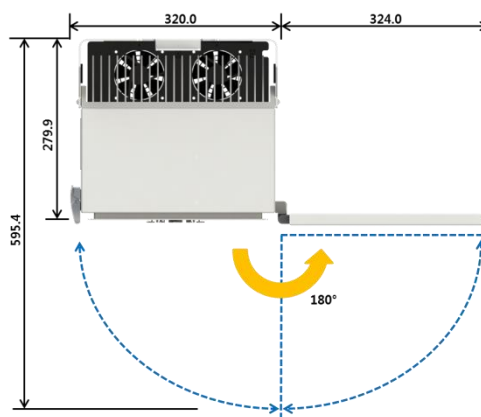

Figure 27. ROU 5W Needed Door Space.

Since ROU 5W is, same as ROU 2W, configured with door, for ease of process, 324mm space on the equipment right side must be secured, and more than 570mm installation space is needed from installation wall.

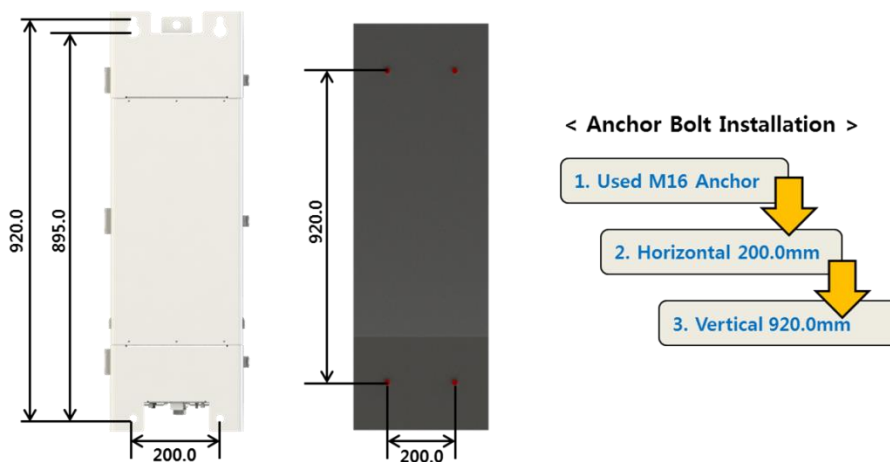

Figure 28. ROU 5W Anchor Bolt Assemble.

Above figure is a simple drawing of the wall face. For wall face installation of ROU 5W, anchor bolt is used to fix.

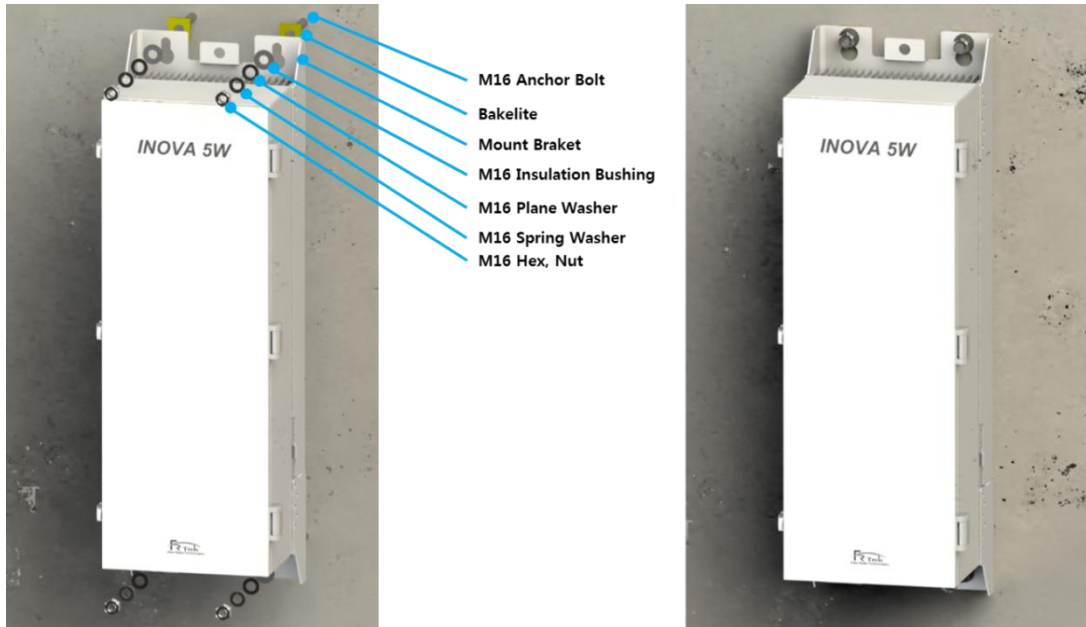

Figure 29. ROU 5W Wall Face Installation Assemble.

Above figure is a assemble drawing of wall face installation of ROU 5W. Assemble order is as the following.

1. Insert bakelite to M16 Anchor Bolt, and locate ROU 5W according to M16 Anchor Bolt location.
2. Insert M16 Insulation Bushing, M16 Plane Washer, and M16 Spring Washer.
3. Tighten M16 Hex, Nut using spanner.

5.4.2 Ground Cable Connection

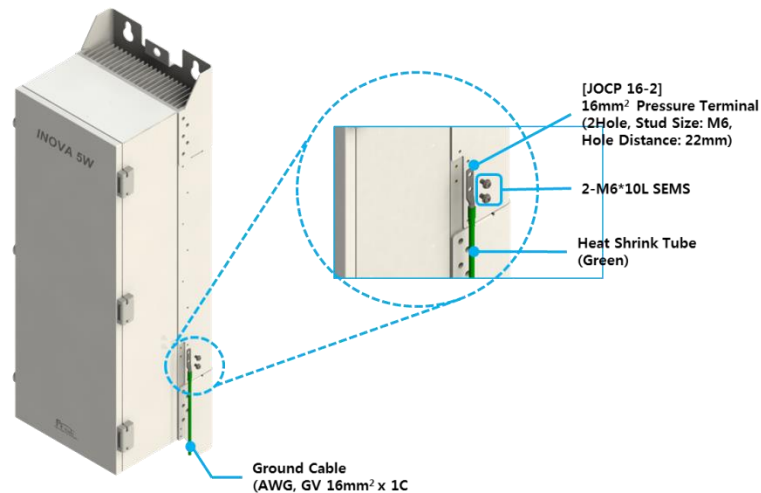

Figure 30. ROU 5W Ground Cable Connection.

Same as ROU 2W, Enclosure grounding and building grounding is connected in order to stable and protect ROU 5W equipment from electrical danger.

5.4.3 Antenna Connection

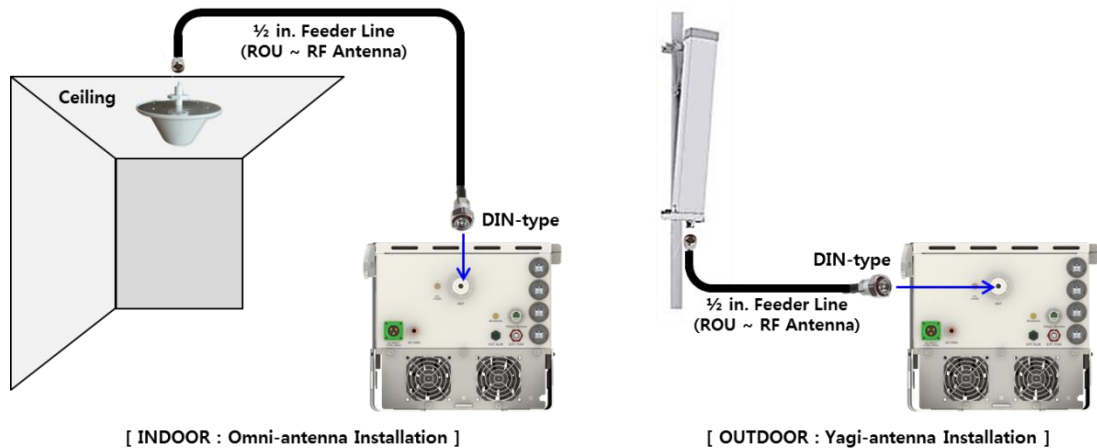

Figure 31. ROU 5W Antenna and Cable Connection.

ROU is installed on shaded area to support continuous telecommunication service. One antenna port that can accommodate all frequency bands is configured on the bottom side of ROU 5W, and antenna connector is a DIN-type connector.

Above drawing shows antenna connection of ROU 5W. When used in-building, it generally uses Omni antenna, and for outdoor uses Yagi antenna. Antenna cabling method is the same for all antenna types.

 **Caution**

Antenna used for ROU 5W must be operator approved or a certified product, antenna type can be selected according to installation environment.

5.4.4 Power Cable Connection

Same as ROU 2W, ROU 5W uses AC power cable, and when connecting power, polarity of each pin must be checked.

MS Connector	Pin Name	Name	Description	Length(mm)
	A	AC_H	AC Hot	1800
	B	AC-N	AC Neutral	1800
	C	F.G	Frame Ground	1800



Figure 32. ROU 5W Power Cable.

5.4.5 Optic Cable Connection

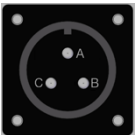
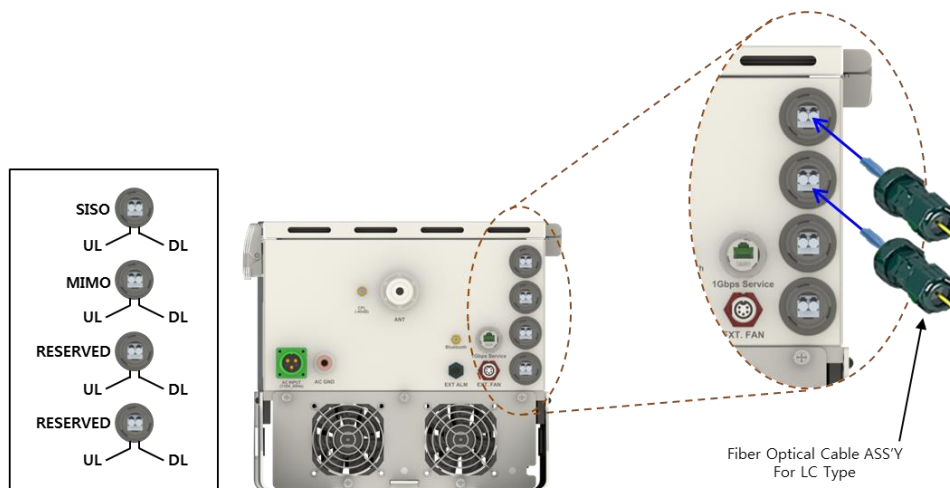

Figure 33. ROU 5W Optic Cable Connection.

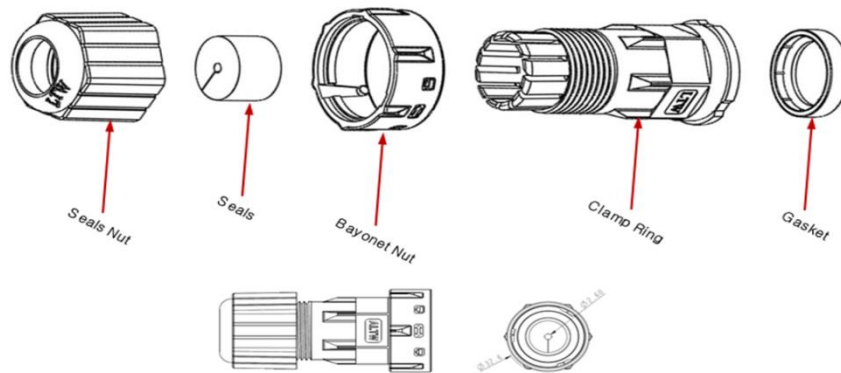

Figure 34. ROU 5W Waterproof Type Optic Connector.

Since ROU 5W is also installed and operated outdoors, waterproof type optic cable must be used for outdoor use. Above figure shows information of the optic cable connection method and waterproof type optic connector.

5.5 2.5GHz, 2.6GHz Setting Method

INOVA DAS is basically available to service 700MHz, 850MHz, 1.9GHz, 2.1GHz, 2.3GHz frequency bands, and is designed to select one of 2.5GHz or 2.6GHz frequency band for service. So according to the module inserted on the MHU and ROU, it can service 700MHz, 850MHz, 1.9GHz, 2.1GHz, 2.3GHz, 2.5GHz or 700MHz, 850MHz, 1.9GHz, 2.1GHz, 2.3GHz, 2.6GHz. Therefore, as the below figure for 2.5GHz and 2.6GHz, the MRFU and RRFU of the desired frequency band should be inserted in the INOVA DAS for service.

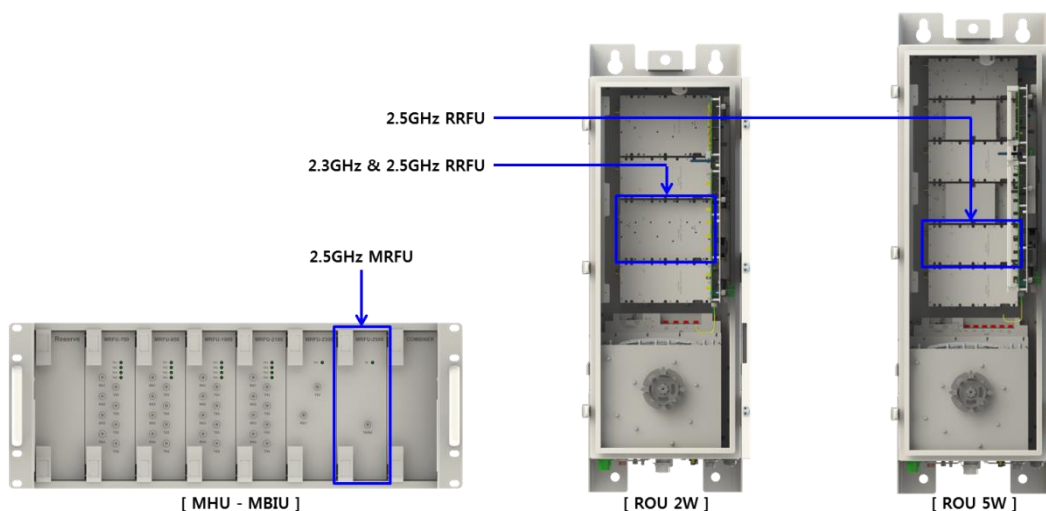

Figure 35. For 2.5GHz Service, Insert 2.5GHz MRFU/RRFU Module.

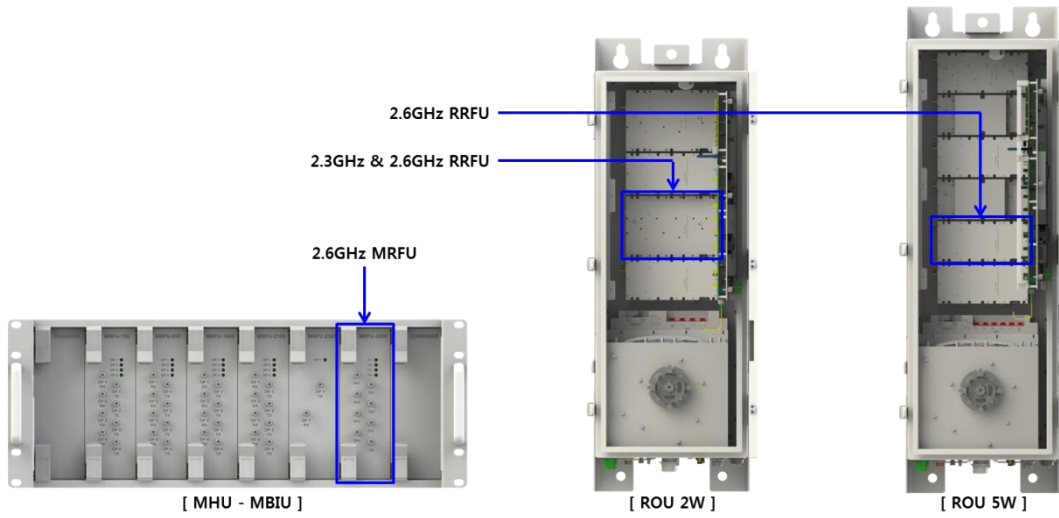

Figure 36. For 2.6GHz Service, Insert 2.6GHz MRFU/RRFU Module.

Chapter 6

Local GUI(Graphical User Interface)

-
- 6.1 Local GUI Main Screen**
 - 6.2 Local GUI MHU Screen**
 - 6.3 Local GUI ROU Screen**

Local GUI(Graphical User Interface)

“ This manual is to provide product installation method and product information to the user operating the INOVA DAS system, the repeater manager who uses the operation manual needs to require professional knowledge and experience on construction operation of repeater systems. ”

- This operation program is designed for controlling and monitoring INOVA DAS.
- This operation program uses USB-B type port configured on each equipment.
- User is available to monitor and control the INOVA DAS operation status through MHU and ROU main screen.

6.1 Local GUI Main Screen

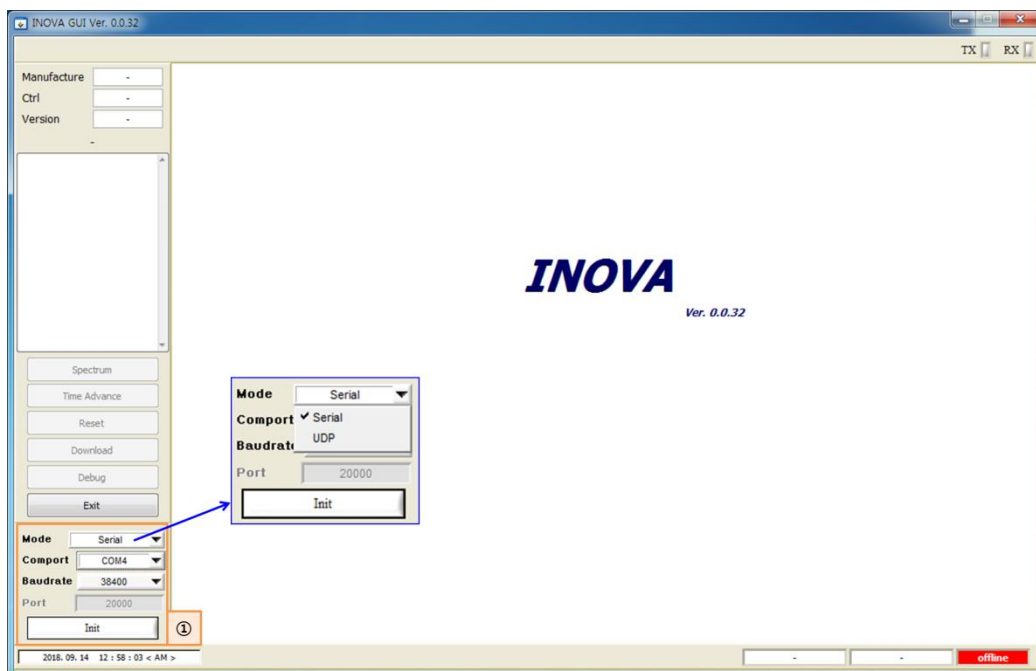

Figure 37. Local GUI initial screen.

When executing Local GUI of INOVA DAS, the GUI initial screen is shown as the above figure. Local GUI and INOVA DAS equipment can be connected with serial communication or UDP communication. Serial telecommunication can be used by connecting to USB B-type port of MCPU or RCPU, UDP telecommunication can be used by connecting to Ethernet port of MCPU or RCPU.

① **Telecommunication Connection**

This is the window to select telecommunication method for GUI operation with INOVA DAS.

- **Mode** : You can select GUI connection method for equipment.
- **Comport** : You can select auto set serial port on GUI notebook.
- **Baudrate** : Basically uses 38400.

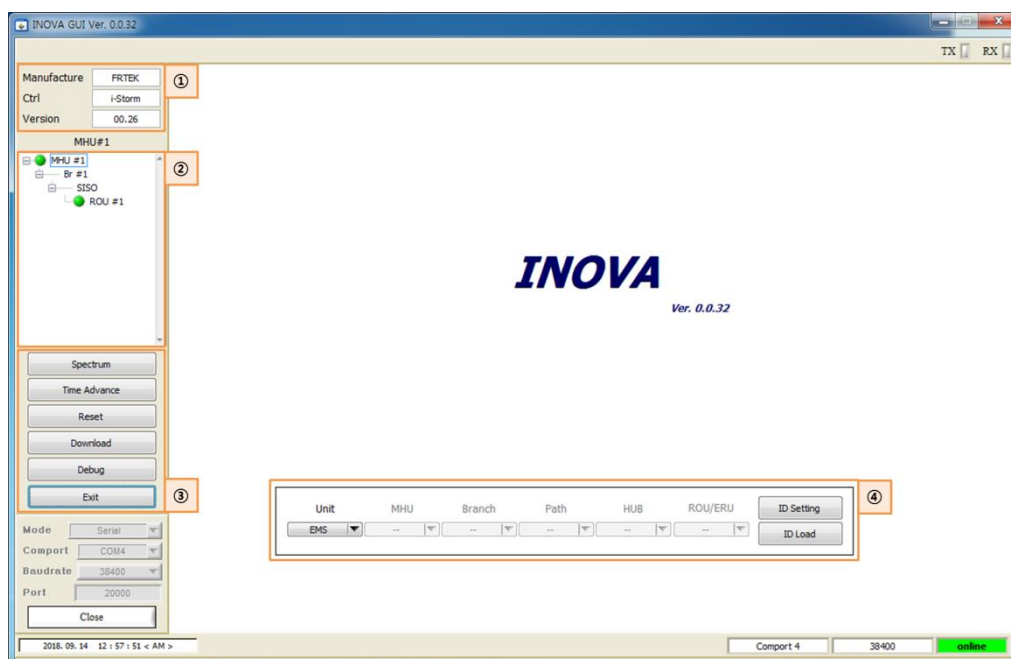

Figure 38. Local GUI Main Screen.

GUI screen as above figure will show up when selecting telecommunication method and connecting GUI and INOVA DAS. When accessing to the desired equipment(MHU, ROU) from the screen, GUI screen of the equipment will appear.

① **Manufacturer Information**

Window to check INOVA DAS manufacturer information and GUI version information.

② **Equipment Tree**

Window to check current INOVA DAS connection status all at once. From this tree configuration, the status of equipment connected to each branch of the MHU, connected ROU's Single and Extend configuration information can be checked, and existence of equipment alarm can be confirmed

through the alarm on the side. Also, by selecting the desired equipment on this window, the screen to check status information and to control the equipment will show.

③ GUI Function

INOVA spectrum analyzer function or time advance, download function can be checked on this item.

- **Spectrum** : Item to use INOVA DAS spectrum analyzer function. Digital input/output signal of all frequency bands can be checked from this function, and each service signal per frequency can be checked real time. Spectrum Analyzer screen is as below.

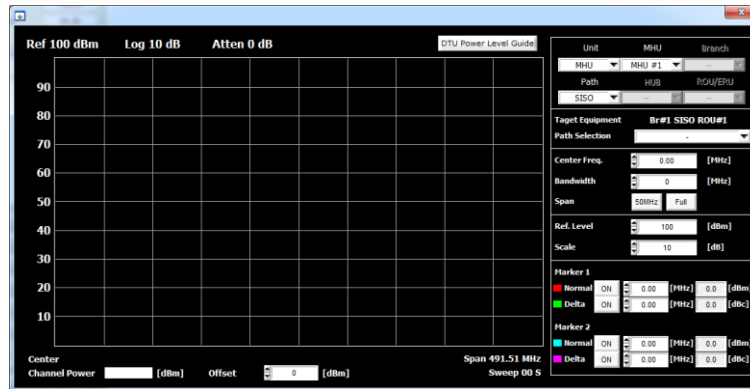

Figure 39. Spectrum Analyzer Window Screen.

- **Time Advance** : Item to use INOVA DAS time advance function. Measures delay between optic cables of configured equipment, and can automatically set system delay to user set delay value. Time Advance screen is as below.

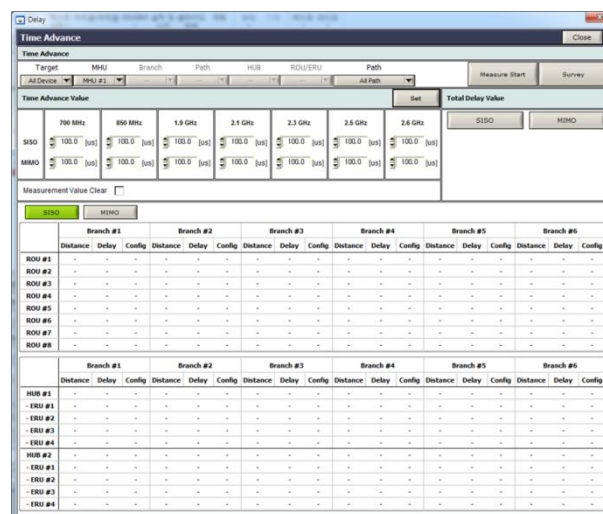

Figure 40. Time Advance Window Screen.

- **Reset** : Item to use reset function of CPU or DTU of the current configured equipment. Below figure shows the reset window.

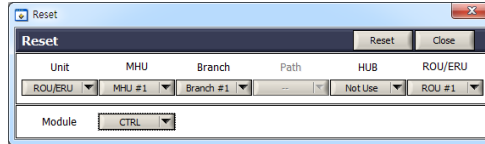

Figure 41. Reset Window Screen.

- **Download** : Item to use function to download firmware such as CPU, DTU, RF unit of the current configured equipment. Below figure shows the download window.

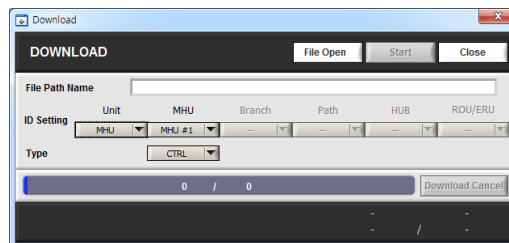

Figure 42. Download Window Screen.

- **Debug** : Item to use debug on GUI
- **Exit** : Item to use when exiting current GUI.

④ ID Setting

Item to read ROU's set ID, and reset ID. When using this item, GUI needs to be accessed by connecting cable to RCP.

6.2 Local GUI MHU Screen

6.2.1 MHU Main Screen

- <Status Mode> requests MHU equipment's status information at intervals of 1 sec.
- By clicking <Set Mode> button, <Set> button next to the button is activated, enters to <Set Mode>, stops status request and can control MHU items.
- When setting is successfully completed, <Setting Success> message window is shown.
- When clicking <Close> button the window will close, and go back to <GUI Main>.

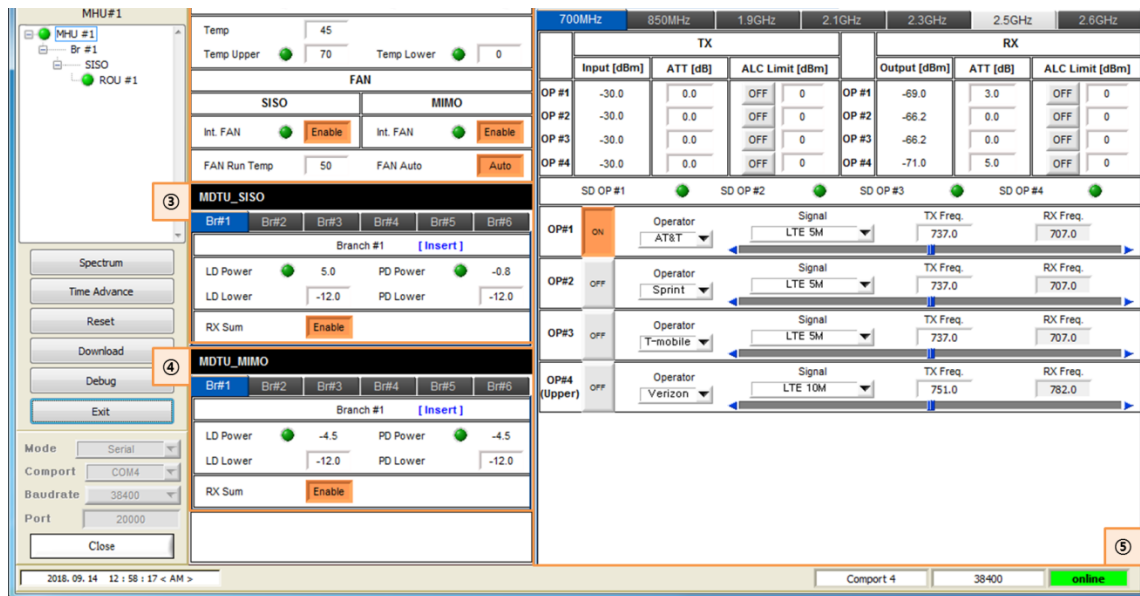

Figure 43. Local GUI MHU Screen.

Above figure shows GUI screen of INOVA MHU. On this screen, temperature monitoring and FAN status monitoring and control of MHU, optic signal and RF signal status monitoring and control is available.

① Install

ROU of INOVA MHU can be set. As set on install, the equipment connection is updated on the left tree information. Below figure shows the install screen.

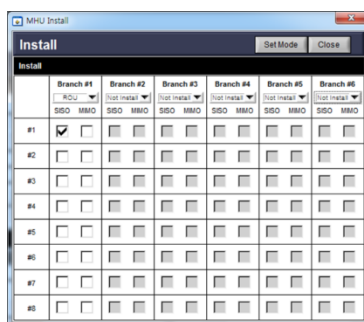

Figure 44. MHU Install Screen.

② Environment

Item to check MHU AC/DC alarm and temperature alarm. Also, MHU internal fan on/off control is available, fan can be set to automatically turn on/off according to temperature.

③ DTU single

Item to check information of optic signal inserted per each branch on single MDTU. Monitoring of optic signal level transmitted from lower equipment and received from upper equipment is available, and user can set the optic signal level that generates the lower limit alarm.

④ DTU EXTENDED

Item to check information of optic signal inserted per each branch on EXTENDED MDTU. Monitoring of optic signal level transmitted from lower equipment and received from lower equipment is available, and user can set the optic signal level that generates the lower limit alarm.

⑤ Band Information

Item to check status information of TX input signal (downlink) and RX output signal (uplink) per each frequency band for each Single / Extend, and can set channel per each frequency. When single is configured, Extend part is disabled to prevent user confusion.

It is a method to select one out of either 2.5GHz or 2.6GHz. Therefore, when inserting 2.5GHz MRFU for use, 2.5GHz band information is activated and 2.6GHz band information is deactivated. Conversely, when inserting 2.6GHz MRFU for use, 2.6GHz band information is activated and 2.5GHz band information is deactivated.

6.2.2 MHU Main Screen per Frequency

- 700MHz Band Information

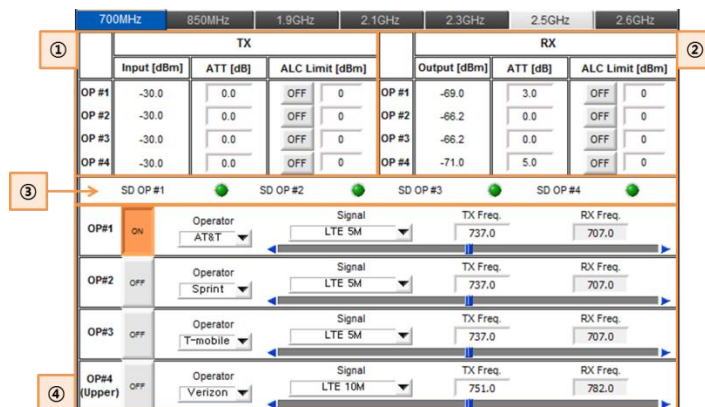

Figure 45. 700MHz MHU Band Information Screen.

① 700MHz TX Signal Monitoring and Controlling

The RF signal input level(Downlink) of 700MHz band received from the base station can be checked on this item, and the input level can be manually adjusted by controlling ATTen. according to the operator. Also, ALC function is configured for the user to automatically adjust input level by inputting the desired ALC level and turning the function ON.

② 700MHz RX Signal Monitoring and Controlling

The RF signal output level(Uplink) of 700MHz band received from the lower equipment can be checked on this item. Also, same as TX, output level can be manually adjusted by controlling ATTen., and automatic output level adjustment through ALC is implemented.

③ 700MHz RX Output Level Monitoring

Alarm to monitor shutdown status of RX output signal(Uplink) per each operator is configured on this item.

④ 700MHz Channel Set

The operator label and channel filter per each operator can be selected on this item. Also, frequency can be set by inputting the user desired frequency on DL Freq. and also can set frequency by moving the bottom bar or the arrows on both sides.

• 850MHz Band Information

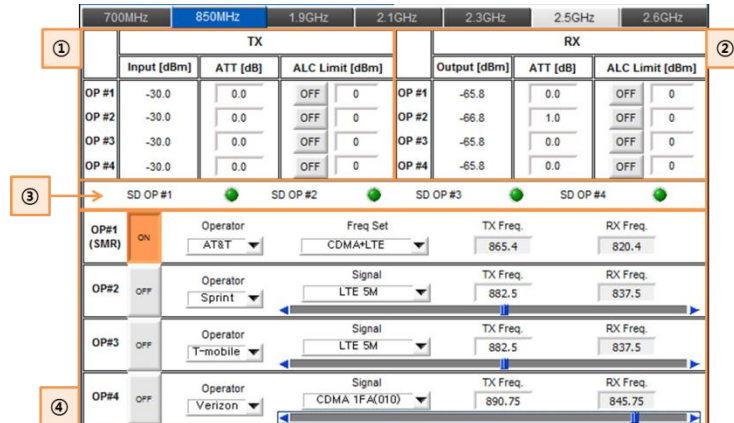

Figure 46. 850MHz MHU Band Information Screen.

① 850MHz TX Signal Monitoring and Control

The RF signal input level(Downlink) of 850MHz band received from the base station can be checked on this item, and the input level can be manually adjusted by controlling ATTen. according to the operator. Also, ALC function is configured for the user to automatically adjust input level by inputting the desired ALC level and turning the function ON.

② 850MHz RX Signal Monitoring and Control

The RF signal output level(Uplink) of 850MHz band received from the lower equipment can be checked on this item. Also, same as TX, output level can be manually adjusted by controlling ATTen., and automatic output level adjustment through ALC is implemented.

③ 850MHz RX Output Level Monitoring

Alarm to monitor shutdown status of RX output signal(Uplink) per each operator is configured on this item.

④ 850MHz Channel Set

The operator label and channel filter per each operator can be selected on this item. Also, frequency can be set by inputting the user desired frequency on DL Freq. and also can set frequency by moving the bottom bar or the arrows on both sides.

• **1.9GHz Band Information**

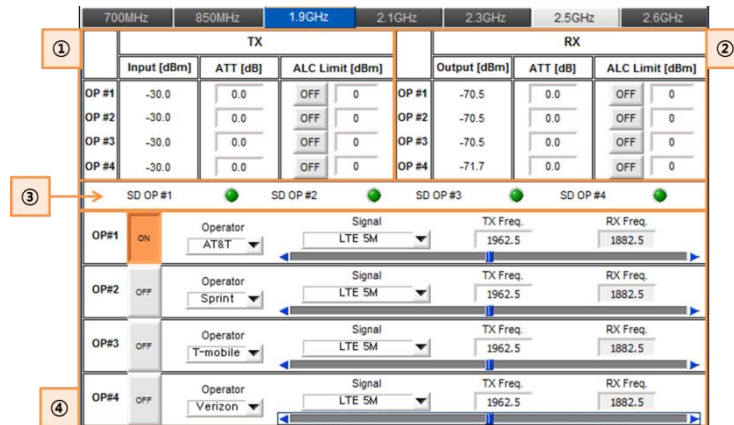

Figure 47. 1.9GHz MHU Band Information Screen.

① **1.9GHz TX Signal Monitoring and Control**

The RF signal input level(Downlink) of 1.9GHz band received from the base station can be checked on this item, and the input level can be manually adjusted by controlling ATTen. according to the operator. Also, ALC function is configured for the user to automatically adjust input level by inputting the desired ALC level and turning the function ON.

② **1.9GHz RX Signal Monitoring and Control**

The RF signal output level(Uplink) of 1.9GHz band received from the lower equipment can be checked on this item. Also, same as TX, output level can be manually adjusted by controlling ATTen., and automatic output level adjustment through ALC is implemented.

③ **1.9GHz RX Output Level Monitoring**

Alarm to monitor shutdown status of RX output signal(Uplink) per each operator is configured on this item.

④ **1.9GHz Channel Set**

The operator label and channel filter per each operator can be selected on this item. Also, frequency can be set by inputting the user desired frequency on DL Freq. and also can set frequency by moving the bottom bar or the arrows on both sides.

• **2.1GHz Band Information**

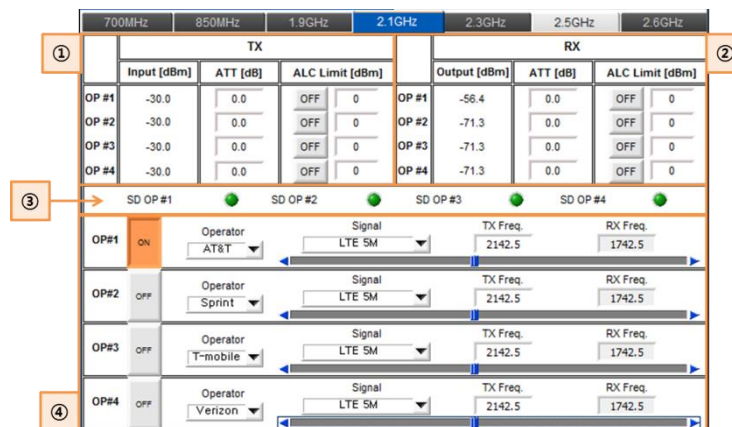

Figure 48. 2.1GHz MHU Band Information Screen.

① 2.1GHz TX Signal Monitoring and Control

The RF signal input level(Downlink) of 2.1GHz band received from the base station can be checked on this item, and the input level can be manually adjusted by controlling ATTen. according to the operator. Also, ALC function is configured for the user to automatically adjust input level by inputting the desired ALC level and turning the function ON.

② 2.1GHz RX Signal Monitoring and Control

The RF signal output level(Uplink) of 2.1GHz band received from the lower equipment can be checked on this item. Also, same as TX, output level can be manually adjusted by controlling ATTen., and automatic output level adjustment through ALC is implemented.

③ 2.1GHz RX Output Level Monitoring

Alarm to monitor shutdown status of RX output signal(Uplink) per each operator is configured on this item.

④ 2.1GHz Channel Set

The operator label and channel filter per each operator can be selected on this item. Also, frequency can be set by inputting the user desired frequency on DL Freq. and also can set frequency by moving the bottom bar or the arrows on both sides.

• 2.3GHz Band Information

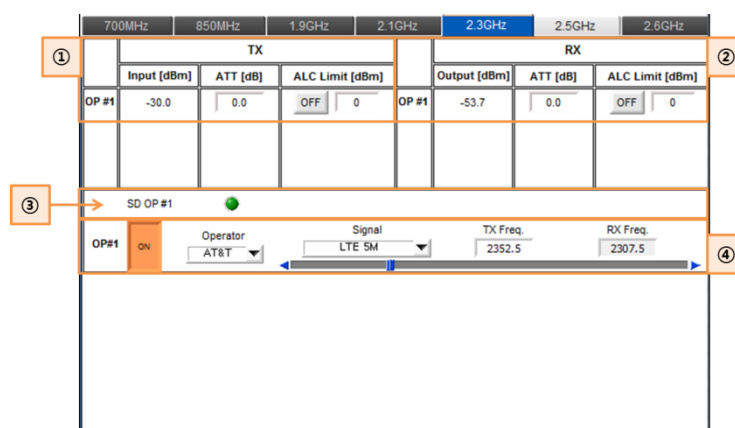

Figure 49. 2.3GHz MHU Band Information Screen.

① 2.3GHz TX Signal Monitoring and Control

The RF signal input level(Downlink) of 2.3GHz band received from the base station can be checked on this item, and the input level can be manually adjusted by controlling ATTen. according to the operator. Also, ALC function is configured for the user to automatically adjust input level by inputting the desired ALC level and turning the function ON.

② 2.3GHz RX Signal Monitoring and Control

The RF signal output level(Uplink) of 2.3GHz band received from the lower equipment can be checked on this item. Also, same as TX, output level can be manually adjusted by controlling ATTen., and automatic output level adjustment through ALC is implemented.

③ 2.3GHz RX Output Level Monitoring

Alarm to monitor shutdown status of RX output signal(Uplink) per each operator is configured on this item.

④ 2.3GHz Channel Set

The operator label and channel filter per each operator can be selected on this item. Also, frequency can be set by inputting the user desired frequency on DL Freq. and also can set frequency by moving the bottom bar or the arrows on both sides.

• 2.5GHz Band Information

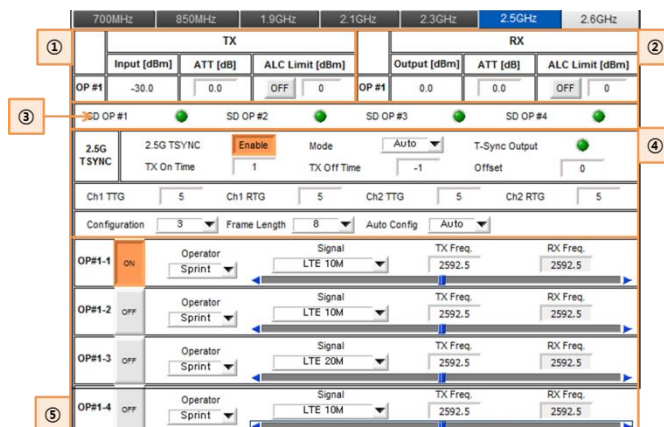

Figure 50. 2.5GHz MHU Band Information Screen.

① 2.5GHz TX Signal Monitoring and Control

The RF signal input level(Downlink) of 2.5GHz band received from the base station can be checked on this item, and the input level can be manually adjusted by controlling ATTen. according to the operator. Also, ALC function is configured for the user to automatically adjust input level by inputting the desired ALC level and turning the function ON.

② 2.5GHz RX Signal Monitoring and Control

The RF signal output level(Uplink) of 2.5GHz band received from the lower equipment can be checked on this item. Also, same as TX, output level can be manually adjusted by controlling ATTen., and automatic output level adjustment through ALC is implemented.

③ 2.5GHz RX Output Level Monitoring

Alarm to monitor shutdown status of RX output signal(Uplink) per each operator is configured on this item.

④ 2.5GHz TDD TDD Signal Set

Since 2.5GHz is a frequency band using TD-LTE, TDD synchronization signal status monitoring and controlling configuration is needed. 2.5GHz TDD synchronization signal on/off is available on this item, and can select high-low configured synchronization signal or only high synchronization signal and only low synchronization signal. Also, the start time and end time of the synchronization signal

can be finely adjusted, and is configured to set high-low cycle.

⑤ **2.5GHz Channel Set**

The operator label and channel filter per each operator can be selected on this item. Also, frequency can be set by inputting the user desired frequency on DL Freq. and also can set frequency by moving the bottom bar or the arrows on both sides.

• **2.6GHz Band Information**

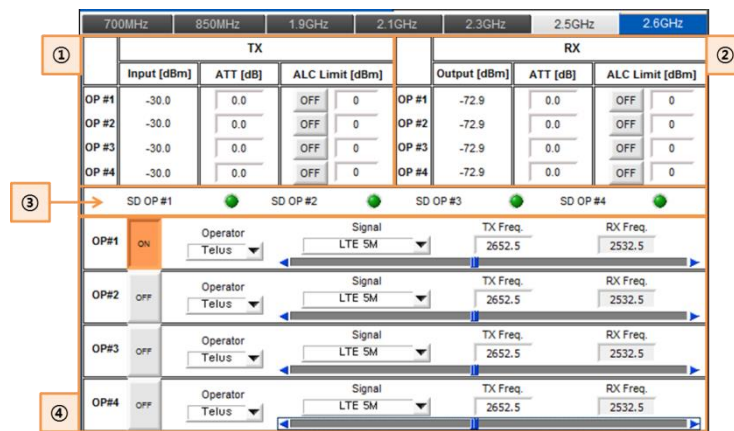

Figure 51. 2.6GHz MHU Band Information Screen.

① **2.6GHz TX Signal Monitoring and Control**

The RF signal input level(Downlink) of 2.6GHz band received from the base station can be checked on this item, and the input level can be manually adjusted by controlling ATTen. according to the operator. Also, ALC function is configured for the user to automatically adjust input level by inputting the desired ALC level and turning the function ON.

② **2.6GHz RX Signal Monitoring and Control**

The RF signal output level(Uplink) of 2.6GHz band received from the lower equipment can be checked on this item. Also, same as TX, output level can be manually adjusted by controlling ATTen., and automatic output level adjustment through ALC is implemented.

③ **2.6GHz RX Output Level Monitoring**

Alarm to monitor shutdown status of RX output signal(Uplink) per each operator is configured on this item.

④ **2.6GHz Channel Set**

The operator label and channel filter per each operator can be selected on this item. Also, frequency can be set by inputting the user desired frequency on DL Freq. and also can set frequency by moving the bottom bar or the arrows on both sides.

6.3 Local GUI ROU Screen

6.3.1 ROU Main Screen

- <Status Mode> requests ROU equipment's status information at intervals of 1 sec.
- By clicking <Set Mode> button, <Set> button next to the button is activated, enters to <Set Mode>, stops status request and can control ROU items.
- When setting is successfully completed, <Setting Success> message window is shown.
- When clicking <Close> button the window will close, and go back to <GUI Main>.

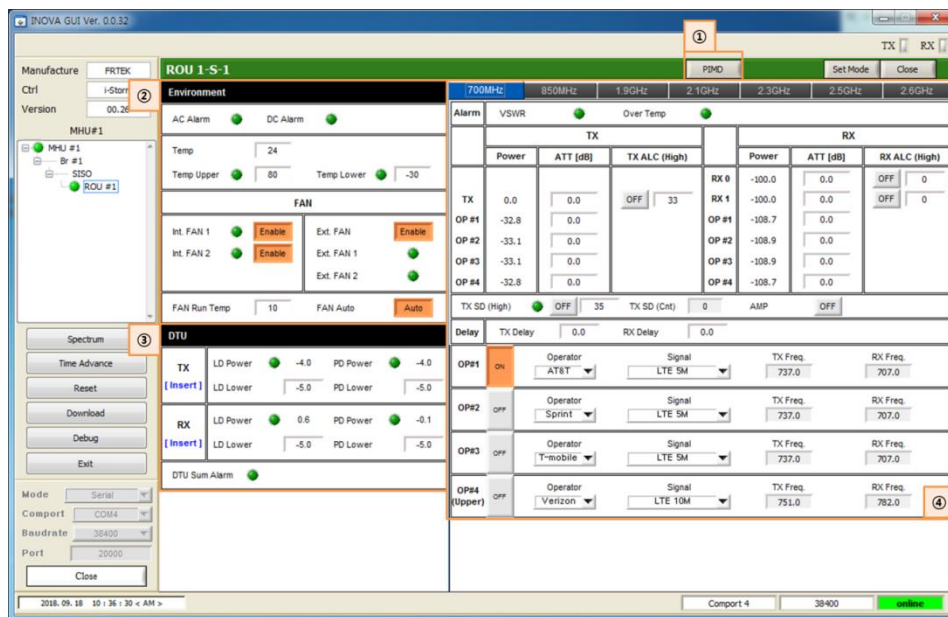

Figure 52. Local GUI ROU Screen.

Above figure shows the INOVA ROU GUI screen, the ROU 2W and ROU 5W are both configured with the same screen. ROU temperature monitoring and FAN status monitoring and controlling is available on this screen, and optic signal and RF signal status monitoring and controlling is available as well.

① **PIMD**

Item for ROU PIMD function control. On/off button to generate CW tone on RX path(Uplink) of frequency band exists, and items to measure and check RX gain is configured.

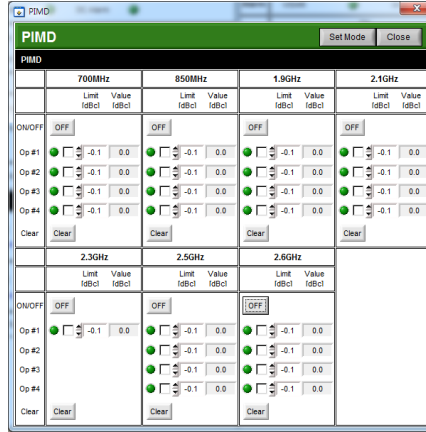

Figure 53. ROU PIMD Screen.

② **Environment**

Item to check MHU AC/DC alarm and temperature alarm. Also, MHU internal fan on/off control is available, fan can be set to automatically turn on/off according to temperature.

③ **DTU**

Item to check information of optic signal inserted on RDTU. Optic signal level transmitted/received from upper equipment is available, and user can set optic signal level that generates low limit alarm.

④ **Band Information**

TX output signal(Downlink) and RX input signal (Uplink) status monitoring and control per each frequency band is available in this item, and channel information per each frequency set on MHU can be checked. Also, same as MHU, 2.5GHz and 2.6GHz can be activated/deactivated according to inserted RRFU.

6.3.2 MHU Main Screen per Frequency

- 700MHz Band Information

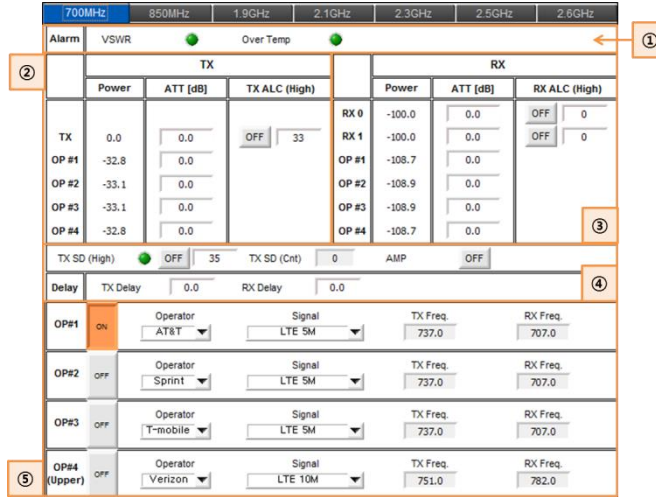

Figure 54. 700MHz ROU Band Information Screen.

① 700MHz Alarm

Item to check 700MHz module VSWR alarm and temperature alarm.

② 700MHz TX Signal Monitoring and Control

The RF signal output level(Downlink) of 700MHz band received from the MHU can be checked on this item, and the output level can be manually adjusted by controlling ATTen. according to the operator. Also, ALC function is configured for the user to automatically adjust output level by inputting the desired ALC level and turning the function ON.

③ 700MHz RX Signal Monitoring and Control

The RF signal input level(Uplink) of 700MHz band received from the terminal can be checked on this item. Also, same as TX, input level can be manually adjusted by controlling ATTen., and automatic input level adjustment through ALC is implemented.

④ 700MHz TX Shutdown and Delay Control

Item implements shutdown function of automatically turning HPA off when 700MHz TX output signal gets high due to overpower. User can set shutdown signal level, function operates when switch is on.

Also, item is configured with delay control item to control 700MHz system delay. When user inputs specific value on this delay window, 700MHz system delay applies with the user input value added.

⑤ 700MHz Channel Status

Item cannot be controlled on the ROU screen, the operator label, channel filter type, downlink frequency, uplink frequency set from MHU per each operator can be checked.

• 850MHz Band Information

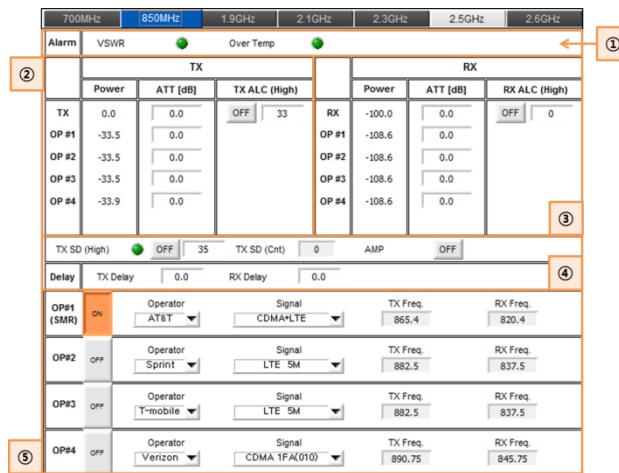

Figure 55. 850MHz ROU Band Information Screen.

① 850MHz Alarm

Item to check 850MHz module VSWR alarm and temperature alarm.

② 850MHz TX Signal Monitoring and Control

The RF signal output level(Downlink) of 850MHz band received from the MHU can be checked on this item, and the output level can be manually adjusted by controlling ATTen. according to the operator. Also, ALC function is configured for the user to automatically adjust output level by inputting the desired ALC level and turning the function ON.

③ 850MHz RX Signal Monitoring and Control

The RF signal input level(Uplink) of 850MHz band received from the terminal can be checked on this item. Also, same as TX, input level can be manually adjusted by controlling ATTen., and automatic input level adjustment through ALC is implemented.

④ **850MHz TX Shutdown and Delay Control**

Item implements shutdown function of automatically turning HPA off when 850MHz TX output signal gets high due to overpower. User can set shutdown signal level, function operates when switch is on.

Also, item is configured with delay control item to control 850MHz system delay. When user inputs specific value on this delay window, 850MHz system delay applies with the user input value added.

⑤ **850MHz Channel Status**

Item cannot be controlled on the ROU screen, the operator label, channel filter type, downlink frequency, uplink frequency set from MHU per each operator can be checked.

• **1.9GHz Band Information**

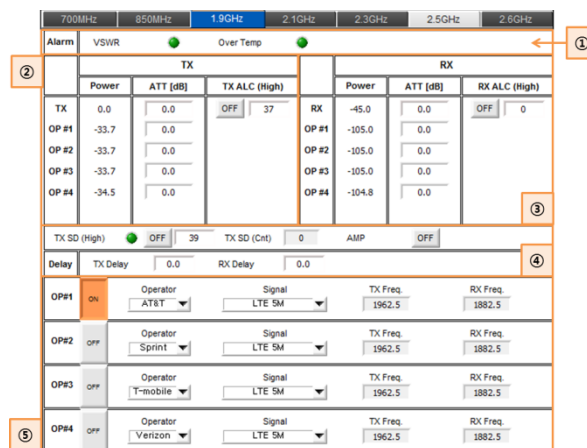

Figure 56. 1.9GHz ROU Band Information Screen.

① **1.9GHz Alarm**

Item to check 1.9GHz module VSWR alarm and temperature alarm.

② **1.9GHz TX Signal Monitoring and Control**

The RF signal output level(Downlink) of 1.9GHz band received from the MHU can be checked on this item, and the output level can be manually adjusted by controlling ATTen. according to the operator. Also, ALC function is configured for the user to automatically adjust output level by inputting the desired ALC level and turning the function ON.

③ **1.9GHz RX Signal Monitoring and Control**

The RF signal input level(Uplink) of 1.9GHz band received from the terminal can be checked on this item. Also, same as TX, input level can be manually adjusted by controlling ATTen., and automatic input level adjustment through ALC is implemented.

④ **1.9GHz TX Shutdown and Delay Control**

Item implements shutdown function of automatically turning HPA off when 1.9GHz TX output signal gets high due to overpower. User can set shutdown signal level, function operates when switch is on.

Also, item is configured with delay control item to control 1.9GHz system delay. When user inputs specific value on this delay window, 1.9GHz system delay applies with the user input value added.

⑤ **1.9GHz Channel Status**

Item cannot be controlled on the ROU screen, the operator label, channel filter type, downlink frequency, uplink frequency set from MHU per each operator can be checked.

• **2.1GHz Band Information**

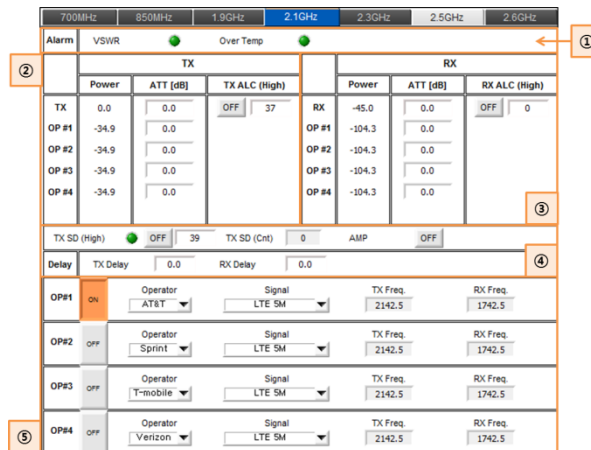

Figure 57. 2.1GHz ROU Band Information Screen.

① **2.1GHz Alarm**

Item to check 2.1GHz module VSWR alarm and temperature alarm.

② 2.1GHz TX Signal Monitoring and Control

The RF signal output level(Downlink) of 2.1GHz band received from the MHU can be checked on this item, and the output level can be manually adjusted by controlling ATTen. according to the operator. Also, ALC function is configured for the user to automatically adjust output level by inputting the desired ALC level and turning the function ON.

③ 2.1GHz RX Signal Monitoring and Control

The RF signal input level(Uplink) of 2.1GHz band received from the terminal can be checked on this item. Also, same as TX, input level can be manually adjusted by controlling ATTen., and automatic input level adjustment through ALC is implemented.

④ 2.1GHz TX Shutdown and Delay Control

Item implements shutdown function of automatically turning HPA off when 2.1GHz TX output signal gets high due to overpower. User can set shutdown signal level, function operates when switch is on.

Also, item is configured with delay control item to control 2.1GHz system delay. When user inputs specific value on this delay window, 2.1GHz system delay applies with the user input value added.

⑤ 2.1GHz Channel Status

Item cannot be controlled on the ROU screen, the operator label, channel filter type, downlink frequency, uplink frequency set from MHU per each operator can be checked.

• **2.3GHz Band Information**



Figure 58. 2.3GHz ROU Band Information Screen.

① **2.3GHz Alarm**

Item to check 2.3GHz module VSWR alarm and temperature alarm.

② **2.3GHz TX Signal Monitoring and Control**

The RF signal output level(Downlink) of 2.3GHz band received from the MHU can be checked on this item, and the output level can be manually adjusted by controlling ATTen. according to the operator. Also, ALC function is configured for the user to automatically adjust output level by inputting the desired ALC level and turning the function ON.

③ **2.3GHz RX Signal Monitoring and Control**

The RF signal input level(Uplink) of 2.3GHz band received from the terminal can be checked on this item. Also, same as TX, input level can be manually adjusted by controlling ATTen., and automatic input level adjustment through ALC is implemented.

④ **2.3GHz TX Shutdown and Delay Control**

Item implements shutdown function of automatically turning HPA off when 2.3GHz TX output signal gets high due to overpower. User can set shutdown signal level, function operates when switch is on.

Also, item is configured with delay control item to control 2.3GHz system delay. When user inputs specific value on this delay window, 2.3GHz system delay applies with the user input value added.

⑤ **2.3GHz Channel Status**

Item cannot be controlled on the ROU screen, the operator label, channel filter type, downlink frequency, uplink frequency set from MHU per each operator can be checked.

• **2.5GHz Band Information**

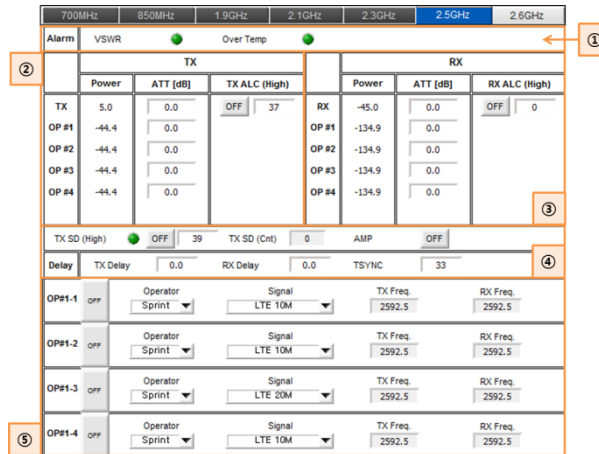

Figure 59. 2.5GHz ROU Band Information Screen.

① **2.5GHz Alarm**

Item to check 2.5GHz module VSWR alarm and temperature alarm.

② **2.5GHz TX Signal Monitoring and Control**

The RF signal output level(Downlink) of 2.5GHz band received from the MHU can be checked on this item, and the output level can be manually adjusted by controlling ATTen. according to the operator. Also, ALC function is configured for the user to automatically adjust output level by inputting the desired ALC level and turning the function ON.

③ **2.5GHz RX Signal Monitoring and Control**

The RF signal input level(Uplink) of 2.5GHz band received from the terminal can be checked on this item. Also, same as TX, input level can be manually adjusted by controlling ATTen., and automatic input level adjustment through ALC is implemented.

④ **2.5GHz TX Shutdown and Delay Control**

Item implements shutdown function of automatically turning HPA off when 2.5GHz TX output signal gets high due to overpower. User can set shutdown signal level, function operates when switch is on.

Also, item is configured with delay control item to control 2.5GHz system delay. When user inputs specific value on this delay window, 2.5GHz system delay applies with the user input value added.

⑤ 2.5GHz Channel Status

Item cannot be controlled on the ROU screen, the operator label, channel filter type, downlink frequency, uplink frequency set from MHU per each operator can be checked.

• 2.6GHz Band Information

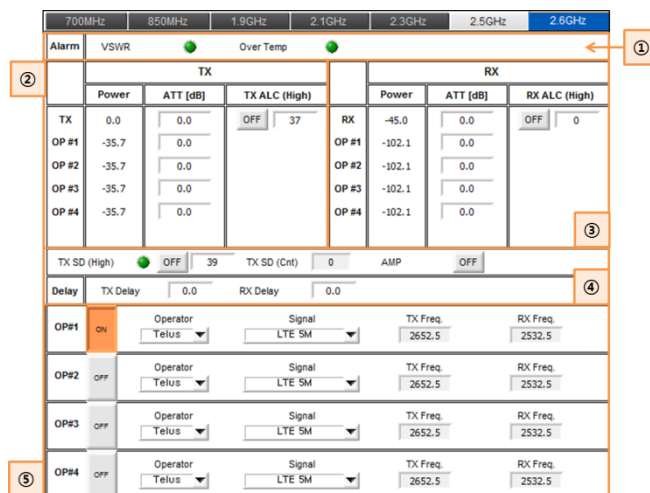

Figure 60. 2.6GHz ROU Band Information Screen.

① 2.6GHz Alarm

Item to check 2.6GHz module VSWR alarm and temperature alarm.

② 2.6GHz TX Signal Monitoring and Control

The RF signal output level(Downlink) of 2.6GHz band received from the MHU can be checked on this item, and the output level can be manually adjusted by controlling ATTen. according to the operator. Also, ALC function is configured for the user to automatically adjust output level by inputting the desired ALC level and turning the function ON.

③ 2.6GHz RX Signal Monitoring and Control

The RF signal input level(Uplink) of 2.6GHz band received from the terminal can be checked on this item. Also, same as TX, input level can be manually adjusted by controlling ATTen., and automatic input level adjustment through ALC is implemented.

④ 2.6GHz TX Shutdown and Delay Control

Item implements shutdown function of automatically turning HPA off when 2.6GHz TX output signal gets high due to overpower. User can set shutdown signal level, function operates when switch is on.

Also, item is configured with delay control item to control 2.6GHz system delay. When user inputs specific value on this delay window, 2.6GHz system delay applies with the user input value added.

⑤ 2.6GHz Channel Status

Item cannot be controlled on the ROU screen, the operator label, channel filter type, downlink frequency, uplink frequency set from MHU per each operator can be checked.

Chapter 7

Alarm and Corrective Action

7.1 Alarm Phenomenon and Solution

Alarm and Corrective Action

7.1 Alarm Phenomenon and Solution

7.1.1 AC Alarm (MHU, ROU)

Phenomenon	Cause
<ul style="list-style-type: none"> - PSU LED : PSU AC LED Off - Alarm window : green → red 	<ul style="list-style-type: none"> - When equipment input power 120V/AC does not normally input

Solution and Action

- Solution : Check if input power 120V/AC is normal.
- Action : Check if input power 120V/AC is normal, and if there is no abnormality, replace PSU and check if it operates normally.

7.1.2 LD Alarm (MHU, ROU)

Phenomenon	Cause
<ul style="list-style-type: none"> - Alarm window : green → red 	<ul style="list-style-type: none"> - When optic module LD does not work normally

Solution and Action

- Solution : Replace optic module
- Action : Replace optic module and check if it works normally.

7.1.3 PD Alarm (MHU, ROU)

Phenomenon	Cause
<ul style="list-style-type: none"> - Alarm window : green → red 	<ul style="list-style-type: none"> - When optic module PD does not work normally

Solution and Action

- Solution : Clean the optic connector with alcohol and check optic cable or replace optic module
- Action : Clean the optic connector with alcohol and check optic cable for abnormality, take action if abnormality is found. If there is no abnormality, replace optic module and check if it works normally.

7.1.4 TX/RX PLL Alarm (MHU, ROU)

Phenomenon	Cause
- Alarm window : green → red	- MHU : When TX PLL within MRFU is abnormal - ROU: When TX PLL within RRFU is abnormal

Solution and Action

- Solution : Replace MRFU for MHU, replace RRFU for ROU
- Action : For MHU, replace MRFU of frequency band that alarm generated and check if it works normally, for ROU, same as MHU, replace RRFU of frequency band that alarm generated and check if it works normally

7.1.5 Internal FAN Alarm (MHU, ROU)

Phenomenon	Cause
- Alarm window : green → red	- When internal equipment FAN is abnormal

Solution and Action

- Solution : Check FAN supply power and replace FAN
- Action : Check and replace FAN, check if it operates normally.

7.1.6 External FAN Alarm (ROU)

Phenomenon	Cause
- Alarm window : green → red	- When external equipment FAN is abnormal

Solution and Action

- Solution : Check FAN supply power and replace FAN
- Action : Check and replace FAN, check if it operates normally.

7.1.7 TX S/D(High) Alarm (ROU)

Phenomenon	Cause
- Alarm window : green → red	- When TX output level is higher than shutdown alarm set value

Solution and Action

- Solution : Set to appropriate TX ATTen.
- Action : Set TX ATTen. appropriately according to the environment, turn ALC on and prevent shutdown.

7.1.8 DTU Alarm (MHU, ROU)

Phenomenon	Cause
- Alarm window : green → red	- When DTU board abnormality such as DTU board connection harness, DTU board clock, DTU board telecommunication abnormality occurs

Solution and Action

- Solution : Replace DTU board connection harness or if abnormality still occurs after 10MHz reference signal input replace DTU board.
- Action : Check DTU board connection harness, input reference signal and replace DTU board and check if it works normally,.

7.1.9 DTU Link Fail Alarm (MHU, ROU)

Phenomenon	Cause
- Alarm window : green → red	- When telecommunication between DTU board and CPU abnormality occurs

Solution and Action

- Solution : Check DTU board and back board connection status and check reference clock
- Action : Check DTU board connection status and replace DTU board

7.1.10 VSWR Alarm (ROU)

Phenomenon	Cause
- Alarm window : green → red	- When antenna input port and AMP abnormality occurs

Solution and Action

- Solution : Check antenna input port connection status and if there is no abnormality replace AMP
- Action : Check antenna input port, if there is no abnormality replace AMP and check if it works normally.

7.1.11 Over Temp (ROU)

Phenomenon	Cause
- Alarm window : green → red	- When RRFU integration module temperature is over 85°C

Solution and Action

- Solution : Check temperature table, if there is abnormality when set to static temperature replace AMP
- Action : Replace RRFU integration module and check if it works normally.

INOVA DAS **Operating Manual**

Fiber Radio Technologies CO., LTD.
All rights reserved.

- Copyright © FRTek Co., Ltd. All rights reserved.
- Without any authorization of FRTek Co., Ltd., the disclosure, distribution, reproduction and reuse of all or part of the information in this manual to the 3rd party are strictly prohibited

