FCC Test Report

Report No.: AGC01080161001FE03

FCC ID : 2AFDG-VA-SK003
APPLICATION PURPOSE : Original Equipment
PRODUCT DESIGNATION : TRUE WIRELESS SPEAKER
BRAND NAME : VAVA
MODEL NAME : VA-SK003
CLIENT : SUNVALLEYTEK INTERNATIONAL, INC.
DATE OF ISSUE : Nov.30, 2016
STANDARD(S) : FCC Part 15 Rules
TEST PROCEDURE(S)
REPORT VERSION : V1.0

Attestation of Global Compliance (Shenzhen) Co., Ltd



CAUTION:

This report shall not be reproduced except in full without the written permission of the test laboratory and shall not be quoted out of context.



Report Revise Record

Report Version	Revise Time	Issued Date	Valid Version	Notes
V1.0	/	Nov.30, 2016	Valid	Original Report

TABLE OF CONTENTS

1. VERIFICATION OF CONFORMITY	4
2. GENERAL INFORMATION	5
2.1. PRODUCT DESCRIPTION	5
2.2. TABLE OF CARRIER FREQUENCYS	5
3. MEASUREMENT UNCERTAINTY.....	6
4. DESCRIPTION OF TEST MODES.....	6
5. SYSTEM TEST CONFIGURATION	8
5.1. CONFIGURATION OF EUT SYSTEM.....	8
5.2. EQUIPMENT USED IN EUT SYSTEM.....	8
5.3. SUMMARY OF TEST RESULTS.....	8
6. TEST FACILITY	9
TEST METHODOLOGY.....	9
7. ALL TEST EQUIPMENT LIST	9
8. RADIATED EMISSION	11
8.1TEST LIMIT.....	11
8.2. MEASUREMENT PROCEDURE.....	12
8.3. TEST SETUP.....	14
8.4. TEST RESULT	16
9. BAND EDGE EMISSION	31
9.1. MEASUREMENT PROCEDURE.....	31
9.2 TEST SETUP.....	31
9.3 RADIATED TEST RESULT	32
10. 20DB BANDWIDTH.....	36
10.1. MEASUREMENT PROCEDURE.....	36
10.2. TEST SET-UP.....	36
10.3. LIMITS AND MEASUREMENT RESULTS.....	36
11. FCC LINE CONDUCTED EMISSION TEST	43
11.1. LIMITS OF LINE CONDUCTED EMISSION TEST	43
11.2. BLOCK DIAGRAM OF LINE CONDUCTED EMISSION TEST	43
11.3. PRELIMINARY PROCEDURE OF LINE CONDUCTED EMISSION TEST	44
11.4. FINAL PROCEDURE OF LINE CONDUCTED EMISSION TEST	44
11.5. TEST RESULT OF LINE CONDUCTED EMISSION TEST	45
APPENDIX A: PHOTOGRAPHS OF TEST SETUP	47
APPENDIX B: PHOTOGRAPHS OF EUT	50

1. VERIFICATION OF CONFORMITY

Applicant	SUNVALLEYTEK INTERNATIONAL, INC.
Address	46724 Lakeview Blvd, Fremont, CA 94538-6529
Manufacturer	Shenzhen NearbyExpress Technology Development Company Limited
Address	Block D, Minle Industrial Park, Meiban Road, Longhua District, Shenzhen, China. 518131
Product Designation	TRUE WIRELESS SPEAKER
Brand Name	VAVA
Test Model	VA-SK003
Date of test	Oct,17, 2016 to Oct.18, 2016
Deviation	None
Condition of Test Sample	Normal
Report Template	AGCRT-US-BR/RF

We hereby certify that:

The above equipment was tested by Dongguan Precise Testing Service Co., Ltd. The test data, the energy emitted by the sample tested as described in this report is in compliance with the requirements of FCC Rules Part 15.249.

Strive Liang

Tested By _____
Strive Liang(Liang Faqiang) Oct.18, 2016

Forrest Lei

Reviewed By _____
Forrest Lei(Lei Yonggang) Nov.30, 2016

Solger Zhang

Approved By _____
Solger Zhang(Zhang Hongyi)
Authorized Officer Nov.30, 2016

2. GENERAL INFORMATION

2.1. PRODUCT DESCRIPTION

A major technical description of EUT is described as following

Operation Frequency	2.402 GHz to 2.480GHz
RF Output Power	1.67dBm
Bluetooth Version	V4.1
Modulation	GFSK, $\pi/4$ -DQPSK, 8DPSK
Number of channels	79 for BR/EDR
Hardware Version	VER:04
Software Version	V2.0
Antenna Designation	Fixed Antenna
Antenna Gain	0dBi
Battery Rated Voltage	DC 14.8V
Charging by Adapter-1	INPUT: 100-240V, 50/60Hz, 0.8A OUTPUT: 18.0V 2.0A Model:NBS30S05200HU
Charging by Adapter-2	INPUT: 100-240V, 50/60Hz, 70-100VA 0.8A OUTPUT: 18.0V 2.0A Model:NBS30D180200D5

Note: 1. The USB port only be used for power supply and can't be used to transfer data with PC.
2. The EUT didn't support BLE.

2.2. TABLE OF CARRIER FREQUENCIES

BR/EDR channel List

Frequency Band	Channel Number	Frequency
2400~2483.5MHZ	0	2402MHZ
	1	2403MHZ
	:	:
	38	2440 MHZ
	39	2441 MHZ
	40	2442 MHZ
	:	:
	77	2479 MHZ
	78	2480 MHZ

3. MEASUREMENT UNCERTAINTY

The reported uncertainty of measurement $y \pm U$, where expanded uncertainty U is based on a standard uncertainty multiplied by a coverage factor of $k=2$, providing a level of confidence of approximately 95 %.

No.	Item	Uncertainty
1	Conducted Emission Test	± 3.18 dB
2	All emissions, radiated	± 3.91 dB
3	Temperature	± 0.5 °C
4	Humidity	± 2 %

4. DESCRIPTION OF TEST MODES

NO.	TEST MODE DESCRIPTION
1	Low channel GFSK
2	Middle channel GFSK
3	High channel GFSK
4	Low channel $\pi/4$ -DQPSK
5	Middle channel $\pi/4$ -DQPSK
6	High channel $\pi/4$ -DQPSK
7	Low channel 8DPSK
8	Middle channel 8DPSK
9	High channel 8DPSK
10	BT Link with charging
11	BT Link

Note:

1. All the test modes can be supply by battery, only the result of the worst case was recorded in the report, if no other cases.
2. For Radiated Emission, 3axis were chosen for testing for each applicable mode.
3. The EUT used fully-charged battery when tested.

Software Setting

The screenshot displays the 'Software Setting' window of the 'Airoha AB1500 Family LAB Test Tool - Version 1.4.11.0'. The interface includes a menu bar with 'View' and 'Help', a toolbar with icons for COM1 selection, error, settings, pause, and execution, and a tabbed interface with 'TX', 'RX', 'Crystal Trim', and 'Test Mode' tabs. The 'TX' tab is active, showing configuration fields for 'RF Freq.(MHz)' (2402), 'Tx GC' (63), 'PKT Type' (2-DH3), and 'Data Type' (PN sequence). There are buttons for 'Write GC to EEPROM (BR)', 'Write GC to EEPROM (EDR)', and 'Execute'. A section for 'Specific Channels Hopping by continuous fixed channel switching' includes a table of channel ranges and their corresponding PN sequences, along with a 'Hopping Interval (ms)' of 10 and buttons for 'Start specific channels BTx' and 'Stop'. A log window at the bottom shows five 'BTx Packet Complete!' messages with timestamps. The status bar at the bottom indicates 'Serial Port Settings' (BaudRate: 115200, Parity: None, Handshake: None), a 'Status' field, and 'EEPROM Error: False, Power'.

Channels	PN Sequence
Channels 15-0	1111111111111111
Channels 31-16	1111111111111111
Channels 47-32	1111111111111111
Channels 63-48	1111111111111111
Channels 78-64	0111111111111111

5. SYSTEM TEST CONFIGURATION

5.1. CONFIGURATION OF EUT SYSTEM

Configure 1: (Normal hopping)

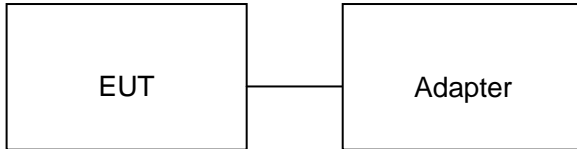

Configure 2: (Control continuous TX)

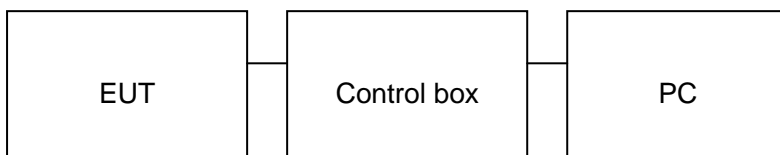

5.2. EQUIPMENT USED IN EUT SYSTEM

Item	Equipment	Mfr/Brand	Model/Type No.	Remark
1	TRUE WIRELESS SPEAKER	VAVA	VA-SK003	EUT
2	Battery	Great Power	ICR18650x4	Accessory
3	PC	Sony	E1412AYCW	A.E
4	Control box	AIROHA	BT_USB to UART	A.E
5	Adapter-1	Vere	NBS30D180200HU	Accessory
6	Adapter-2	Vere	NBS30D180200D5	Accessory

5.3. SUMMARY OF TEST RESULTS

FCC RULES	DESCRIPTION OF TEST	RESULT
§15.249	Radiated Emission	Compliant
§15.249	Band Edges	Compliant
§15.207	Conduction Emission	Compliant
§15.215	Bandwidth	Compliant

6. TEST FACILITY

Site	Dongguan Precise Testing Service Co., Ltd.
Location	Building D,Baoding Technology Park,Guangming Road2,Dongcheng District, Dongguan, Guangdong, China,
FCC Registration No.	371540
Description	The test site is constructed and calibrated to meet the FCC requirements in documents ANSI C63.4:2014.

TEST METHODOLOGY

All measurements contained in this report were conducted with ANSI C63.10-2013

7. ALL TEST EQUIPMENT LIST

FOR RADIATED EMISSION TEST (BELOW 1GHZ)

Radiated Emission Test Site					
Name of Equipment	Manufacturer	Model Number	Serial Number	Last Calibration	Due Calibration
EMI Test Receiver	ROHDE&SCHWARZ	ESCI	101417	July 4, 2016	July 3, 2017
Trilog Broadband Antenna (25M-1GHz)	SCHWARZBECK	VULB9160	9160-3355	July 4, 2016	July 3, 2017
Signal Amplifier	SCHWARZBECK	BBV 9475	9745-0013	July 4, 2016	July 3, 2017
RF Cable	SCHWARZBECK	AK9515E	96221	July 4, 2016	July 3, 2017
3m Anechoic Chamber	CHENGYU	966	PTS-001	June 6, 2016	June 5, 2017
MULTI-DEVICE Positioning Controller	MAX-FULL	MF-7802	MF780208339	N/A	N/A
Active loop antenna (9K-30MHz)	SCHWARZBECK	FMZB1519	1519-038	June 6, 2016	June 5, 2017
Spectrum analyzer	AGILENT	E4407B	MY46185649	June 6, 2016	June 5, 2017
Radiation Cable 1	MXT	RS1	R005	June 6, 2016	June 5, 2017
Radiation Cable 2	MXT	RS1	R006	June 6, 2016	June 5, 2017

FOR RADIATED EMISSION TEST (1GHZ ABOVE)

Radiated Emission Test Site					
Name of Equipment	Manufacturer	Model Number	Serial Number	Last Calibration	Due Calibration
EMI Test Receiver	ROHDE&SCHWARZ	ESCI	101417	July 4, 2016	July 3, 2017
Horn Antenna (1G-18GHz)	SCHWARZBECK	BBHA9120D	9120D-1246	July 11, 2016	July 10, 2017
Spectrum Analyzer	AGILENT	E4411B	MY4511453	July 4, 2016	July 3, 2017
Signal Amplifier	SCHWARZBECK	BBV 9718	9718-269	July 7, 2016	July 6, 2017
RF Cable	SCHWARZBECK	AK9515H	96220	July 8, 2016	July 7, 2017
3m Anechoic Chamber	CHENGYU	966	PTS-001	June 6, 2016	June 5, 2017
MULTI-DEVICE Positioning Controller	MAX-FULL	MF-7802	MF780208339	N/A	N/A
Horn Ant (18G-40GHz)	SCHWARZBECK	BBHA 9170	9170-181	June 6, 2016	June 5, 2017
Radiation Cable 1	MXT	RS1	R005	June 6, 2016	June 5, 2017
Radiation Cable 2	MXT	RS1	R006	June 6, 2016	June 5, 2017

Conducted Emission Test Site					
Name of Equipment	Manufacturer	Model Number	Serial Number	Last Calibration	Due Calibration
EMI Test Receiver	ROHDE&SCHWARZ	ESCI	101417	July 4, 2016	July 3, 2017
Artificial Mains Network	NARDA	L2-16B	000WX31025	July 8, 2016	July 7, 2017
Artificial Mains Network (AUX)	NARDA	L2-16B	000WX31026	July 8, 2016	July 7, 2017
RF Cable	SCHWARZBECK	AK9515E	96222	July 4, 2016	July 3, 2017
Shielded Room	CHENGYU	843	PTS-002	June 6, 2016	June 5, 2017
Conduction Cable	MXT	SE1	S003	June 6, 2016	June 5, 2017

8. RADIATED EMISSION

8.1 TEST LIMIT

Standard FCC15.249

Fundamental Frequency	Field Strength of Fundamental (millivolts/meter)	Field Strength of Harmonics (microvolts/meter)
900-928MHz	50	500
2400-2483.5MHz	50	500
5725-5875MHz	50	500
24.0-24.25GHz	250	2500

Standard FCC 15.209

Frequency (MHz)	Distance Meters	Field Strengths Limit	
		μ V/m	dB(μ V)/m
0.009 ~ 0.490	300	2400/F(kHz)	---
0.490 ~ 1.705	30	24000/F(kHz)	---
1.705 ~ 30	30	30	---
30 ~ 88	3	100	40.0
88 ~ 216	3	150	43.5
216 ~ 960	3	200	46.0
960 ~ 1000	3	500	54.0
Above 1000	3	Other:74.0 dB(μ V)/m (Peak) 54.0 dB(μ V)/m (Average)	

Remark: (1) Emission level $\text{dB}\mu\text{V} = 20 \log \text{Emission level } \mu\text{V/m}$
(2) The smaller limit shall apply at the cross point between two frequency bands.
(3) Distance is the distance in meters between the measuring instrument, antenna and the closest point of any part of the device or system.

8.2. MEASUREMENT PROCEDURE

1. The measuring distance of 3m shall be used for measurements. The EUT was placed on the top of a rotating table 0.8 meter above the ground at a 3 meter semi-anechoic chamber. The table was rotated 360 degrees to determine the position of the highest radiation(Below 1GHz)
2. The measuring distance of 3m shall used for measurements. The EUT was placed on the top of a rotating table 1.5 meter above the ground at a 3 meter semi-anechoic chamber. The table was rotated 360 degrees to determine the position of the highest radiation(Above 1GHz)
3. The height of the test antenna shall vary between 1m to 4m.Both horizontal and vertical polarization Of the antenna are set to make the measurement.
4. The initial step in collecting radiated emission data is a receive peak detector mode. Pre-scanning the measurement frequency range. Significant peaks are then marked and then Quasi Peak detector mode re-measured.
5. All readings are peak unless otherwise stated QP in column of Note. Peak denoted that the Peak reading compliance with the QP limits and then QP Mode measurement didn't perform(Below 1GHz)
6. All readings are Peak mode value unless otherwise stated AVG in column of Note. If the Peak mode measured value compliance with the Peak limits and lower than AVG Limits, the EUT shall be deemed to meet Peak&AVG limits and then only Peak mode was measured, but AVG mode didn't perform.(Above 1GHz)

The following table is the setting of spectrum analyzer and receiver.

Spectrum Parameter	Setting
Start ~Stop Frequency	9KHz~150KHz/RB 200Hz for QP
Start ~Stop Frequency	150KHz~30MHz/RB 9KHz for QP
Start ~Stop Frequency	30MHz~1000MHz/RB 120KHz for QP
Start ~Stop Frequency	1GHz~26.5GHz 1MHz/3MHz for Peak, 1MHz/10Hz for Average
Receiver Parameter	Setting
Start ~Stop Frequency	9KHz~150KHz/RB 200Hz for QP
Start ~Stop Frequency	150KHz~30MHz/RB 9KHz for QP
Start ~Stop Frequency	30MHz~1000MHz/RB 120KHz for QP

8.3. TEST SETUP

Radiated Emission Test-Setup Frequency Below 30MHz



RADIATED EMISSION TEST SETUP 30MHz-1000MHz

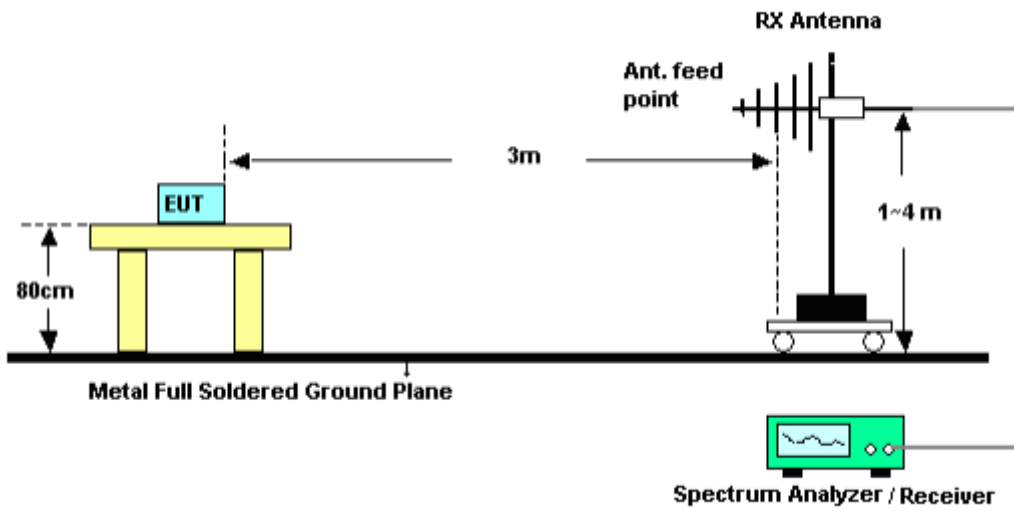

RADIATED EMISSION TEST SETUP ABOVE 1000MHz



8.4. TEST RESULT

(Worst modulation:GFSK)

FOR BR/EDR

RADIATED EMISSION BELOW 30MHZ

No emission found between lowest internal used/generated frequencies to 30MHz.

RADIATED EMISSION BELOW 1GHZ

RADIATED EMISSION TEST- (30MHZ-1GHZ)-LOW CHANNEL-HORIZONTAL

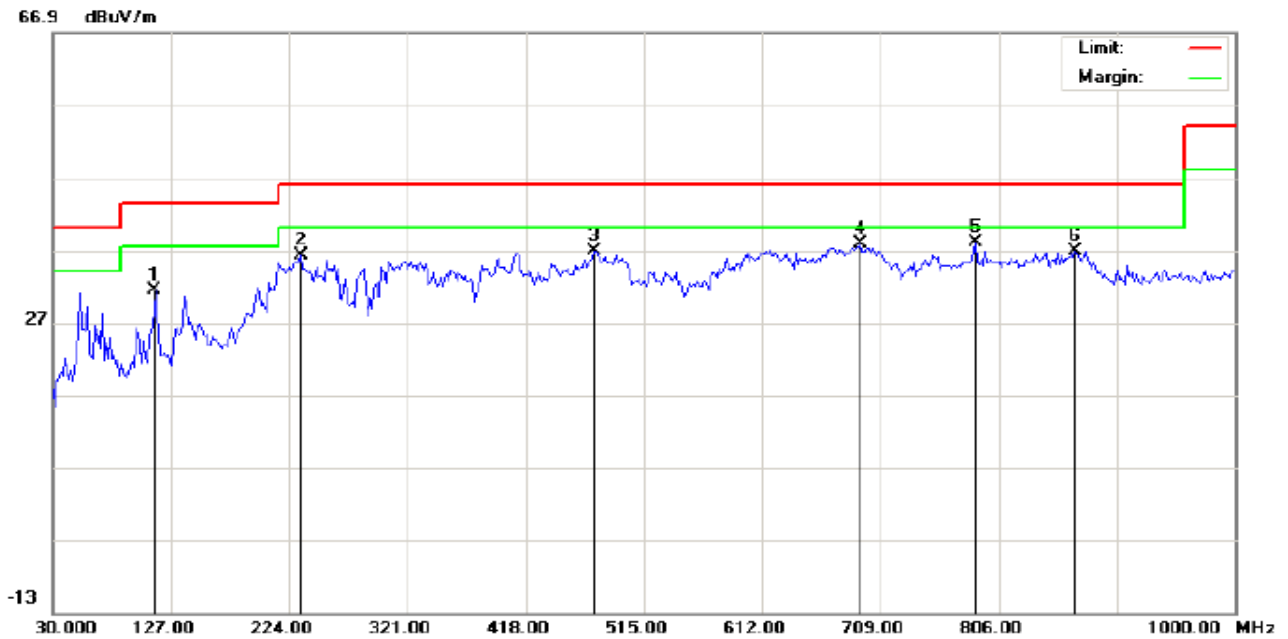

Site: site #1
 Limit: FCC Class B 3M Radiation
 EUT:TRUE WIRELESS SPEAKER
 M/N:VA-SK003
 Mode:Low Channel TX
 Note:

Polarization: *Horizontal*
 Power:
 Distance:

Temperature: 24.1
 Humidity: 53.9 %

No.	Mk	Freq.	Reading	Factor	Measurement	Limit	Over	Detector	Antenna Height	Table Degree	Comment
		MHz	dBuV	dB/m	dBuV/m	dBuV/m	dB		cm	degree	
1		114.0666	24.20	7.23	31.43	43.50	-12.07	peak			
2		233.6999	27.61	8.56	36.17	46.00	-9.83	peak			
3		474.5833	15.89	20.86	36.75	46.00	-9.25	peak			
4		692.8333	12.84	25.00	37.84	46.00	-8.16	peak			
5	*	786.6000	10.92	27.14	38.06	46.00	-7.94	peak			
6		869.0499	9.03	27.81	36.84	46.00	-9.16	peak			

RESULT: PASS

RADIATED EMISSION TEST- (30MHZ-1GHZ)-LOW CHANNEL -VERTICAL

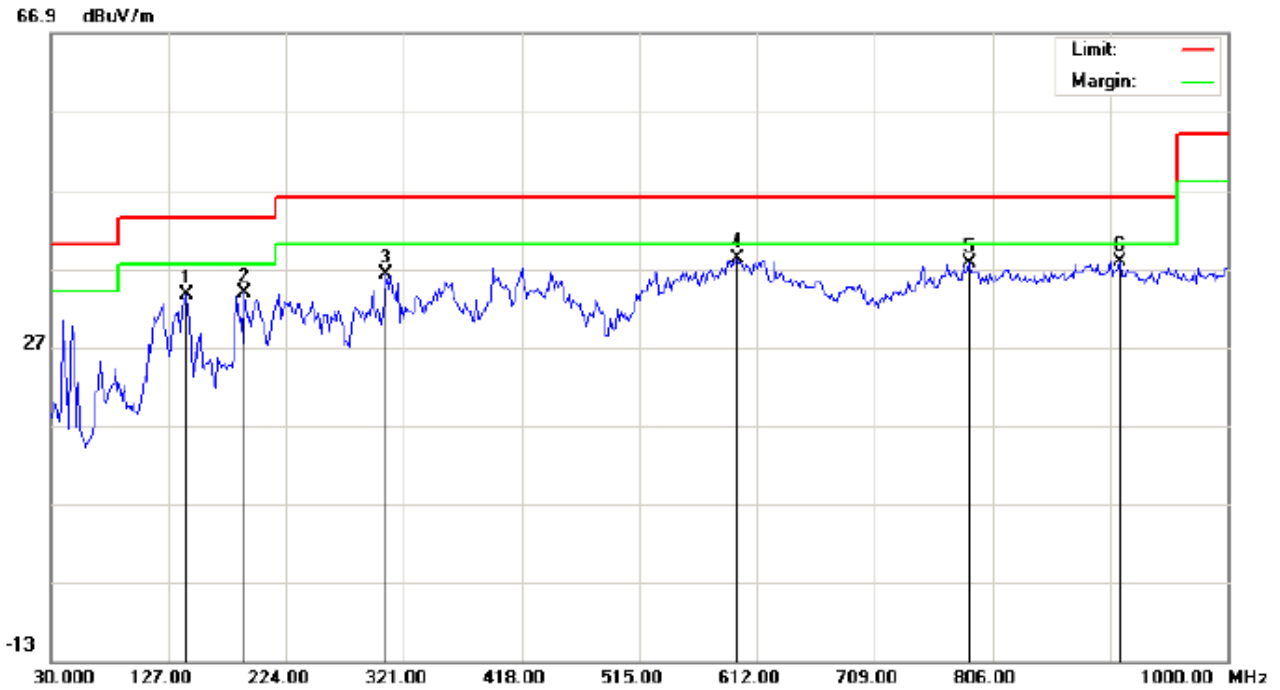

Site: site #1
 Limit: FCC Class B 3M Radiation
 EUT:TRUE WIRELESS SPEAKER
 M/N:VA-SK003
 Mode:Low Channel TX
 Note:

Polarization: *Vertical*
 Power:
 Distance:

Temperature: 24.1
 Humidity: 53.9 %

No.	Mk	Freq.	Reading	Factor	Measurement	Limit	Over	Detector	Antenna Height	Table Degree	Comment
		MHz	dBuV	dB/m	dBuV/m	dBuV/m	dB		cm	degree	
1		141.5500	18.39	15.21	33.60	43.50	-9.90	peak			
2		190.0500	22.28	11.52	33.80	43.50	-9.70	peak			
3		306.4499	20.40	15.84	36.24	46.00	-9.76	peak			
4	*	595.8333	15.42	22.71	38.13	46.00	-7.87	peak			
5		786.6000	10.53	27.14	37.67	46.00	-8.33	peak			
6		911.0833	8.95	28.92	37.87	46.00	-8.13	peak			

RESULT: PASS

Note: 1. Factor=Antenna Factor + Cable loss, Margin=Measurement-Limit.

2. The "Factor" value can be calculated automatically by software of measurement system.

RADIATED EMISSION TEST- (30MHZ-1GHZ)-MIDDLE CHANNEL-HORIZONTAL

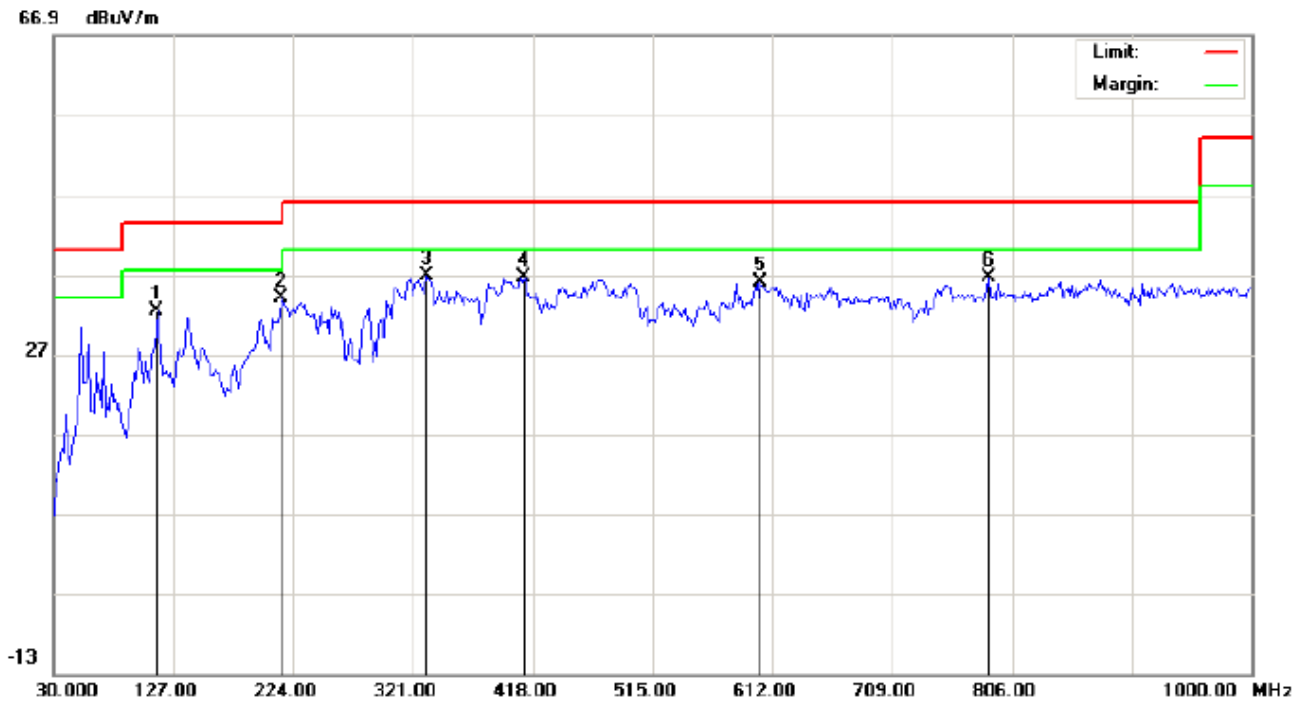

Site: site #1
Limit: FCC Class B 3M Radiation
EUT:TRUE WIRELESS SPEAKER
M/N:VA-SK003
Mode:Middle Channel TX
Note:

Polarization: *Horizontal*
Power:
Distance:

Temperature: 24.1
Humidity: 53.9 %

No.	Mk	Freq.	Reading	Factor	Measurement	Limit	Over	Detector	Antenna Height	Table Degree	Comment
		MHz	dBuV	dB/m	dBuV/m	dBuV/m	dB		cm	degree	
1		114.0666	25.20	7.23	32.43	43.50	-11.07	peak			
2		214.3000	23.38	10.54	33.92	43.50	-9.58	peak			
3	*	332.3167	19.15	17.56	36.71	46.00	-9.29	peak			
4		411.5332	17.22	19.42	36.64	46.00	-9.36	peak			
5		602.2999	12.19	23.74	35.93	46.00	-10.07	peak			
6		786.6000	9.42	27.14	36.56	46.00	-9.44	peak			

RESULT: PASS

RADIATED EMISSION TEST- (30MHZ-1GHZ)- MIDDLE CHANNEL -VERTICAL

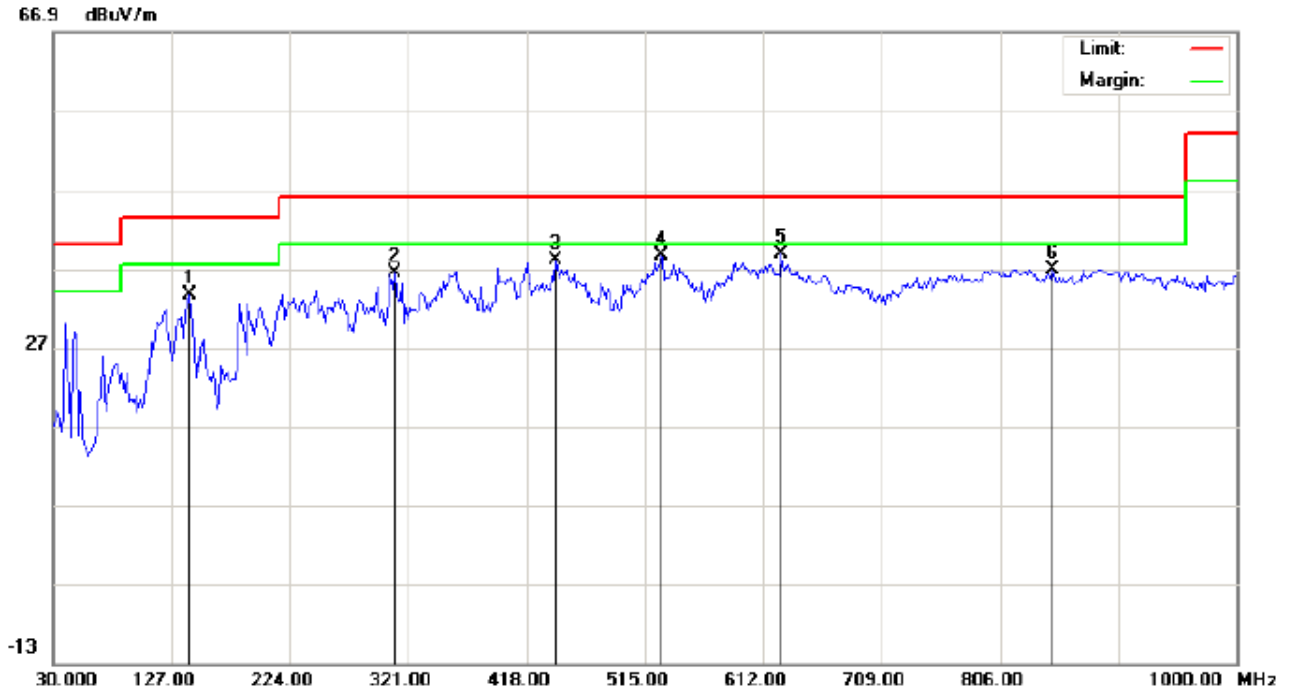

Site: site #1
Limit: FCC Class B 3M Radiation
EUT:TRUE WIRELESS SPEAKER
M/N:VA-SK003
Mode:Middle Channel TX
Note:

Polarization: *Vertical*
Power:
Distance:

Temperature: 24.1
Humidity: 53.9 %

No.	Mk	Freq.	Reading	Factor	Measurement	Limit	Over	Detector	Antenna Height	Table Degree	Comment
		MHz	dBuV	dB/m	dBuV/m	dBuV/m	dB		cm	degree	
1		141.5500	18.39	15.21	33.60	43.50	-9.90	peak			
2		309.6832	20.41	16.05	36.46	46.00	-9.54	peak			
3		442.2500	17.60	20.35	37.95	46.00	-8.05	peak			
4		527.9333	16.80	21.88	38.68	46.00	-7.32	peak			
5	*	626.5499	15.48	23.32	38.80	46.00	-7.20	peak			
6		849.6499	9.59	27.31	36.90	46.00	-9.10	peak			

RESULT: PASS

Note: 1. Factor=Antenna Factor + Cable loss, Margin=Measurement-Limit.

2. The "Factor" value can be calculated automatically by software of measurement system.

RADIATED EMISSION TEST- (30MHZ-1GHZ)-HIGH CHANNEL-HORIZONTAL

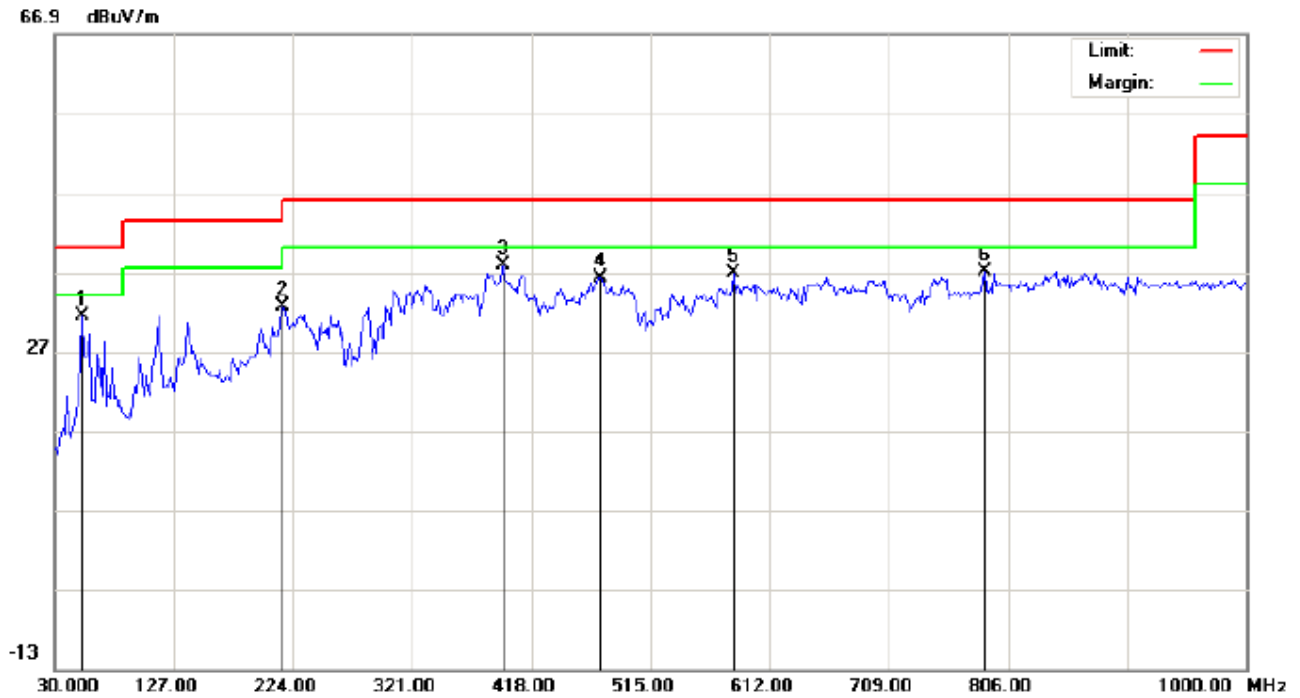

Site: site #1
Limit: FCC Class B 3M Radiation
EUT:TRUE WIRELESS SPEAKER
M/N:VA-SK003
Mode:High Channel TX
Note:

Polarization: *Horizontal*
Power:
Distance:

Temperature: 24.1
Humidity: 53.9 %

No.	Mk	Freq.	Reading	Factor	Measurement	Limit	Over	Detector	Antenna Height	Table Degree	Comment
		MHz	dBuV	dB/m	dBuV/m	dBuV/m	dB		cm	degree	
1		52.6332	23.07	8.41	31.48	40.00	-8.52	peak			
2		215.9166	22.26	10.38	32.64	43.50	-10.86	peak			
3	*	395.3666	18.68	19.04	37.72	46.00	-8.28	peak			
4		474.5833	15.39	20.86	36.25	46.00	-9.75	peak			
5		582.8999	13.50	23.30	36.80	46.00	-9.20	peak			
6		786.6000	9.92	27.14	37.06	46.00	-8.94	peak			

RESULT: PASS

RADIATED EMISSION TEST- (30MHZ-1GHZ)-HIGH CHANNEL -VERTICAL

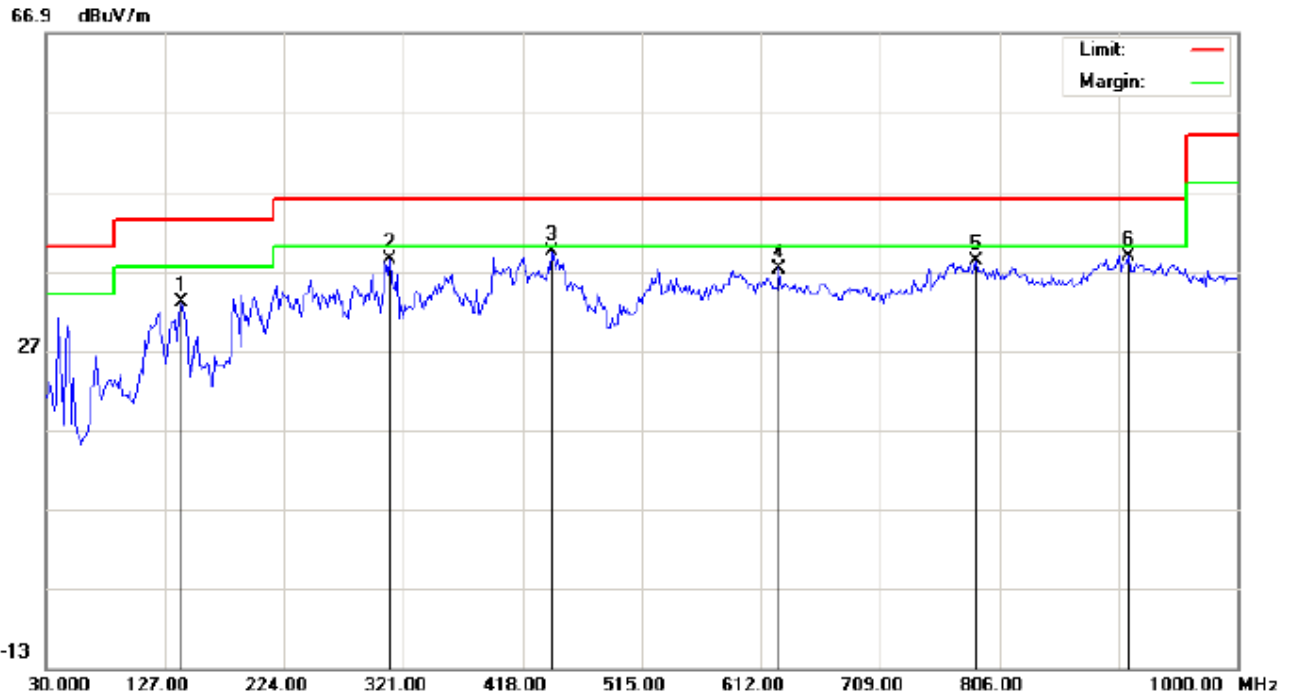

Site: site #1
Limit: FCC Class B 3M Radiation
EUT:TRUE WIRELESS SPEAKER
M/N:VA-SK003
Mode:High Channel TX
Note:

Polarization: *Vertical*
Power:
Distance:

Temperature: 24.1
Humidity: 53.9 %

No.	Mk	Freq.	Reading	Factor	Measurement	Limit	Over	Detector	Antenna Height	Table Degree	Comment
		MHz	dBuV	dB/m	dBuV/m	dBuV/m	dB		cm	degree	
1		139.9333	17.87	15.17	33.04	43.50	-10.46	peak			
2		309.6832	22.41	16.05	38.46	46.00	-7.54	peak			
3	*	442.2500	19.10	20.35	39.45	46.00	-6.55	peak			
4		626.5499	13.98	23.32	37.30	46.00	-8.70	peak			
5		786.6000	11.03	27.14	38.17	46.00	-7.83	peak			
6		911.0833	9.95	28.92	38.87	46.00	-7.13	peak			

RESULT: PASS

Note: 1. Factor=Antenna Factor + Cable loss, Margin=Measurement-Limit.

2. The "Factor" value can be calculated automatically by software of measurement system.

RADIATED EMISSION ABOVE 1GHZ
(Worst modulation: GFSK)
FOR BR/EDR

RADIATED EMISSION TEST- (ABOVE 1GHZ)-LOW CHANNEL-HORIZONTAL

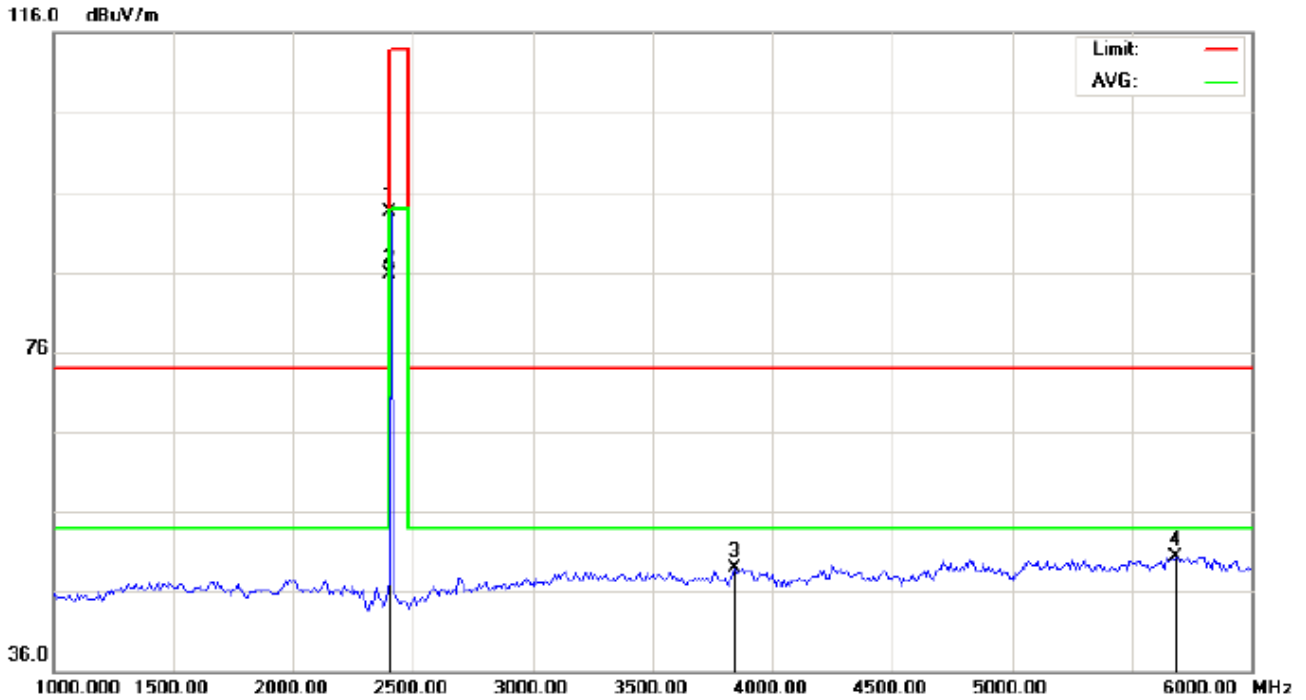

Site: site #1	Polarization: <i>Horizontal</i>	Temperature: 22.7
Limit: FCC Class B 3M Radiation above 1GHZ(PK)-	Power:	Humidity: 53.6 %
EUT:TRUE WIRELESS SPEAKER	Distance:	
M/N:VA-SK003		
Mode: Low Channel TX		
Note:		

No.	Mk	Freq.	Reading	Factor	Measurement	Limit	Over	Detector	Antenna Height	Table Degree	Comment
		MHz	dBuV	dB/m	dBuV/m	dBuV/m	dB		cm	degree	
1		2402.000	83.21	10.32	93.53	114.00	-20.47	peak			
2	*	2402.000	75.32	10.32	85.64	94.00	-8.36	AVG	150	294	
3		3841.667	34.76	14.21	48.97	74.00	-25.03	peak			
4		5683.333	52.07	-1.73	50.34	74.00	-23.66	peak			

RESULT: PASS

RADIATED EMISSION TEST- (ABOVE 1GHZ)-LOW CHANNEL- VERTICAL

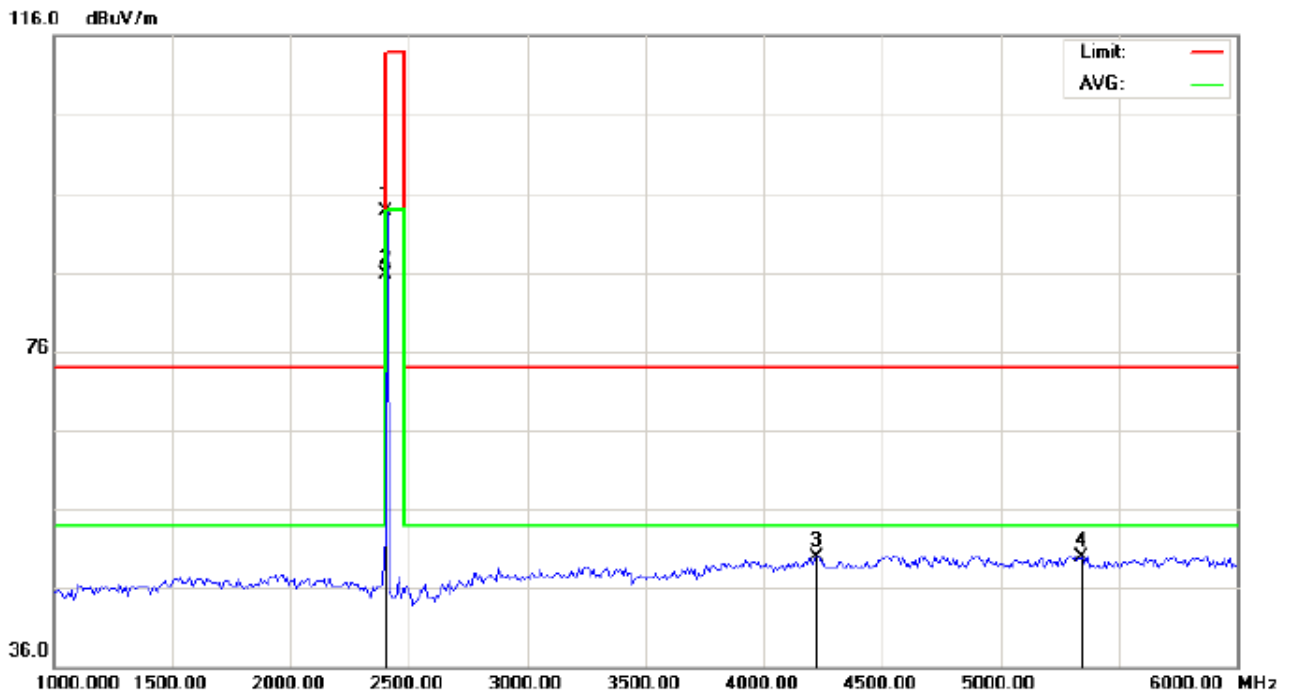

Site: site #1
Limit: FCC Class B 3M Radiation above 1GHZ(PK)-
EUT:TRUE WIRELESS SPEAKER
M/N:VA-SK003
Mode: Low Channel TX
Note:

Polarization: *Vertical*
Power:
Distance:

Temperature: 22.7
Humidity: 53.6 %

No.	Mk	Freq.	Reading	Factor	Measurement	Limit	Over	Detector	Antenna Height	Table Degree	Comment
		MHz	dBuV	dB/m	dBuV/m	dBuV/m	dB		cm	degree	
1		2402.000	83.32	10.32	93.64	114.00	-20.36	peak			
2	*	2402.000	75.47	10.32	85.79	94.00	-8.21	AVG	100	147	
3		4225.000	38.45	11.45	49.90	74.00	-24.10	peak			
4		5341.667	48.57	1.36	49.93	74.00	-24.07	peak			

RESULT: PASS

RADIATED EMISSION TEST- (ABOVE 1GHZ)-MIDDLE CHANNEL- VERTICAL

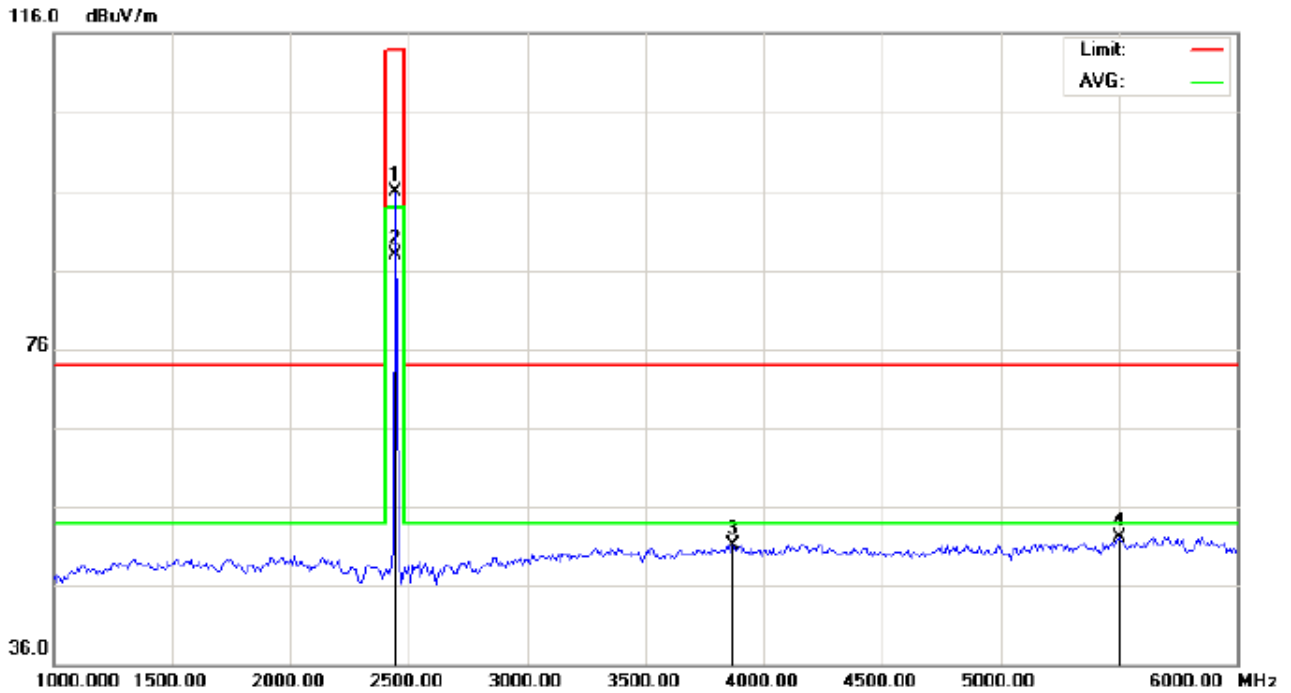

Site: site #1 Polarization: *Vertical* Temperature: 22.7
Limit: FCC Class B 3M Radiation above 1GHZ(PK)- Power: Humidity: 53.6 %
EUT:TRUE WIRELESS SPEAKER Distance:
M/N:VA-SK003
Mode: Middle Channel TX
Note:

No.	Mk	Freq.	Reading	Factor	Measurement	Limit	Over	Detector	Antenna Height	Table Degree	Comment
		MHz	dBuV	dB/m	dBuV/m	dBuV/m	dB		cm	degree	
1		2441.000	85.49	10.36	95.85	114.00	-18.15	peak			
2	*	2441.000	77.54	10.36	87.90	94.00	-6.10	AVG	150	229	
3		3866.667	36.81	14.37	51.18	74.00	-22.82	peak			
4		5500.000	53.90	-1.81	52.09	74.00	-21.91	peak			

RESULT: PASS

RADIATED EMISSION TEST- (ABOVE 1GHZ)-HIGH CHANNEL-HORIZONTAL

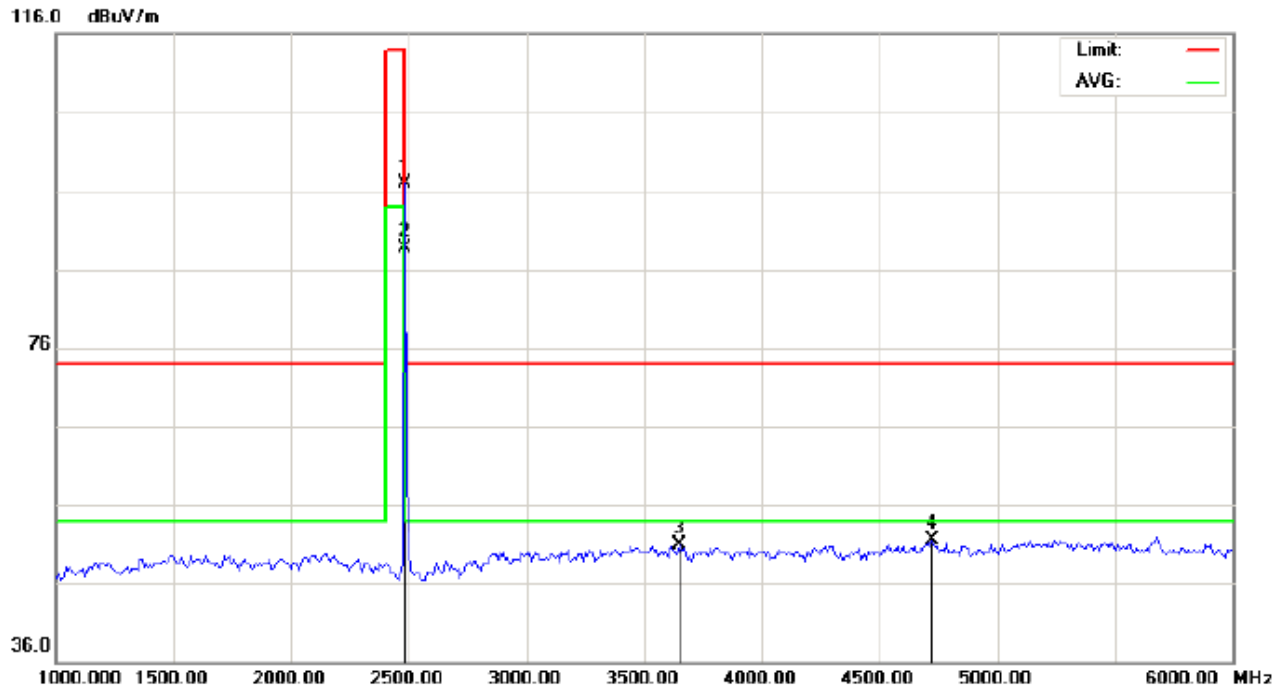

Site: site #1

Polarization: *Horizontal*

Temperature: 22.7

Limit: FCC Class B 3M Radiation above 1GHZ(PK)-

Power:

Humidity: 53.6 %

EUT: TRUE WIRELESS SPEAKER

Distance:

M/N:VA-SK003

Mode: High Channel TX

Note:

No.	Mk	Freq.	Reading	Factor	Measurement	Limit	Over	Detector	Antenna Height	Table Degree	Comment
		MHz	dBuV	dB/m	dBuV/m	dBuV/m	dB		cm	degree	
1		2480.000	86.47	10.41	96.88	114.00	-17.12	peak			
2	*	2480.000	78.23	10.41	88.64	94.00	-5.36	AVG	100	219	
3		3650.000	37.78	13.03	50.81	74.00	-23.19	peak			
4		4725.000	44.06	7.48	51.54	74.00	-22.46	peak			

RESULT: PASS

Field strength of the fundamental signal

1Mbps Result:

Peak value

Frequency	Reading Level	Factor	Measurement	Limit	Over	Antenna
(MHz)	(dBuv)	(dB/m)	(dBuv/m)	(dBuv/m)	(dB)	Polarization
2402	83.21	10.32	93.53	114	-20.47	Horizontal
2402	83.32	10.32	93.64	114	-20.36	Vertical
2441	85.44	10.36	95.80	114	-18.20	Horizontal
2441	85.49	10.36	95.85	114	-18.15	Vertical
2480	86.47	10.41	96.88	114	-17.12	Horizontal
2480	86.37	10.41	96.78	114	-17.22	Vertical

Average value

Frequency	Reading Level	Factor	Measurement	Limit	Over	Antenna
(MHz)	(dBuv)	(dB/m)	(dBuv/m)	(dBuv/m)	(dB)	Polarization
2402	75.32	10.32	85.64	94	-8.36	Horizontal
2402	75.47	10.32	85.79	94	-8.21	Vertical
2441	77.45	10.36	87.81	94	-6.19	Horizontal
2441	77.54	10.36	87.90	94	-6.10	Vertical
2480	78.23	10.41	88.64	94	-5.36	Horizontal
2480	78.12	10.41	88.53	94	-5.47	Vertical

2Mbps Result:**Peak value**

Frequency	Reading Level	Factor	Measurement	Limit	Over	Antenna
(MHz)	(dBuv)	(dB/m)	(dBuv/m)	(dBuv/m)	(dB)	Polarization
2402	82.70	10.32	93.02	114	-20.98	Horizontal
2402	82.73	10.32	93.05	114	-20.95	Vertical
2441	84.90	10.36	95.26	114	-18.74	Horizontal
2441	84.95	10.36	95.31	114	-18.69	Vertical
2480	85.93	10.41	96.34	114	-17.66	Horizontal
2480	85.95	10.41	96.36	114	-17.64	Vertical

Average value

Frequency	Reading Level	Factor	Measurement	Limit	Over	Antenna
(MHz)	(dBuv)	(dB/m)	(dBuv/m)	(dBuv/m)	(dB)	Polarization
2402	74.79	10.32	85.11	94	-8.89	Horizontal
2402	74.80	10.32	85.12	94	-8.88	Vertical
2441	77.03	10.36	87.39	94	-6.61	Horizontal
2441	77.06	10.36	87.42	94	-6.58	Vertical
2480	77.74	10.41	88.15	94	-5.85	Horizontal
2480	77.78	10.41	88.19	94	-5.81	Vertical

3Mbps Result:**Peak value**

Frequency	Reading Level	Factor	Measurement	Limit	Over	Antenna
(MHz)	(dBuv)	(dB/m)	(dBuv/m)	(dBuv/m)	(dB)	Polarization
2402	82.21	10.32	92.53	114	-21.47	Horizontal
2402	82.24	10.32	92.56	114	-21.44	Vertical
2441	84.50	10.36	94.86	114	-19.14	Horizontal
2441	84.53	10.36	94.89	114	-19.11	Vertical
2480	85.46	10.41	95.87	114	-18.13	Horizontal
2480	85.49	10.41	95.90	114	-18.10	Vertical

Average value

Frequency	Reading Level	Factor	Measurement	Limit	Over	Antenna
(MHz)	(dBuv)	(dB/m)	(dBuv/m)	(dBuv/m)	(dB)	Polarization
2402	74.31	10.32	84.63	94	-9.37	Horizontal
2402	74.34	10.32	84.66	94	-9.34	Vertical
2441	76.58	10.36	86.94	94	-7.06	Horizontal
2441	76.49	10.36	86.85	94	-7.15	Vertical
2480	77.11	10.41	87.52	94	-6.48	Horizontal
2480	77.15	10.41	87.56	94	-6.44	Vertical

9. BAND EDGE EMISSION

9.1. MEASUREMENT PROCEDURE

1The EUT operates at hopping-off test mode. The lowest or highest channels are tested to verify the largest transmission and spurious emissions power at the continuous transmission mode.

2Max hold the trace of the setup 1, and the EUT operates at hopping-on test mode to verify the largest spurious emissions power.

3Set the spectrum analyzer in the following setting in order to capture the lower and upper band-edges of the emission

9.2 TEST SETUP

RADIATED EMISSION TEST SETUP

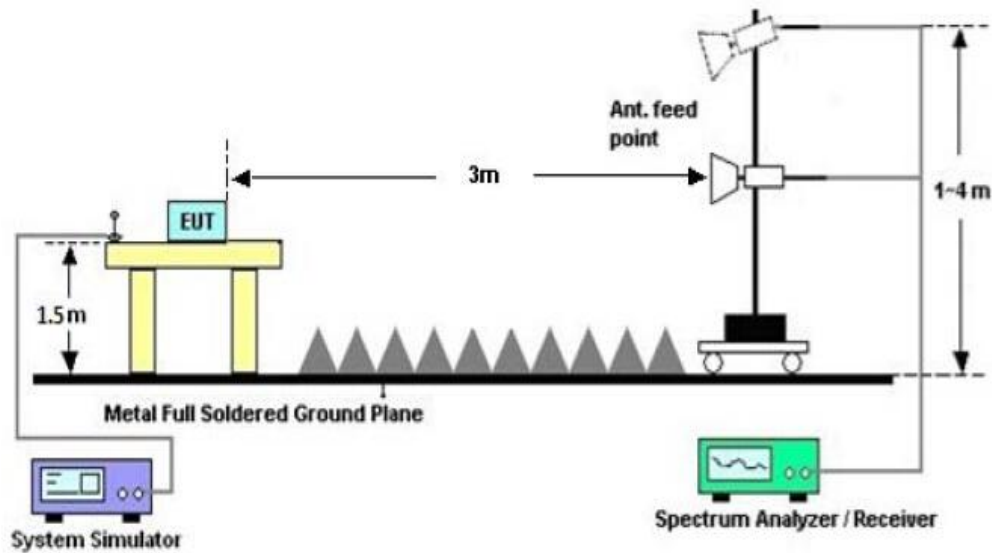

TEST PLOT OF BAND EDGE FOR HIGH CHANNEL -Horizontal

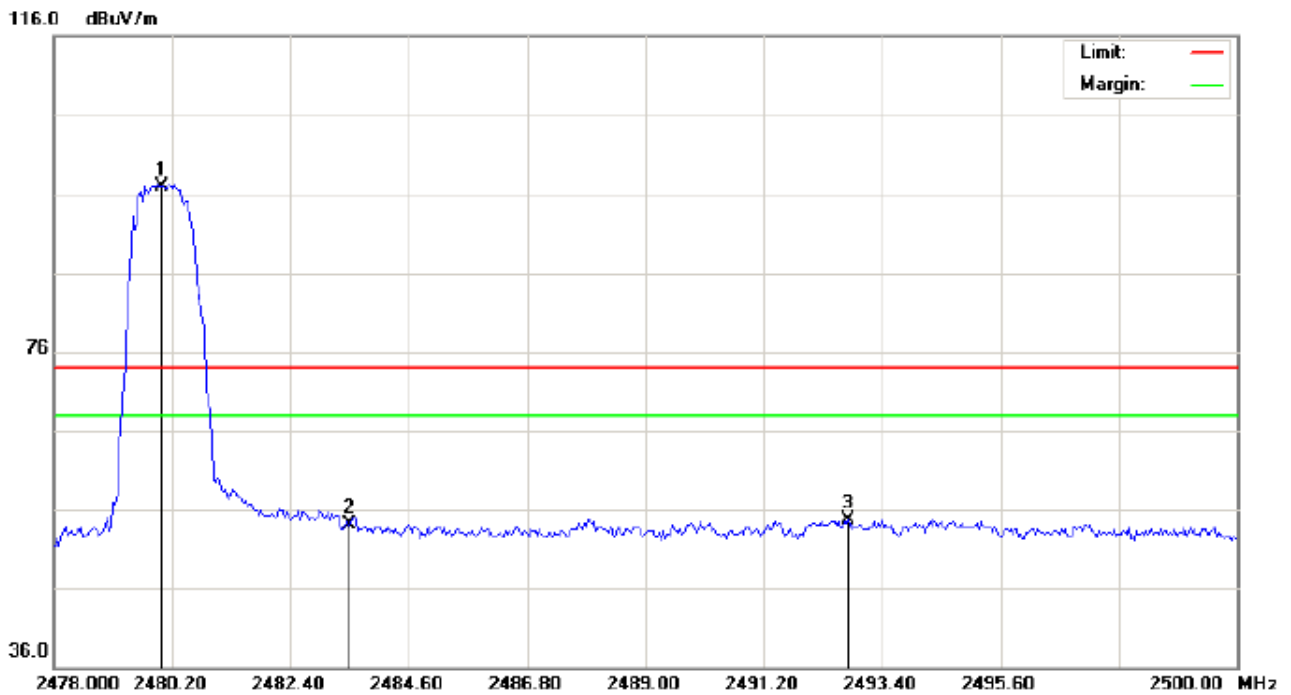

Site: site #1 Polarization: *Horizontal* Temperature: 26
Limit: FCC Class B 3M Radiation above 1GHZ(PK) Power: Humidity: 60 %
EUT:TRUE WIRELESS SPEAKER Distance:
M/N:VA-SK003
Mode: High Channel TX
Note:

No.	Mk	Freq.	Reading	Factor	Measurement	Limit	Over	Detector	Antenna Height	Table Degree	Comment
		MHz	dBuV	dB/m	dBuV/m	dBuV/m	dB		cm	degree	
1	*	2480.000	86.55	10.41	96.96	74.00	22.96	peak			
2		2483.500	43.69	10.41	54.10	74.00	-19.90	peak			
3		2492.777	44.30	10.42	54.72	74.00	-19.28	peak			

TEST PLOT OF BAND EDGE FOR HIGH CHANNEL-Vertical

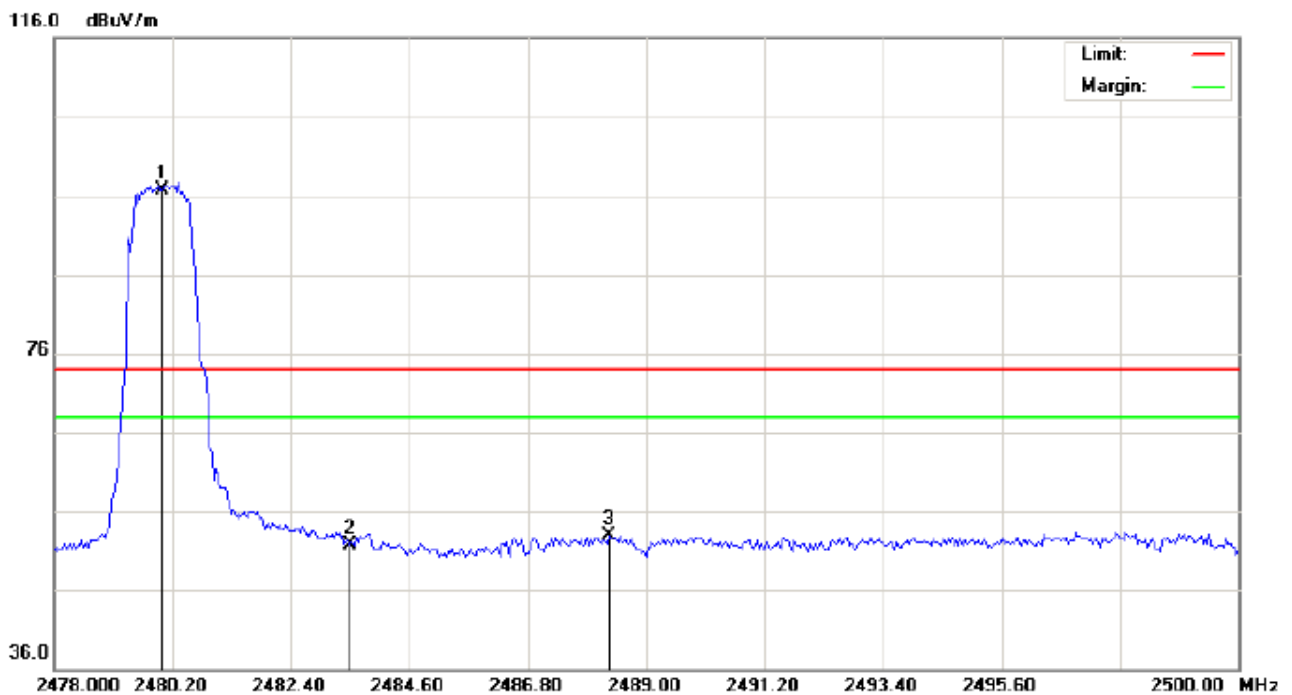

Site: site #1 Polarization: **Vertical** Temperature: 26
 Limit: FCC Class B 3M Radiation above 1GHZ(PK) Power: Humidity: 60 %
 EUT:TRUE WIRELESS SPEAKER Distance:
 M/N:VA-SK003
 Mode: High Channel TX
 Note:

No.	Mk	Freq.	Reading	Factor	Measurement	Limit	Over	Detector	Antenna Height	Table Degree	Comment
		MHz	dBuV	dB/m	dBuV/m	dBuV/m	dB		cm	degree	
1	*	2480.000	86.32	10.41	96.73	74.00	22.73	peak			
2		2483.500	41.26	10.41	51.67	74.00	-22.33	peak			
3		2488.303	42.57	10.42	52.99	74.00	-21.01	peak			

RESULT: PASS

Note: The other modes radiation emission have enough 20dB margin.

Factor=Antenna Factor + Cable loss - Amplifier gain, Over=Measure-Limit.

The "Factor" value can be calculated automatically by software of measurement system.

Hopping on mode and Hopping off mode have been tested, but only worst case reported.

10. 20DB BANDWIDTH

10.1. MEASUREMENT PROCEDURE

1. Connect EUT RF output port to the Spectrum Analyzer through an RF attenuator
2. Set the EUT Work on the top, the middle and the bottom operation frequency individually.
3. Set Span = approximately 2 to 3 times the 20 dB bandwidth, centered on a hoping channel
 $RBW \geq 1\%$ of the 20 dB bandwidth, $VBW \geq RBW$; Sweep = auto; Detector function = peak
4. Set SPA Trace 1 Max hold, then View.

10.2. TEST SET-UP

(BLOCK DIAGRAM OF CONFIGURATION)

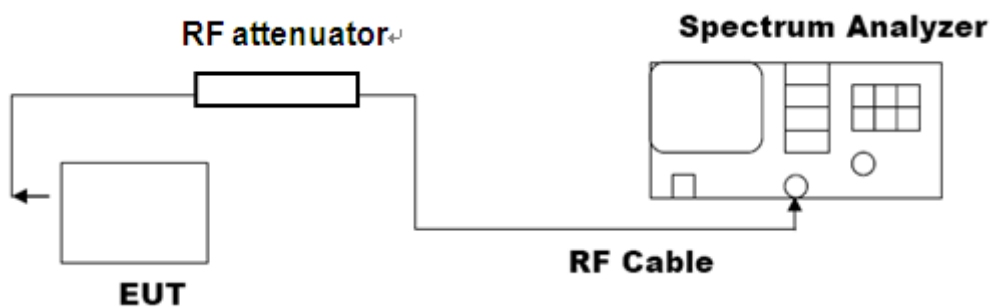

Note: The EUT has been used temporary antenna connector for testing.

10.3. LIMITS AND MEASUREMENT RESULTS

FOR BR/EDR

BLUETOOTH 1MBPS LIMITS AND MEASUREMENT RESULT				
Applicable Limits	Measurement Result			
	Test Data (MHz)			Result
		99%OBW (MHz)	-20dB BW(MHz)	
N/A	Low Channel	0.959	1.107	PASS
	Middle Channel	0.963	1.102	PASS
	High Channel	0.960	1.102	PASS

TEST PLOT OF BANDWIDTH FOR LOW CHANNEL

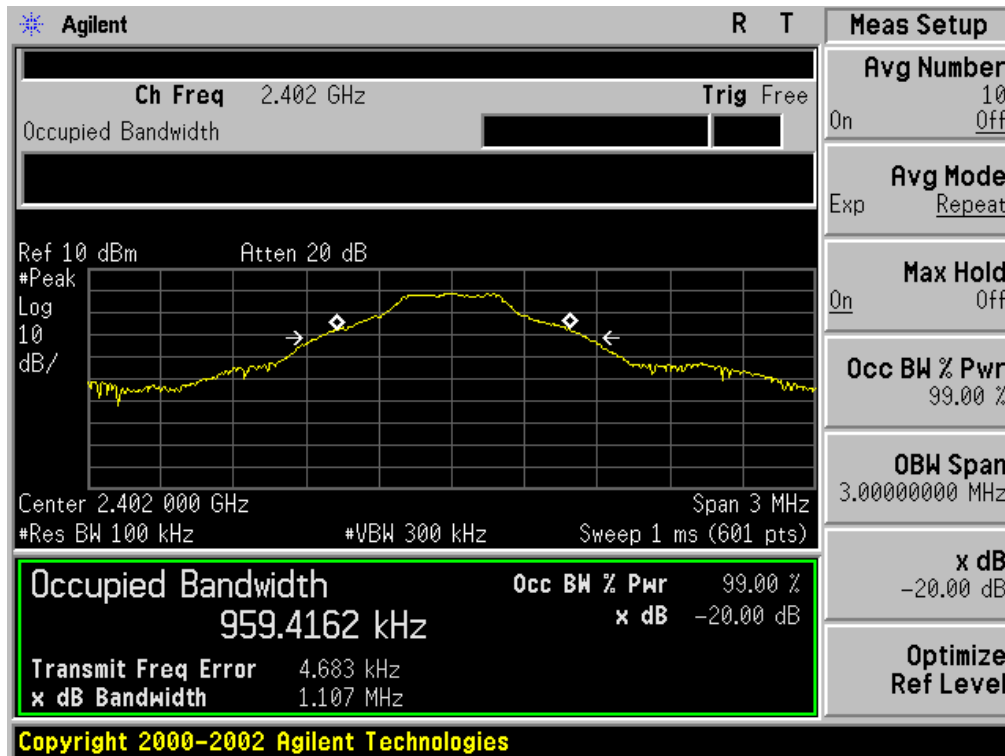

TEST PLOT OF BANDWIDTH FOR MIDDLE CHANNEL

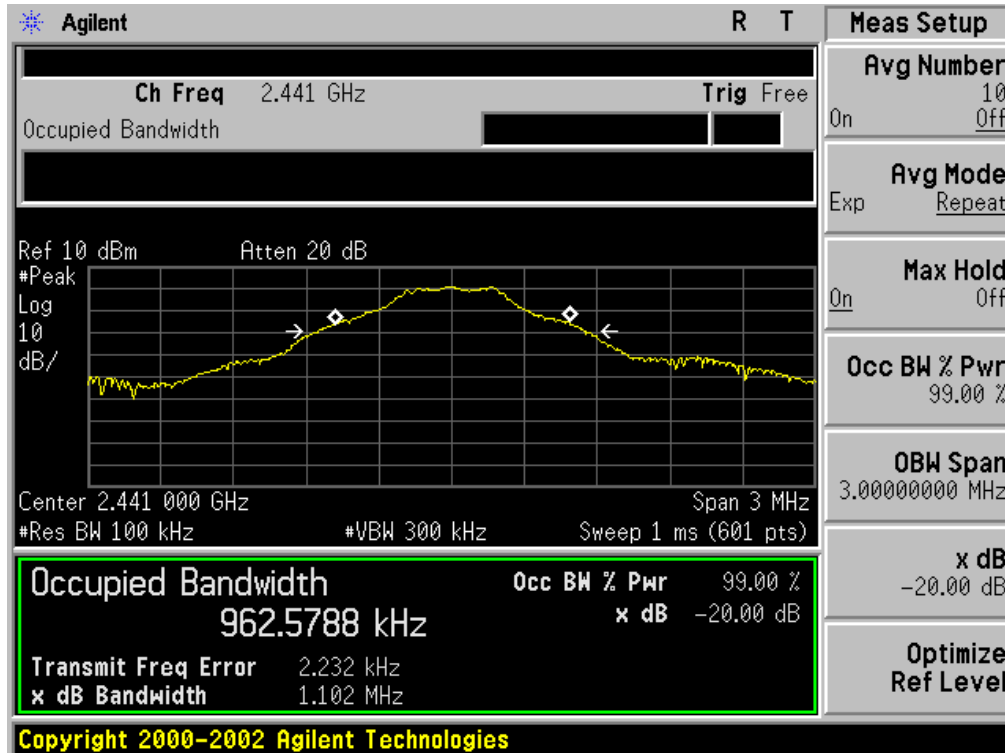

TEST PLOT OF BANDWIDTH FOR HIGH CHANNEL

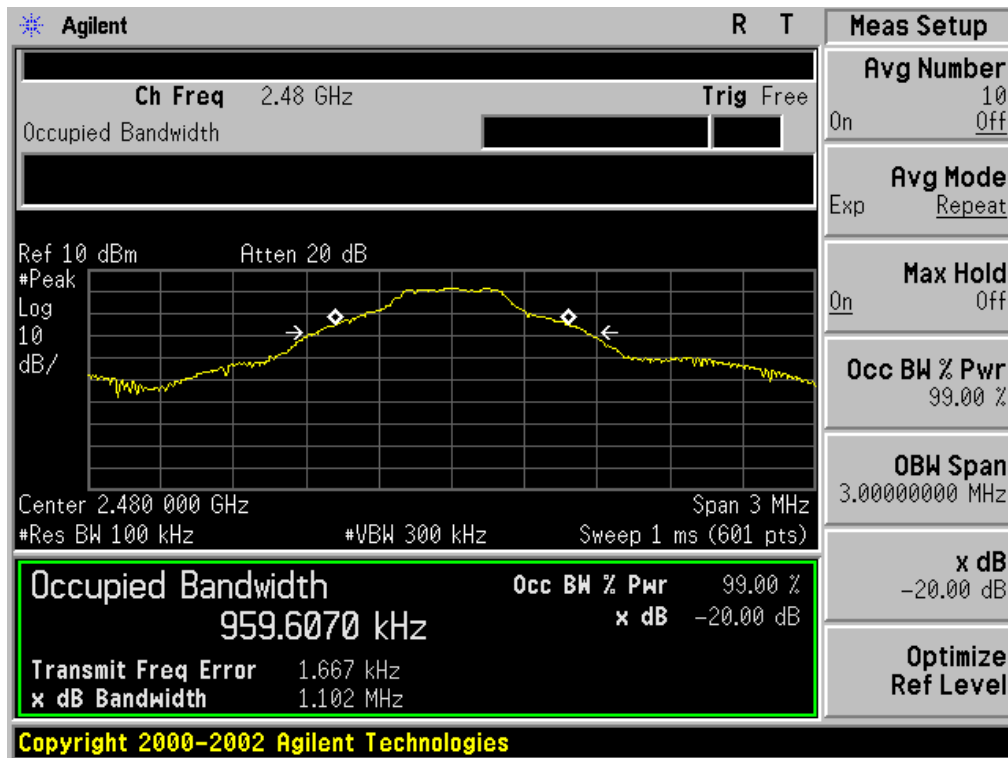

BLUETOOTH 2MBPS LIMITS AND MEASUREMENT RESULT				
Applicable Limits	Measurement Result			
	Test Data (MHz)			Result
		99%OBW (MHz)	-20dB BW(MHz)	
N/A	Low Channel	1.216	1.357	PASS
	Middle Channel	1.208	1.357	PASS
	High Channel	1.214	1.369	PASS

TEST PLOT OF BANDWIDTH FOR LOW CHANNEL

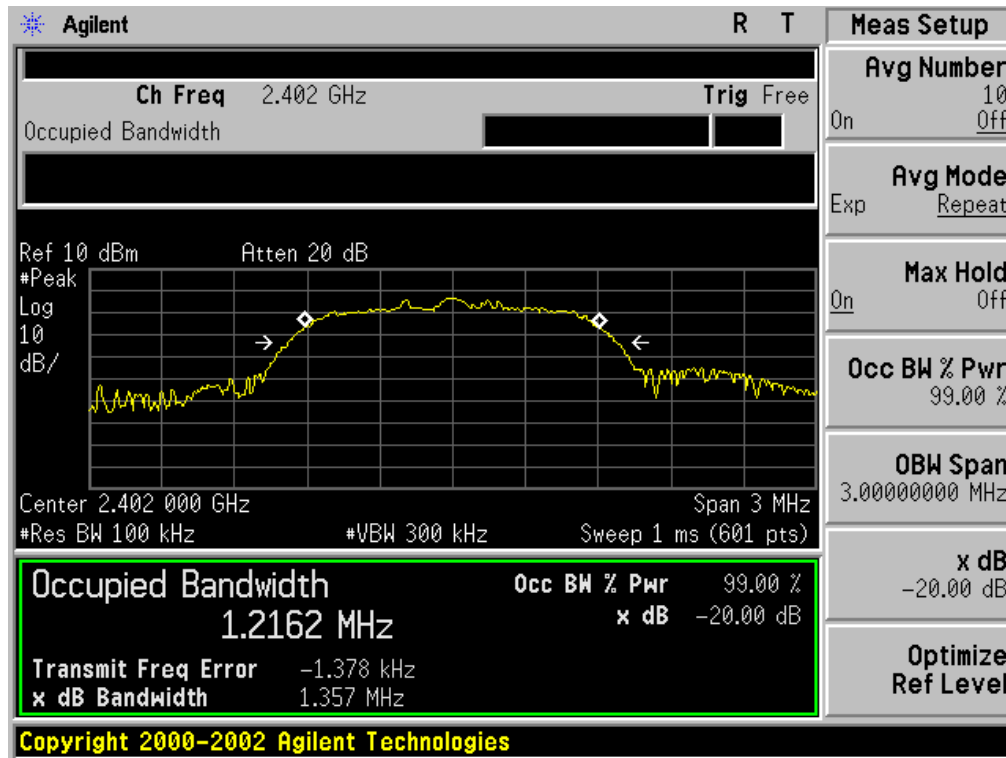

TEST PLOT OF BANDWIDTH FOR MIDDLE CHANNEL

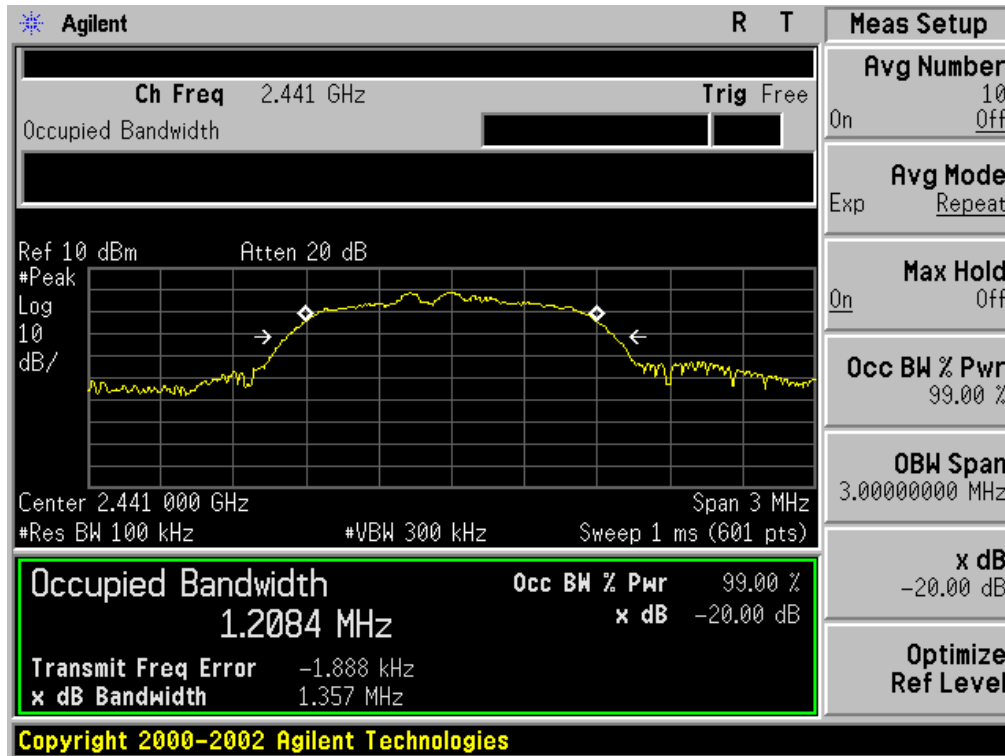

TEST PLOT OF BANDWIDTH FOR HIGH CHANNEL

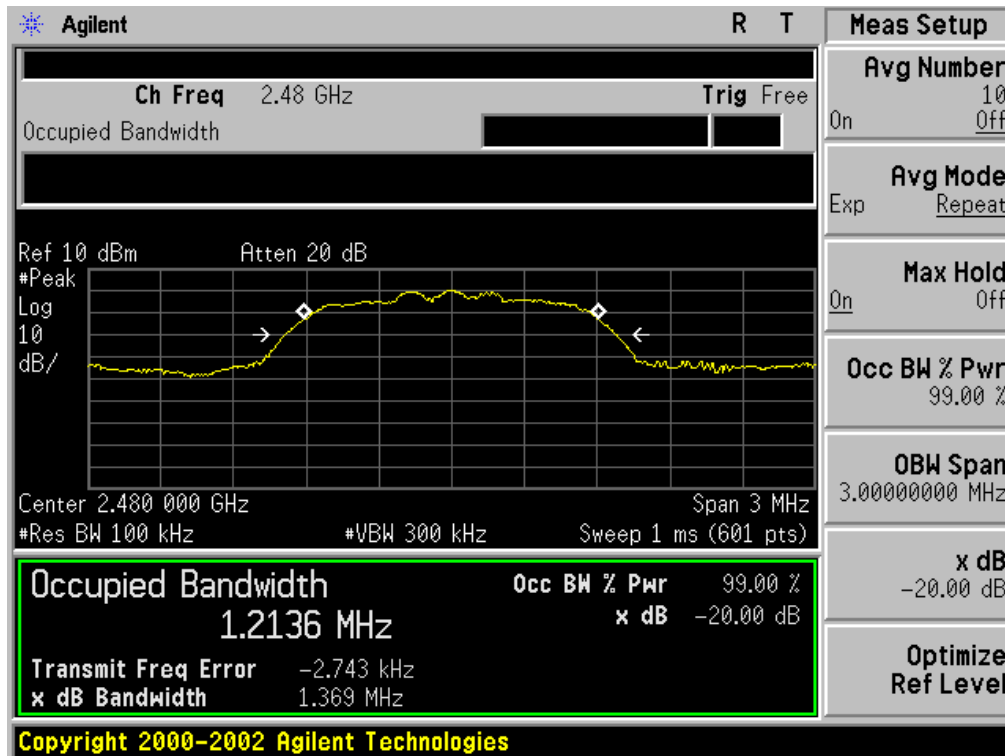

BLUETOOTH 3MBPS LIMITS AND MEASUREMENT RESULT				
Applicable Limits	Measurement Result			
	Test Data (MHz)			Result
		99%OBW (MHz)	-20dB BW(MHz)	
N/A	Low Channel	1.212	1.375	PASS
	Middle Channel	1.211	1.360	PASS
	High Channel	1.215	1.367	PASS

TEST PLOT OF BANDWIDTH FOR LOW CHANNEL



TEST PLOT OF BANDWIDTH FOR MIDDLE CHANNEL

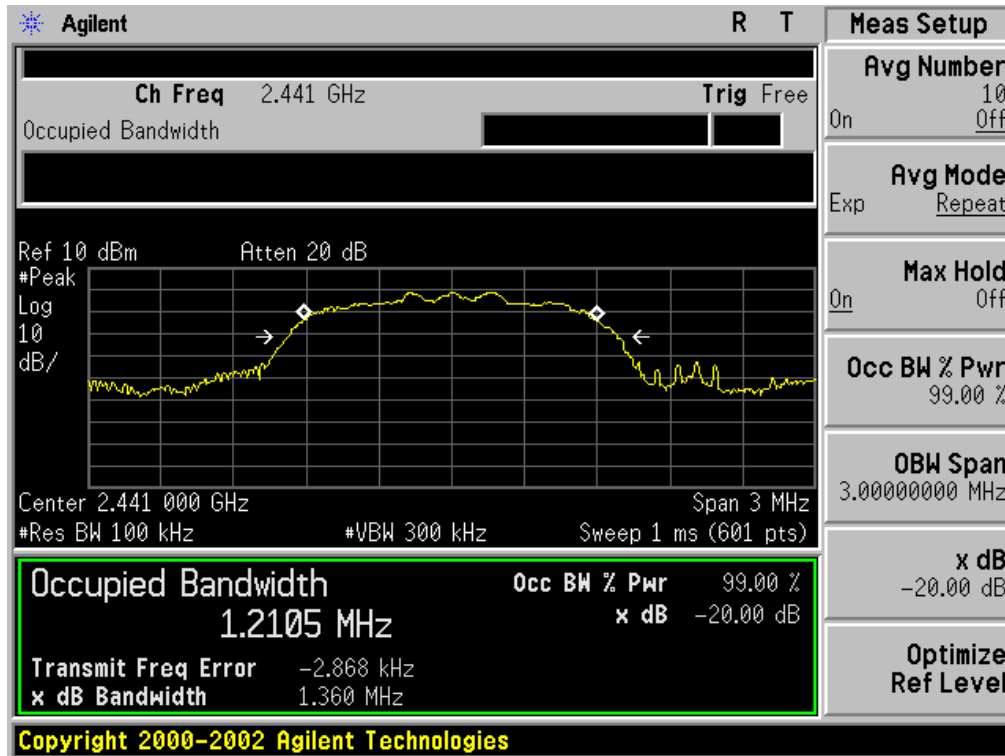

TEST PLOT OF BANDWIDTH FOR HIGH CHANNEL

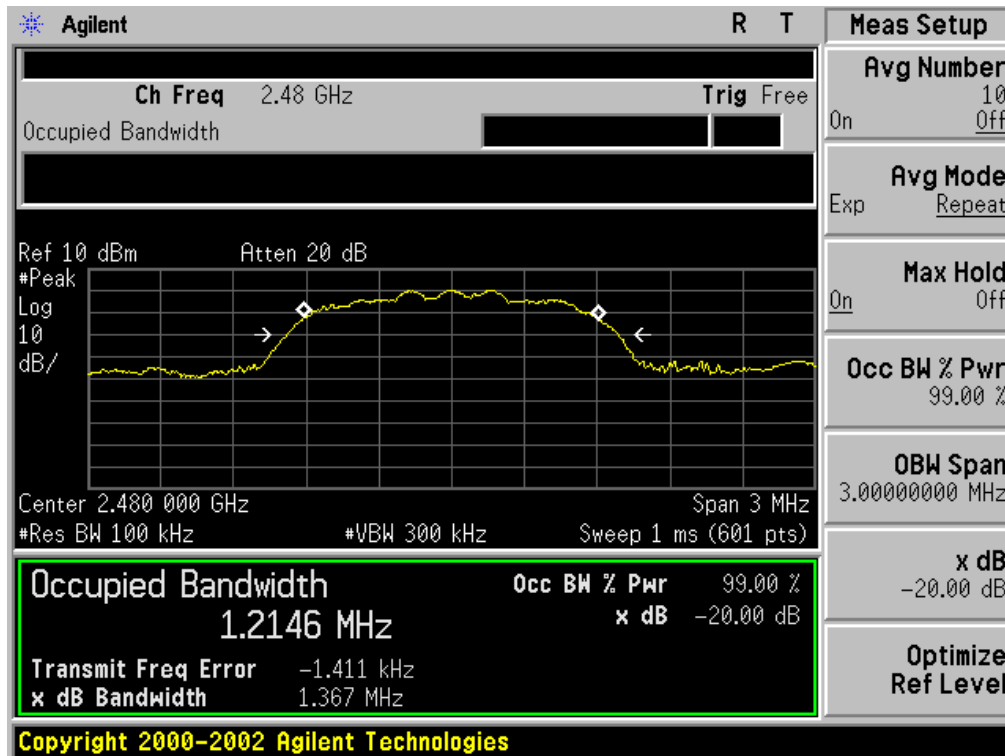

11. FCC LINE CONDUCTED EMISSION TEST

11.1. LIMITS OF LINE CONDUCTED EMISSION TEST

Frequency	Maximum RF Line Voltage	
	Q.P.(dBuV)	Average(dBuV)
150kHz~500kHz	66-56	56-46
500kHz~5MHz	56	46
5MHz~30MHz	60	50

Note:

1. The lower limit shall apply at the transition frequency.
2. The limit decreases linearly with the logarithm of the frequency in the range 0.15 MHz to 0.50 MHz.

11.2. BLOCK DIAGRAM OF LINE CONDUCTED EMISSION TEST

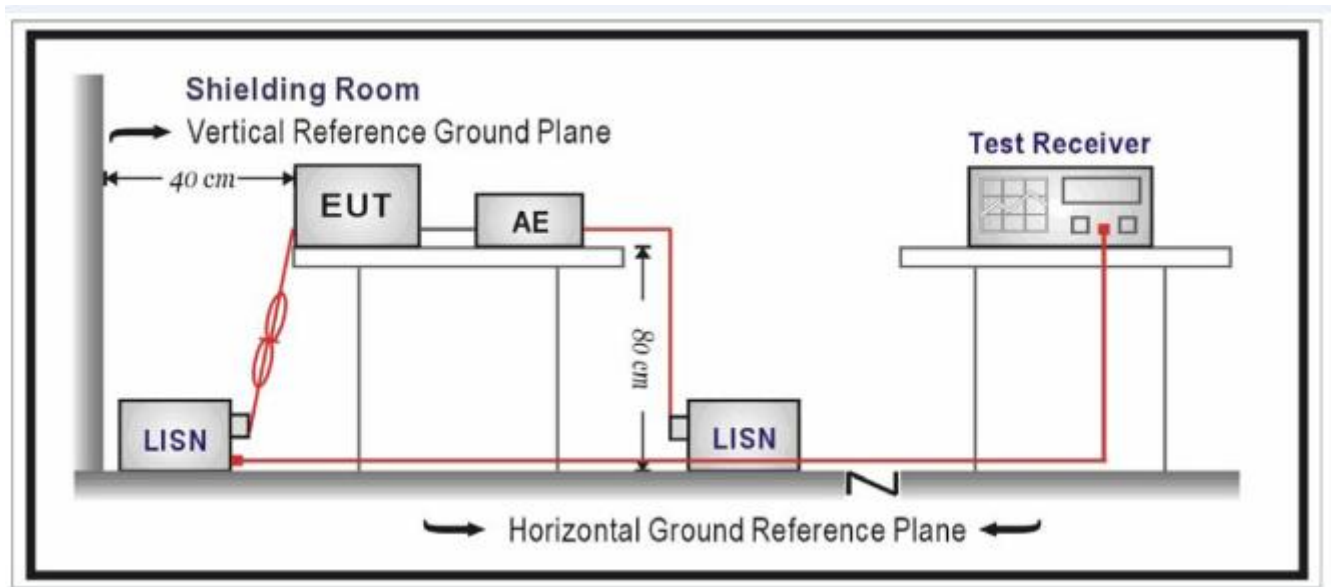

11.3. PRELIMINARY PROCEDURE OF LINE CONDUCTED EMISSION TEST

1. The equipment was set up as per the test configuration to simulate typical actual usage per the user's manual. When the EUT is a tabletop system, a wooden table with a height of 0.8 meters is used and is placed on the ground plane as per ANSI C63.10 (see Test Facility for the dimensions of the ground plane used). When the EUT is a floor-standing equipment, it is placed on the ground plane which has a 3-12 mm non-conductive covering to insulate the EUT from the ground plane.
2. Support equipment, if needed, was placed as per ANSI C63.10.
3. All I/O cables were positioned to simulate typical actual usage as per ANSI C63.10.
4. All support equipments received AC120V/60Hz power from a LISN, if any.
5. The EUT received charging voltage by adapter which received 120V/60Hz power by a LISN.
6. The test program was started. Emissions were measured on each current carrying line of the EUT using a spectrum Analyzer / Receiver connected to the LISN powering the EUT. The LISN has two monitoring points: Line 1 (Hot Side) and Line 2 (Neutral Side). Two scans were taken: one with Line 1 connected to Analyzer / Receiver and Line 2 connected to a 50 ohm load; the second scan had Line 1 connected to a 50 ohm load and Line 2 connected to the Analyzer / Receiver.
7. Analyzer / Receiver scanned from 150 kHz to 30MHz for emissions in each of the test modes.
8. During the above scans, the emissions were maximized by cable manipulation.
9. The test mode(s) were scanned during the preliminary test.

Then, the EUT configuration and cable configuration of the above highest emission level were recorded for reference of final testing.

11.4. FINAL PROCEDURE OF LINE CONDUCTED EMISSION TEST

1. EUT and support equipment was set up on the test bench as per step 2 of the preliminary test.
2. A scan was taken on both power lines, Line 1 and Line 2, recording at least the six highest emissions. Emission frequency and amplitude were recorded into a computer in which correction factors were used to calculate the emission level and compare reading to the applicable limit. If EUT emission level was less -2dB to the A.V. limit in Peak mode, then the emission signal was re-checked using Q.P and Average detector.
3. The test data of the worst case condition(s) was reported on the Summary Data page.

11.5. TEST RESULT OF LINE CONDUCTED EMISSION TEST

By adapter-1(worst case)
FOR BR/EDR

Line Conducted Emission Test Line 1-L

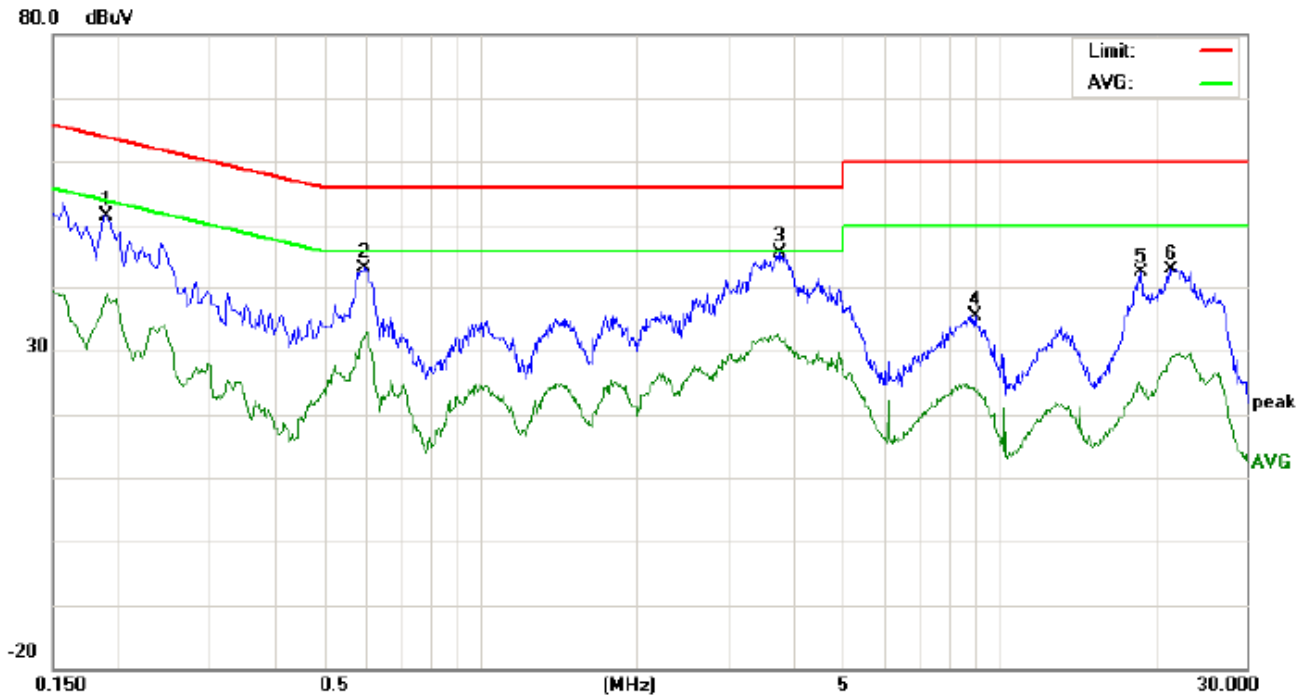

Site: Conduction Phase: **L1** Temperature: 24.1
 Limit: FCC Class B Conduction(QP) Power: Humidity: 53.7 %
 EUT:TRUE WIRELESS SPEAKER
 M/N:VA-SK003
 Mode:BT Link with charging
 Note:

No.	Freq. (MHz)	Reading_Level (dBuV)			Correct Factor (dB)	Measurement (dBuV)			Limit (dBuV)		Margin (dB)		P/F	Comment
		Peak	QP	AVG		Peak	QP	AVG	QP	AVG	QP	AVG		
1	0.1900	41.28		28.98	10.20	51.48		39.18	64.03	54.03	-12.55	-14.85	P	
2	0.5980	32.69		21.58	10.31	43.00		31.89	56.00	46.00	-13.00	-14.11	P	
3	3.7660	35.22		21.60	10.47	45.69		32.07	56.00	46.00	-10.31	-13.93	P	
4	8.9659	25.26		13.47	10.22	35.48		23.69	60.00	50.00	-24.52	-26.31	P	
5	18.7779	32.26		14.04	10.12	42.38		24.16	60.00	50.00	-17.62	-25.84	P	
6	21.4100	32.77		18.42	10.13	42.90		28.55	60.00	50.00	-17.10	-21.45	P	

Line Conducted Emission Test Line 2-N

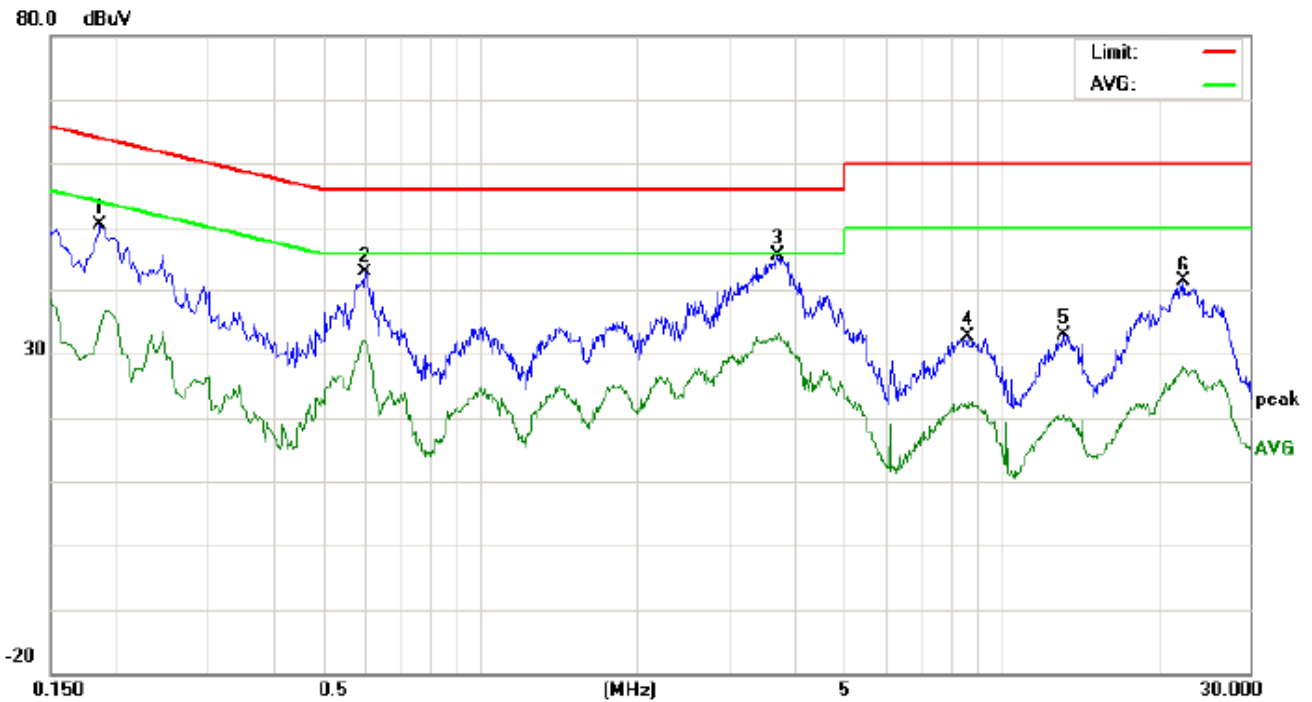

Site: Conduction Phase: **N** Temperature: 24.1
Limit: FCC Class B Conduction(QP) Power: Humidity: 53.7 %
EUT:TRUE WIRELESS SPEAKER
M/N:VA-SK003
Mode:BT Link with charging
Note:

No.	Freq. (MHz)	Reading_Level (dBuV)			Correct Factor (dB)	Measurement (dBuV)			Limit (dBuV)		Margin (dB)		P/F	Comment
		Peak	QP	AVG		Peak	QP	AVG	QP	AVG	QP	AVG		
1	0.1864	40.25		23.99	10.20	50.45		34.19	64.19	54.19	-13.74	-20.00	P	
2	0.6019	32.49		21.66	10.31	42.80		31.97	56.00	46.00	-13.20	-14.03	P	
3	3.7219	35.03		21.89	10.47	45.50		32.36	56.00	46.00	-10.50	-13.64	P	
4	8.5938	22.42		11.99	10.32	32.74		22.31	60.00	50.00	-27.26	-27.69	P	
5	13.1859	22.79		9.92	10.14	32.93		20.06	60.00	50.00	-27.07	-29.94	P	
6	22.5259	31.26		17.73	10.11	41.37		27.84	60.00	50.00	-18.63	-22.16	P	

APPENDIX A: PHOTOGRAPHS OF TEST SETUP

FCC LINE CONDUCTED EMISSION TEST SETUP



FCC RADIATED EMISSION TEST SETUP

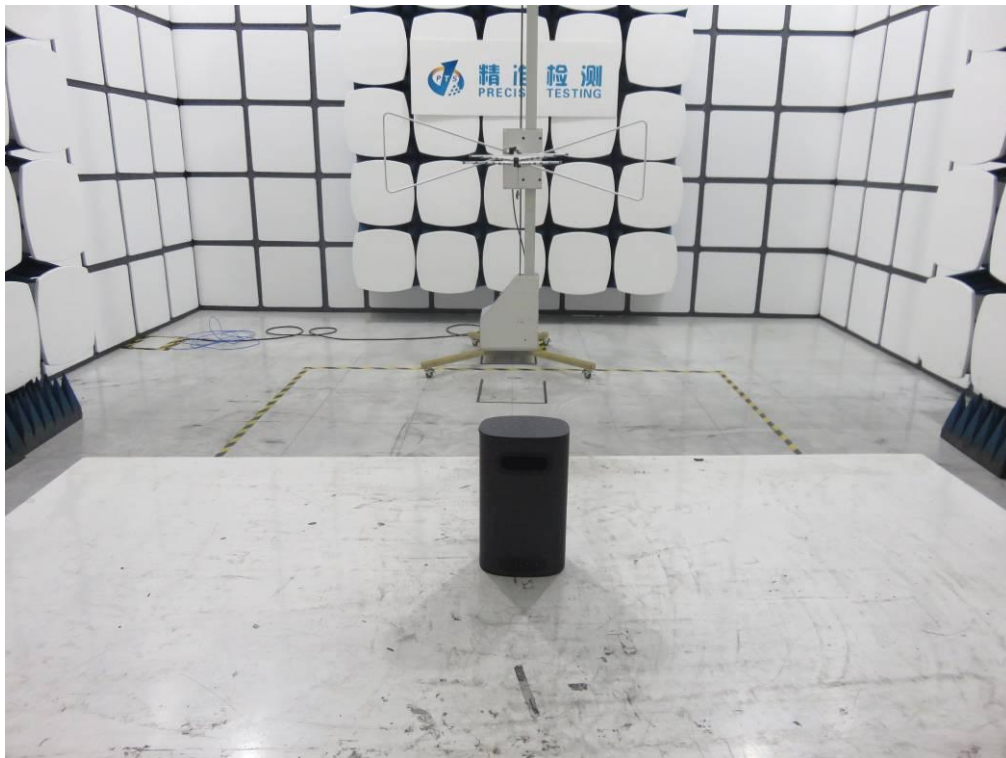

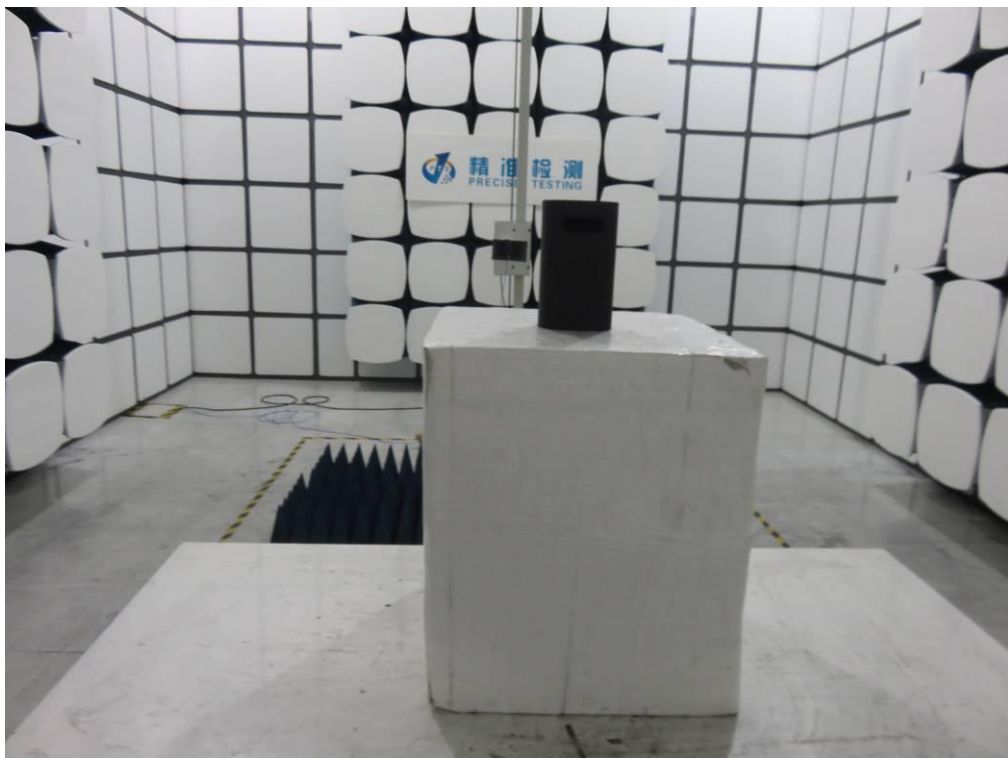
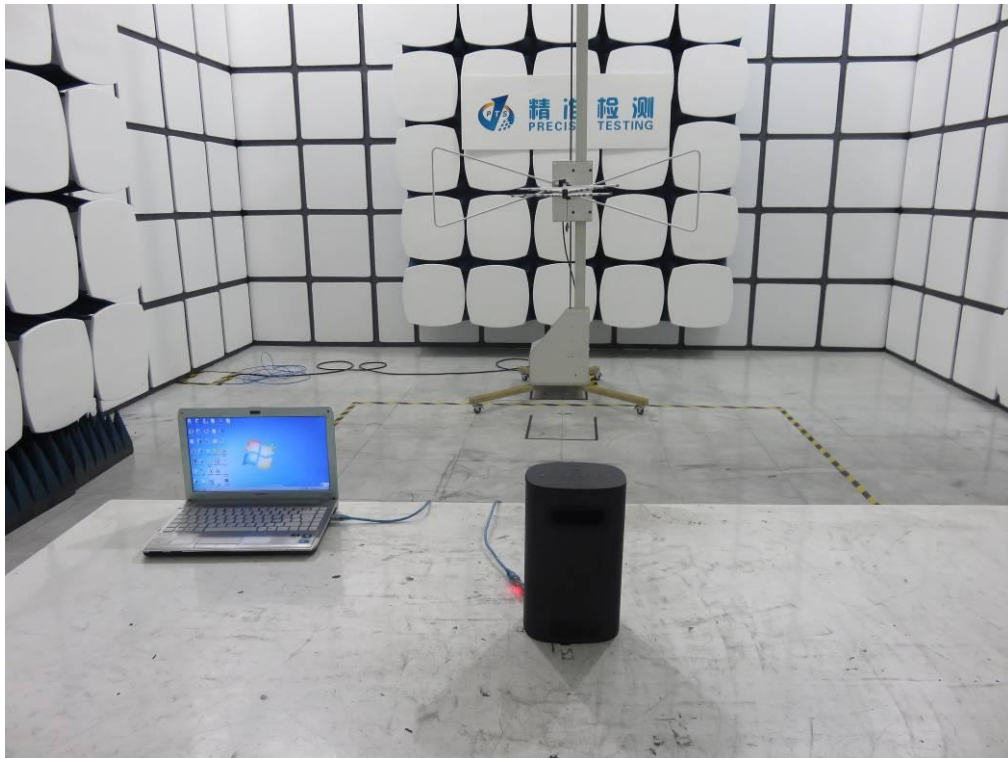

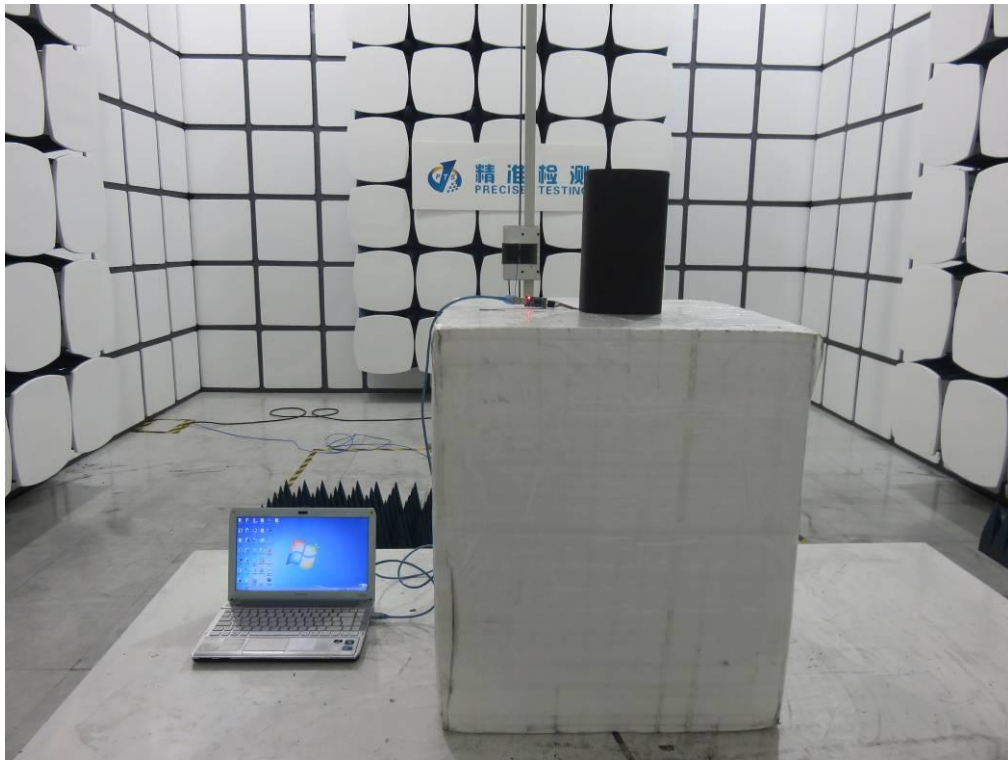

APPENDIX B: PHOTOGRAPHS OF EUT
WHOLE VIEW OF EUT



TOP VIEW OF EUT



BOTTOM VIEW OF EUT



FRONT VIEW OF EUT

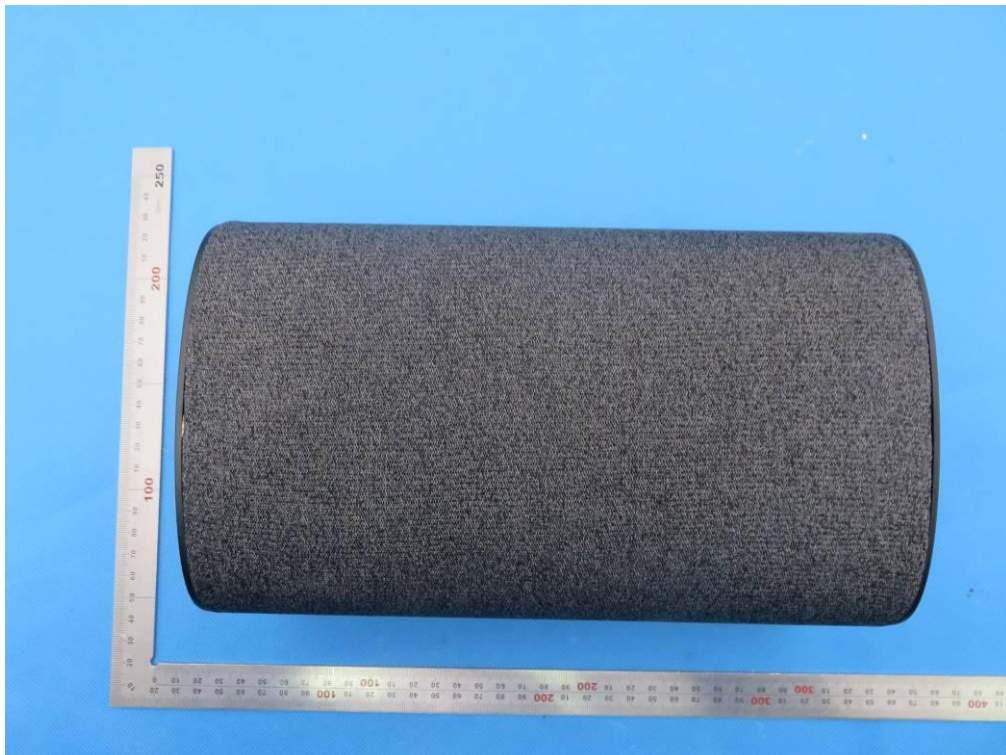

BACK VIEW OF EUT



LEFT VIEW OF EUT

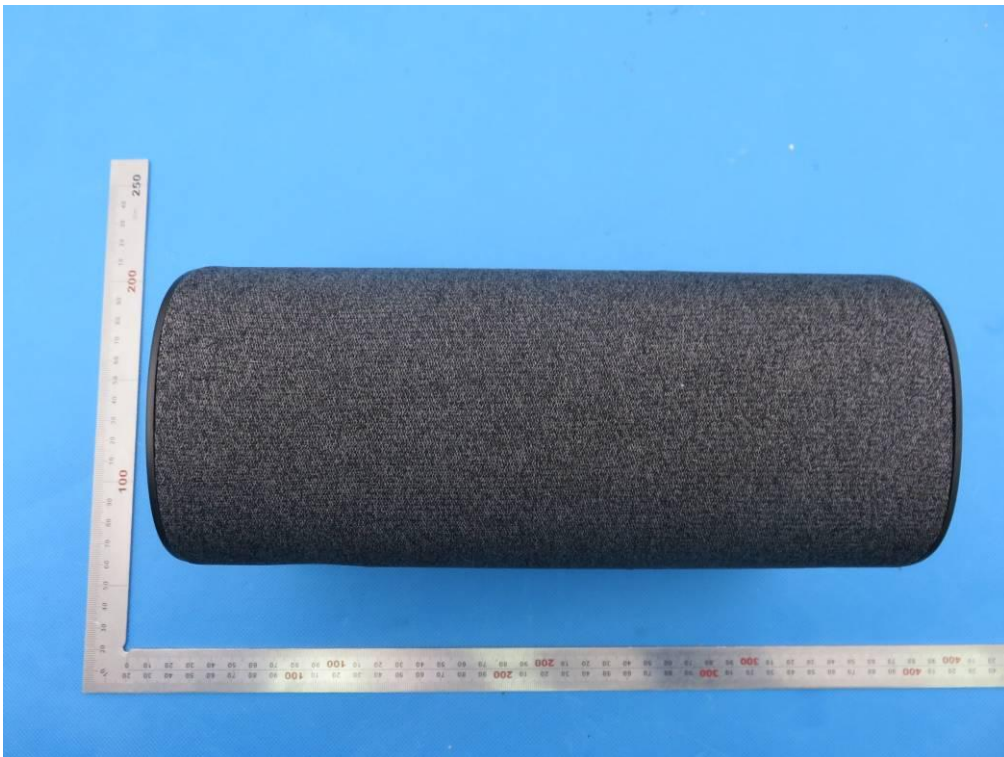

RIGHT VIEW OF EUT

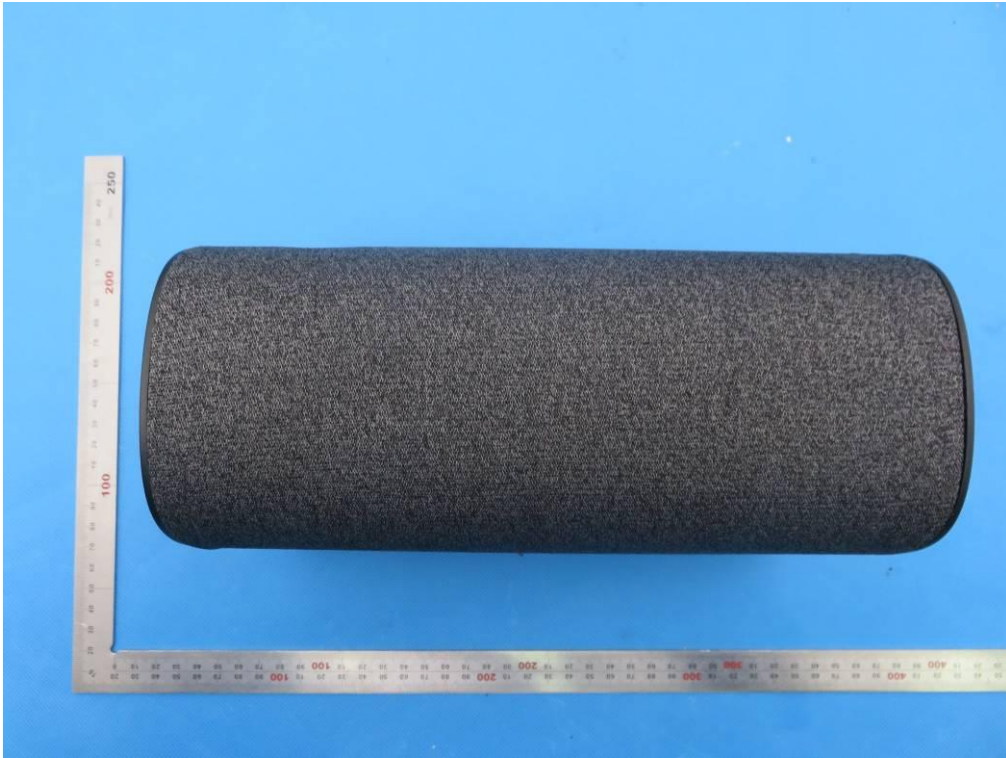

VIEW OF EUT (PORT)



OPEN VIEW OF EUT-1

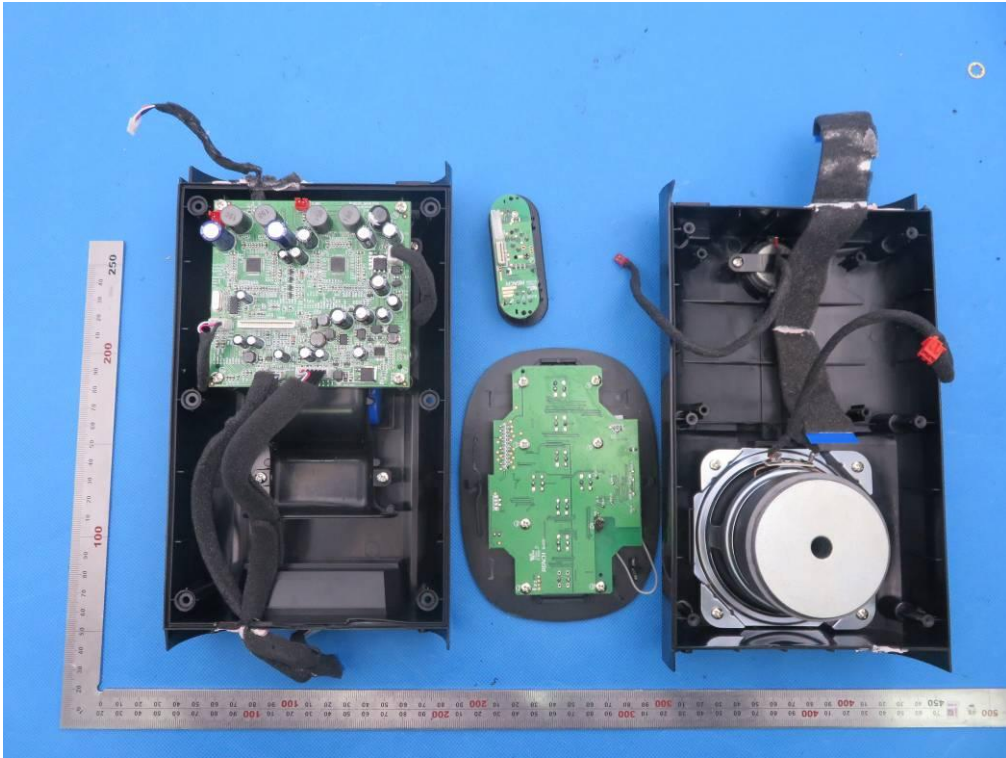

OPEN VIEW OF EUT-2

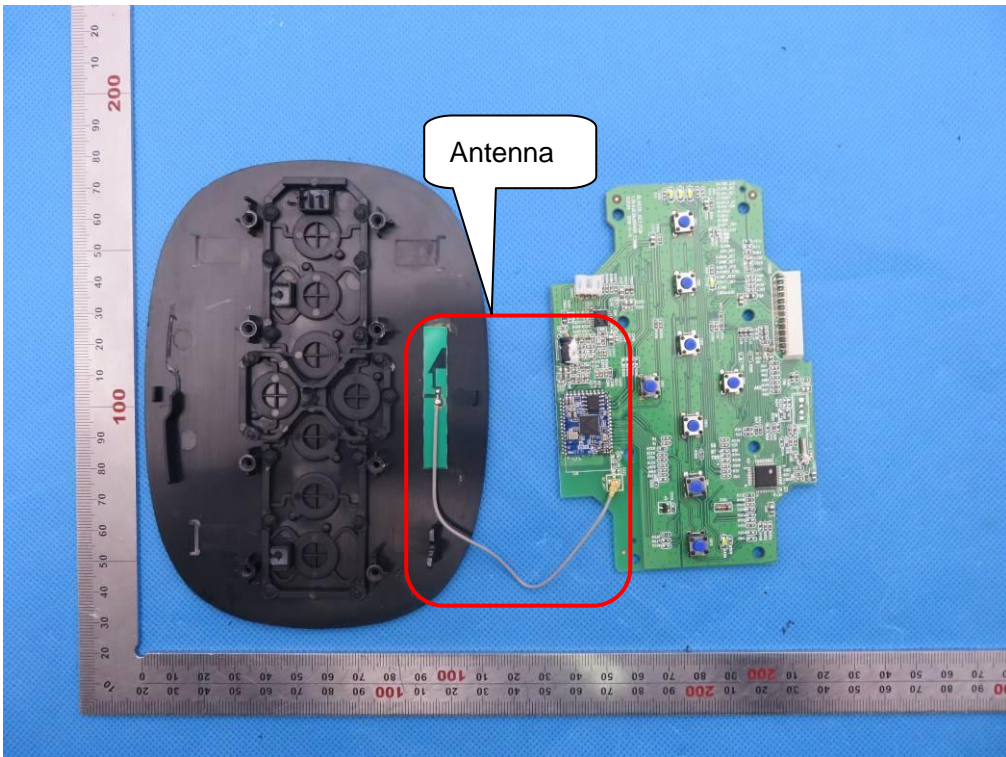

OPEN VIEW OF EUT-3



INTERNAL VIEW OF EUT-1

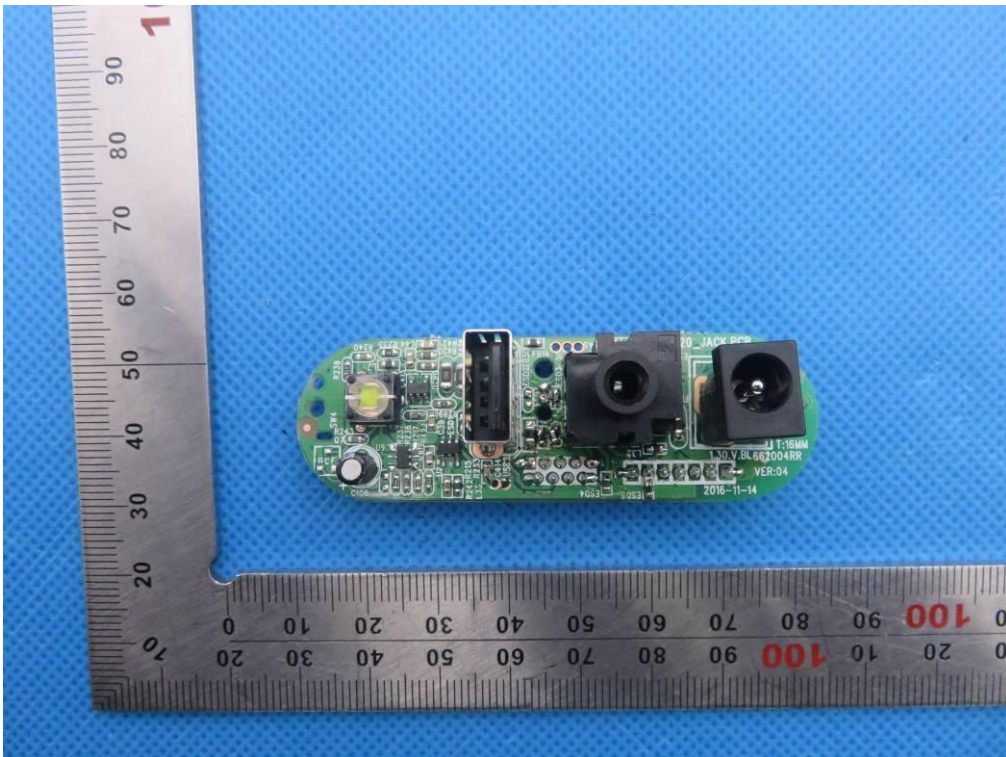

INTERNAL VIEW OF EUT-2

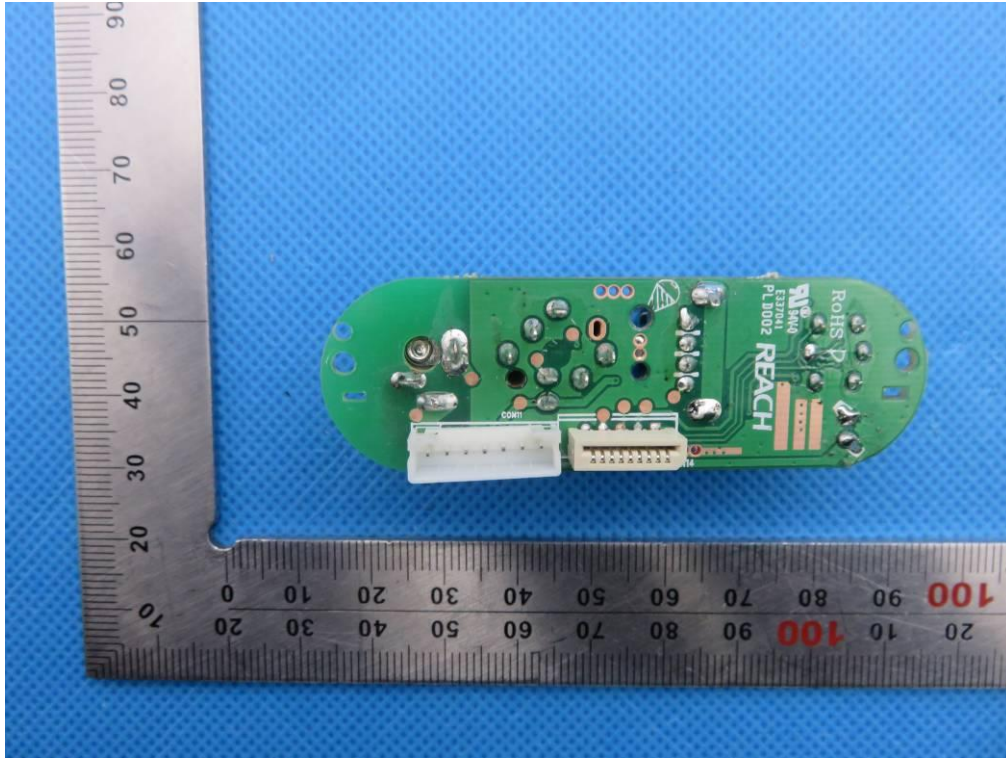

INTERNAL VIEW OF EUT-3

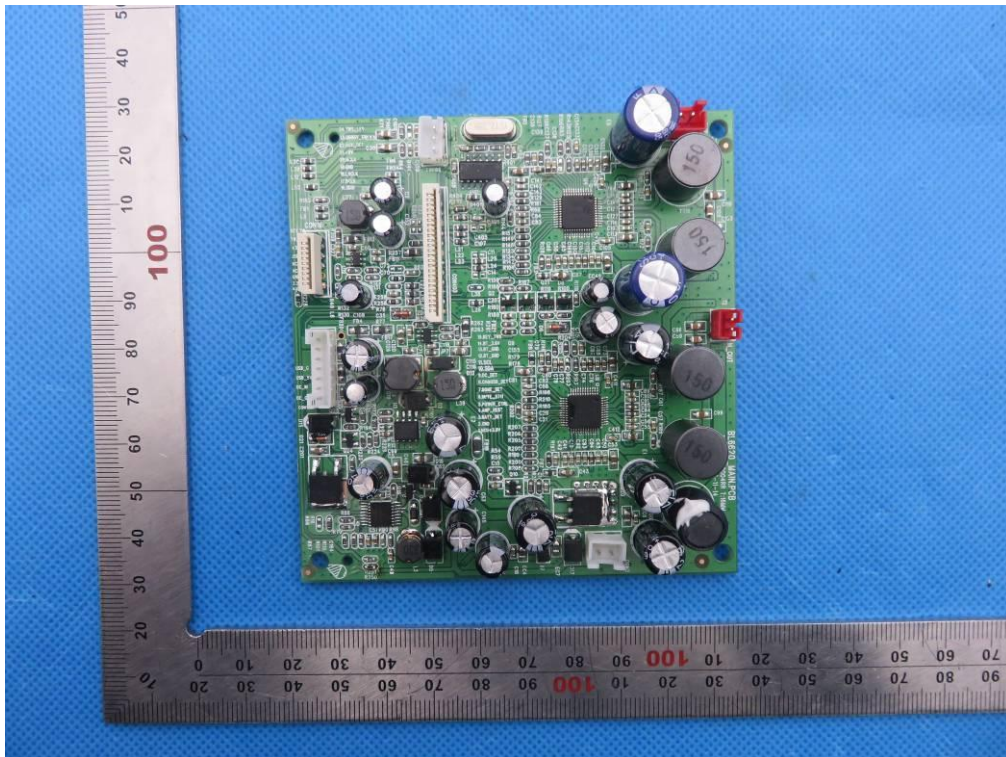

INTERNAL VIEW OF EUT-4

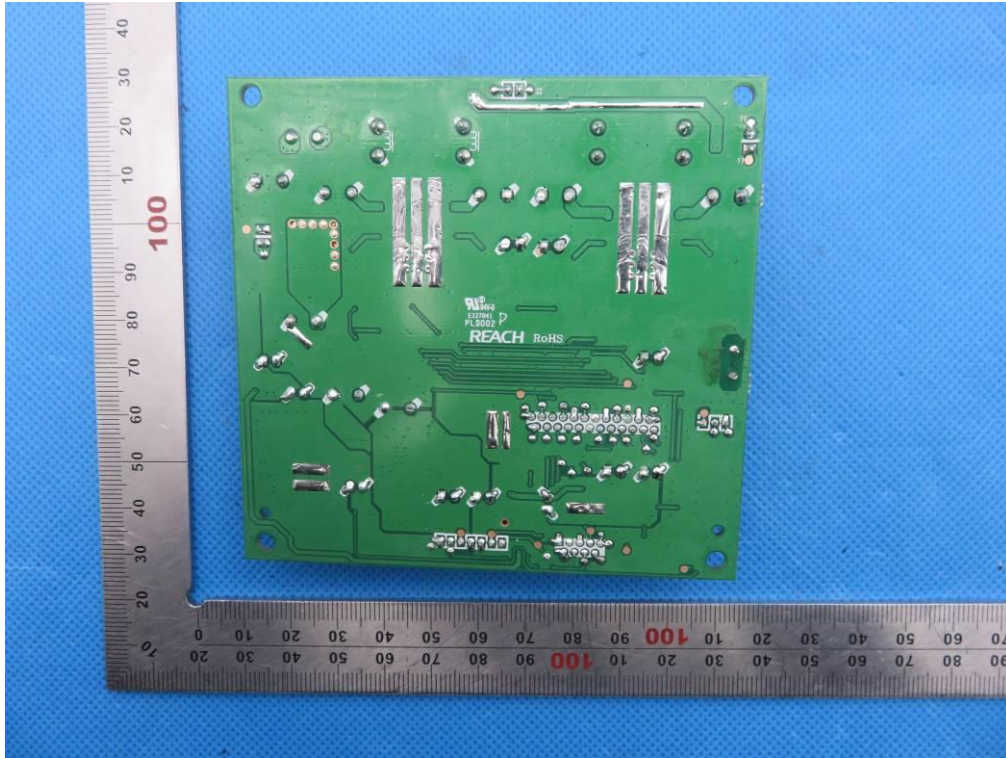

INTERNAL VIEW OF EUT-5

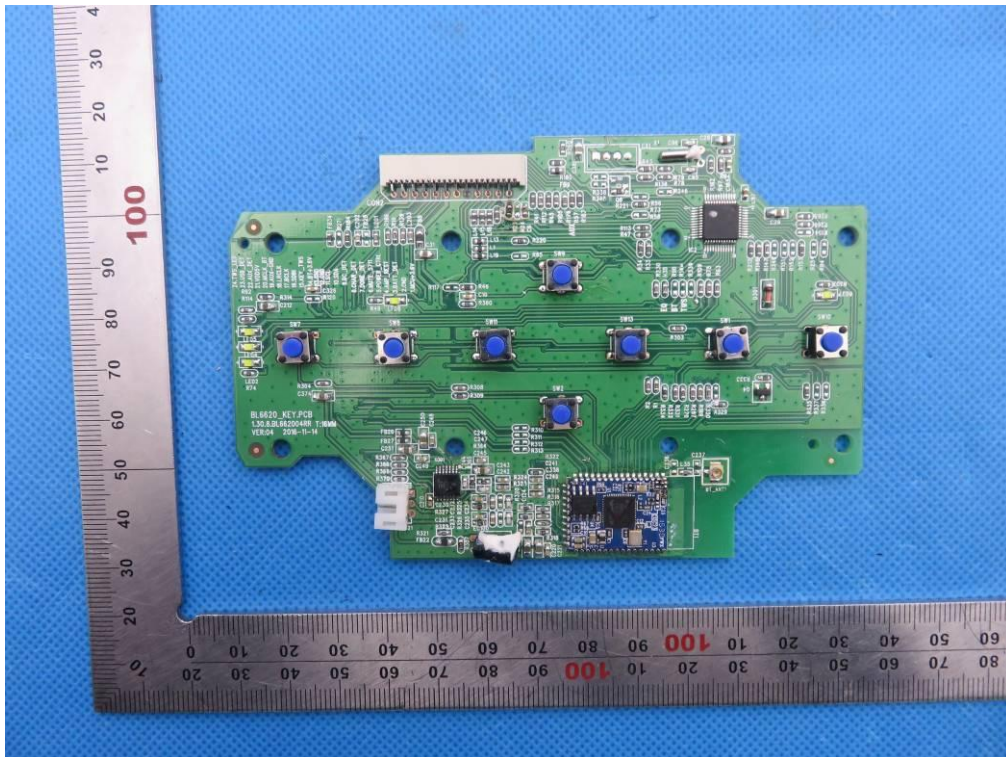

INTERNAL VIEW OF EUT-6

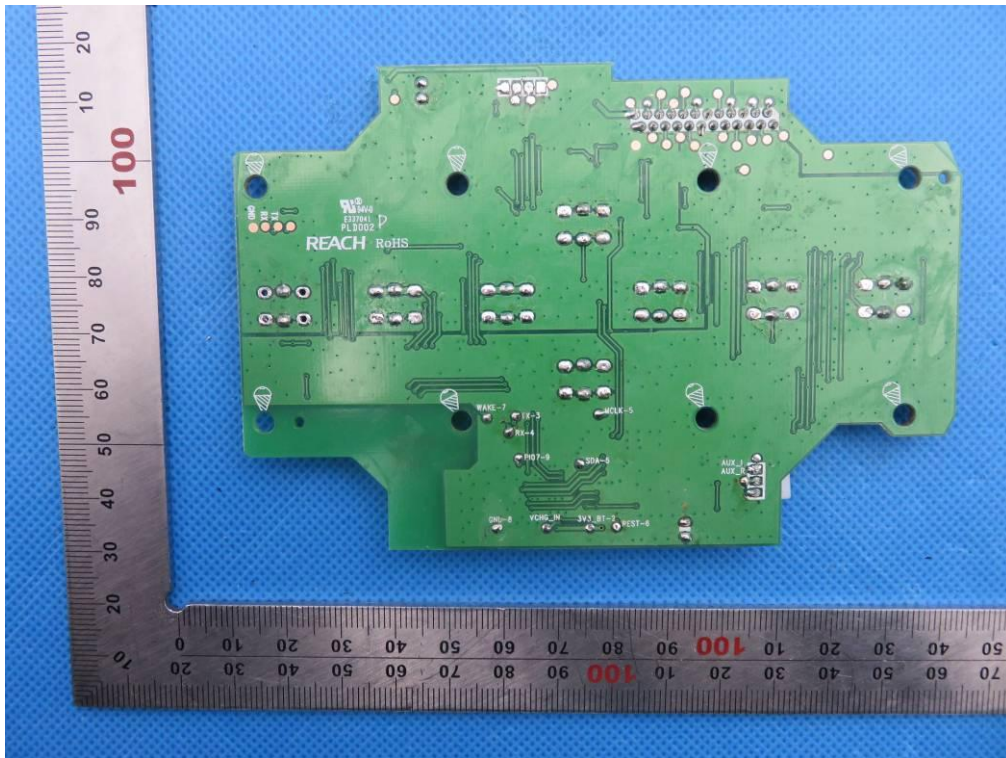

INTERNAL VIEW OF EUT-7

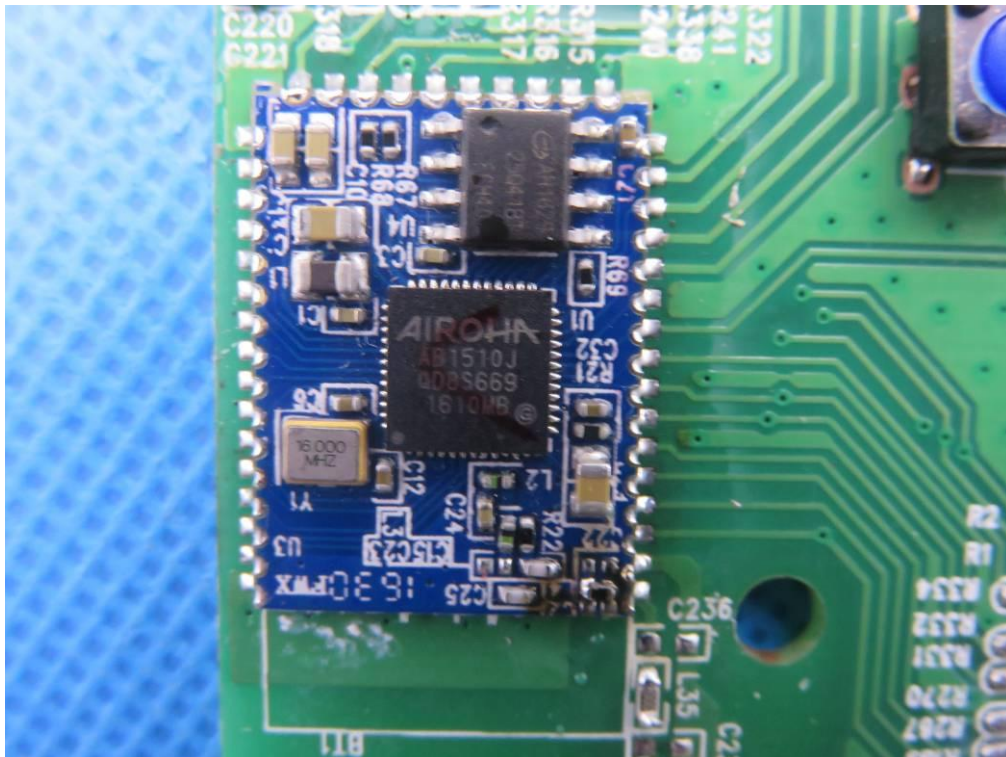

VIEW OF ADAPTER-1



VIEW OF ADAPTER-2



----END OF REPORT----