FCC Test Report

Report No.: AGC00653151201FE04

FCC ID : 2AFD9Q6
APPLICATION PURPOSE : Original Equipment
PRODUCT DESIGNATION : MOBILE PHONE
BRAND NAME : ZOOM
MODEL NAME : Q6
CLIENT : MOVEON TECHNOLOGY LIMITED
DATE OF ISSUE : Jan.08, 2016
STANDARD(S) : FCC Part 15.247
TEST PROCEDURE(S) : KDB 558074 v03r02
REPORT VERSION : V1.0

Attestation of Global Compliance (Shenzhen) Co., Ltd



CAUTION:

This report shall not be reproduced except in full without the written permission of the test laboratory and shall not be quoted out of context.



Report Revise Record

Report Version	Revise Time	Issued Date	Valid Version	Notes
V1.0	/	Jan.08, 2016	Valid	Original Report

TABLE OF CONTENTS

1. VERIFICATION OF CONFORMITY	5
2. GENERAL INFORMATION	6
2.1. PRODUCT DESCRIPTION.....	6
2.2. TABLE OF CARRIER FREQUENCIES.....	6
2.3. IEEE 802.11N MODULATION SCHEME	7
2.4. RELATED SUBMITTAL(S) / GRANT (S).....	7
2.5. TEST METHODOLOGY.....	7
2.6. SPECIAL ACCESSORIES	7
2.7. EQUIPMENT MODIFICATIONS	8
3. MEASUREMENT UNCERTAINTY.....	8
4. DESCRIPTION OF TEST MODES.....	8
5. SYSTEM TEST CONFIGURATION	9
5.1. CONFIGURATION OF EUT SYSTEM	9
5.2. EQUIPMENT USED IN EUT SYSTEM	9
5.3. SUMMARY OF TEST RESULTS	9
6. TEST FACILITY	10
7. OUTPUT POWER	12
7.1. MEASUREMENT PROCEDURE	12
7.2. TEST SET-UP (BLOCK DIAGRAM OF CONFIGURATION).....	13
7.3. LIMITS AND MEASUREMENT RESULT	14
8. 6DB BANDWIDTH	16
8.1. MEASUREMENT PROCEDURE	16
8.2. TEST SET-UP (BLOCK DIAGRAM OF CONFIGURATION).....	16
8.3. LIMITS AND MEASUREMENT RESULTS.....	16
9. CONDUCTED SPURIOUS EMISSION	21
9.1. MEASUREMENT PROCEDURE	21
9.2. TEST SET-UP (BLOCK DIAGRAM OF CONFIGURATION).....	21
9.3. MEASUREMENT EQUIPMENT USED.....	21
9.4. LIMITS AND MEASUREMENT RESULT	21
10. MAXIMUM CONDUCTED OUTPUT POWER SPECTRAL DENSITY	50
10.1 MEASUREMENT PROCEDURE	50
10.2 TEST SET-UP (BLOCK DIAGRAM OF CONFIGURATION).....	50
10.3 MEASUREMENT EQUIPMENT USED.....	50
10.4 LIMITS AND MEASUREMENT RESULT	50

- 11. RADIATED EMISSION 55**
 - 11.1. MEASUREMENT PROCEDURE55
 - 11.2. TEST SETUP56
 - 11.3. LIMITS AND MEASUREMENT RESULT57
 - 11.4. TEST RESULT57
- 12. BAND EDGE EMISSION 65**
 - 12.1. MEASUREMENT PROCEDURE65
 - 12.2. TEST SET-UP65
 - 12.3. Radiated Test Result66
 - 12.4. Conducted Test Result.....67
- 13. FCC LINE CONDUCTED EMISSION TEST 71**
 - 13.1. LIMITS OF LINE CONDUCTED EMISSION TEST71
 - 13.2. BLOCK DIAGRAM OF LINE CONDUCTED EMISSION TEST71
 - 13.3. PRELIMINARY PROCEDURE OF LINE CONDUCTED EMISSION TEST72
 - 13.4. FINAL PROCEDURE OF LINE CONDUCTED EMISSION TEST72
 - 13.5. TEST RESULT OF LINE CONDUCTED EMISSION TEST73
- APPENDIX A: PHOTOGRAPHS OF TEST SETUP 75**
- APPENDIX B: PHOTOGRAPHS OF EUT 77**

1. VERIFICATION OF CONFORMITY

Applicant	MOVEON TECHNOLOGY LIMITED
Address	world trade plaza-A block #3201-3202 Fuhong Road, Futian
Manufacturer	MOVEON TECHNOLOGY LIMITED
Address	world trade plaza-A block #3201-3202 Fuhong Road, Futian
Product Designation	MOBILE PHONE
Brand Name	ZOOM
Test Model	Q6
Date of test	Dec.29, 2015 to Dec.31, 2015
Deviation	None
Condition of Test Sample	Normal
Report Template	AGCRT-US-BGN/RF

We hereby certify that:

The above equipment was tested by Dongguan Precise Testing Service Co., Ltd. The test data, data evaluation, test procedures, and equipment configurations shown in this report were made in accordance with the procedures given in ANSI C63.4 (2009) and the energy emitted by the sample EUT tested as described in this report is in compliance with requirement of FCC Part 15 Rules requirement.

Tested By	<i>Matt Zhang</i>	

	Matt Zhang(Zhang Liang)	Jan.08, 2016
Reviewed By	<i>Bart Xie</i>	

	Bart Xie(Xie Xiaobin)	Jan.08, 2016
Approved By	<i>Solger Zhang</i>	

	Solger Zhang(Zhang Hongyi) Authorized Officer	Jan.08, 2016

2. GENERAL INFORMATION

2.1. PRODUCT DESCRIPTION

The EUT is designed as “MOBILE PHONE”. It is designed by way of utilizing the DSSS and OFDM technology to achieve the system operation.

A major technical description of EUT is described as following

Operation Frequency	2.412 GHz~2.462GHz
Output Power	IEEE 802.11b:10.76dBm; IEEE 802.11g:9.48dBm; IEEE 802.11n(20):9.26dBm; IEEE 802.11n(40):6.89dBm
Modulation	DSSS(DBPSK/DQPSK/CCK);OFDM(BPSK/QPSK/16-QAM/64-QAM)
Number of channels	11
Hardware Version	A3-02
Software Version	a3e_ax_tm_q6_b2b5_zoom_v06_07122015
Antenna Designation	Integrated Antenna
Antenna Gain	0.8dBi
Power Supply	DC3.7V by Built-in Li-ion Battery

2.2. TABLE OF CARRIER FREQUENCIES

Frequency Band	Channel Number	Frequency
2400~2483.5MHZ	1	2412 MHZ
	2	2417 MHZ
	3	2422 MHZ
	4	2427 MHZ
	5	2432 MHZ
	6	2437 MHZ
	7	2442 MHZ
	8	2447 MHZ
	9	2452 MHZ
	10	2457 MHZ
	11	2462 MHZ

Note: For 20MHZ bandwidth system use Channel 1 to Channel 11
For 40MHZ bandwidth system use Channel 3 to Channel 9

2.3. IEEE 802.11N MODULATION SCHEME

MCS Index	Nss	Modulation	R	NBPS	NCBPS		NDBPS		Data rate(Mbps)			
					800nsGI		20MHz	40MHz	20MHz	40MHz	20MHz	40MHz
					20MHz	40MHz						
0	1	BPSK	1/2	1	52	108	26	54	6.5	13.5		
1	1	QPSK	1/2	2	104	216	52	108	13.0	27.0		
2	1	QPSK	3/4	2	104	216	78	162	19.5	40.5		
3	1	16-QAM	1/2	4	208	432	104	216	26.0	54.0		
4	1	16-QAM	3/4	4	208	432	156	324	39.0	81.0		
5	1	64-QAM	2/3	6	312	648	208	432	52.0	108.0		
6	1	64-QAM	3/4	6	312	648	234	489	58.5	121.5		
7	1	64-QAM	5/6	6	312	648	260	540	65.0	135.0		

Symbol	Explanation
NSS	Number of spatial streams
R	Code rate
NBPS	Number of coded bits per single carrier
NCBPS	Number of coded bits per symbol
NDBPS	Number of data bits per symbol
GI	Guard interval

2.4. RELATED SUBMITTAL(S) / GRANT (S)

This submittal(s) (test report) is intended for **FCC ID: 2AFD9Q6** filing to comply with the FCC Part 15 requirements.

2.5. TEST METHODOLOGY

Both conducted and radiated testing was performed according to the procedures in ANSI C63.4 (2009).

Radiated testing was performed at an antenna to EUT distance 3 meters.

Others testing (listed at item 5.3) was performed according to the procedures in FCC Part 15.247 rules KDB 558074 D01 DTS Meas Guidance v03r02.

2.6. SPECIAL ACCESSORIES

Refer to section 5.2.

2.7. EQUIPMENT MODIFICATIONS

Not available for this EUT intended for grant.

3. MEASUREMENT UNCERTAINTY

Conducted measurement: +/- 2.75dB

Radiated measurement: +/- 3.2dB

4. DESCRIPTION OF TEST MODES

NO.	TEST MODE DESCRIPTION
1	Low channel TX
2	Middle channel TX
3	High channel TX
4	Normal operating

Note:
Transmit by 802.11b with Data rate (1/2/5.5/11)
Transmit by 802.11g with Data rate (6/9/12/18/24/36/48/54)
Transmit by 802.11n (20MHz) with Data rate (6.5/13/19.5/26/39/52/58.5/65)
Transmit by 802.11n (40MHz) with Data rate (13.5/27/40.5/54/81/108/121.5/135)

Note:

1. The EUT has been set to operate continuously on the lowest, middle and highest operation frequency Individually, and the eut is operating at its maximum duty cycle>or equal 98%
2. All modes under which configure applicable have been tested and the worst mode test data recording in the test report, if no other mode data.
3. For Radiated Emission, 3axis were chosen for testing for each applicable mode.

5. SYSTEM TEST CONFIGURATION

5.1. CONFIGURATION OF EUT SYSTEM

Configure:

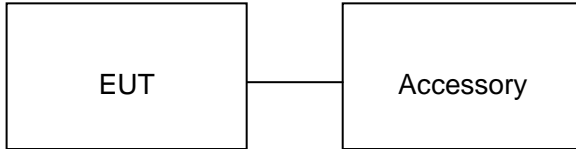

5.2. EQUIPMENT USED IN EUT SYSTEM

Item	Equipment	Model No.	ID or Specification	Note
1	Mobile Phone	Q6	FCC ID: 2AFD9Q6	EUT
2	Adapter	Q6	DC5V, 1000mA	Accessory
3	Battery	Q6	DC3.7V/1300mAh	Accessory
4	Earphone	Q6	N/A	Accessory
5	USB Cable	Q6	N/A	Accessory

Note: All the accessories have been used during the test in conduction emission test.

5.3. SUMMARY OF TEST RESULTS

FCC RULES	DESCRIPTION OF TEST	RESULT
§15.247	Output Power	Compliant
§15.247	6 dB Bandwidth	Compliant
§15.247	Conducted Spurious Emission	Compliant
§15.247	Maximum Conducted Output Power SPECTRAL Density	Compliant
§15.209	Radiated Emission	Compliant
§15.247	Band Edges	Compliant
§15.207	Line Conduction Emission	Compliant

Note: The EUT received power from DC3.7V lithium battery.

6. TEST FACILITY

Site	Dongguan Precise Testing Service Co., Ltd.
Location	Building D,Baoding Technology Park,Guangming Road2,Dongcheng District, Dongguan, Guangdong, China,
FCC Registration No.	371540
Description	The test site is constructed and calibrated to meet the FCC requirements in documents ANSI C63.4:2009.

ALL TEST EQUIPMENT LIST

FOR RADIATED EMISSION TEST (BELOW 1GHZ)

Radiated Emission Test Site					
Name of Equipment	Manufacturer	Model Number	Serial Number	Last Calibration	Due Calibration
EMI Test Receiver	Rohde & Schwarz	ESCI	101417	July 4, 2015	July 3, 2016
Trilog Broadband Antenna (25M-1GHz)	SCHWARZBECK	VULB9160	9160-3355	July 4, 2015	July 3, 2016
Signal Amplifier	SCHWARZBECK	BBV 9475	9745-0013	July 4, 2015	July 3, 2016
RF Cable	SCHWARZBECK	AK9515E	96221	July 4, 2015	July 3, 2016
3m Anechoic Chamber	CHENGYU	966	PTS-001	June 6, 2015	June 5, 2016
MULTI-DEVICE Positioning Controller	Max-Full	MF-7802	MF780208339	N/A	N/A
Active loop antenna (9K-30MHz)	Schwarzbeck	FMZB1519	1519-038	June 6, 2015	June 5, 2016
Spectrum analyzer	Agilent	E4407B	MY46185649	June 6, 2015	June 5, 2016
Power Probe	R&S	NRP-Z23	100323	July 25,2015	July 24,2016
RF attenuator	N/A	RFA20db	68	N/A	N/A

FOR RADIATED EMISSION TEST (1GHZ ABOVE)

Radiated Emission Test Site					
Name of Equipment	Manufacturer	Model Number	Serial Number	Last Calibration	Due Calibration
EMI Test Receiver	Rohde & Schwarz	ESCI	101417	July 4, 2015	July 3, 2016
Horn Antenna (1G-18GHz)	SCHWARZBECK	BBHA9120D	9120D-1246	July 11, 2015	July 10, 2016
Spectrum Analyzer	Agilent	E4411B	MY4511453	July 4, 2015	July 3, 2016
Signal Amplifier	SCHWARZBECK	BBV 9718	9718-269	July 7, 2015	July 6, 2016
RF Cable	SCHWARZBECK	AK9515H	96220	July 8, 2015	July 7, 2016
3m Anechoic Chamber	CHENGYU	966	PTS-001	June 6, 2015	June 5, 2016
MULTI-DEVICE Positioning Controller	Max-Full	MF-7802	MF780208339	N/A	N/A
Horn Ant (18G-40GHz)	Schwarzbeck	BBHA 9170	9170-181	June 6, 2015	June 5, 2016
Power Probe	R&S	NRP-Z23	100323	July 25,2015	July 24,2016
RF attenuator	N/A	RFA20db	68	N/A	N/A

Conducted Emission Test Site					
Name of Equipment	Manufacturer	Model Number	Serial Number	Last Calibration	Due Calibration
EMI Test Receiver	Rohde & Schwarz	ESCI	101417	July 4, 2015	July 3, 2016
Artificial Mains Network	Narda	L2-16B	000WX31025	July 8, 2015	July 7, 2016
Artificial Mains Network (AUX)	Narda	L2-16B	000WX31026	July 8, 2015	July 7, 2016
RF Cable	SCHWARZBECK	AK9515E	96222	July 4, 2015	July 3, 2016
Shielded Room	CHENGYU	843	PTS-002	June 6,2015	June 5,2016

7. OUTPUT POWER

7.1. MEASUREMENT PROCEDURE

For max average conducted output power test:

1. Connect EUT RF output port to power probe through an RF attenuator.
2. Connect the power probe to the PC.
3. Set the EUT Work on the top, the middle and the bottom operation frequency individually.
4. Record the maximum power from the software.

Note : The EUT was tested according to KDB 558074v03r02 for compliance to FCC 47CFR 15.247 requirements.

7.2. TEST SET-UP (BLOCK DIAGRAM OF CONFIGURATION)

AVERAGE POWER SETUP

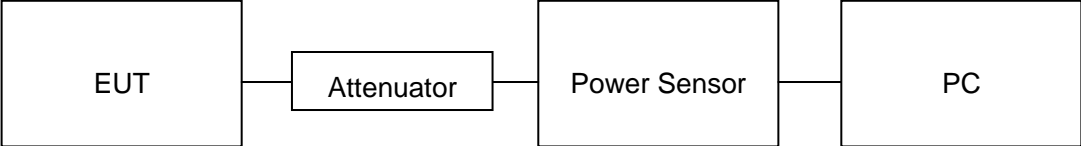

7.3. LIMITS AND MEASUREMENT RESULT

TEST ITEM	OUTPUT POWER
TEST MODE	802.11b with data rate 1

Frequency (GHz)	Average Power (dBm)	Applicable Limits (dBm)	Pass or Fail
2.412	10.76	30	Pass
2.437	10.69	30	Pass
2.462	10.61	30	Pass

TEST ITEM	OUTPUT POWER
TEST MODE	802.11g with data rate 6

Frequency (GHz)	Average Power (dBm)	Applicable Limits (dBm)	Pass or Fail
2.412	9.48	30	Pass
2.437	9.39	30	Pass
2.462	9.36	30	Pass

TEST ITEM	OUTPUT POWER
TEST MODE	802.11n 20 with data rate 6.5

Frequency (GHz)	Average Power (dBm)	Applicable Limits (dBm)	Pass or Fail
2.412	9.26	30	Pass
2.437	9.23	30	Pass
2.462	9.15	30	Pass

TEST ITEM	OUTPUT POWER
TEST MODE	802.11n 40 with data rate 13.5

Frequency (GHz)	Average Power (dBm)	Applicable Limits (dBm)	Pass or Fail
2.422	6.89	30	Pass
2.437	6.84	30	Pass
2.452	6.75	30	Pass

8. 6DB BANDWIDTH

8.1. MEASUREMENT PROCEDURE

1. Connect EUT RF output port to the Spectrum Analyzer through an RF attenuator
2. Set the EUT Work on the top, the middle and the bottom operation frequency individually.
3. Set SPA Centre Frequency = Operation Frequency, RBW= 100 KHz, VBW \geq 3 \times RBW.
4. Set SPA Trace 1 Max hold, then View.

Note: The EUT was tested according to KDB 558074 for compliance to FCC 47CFR 15.247 requirements.

8.2. TEST SET-UP (BLOCK DIAGRAM OF CONFIGURATION)

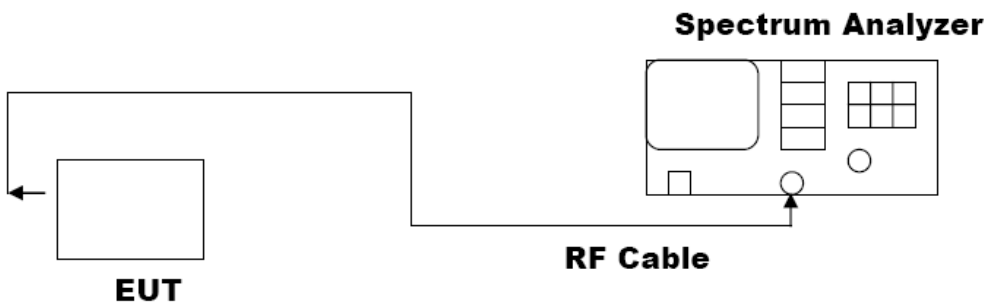

8.3. LIMITS AND MEASUREMENT RESULTS

Mode	Channel	6dB Bandwidth [MHz]	OBW [MHz]	Verdict
11B	LCH	9.61	12.65	PASS
11B	MCH	9.06	12.56	PASS
11B	HCH	8.68	12.69	PASS
11G	LCH	15.19	16.38	PASS
11G	MCH	16.00	16.38	PASS
11G	HCH	15.09	16.34	PASS
11N20SISO	LCH	14.97	17.55	PASS
11N20SISO	MCH	14.74	17.56	PASS
11N20SISO	HCH	14.95	17.55	PASS
11N40SISO	LCH	34.07	35.75	PASS
11N40SISO	MCH	34.00	35.79	PASS
11N40SISO	HCH	35.32	35.78	PASS

Test Graph

Graphs	
<p>11B/LCH</p>	<div style="border: 1px solid black; padding: 5px;"> <p style="text-align: right;">R L</p> <p>Agilent</p> <hr/> <p style="text-align: center;">Ch Freq 2.412 GHz Trig Free</p> <p>Occupied Bandwidth</p> <hr/> <p>Ref 30 dBm #Atten 40 dB</p> <p>#Peak Log 10 dB/Offst 0.9 dB</p> <p style="text-align: center;">Center 2.412 00 GHz Span 30 MHz #Res BW 100 kHz #VBW 300 kHz Sweep 2.88 ms (601 pts)</p> <div style="border: 2px solid green; padding: 2px;"> <p>Occupied Bandwidth 12.6463 MHz Occ BW % Pwr 99.00 %</p> <p>Transmit Freq Error -23.261 kHz x dB -6.00 dB</p> <p>x dB Bandwidth 9.612 MHz</p> </div> <p style="color: red; font-size: small;">File name error</p> </div> <div style="border: 1px solid gray; padding: 5px; margin-top: 5px;"> <p>Freq/Channel</p> <p>Center Freq 2.41200000 GHz</p> <p>Start Freq 2.39700000 GHz</p> <p>Stop Freq 2.42700000 GHz</p> <p>CF Step 3.00000000 MHz Auto Man</p> <p>Freq Offset 0.00000000 Hz</p> <p>Signal Track On Off</p> </div>
<p>11B/MCH</p>	<div style="border: 1px solid black; padding: 5px;"> <p style="text-align: right;">R L</p> <p>Agilent</p> <hr/> <p style="text-align: center;">Ch Freq 2.437 GHz Trig Free</p> <p>Occupied Bandwidth</p> <hr/> <p>Ref 30 dBm #Atten 40 dB</p> <p>#Peak Log 10 dB/Offst 0.9 dB</p> <p style="text-align: center;">Center 2.437 00 GHz Span 30 MHz #Res BW 100 kHz #VBW 300 kHz Sweep 2.88 ms (601 pts)</p> <div style="border: 2px solid green; padding: 2px;"> <p>Occupied Bandwidth 12.5592 MHz Occ BW % Pwr 99.00 %</p> <p>Transmit Freq Error -29.273 kHz x dB -6.00 dB</p> <p>x dB Bandwidth 9.057 MHz</p> </div> <p style="color: red; font-size: small;">File name error</p> </div> <div style="border: 1px solid gray; padding: 5px; margin-top: 5px;"> <p>Freq/Channel</p> <p>Center Freq 2.43700000 GHz</p> <p>Start Freq 2.42200000 GHz</p> <p>Stop Freq 2.45200000 GHz</p> <p>CF Step 3.00000000 MHz Auto Man</p> <p>Freq Offset 0.00000000 Hz</p> <p>Signal Track On Off</p> </div>
<p>11B/HCH</p>	<div style="border: 1px solid black; padding: 5px;"> <p style="text-align: right;">R L</p> <p>Agilent</p> <hr/> <p style="text-align: center;">Ch Freq 2.462 GHz Trig Free</p> <p>Occupied Bandwidth</p> <hr/> <p>Ref 30 dBm #Atten 40 dB</p> <p>#Peak Log 10 dB/Offst 0.9 dB</p> <p style="text-align: center;">Center 2.462 00 GHz Span 30 MHz #Res BW 100 kHz #VBW 300 kHz Sweep 2.88 ms (601 pts)</p> <div style="border: 2px solid green; padding: 2px;"> <p>Occupied Bandwidth 12.6946 MHz Occ BW % Pwr 99.00 %</p> <p>Transmit Freq Error -32.938 kHz x dB -6.00 dB</p> <p>x dB Bandwidth 8.676 MHz</p> </div> <p style="color: red; font-size: small;">File name error</p> </div> <div style="border: 1px solid gray; padding: 5px; margin-top: 5px;"> <p>Freq/Channel</p> <p>Center Freq 2.46200000 GHz</p> <p>Start Freq 2.44700000 GHz</p> <p>Stop Freq 2.47700000 GHz</p> <p>CF Step 3.00000000 MHz Auto Man</p> <p>Freq Offset 0.00000000 Hz</p> <p>Signal Track On Off</p> </div>

<p>11G/LCH</p>	<p>Agilent R L</p> <p>Ch Freq 2.412 GHz Trig Free</p> <p>Center Freq 2.41200000 GHz</p> <p>Start Freq 2.39700000 GHz</p> <p>Stop Freq 2.42700000 GHz</p> <p>CF Step 3.00000000 MHz Auto Man</p> <p>Freq Offset 0.00000000 Hz</p> <p>Signal Track On Off</p> <p>Ref 30 dBm #Atten 40 dB</p> <p>#Peak Log 10 dB/Offst 0.9 dB</p> <p>Center 2.412 00 GHz Span 30 MHz</p> <p>#Res BW 100 kHz #VBW 300 kHz Sweep 2.88 ms (601 pts)</p> <p>Occupied Bandwidth 16.3759 MHz Occ BW % Pwr 99.00 % x dB -6.00 dB</p> <p>Transmit Freq Error -12.064 kHz</p> <p>x dB Bandwidth 15.188 MHz</p> <p>File name error</p>
<p>11G/MCH</p>	<p>Agilent R L</p> <p>Ch Freq 2.437 GHz Trig Free</p> <p>Center Freq 2.43700000 GHz</p> <p>Start Freq 2.42200000 GHz</p> <p>Stop Freq 2.45200000 GHz</p> <p>CF Step 3.00000000 MHz Auto Man</p> <p>Freq Offset 0.00000000 Hz</p> <p>Signal Track On Off</p> <p>Ref 30 dBm #Atten 40 dB</p> <p>#Peak Log 10 dB/Offst 0.9 dB</p> <p>Center 2.437 00 GHz Span 30 MHz</p> <p>#Res BW 100 kHz #VBW 300 kHz Sweep 2.88 ms (601 pts)</p> <p>Occupied Bandwidth 16.3766 MHz Occ BW % Pwr 99.00 % x dB -6.00 dB</p> <p>Transmit Freq Error -15.195 kHz</p> <p>x dB Bandwidth 15.999 MHz</p> <p>File name error</p>
<p>11G/HCH</p>	<p>Agilent R L</p> <p>Ch Freq 2.462 GHz Trig Free</p> <p>Center Freq 2.46200000 GHz</p> <p>Start Freq 2.44700000 GHz</p> <p>Stop Freq 2.47700000 GHz</p> <p>CF Step 3.00000000 MHz Auto Man</p> <p>Freq Offset 0.00000000 Hz</p> <p>Signal Track On Off</p> <p>Ref 30 dBm #Atten 40 dB</p> <p>#Peak Log 10 dB/Offst 0.9 dB</p> <p>Center 2.462 00 GHz Span 30 MHz</p> <p>#Res BW 100 kHz #VBW 300 kHz Sweep 2.88 ms (601 pts)</p> <p>Occupied Bandwidth 16.3423 MHz Occ BW % Pwr 99.00 % x dB -6.00 dB</p> <p>Transmit Freq Error -630.455 Hz</p> <p>x dB Bandwidth 15.094 MHz</p> <p>File name error</p>

<p>11N20SISO/LCH</p>	<p>Agilent R T</p> <p>Ch Freq 2.412 GHz Trig Free</p> <p>Center Freq 2.41200000 GHz</p> <p>Start Freq 2.39700000 GHz</p> <p>Stop Freq 2.42700000 GHz</p> <p>CF Step 3.00000000 MHz Auto Man</p> <p>Freq Offset 0.00000000 Hz</p> <p>Signal Track On Off</p> <p>Occupied Bandwidth 17.5532 MHz Occ BW % Pwr 99.00 % x dB -6.00 dB</p> <p>Transmit Freq Error -4.479 kHz</p> <p>x dB Bandwidth 14.967 MHz</p> <p>File name error</p>
<p>11N20SISO/MCH</p>	<p>Agilent R L</p> <p>Ch Freq 2.437 GHz Trig Free</p> <p>Center Freq 2.43700000 GHz</p> <p>Start Freq 2.42200000 GHz</p> <p>Stop Freq 2.45200000 GHz</p> <p>CF Step 3.00000000 MHz Auto Man</p> <p>Freq Offset 0.00000000 Hz</p> <p>Signal Track On Off</p> <p>Occupied Bandwidth 17.5551 MHz Occ BW % Pwr 99.00 % x dB -6.00 dB</p> <p>Transmit Freq Error -3.187 kHz</p> <p>x dB Bandwidth 14.739 MHz</p> <p>File name error</p>
<p>11N20SISO/HCH</p>	<p>Agilent R L</p> <p>Ch Freq 2.462 GHz Trig Free</p> <p>Center Freq 2.46200000 GHz</p> <p>Start Freq 2.44700000 GHz</p> <p>Stop Freq 2.47700000 GHz</p> <p>CF Step 3.00000000 MHz Auto Man</p> <p>Freq Offset 0.00000000 Hz</p> <p>Signal Track On Off</p> <p>Occupied Bandwidth 17.5530 MHz Occ BW % Pwr 99.00 % x dB -6.00 dB</p> <p>Transmit Freq Error 5.720 kHz</p> <p>x dB Bandwidth 14.948 MHz</p> <p>File name error</p>

<p>11N40SISO/LCH</p>	<p>Agilent R L</p> <p>Ch Freq 2.422 GHz Trig Free</p> <p>Center 2.422 00 GHz Span 60 MHz</p> <p>Res BW 100 kHz VBW 300 kHz Sweep 5.76 ms (601 pts)</p> <p>Occupied Bandwidth 35.7451 MHz Occ BW % Pwr 99.00 % x dB -6.00 dB</p> <p>Transmit Freq Error -55.953 kHz x dB Bandwidth 34.073 MHz</p> <p>File name error</p> <p>Freq/Channel</p> <p>Center Freq 2.42200000 GHz</p> <p>Start Freq 2.39200000 GHz</p> <p>Stop Freq 2.45200000 GHz</p> <p>CF Step 6.00000000 MHz Auto Man</p> <p>Freq Offset 0.00000000 Hz</p> <p>Signal Track On Off</p>
<p>11N40SISO/MCH</p>	<p>Agilent R L</p> <p>Ch Freq 2.437 GHz Trig Free</p> <p>Center 2.437 00 GHz Span 60 MHz</p> <p>Res BW 100 kHz VBW 300 kHz Sweep 5.76 ms (601 pts)</p> <p>Occupied Bandwidth 35.7875 MHz Occ BW % Pwr 99.00 % x dB -6.00 dB</p> <p>Transmit Freq Error -54.048 kHz x dB Bandwidth 33.999 MHz</p> <p>File name error</p> <p>Freq/Channel</p> <p>Center Freq 2.43700000 GHz</p> <p>Start Freq 2.40700000 GHz</p> <p>Stop Freq 2.46700000 GHz</p> <p>CF Step 6.00000000 MHz Auto Man</p> <p>Freq Offset 0.00000000 Hz</p> <p>Signal Track On Off</p>
<p>11N40SISO/HCH</p>	<p>Agilent R L</p> <p>Ch Freq 2.452 GHz Trig Free</p> <p>Center 2.452 00 GHz Span 60 MHz</p> <p>Res BW 100 kHz VBW 300 kHz Sweep 5.76 ms (601 pts)</p> <p>Occupied Bandwidth 35.7798 MHz Occ BW % Pwr 99.00 % x dB -6.00 dB</p> <p>Transmit Freq Error -23.139 kHz x dB Bandwidth 35.318 MHz</p> <p>File name error</p> <p>Freq/Channel</p> <p>Center Freq 2.45200000 GHz</p> <p>Start Freq 2.42200000 GHz</p> <p>Stop Freq 2.48200000 GHz</p> <p>CF Step 6.00000000 MHz Auto Man</p> <p>Freq Offset 0.00000000 Hz</p> <p>Signal Track On Off</p>

9. CONDUCTED SPURIOUS EMISSION

9.1. MEASUREMENT PROCEDURE

1. Connect EUT RF output port to the Spectrum Analyzer through an RF attenuator
2. Set the EUT Work on the top, the middle and the bottom operation frequency individually.
3. Set SPA Trace 1 Max hold, then View.

Note: The EUT was tested according to KDB 558074 for compliance to FCC 47CFR 15.247 requirements. Owing to satisfy the requirements of the number of measurement points, we set the RBW=1MHz, VBW>RBW, scan up through 10th harmonic, and consider the tested results as the worst case, if the tested results conform to the requirement, we can deem that the real tested results(set the RBW=100KHz, VBW > RBW) are conform to the requirement.

9.2. TEST SET-UP (BLOCK DIAGRAM OF CONFIGURATION)

The same as described in section 8.2.

9.3. MEASUREMENT EQUIPMENT USED

The same as described in section 6.

9.4. LIMITS AND MEASUREMENT RESULT

LIMITS AND MEASUREMENT RESULT		
Applicable Limits	Measurement Result	
	Test Data	Criteria
In any 100 KHz Bandwidth Outside the frequency band in which the spread spectrum intentional radiator is operating, the radio frequency power that is produce by the intentional radiator shall be at least 20 dB below that in 100KHz bandwidth within the band that contains the highest level of the desired power. In addition, radiation emissions which fall in the restricted bands, as defined in §15.205(a), must also comply with the radiated emission limits specified in§15.209(a)	At least -20dBc than the limit Specified on the BOTTOM Channel	PASS
	At least -20dBc than the limit Specified on the TOP Channel	PASS

Test Graph

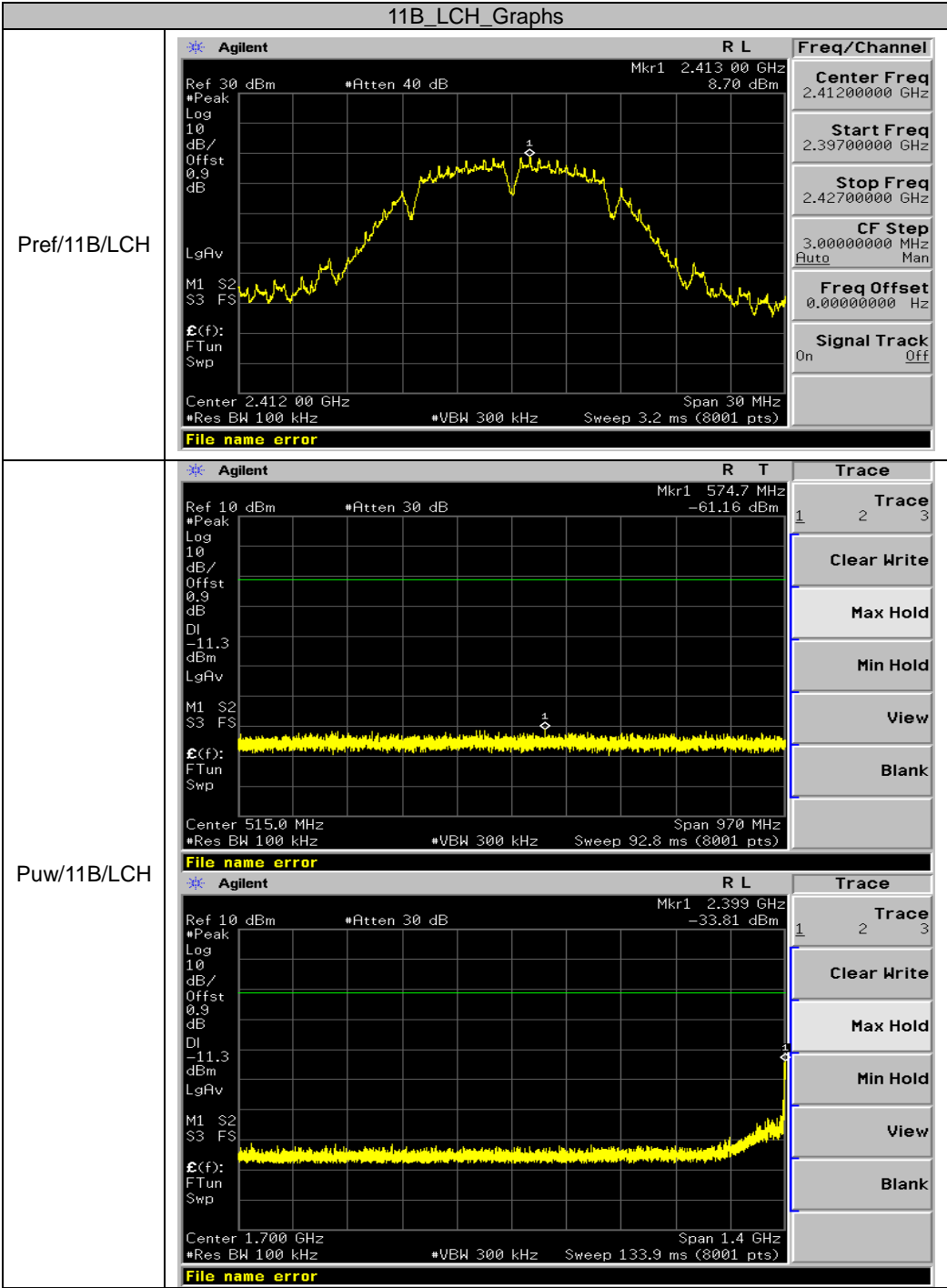

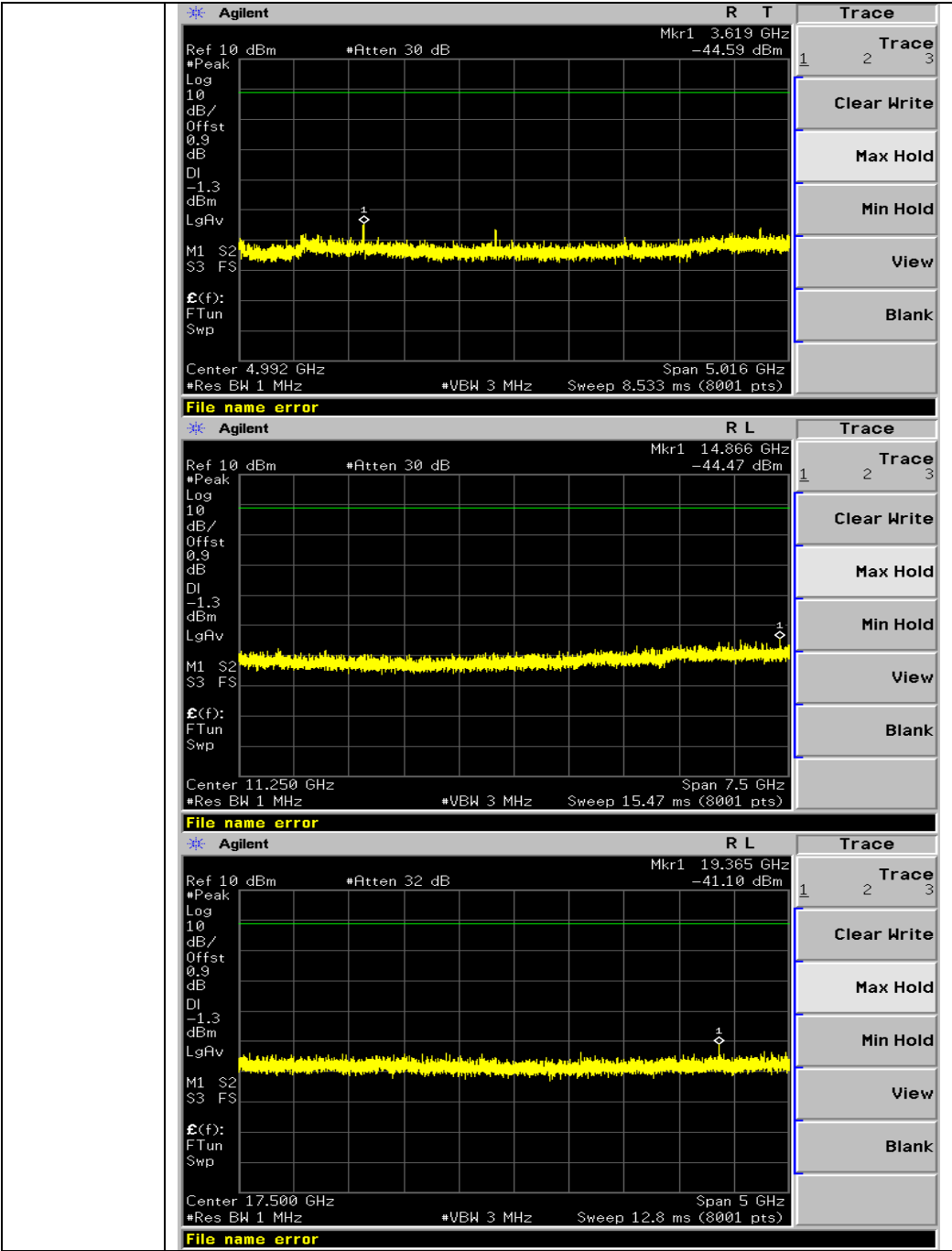

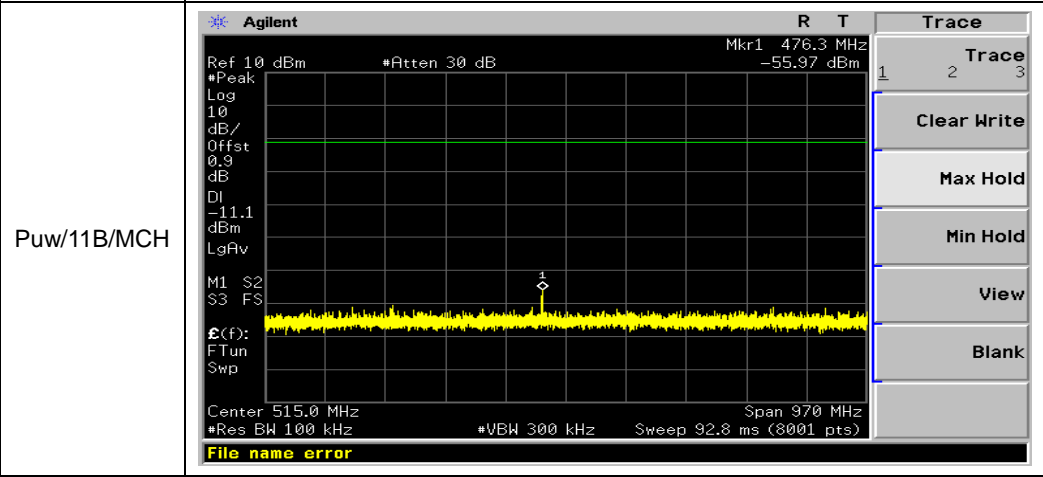
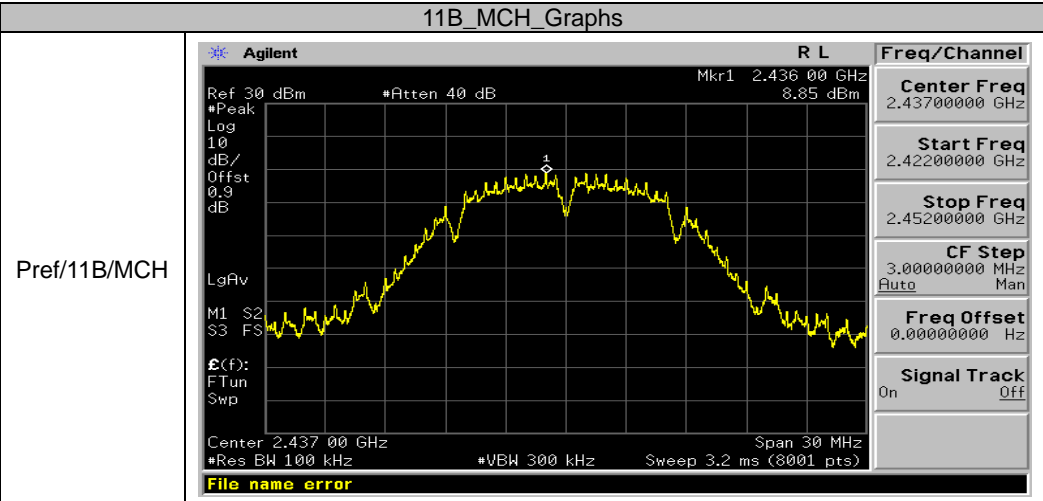
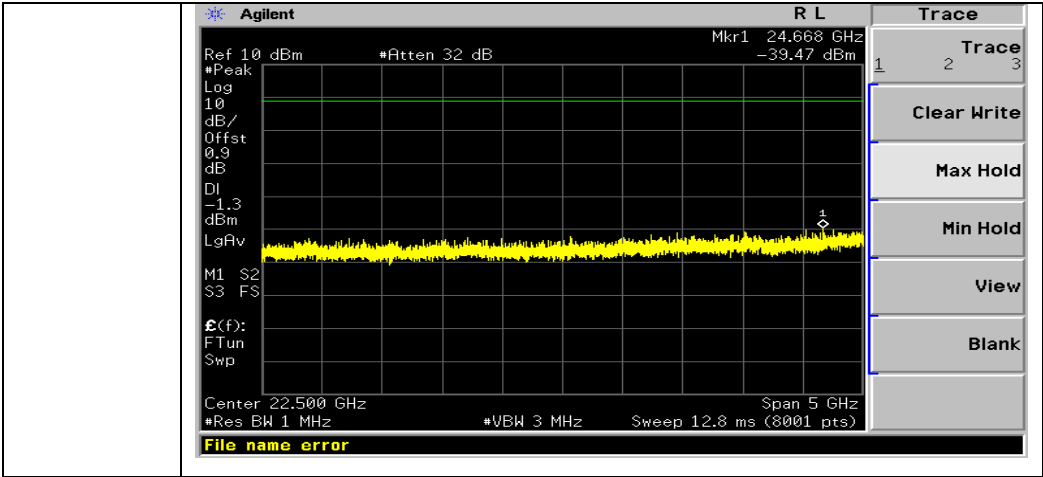

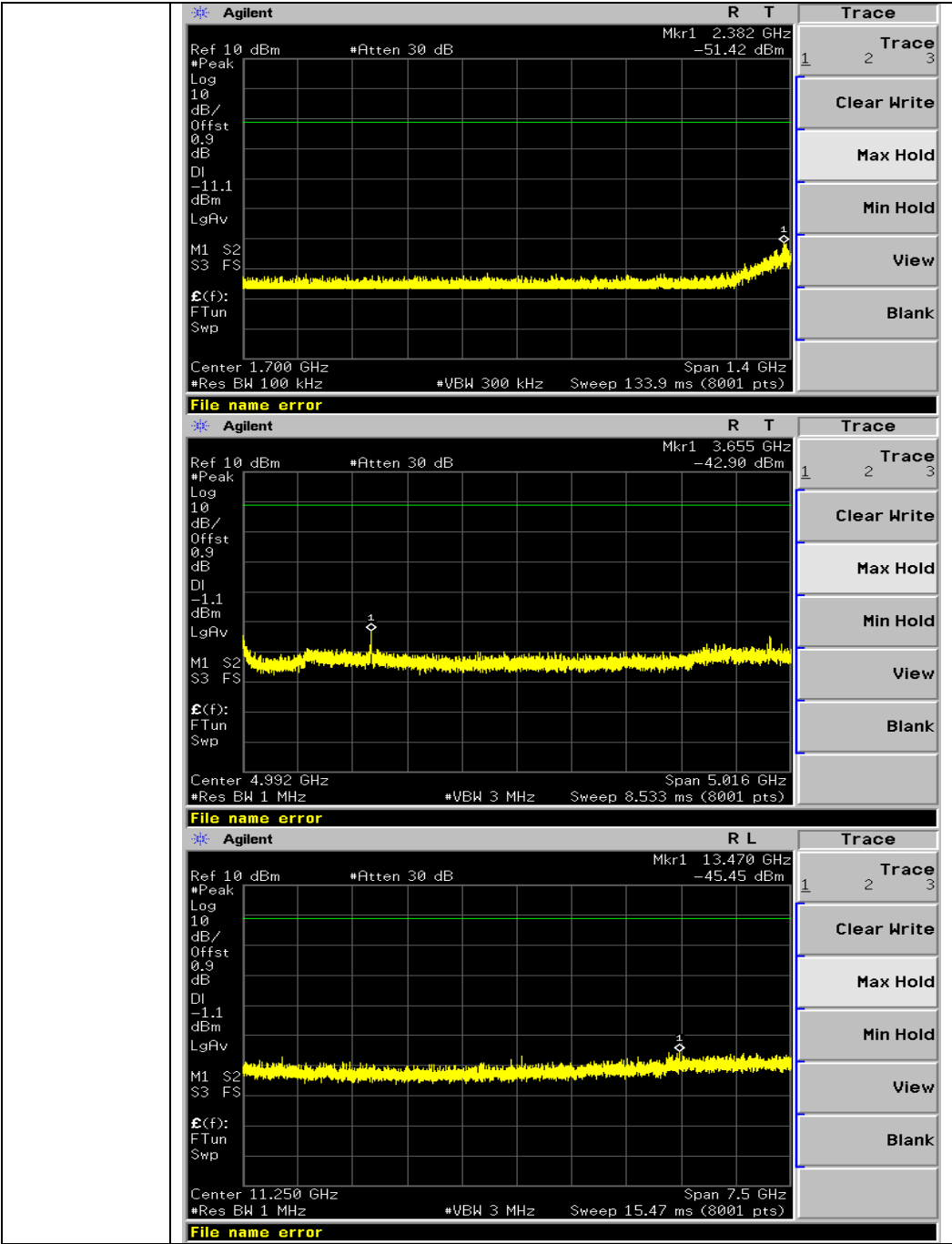

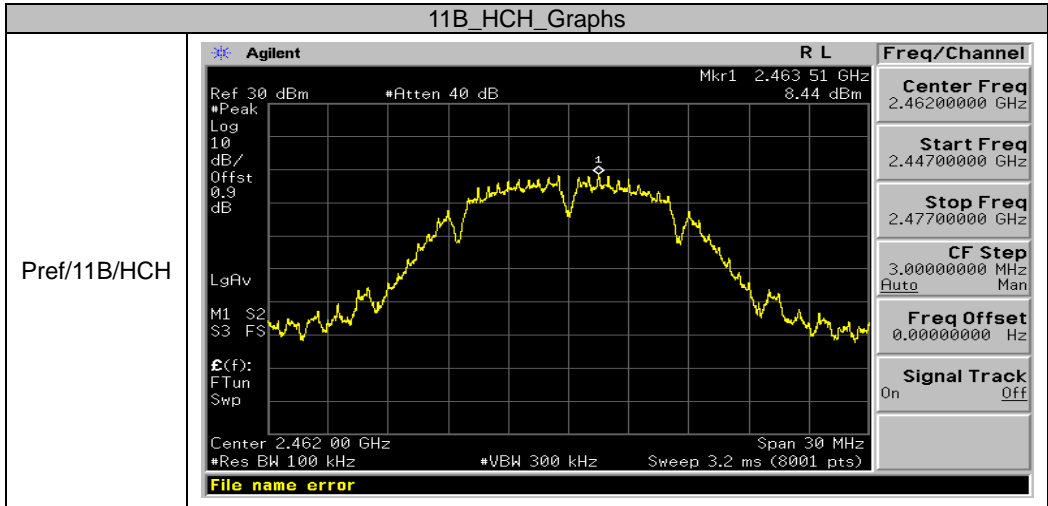
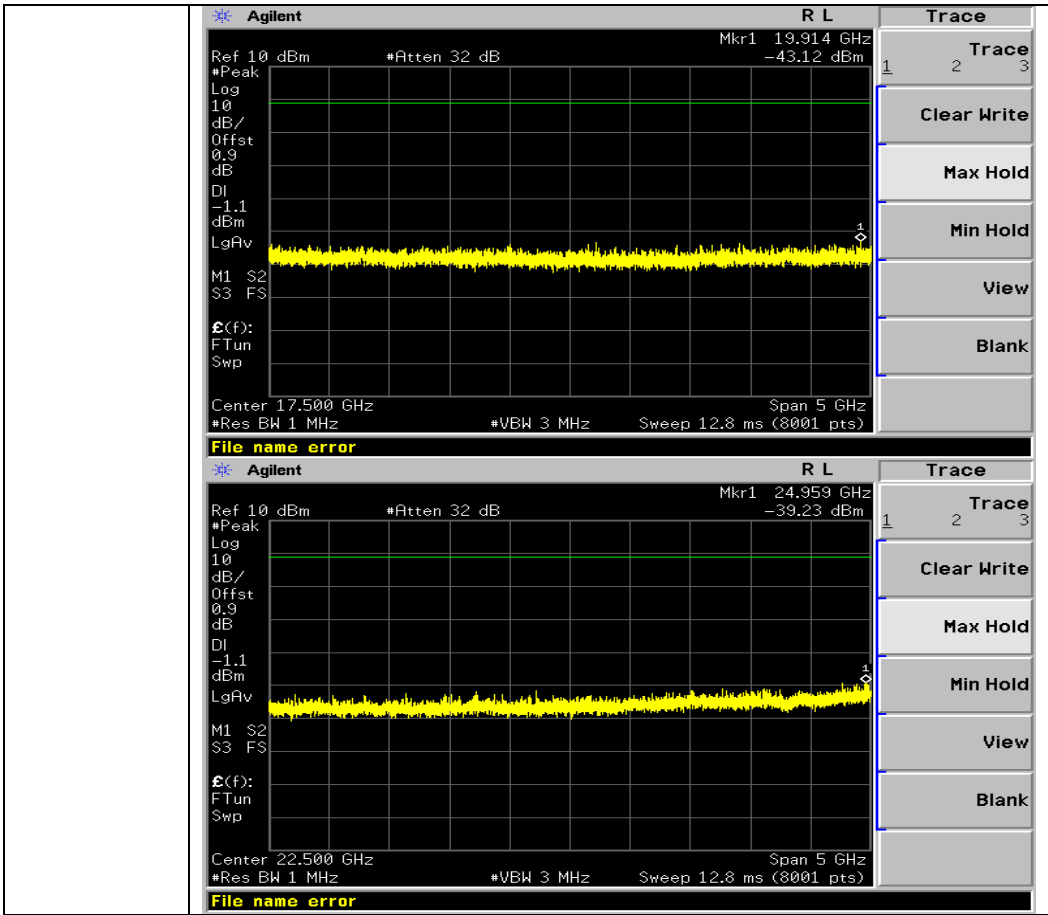

Pref/11B/HCH

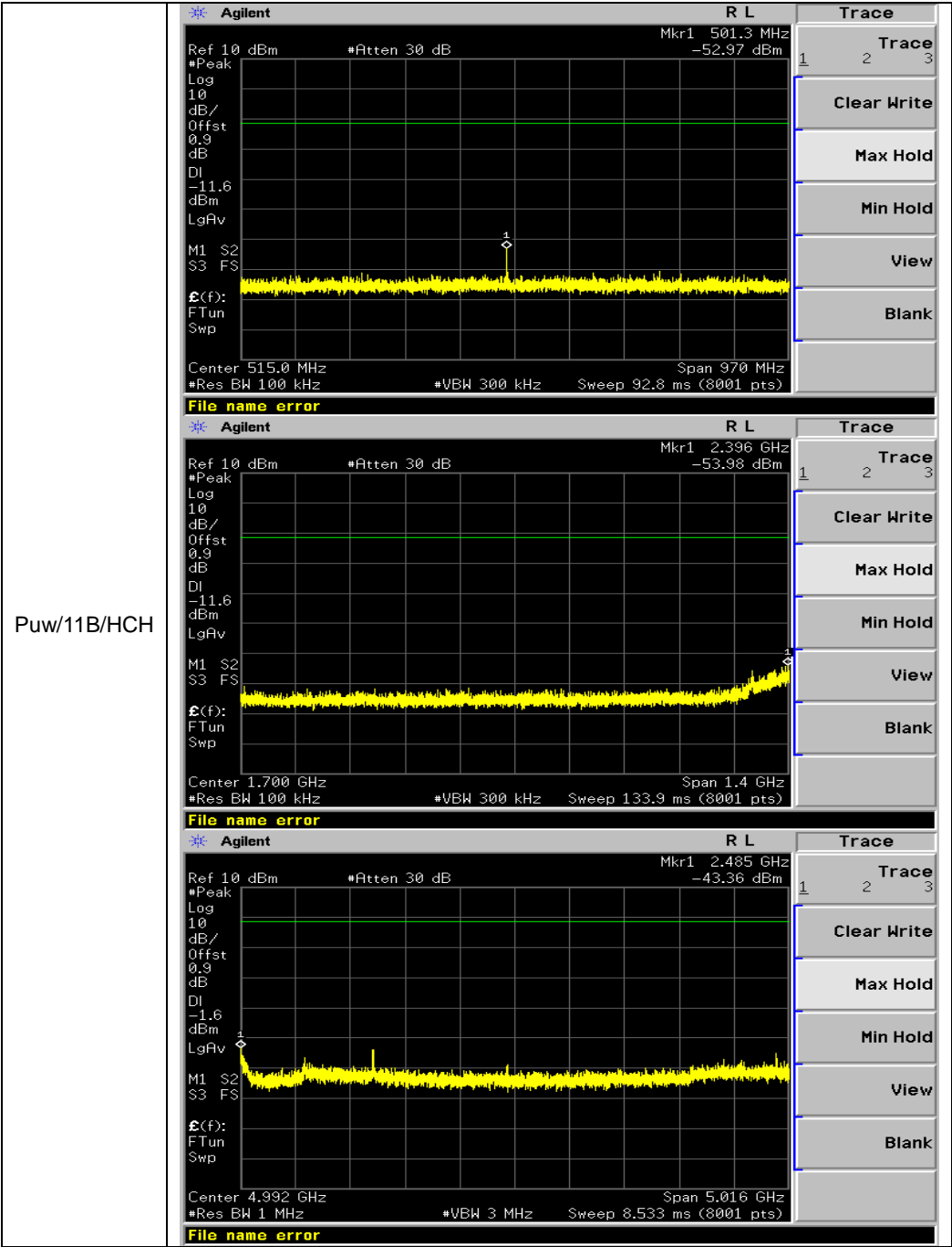

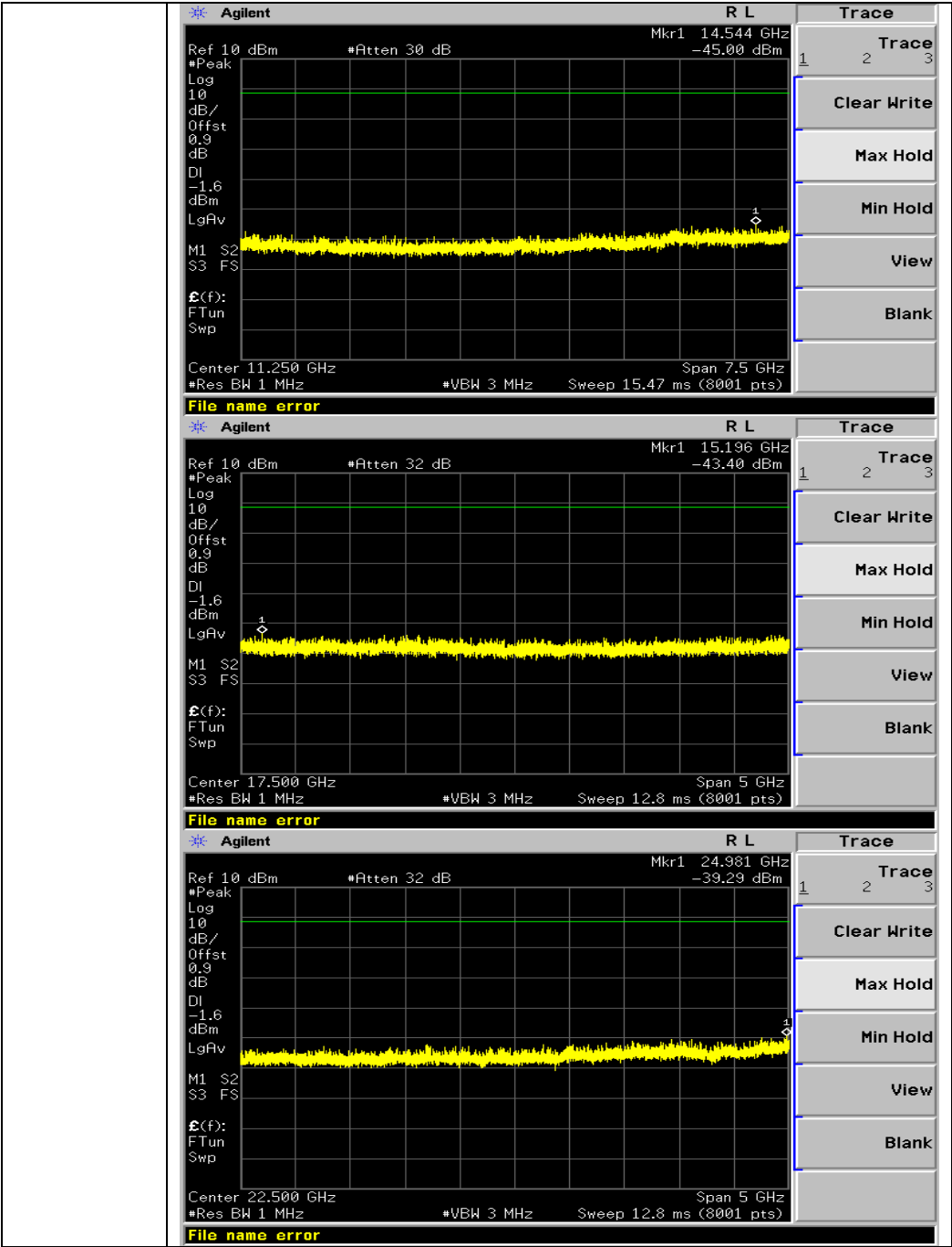

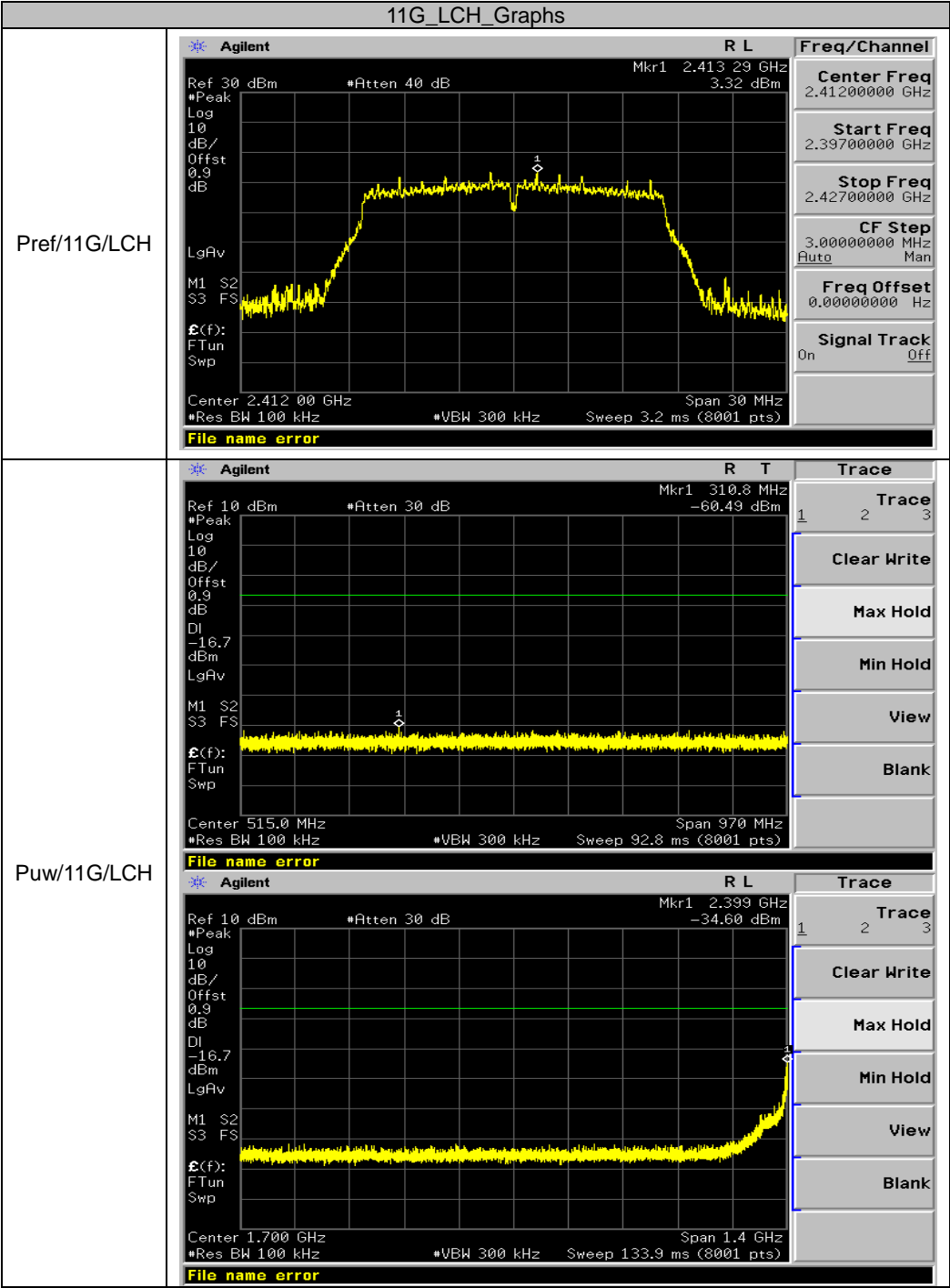



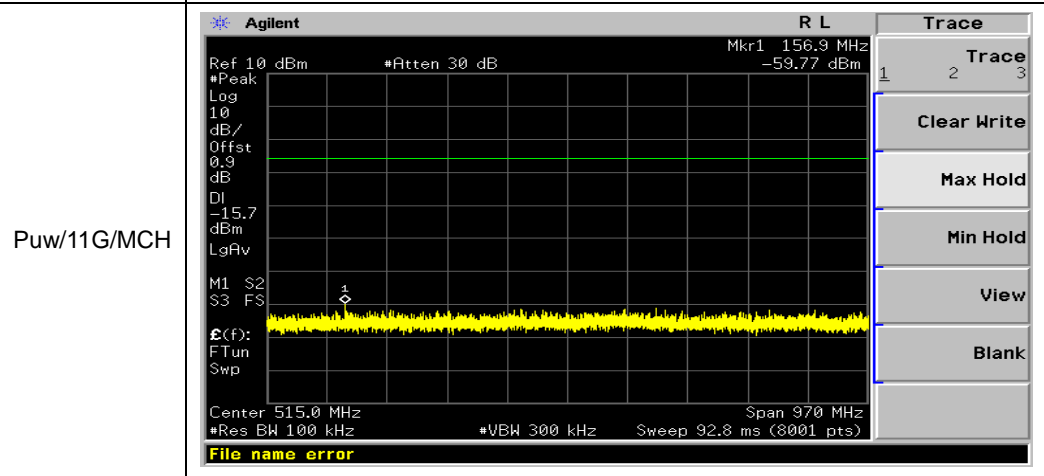
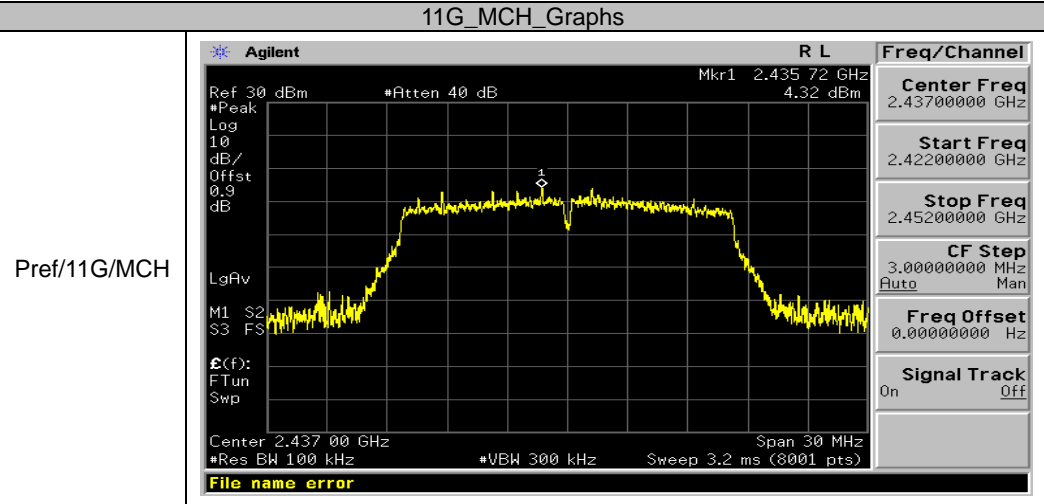
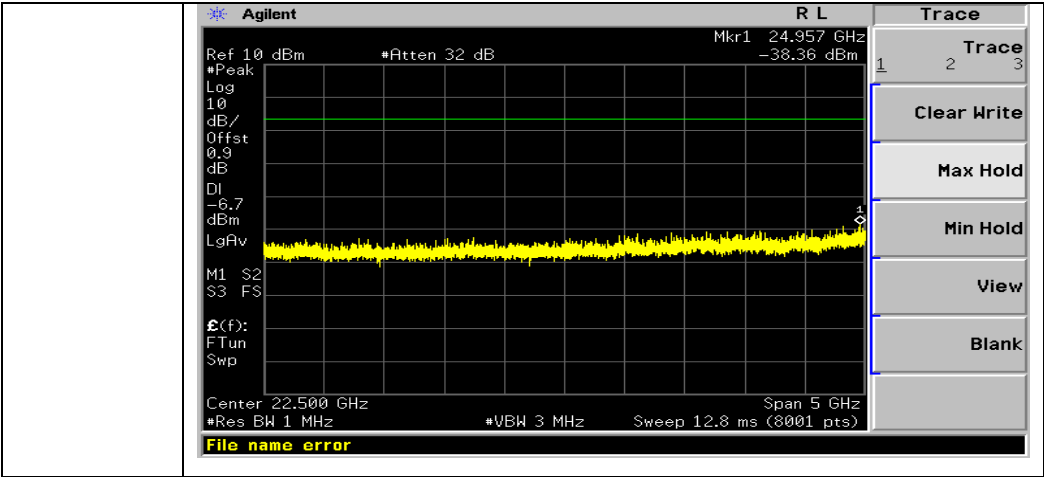

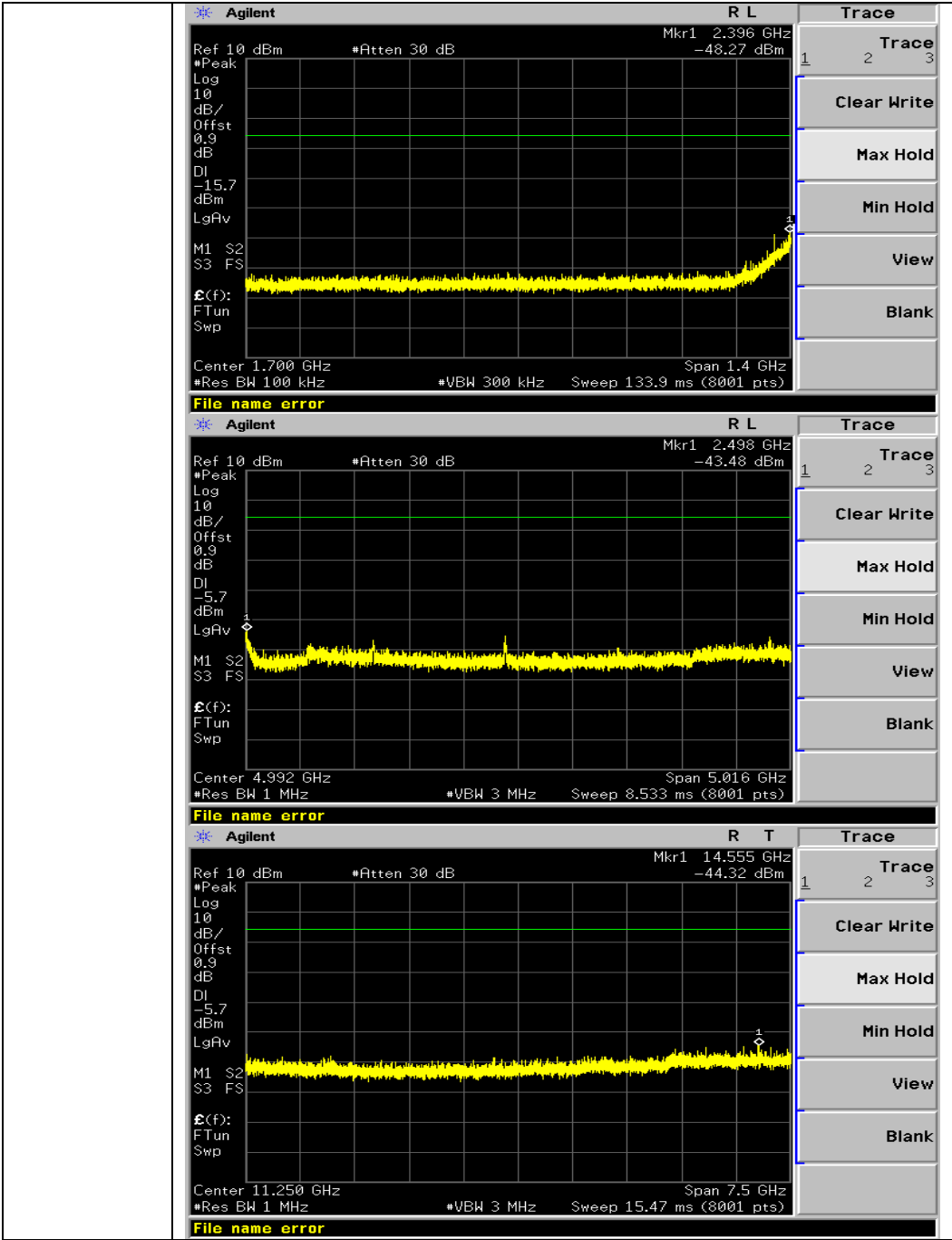

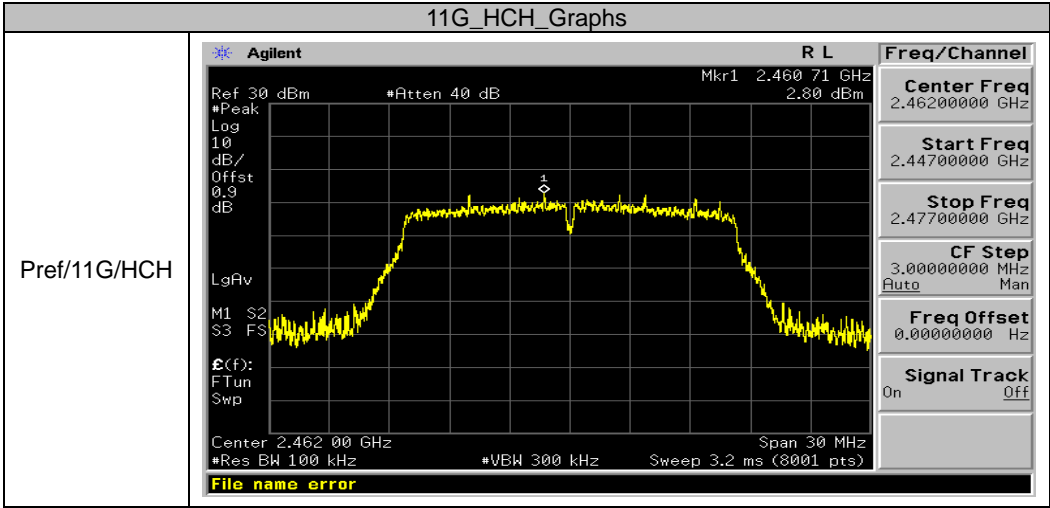
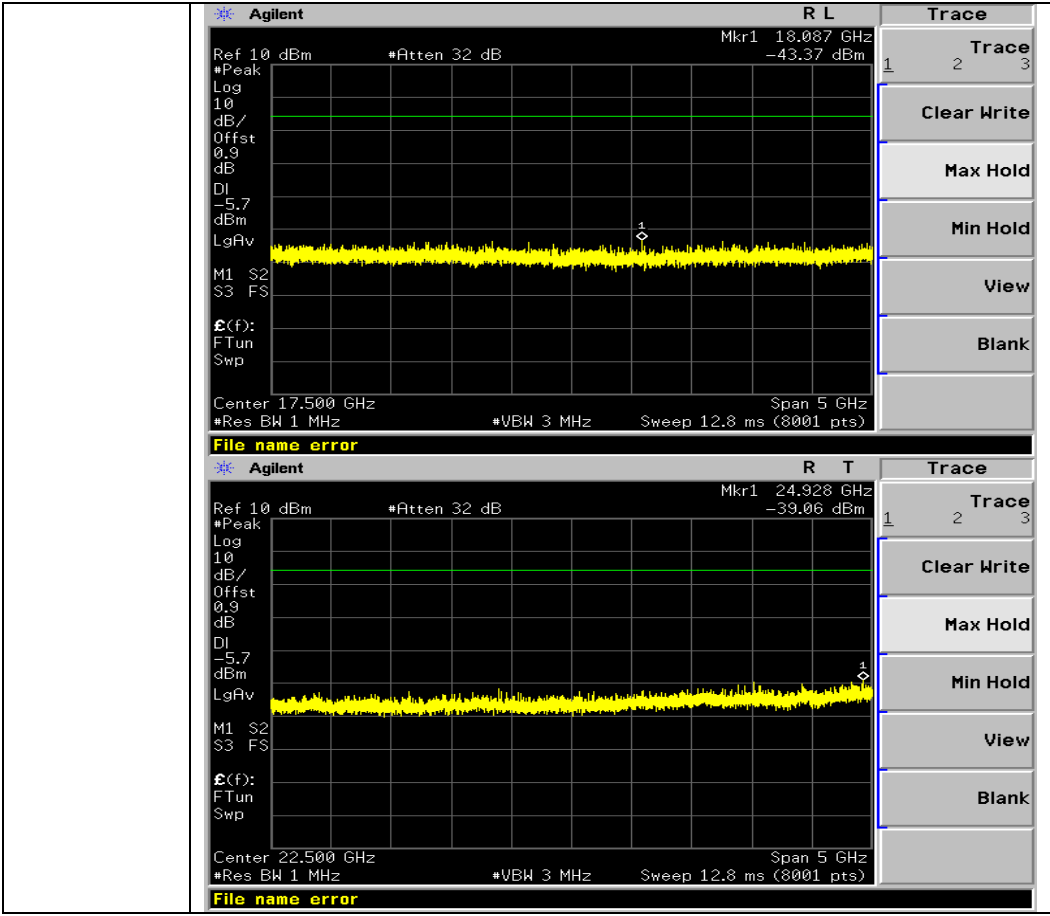

Pref/11G/HCH

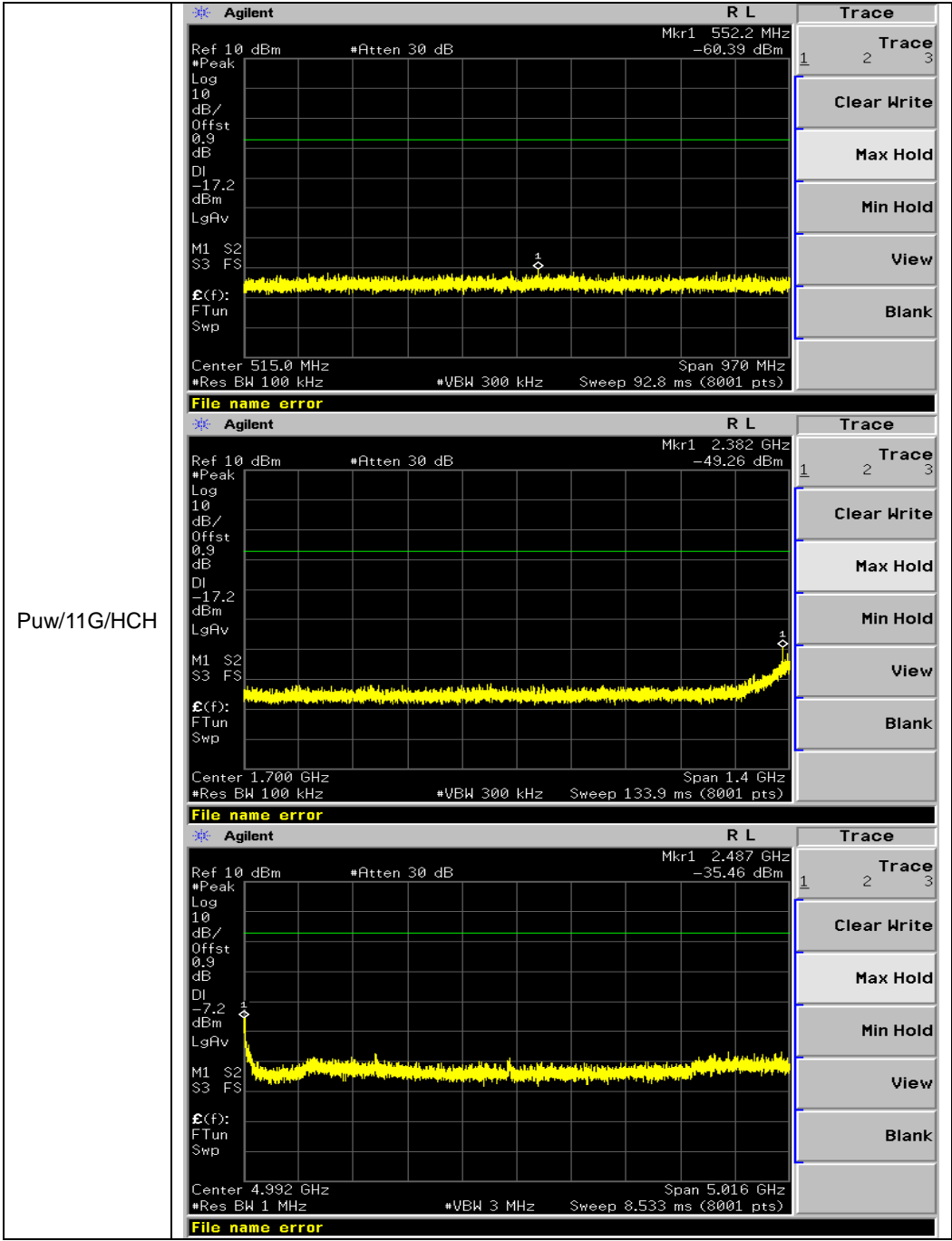



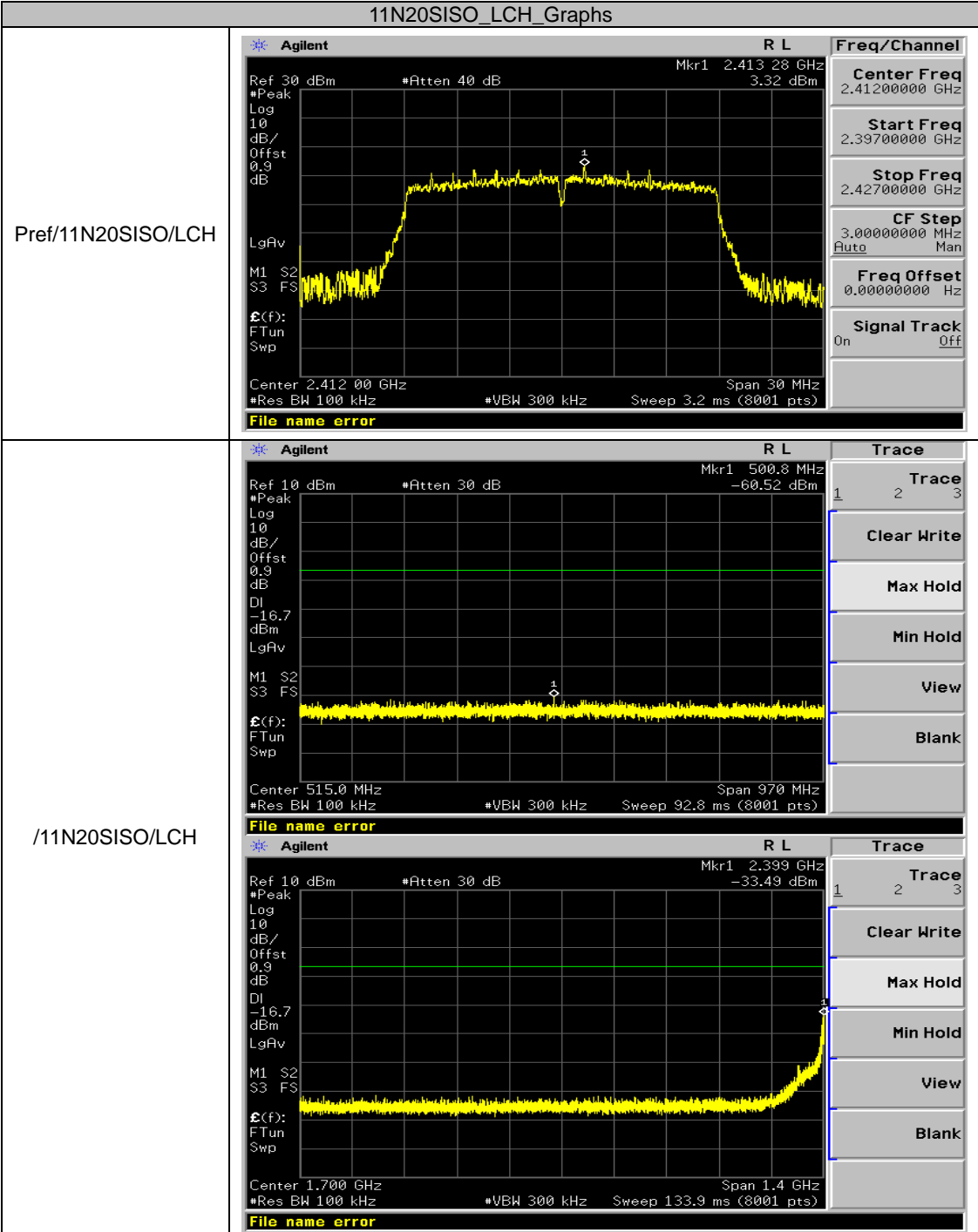



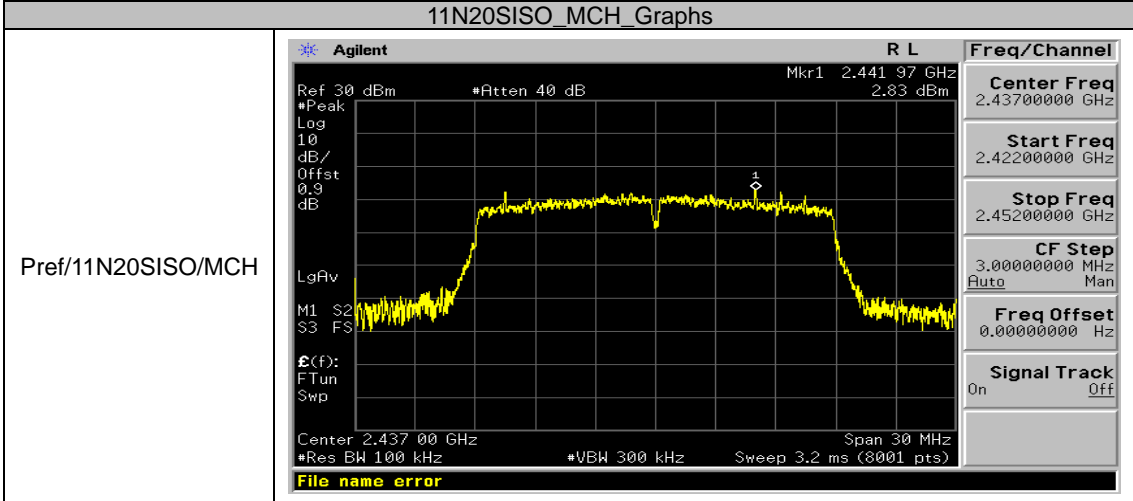
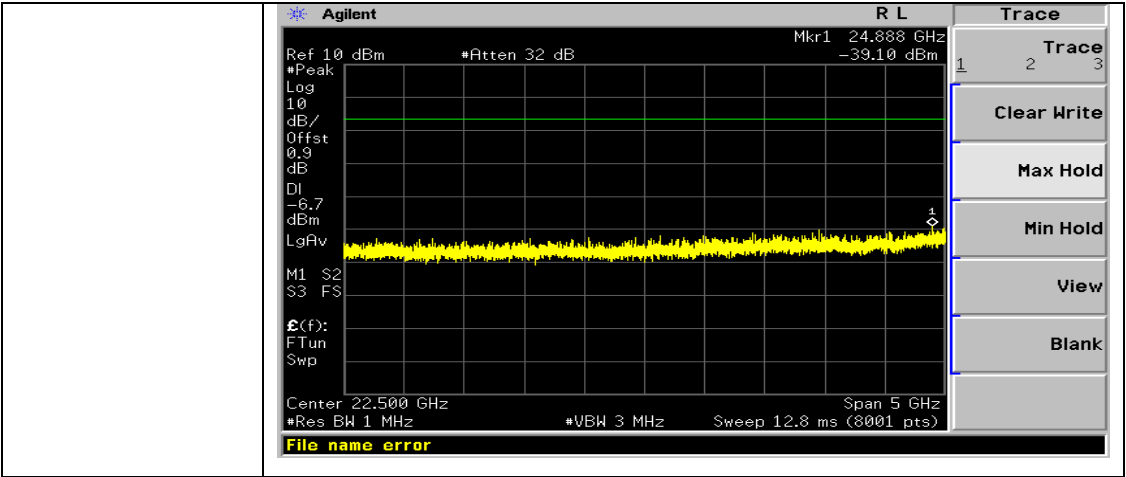

Pref/11N20SISO/MCH

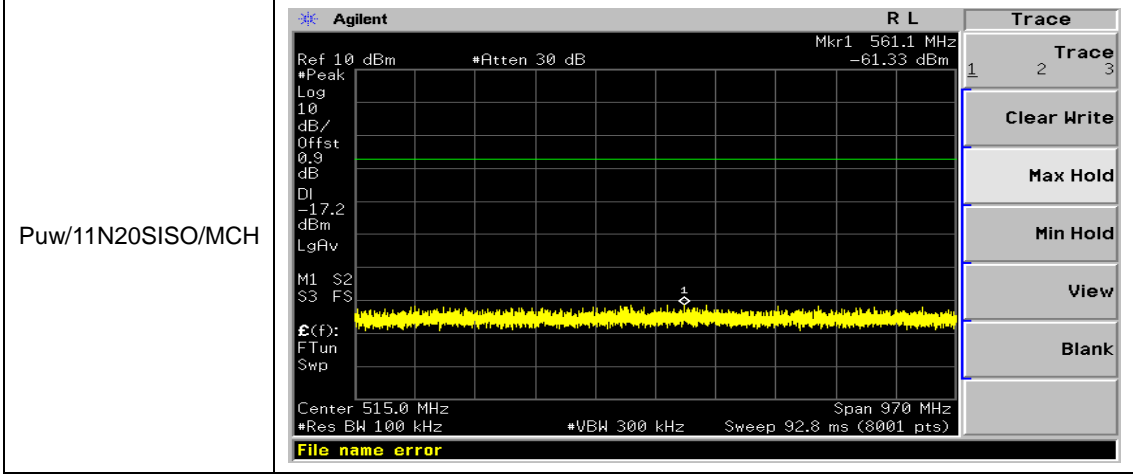

Puw/11N20SISO/MCH

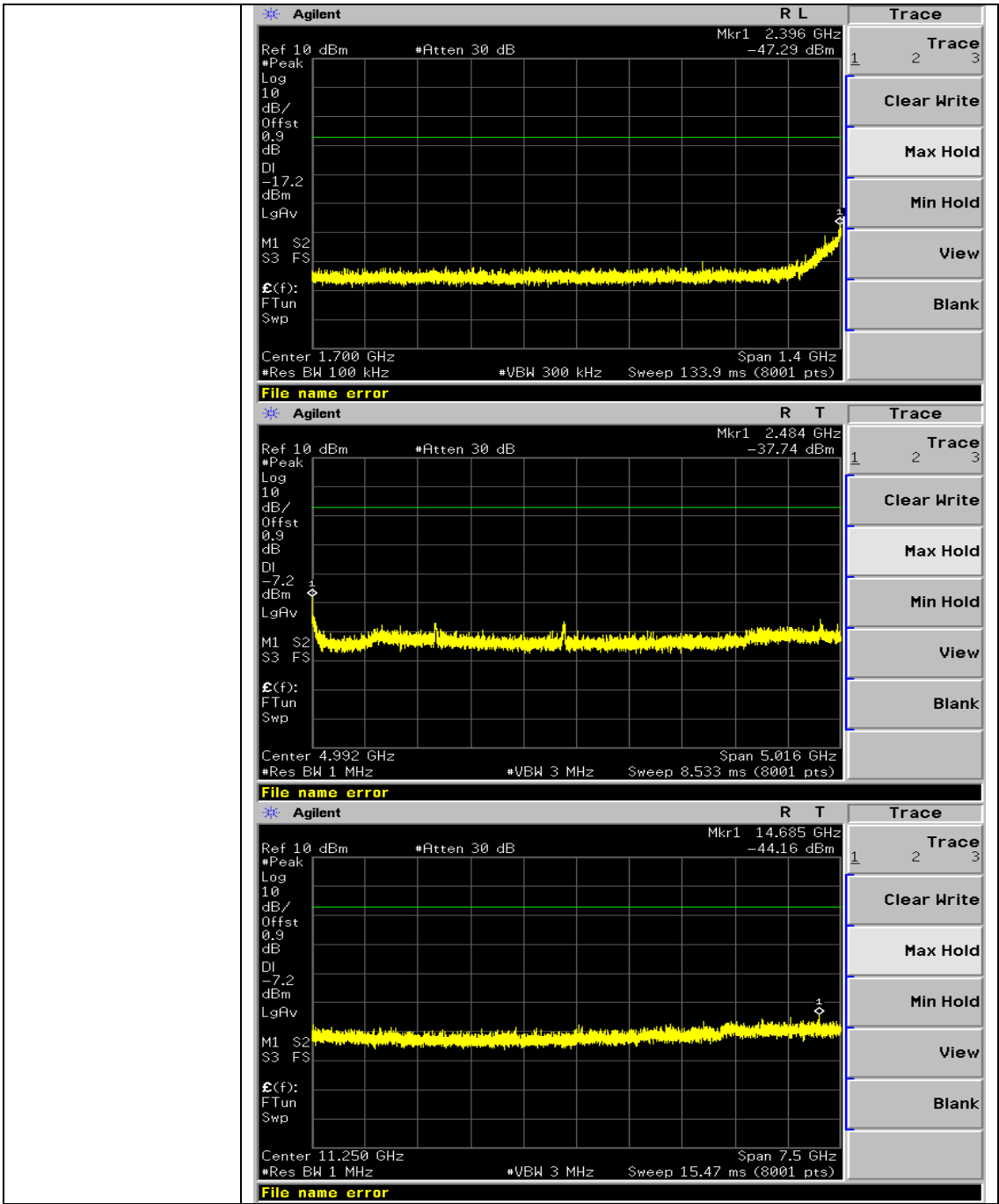

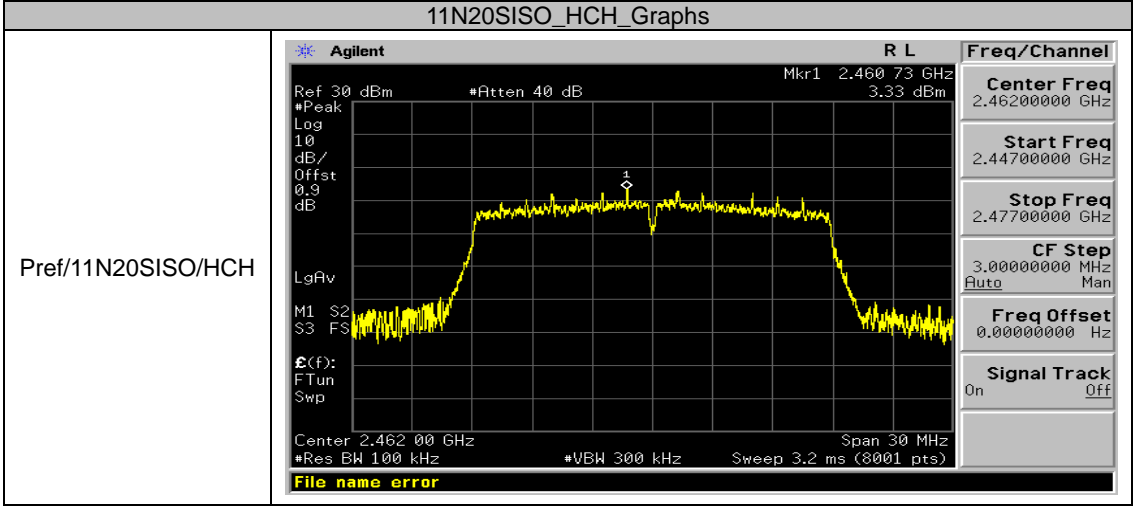
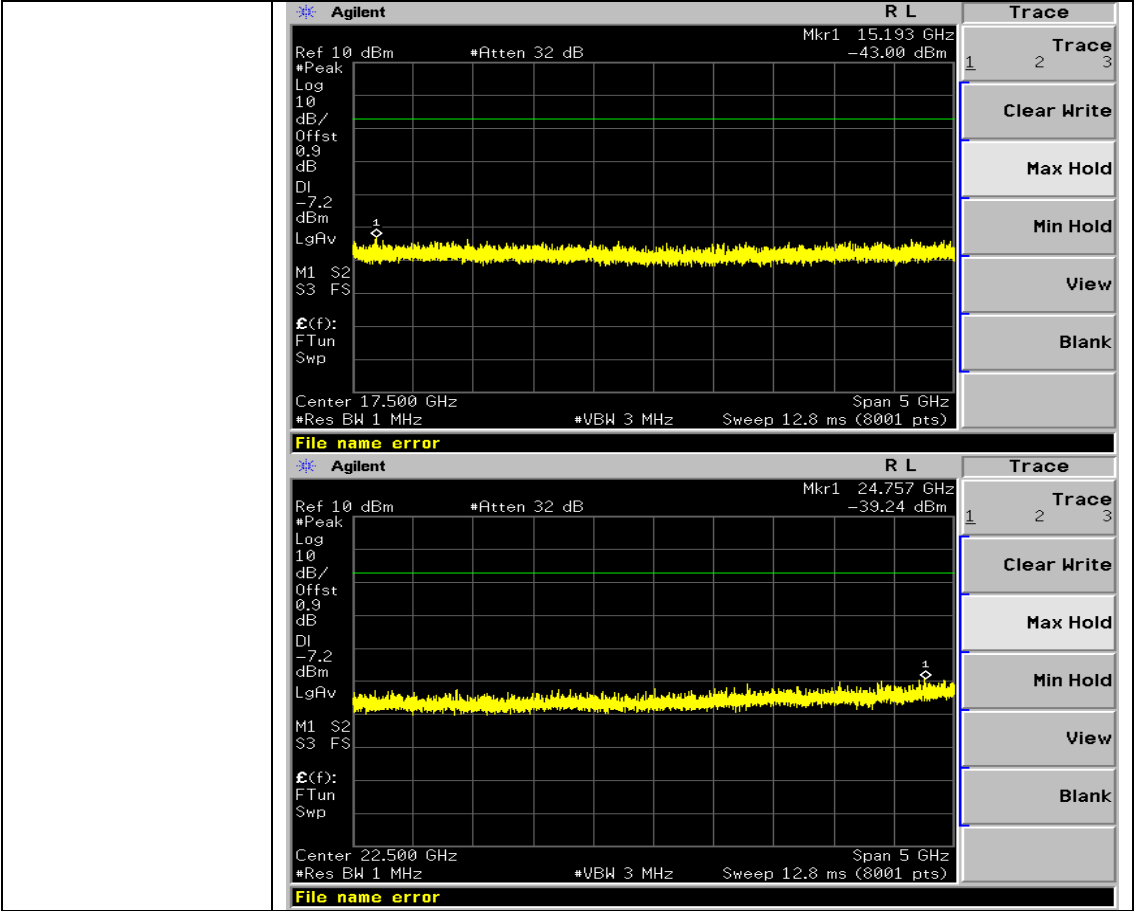

Puw/11N20SISO/HCH

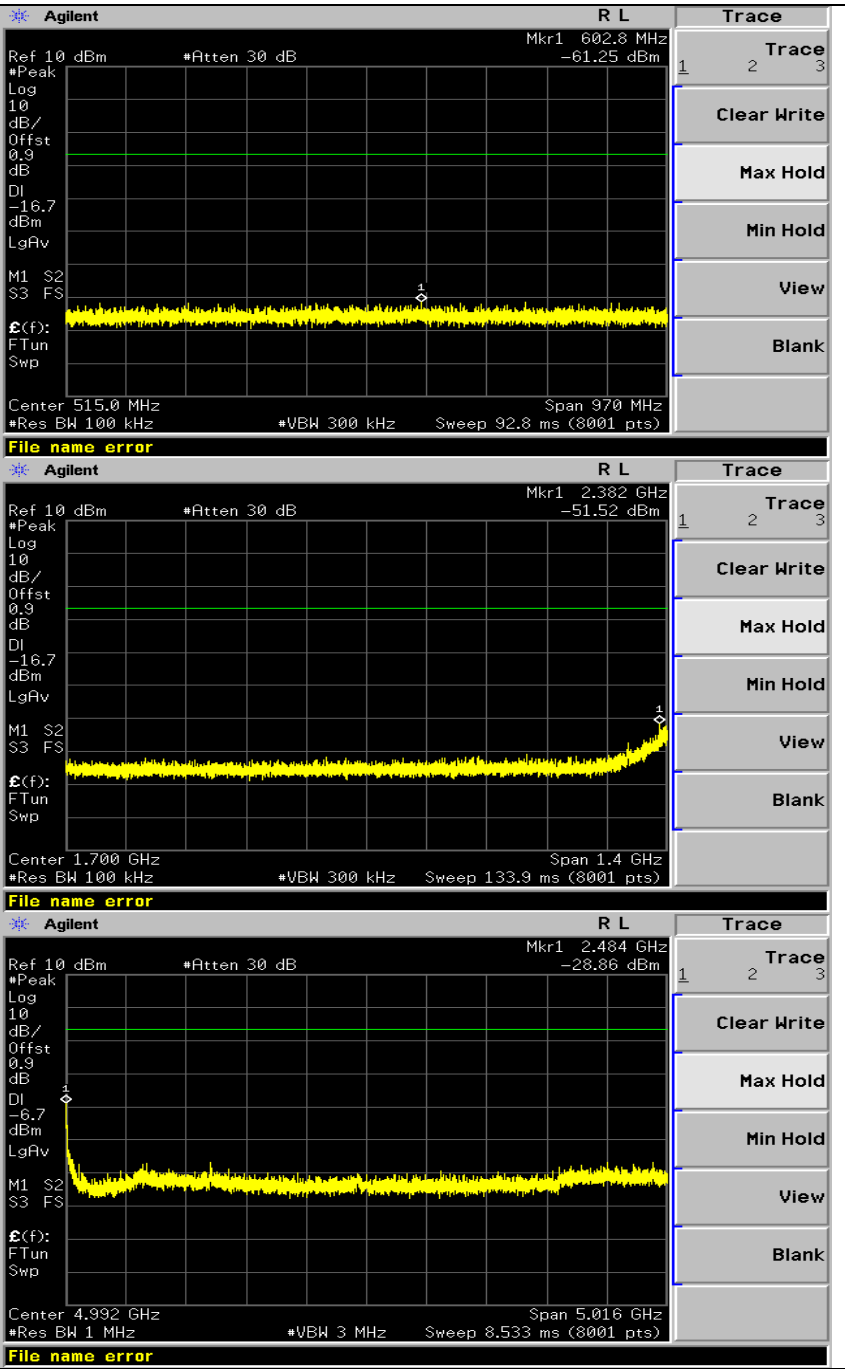

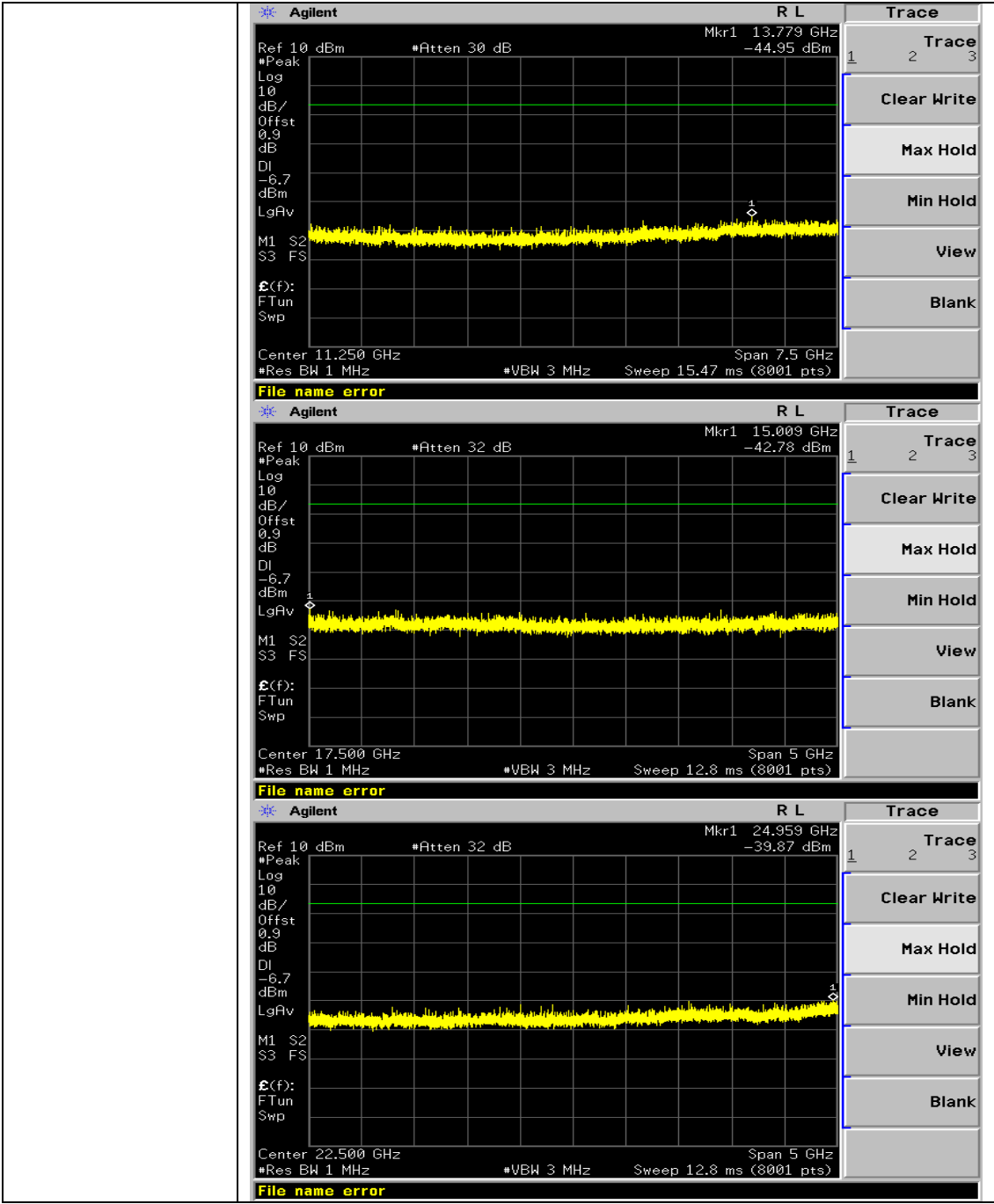

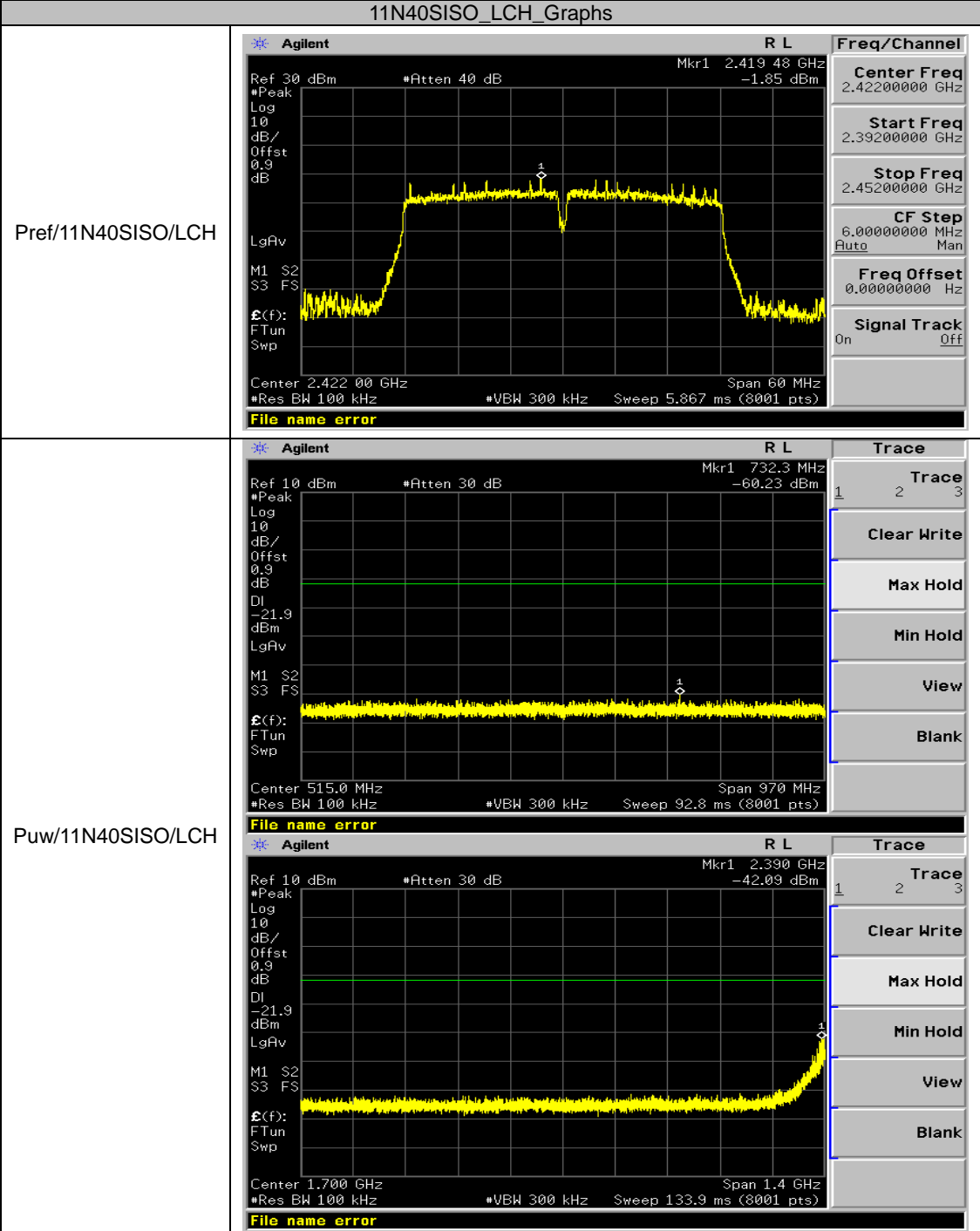

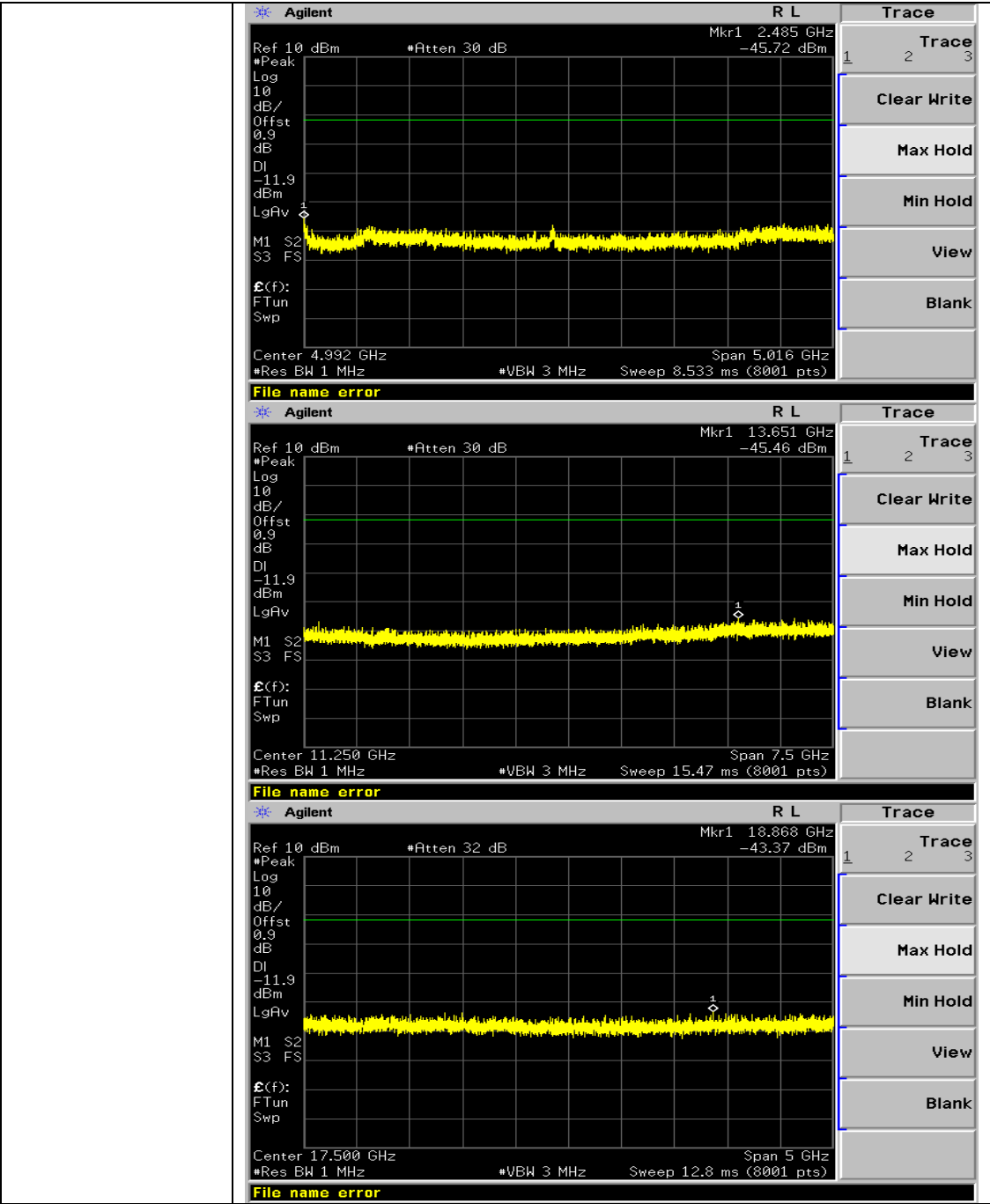

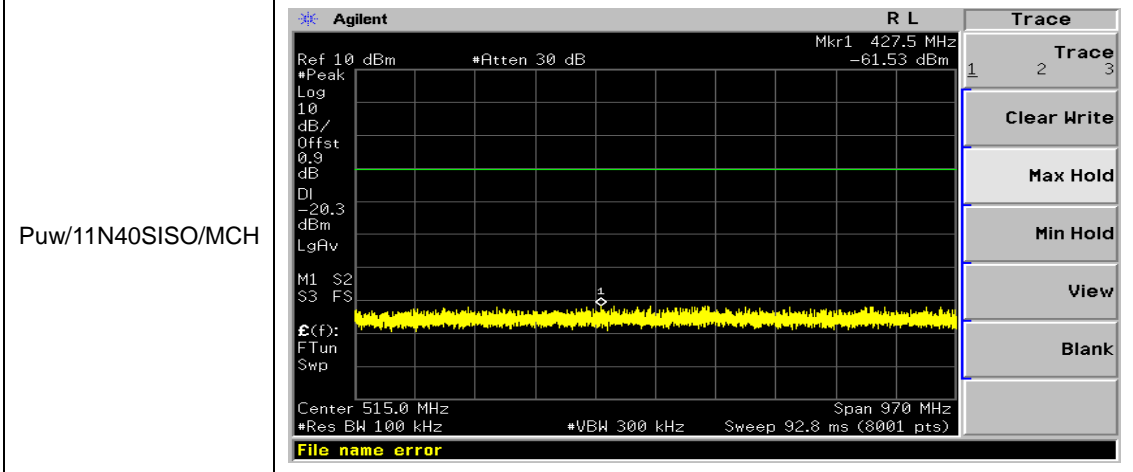
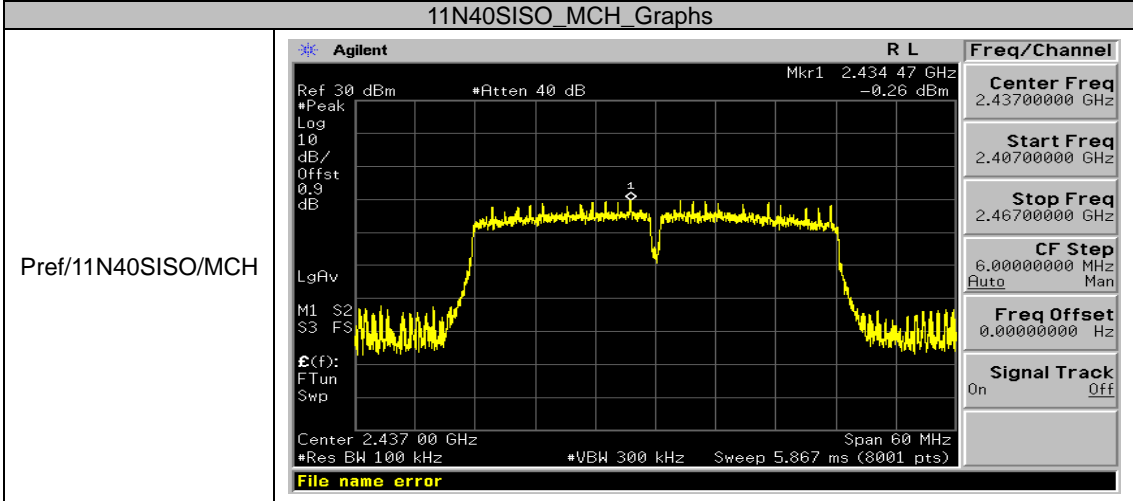
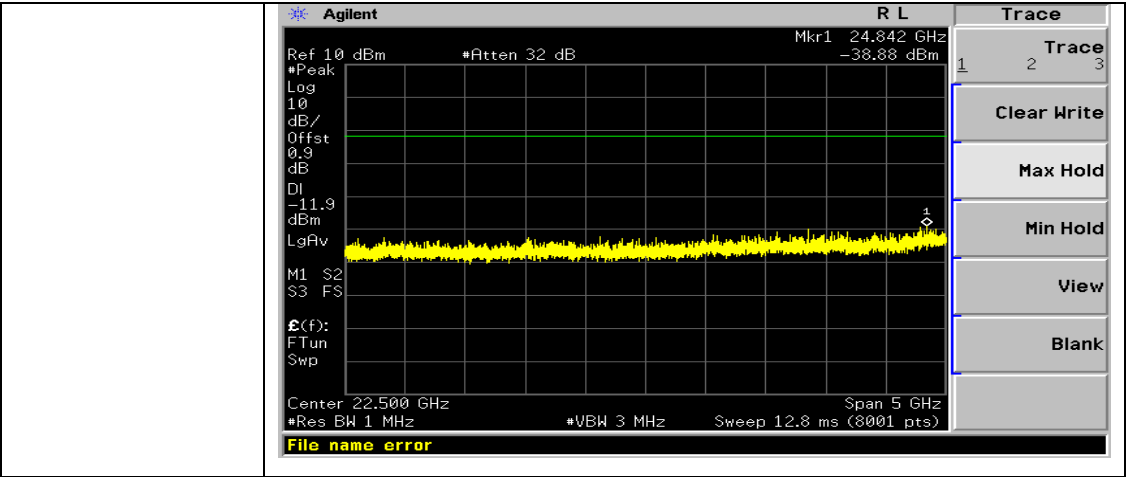

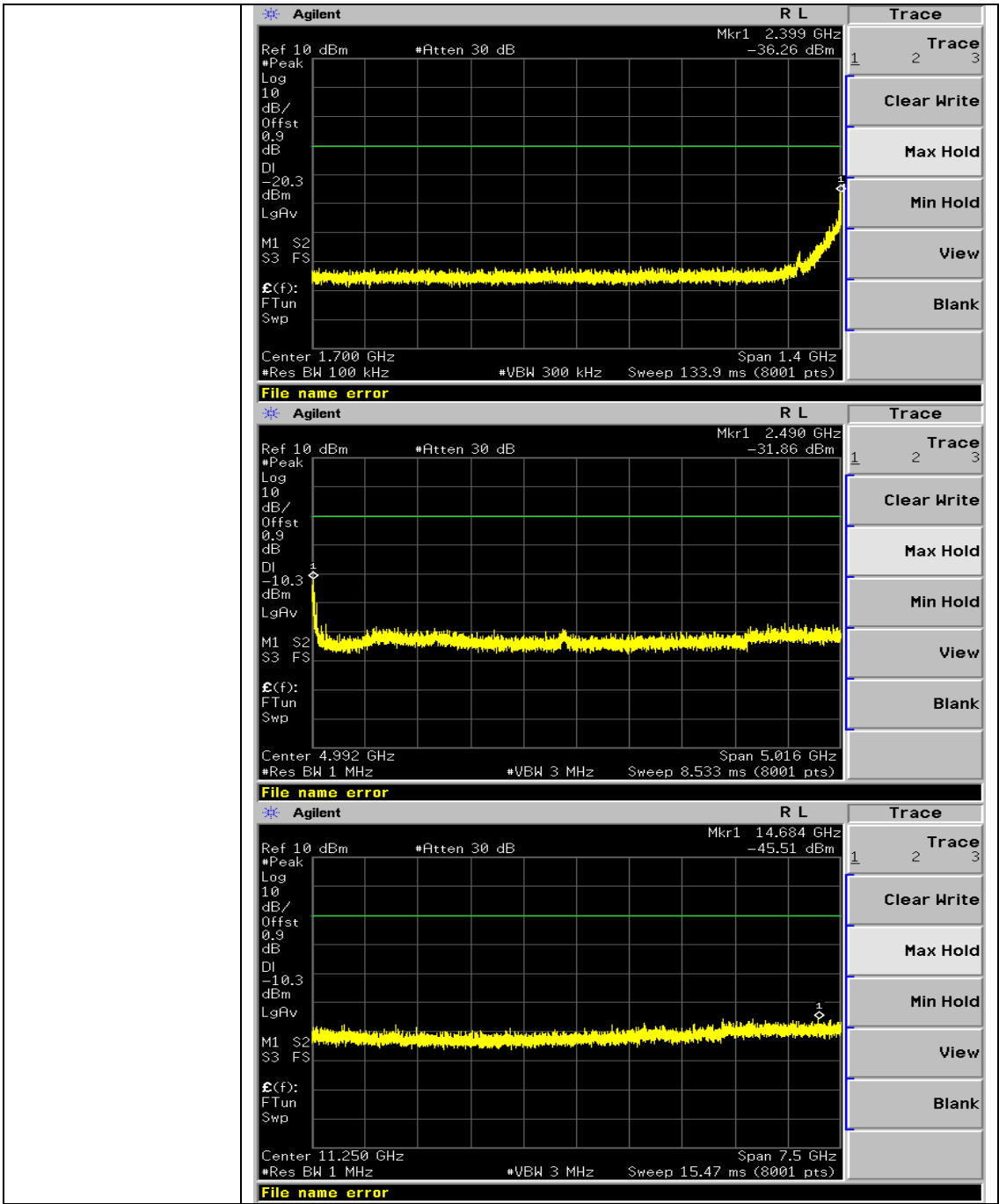

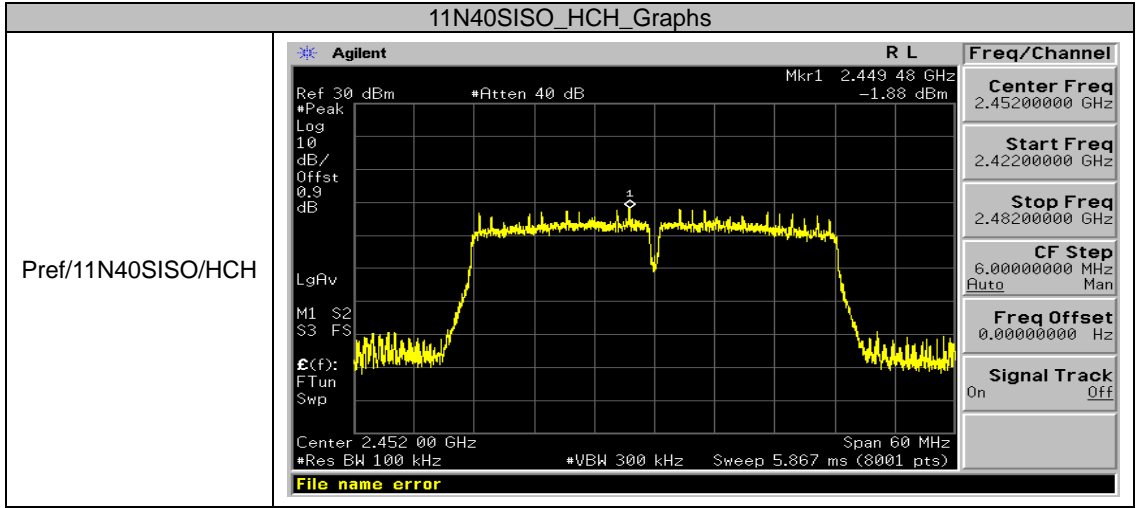
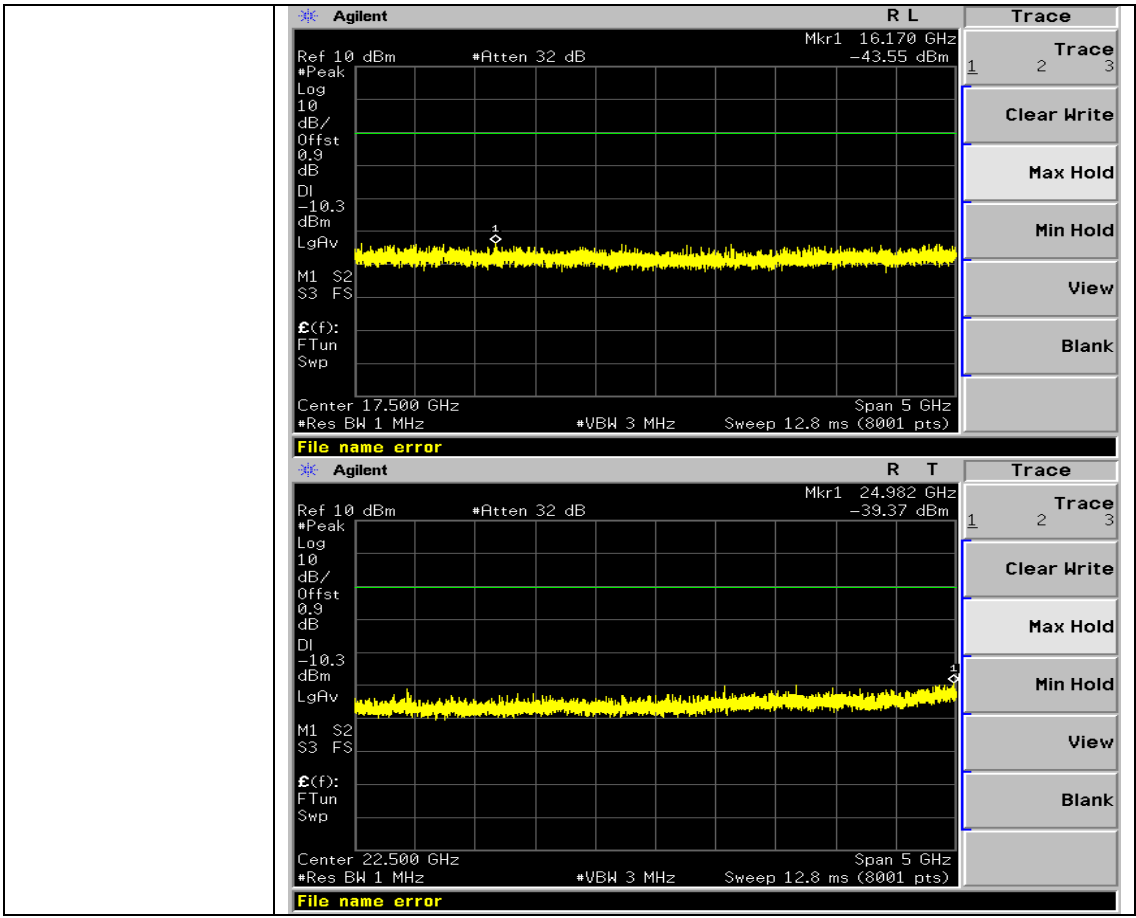

Puw/11N40SISO/HCH

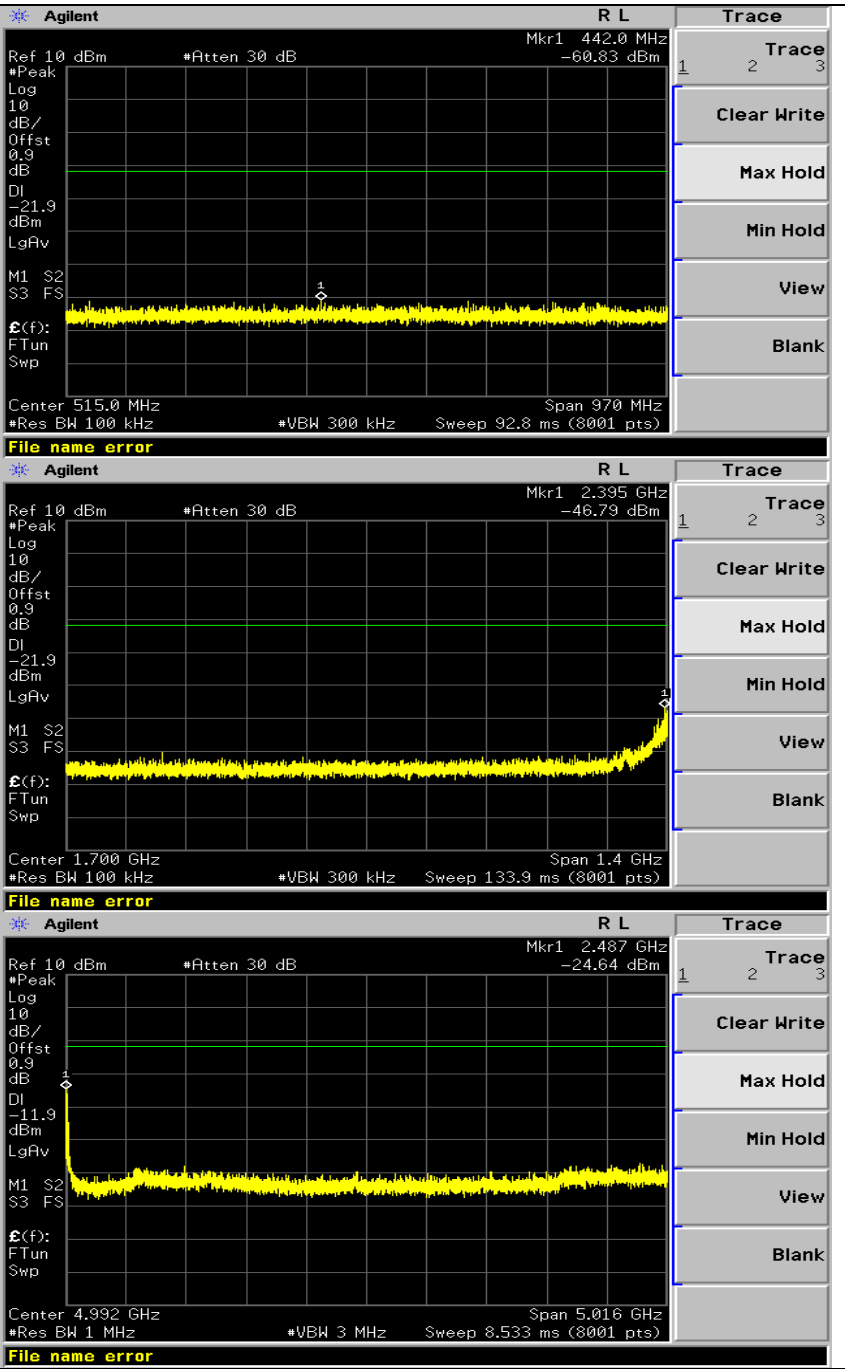

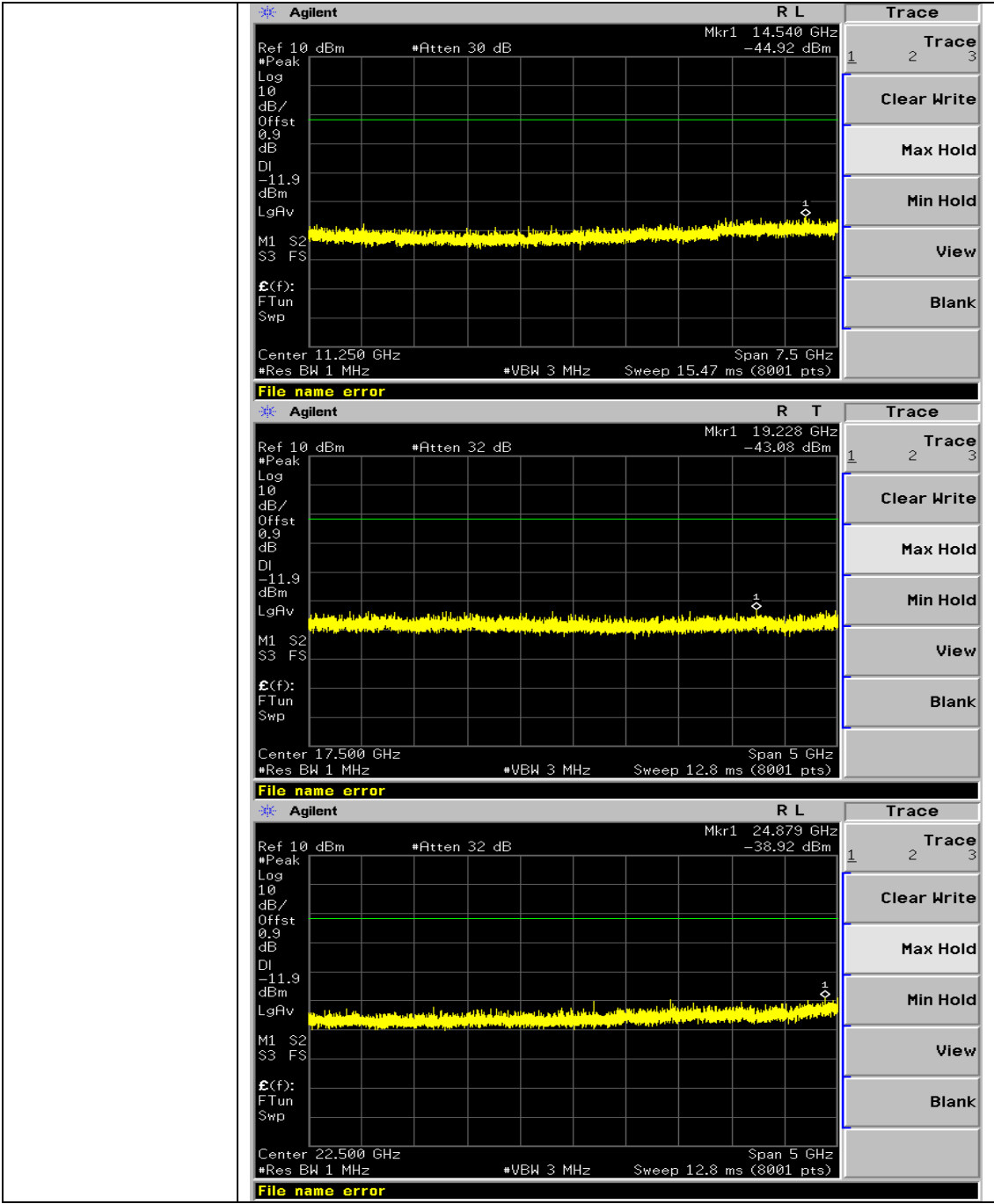

10. MAXIMUM CONDUCTED OUTPUT POWER SPECTRAL DENSITY

10.1 MEASUREMENT PROCEDURE

- (1). Connect EUT RF output port to the Spectrum Analyzer through an RF attenuator
- (2). Set the EUT Work on the top, the middle and the bottom operation frequency individually.
- (3). Set SPA Trace 1 Max hold, then View.

Note: The method of AVGPSD in the KDB 558074 item 10.3 was used in this testing.

10.2 TEST SET-UP (BLOCK DIAGRAM OF CONFIGURATION)

Refer To Section 8.2.

10.3 MEASUREMENT EQUIPMENT USED

Refer To Section 6.

10.4 LIMITS AND MEASUREMENT RESULT

Mode	Channel	Av.PSD [dBm/20kHz]	Limit[dBm/3kHz]	Verdict
11B	LCH	-3.17	8	PASS
11B	MCH	-3.33	8	PASS
11B	HCH	-3.8	8	PASS
11G	LCH	-8.85	8	PASS
11G	MCH	-7.52	8	PASS
11G	HCH	-9.5	8	PASS
11N20SISO	LCH	-9.59	8	PASS
11N20SISO	MCH	-7.78	8	PASS
11N20SISO	HCH	-9.3	8	PASS
11N40SISO	LCH	-15.78	8	PASS
11N40SISO	MCH	-13.59	8	PASS
11N40SISO	HCH	-15.93	8	PASS

Test Graph

Graphs	
<p>11B/LCH</p>	<p>Agilent R L</p> <p>Ref 30 dBm #Atten 40 dB Mkr1 2.409 35 GHz -3.17 dBm</p> <p>#Avg Log 10 dB/ Offst 0.9 dB</p> <p>PAvg</p> <p>M1 S2 S3 FS</p> <p>Ⓕ(f): FTun Swp</p> <p>Center 2.412 00 GHz Span 30 MHz #Res BW 10 kHz #VBW 30 kHz Sweep 906.7 ms (3001 pts)</p> <p>File name error</p> <p>Freq/Channel</p> <p>Center Freq 2.41200000 GHz</p> <p>Start Freq 2.39700000 GHz</p> <p>Stop Freq 2.42700000 GHz</p> <p>CF Step 3.00000000 MHz Auto Man</p> <p>Freq Offset 0.00000000 Hz</p> <p>Signal Track On Off</p>
<p>11B/MCH</p>	<p>Agilent R L</p> <p>Ref 30 dBm #Atten 40 dB Mkr1 2.436 18 GHz -3.33 dBm</p> <p>#Avg Log 10 dB/ Offst 0.9 dB</p> <p>PAvg</p> <p>M1 S2 S3 FS</p> <p>Ⓕ(f): FTun Swp</p> <p>Center 2.437 00 GHz Span 30 MHz #Res BW 10 kHz #VBW 30 kHz Sweep 906.7 ms (3001 pts)</p> <p>File name error</p> <p>Freq/Channel</p> <p>Center Freq 2.43700000 GHz</p> <p>Start Freq 2.42200000 GHz</p> <p>Stop Freq 2.45200000 GHz</p> <p>CF Step 3.00000000 MHz Auto Man</p> <p>Freq Offset 0.00000000 Hz</p> <p>Signal Track On Off</p>
<p>11B/HCH</p>	<p>Agilent R L</p> <p>Ref 30 dBm #Atten 40 dB Mkr1 2.461 38 GHz -3.80 dBm</p> <p>#Avg Log 10 dB/ Offst 0.9 dB</p> <p>PAvg</p> <p>M1 S2 S3 FS</p> <p>Ⓕ(f): FTun Swp</p> <p>Center 2.462 00 GHz Span 30 MHz #Res BW 10 kHz #VBW 30 kHz Sweep 906.7 ms (3001 pts)</p> <p>File name error</p> <p>Freq/Channel</p> <p>Center Freq 2.46200000 GHz</p> <p>Start Freq 2.44700000 GHz</p> <p>Stop Freq 2.47700000 GHz</p> <p>CF Step 3.00000000 MHz Auto Man</p> <p>Freq Offset 0.00000000 Hz</p> <p>Signal Track On Off</p>

<p>11G/LCH</p>	<p>Agilent R L</p> <p>Ref 30 dBm #Atten 40 dB Mkr1 2.415 75 GHz -8.85 dBm</p> <p>#Aveg Log 10 dB/Offst 0.9 dB</p> <p>PFAvg M1 S2 S3 FS</p> <p>Ⓕ(f): FTun Swp</p> <p>Center 2.412 00 GHz Span 30 MHz #Res BW 10 kHz #VBW 30 kHz Sweep 906.7 ms (3001 pts)</p> <p>File name error</p> <p>Freq/Channel</p> <p>Center Freq 2.41200000 GHz</p> <p>Start Freq 2.39700000 GHz</p> <p>Stop Freq 2.42700000 GHz</p> <p>CF Step 3.00000000 MHz Auto Man</p> <p>Freq Offset 0.00000000 Hz</p> <p>Signal Track On Off</p>
<p>11G/MCH</p>	<p>Agilent R L</p> <p>Ref 30 dBm #Atten 40 dB Mkr1 2.440 10 GHz -7.52 dBm</p> <p>#Aveg Log 10 dB/Offst 0.9 dB</p> <p>PFAvg M1 S2 S3 FS</p> <p>Ⓕ(f): FTun Swp</p> <p>Center 2.437 00 GHz Span 30 MHz #Res BW 10 kHz #VBW 30 kHz Sweep 906.7 ms (3001 pts)</p> <p>File name error</p> <p>Freq/Channel</p> <p>Center Freq 2.43700000 GHz</p> <p>Start Freq 2.42200000 GHz</p> <p>Stop Freq 2.45200000 GHz</p> <p>CF Step 3.00000000 MHz Auto Man</p> <p>Freq Offset 0.00000000 Hz</p> <p>Signal Track On Off</p>
<p>11G/HCH</p>	<p>Agilent R L</p> <p>Ref 30 dBm #Atten 40 dB Mkr1 2.460 42 GHz -9.50 dBm</p> <p>#Aveg Log 10 dB/Offst 0.9 dB</p> <p>PFAvg M1 S2 S3 FS</p> <p>Ⓕ(f): FTun Swp</p> <p>Center 2.462 00 GHz Span 30 MHz #Res BW 10 kHz #VBW 30 kHz Sweep 906.7 ms (3001 pts)</p> <p>File name error</p> <p>Freq/Channel</p> <p>Center Freq 2.46200000 GHz</p> <p>Start Freq 2.44700000 GHz</p> <p>Stop Freq 2.47700000 GHz</p> <p>CF Step 3.00000000 MHz Auto Man</p> <p>Freq Offset 0.00000000 Hz</p> <p>Signal Track On Off</p>

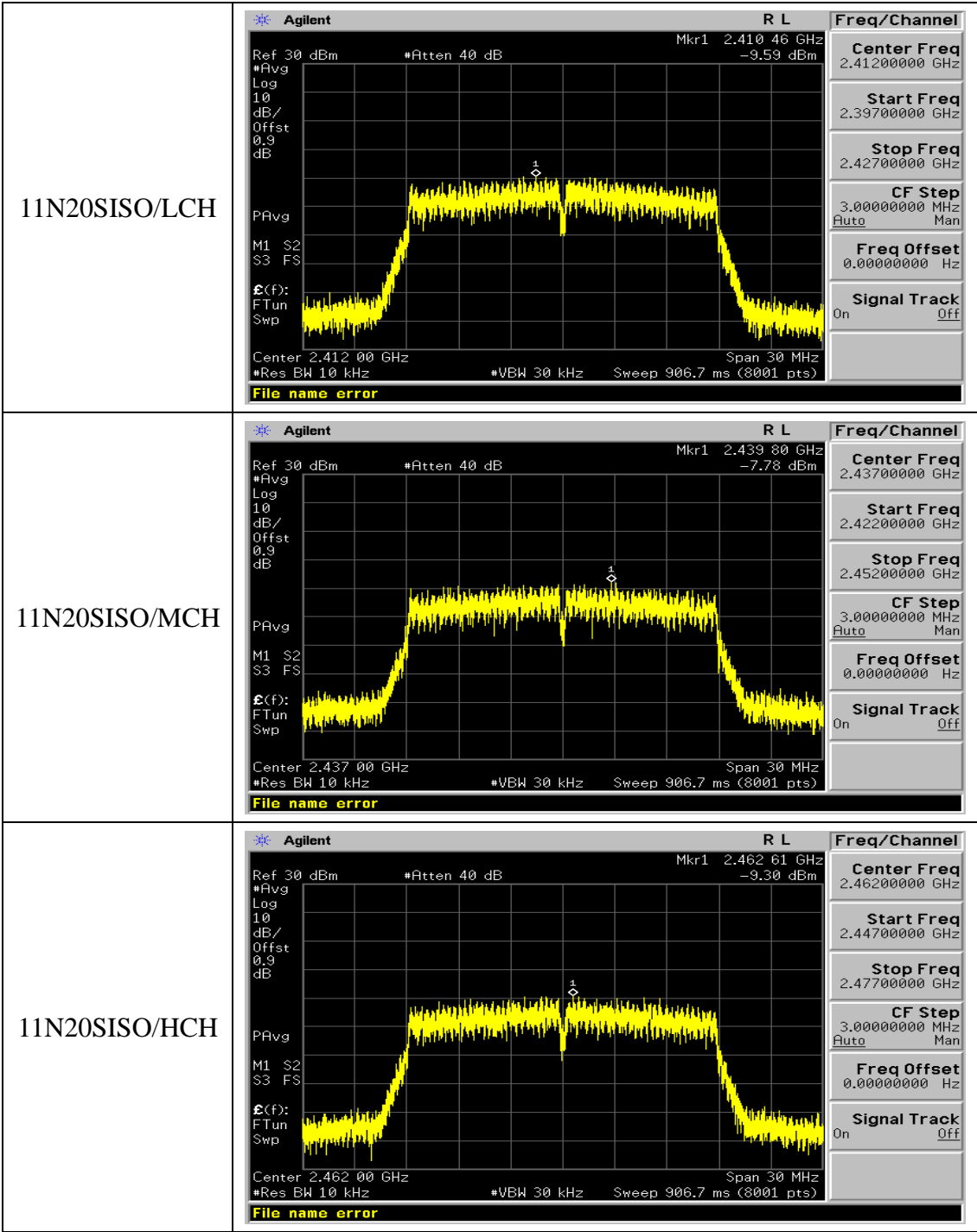

<p>11N40SISO/LCH</p>	<p>Agilent R L</p> <p>Ref 30 dBm #Atten 40 dB Mkr1 2.413 22 GHz -15.78 dBm</p> <p>#AVg Log 10 dB/ Offst 0.9 dB</p> <p>PAvg</p> <p>M1 S2 S3 FS</p> <p>Ⓕ(f): FTun Swp</p> <p>Center 2.422 00 GHz Span 60 MHz #Res BW 10 kHz #VBW 30 kHz Sweep 1.813 s (3001 pts)</p> <p>File name error</p> <p>Freq/Channel</p> <p>Center Freq 2.42200000 GHz</p> <p>Start Freq 2.39200000 GHz</p> <p>Stop Freq 2.45200000 GHz</p> <p>CF Step 6.00000000 MHz Auto Man</p> <p>Freq Offset 0.00000000 Hz</p> <p>Signal Track On Off</p>
<p>11N40SISO/MCH</p>	<p>Agilent R L</p> <p>Ref 30 dBm #Atten 40 dB Mkr1 2.431 62 GHz -13.59 dBm</p> <p>#AVg Log 10 dB/ Offst 0.9 dB</p> <p>PAvg</p> <p>M1 S2 S3 FS</p> <p>Ⓕ(f): FTun Swp</p> <p>Center 2.437 00 GHz Span 60 MHz #Res BW 10 kHz #VBW 30 kHz Sweep 1.813 s (3001 pts)</p> <p>File name error</p> <p>Freq/Channel</p> <p>Center Freq 2.43700000 GHz</p> <p>Start Freq 2.40700000 GHz</p> <p>Stop Freq 2.46700000 GHz</p> <p>CF Step 6.00000000 MHz Auto Man</p> <p>Freq Offset 0.00000000 Hz</p> <p>Signal Track On Off</p>
<p>11N40SISO/HCH</p>	<p>Agilent R L</p> <p>Ref 30 dBm #Atten 40 dB Mkr1 2.443 62 GHz -15.93 dBm</p> <p>#AVg Log 10 dB/ Offst 0.9 dB</p> <p>PAvg</p> <p>M1 S2 S3 FS</p> <p>Ⓕ(f): FTun Swp</p> <p>Center 2.452 00 GHz Span 60 MHz #Res BW 10 kHz #VBW 30 kHz Sweep 1.813 s (3001 pts)</p> <p>File name error</p> <p>Freq/Channel</p> <p>Center Freq 2.45200000 GHz</p> <p>Start Freq 2.42200000 GHz</p> <p>Stop Freq 2.48200000 GHz</p> <p>CF Step 6.00000000 MHz Auto Man</p> <p>Freq Offset 0.00000000 Hz</p> <p>Signal Track On Off</p>

11. RADIATED EMISSION

11.1. MEASUREMENT PROCEDURE

1. Configure the EUT according to ANSI C63.4. The EUT was placed on the top of the turntable 0.8 meter above ground. The phase center of the receiving antenna mounted on the top of a height-variable antenna tower was placed 3 meters far away from the turntable.
2. Power on the EUT and all the supporting units. The turntable was rotated by 360 degrees to determine the position of the highest radiation.
3. The height of the broadband receiving antenna was varied between one meter and four meters above ground to find the maximum emissions field strength of both horizontal and vertical polarization.
4. For each suspected emissions, the antenna tower was scan (from 1 M to 4 M) and then the turntable was rotated (from 0 degree to 360 degrees) to find the maximum reading.
5. Set the test-receiver system to Peak or CISPR quasi-peak Detect Function with specified bandwidth under Maximum Hold Mode.
6. For emissions above 1GHz, use 1MHz VBW and RBW for peak reading. Then 1MHz RBW and 10Hz VBW for average reading in spectrum analyzer.
7. When the radiated emissions limits are expressed in terms of the average value of the emissions, and pulsed operation is employed, the measurement field strength shall be determined by averaging over one complete pulse train, including blanking intervals, as long as the pulse train does not exceed 0.1 seconds. As an alternative (provided the transmitter operates for longer than 0.1 seconds) or in cases where the pulse train exceeds 0.1 seconds, the measured field strength shall be determined from the average absolute voltage during a 0.1 second interval during which the field strength is at its maximum values.
8. If the emissions level of the EUT in peak mode was 3 dB lower than the average limit specified, then testing will be stopped and peak values of EUT will be reported, otherwise, the emissions which do not have 3 dB margin will be repeated one by one using the quasi-peak method for below 1GHz.
9. For testing above 1GHz, the emissions level of the EUT in peak mode was lower than average limit (that means the emissions level in peak mode also complies with the limit in average mode), then testing will be stopped and peak values of EUT will be reported, otherwise, the emissions will be measured in average mode again and reported.
10. In case the emission is lower than 30MHz, loop antenna has to be used for measurement and the recorded data should be QP measured by receiver. High - Low scan is not required in this case.

11.2. TEST SETUP

RADIATED EMISSION TEST SETUP 30MHz-1000MHz

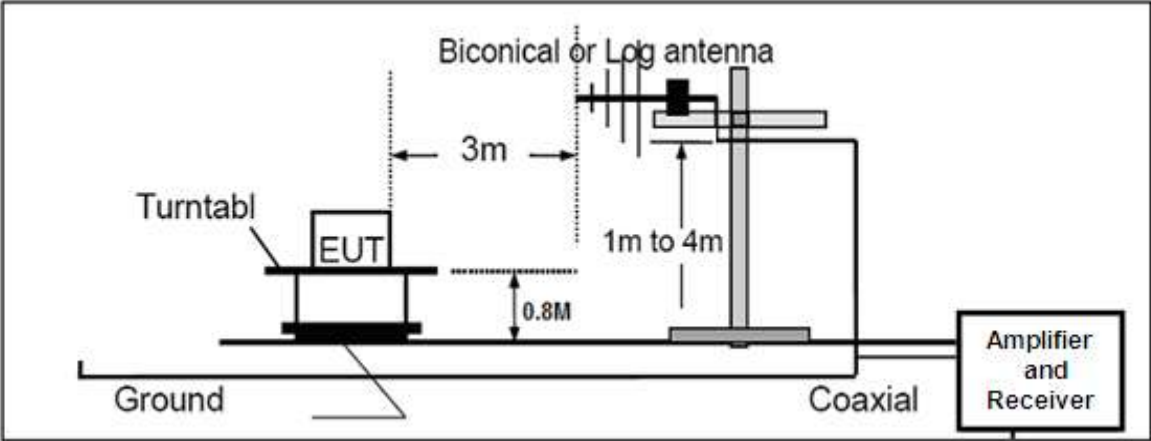

RADIATED EMISSION TEST SETUP ABOVE 1000MHz

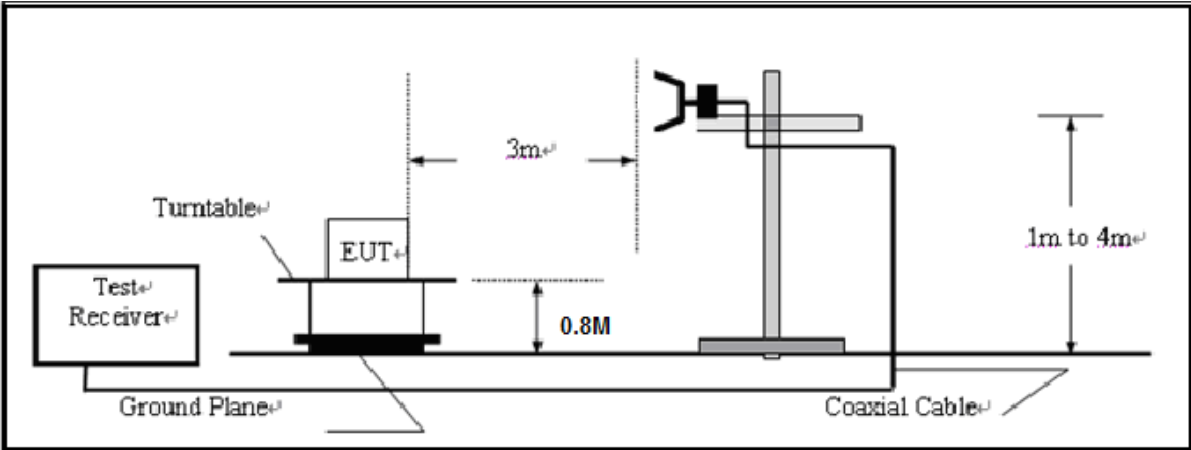

11.3. LIMITS AND MEASUREMENT RESULT

15.209(a) Limit in the below table has to be followed

Frequencies (MHz)	Field Strength (micorvolts/meter)	Measurement Distance (meters)
0.009~0.490	2400/F(KHz)	300
0.490~1.705	24000/F(KHz)	30
1.705~30.0	30	30
30~88	100	3
88~216	150	3
216~960	200	3
Above 960	500	3

Note: All modes were tested For restricted band radiated emission,
the test records reported below are the worst result compared to other modes.

11.4. TEST RESULT

RADIATED EMISSION BELOW 30MHZ

No emission found between lowest internal used/generated frequencies to 30MHz.

RADIATED EMISSION BELOW 1GHZ

EUT	MOBILE PHONE	Model Name	Q6
Temperature	25°C	Relative Humidity	55.4%
Pressure	960hPa	Test Voltage	Normal Voltage
Test Mode	802.11b with data rate 1 2412MHZ	Antenna	Horizontal

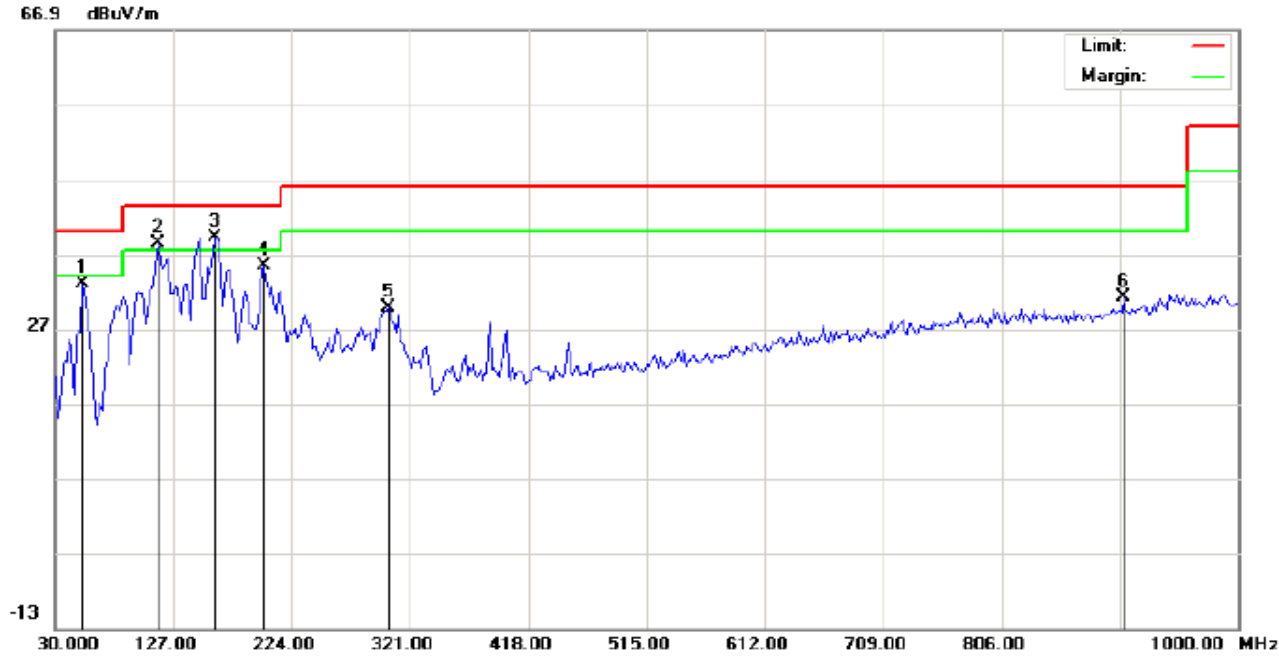

Site: site #1	Polarization: <i>Horizontal</i>	Temperature: 23.3
Limit: FCC Class B 3M Radiation	Power: AC 120V/60Hz	Humidity: 56.9 %
EUT: MOBILE PHONE	Distance:	
M/N: Q6		
Mode: Low channel TX		
Note:		

No.	Mk	Freq.	Reading	Factor	Measurement	Limit	Over	Detector	Antenna Height	Table Degree	Comment
		MHz	dBuV	dB/m	dBuV/m	dBuV/m	dB		cm	degree	
1		52.6333	18.17	14.82	32.99	40.00	-7.01	peak			
2	!	114.0667	24.89	13.47	38.36	43.50	-5.14	peak			
3	*	160.9500	22.21	17.03	39.24	43.50	-4.26	peak			
4		201.3667	22.16	13.24	35.40	43.50	-8.10	peak			
5		303.2167	13.48	16.31	29.79	46.00	-16.21	peak			
6		906.2333	2.90	28.40	31.30	46.00	-14.70	peak			

RESULT: PASS

EUT	MOBILE PHONE	Model Name	Q6
Temperature	25°C	Relative Humidity	55.4%
Pressure	960hPa	Test Voltage	Normal Voltage
Test Mode	802.11b with data rate 1 2412MHZ	Antenna	Vertical

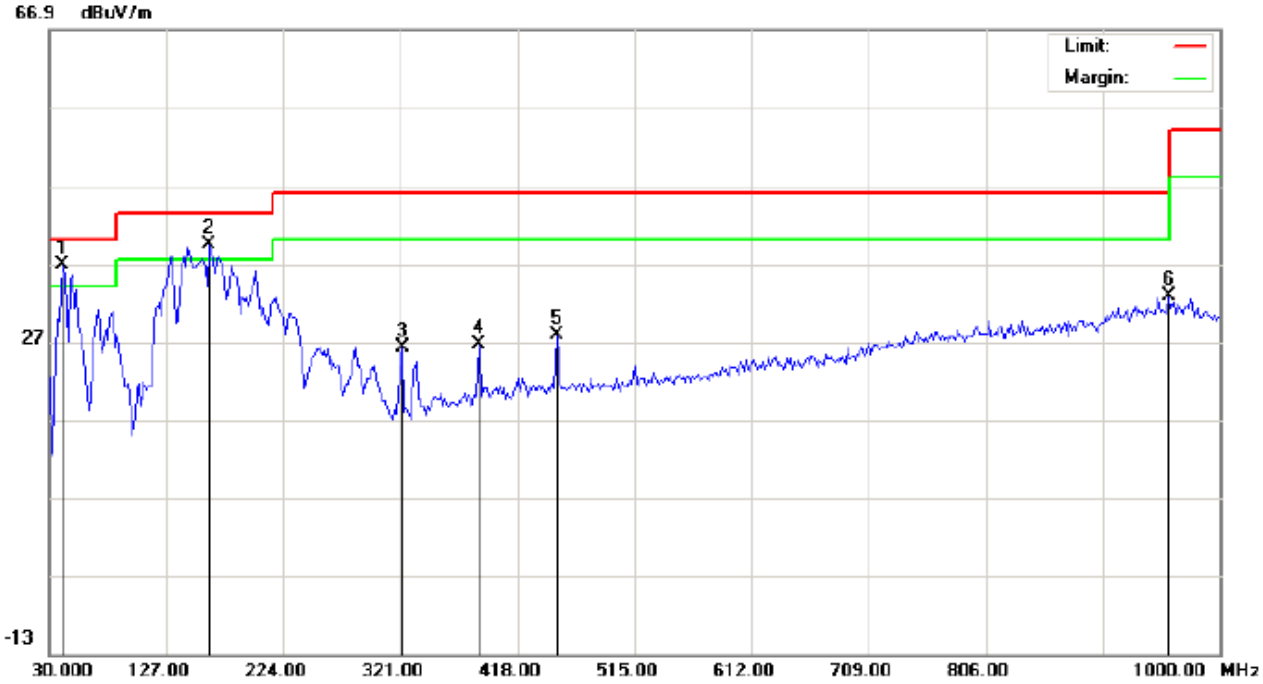

Site: site #1
 Limit: FCC Class B 3M Radiation
 EUT: MOBILE PHONE
 M/N: Q6
 Mode: Low channel TX
 Note:

Polarization: **Vertical**
 Power: AC 120V/60Hz
 Distance:

Temperature: 23.3
 Humidity: 56.9 %

No.	Mk	Freq.	Reading	Factor	Measurement	Limit	Over	Detector	Antenna Height	Table Degree	Comment
		MHz	dBuV	dB/m	dBuV/m	dBuV/m	dB		cm	degree	
1	*	41.3167	27.93	8.81	36.74	40.00	-3.26	peak			
2	!	162.5667	24.26	15.17	39.43	43.50	-4.07	peak			
3		322.6167	9.19	16.92	26.11	46.00	-19.89	peak			
4		385.6667	7.53	18.98	26.51	46.00	-19.49	peak			
5		450.3333	7.27	20.59	27.86	46.00	-18.14	peak			
6		957.9667	2.82	29.92	32.74	46.00	-13.26	peak			

RESULT: PASS

EUT	MOBILE PHONE	Model Name	Q6
Temperature	25°C	Relative Humidity	55.4%
Pressure	960hPa	Test Voltage	Normal Voltage
Test Mode	802.11b with data rate 1 2437MHZ	Antenna	Horizontal

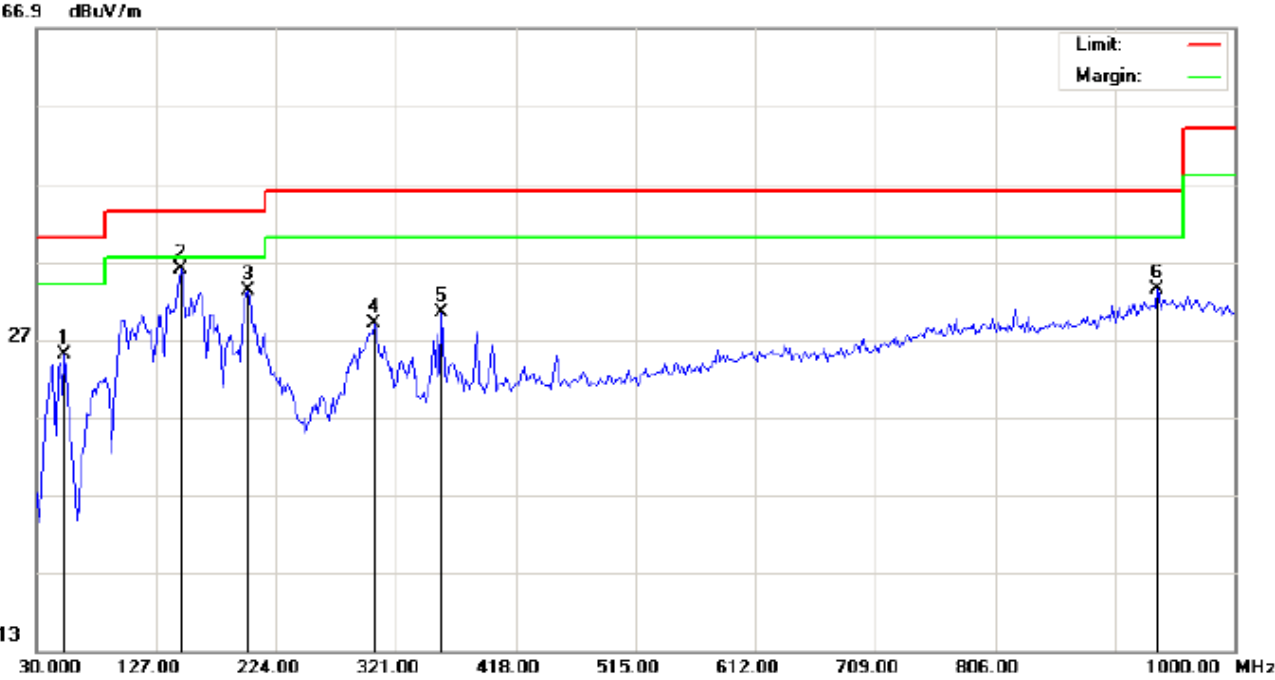

Site: site #1
 Limit: FCC Class B 3M Radiation
 EUT: MOBILE PHONE
 M/N: Q6
 Mode: Middle channel TX
 Note:

Polarization: *Horizontal*
 Power: AC 120V/60Hz
 Distance:

Temperature: 23.3
 Humidity: 56.9 %

No.	Mk	Freq.	Reading	Factor	Measurement	Limit	Over	Detector	Antenna Height	Table Degree	Comment
		MHz	dBuV	dB/m	dBuV/m	dBuV/m	dB		cm	degree	
1		52.6333	16.66	8.41	25.07	40.00	-14.93	peak			
2	*	146.4000	22.34	13.64	35.98	43.50	-7.52	peak			
3		201.3667	21.27	11.86	33.13	43.50	-10.37	peak			
4		303.2167	13.44	15.62	29.06	46.00	-16.94	peak			
5		358.1833	11.52	18.79	30.31	46.00	-15.69	peak			
6		936.9500	3.67	29.64	33.31	46.00	-12.69	peak			

RESULT: PASS

EUT	MOBILE PHONE	Model Name	Q6
Temperature	25°C	Relative Humidity	55.4%
Pressure	960hPa	Test Voltage	Normal Voltage
Test Mode	802.11b with data rate 1 2437MHZ	Antenna	Vertical

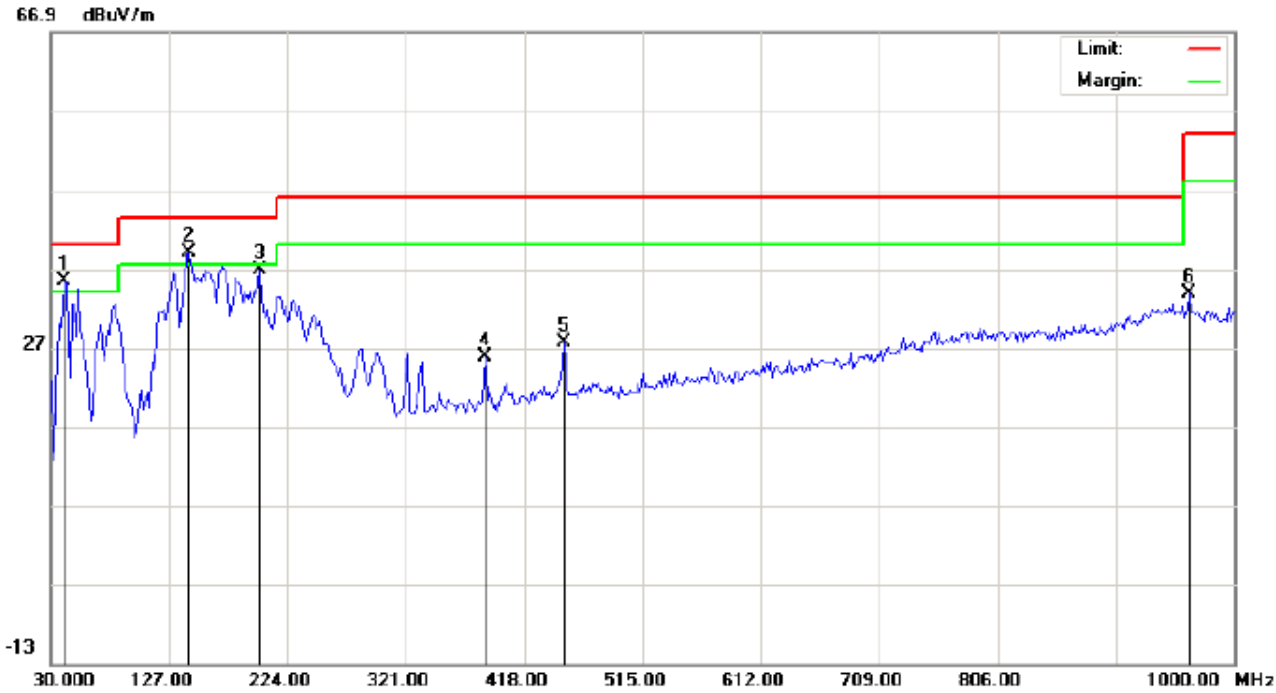

Site: site #1
 Limit: FCC Class B 3M Radiation
 EUT: MOBILE PHONE
 M/N: Q6
 Mode: Middle channel TX
 Note:

Polarization: *Vertical*
 Power: AC 120V/60Hz
 Distance:

Temperature: 23.3
 Humidity: 56.9 %

No.	Mk	Freq.	Reading	Factor	Measurement	Limit	Over	Detector	Antenna Height	Table Degree	Comment
		MHz	dBuV	dB/m	dBuV/m	dBuV/m	dB		cm	degree	
1	*	41.3167	26.68	8.81	35.49	40.00	-4.51	peak			
2	!	143.1667	23.71	15.22	38.93	43.50	-4.57	peak			
3		201.3667	27.70	9.13	36.83	43.50	-6.67	peak			
4		385.6667	6.87	18.98	25.85	46.00	-20.15	peak			
5		450.3333	7.10	20.59	27.69	46.00	-18.31	peak			
6		962.8167	4.01	29.88	33.89	54.00	-20.11	peak			

RESULT: PASS

EUT	MOBILE PHONE	Model Name	Q6
Temperature	25°C	Relative Humidity	55.4%
Pressure	960hPa	Test Voltage	Normal Voltage
Test Mode	802.11b with data rate 1 2462MHZ	Antenna	Horizontal

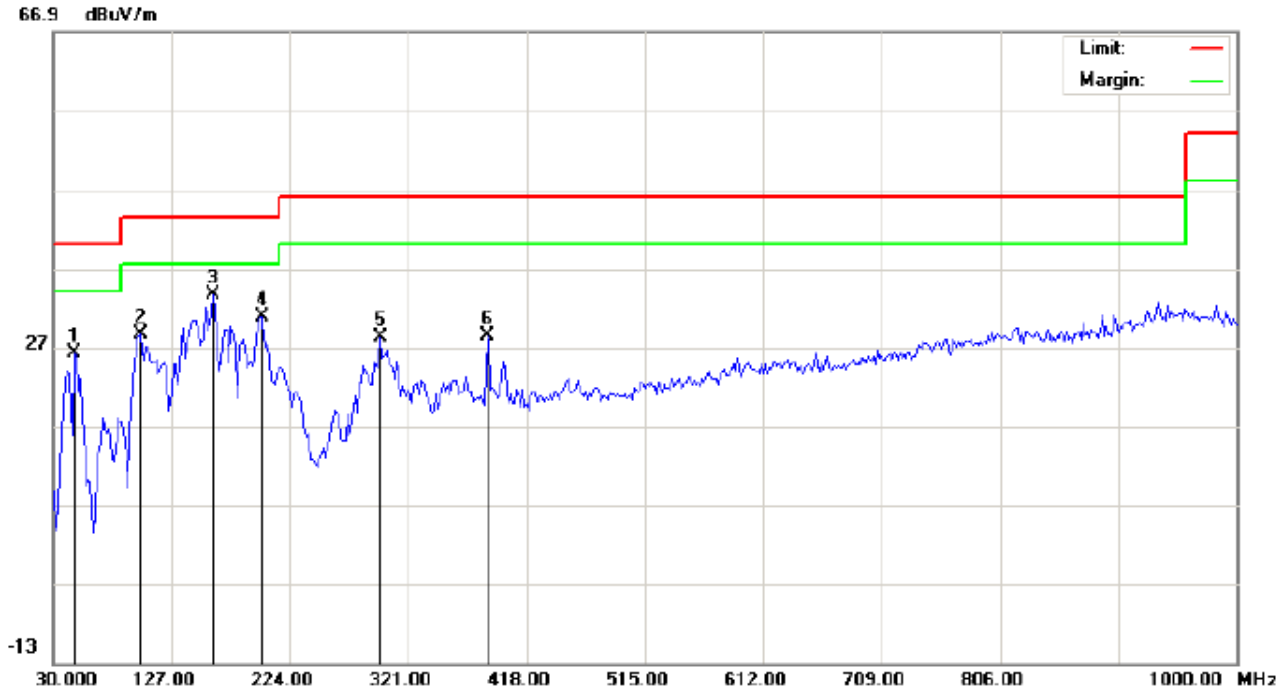

Site: site #1	Polarization: <i>Horizontal</i>	Temperature: 23.3
Limit: FCC Class B 3M Radiation	Power: AC 120V/60Hz	Humidity: 56.9 %
EUT: MOBILE PHONE	Distance:	
M/N: Q6		
Mode: High channel TX		
Note:		

No.	Mk	Freq.	Reading	Factor	Measurement	Limit	Over	Detector	Antenna Height	Table Degree	Comment
		MHz	dBuV	dB/m	dBuV/m	dBuV/m	dB		cm	degree	
1		47.7833	14.85	11.39	26.24	40.00	-13.76	peak			
2		101.1333	18.40	10.22	28.62	43.50	-14.88	peak			
3	*	160.9500	23.17	10.37	33.54	43.50	-9.96	peak			
4		201.3667	18.93	11.86	30.79	43.50	-12.71	peak			
5		298.3667	13.11	15.13	28.24	46.00	-17.76	peak			
6		385.6667	9.41	18.98	28.39	46.00	-17.61	peak			

RESULT: PASS

EUT	MOBILE PHONE	Model Name	Q6
Temperature	25°C	Relative Humidity	55.4%
Pressure	960hPa	Test Voltage	Normal Voltage
Test Mode	802.11b with data rate 1 2462MHZ	Antenna	Vertical

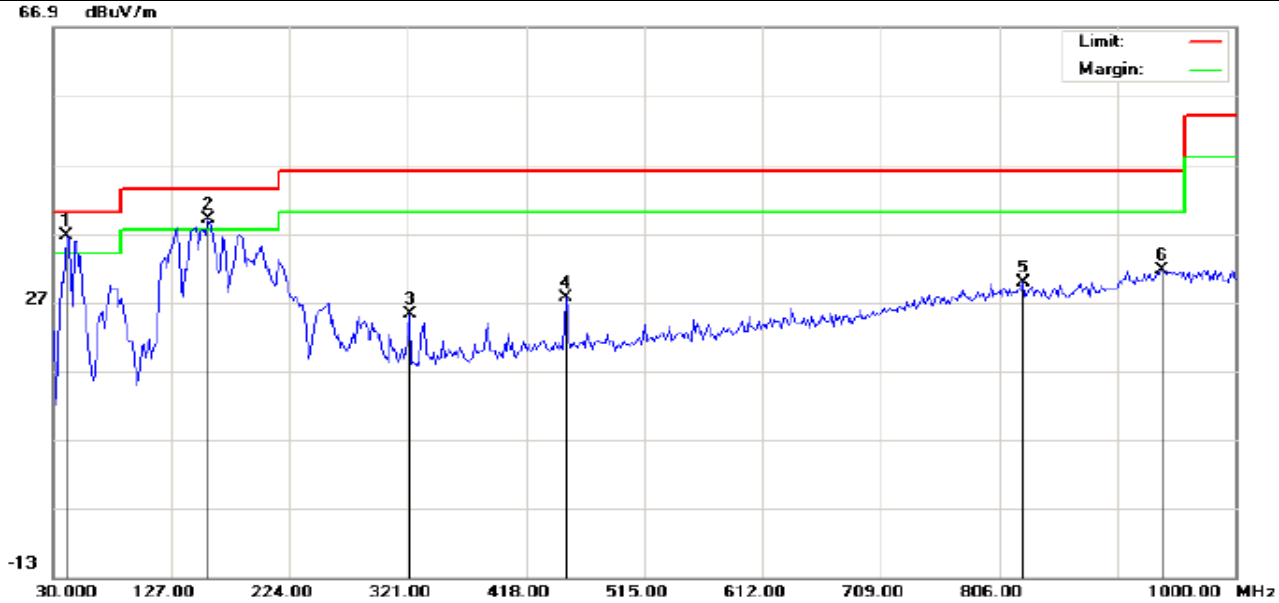

Site: site #1
 Limit: FCC Class B 3M Radiation
 EUT: MOBILE PHONE
 M/N: Q6
 Mode: High channel TX
 Note:

Polarization: **Vertical**
 Power: AC 120V/60Hz
 Distance:

Temperature: 23.3
 Humidity: 56.9 %

No.	Mk	Freq.	Reading	Factor	Measurement	Limit	Over	Detector	Antenna Height	Table Degree	Comment
		MHz	dBuV	dB/m	dBuV/m	dBuV/m	dB		cm	degree	
1	*	41.3167	27.86	8.81	36.67	40.00	-3.33	peak			
2	!	157.7167	23.63	15.32	38.95	43.50	-4.55	peak			
3		322.6167	8.27	16.92	25.19	46.00	-20.81	peak			
4		450.3333	6.97	20.59	27.56	46.00	-18.44	peak			
5		825.4000	2.50	27.31	29.81	46.00	-16.19	peak			
6		940.1833	1.82	29.73	31.55	46.00	-14.45	peak			

RESULT: PASS

- Note:** 1. Factor=Antenna Factor + Cable loss, Margin= Result -Limit.
 2. The "Factor" value can be calculated automatically by software of measurement system.
 3. 30MHz~1GHz:(Scan with 11b,11g,11n, the worst case is 11b Mode)

RADIATED EMISSION ABOVE 1GHZ

Frequency	Meter Reading	Factor	Emission Level	Limits	Margin	Detector	Comment
(MHz)	(dBμV)	(dB)	(dBμV/m)	(dBμV/m)	(dB)	Type	
TX 11b 2412MHz							
4824.092	46.61	10.44	57.05	74	-16.95	Pk	Horizontal
4824.092	31.73	10.44	42.17	54	-11.83	AV	Horizontal
7236.127	43.51	10.39	53.9	74	-20.1	pk	Horizontal
7236.127	33.86	10.39	44.25	54	-9.75	AV	Horizontal
4824.098	49.27	10.39	59.66	74	-14.34	Pk	Vertical
4824.082	33.31	10.39	43.7	54	-10.3	AV	Vertical
7236.110	48.52	10.68	59.2	74	-14.8	Pk	Vertical
7236.054	30.73	10.68	41.41	54	-12.59	AV	Vertical
TX 11b 2437MHz							
4874.072	49.61	10.39	60	74	-14	Pk	Horizontal
4874.108	33.45	10.39	43.84	54	-10.16	AV	Horizontal
7311.092	48.83	12.68	61.51	74	-12.49	Pk	Horizontal
7311.131	30.68	12.68	43.36	54	-10.64	AV	Horizontal
4874.098	49.49	10.39	59.88	74	-14.12	Pk	Vertical
4874.044	33.27	10.39	43.66	54	-10.34	AV	Vertical
7311.145	48.39	12.68	61.07	74	-12.93	Pk	Vertical
7311.104	30.13	12.68	42.81	54	-11.19	AV	Vertical
TX 11b 2462MHz							
4924.128	49.27	10.39	59.66	74	-14.34	pk	Horizontal
4924.083	33.46	10.39	43.85	54	-10.15	AV	Horizontal
7386.071	48.76	12.68	61.44	74	-12.56	pk	Horizontal
7386.134	30.32	12.68	43	54	-11	AV	Horizontal
4924.042	49.89	10.39	60.28	74	-13.72	pk	Vertical
4924.060	33.72	10.39	44.11	54	-9.89	AV	Vertical
7386.051	48.83	12.68	61.51	74	-12.49	pk	Vertical
7386.054	30.21	12.68	42.89	54	-11.11	AV	Vertical

RESULT: PASS

Note: 1~25GHz scan with 11b. No recording in the test report at least have 20dB margin.

Factor = Antenna Factor + Cable Loss – Pre-amplifier.

Emission Level = Meter Reading + Factor

Margin = Emission Level - Limit

12. BAND EDGE EMISSION

12.1. MEASUREMENT PROCEDURE

1) Radiated restricted band edge measurements

The radiated restricted band edge measurements are measured with an EMI test receiver connected to the receive antenna while the EUT is transmitting

2) Conducted Emissions at the bang edge

a) The transmitter output was connected to the spectrum analyzer

b) Set RBW=100kHz, VBW=300kHz

c) Suitable frequency span including 100kHz bandwidth from band edge

12.2. TEST SET-UP

Radiated same as 11.2

Conducted set up

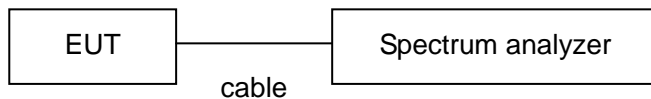

12.3. Radiated Test Result

Frequency (MHz)	Meter Reading (dB μ V)	Factor (dB)	Emission Level (dB μ V/m)	Limits (dB μ V/m)	Margin (dB)	Detector Type	Comment
TX 11b 2412MHz							
2399.9	78.18	-13	65.18	74	-8.82	peak	Horizontal
2399.9	59.32	-13	46.32	54	-7.68	AVG	Horizontal
2400	79.81	-12.99	66.82	74	-7.18	peak	Horizontal
2400	58.64	-12.99	45.65	54	-8.35	AVG	Horizontal
2399.9	79.73	-12.97	66.76	74	-7.24	peak	Vertical
2399.9	59.29	-12.97	46.32	54	-7.68	AVG	Vertical
2400	79.51	-12.94	66.57	74	-7.43	peak	Vertical
2400	59.68	-12.94	46.74	54	-7.26	AVG	Vertical
TX 11b 2462MHz							
2483.5	78.46	-12.78	65.68	74	-8.32	peak	Horizontal
2483.5	58.81	-12.78	46.03	54	-7.97	AVG	Horizontal
2483.6	78.53	-12.77	65.76	74	-8.24	peak	Horizontal
2483.6	58.61	-12.77	45.84	54	-8.16	AVG	Horizontal
2483.5	79.91	-12.76	67.15	74	-6.85	peak	Vertical
2483.5	57.53	-12.76	44.77	54	-9.23	AVG	Vertical
2483.6	78.73	-12.72	66.01	74	-7.99	peak	Vertical
2483.6	58.84	-12.72	46.12	54	-7.88	AVG	Vertical

RESULT: PASS

Note: Scan with 11b,11g,11n, the worst casw is 11b Mode

Factor=Antenna Factor + Cable loss - Amplifier gain,

Emission Level = Meter Reading + Factor

Margin= Emission Level -Limit.

The "Factor" value can be calculated automatically by software of measurement system.

12.4. Conducted Test Result

Mode	Channel	Carrier Power[dBm]	Max.Spurious Level [dBm]	Limit [dBm]	Verdict
11B	LCH	8.73	-32.16	-11.27	PASS
11B	HCH	8.64	-47.88	-11.36	PASS
11G	LCH	2.76	-33.2	-17.24	PASS
11G	HCH	2.37	-40.59	-17.63	PASS
11N20SISO	LCH	3.55	-33.17	-16.45	PASS
11N20SISO	HCH	3.27	-39.12	-16.73	PASS
11N40SISO	LCH	-2.08	-40.02	-22.08	PASS
11N40SISO	HCH	-2.44	-38.76	-22.44	PASS

Test Graph

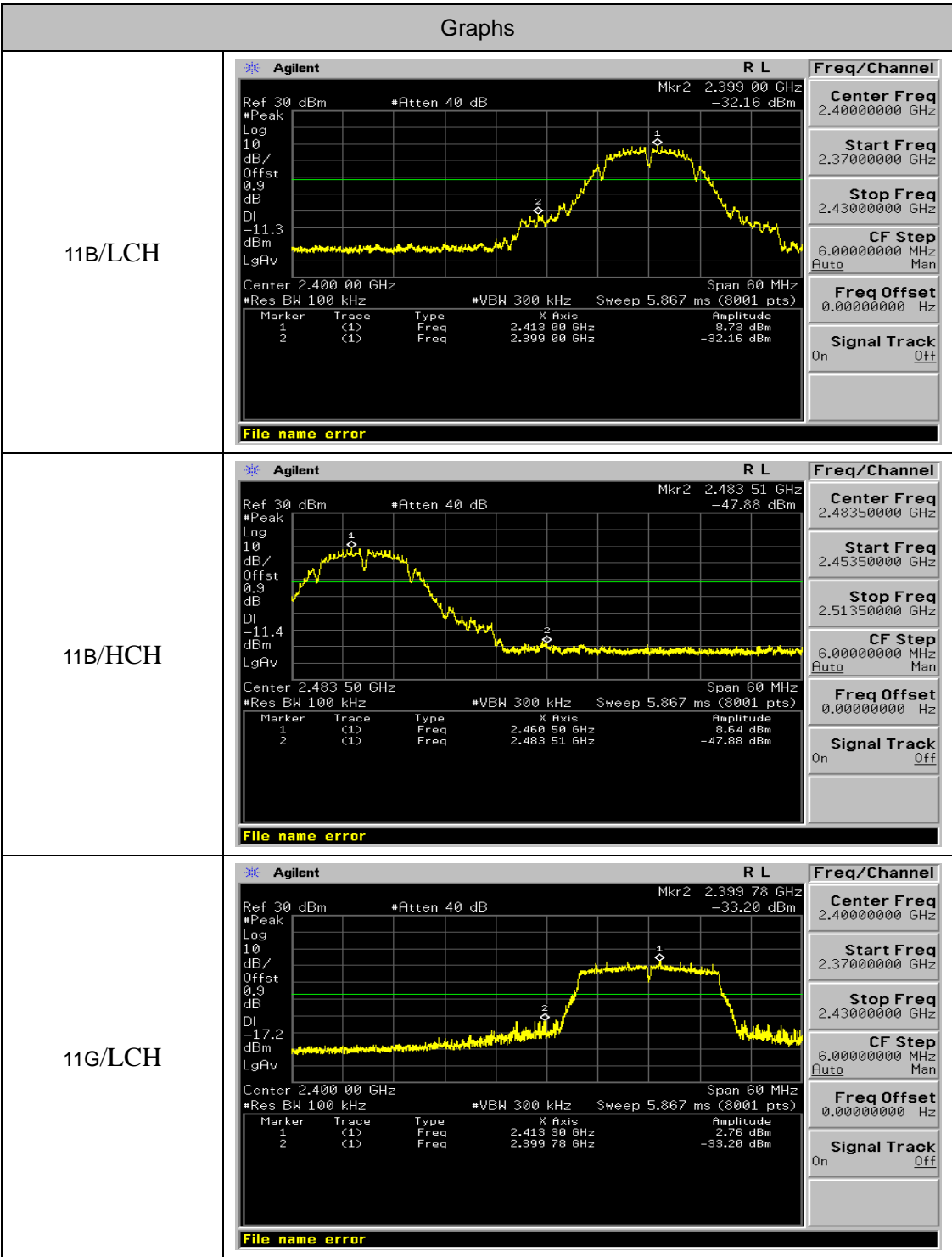

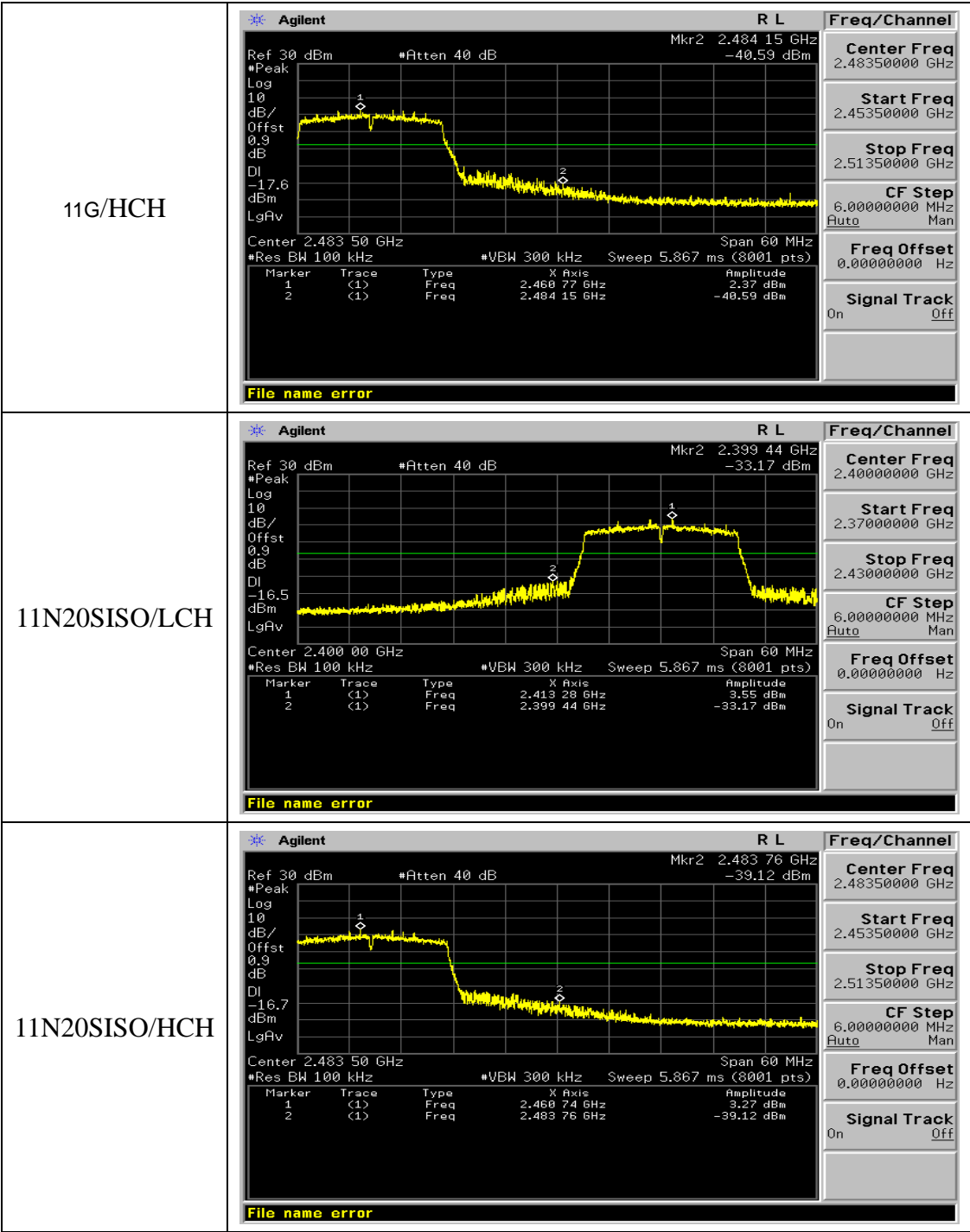

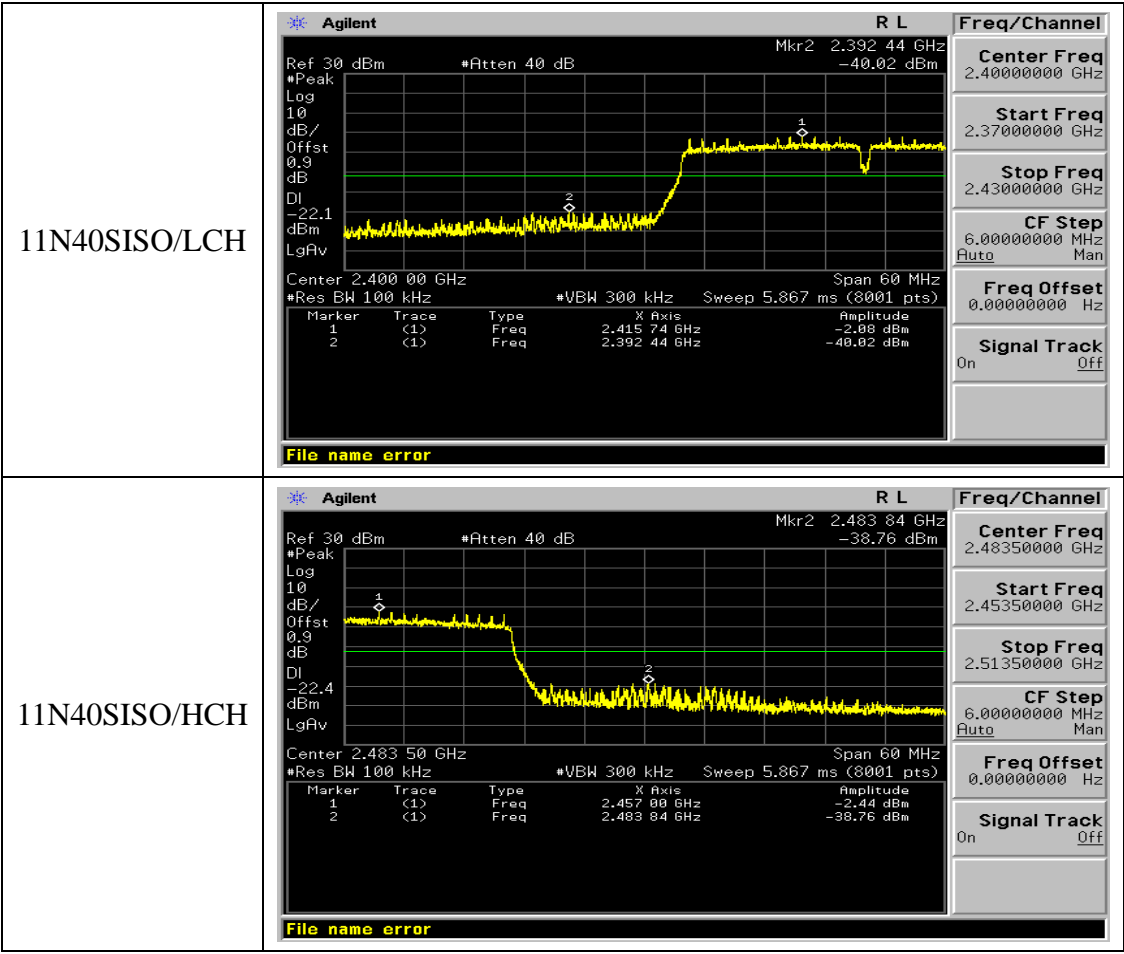

13. FCC LINE CONDUCTED EMISSION TEST

13.1. LIMITS OF LINE CONDUCTED EMISSION TEST

Frequency	Maximum RF Line Voltage	
	Q.P.(dBuV)	Average(dBuV)
150kHz~500kHz	66-56	56-46
500kHz~5MHz	56	46
5MHz~30MHz	60	50

Note:

1. The lower limit shall apply at the transition frequency.
2. The limit decreases linearly with the logarithm of the frequency in the range 0.15 MHz to 0.50 MHz.

13.2. BLOCK DIAGRAM OF LINE CONDUCTED EMISSION TEST

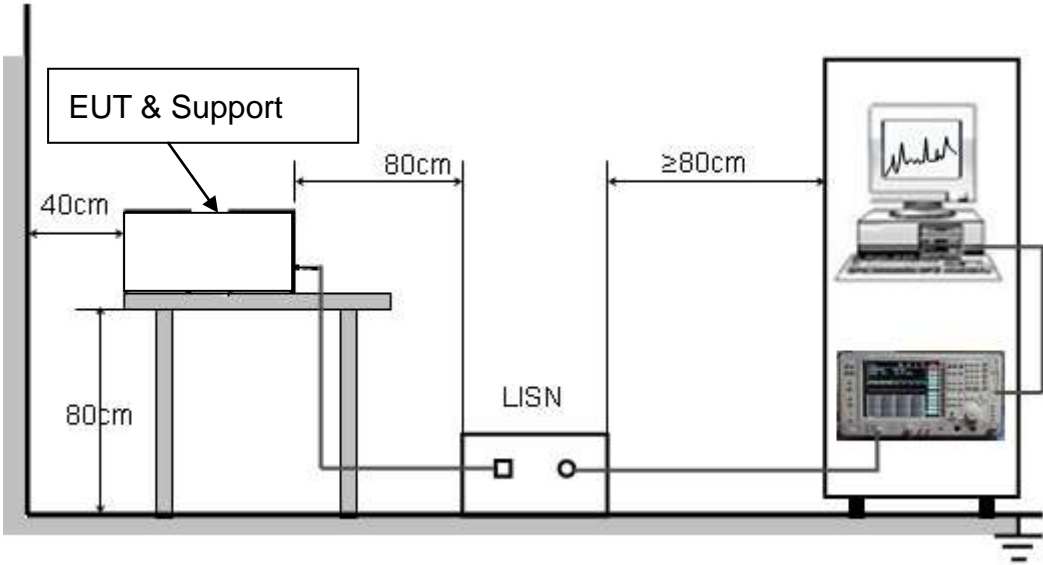

13.3. PRELIMINARY PROCEDURE OF LINE CONDUCTED EMISSION TEST

1. The equipment was set up as per the test configuration to simulate typical actual usage per the user's manual. When the EUT is a tabletop system, a wooden table with a height of 0.8 meters is used and is placed on the ground plane as per ANSI C63.4 (see Test Facility for the dimensions of the ground plane used). When the EUT is a floor-standing equipment, it is placed on the ground plane which has a 3-12 mm non-conductive covering to insulate the EUT from the ground plane.
2. Support equipment, if needed, was placed as per ANSI C63.4.
3. All I/O cables were positioned to simulate typical actual usage as per ANSI C63.4.
4. All support equipments received AC120V/60Hz power from a LISN, if any.
5. The EUT received charging voltage by adapter which received 120V/60Hz power by a LISN..
6. The test program was started. Emissions were measured on each current carrying line of the EUT using a spectrum Analyzer / Receiver connected to the LISN powering the EUT. The LISN has two monitoring points: Line 1 (Hot Side) and Line 2 (Neutral Side). Two scans were taken: one with Line 1 connected to Analyzer / Receiver and Line 2 connected to a 50 ohm load; the second scan had Line 1 connected to a 50 ohm load and Line 2 connected to the Analyzer / Receiver.
7. Analyzer / Receiver scanned from 150 kHz to 30MHz for emissions in each of the test modes.
8. During the above scans, the emissions were maximized by cable manipulation.
9. The test mode(s) were scanned during the preliminary test.

Then, the EUT configuration and cable configuration of the above highest emission level were recorded for reference of final testing.

13.4. FINAL PROCEDURE OF LINE CONDUCTED EMISSION TEST

1. EUT and support equipment was set up on the test bench as per step 2 of the preliminary test.
2. A scan was taken on both power lines, Line 1 and Line 2, recording at least the six highest emissions. Emission frequency and amplitude were recorded into a computer in which correction factors were used to calculate the emission level and compare reading to the applicable limit. If EUT emission level was less -2dB to the A.V. limit in Peak mode, then the emission signal was re-checked using Q.P and Average detector.
3. The test data of the worst case condition(s) was reported on the Summary Data page.

13.5. TEST RESULT OF LINE CONDUCTED EMISSION TEST

LINE CONDUCTED EMISSION TEST LINE 1-L

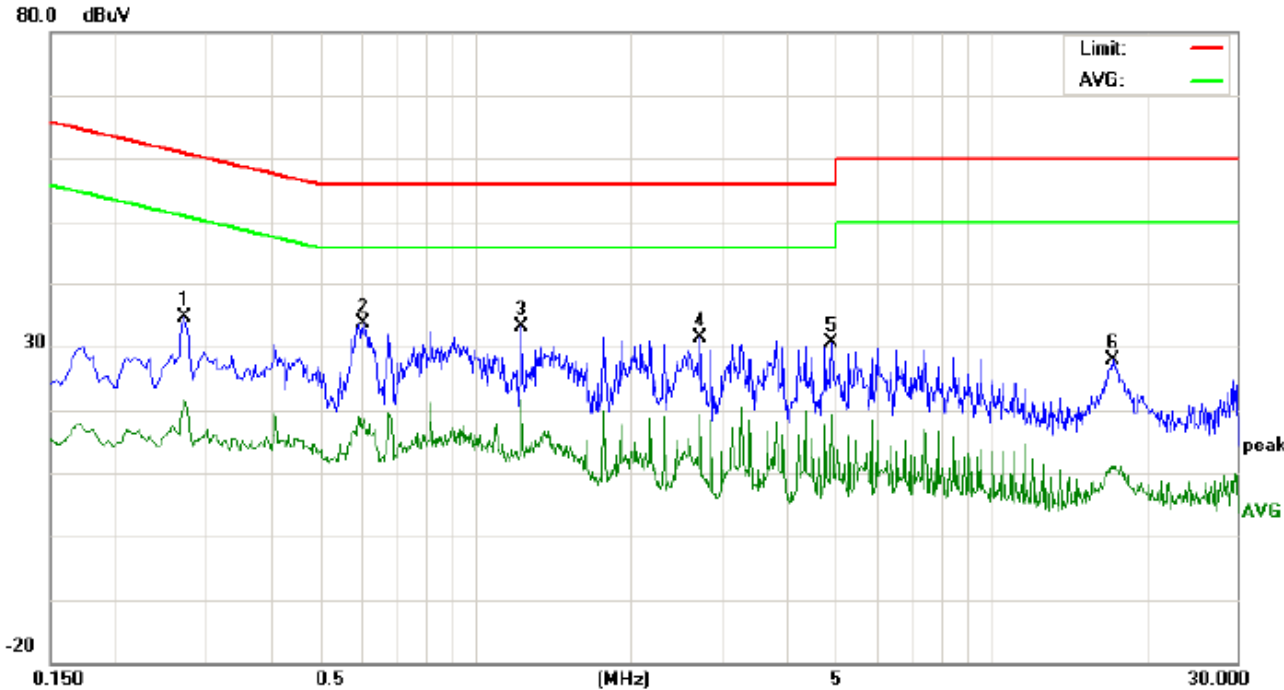

Site: Conduction Phase: **L1** Temperature: 23.4
 Limit: FCC Class B Conduction(QP) Power: AC 120V/60Hz Humidity: 55.4 %
 EUT: MOBILE PHONE
 M/N: Q6
 Mode: Normal Operation(WIFI)
 Note:

No.	Freq. (MHz)	Reading_Level (dBuV)			Correct Factor (dB)	Measurement (dBuV)			Limit (dBuV)		Margin (dB)		P/F	Comment
		Peak	QP	AVG		Peak	QP	AVG	QP	AVG	QP	AVG		
1	0.2740	24.31		11.42	10.28	34.59		21.70	60.99	50.99	-26.40	-29.29	P	
2	0.6060	23.28		8.44	10.31	33.59		18.75	56.00	46.00	-22.41	-27.25	P	
3	1.2300	22.88		11.25	10.37	33.25		21.62	56.00	46.00	-22.75	-24.38	P	
4	2.7340	20.91		8.62	10.49	31.40		19.11	56.00	46.00	-24.60	-26.89	P	
5	4.9180	20.28		8.80	10.24	30.52		19.04	56.00	46.00	-25.48	-26.96	P	
6	17.2420	17.73		0.93	10.13	27.86		11.06	60.00	50.00	-32.14	-38.94	P	

Line Conducted Emission Test Line 2-N

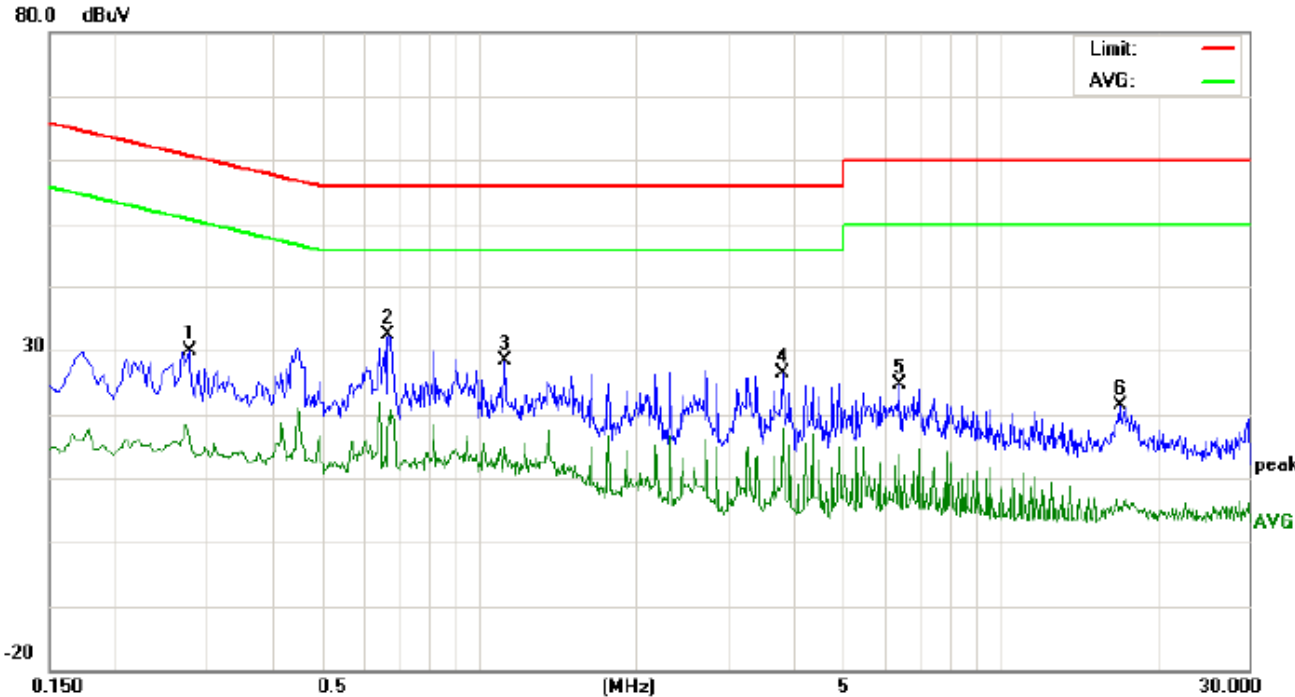

Site: Conduction Phase: **N** Temperature: 23.4
 Limit: FCC Class B Conduction(QP) Power: AC 120V/60Hz Humidity: 55.4 %
 EUT: MOBILE PHONE
 M/N: Q6
 Mode: Normal Operation(WIFI)
 Note:

No.	Freq. (MHz)	Reading_Level (dBuV)			Correct Factor (dB)	Measurement (dBuV)			Limit (dBuV)		Margin (dB)		P/F	Comment
		Peak	QP	AVG		Peak	QP	AVG	QP	AVG	QP	AVG		
1	0.2779	19.49		6.04	10.28	29.77		16.32	60.88	50.88	-31.11	-34.56	P	
2	0.6700	22.07		9.55	10.34	32.41		19.89	56.00	46.00	-23.59	-26.11	P	
3	1.1220	17.96		4.46	10.37	28.33		14.83	56.00	46.00	-27.67	-31.17	P	
4	3.8260	15.89		7.37	10.46	26.35		17.83	56.00	46.00	-29.65	-28.17	P	
5	6.4180	14.29		3.20	10.30	24.59		13.50	60.00	50.00	-35.41	-36.50	P	
6	16.9380	11.27		-4.38	10.13	21.40		5.75	60.00	50.00	-38.60	-44.25	P	

APPENDIX A: PHOTOGRAPHS OF TEST SETUP
FCC LINE CONDUCTED EMISSION TEST SETUP



FCC RADIATED EMISSION TEST SETUP

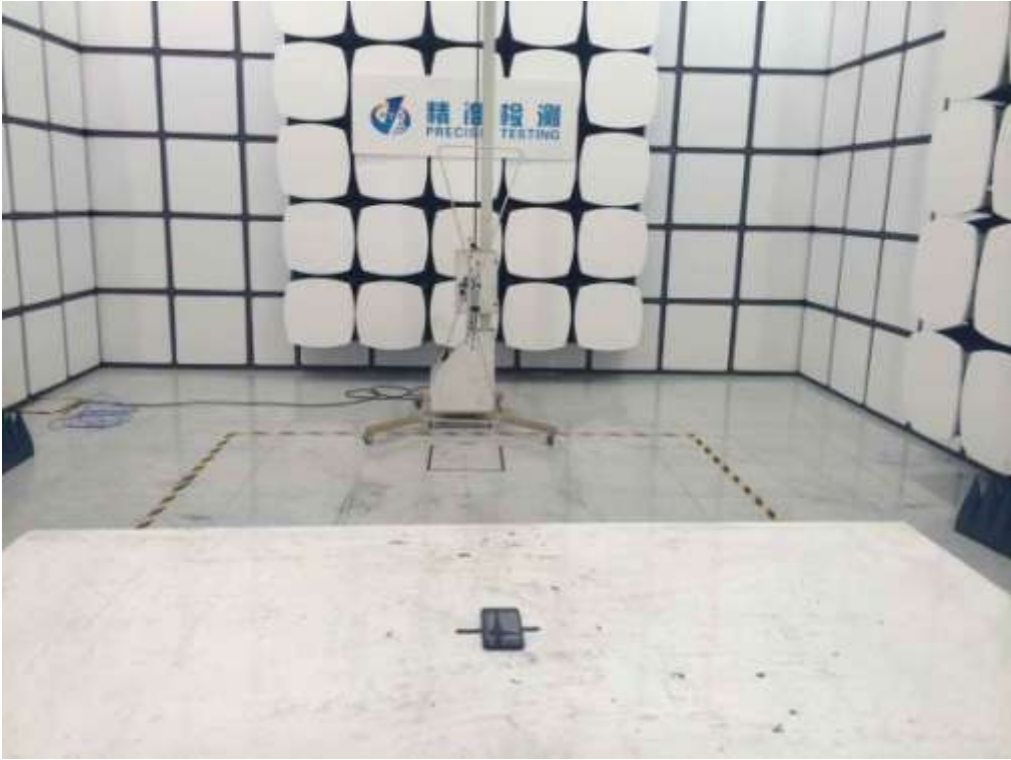

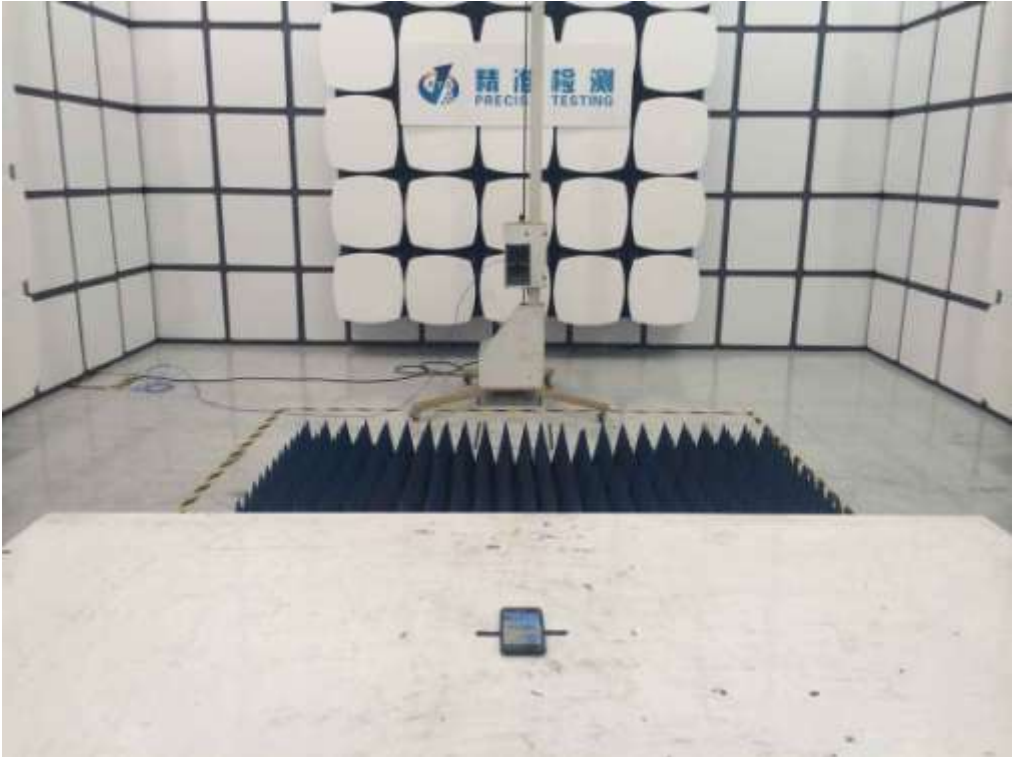

APPENDIX B: PHOTOGRAPHS OF EUT
TOTAL VIEW OF EUT



TOP VIEW OF EUT



BOTTOM VIEW OF EUT



FRONT VIEW OF EUT



BACK VIEW OF EUT



LEFT VIEW OF EUT



RIGHT VIEW OF EUT



OPEN VIEW OF EUT-1

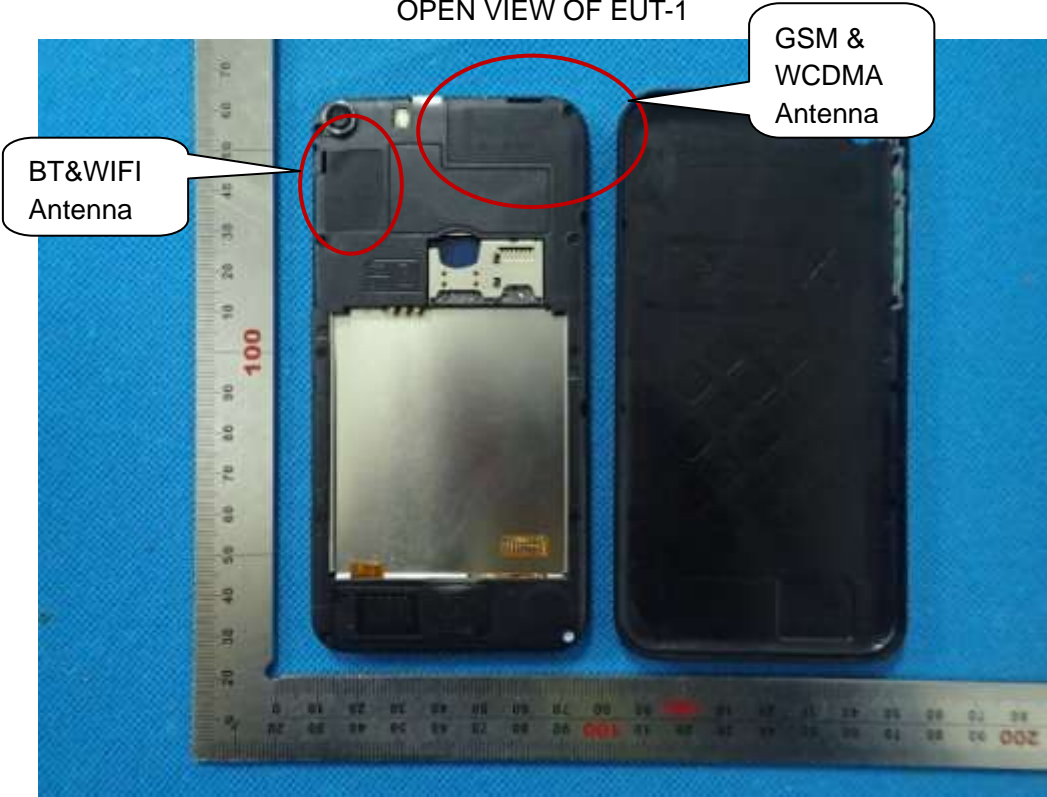

OPEN VIEW OF EUT-2



OPEN VIEW OF EUT-3



INTERNAL VIEW OF EUT-1

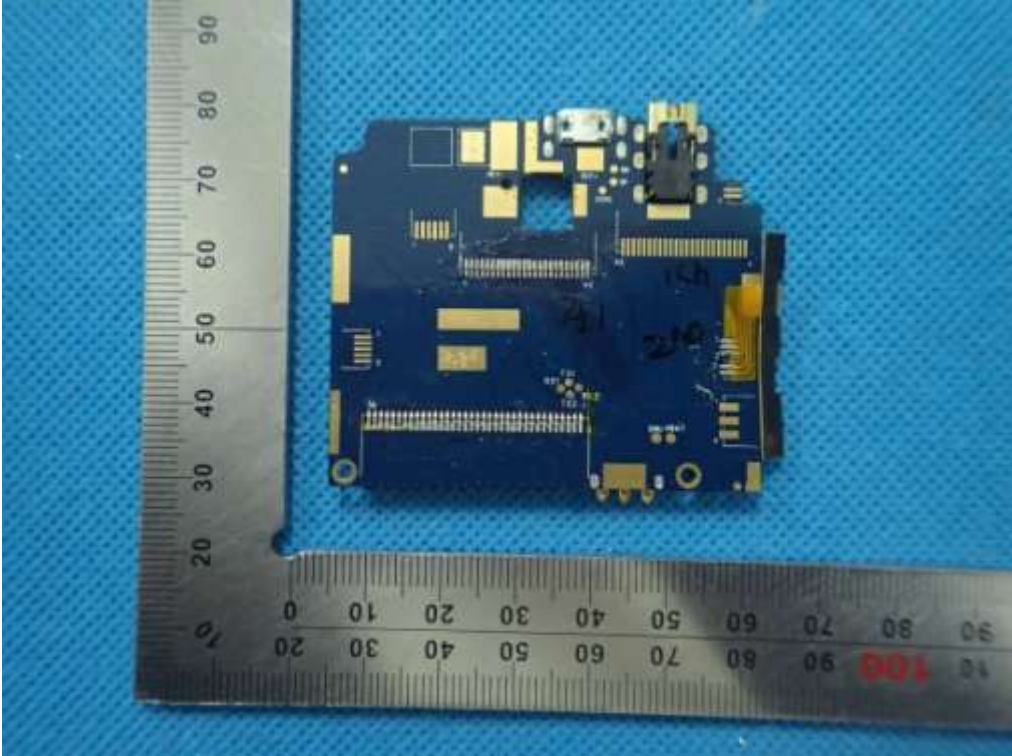

INTERNAL VIEW OF EUT-2



----END OF REPORT----