SAR Test Report

Report No.: AGC00564180901FH01

FCC ID : 2AFD9LITEPRO
APPLICATION PURPOSE : Original Equipment
PRODUCT DESIGNATION : Smart Phone
BRAND NAME : ZOOM
MODEL NAME : LitePro
CLIENT : MOVEON TECHNOLOGY LIMITED
DATE OF ISSUE : Oct. 19,2018
STANDARD(S) : IEEE Std. 1528:2013
: FCC 47CFR § 2.1093
: IEEE/ANSI C95.1:2005
REPORT VERSION : V1.0

Attestation of Global Compliance(Shenzhen) Co., Ltd.

CAUTION:

This report shall not be reproduced except in full without the written permission of the test laboratory and shall not be quoted out of context.



Report Revise Record

Report Version	Revise Time	Issued Date	Valid Version	Notes
V1.0	/	Oct. 19,2018	Valid	Initial Release

TestReport

Applicant Name	MOVEON TECHNOLOGY LIMITED
Applicant Address	World Trade Plaza-A block #3201-3202 Fuhong Road, Futian, Shenzhen, China
Manufacturer Name	MOVEON TECHNOLOGY LIMITED
Manufacturer Address	World Trade Plaza-A block #3201-3202 Fuhong Road, Futian, Shenzhen, China
Product Designation	Smart Phone
Brand Name	ZOOM
Model Name	LitePro
Different Description	N/A
EUT Voltage	DC3.7V by battery
Applicable Standard	IEEE Std. 1528:2013 FCC 47CFR § 2.1093 IEEE/ANSI C95.1:2005
Test Date	Oct. 10,2018 to Oct. 12,2018
Report Template	AGCRT-US-3G3/SAR (2018-01-01)

Note: The results of testing in this report apply to the product/system which was tested only.

Eric Zhou

Tested By

Eric Zhou(Zhou Yongkang)

Oct. 12,2018

Angela Li

Checked By

Angela Li(Li Jiao)

Oct. 19,2018

Forrest Lei

Authorized By

Forrest Lei(Lei Yonggang)

Oct. 19,2018

Authorized Officer

TABLE OF CONTENTS

1. SUMMARY OF MAXIMUM SAR VALUE	5
2. GENERAL INFORMATION.....	6
2.1. EUT DESCRIPTION.....	6
3. SAR MEASUREMENT SYSTEM.....	8
3.1. THE SATIMO SYSTEM USED FOR PERFORMING COMPLIANCE TESTS CONSISTS OF FOLLOWING ITEMS	8
3.2. COMOSAR E-FIELD PROBE	9
3.3. ROBOT.....	9
3.4. VIDEO POSITIONING SYSTEM	10
3.5. DEVICE HOLDER	10
3.6. SAM TWIN PHANTOM.....	11
4. SAR MEASUREMENT PROCEDURE.....	12
4.1. SPECIFIC ABSORPTION RATE (SAR).....	12
4.2. SAR MEASUREMENT PROCEDURE	13
4.3. RF EXPOSURE CONDITIONS	15
5. TISSUE SIMULATING LIQUID.....	17
5.1. THE COMPOSITION OF THE TISSUE SIMULATING LIQUID.....	17
5.2. TISSUE DIELECTRIC PARAMETERS FOR HEAD AND BODY PHANTOMS	17
5.3. TISSUE CALIBRATION RESULT	18
6. SAR SYSTEM CHECK PROCEDURE	20
6.1. SAR SYSTEM CHECK PROCEDURES	20
6.2. SAR SYSTEM CHECK.....	21
7. EUT TEST POSITION.....	22
7.2. CHEEK POSITION	23
7.3. TILT POSITION.....	23
7.4. BODY WORN POSITION	24
8. SAR EXPOSURE LIMITS	25
9. TEST FACILITY	26
10. TEST EQUIPMENT LIST	27
11. MEASUREMENT UNCERTAINTY	28
12. CONDUCTED POWER MEASUREMENT.....	31
13. TEST RESULTS	39
13.1. SAR TEST RESULTS SUMMARY.....	39
APPENDIX A. SAR SYSTEM CHECK DATA	50
APPENDIX B. SAR MEASUREMENT DATA.....	62
APPENDIX C. TEST SETUP PHOTOGRAPHS.....	90
APPENDIX D. CALIBRATION DATA	96

1. SUMMARY OF MAXIMUM SARVALUE

The maximum results of Specific Absorption Rate (SAR) found during testing for EUT are as follows:

Frequency Band	Highest Reported 1g-SAR(W/Kg)		SAR Test Limit (W/Kg)
	Head	Body-worn	
GSM 850	0.525	0.695	1.6
PCS 1900	0.086	1.128	
UMTS Band II	0.189	1.068	
UMTS Band V	0.416	0.561	
WIFI 2.4G	0.081	0.340	
Simultaneous Reported SAR	1.131		
SAR Test Result	PASS		

This device is compliance with Specific Absorption Rate (SAR) for general population/uncontrolled exposure limits (1.6W/Kg) specified in IEEE Std. 1528:2013; FCC 47CFR § 2.1093; IEEE/ANSI C95.1:2005 and the following specific FCC Test Procedures:

- KDB 447498 D01 General RF Exposure Guidance v06
- KDB 648474 D04 Handset SAR v01r03
- KDB 865664 D01 SAR Measurement 100MHz to 6GHz v01r04
- KDB 941225 D01 3G SAR Procedures v03r01
- KDB 941225 D06 Hotspot Mode v02r01
- KDB 248227 D01 802 11 Wi-Fi SAR v02r02

2. GENERAL INFORMATION

2.1. EUT Description

General Information	
Product Designation	Smart Phone
Test Model	LitePro
Hardware Version	7130D-MMI-V10
Software Version	Zoom_LitePro_001_20180903
Device Category	Portable
RF Exposure Environment	Uncontrolled
Antenna Type	Internal
GSM and GPRS& EGPRS	
Support Band	<input checked="" type="checkbox"/> GSM 850 <input checked="" type="checkbox"/> PCS1900(US Frequency) <input checked="" type="checkbox"/> GSM 900 <input checked="" type="checkbox"/> DCS 1800 (none US Frequency)
GPRS & EGPRS Type	Class B
GPRS & EGPRS Class	Class 12(1Tx+4Rx, 2Tx+3Rx, 3Tx+2Rx, 4Tx+1Rx)
TX Frequency Range	GSM 850 : 820-850MHz;; PCS 1900: 1850-1910MHz;
RX Frequency Range	GSM 850 : 869~894MHz; PCS 1900: 1930~1990MHz
Release Version	R99
Type of modulation	GMSK for GSM/GPRS;
Antenna Gain	GSM850:0.99dBi; PCS1900: 0.84dBi;
Max.Average Power	GSM850:31.52dBm ;PCS1900:28.69dBm
WCDMA	
Support Band	<input checked="" type="checkbox"/> UMTS FDD Band II <input checked="" type="checkbox"/> UMTS FDD Band V (US Frequency) <input checked="" type="checkbox"/> UMTS FDD Band I <input checked="" type="checkbox"/> UMTS FDD Band VIII (none US Frequency)
HS Type	HSPA(HSUPA/HSDPA)
TX Frequency Range	WCDMA FDD Band II: 1850-1910MHz; WCDMA FDD Band V: 820-850MHz
RX Frequency Range	WCDMA FDD Band II: 1930-1990MHz; WCDMA FDD Band V: 869-894MHz
Release Version	Rel-6
Type of modulation	HSDPA:QPSK/16QAM;HSUPA:BPSK; WCDMA:QPSK
Antenna Gain	Band II:0.66dBi ; Band V:0.74dBi
Max.Average Power	Band II: 22.36dBm; Band V: 21.72dBm

EUT Description(Continue)

Bluetooth	
Operation Frequency	2402~2480MHz
Antenna Gain	1dBi
Bluetooth Version	BR/EDR,BLE
Type of modulation	BR/EDR: GFSK, Π/4-DQPSK, 8-DPSK; BLE: GFSK
EIRP	BR/EDR: 1.105dBm; BLE: -6.058dBm
WIFI	
WIFI Specification	<input type="checkbox"/> 802.11a <input checked="" type="checkbox"/> 802.11b <input checked="" type="checkbox"/> 802.11g <input checked="" type="checkbox"/> 802.11n(20) <input checked="" type="checkbox"/> 802.11n(40)
Operation Frequency	2412~2462MHz
Avg. Burst Power	11b:14.18dBm,11g:12.23dBm,11n(20):12.16dBm,11n(40):8.23dBm
Antenna Gain	1dBi
Accessories	
Battery	Brand name: ZOOM Model No. :LitePro Voltage and Capacitance: 3.7 V &2500mAh
Earphone	Brand name:N/A Model No. : N/A

Note:1.CMU200can measure the average power and Peak power at the same time
2.The sample used for testing is end product.

Product	Type
	<input checked="" type="checkbox"/> Production unit <input type="checkbox"/> Identical Prototype

3. SAR MEASUREMENT SYSTEM

3.1. The SATIMO system used for performing compliance tests consists of following items

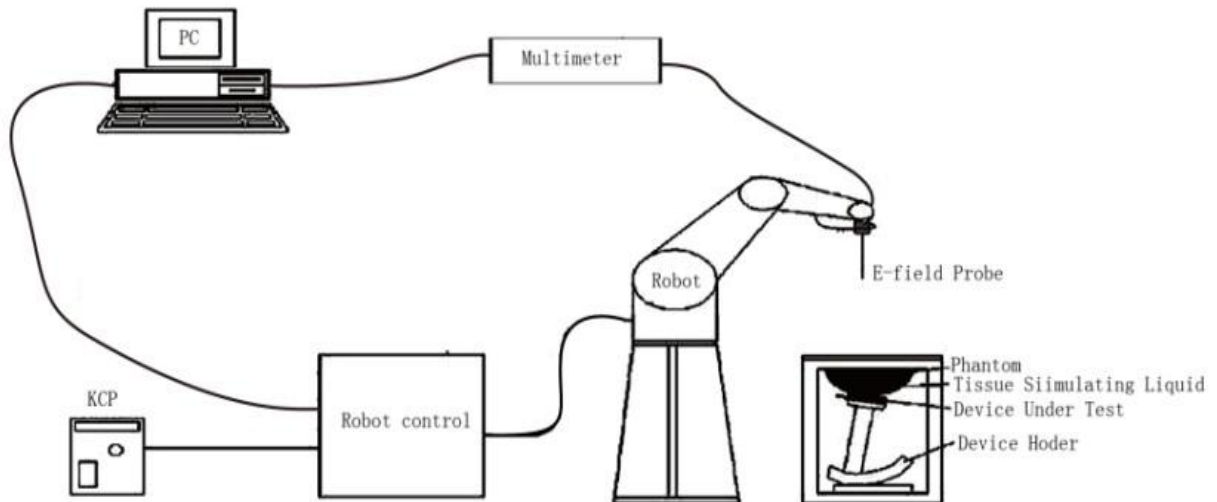

The COMOSAR system for performing compliance tests consists of the following items:

- The PC. It controls most of the bench devices and stores measurement data. A computer running WinXP and the Opensar software.
- The E-Field probe. The probe is a 3-axis system made of 3 distinct dipoles. Each dipole returns a voltage in function of the ambient electric field.
- The Keithley multimeter measures each probe dipole voltages.
- The SAM phantom simulates a human head. The measurement of the electric field is made inside the phantom.
- The liquids simulate the dielectric properties of the human head tissues.
- The network emulator controls the mobile phone under test.
- The validation dipoles are used to measure a reference SAR. They are used to periodically check the bench to make sure that there is no drift of the system characteristics over time.
- The phantom, the device holder and other accessories according to the targeted measurement.

3.2. COMOSAR E-Field Probe

The SAR measurement is conducted with the dosimetric probe manufactured by SATIMO. The probe is specially designed and calibrated for use in liquid with high permittivity. The dosimetric probe has special calibration in liquid at different frequency. SATIMO conducts the probe calibration in compliance with international and national standards (e.g. IEEE 1528 and relevant KDB files.) The calibration data are in Appendix D.

Isotropic E-Field Probe Specification

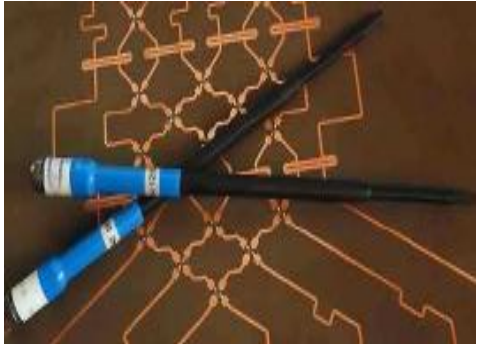
Model	SSE5	
Manufacture	MVG	
Identification No.	SN 22/12 EP159	
Frequency	0.45GHz-3GHz Linearity: ± 0.11 dB (0.45GHz-3GHz)	
Dynamic Range	0.01W/Kg-100W/Kg Linearity: ± 0.11 dB	
Dimensions	Overall length: 330mm Length of individual dipoles: 4.5mm Maximum external diameter: 8mm Probe Tip external diameter: 5mm Distance between dipoles/ probe extremity: 2.7mm	
Application	High precision dosimetric measurements in any exposure scenario (e.g., very strong gradient fields). Only probe which enables compliance testing for frequencies up to 3 GHz with precision of better 30%.	

3.3. Robot

The COMOSAR system uses the KUKA robot from SATIMO SA (France). For the 6-axis controller COMOSAR system, the KUKA robot controller version from SATIMO is used.

The XL robot series have many features that are important for our application:

- High precision (repeatability 0.02 mm)
- High reliability (industrial design)
- Jerk-free straight movements
- Low ELF interference (the closed metallic construction shields against motor control fields)
- 6-axis controller



3.4. Video Positioning System

The video positioning system is used in OpenSAR to check the probe. Which is composed of a camera, LED, mirror and mechanical parts. The camera is piloted by the main computer with firewire link. During the process, the actual position of the probe tip with respect to the robot arm is measured, as well as the probe length and the horizontal probe offset. The software then corrects all movements, such that the robot coordinates are valid for the probe tip. The repeatability of this process is better than 0.1 mm. If a position has been taught with an aligned probe, the same position will be reached with another aligned probe within 0.1 mm, even if the other probe has different dimensions. During probe rotations, the probe tip will keep its actual position.

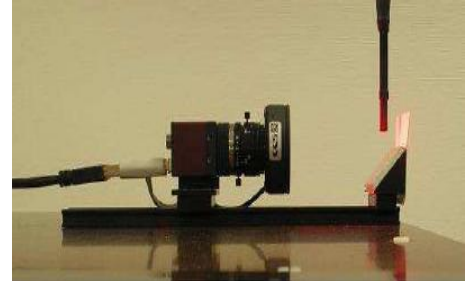

3.5. Device Holder

The COMOSAR device holder is designed to cope with different positions given in the standard. It has two scales for the device rotation (with respect to the body axis) and the device inclination (with respect to the line between the ear reference points). The rotation center for both scales is the ear reference point (EPR). Thus the device needs no repositioning when changing the angles. The COMOSAR device holder has been made out of low-loss POM material having the following dielectric parameters: relative permittivity $\epsilon_r=3$ and loss tangent $\delta = 0.02$. The amount of dielectric material has been reduced in the closest vicinity of the device, since measurements have suggested that the influence of the clamp on the test results could thus be lowered.

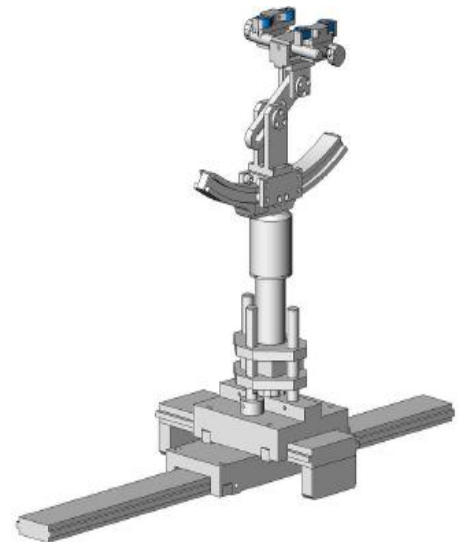

3.6. SAM Twin Phantom

The SAM twin phantom is a fiberglass shell phantom with 2mm shell thickness (except the ear region where shell thickness increases to 6mm). It has three measurement areas:

- Left head
- Right head
- Flat phantom



The bottom plate contains three pair of bolts for locking the device holder. The deviceholder positions are adjusted to the standard measurement positions in the threesections. A white cover is provided to tap the phantom during off-periods to prevent waterevaporation and changes in the liquid parameters. On the phantom top, three referencemarkers are provided to identify the phantom position with respect to the robot.

4. SAR MEASUREMENT PROCEDURE

4.1. Specific Absorption Rate (SAR)

SAR is related to the rate at which energy is absorbed per unit mass in object exposed to a radio field. The SAR distribution in a biological body is complicated and is usually carried out by experimental techniques or numerical modeling. The standard recommends limits for two tiers of groups, occupational/controlled and occupational/uncontrolled, based on a person's awareness and ability to exercise control over his or her exposure. In general, occupational/controlled exposure limits are higher than the limits for general population/uncontrolled.

The SAR definition is the time derivative (rate) of the incremental energy (dW) absorbed by (dissipated in) an incremental mass (dm) contained in a volume element(dv) of given mass density (ρ). The equation description is as below:

$$SAR = \frac{d}{dt} \left(\frac{dW}{dm} \right) = \frac{d}{dt} \left(\frac{dW}{\rho dV} \right)$$

SAR is expressed in units of Watts per kilogram (W/Kg)

SAR can be obtained using either of the following equations:

$$SAR = \frac{\sigma E^2}{\rho}$$

$$SAR = c_h \left. \frac{dT}{dt} \right|_{t=0}$$

Where

SAR	is the specific absorption rate in watts per kilogram;
E	is the r.m.s. value of the electric field strength in the tissue in volts per meter;
σ	is the conductivity of the tissue in siemens per metre;
ρ	is the density of the tissue in kilograms per cubic metre;
c _h	is the heat capacity of the tissue in joules per kilogram and Kelvin;

$\left. \frac{dT}{dt} \right|_{t=0}$ is the initial time derivative of temperature in the tissue in kelvins per second

4.2. SAR Measurement Procedure

Step 1: Power Reference Measurement

The Power Reference Measurement and Power Drift Measurement are for monitoring the power drift of the device under test in the batch process. The minimum distance of probe sensors to surface is 2.7mm This distance cannot be smaller than the distance os sensor calibration points to probe tip as `defined in the probe properties,

Step 2: Area Scan

The Area Scan is used as a fast scan in two dimensions to find the area of high field values, before doing a fine measurement around the hot spot. The sophisticated interpolation routines implemented in SATIMO software can find the maximum locations even in relatively coarse grids. When an Area Scan has measured all reachable points, it computes the field maximal found in the scanned area, within a range of the global maximum. The range (in db) is specified in the standards for compliance testing. For example, a 2db range is required in IEEE Standard 1528, whereby 3db is a requirement when compliance is assessed in accordance with the ARIB standard (Japan) If one Zoom Scan follows the Area Scan, then only the absolute maximum will be taken as reference. For cases where multiple maximum are detected, the number of Zoom Scan has to be increased accordingly.

Area Scan Parameters extracted from KDB 865664 D01 SAR Measurement 100MHz to 6GHz

	≤ 3 GHz	> 3 GHz
Maximum distance from closest measurement point (geometric center of probe sensors) to phantom surface	5 ± 1 mm	$\frac{1}{2} \cdot \delta \cdot \ln(2) \pm 0.5$ mm
Maximum probe angle from probe axis to phantom surface normal at the measurement location	30° ± 1°	20° ± 1°
Maximum area scan spatial resolution: Δx_{Area} , Δy_{Area}	≤ 2 GHz: ≤ 15 mm 2 – 3 GHz: ≤ 12 mm	3 – 4 GHz: ≤ 12 mm 4 – 6 GHz: ≤ 10 mm
	When the x or y dimension of the test device, in the measurement plane orientation, is smaller than the above, the measurement resolution must be ≤ the corresponding x or y dimension of the test device with at least one measurement point on the test device.	

Step 3: Zoom Scan

Zoom Scan are used to assess the peak spatial SAR value within a cubic average volume containing 1g abd 10g of simulated tissue. The Zoom Scan measures points(refer to table below) within a cube whose base faces are centered on the maxima found in a preceding area scan job within the same procedure. When the measurement is done, the Zoom Scan evaluates the averaged SAR for 1g and 10g and displays these values next to the job's label.

Zoom Scan Parameters extracted from KDB865664 d01 SAR Measurement 100MHz to 6GHz

Maximum zoom scan spatial resolution: Δx_{Zoom} , Δy_{Zoom}		≤ 2 GHz: ≤ 8 mm 2 – 3 GHz: ≤ 5 mm*	3 – 4 GHz: ≤ 5 mm* 4 – 6 GHz: ≤ 4 mm*
Maximum zoom scan spatial resolution, normal to phantom surface	uniform grid: $\Delta z_{Zoom}(n)$	≤ 5 mm	3 – 4 GHz: ≤ 4 mm 4 – 5 GHz: ≤ 3 mm 5 – 6 GHz: ≤ 2 mm
	graded grid	$\Delta z_{Zoom}(1)$: between 1 st two points closest to phantom surface	≤ 4 mm
		$\Delta z_{Zoom}(n>1)$: between subsequent points	$\leq 1.5 \cdot \Delta z_{Zoom}(n-1)$
Minimum zoom scan volume	x, y, z	≥ 30 mm	3 – 4 GHz: ≥ 28 mm 4 – 5 GHz: ≥ 25 mm 5 – 6 GHz: ≥ 22 mm
<p>Note: δ is the penetration depth of a plane-wave at normal incidence to the tissue medium; see draft standard IEEE P1528-2011 for details.</p> <p>* When zoom scan is required and the <i>reported</i> SAR from the <i>area scan based I-g SAR estimation</i> procedures of KDB 447498 is ≤ 1.4 W/kg, ≤ 8 mm, ≤ 7 mm and ≤ 5 mm zoom scan resolution may be applied, respectively, for 2 GHz to 3 GHz, 3 GHz to 4 GHz and 4 GHz to 6 GHz.</p>			

Step 4: Power Drift Measurement

The Power Drift Measurement measures the field at the same location as the most recent power reference measurement within the same procedure, and with the same settings. The Power Drift Measurement gives the field difference in dB from the reading conducted within the same settings. This allows a user to monitor the power drift of the device under test within a batch process. The measurement procedure is the same as Step 1.

4.3.RF Exposure Conditions

Test Configuration and setting:

The EUT is a model of GSM/WCDMA Portable Mobile Station (MS). It supports GSM/GPRS, WCDMA/HSPA, BT, WIFI, and support hot spot mode.

For WWAN SAR testing, the device was controlled by using a base station emulator. Communication between the device and the emulator were established by air link. The distance between the EUT and the antenna is larger than 50cm, and the output power radiated from the emulator antenna is at least 30db smaller than the output power of EUT.

For WLAN testing, the EUT is configured with the WLAN continuous TX tool through engineering command.

Antenna Location: (the back view)

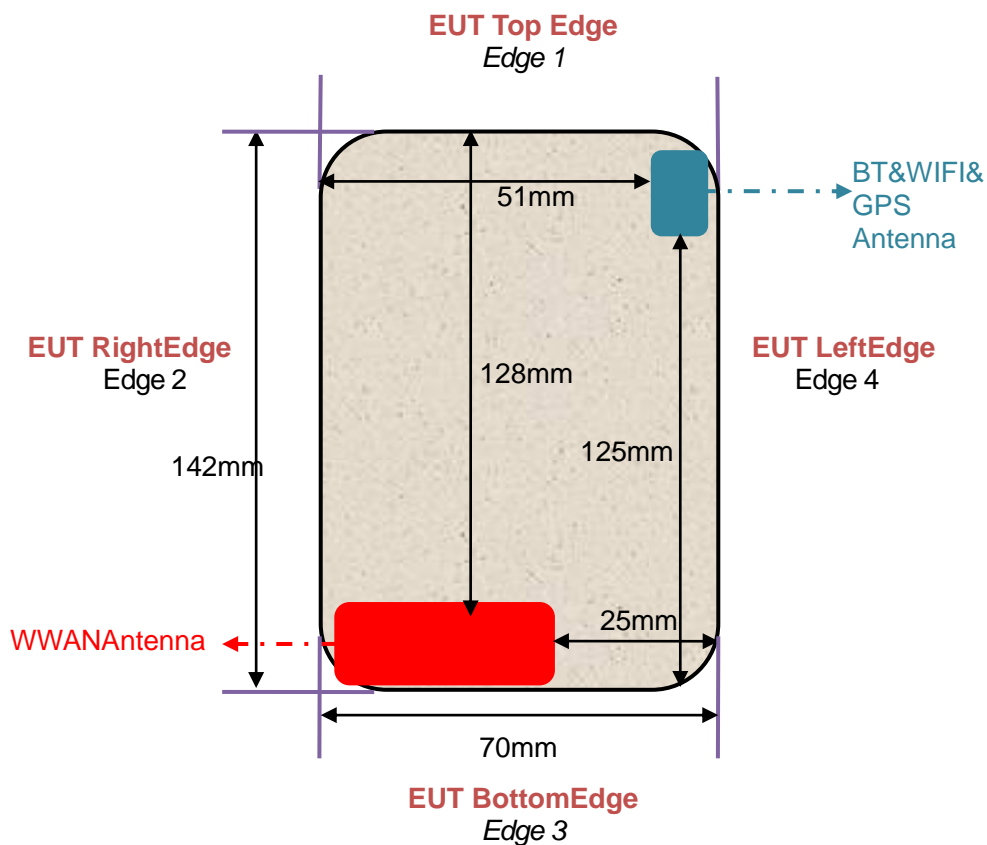

For WWAN mode:

Test Configurations	Antenna to edges/surface	SAR required	Note
Head			
Left Touch		Yes	--
Left Tilt		Yes	--
Right Touch		Yes	--
Right Tilt		Yes	--
Body			
Back	<25mm	Yes	--
Front	<25mm	Yes	--
Hotspot			
Back	<25mm	Yes	--
Front	<25mm	Yes	--
Edge 1 (Top)	128mm	No	SAR is not required for the distance between the antenna and the edge is >25mm as per KDB 941225 D06 Hotspot SAR
Edge 2 (Right)	2mm	Yes	--
Edge 3 (Bottom)	2mm	Yes	--
Edge 4 (Left)	25mm	Yes	--

For WLAN mode:

Test Configurations	Antenna to edges/surface	SAR required	Note
Head			
Left Touch		Yes	--
Left Tilt		Yes	--
Right Touch		Yes	--
Right Tilt		Yes	--
Body			
Back	<25mm	Yes	--
Front	<25mm	Yes	--
Hotspot			
Back	<25mm	Yes	--
Front	<25mm	Yes	--
Edge 1 (Top)	3mm	Yes	--
Edge 2 (Right)	51mm	No	SAR is not required for the distance between the antenna and the edge is >25mm as per KDB 941225 D06 Hotspot SAR
Edge 3 (Bottom)	125mm	No	SAR is not required for the distance between the antenna and the edge is >25mm as per KDB 941225 D06 Hotspot SAR
Edge 4 (Left)	2mm	Yes	

5. TISSUE SIMULATING LIQUID

For SAR measurement of the field distribution inside the phantom, the phantom must be filled with homogeneous tissue simulating liquid to a depth of at least 15cm. For head SAR testing the liquid height from the ear reference point (ERP) of the phantom to the liquid top surface is larger than 15cm For body SAR testing, the liquid height from the center of the flat phantom to the liquid top surface is larger than 15cm. The nominal dielectric values of the tissue simulating liquids in the phantom and the tolerance of 5% are listed in 5.2

5.1. The composition of the tissue simulating liquid

Ingredient (% Weight) Frequency (MHz)	Water	Nacl	Polysorbate 20	DGBE	1,2 Propanediol	Triton X-100
835 Head	50.36	1.25	48.39	0.0	0.0	0.0
835 Body	54.00	1	0.0	15	0.0	30
1900 Head	54.9	0.18	0.0	44.92	0.0	0.0
1900 Body	70	1	0.0	9	0.0	20
2450 Head	71.88	0.16	0.0	7.99	0.0	19.97
2450 Body	70	1	0.0	9	0.0	20

5.2. Tissue Dielectric Parameters for Head and Body Phantoms

The head tissue dielectric parameters recommended by the IEEE 1528 have been incorporated in the following table. These head parameters are derived from planar layer models simulating the highest expected SAR for the dielectric properties and tissue thickness variations in a human head. Other head and body tissue parameters that have not been specified in IEEE 1528 are derived from the tissue dielectric parameters computed from the 4-Cole-Cole equations described in Reference [12] and extrapolated according to the head parameters specified in IEEE 1528.

Target Frequency (MHz)	head		body	
	ϵ_r	σ (S/m)	ϵ_r	σ (S/m)
300	45.3	0.87	58.2	0.92
450	43.5	0.87	56.7	0.94
835	41.5	0.90	55.2	0.97
900	41.5	0.97	55.0	1.05
915	41.5	1.01	55.0	1.06
1450	40.5	1.20	54.0	1.30
1610	40.3	1.29	53.8	1.40
1800 – 2000	40.0	1.40	53.3	1.52
2450	39.2	1.80	52.7	1.95
3000	38.5	2.40	52.0	2.73

(ϵ_r = relative permittivity, σ = conductivity and $\rho = 1000 \text{ kg/m}^3$)

5.3. Tissue Calibration Result

The dielectric parameters of the liquids were verified prior to the SAR evaluation using SATIMO Dielectric Probe Kit and R&S Network Analyzer ZVL6.

Tissue Stimulant Measurement for 835MHz					
	Fr. (MHz)	Dielectric Parameters ($\pm 5\%$)		Tissue Temp [°C]	Test time
		ϵ_r 41.5 (39.425-43.575)	δ [s/m] 0.90(0.855-0.945)		
Head	824.2	42.36	0.88	21.5	Oct. 10,2018
	826.4	41.79	0.90		
	835	41.26	0.91		
	836.6	40.81	0.92		
	846.6	40.59	0.93		
	848.8	40.03	0.93		
	Body	Fr. (MHz)	Dielectric Parameters ($\pm 5\%$)		
		ϵ_r 55.20(52.44-57.96)	δ [s/m]0.97(0.9215-1.0185)		
824.2		56.18	0.94	21.7	Oct. 10,2018
826.4		55.69	0.95		
835		55.07	0.96		
836.6		54.73	0.97		
846.6		54.28	0.98		
848.8		53.99	0.98		

Tissue Stimulant Measurement for 1900MHz					
	Fr. (MHz)	Dielectric Parameters ($\pm 5\%$)		Tissue Temp [°C]	Test time
		ϵ_r 40.00(38.00-42.00)	δ [s/m]1.40(1.33-1.47)		
Head	1850.2	41.63	1.35	21.3	Oct. 12,2018
	1852.4	41.09	1.37		
	1880	40.76	1.39		
	1900	40.28	1.40		
	1907.6	39.85	1.41		
	1909.8	39.53	1.43		
	Body	Fr. (MHz)	Dielectric Parameters ($\pm 5\%$)		
		ϵ_r 53.30(50.635-55.965)	δ [s/m]1.52(1.444-1.596)		
1850.2		54.75	1.46	21.5	Oct. 12,2018
1852.4		54.23	1.50		
1880		53.69	1.51		
1900		53.07	1.53		
1907.6		52.55	1.55		
1909.8	52.13	1.57			

Tissue Stimulant Measurement for 2450MHz					
	Fr. (MHz)	Dielectric Parameters ($\pm 5\%$)		Tissue Temp [$^{\circ}\text{C}$]	Test time
		ϵ_r 39.2(37.24-41.16)	δ [s/m]1.80(1.71-1.89)		
Head	2412	40.81	1.77	21.3	Oct. 11,2018
	2437	40.22	1.80		
	2450	39.67	1.82		
	2462	39.15	1.85		
	Fr. (MHz)	Dielectric Parameters ($\pm 5\%$)		Tissue Temp [$^{\circ}\text{C}$]	Test time
		ϵ_r 52.7(50.065-55.335)	δ [s/m]1.95(1.8525-2.0475)		
Body	2412	54.75	1.88	21.5	Oct. 11,2018
	2437	54.31	1.90		
	2450	53.66	1.93		
	2462	53.14	1.95		

6. SAR SYSTEM CHECK PROCEDURE

6.1. SAR System Check Procedures

SAR system check is required to confirm measurement accuracy, according to the tissue dielectric media, probe calibration points and other system operating parameters required for measuring the SAR of a test device. The system verification must be performed for each frequency band and within the valid range of each probe calibration point required for testing the device. The same SAR probe(s) and tissue-equivalent media combinations used with each specific SAR system for system verification must be used for device testing. When multiple probe calibration points are required to cover substantially large transmission bands, independent system verifications are required for each probe calibration point. A system verification must be performed before each series of SAR measurements using the same probe calibration point and tissue-equivalent medium. Additional system verification should be considered according to the conditions of the tissue-equivalent medium and measured tissue dielectric parameters, typically every three to four days when the liquid parameters are remeasured or sooner when marginal liquid parameters are used at the beginning of a series of measurements.

Each SATIMO system is equipped with one or more system check kits. These units, together with the predefined measurement procedures within the SATIMO software, enable the user to conduct the system check and system validation. System kit includes a dipole, and dipole device holder.

The system check verifies that the system operates within its specifications. It's performed daily or before every SAR measurement. The system check uses normal SAR measurement in the flat section of the phantom with a matched dipole at a specified distance. The system check setup is shown as below.

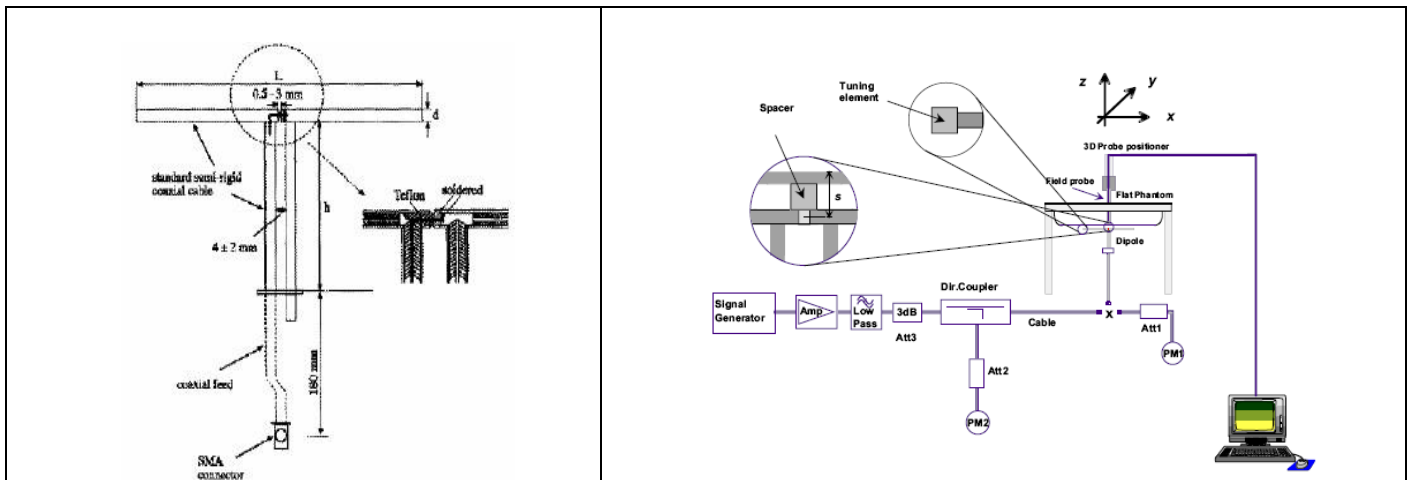

6.2. SAR System Check

6.2.1. Dipoles

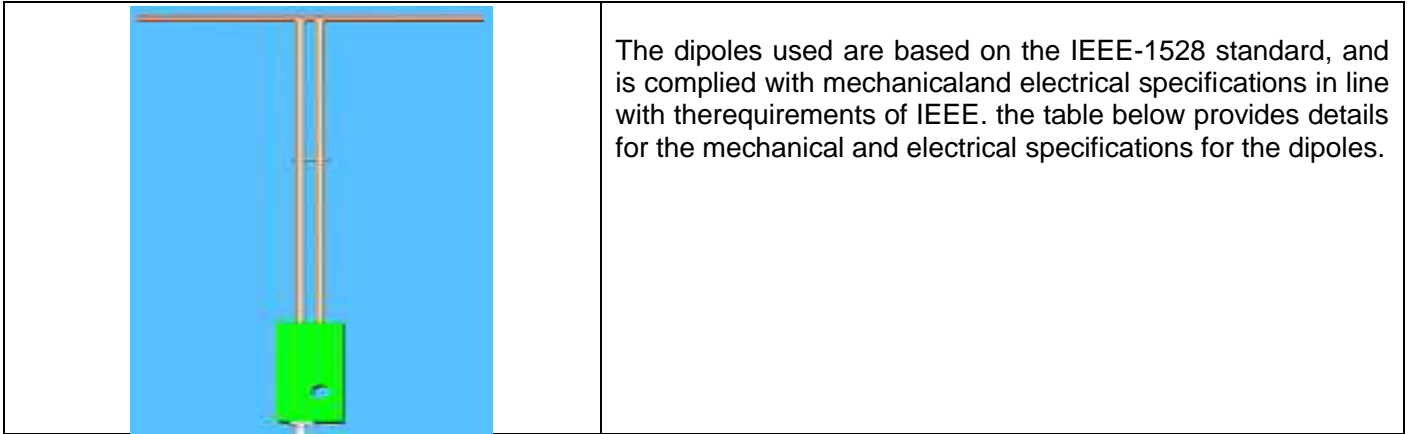

Frequency	L (mm)	h (mm)	d (mm)
835MHz	161.0	89.8	3.6
1900MHz	68	39.5	3.6
2450MHz	51.5	30.4	3.6

6.2.2. System Check Result

System Performance Check at 835MHz & 1900MHz & 2450MHz for Head									
Validation Kit: SN29/15 DIP 0G835-383 & SN 29/15 DIP 1G900-389 & SN 29/15 DIP 2G450-393									
Frequency [MHz]	Target Value (W/Kg)		Reference Result ($\pm 10\%$)		Tested Value (W/Kg)		Tissue Temp. [°C]	Test time	
	1g	10g	1g	10g	1g	10g			
835	10.04	6.43	9.036-11.044	5.787-7.073	9.59	6.00	21.5	Oct. 10, 2018	
1900	41.44	21.33	37.296-45.584	19.197-23.463	38.03	19.40	21.3	Oct. 12, 2018	
2450	54.53	24.30	49.077-59.983	21.87-26.730	51.72	24.08	21.3	Oct. 11, 2018	
System Performance Check at 835 MHz & 1900MHz & 2450MHz for Body									
Frequency [MHz]	Target Value (W/Kg)		Reference Result ($\pm 10\%$)		Tested Value (W/Kg)		Tissue Temp. [°C]	Test time	
	1g	10g	1g	10g	1g	10g			
835	9.85	6.45	8.865-10.835	5.805-7.095	9.67	5.95	21.7	Oct. 10, 2018	
1900	39.38	20.86	35.442-43.318	18.774-22.946	36.88	18.78	21.5	Oct. 12, 2018	
2450	49.92	23.16	44.928-54.912	20.844-25.476	51.14	23.77	21.5	Oct. 11, 2018	

Note:

(1) We use a CW signal of 18dBm for system check, and then all SAR values are normalized to 1W forward power. The result must be within $\pm 10\%$ of target value.

7. EUT TEST POSITION

This EUT was tested in **Right Cheek, Right Tilted, Left Cheek, Left Tilted, Body back, Body front and 4 edges.**

7.1. Define Two Imaginary Lines on the Handset

- (1) The vertical centerline passes through two points on the front side of the handset: the midpoint of the width w_t of the handset at the level of the acoustic output, and the midpoint of the width w_b of the handset.
- (2) The horizontal line is perpendicular to the vertical centerline and passes through the center of the acoustic output. The horizontal line is also tangential to the face of the handset at point A.
- (3) The two lines intersect at point A. Note that for many handsets, point A coincides with the center of the acoustic output; however, the acoustic output may be located elsewhere on the horizontal line. Also note that the vertical centerline is not necessarily to the front face of the handset, especially for clamshell handsets, handsets with flip covers, and other irregularly shaped handsets.

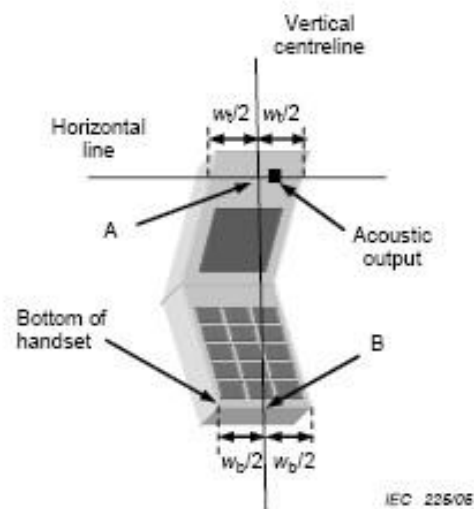
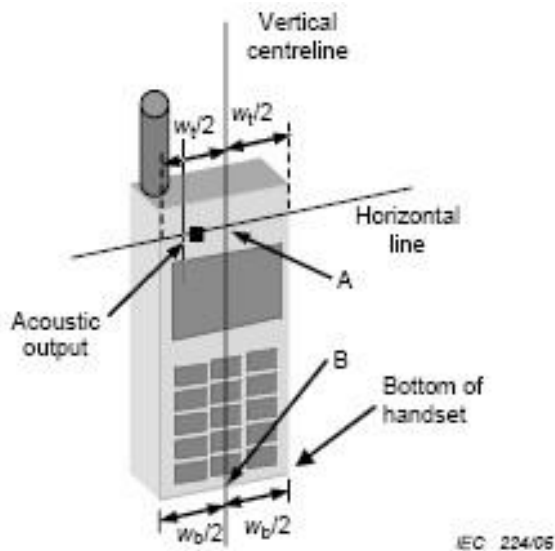

7.2. Cheek Position

- (1) To position the device with the vertical center line of the body of the device and the horizontal line crossing the center piece in a plane parallel to the sagittal plane of the phantom. While maintaining the device in this plane, align the vertical center line with the reference plane containing the ear and mouth reference point (M: Mouth, RE: Right Ear, and LE: Left Ear) and align the center of the ear piece with the line RE-LE.
- (2) To move the device towards the phantom with the ear piece aligned with the the line LE-RE until the phone touched the ear. While maintaining the device in the reference plane and maintaining the phone contact with ear, move the bottom of the phone until any point on the front side is in contact with the cheek of the phantom or until contact with the ear is lost



7.3. Tilt Position

- (1) To position the device in the “cheek” position described above.
- (2) While maintaining the device in the reference plane described above and pivoting against the ear, moves it outward away from the mouth by an angle of 15 degrees or until with the ear is lost.



7.4. Body Worn Position

- (1) To position the EUT parallel to the phantom surface.
- (2) To adjust the EUT parallel to the flat phantom.
- (3) To adjust the distance between the EUT surface and the flat phantom to **10mm**.

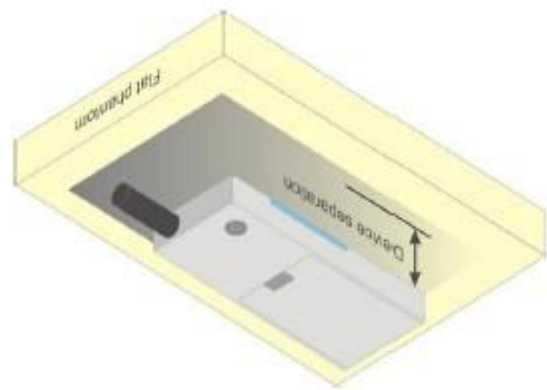
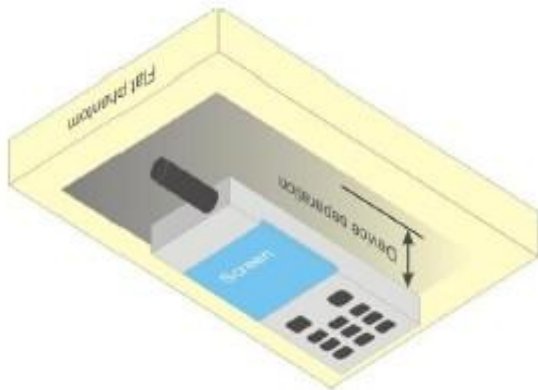

8. SAR EXPOSURE LIMITS

Limits for General Population/Uncontrolled Exposure (W/kg)

Type Exposure	Uncontrolled Environment Limit (W/kg)
Spatial Peak SAR (1g cube tissue for brain or body)	1.60
Spatial Average SAR (Whole body)	0.08
Spatial Peak SAR (Limbs)	4.0

9. TEST FACILITY

Test Site	Attestation of Global Compliance (Shenzhen) Co., Ltd
Location	1-2F., Bldg.2, No.1-4, ChaxiSanwei Technical Industrial Park, Gushu, Xixiang, Bao'an District B112-B113, Shenzhen 518012
NVLAP Lab Code	600153-0
Designation Number	CN5028
Test Firm Registration Number	682566
Description	Attestation of Global Compliance(Shenzhen) Co., Ltd is accredited by National Voluntary Laboratory Accreditation program, NVLAP Code 600153-0

10. TEST EQUIPMENT LIST

Equipment description	Manufacturer/ Model	Identification No.	Current calibration date	Next calibration date
SAR Probe	MVG	SN 22/12 EP159	Aug. 08,2018	Aug. 07,2019
Phantom	SATIMO	SN_4511_SAM90	Validated. No cal required.	Validated. No cal required.
Liquid	SATIMO	-	Validated. No cal required.	Validated. No cal required.
Comm Tester	Agilent-8960	GB46310822	Mar. 01,2018	Feb. 28,2019
Multimeter	Keithley 2000	1188656	Mar. 01,2018	Feb. 28,2019
Dipole	SATIMO SID835	SN29/15 DIP 0G835-383	July 05,2016	July 04,2019
Dipole	SATIMO SID1900	SN 29/15 DIP 1G900-389	July 05,2016	July 04,2019
Dipole	SATIMO SID2450	SN29/15 DIP 2G450-393	July 05,2016	July 04,2019
Signal Generator	Agilent-E4438C	US41461365	Mar. 01,2018	Feb. 28,2019
Vector Analyzer	Agilent / E4440A	US41421290	Mar. 01,2018	Feb. 28,2019
Network Analyzer	Rhode & Schwarz ZVL6	SN100132	Mar. 01,2018	Feb. 28,2019
Attenuator	Warison/WATT-6SR 1211	N/A	N/A	N/A
Attenuator	Mini-circuits / VAT-10+	N/A	N/A	N/A
Amplifier	EM30180	SN060552	Mar. 01,2018	Feb. 28,2019
Directional Couple	Werlatone/ C5571-10	SN99463	June 12,2018	June 11,2019
Directional Couple	Werlatone/ C6026-10	SN99482	June 12,2018	June 11,2019
Power Sensor	NRP-Z21	1137.6000.02	Sep. 20,2018	Sep. 19,2019
Power Sensor	NRP-Z23	US38261498	Mar. 01,2018	Feb. 28,2019
Power Viewer	R&S	V2.3.1.0	N/A	N/A

Note: Per KDB 865664 Dipole SAR Validation, AGC Lab has adopted 3 years calibration intervals. On annual basis, every measurement dipole has been evaluated and is in compliance with the following criteria:

1. There is no physical damage on the dipole;
2. System validation with specific dipole is within 10% of calibrated value;
3. Return-loss is within 20% of calibrated measurement;
4. Impedance is within 5Ω of calibrated measurement.

11. MEASUREMENT UNCERTAINTY

Measurement uncertainty for Dipole averaged over 1 gram / 10 gram.									
a	b	c	d	^e f(d,k)	f	g	^h cx _f /e	ⁱ cx _g /e	k
Uncertainty Component	Sec.	Tol (± %)	Prob. Dist.	Div.	Ci (1g)	Ci (10g)	1g U _i (±%)	10g U _i (±%)	v _i
Measurement System									
Probe calibration	E.2.1	5.831	N	1	1	1	5.83	5.83	∞
Axial Isotropy	E.2.2	0.579	R	$\sqrt{3}$	$\sqrt{0.5}$	$\sqrt{0.5}$	0.24	0.24	∞
Hemispherical Isotropy	E.2.2	0.813	R	$\sqrt{3}$	$\sqrt{0.5}$	$\sqrt{0.5}$	0.33	0.33	∞
Boundary effect	E.2.3	1.0	R	$\sqrt{3}$	1	1	0.58	0.58	∞
Linearity	E.2.4	1.26	R	$\sqrt{3}$	1	1	0.73	0.73	∞
System detection limits	E.2.4	1.0	R	$\sqrt{3}$	1	1	0.58	0.58	∞
Modulation response	E.2.5	3.0	R	$\sqrt{3}$	1	1	1.73	1.73	∞
Readout Electronics	E.2.6	0.021	N	1	1	1	0.021	0.021	∞
Response Time	E.2.7	0	R	$\sqrt{3}$	1	1	0	0	∞
Integration Time	E.2.8	1.4	R	$\sqrt{3}$	1	1	0.81	0.81	∞
RF ambient conditions-Noise	E.6.1	3.0	R	$\sqrt{3}$	1	1	1.73	1.73	∞
RF ambient conditions-reflections	E.6.1	3.0	R	$\sqrt{3}$	1	1	1.73	1.73	∞
Probe positioner mechanical tolerance	E.6.2	1.4	R	$\sqrt{3}$	1	1	0.81	0.81	∞
Probe positioning with respect to phantom shell	E.6.3	1.4	R	$\sqrt{3}$	1	1	0.81	0.81	∞
Extrapolation, interpolation, and integrations algorithms for max. SAR evaluation	E.5	2.3	R	$\sqrt{3}$	1	1	1.33	1.33	∞
Test sample Related									
Test sample positioning	E.4.2	2.6	N	1	1	1	2.6	2.6	∞
Device holder uncertainty	E.4.1	3	N	1	1	1	3	3	∞
Output power variation—SAR drift measurement	E.2.9	5	R	$\sqrt{3}$	1	1	2.89	2.89	∞
SAR scaling	E.6.5	5	R	$\sqrt{3}$	1	1	2.89	2.89	∞
Phantom and tissue parameters									
Phantom shell uncertainty—shape, thickness, and permittivity	E.3.1	4	R	$\sqrt{3}$	1	1	2.31	2.31	∞
Uncertainty in SAR correction for deviations in permittivity and conductivity	E.3.2	1.9	N	1	1	0.84	1.90	1.60	∞
Liquid conductivity measurement	E.3.3	4	N	1	0.78	0.71	3.12	2.84	M
Liquid permittivity measurement	E.3.3	5	N	1	0.23	0.26	1.15	1.30	M
Liquid conductivity—temperature uncertainty	E.3.4	2.5	R	$\sqrt{3}$	0.78	0.71	1.13	1.02	∞
Liquid permittivity—temperature uncertainty	E.3.4	2.5	R	$\sqrt{3}$	0.23	0.26	0.33	0.38	∞
Combined Standard Uncertainty			RSS				9.807	9.608	
Expanded Uncertainty (95% Confidence interval)			K=2				19.614	19.216	

System Validation uncertainty for Dipole averaged over 1 gram / 10 gram.									
a	b	c	d	^e f(d,k)	f	g	^h cx _f /e	ⁱ cx _g /e	k
Uncertainty Component	Sec.	Tol (±%)	Prob. Dist.	Div.	Ci (1g)	Ci (10g)	1g U _i (±%)	10g U _i (±%)	v _i
Measurement System									
Probe calibration	E.2.1	5.831	N	1	1	1	5.83	5.83	∞
Axial Isotropy	E.2.2	0.579	R	$\sqrt{3}$	1	1	0.33	0.33	∞
Hemispherical Isotropy	E.2.2	0.813	R	$\sqrt{3}$	0	0	0.00	0.00	∞
Boundary effect	E.2.3	1.0	R	$\sqrt{3}$	1	1	0.58	0.58	∞
Linearity	E.2.4	1.26	R	$\sqrt{3}$	1	1	0.73	0.73	∞
System detection limits	E.2.4	1.0	R	$\sqrt{3}$	1	1	0.58	0.58	∞
Modulation response	E.2.5	3.0	R	$\sqrt{3}$	0	0	0.00	0.00	∞
Readout Electronics	E.2.6	0.021	N	1	1	1	0.021	0.021	∞
Response Time	E.2.7	0.0	R	$\sqrt{3}$	0	0	0.00	0.00	∞
Integration Time	E.2.8	1.4	R	$\sqrt{3}$	0	0	0.00	0.00	∞
RF ambient conditions-Noise	E.6.1	3.0	R	$\sqrt{3}$	1	1	1.73	1.73	∞
RF ambient conditions-reflections	E.6.1	3.0	R	$\sqrt{3}$	1	1	1.73	1.73	∞
Probe positioner mechanical tolerance	E.6.2	1.4	R	$\sqrt{3}$	1	1	0.81	0.81	∞
Probe positioning with respect to phantom shell	E.6.3	1.4	R	$\sqrt{3}$	1	1	0.81	0.81	∞
Extrapolation, interpolation, and integrations algorithms for max. SAR evaluation	E.5	2.3	R	$\sqrt{3}$	1	1	1.33	1.33	∞
System check source (dipole)									
Deviation of experimental dipole from numerical dipole	E.6.4	5.0	N	1	1	1	5.00	5.00	∞
Input power and SAR drift measurement	8,6.6.4	5.0	R	$\sqrt{3}$	1	1	2.89	2.89	∞
Dipole axis to liquid distance	8,E.6.6	2.0	R	$\sqrt{3}$	1	1	1.15	1.15	∞
Phantom and tissue parameters									
Phantom shell uncertainty—shape, thickness, and permittivity	E.3.1	4.0	R	$\sqrt{3}$	1	1	2.31	2.31	∞
Uncertainty in SAR correction for deviations in permittivity and conductivity	E.3.2	1.9	N	1	1	0.84	1.90	1.60	∞
Liquid conductivity measurement	E.3.3	4.0	N	1	0.78	0.71	3.12	2.84	M
Liquid permittivity measurement	E.3.3	5.0	N	1	0.23	0.26	1.15	1.30	M
Liquid conductivity—temperature uncertainty	E.3.4	2.5	R	$\sqrt{3}$	0.78	0.71	1.13	1.02	∞
Liquid permittivity—temperature uncertainty	E.3.4	2.5	R	$\sqrt{3}$	0.23	0.26	0.33	0.38	∞
Combined Standard Uncertainty			RSS				9.735	9.534	
Expanded Uncertainty (95% Confidence interval)			K=2				19.470	19.069	

System check uncertainty for Dipole averaged over 1 gram / 10 gram.									
a	b	c	d	e f(d,k)	f	g	h cx _f /e	i cx _g /e	k
Uncertainty Component	Sec.	Tol (± %)	Prob. Dist.	Div.	Ci (1g)	Ci (10g)	1g U _i (±%)	10g U _i (±%)	v _i
Measurement System									
Probe calibration drift	E.2.1.3	0.5	N	1	1	1	0.50	0.50	∞
Axial Isotropy	E.2.2	0.579	R	$\sqrt{3}$	0	0	0.00	0.00	∞
Hemispherical Isotropy	E.2.2	0.813	R	$\sqrt{3}$	0	0	0.00	0.00	∞
Boundary effect	E.2.3	1.0	R	$\sqrt{3}$	0	0	0.00	0.00	∞
Linearity	E.2.4	1.26	R	$\sqrt{3}$	0	0	0.00	0.00	∞
System detection limits	E.2.4	1.0	R	$\sqrt{3}$	0	0	0.00	0.00	∞
Modulation response	E.2.5	3.0	R	$\sqrt{3}$	0	0	0.00	0.00	∞
Readout Electronics	E.2.6	0.021	N	1	0	0	0.00	0.00	∞
Response Time	E.2.7	0	R	$\sqrt{3}$	0	0	0.00	0.00	∞
Integration Time	E.2.8	1.4	R	$\sqrt{3}$	0	0	0.00	0.00	∞
RF ambient conditions-Noise	E.6.1	3.0	R	$\sqrt{3}$	0	0	0.00	0.00	∞
RF ambient conditions-reflections	E.6.1	3.0	R	$\sqrt{3}$	0	0	0.00	0.00	∞
Probe positioner mechanical tolerance	E.6.2	1.4	R	$\sqrt{3}$	1	1	0.81	0.81	∞
Probe positioning with respect to phantom shell	E.6.3	1.4	R	$\sqrt{3}$	1	1	0.81	0.81	∞
Extrapolation, interpolation, and integrations algorithms for max. SAR evaluation	E.5	2.3	R	$\sqrt{3}$	0	0	0.00	0.00	∞
System check source (dipole)									
Deviation of experimental dipoles	E.6.4	2	N	1	1	1	2	2	∞
Input power and SAR drift measurement	8,6.6.4	5	R	$\sqrt{3}$	1	1	2.89	2.89	∞
Dipole axis to liquid distance	8,E.6.6	2	R	$\sqrt{3}$	1	1	1.15	1.15	∞
Phantom and tissue parameters									
Phantom shell uncertainty—shape, thickness, and permittivity	E.3.1	4	R	$\sqrt{3}$	1	1	2.31	2.31	∞
Uncertainty in SAR correction for deviations in permittivity and conductivity	E.3.2	1.9	N	1	1	0.84	1.90	1.60	∞
Liquid conductivity measurement	E.3.3	4	N	1	0.78	0.71	3.12	2.84	M
Liquid permittivity measurement	E.3.3	5	N	1	0.23	0.26	1.15	1.30	M
Liquid conductivity—temperature uncertainty	E.3.4	2.5	R	$\sqrt{3}$	0.78	0.71	1.13	1.02	∞
Liquid permittivity—temperature uncertainty	E.3.4	2.5	R	$\sqrt{3}$	0.23	0.26	0.33	0.38	∞
Combined Standard Uncertainty			RSS				5.564	5.205	
Expanded Uncertainty (95% Confidence interval)			K=2				11.128	10.410	

12. CONDUCTED POWER MEASUREMENT GSM BAND

Mode	Frequency(MHz)	Avg. Burst Power(dBm)	Duty cycle Factor(dBm)	Frame Power(dBm)
Maximum Power <1>				
GSM 850	824.2	31.44	-9	22.44
	836.6	31.52	-9	22.52
	848.8	31.34	-9	22.34
GPRS 850 (1 Slot)	824.2	31.25	-9	22.25
	836.6	31.28	-9	22.28
	848.8	31.34	-9	22.34
GPRS 850 (2 Slot)	824.2	28.42	-6	22.42
	836.6	28.19	-6	22.19
	848.8	28.27	-6	22.27
GPRS 850 (3 Slot)	824.2	26.33	-4.26	22.07
	836.6	26.42	-4.26	22.16
	848.8	26.35	-4.26	22.09
GPRS 850 (4 Slot)	824.2	25.28	-3	22.28
	836.6	25.22	-3	22.22
	848.8	25.38	-3	22.38
Maximum Power <2>				
GSM 850	824.2	30.86	-9	21.86
	836.6	30.98	-9	21.98
	848.8	30.77	-9	21.77
GPRS 850 (1 Slot)	824.2	30.56	-9	21.56
	836.6	30.61	-9	21.61
	848.8	30.55	-9	21.55
GPRS 850 (2 Slot)	824.2	28.37	-6	22.37
	836.6	28.12	-6	22.12
	848.8	28.25	-6	22.25
GPRS 850 (3 Slot)	824.2	26.31	-4.26	22.05
	836.6	26.38	-4.26	22.12
	848.8	26.32	-4.26	22.06
GPRS 850 (4 Slot)	824.2	25.22	-3	22.22
	836.6	25.16	-3	22.16
	848.8	25.31	-3	22.31

GSM BAND CONTINUE

Mode	Frequency(MHz)	Avg. Burst Power(dBm)	Duty cycle Factor(dBm)	Frame Power(dBm)
Maximum Power <1>				
PCS1900	1850.2	28.69	-9	19.69
	1880	28.54	-9	19.54
	1909.8	28.46	-9	19.46
GPRS1900 (1 Slot)	1850.2	27.28	-9	18.28
	1880	27.17	-9	18.17
	1909.8	27.37	-9	18.37
GPRS1900 (2 Slot)	1850.2	24.42	-6	18.42
	1880	24.25	-6	18.25
	1909.8	24.54	-6	18.54
GPRS1900 (3 Slot)	1850.2	23.39	-4.26	19.13
	1880	23.47	-4.26	19.21
	1909.8	23.56	-4.26	19.30
GPRS1900 (4 Slot)	1850.2	22.74	-3	19.74
	1880	22.58	-3	19.58
	1909.8	22.55	-3	19.55
Maximum Power <2>				
PCS1900	1850.2	28.13	-9	19.13
	1880	28.50	-9	19.50
	1909.8	28.42	-9	19.42
GPRS1900 (1 Slot)	1850.2	27.22	-9	18.22
	1880	27.15	-9	18.15
	1909.8	27.34	-9	18.34
GPRS1900 (2 Slot)	1850.2	24.40	-6	18.40
	1880	24.21	-6	18.21
	1909.8	24.47	-6	18.47
GPRS1900 (3 Slot)	1850.2	23.33	-4.26	19.07
	1880	23.42	-4.26	19.16
	1909.8	23.51	-4.26	19.25
GPRS1900 (4 Slot)	1850.2	22.72	-3	19.72
	1880	22.53	-3	19.53
	1909.8	22.50	-3	19.50

Note 1:

The Frame Power (Source-based time-averaged Power) is scaled the maximum burst average power based on time slots. The calculated methods are show as following:

Frame Power = Max burst power (1 Up Slot) – 9 dB

Frame Power = Max burst power (2 Up Slot) – 6 dB

Frame Power = Max burst power (3 Up Slot) – 4.26 dB

Frame Power = Max burst power (4 Up Slot) – 3 dB

UMTS BAND

HSDPA Setup Configuration:

- The EUT was connected to Base Station Agilent E5515C referred to the Setup Configuration.
- The RF path losses were compensated into the measurements.
- A call was established between EUT and Based Station with following setting:
 - (1) Set Gain Factors(β_c and β_d)parameters set according to each
 - (2) Set RMC 12.2Kbps+HSDPA mode.
 - (3) Set Cell Power=-86dBm
 - (4) Set HS-DSCH Configuration Type to FRC(H-set 1,QPSK)
 - (5) Select HSDPA Uplink Parameters
 - (6) Set Delta ACK, Delta NACK and Delta CQI=8
 - (7) Set Ack - Nack Repetition Factor to 3
 - (8) Set CQI Feedback Cycle(k) to 4ms
 - (9) Set CQI Repetition Factor to 2
 - (10) Power Ctrl Mode=All Up bits
- The transmitted maximum output power was recorded.

Table C.10.2.4: β values for transmitter characteristics tests with HS-DPCCH

Sub-test	β_c (Note5)	β_d	β_d (SF)	β_c/β_d	β_{HS} (Note1, Note 2)	CM (dB) (Note 3)	MPR (dB) (Note 3)
1	2/15	15/15	64	2/15	4/15	0.0	0.0
2	12/15(Note 4)	15/15(Note 4)	64	12/15(Note 4)	24/15	1.0	0.0
3	15/15	8/15	64	15/8	30/15	1.5	0.5
4	15/15	4/15	64	15/4	30/15	1.5	0.5

Note 1: $\Delta ACK, \Delta NACK$ and $\Delta CQI = 30/15$ with $\beta_{hs} = 30/15 * \beta_c$.

Note 2: For the HS-DPCCH power mask requirement test in clause 5.2C, 5.7A, and the Error Vector Magnitude (EVM) with HS-DPCCH test in clause 5.13.1A, and HSDPA EVM with phase discontinuity in clause 5.13.1AA, ΔACK and $\Delta NACK = 30/15$ with $\beta_{hs} = 30/15 * \beta_c$, and $\Delta CQI = 24/15$ with $\beta_{hs} = 24/15 * \beta_c$.

Note 3: CM = 1 for $\beta_c/\beta_d = 12/15$, $hs/c = 24/15$. For all other combinations of DPDCH, DPCCH and HS-DPCCH the MPR is based on the relative CM difference. This is applicable for only UEs that support HSDPA in release 6 and later releases.

Note 4: For subtest 2 the c/d ratio of 12/15 for the TFC during the measurement period (TF1, TF0) is achieved by setting the signalled gain factors for the reference TFC (TF1, TF1) to $c = 11/15$ and $d = 15/15$.

HSUPA Setup Configuration:

- The EUT was connected to Base Station Agilent E5515C referred to the Setup Configuration.
- The RF path losses were compensated into the measurements.
- A call was established between EUT and Base Station with following setting * :
 - (1) Call Configs = 5.2B, 5.9B, 5.10B, and 5.13.2B with QPSK
 - (2) Set the Gain Factors (β_c and β_d) and parameters (AG Index) were set according to each specific sub-test in the following table, C11.1.3, quoted from the TS 34.121
 - (3) Set Cell Power = -86 dBm
 - (4) Set Channel Type = 12.2k + HSPA
 - (5) Set UE Target Power
 - (6) Power Ctrl Mode= Alternating bits
 - (7) Set and observe the E-TFCI
 - (8) Confirm that E-TFCI is equal to the target E-TFCI of 75 for sub-test 1, and other subtest's E-TFCI
- The transmitted maximum output power was recorded.

Table C.11.1.3: β values for transmitter characteristics tests with HS-DPCCH and E-DCH

Sub-test	β_c	β_d	β_d (SF)	β_c/β_d	β_{HS} (Note 1)	β_{ec}	β_{ed} (Note 4) (Note 5)	β_{ed} (SF)	β_{ed} (Code s)	CM (dB) (Note 2)	MPR (dB) (Note 2) (Note 6)	AG Index (Note 5)	E-TF CI
1	11/15 (Note 3)	15/15 (Note 3)	64	11/15 (Note 3)	22/15	209/225	1309/225	4	1	1.0	0.0	20	75
2	6/15	15/15	64	6/15	12/15	12/15	94/75	4	1	3.0	2.0	12	67
3	15/15	9/15	64	15/9	30/15	30/15	β_{ed1} : 47/15 β_{ed2} : 47/15	4 4	2	2.0	1.0	15	92
4	2/15	15/15	64	2/15	4/15	2/15	56/75	4	1	3.0	2.0	17	71
5	15/15	0	-	-	5/15	5/15	47/15	4	1	1.0	0.0	12	67

Note 1: For sub-test 1 to 4, ΔACK , $\Delta NACK$ and $\Delta CQI = 30/15$ with $\beta_{hs} = 30/15 * \beta_c$. For sub-test 5, ΔACK , $\Delta NACK$ and $\Delta CQI = 5/15$ with $\beta_{hs} = 5/15 * \beta_c$.

Note 2: CM = 1 for $\beta_c/\beta_d = 12/15$, $hs/c = 24/15$. For all other combinations of DPDCH, DPCCH, HS-DPCCH, E-DPDCH and E-DPCCH the MPR is based on the relative CM difference.

Note 3: For subtest 1 the c/d ratio of 11/15 for the TFC during the measurement period (TF1, TF0) is achieved by setting the signalled gain factors for the reference TFC (TF1, TF1) to $c = 10/15$ and $d = 15/15$.

Note 4: In case of testing by UE using E-DPDCH Physical Layer category 1, Sub-test 3 is omitted according to TS25.306 Table 5.1g.

Note 5: β_{ed} cannot be set directly; it is set by Absolute Grant Value.

Note 6: For subtests 2, 3 and 4, UE may perform E-DPDCH power scaling at max power which could results in slightly smaller MPR values.

UMTS BAND II

Mode	Frequency (MHz)	Avg. Burst Power (dBm)
WCDMA 1900 RMC	1852.4	22.11
	1880	22.36
	1907.6	22.28
WCDMA 1900 AMR	1852.4	22.18
	1880	22.23
	1907.6	22.12
HSDPA Subtest 1	1852.4	21.56
	1880	21.47
	1907.6	21.48
HSDPA Subtest 2	1852.4	20.33
	1880	20.26
	1907.6	20.28
HSDPA Subtest 3	1852.4	20.05
	1880	20.11
	1907.6	20.10
HSDPA Subtest 4	1852.4	20.53
	1880	20.49
	1907.6	20.58
HSUPA Subtest 1	1852.4	20.44
	1880	20.39
	1907.6	20.43
HSUPA Subtest 2	1852.4	21.00
	1880	21.06
	1907.6	21.33
HSUPA Subtest 3	1852.4	21.58
	1880	21.47
	1907.6	21.61
HSUPA Subtest 4	1852.4	21.53
	1880	22.47
	1907.6	22.33
HSUPA Subtest 5	1852.4	21.17
	1880	21.28
	1907.6	21.23

UMTS BAND V

Mode	Frequency (MHz)	Avg. Burst Power (dBm)
WCDMA 850 RMC	826.4	21.58
	836.6	21.11
	846.6	21.72
WCDMA 850 AMR	826.4	21.18
	836.6	21.33
	846.6	21.15
HSDPA Subtest 1	826.4	20.14
	836.6	20.21
	846.6	20.27
HSDPA Subtest 2	826.4	19.95
	836.6	20.07
	846.6	20.03
HSDPA Subtest 3	826.4	20.62
	836.6	20.26
	846.6	20.50
HSDPA Subtest 4	826.4	20.62
	836.6	20.37
	846.6	20.51
HSUPA Subtest 1	826.4	20.53
	836.6	21.52
	846.6	20.97
HSUPA Subtest 2	826.4	20.85
	836.6	20.99
	846.6	21.00
HSUPA Subtest 3	826.4	20.87
	836.6	20.61
	846.6	20.66
HSUPA Subtest 4	826.4	20.78
	836.6	20.32
	846.6	20.87
HSUPA Subtest 5	826.4	20.43
	836.6	20.51
	846.6	20.26

According to 3GPP 25.101 sub-clause 6.2.2 , the maximum output power is allowed to be reduced by following the table.

Table 6.1aA: UE maximum output power with HS-DPCCH and E-DCH

UE Transmit Channel Configuration	CM(db)	MPR(db)
For all combinations of ,DPDCH,DPCCH HS-DPDCH,E-DPDCH and E-DPCCH	$0 \leq CM \leq 3.5$	$MAX(CM-1,0)$
Note: CM=1 for $\beta_{d}/\beta_{d}=12/15, \beta_{hs}/\beta_{c}=24/15$. For all other combinations of DPDCH, DPCCH, HS-DPCCH, E-DPDCH and E-DPCCH the MPR is based on the relative CM difference.		

The device supports MPR to solve linearity issues (ACLR or SEM) due to the higher peak-to average ratios (PAR) of the HSUPA signal. This prevents saturating the full range of the TX DAC inside of device and provides a reduced power output to the RF transceiver chip according to the Cubic Metric (a function of the combinations of DPDCH, DPCCH, HS-DPCCH, E-DPDCH and E-DPCCH).

When E-DPDCH channels are present the beta gains on those channels are reduced firsts to try to get the power under the allowed limit. If the beta gains are lowered as far as possible, then a hard limiting is applied at the maximum allowed level.

The SW currently recalculates the cubic metric every time the beta gains on the E-DPDCH are reduced. The cubic metric will likely get lower each time this is done .However, there is no reported reduction of maximum output power in the HSUPA mode since the device also provides a compensation for the power back-off by increasing the gain of TX_AGC in the transceiver (PA) device.

The end effect is that the DUT output power is identical to the case where there is no MPR in the device.

WIFI

Mode	Data Rate (Mbps)	Channel	Frequency(MHz)	Avg. Burst Power(dBm)
802.11b	1	01	2412	13.98
		06	2437	14.11
		11	2462	14.18
802.11g	6	01	2412	10.38
		06	2437	12.04
		11	2462	12.23
802.11n(20)	6.5	01	2412	10.34
		06	2437	12.02
		11	2462	12.16
802.11n(40)	13.5	03	2422	8.23
		06	2437	7.86
		09	2452	8.04

Bluetooth_BR/EDR

Modulation	Channel	Frequency(MHz)	Peak Power (dBm)
GFSK	0	2402	1.105
	39	2441	0.388
	78	2480	-0.931
π /4-DQPSK	0	2402	0.409
	39	2441	-0.301
	78	2480	-1.909
8-DPSK	0	2402	-0.131
	39	2441	-0.854
	78	2480	-1.866

Bluetooth_BLE

Modulation	Channel	Frequency(MHz)	Peak Power (dBm)
GFSK	0	2402	-6.058
	19	2440	-6.551
	39	2480	-7.904

13. TEST RESULTS

13.1. SAR Test Results Summary

13.1.1. Test position and configuration

Head SAR was performed with the device configured in the positions according to IEEE 1528-2013, Body-worn and 4 Edges SAR was performed with the device 10mm from the phantom.

13.1.2. Operation Mode

1. Per KDB 447498 D01 v06 ,for each exposure position, if the highest 1-g SAR is ≤ 0.8 W/kg, testing for low and high channel is optional.
2. Per KDB 865664 D01 v01r04,for each frequency band, if the measured SAR is ≥ 0.8 W/Kg, testing for repeated SAR measurement is required , that the highest measured SAR is only to be tested. When the SAR results are near the limit,the following procedures are required for each device to verify these types of SAR measurement related variation concerns by repeating the highest measured SAR configuration in each frequency band.
 - (1) When the original highest measured SAR is ≥ 0.8 W/Kg, repeat that measurement once.
 - (2) Perform a second repeated measurement only if the ratio of largest to smallest SAR for the original and first repeated measurements is >1.20 or when the original or repeated measurement is ≥ 1.45 W/Kg.
 - (3) Perform a third repeated measurement only if the original, first and second repeated measurement is ≥ 1.5 W/Kg and ratio of largest to smallest SAR for the original, first and second measurement is ≥ 1.20 .
3. Body-worn exposure conditions are intended to voice call operations, therefore GSM voice call mode is selected to be test.
4. Per KDB 648474 D04 v01r03,when the reported SAR for a body-worn accessory measured without a headset connected to the handset is ≤ 1.2 W/Kg, SAR testing with a headset connected is not required.
5. Per KDB 248227 D01v02r02,for 2.4GHz 802.11g/n SAR testing is not required when the highest reported SAR for DSSS is adjusted by the ratio of OFDM to DSSS specified maximum output power and the adjusted SAR is ≤ 1.2 W/kg.
6. Per KDB 941225 D06 V02r01, when the same wireless mode transmission configurations for voice and data are required for SAR measurements, the more conservative configuration with a smaller separation distance should be tested for the overlapping SAR configurations.
7. Maximum Scaling SAR in order to calculate the Maximum SAR values to test under the standard Peak Power, Calculation method is as follows:
Maximum Scaling SAR = tested SAR (Max.) \times [maximum turn-up power (mw)/ maximum measurement output power(mw)]
8. Proximity sensor, just for avoiding the wrong operation in the phone screen when call, and has no influence on output power or SAR result

13.1.3. Test Result

SAR MEASUREMENT									
Depth of Liquid (cm):>15					Relative Humidity (%): 49.5				
Product: Smart Phone									
Test Mode: GSM850with GMSK modulation									
Position	Mode	Ch.	Fr. (MHz)	Power Drift (<±5%)	SAR (1g) (W/kg)	Max. Tune-up Power (dBm)	Meas. output Power (dBm)	Scaled SAR (W/Kg)	Limit (W/kg)
SIM 1 Card									
Left Cheek	voice	190	836.6	-0.39	0.449	32.00	31.52	0.501	1.6
Left Tilt	voice	190	836.6	-0.20	0.259	32.00	31.52	0.289	1.6
Right Cheek	voice	190	836.6	-0.08	0.470	32.00	31.52	0.525	1.6
Right Tilt	voice	190	836.6	0.24	0.277	32.00	31.52	0.309	1.6
Body back	voice	190	836.6	-0.17	0.549	32.00	31.52	0.613	1.6
Body front	voice	190	836.6	0.05	0.538	32.00	31.52	0.601	1.6
Body back	GPRS-2 slot	190	836.6	0.23	0.647	28.50	28.19	0.695	1.6
Body front	GPRS-2 slot	190	836.6	-0.06	0.592	28.50	28.19	0.636	1.6
Edge 2(Right)	GPRS-2 slot	190	836.6	0.27	0.318	28.50	28.19	0.342	1.6
Edge 3(Bottom)	GPRS-2 slot	190	836.6	-0.09	0.194	28.50	28.19	0.208	1.6
Edge 4(Left)	GPRS-2 slot	190	836.6	-0.11	0.319	28.50	28.19	0.343	1.6

Note:

- When the 1-g Reported SAR is ≤ 0.8 W/kg, testing for low and high channel is optional. Refer to KDB 447498.
- The test separation for body back, body front and 4 Edges is 10mm of all above table.

SAR MEASUREMENT									
Depth of Liquid (cm):>15					Relative Humidity (%): 51.6				
Product: Smart Phone									
Test Mode: PCS1900with GMSK modulation									
Position	Mode	Ch.	Fr. (MHz)	Power Drift (<±5%)	SAR (1g) (W/kg)	Max. Tune-up Power (dBm)	Meas. output Power (dBm)	Scaled SAR (W/Kg)	Limit (W/kg)
SIM 1 Card									
Left Cheek	voice	661	1880.0	-0.38	0.066	29.00	28.54	0.073	1.6
Left Tilt	voice	661	1880.0	-0.27	0.020	29.00	28.54	0.022	1.6
Right Cheek	voice	661	1880.0	-0.04	0.077	29.00	28.54	0.086	1.6
Right Tilt	voice	661	1880.0	0.19	0.013	29.00	28.54	0.014	1.6
Body back	voice	661	1880.0	-0.53	0.385	29.00	28.54	0.428	1.6
Body front	voice	661	1880.0	0.26	0.287	29.00	28.54	0.319	1.6
Body back	GPRS-4 slot	661	1880.0	-0.33	0.761	22.75	22.58	0.791	1.6
Body front	GPRS-4 slot	661	1880.0	0.17	0.666	22.75	22.58	0.693	1.6
Edge 2(Right)	GPRS-4 slot	661	1880.0	0.22	0.122	22.75	22.58	0.127	1.6
Edge 3(Bottom)	GPRS-4 slot	512	1850.2	-0.13	1.125	22.75	22.74	1.128	1.6
Edge 3(Bottom)	GPRS-4 slot	661	1880.0	-0.09	1.085	22.75	22.58	1.128	1.6
Edge 3(Bottom)	GPRS-4 slot	810	1909.8	0.53	1.050	22.75	22.55	1.099	1.6
Edge 4(Left)	GPRS-4 slot	661	1880.0	0.24	0.091	22.75	22.58	0.095	1.6

Note:

- When the 1-g Reported SAR is ≤ 0.8 W/kg, testing for low and high channel is optional. Refer to KDB 447498.
- The test separation for body back, body front and 4 Edges is 10mm of all above table.

SAR MEASUREMENT									
Depth of Liquid (cm):>15					Relative Humidity (%): 51.6				
Product: Smart Phone									
Test Mode: WCDMA Band II with QPSK modulation									
Position	Mode	Ch.	Fr. (MHz)	Power Drift (<±5%)	SAR (1g) (W/kg)	Max. Tune-up Power (dBm)	Meas. output Power (dBm)	Scaled SAR (W/Kg)	Limit (W/kg)
Left Cheek	RMC 12.2kbps	9400	1880	-0.33	0.128	22.50	22.36	0.132	1.6
Left Tilt	RMC 12.2kbps	9400	1880	-0.28	0.029	22.50	22.36	0.030	1.6
Right Cheek	RMC 12.2kbps	9400	1880	0.14	0.183	22.50	22.36	0.189	1.6
Right Tilt	RMC 12.2kbps	9400	1880	-0.07	0.025	22.50	22.36	0.026	1.6
Body back	RMC 12.2kbps	9400	1880	0.25	0.708	22.50	22.36	0.731	1.6
Body front	RMC 12.2kbps	9400	1880	-0.16	0.533	22.50	22.36	0.550	1.6
Edge 2(Right)	RMC 12.2kbps	9400	1880	-0.34	0.099	22.50	22.36	0.102	1.6
Edge 3(Bottom)	RMC 12.2kbps	9262	1852.4	0.17	0.976	22.50	22.11	1.068	1.6
Edge 3(Bottom)	RMC 12.2kbps	9400	1880	-0.08	0.924	22.50	22.36	0.954	1.6
Edge 3(Bottom)	RMC 12.2kbps	9538	1907.6	-0.22	0.848	22.50	22.28	0.892	1.6
Edge 4(Left)	RMC 12.2kbps	9400	1880	0.15	0.071	22.50	22.36	0.073	1.6

Note:

- When the 1-g Reported SAR is ≤ 0.8 W/kg, testing for low and high channel is optional. Refer to KDB 447498.
- The test separation for body back, body front and 4 Edges is 10mm of all above table.

SAR MEASUREMENT									
Depth of Liquid (cm):>15					Relative Humidity (%): 49.5				
Product: Smart Phone									
Test Mode: WCDMA Band V with QPSK modulation									
Position	Mode	Ch.	Fr. (MHz)	Power Drift (<±5%)	SAR (1g) (W/kg)	Max. Tune-up Power (dBm)	Meas. output Power (dBm)	Scaled SAR (W/Kg)	Limit (W/kg)
Left Cheek	RMC 12.2kbps	4183	836.6	-0.32	0.345	21.80	21.11	0.404	1.6
Left Tilt	RMC 12.2kbps	4183	836.6	-0.15	0.211	21.80	21.11	0.247	1.6
Right Cheek	RMC 12.2kbps	4183	836.6	0.28	0.355	21.80	21.11	0.416	1.6
Right Tilt	RMC 12.2kbps	4183	836.6	-0.17	0.263	21.80	21.11	0.308	1.6
Body back	RMC 12.2kbps	4183	836.6	-0.42	0.479	21.80	21.11	0.561	1.6
Body front	RMC 12.2kbps	4183	836.6	0.16	0.419	21.80	21.11	0.491	1.6
Edge 2(Right)	RMC 12.2kbps	4183	836.6	-0.23	0.228	21.80	21.11	0.267	1.6
Edge 3(Bottom)	RMC 12.2kbps	4183	836.6	-0.05	0.115	21.80	21.11	0.135	1.6
Edge 4(Left)	RMC 12.2kbps	4183	836.6	0.08	0.267	21.80	21.11	0.313	1.6

Note:

- When the 1-g Reported SAR is ≤ 0.8 W/kg, testing for low and high channel is optional. Refer to KDB 447498.
- The test separation for body back, body front and 4 Edges is 10mm of all above table.

SAR MEASUREMENT									
Depth of Liquid (cm):>15					Relative Humidity (%): 47.3				
Product: Smart Phone									
Test Mode:802.11b									
Position	Mode	Ch.	Fr. (MHz)	Power Drift (<±5%)	SAR (1g) (W/kg)	Max. Tune-up Power (dBm)	Meas. output Power (dBm)	Scaled SAR (W/Kg)	Limit (W/kg)
Left Cheek	DTS	6	2437	-0.13	0.020	14.18	14.11	0.020	1.6
Left Tilt	DTS	6	2437	0.15	0.020	14.18	14.11	0.020	1.6
Right Cheek	DTS	6	2437	-0.28	0.080	14.18	14.11	0.081	1.6
Right Tilt	DTS	6	2437	-0.14	0.045	14.18	14.11	0.046	1.6
Body back	DTS	6	2437	-0.17	0.335	14.18	14.11	0.340	1.6
Body front	DTS	6	2437	-0.06	0.034	14.18	14.11	0.035	1.6
Edge 1 (Top)	DTS	6	2437	0.23	0.023	14.18	14.11	0.023	1.6
Edge 4(Left)	DTS	6	2437	-0.28	0.048	14.18	14.11	0.049	1.6

Note:

- According to KDB248227, for 2.4GHz 802.11g/n SAR testing is not required when the highest reported SAR for DSSS is adjusted by the ratio of OFDM to DSSS specified maximum output power and the adjusted SAR is $\leq 1.2W/kg$.
- All of above "DTS" means data transmitters.
- The test separation for body back, body front and 4 Edges is 10mm of all above table.

Repeated SAR										
Product: Smart Phone										
Test Mode: PCS1900& WCDMA Band II										
Position	Mode	Ch.	Fr. (MHz)	Power Drift (<±5%)	Once SAR (1g) (W/kg)	Power Drift (<±5%)	Twice SAR (1g) (W/kg)	Power Drift (<±5%)	Third SAR (1g) (W/kg)	Limit (W/kg)
Edge 3(Bottom)	GPRS-4 slot	512	1850.2	-0.26	1.138	--	--	--	--	1.6
Edge 3(Bottom)	RMC 12.2kbps	9262	1852.4	-0.09	1.007	--	--	--	--	1.6

Simultaneous Multi-band Transmission Evaluation:
Application Simultaneous Transmission information:

NO	Simultaneous state	Portable Handset		
		Head	Body-worn	Hotspot
1	GSM(voice)+WLAN 2.4GHz (data)	Yes	Yes	-
2	GSM(voice)+Bluetooth(data)	-	Yes	-
3	GSM (Data) + WLAN 2.4GHz (data)	-	Yes	Yes
4	GSM (Data) + Bluetooth(data)	-	Yes	Yes
5	WCDMA+WLAN 2.4GHz (data)	Yes	Yes	Yes
6	WCDMA+Bluetooth(data)	-	Yes	Yes

NOTE:

1. WIFI and BT share the same antenna, and cannot transmit simultaneously.
2. Simultaneous with every transmitter must be the same test position.
3. KDB 447498 D01, BT SAR is excluded as below table.
4. KDB 447498 D01, for handsets the test separation distance is determined by the smallest distance between the outer surface of the device and the user; which is 0mm for head SAR and 10mm for body-worn SAR.
5. According to KDB 447498 D01 4.3.1, Standalone SAR test exclusion is as follow:
For 100 MHz to 6 GHz and test separation distances ≤ 50 mm, the 1-g and 10-g SAR test exclusion thresholds are determined by the following:

$$[(\text{max. power of channel, including tune-up tolerance, mW}) / (\text{min. test separation distance, mm})] \cdot [\sqrt{f(\text{GHz})}] \leq 3.0$$
for 1-g SAR, and ≤ 7.5 for 10-g extremity SAR³⁰, where
 - f(GHz) is the RF channel transmit frequency in GHz
 - Power and distance are rounded to the nearest mW and mm before calculation³¹
 - The result is rounded to one decimal place for comparison
 - The values 3.0 and 7.5 are referred to as numeric thresholds in step b) below
The test exclusions are applicable only when the minimum test separation distance is ≤ 50 mm, and for transmission frequencies between 100 MHz and 6 GHz. When the minimum test separation distance is < 5 mm, a distance of 5 mm according to 4.1 f) is applied to determine SAR test exclusion.
6. If the test separation distance is < 5 mm, 5mm is used for excluded SAR calculation.
7. According to KDB 447498 D01 4.3.2, simultaneous transmission SAR test exclusion is as follow:
 - (1) Simultaneous transmission SAR test exclusion is determined for each operating configuration and exposure condition according to the reported standalone SAR of each applicable simultaneous transmitting antenna.
 - (2) Any transmitters and antennas should be considered when calculating simultaneous mode.
 - (3) For mobile phone and PC, it's the sum of all transmitters and antennas at the same mode with same position in each applicable exposure condition
 - (4) When the standalone SAR test exclusion of section 4.3.2 is applied to an antenna that transmits simultaneously with other antennas, the standalone SAR must be estimated according to the following to det

$$[(\text{max. power of channel, including tune-up tolerance, mW}) / (\text{min. test separation distance, mm})] \cdot [\sqrt{f(\text{GHz})} / x] \text{ W/kg}$$
for test separation distances ≤ 50 mm;
where $x = 7.5$ for 1-g SAR, and $x = 18.75$ for 10-g SAR.

8. When the sum of SAR is larger than the limit, SAR test exclusion is determined by the SAR to peak location separation ratio. The simultaneous transmitting antennas in each operating mode and exposure condition combination must be considered one pair at a time to determine the SAR to peak location separation ratio to qualify for test exclusion. The ratio is determined by $(SAR1 + SAR2)1.5/R_i$, rounded to two decimal digits, and must be ≤ 0.04 for all antenna pairs in the configuration to qualify for 1-g SAR test exclusion.

Estimated SAR		Max Power including Tune-up Tolerance		Separation Distance (mm)	Estimated SAR (W/kg)
		dBm	mW		
BT	Head	2	1.585	0	0.066
	Body	2	1.585	10	0.033

Sum of the SAR for GSM 850 & Wi-Fi & BT:

RF Exposure Conditions	Test Position	Simultaneous Transmission Scenario			Σ1-g SAR (W/Kg)	SPLSR (Yes/No)
		GSM 850	Wi-Fi DTS Band	Bluetooth		
Head (voice)	Left Touch	0.501	0.020		0.521	No
	Left Tilt	0.289	0.020		0.309	No
	Right Touch	0.525	0.081		0.606	No
	Right Tilt	0.309	0.046		0.355	No
Body-worn (voice)	Rear	0.613	0.340		0.953	No
		0.613		0.033	0.646	No
	Front	0.601	0.035		0.636	No
		0.601		0.033	0.634	No
Body-worn (Data)	Rear	0.695		0.033	0.728	No
		0.695	0.340		1.035	No
	Front	0.636		0.033	0.669	No
		0.636	0.035		0.671	No
	Edge 4	0.343	0.049		0.392	No
	Edge 4	0.343		0.033	0.376	No

Note:

- According to KDB 447498 D01 General RF Exposure Guidance, when the simultaneous transmission SAR is less than 1.6 W/Kg, SPLSR assessment is not required.
- SPLSR mean is "The SAR to Peak Location Separation Ratio "

Sum of the SAR for PCS 1900 & Wi-Fi & BT:

RF Exposure Conditions	Test Position	Simultaneous Transmission Scenario			Σ1-g SAR (W/Kg)	SPLSR (Yes/No)
		GSM 1900	Wi-Fi DTS Band	Bluetooth		
Head (voice)	Left Touch	0.073	0.020		0.093	No
	Left Tilt	0.022	0.020		0.042	No
	Right Touch	0.086	0.081		0.167	No
	Right Tilt	0.014	0.046		0.060	No
Body-worn (voice)	Rear	0.428	0.340		0.768	No
		0.428		0.033	0.461	No
	Front	0.319	0.035		0.354	No
		0.319		0.033	0.352	No
Body-worn (Data)	Rear	0.791		0.033	0.824	No
		0.791	0.340		1.131	No
	Front	0.693		0.033	0.726	No
		0.693	0.035		0.728	No
	Edge 4	0.095	0.049		0.144	No
	Edge 4	0.095		0.033	0.128	No

Note:

- According to KDB 447498 D01 General RF Exposure Guidance, when the simultaneous transmission SAR is less than 1.6 W/Kg, SPLSR assessment is not required.
- SPLSR mean is "The SAR to Peak Location Separation Ratio "

Sum of the SAR for WCDMA Band II & Wi-Fi & BT:

RF Exposure Conditions	Test Position	Simultaneous Transmission Scenario			Σ1-g SAR (W/Kg)	SPLSR (Yes/No)
		WCDMA BandII	Wi-Fi DTS Band	Bluetooth		
Head	Left Touch	0.132	0.020		0.152	No
	Left Tilt	0.030	0.020		0.050	No
	Right Touch	0.189	0.081		0.270	No
	Right Tilt	0.026	0.046		0.072	No
Body-worn	Rear	0.731	0.340		1.071	No
	Front	0.550	0.035		0.585	No
	Edge 4	0.073	0.049		0.122	No
	Rear	0.731		0.033	0.764	No
	Front	0.550		0.033	0.583	No
	Edge 4	0.073		0.033	0.106	No

Note:

- According to KDB 447498 D01 General RF Exposure Guidance, when the simultaneous transmission SAR is less than 1.6 W/Kg, SPLSR assessment is not required.
- SPLSR mean is "The SAR to Peak Location Separation Ratio "

Sum of the SAR for WCDMA Band V & Wi-Fi & BT:

RF Exposure Conditions	Test Position	Simultaneous Transmission Scenario			Σ1-g SAR (W/Kg)	SPLSR (Yes/No)
		WCDMA BandV	Wi-Fi DTS Band	Bluetooth		
Head	Left Touch	0.404	0.020		0.424	No
	Left Tilt	0.247	0.020		0.267	No
	Right Touch	0.416	0.081		0.497	No
	Right Tilt	0.308	0.046		0.354	No
Body-worn	Rear	0.561	0.340		0.901	No
	Front	0.491	0.035		0.526	No
	Edge 4	0.313	0.049		0.362	No
	Rear	0.561		0.033	0.594	No
	Front	0.491		0.033	0.524	No
	Edge 4	0.313		0.033	0.346	No

Note:

- According to KDB 447498 D01 General RF Exposure Guidance, when the simultaneous transmission SAR is less than 1.6 W/Kg, SPLSR assessment is not required.
- SPLSR mean is "The SAR to Peak Location Separation Ratio "

APPENDIX A. SAR SYSTEM CHECK DATA

Test Laboratory: AGC Lab

Date: Oct. 10,2018

System Check Head 835 MHz

DUT: Dipole 835 MHz Type:SID 835

Communication System CW; Communication System Band: D835 (835.0 MHz); Duty Cycle: 1:1;Conv.F=5.29
Frequency: 835 MHz; Medium parameters used: $f = 835$ MHz; $\sigma = 0.91$ mho/m; $\epsilon_r = 41.26$; $\rho = 1000$ kg/m³ ;
Phantom section: Flat Section; Input Power=18dBm
Ambient temperature (°C):22.1, Liquid temperature (°C): 21.5

SATIMO Configuration

Probe: SSE5; Calibrated: Aug. 08,2018; Serial No.: SN 22/12 EP159

Sensor-Surface: 4mm (Mechanical Surface Detection)

Phantom: SAM twin phantom

Measurement SW: OpenSAR V4_02_32

Configuration/System Check 835MHz Head/Area Scan: Measurement grid: dx=8mm, dy=8mm

Configuration/System Check 835MHz Head/Zoom Scan: Measurement grid: dx=8mm,dy=8mm, dz=5mm

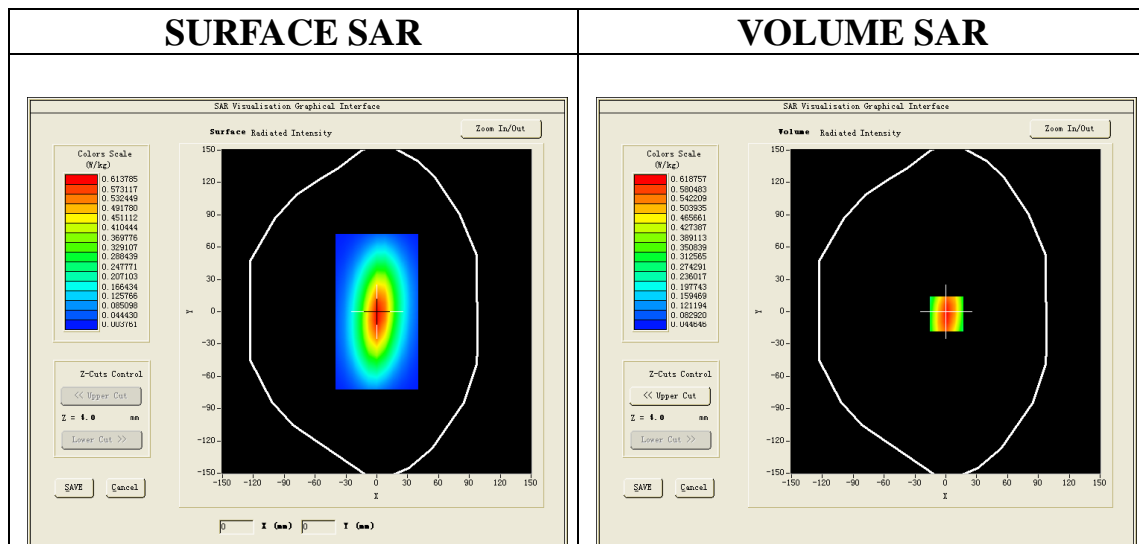

Maximum location: X=1.00, Y=-2.00

SAR Peak: 0.90 W/kg

SAR 10g (W/Kg)	0.378412
SAR 1g (W/Kg)	0.605348

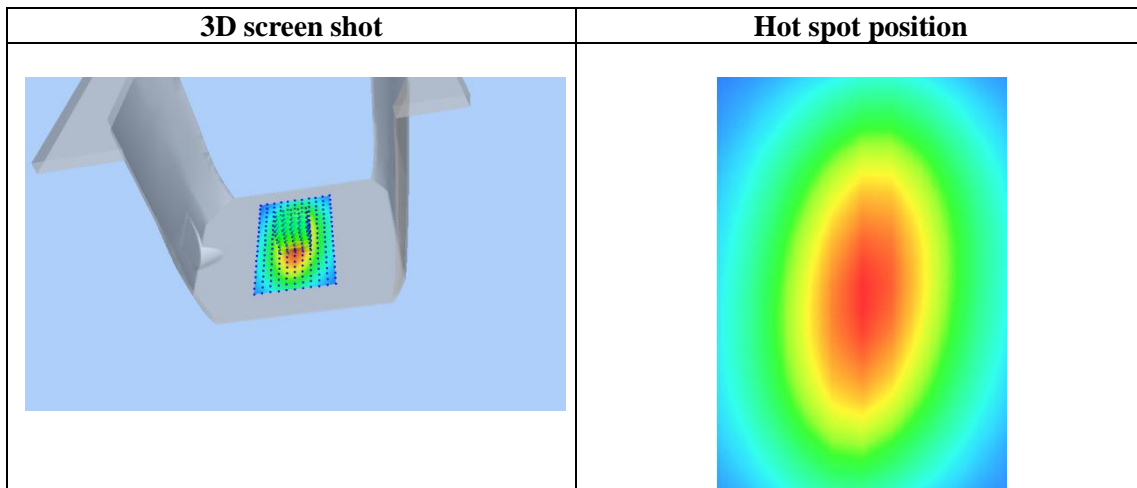
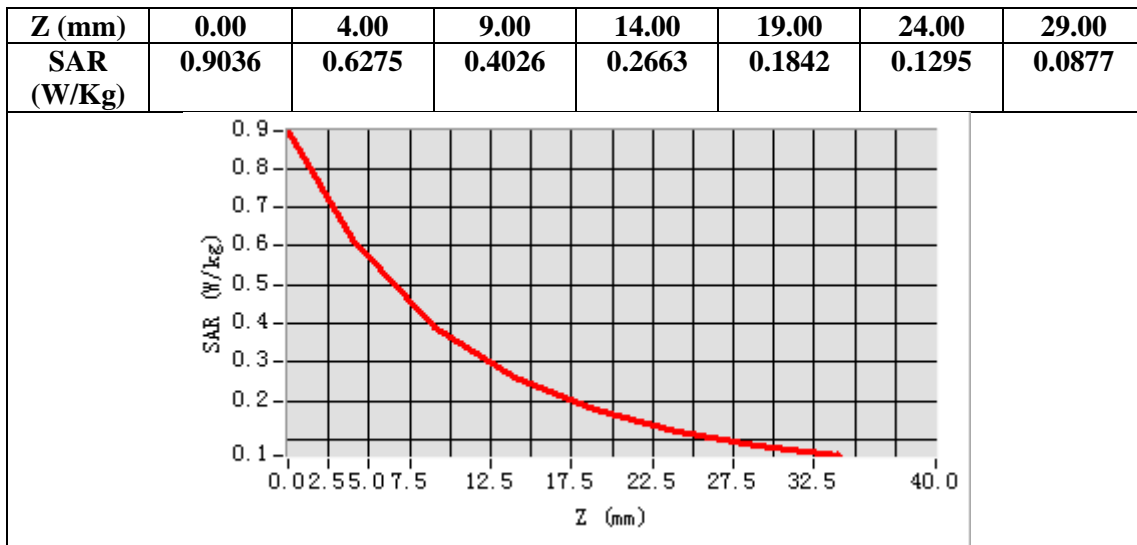

Test Laboratory: AGC Lab
System Check Body835 MHz

Date: Oct. 10,2018

DUT: Dipole 835 MHz Type: SID 835

Communication System CW; Communication System Band: D835 (835.0 MHz); Duty Cycle: 1:1;Conv.F=5.49
Frequency: 835 MHz; Medium parameters used: $f = 835$ MHz; $\sigma = 0.96$ mho/m; $\epsilon_r = 55.07$; $\rho = 1000$ kg/m³ ;
Phantom section: Flat Section; Input Power=18dBm
Ambient temperature (°C):22.1, Liquid temperature (°C): 21.7

SATIMO Configuration

Probe: SSE5; Calibrated: Aug. 08,2018; Serial No.: SN 22/12 EP159
Sensor-Surface: 4mm (Mechanical Surface Detection)
Phantom: SAM twin phantom
Measurement SW: OpenSAR V4_02_32

Configuration/System Check 835MHzBody/Area Scan: Measurement grid: dx=8mm, dy=8mm

Configuration/System Check 835MHzBody/Zoom Scan: Measurement grid: dx=8mm,dy=8mm, dz=5mm

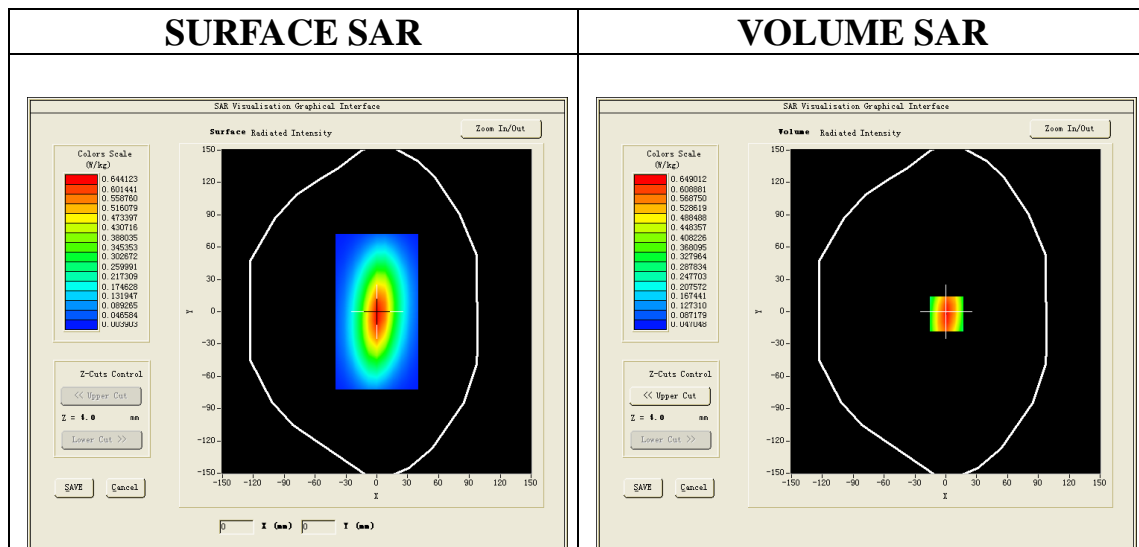

Maximum location: X=1.00, Y=-2.00
SAR Peak: 0.90 W/kg

SAR 10g (W/Kg)	0.375120
SAR 1g (W/Kg)	0.610174

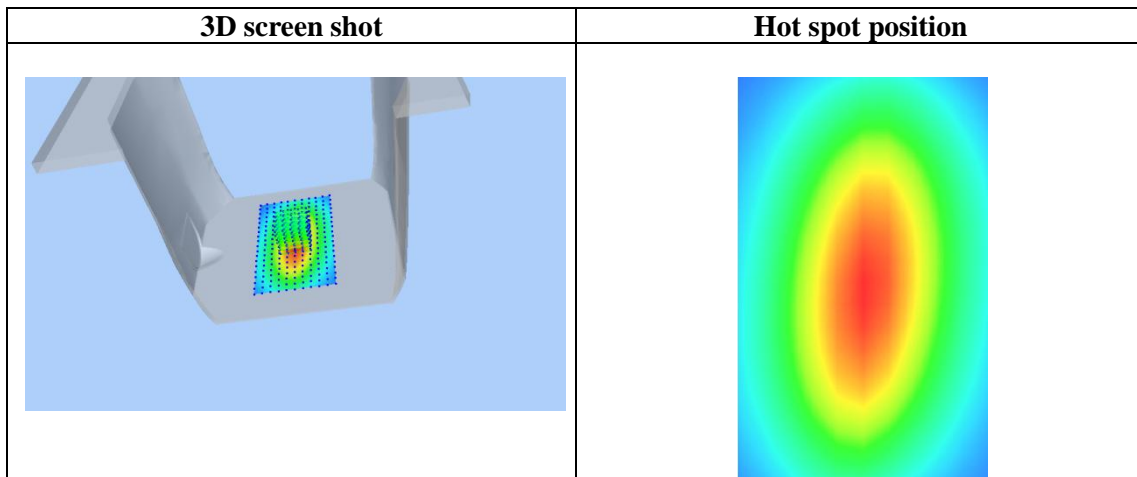
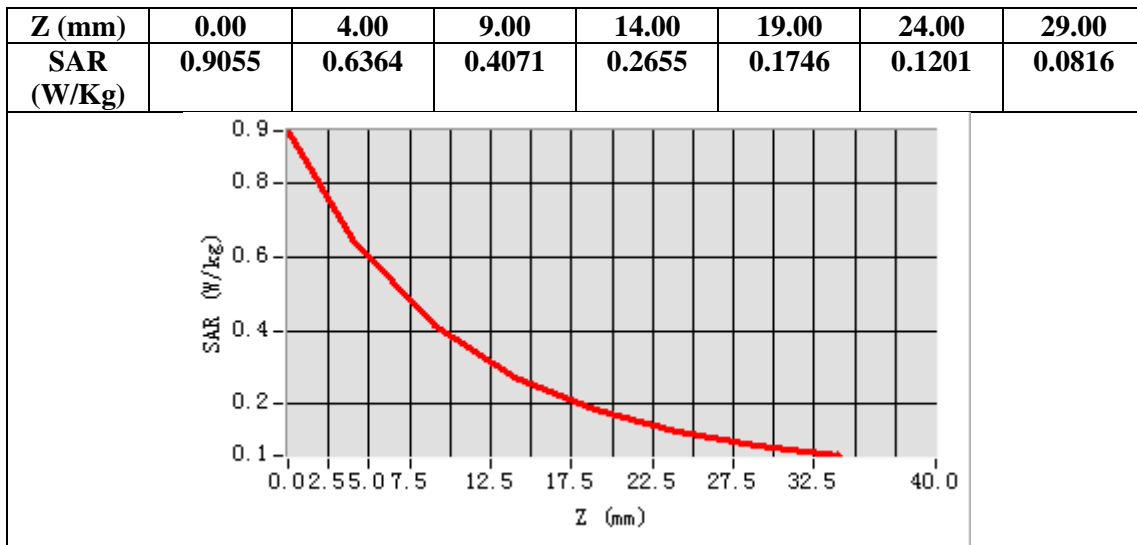

Test Laboratory: AGC Lab
System Check Head 1900MHz

Date: Oct. 12,2018

DUT: Dipole 1900 MHz; Type: SID 1900

CommunicationSystem: CW; Communication System Band: D1900 (1900.0 MHz); Duty Cycle:1:1;Conv.F=5.24
Frequency: 1900 MHz; Medium parameters used: $f = 1850$ MHz; $\sigma = 1.40$ mho/m; $\epsilon_r = 40.28$; $\rho = 1000$ kg/m³ ;
Phantom section: Flat Section; Input Power=18dBm
Ambient temperature (°C):21.8, Liquid temperature (°C): 21.3

SATIMO Configuration:

Probe: SSE5; Calibrated: Aug. 08,2018; Serial No.: SN 22/12 EP159

Sensor-Surface: 4mm (Mechanical Surface Detection)

Phantom: SAM twin phantom

Measurement SW: OpenSAR V4_02_32

Configuration/System Check 1900MHz Head/Area Scan: Measurement grid: dx=8mm, dy=8mm

Configuration/System Check 1900MHz Head/Zoom Scan: Measurement grid: dx=8mm,dy=8mm, dz=5mm

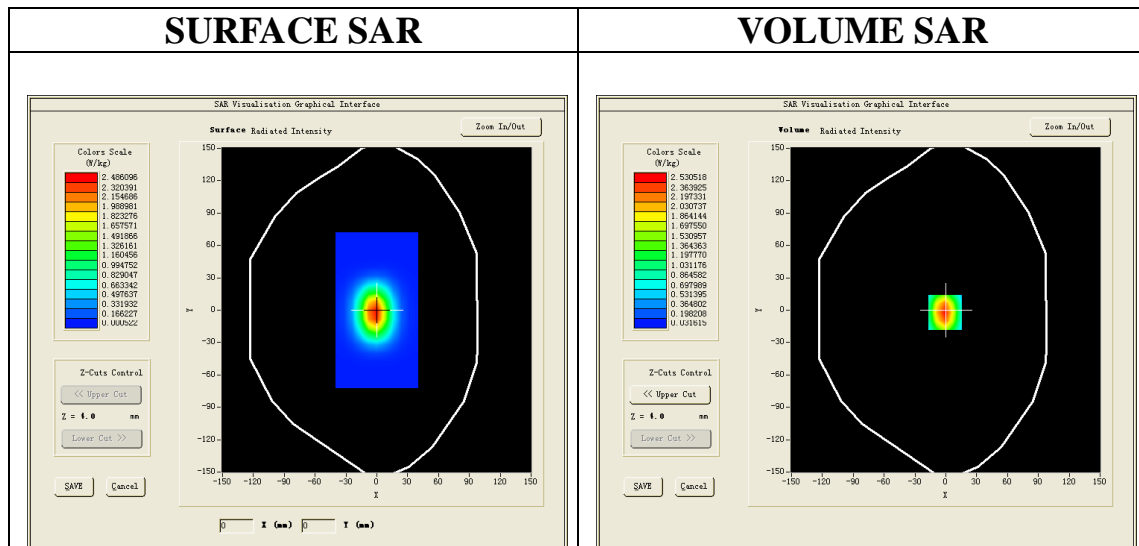

Maximum location: X=-2.00, Y=-2.00
SAR Peak: 4.13 W/kg

SAR 10g (W/Kg)	1.223751
SAR 1g (W/Kg)	2.399677

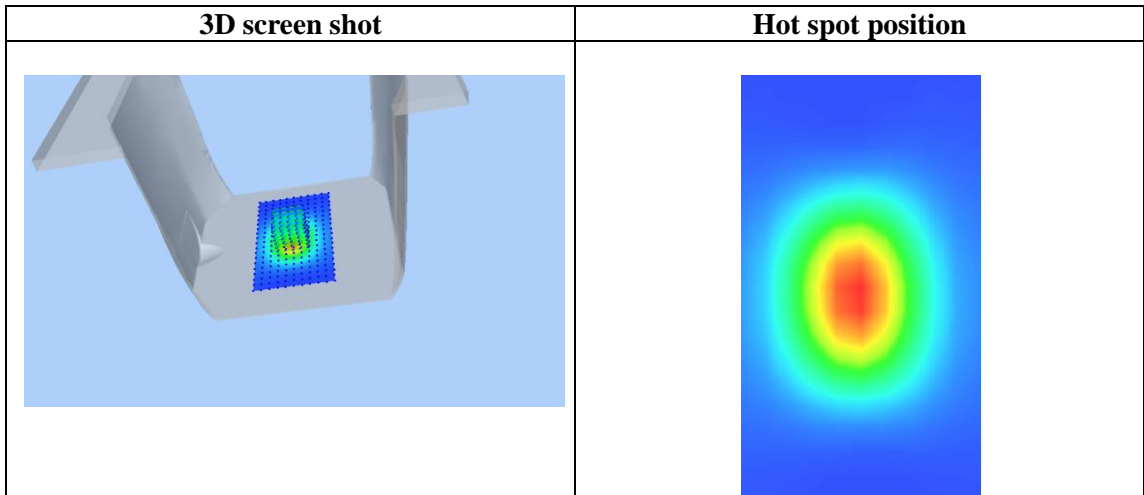
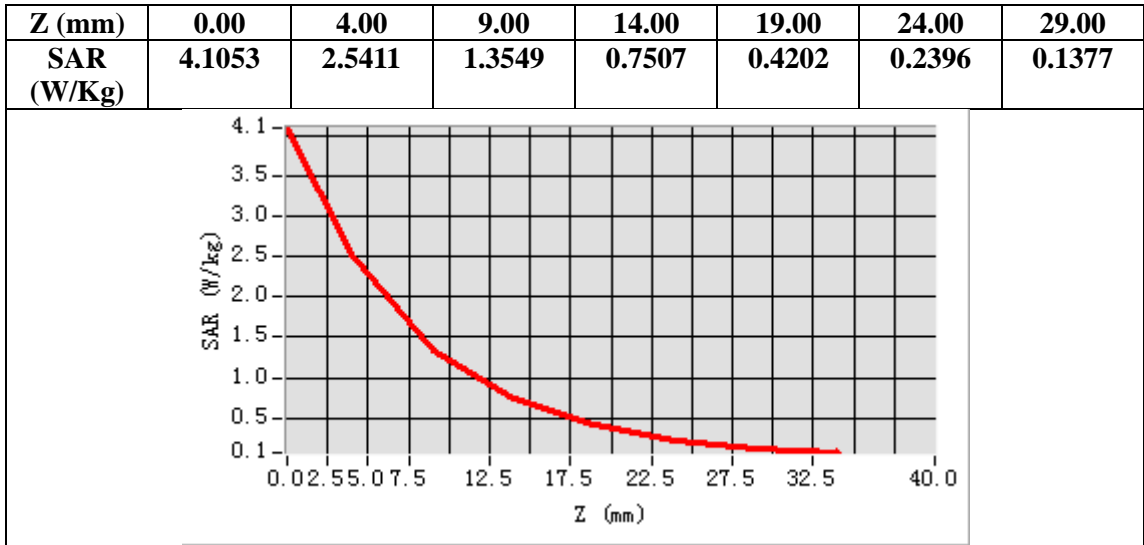

Test Laboratory: AGC Lab
System Check Body1900MHz
DUT: Dipole 1900 MHz; Type: SID 1900

Date: Oct. 12,2018

CommunicationSystem: CW; Communication System Band: D1900 (1900.0 MHz); Duty Cycle:1:1;Conv.F=5.39
Frequency: 1900 MHz; Medium parameters used: $f = 1850$ MHz; $\sigma = 1.53$ mho/m; $\epsilon_r = 53.07$; $\rho = 1000$ kg/m³ ;
Phantom section: Flat Section; Input Power=18dBm
Ambient temperature (°C):21.8, Liquid temperature (°C): 21.5

SATIMO Configuration:

Probe: SSE5; Calibrated: Aug. 08,2018; Serial No.: SN 22/12 EP159
Sensor-Surface: 4mm (Mechanical Surface Detection)
Phantom: SAM twin phantom
Measurement SW: OpenSAR V4_02_32

Configuration/System Check 1900MHzBody/Area Scan: Measurement grid: dx=8mm, dy=8mm

Configuration/System Check 1900MHzBody/Zoom Scan: Measurement grid: dx=8mm,dy=8mm, dz=5mm

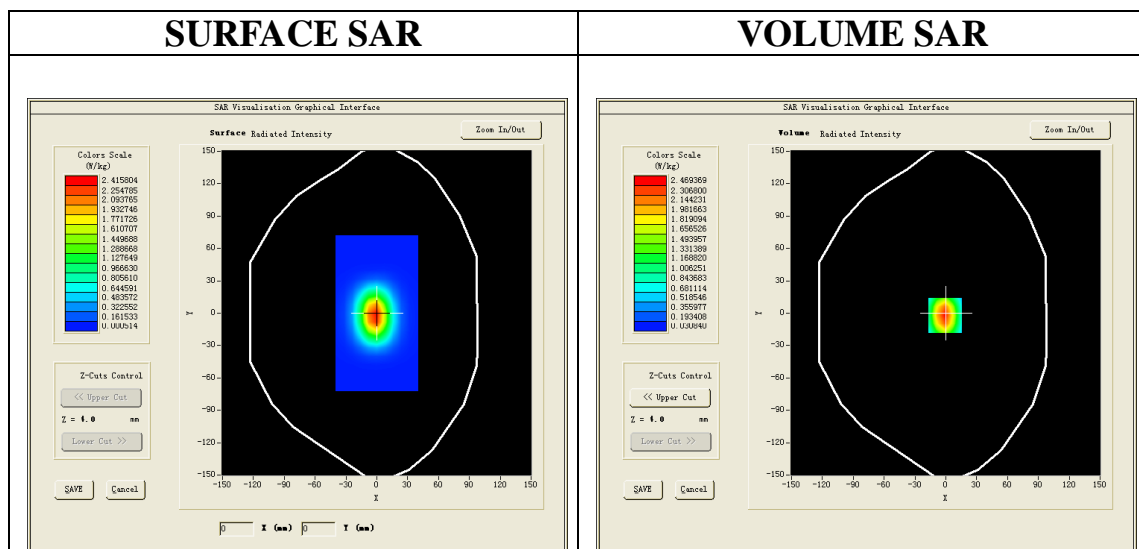

Maximum location: X=-1.00, Y=-1.00
SAR Peak: 3.95 W/kg

SAR 10g (W/Kg)	1.185137
SAR 1g (W/Kg)	2.326714

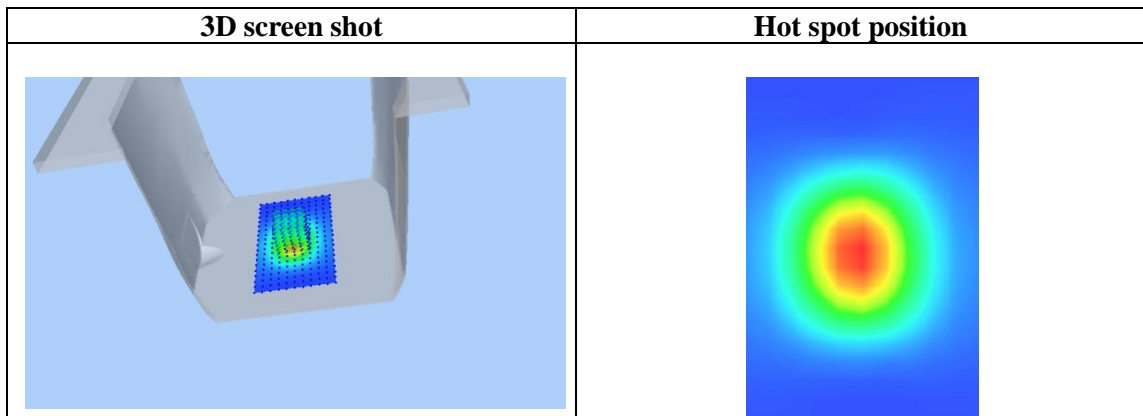
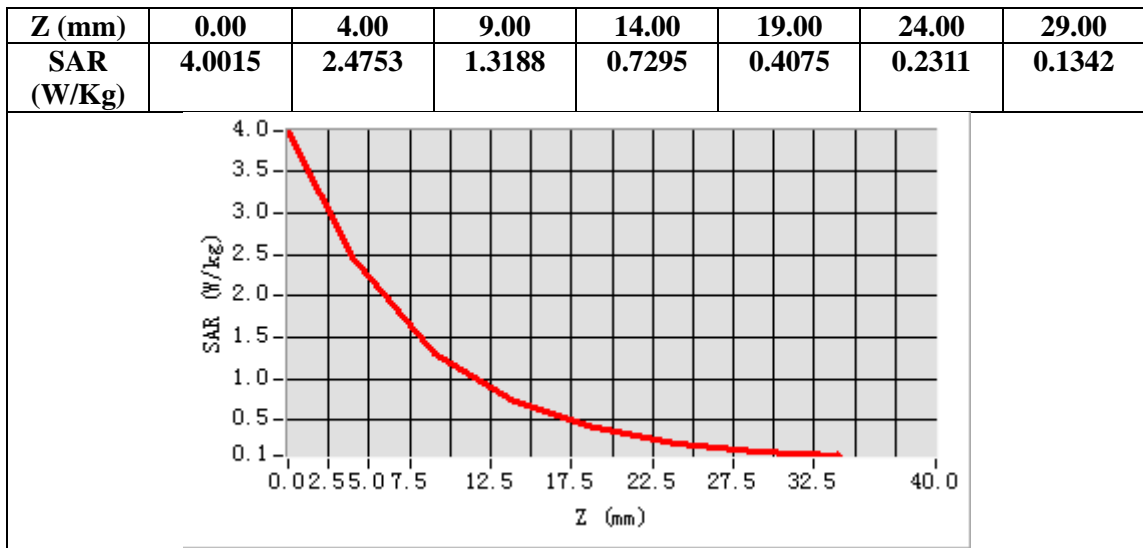

Test Laboratory: AGC Lab
System Check Head 2450 MHz

Date: Oct. 11,2018

DUT: Dipole 2450 MHz Type: SID 2450

Communication System CW; Communication System Band: D2450 (2450.0 MHz); Duty Cycle: 1:1;Conv.F=4.90
Frequency: 2450 MHz; Medium parameters used: $f = 2450$ MHz; $\sigma = 1.82$ mho/m; $\epsilon_r = 39.67$; $\rho = 1000$ kg/m³ ;
Phantom section: Flat Section; Input Power=18dBm
Ambient temperature (°C):21.9, Liquid temperature (°C): 21.3

SATIMO Configuration

Probe: SSE5; Calibrated: Aug. 08,2018; Serial No.: SN 22/12 EP159
Sensor-Surface: 4mm (Mechanical Surface Detection)
Phantom: SAM twin phantom
Measurement SW: OpenSAR V4_02_35

Configuration/System Check 2450MHz Head/Area Scan: Measurement grid: dx=8mm, dy=8mm

Configuration/System Check 2450MHz Head/Zoom Scan: Measurement grid: dx=5mm,dy=5mm, dz=5mm

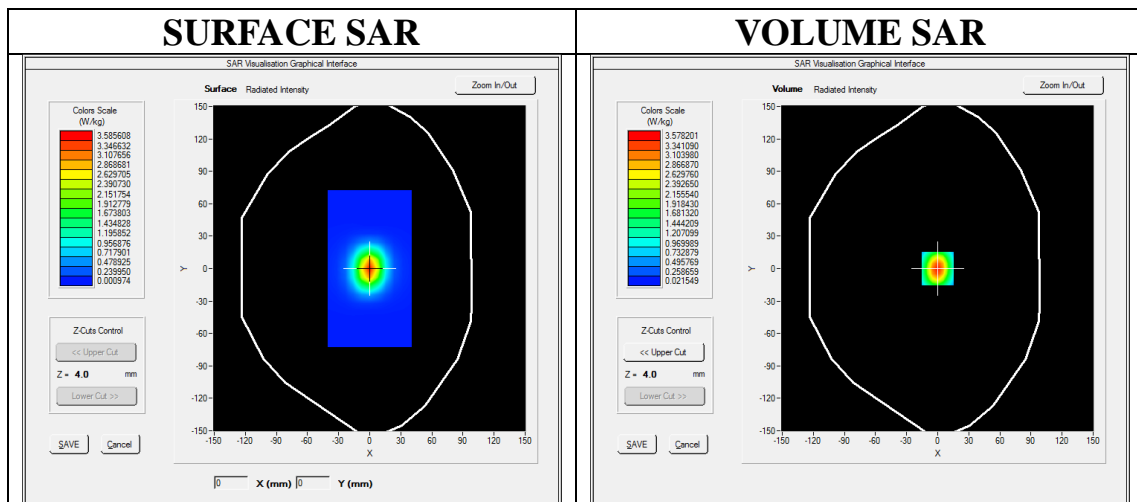

Maximum location: X=0.00, Y=0.00
SAR Peak: 5.99 W/kg

SAR 10g (W/Kg)	1.519394
SAR 1g (W/Kg)	3.263179

Z (mm)	0.00	4.00	9.00	14.00	19.00	24.00	29.00
SAR (W/Kg)	6.0649	3.5782	1.7467	0.8682	0.4357	0.2208	0.1124

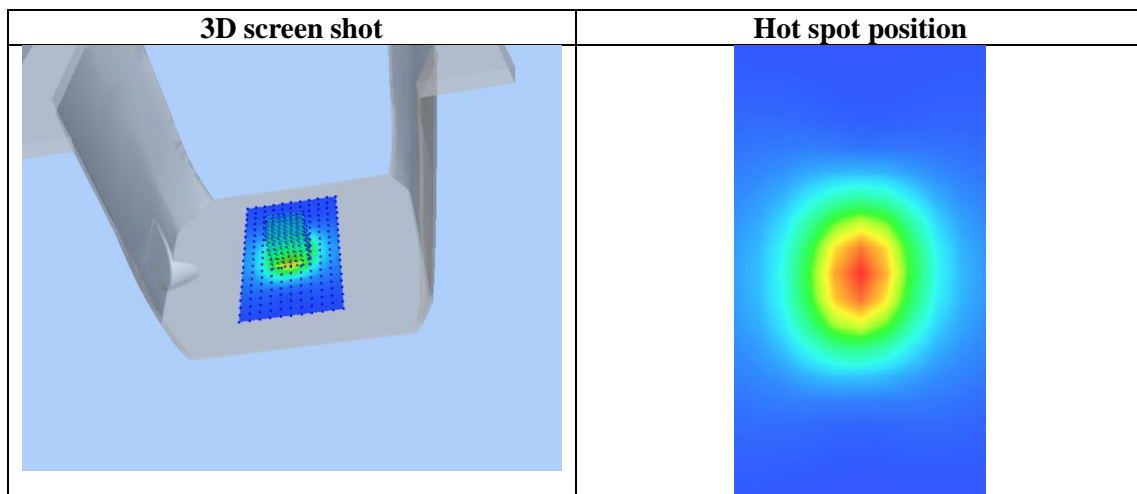
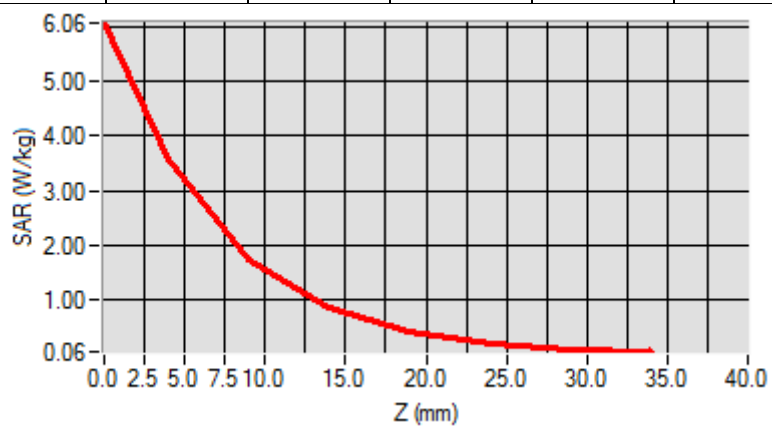

Test Laboratory: AGC Lab
System Check Body2450 MHz

Date: Oct. 11,2018

DUT: Dipole 2450 MHz Type: SID 2450

Communication System CW; Communication System Band: D2450 (2450.0 MHz); Duty Cycle: 1:1;Conv.F=5.04
Frequency: 2450 MHz; Medium parameters used: $f = 2450$ MHz; $\sigma = 1.93$ mho/m; $\epsilon_r = 53.66$; $\rho = 1000$ kg/m³ ;
Phantom section: Flat Section; Input Power=18dBm
Ambient temperature (°C):21.9, Liquid temperature (°C): 21.5

SATIMO Configuration

Probe: SSE5; Calibrated: Aug. 08,2018; Serial No.: SN 22/12 EP159
Sensor-Surface: 4mm (Mechanical Surface Detection)
Phantom: SAM twin phantom
Measurement SW: OpenSAR V4_02_35

Configuration/System Check 2450MHzBody/Area Scan: Measurement grid: dx=8mm, dy=8mm

Configuration/System Check 2450MHzBody/Zoom Scan: Measurement grid: dx=5mm,dy=5mm, dz=5mm

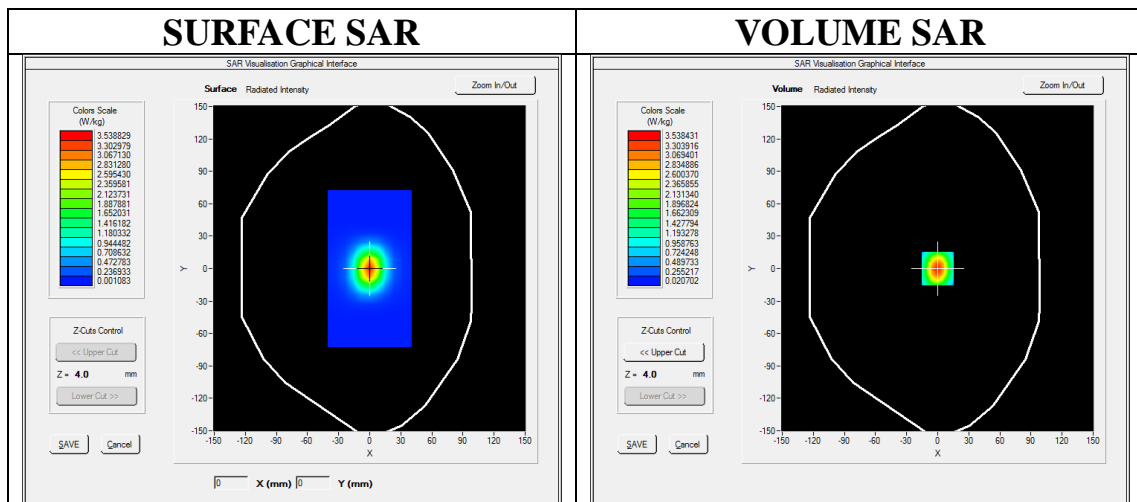

Maximum location: X=0.00, Y=0.00
SAR Peak: 5.94 W/kg

SAR 10g (W/Kg)	1.499719
SAR 1g (W/Kg)	3.227008

Z (mm)	0.00	4.00	9.00	14.00	19.00	24.00	29.00
SAR (W/Kg)	6.0134	3.5384	1.7211	0.8535	0.4287	0.2166	0.1095

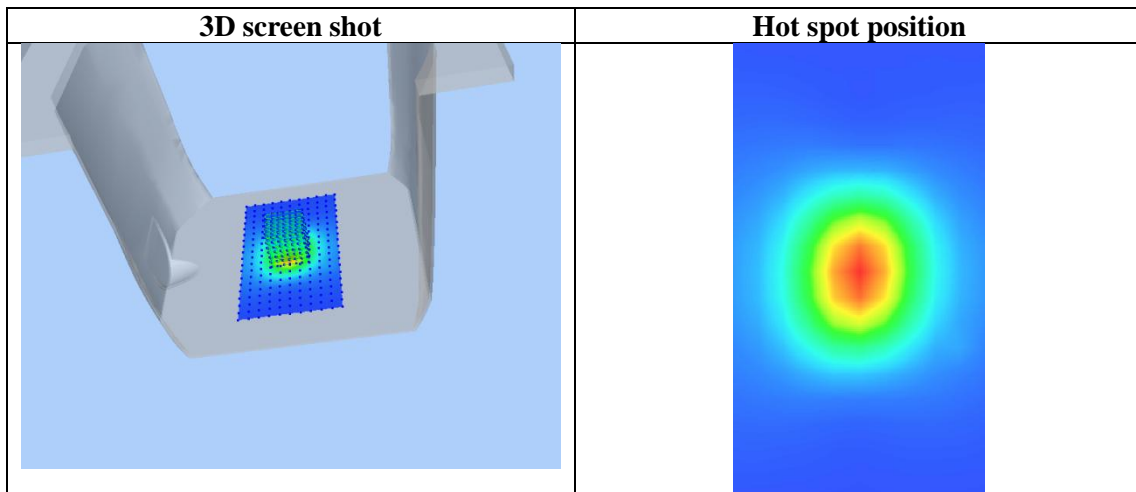
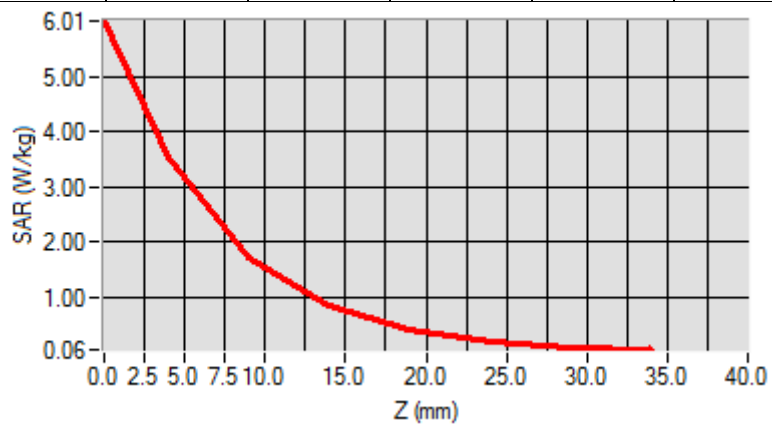

APPENDIX B. SAR MEASUREMENT DATA

Test Laboratory: AGC Lab
GSM 850 Mid- Touch-Right <SIM 1>
DUT:Smart Phone; Type:LitePro

Date: Oct. 10,2018

Communication System: Generic GSM; Communication System Band: GSM 850; DutyCycle: 1:8.3; Conv.F=5.29;
Frequency: 836.6 MHz; Medium parameters used: $f = 835$ MHz; $\sigma = 0.92$ mho/m; $\epsilon_r = 40.81$; $\rho = 1000$ kg/m³ ;
Phantom section: Right Section
Ambient temperature (°C): 22.1, Liquid temperature (°C): 21.5

SATIMO Configuration:

Probe: SSE5; Calibrated: Aug. 08,2018; Serial No.: SN 22/12 EP159
Sensor-Surface: 4mm (Mechanical Surface Detection)
Phantom: SAM twin phantom
Measurement SW: OpenSAR V4_02_32

Configuration/GSM 850 Mid-Touch-Right/Area Scan: Measurement grid: dx=8mm, dy=8mm
Configuration/GSM 850 Mid-Touch-Right/Zoom Scan: Measurement grid: dx=8mm,dy=8mm, dz=5mm;

Area Scan	dx=8mm dy=8mm, h= 5.00 mm
ZoomScan	5x5x7,dx=8mm dy=8mm dz=5mm,Complete
Phantom	Right head
Device Position	Cheek
Band	GSM 850
Channels	Middle
Signal	TDMA (Crest factor: 8.0)

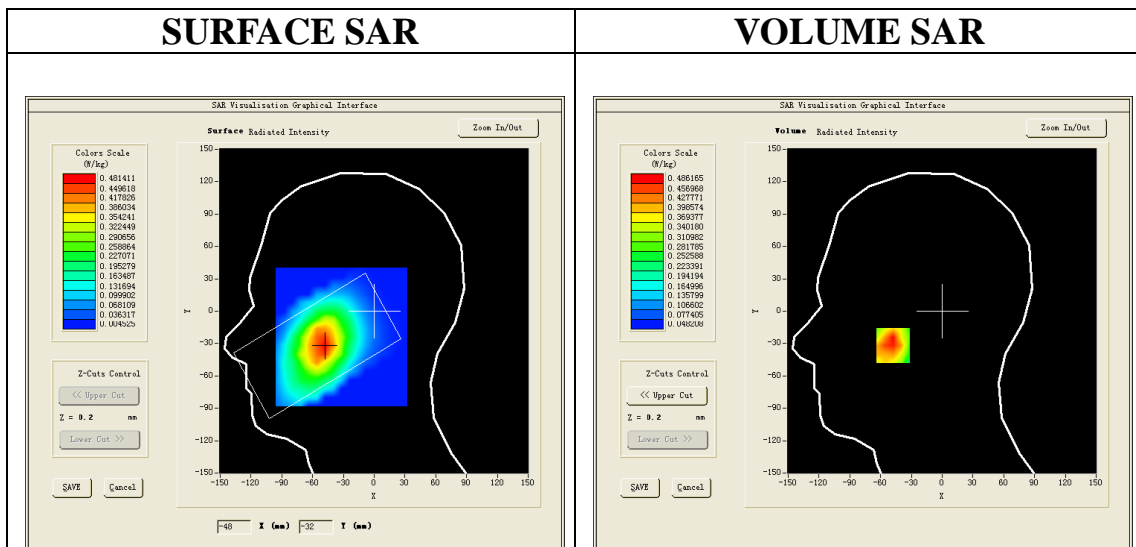

Maximum location: X=-48.00, Y=-32.00

SAR Peak: 0.69 W/kg

SAR 10g (W/Kg)	0.328039
SAR 1g (W/Kg)	0.470125

Z (mm)	0.00	4.00	9.00	14.00	19.00	24.00	29.00
---------------	-------------	-------------	-------------	--------------	--------------	--------------	--------------

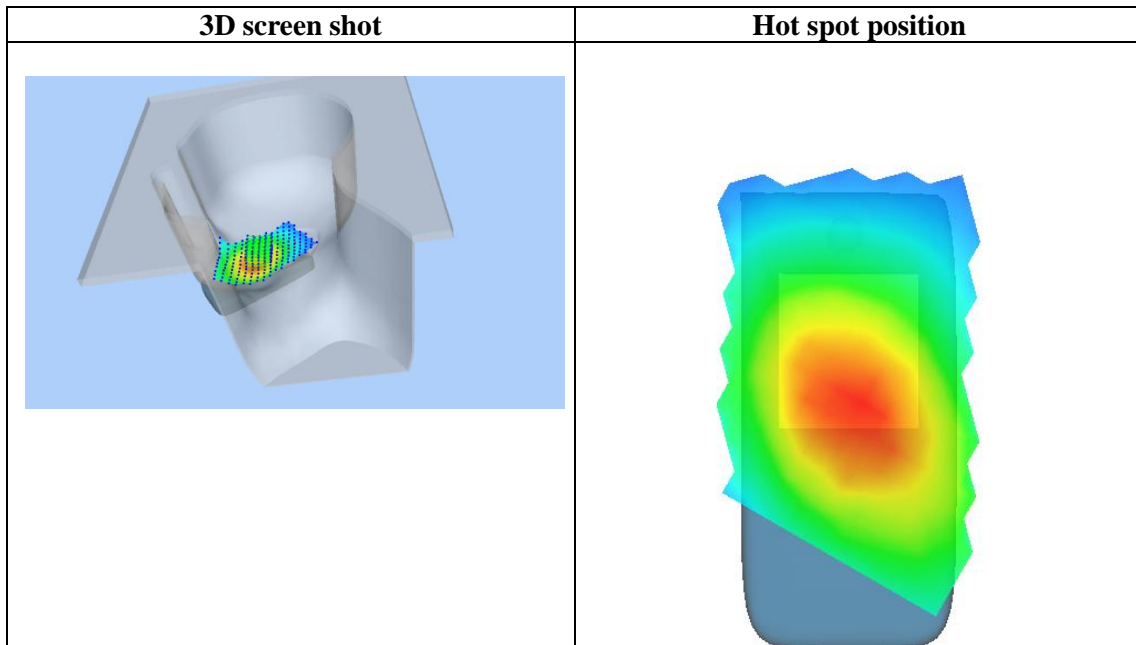
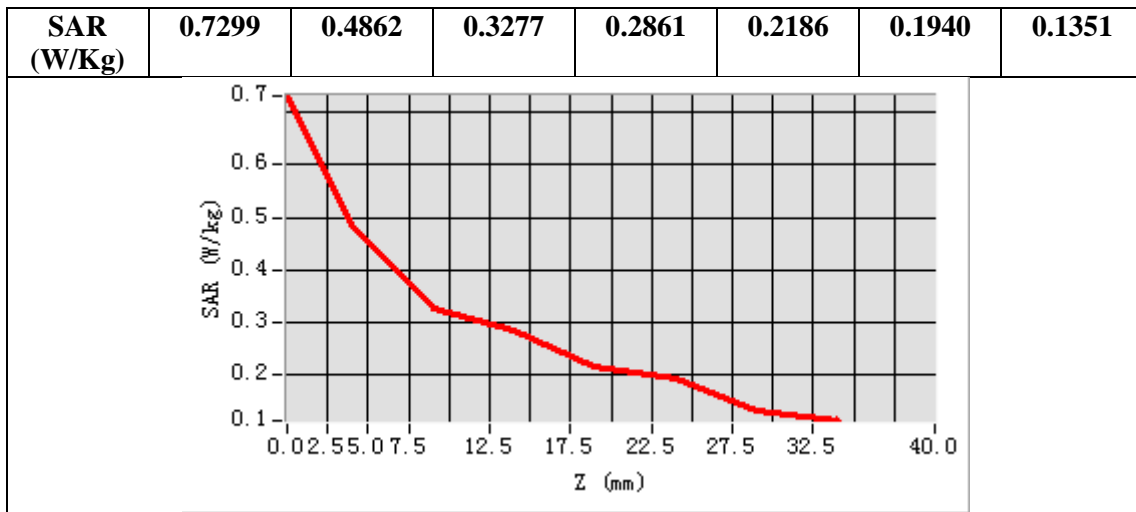

Test Laboratory: AGC Lab
GSM 850 Mid- Body- Back (MS)<SIM 1>
DUT:Smart Phone; Type:LitePro

Date: Oct. 10,2018

Communication System: Generic GSM; Communication System Band: GSM 850; DutyCycle: 1:8.3; Conv.F=5.49;
Frequency: 836.6 MHz; Medium parameters used: $f = 835$ MHz; $\sigma = 0.97$ mho/m; $\epsilon_r = 54.73$; $\rho = 1000$ kg/m³ ;
Phantom section: Flat Section
Ambient temperature (°C): 22.1, Liquid temperature (°C): 21.7

SATIMO Configuration:

Probe: SSE5; Calibrated: Aug. 08,2018; Serial No.: SN 22/12 EP159
Sensor-Surface: 4mm (Mechanical Surface Detection)
Phantom: SAM twin phantom
Measurement SW: OpenSAR V4_02_32

Configuration/GSM 850 Mid-Body-Back/Area Scan: Measurement grid: dx=8mm, dy=8mm
Configuration/GSM 850 Mid-Body-Back/Zoom Scan: Measurement grid: dx=8mm,dy=8mm, dz=5mm;

Area Scan	surf_sam_plan.txt, h= 5.00 mm
ZoomScan	5x5x7,dx=8mm dy=8mm dz=5mm,Complete
Phantom	Validation plane
Device Position	BodyBack
Band	GSM 850
Channels	Middle
Signal	TDMA (Crest factor: 8.0)

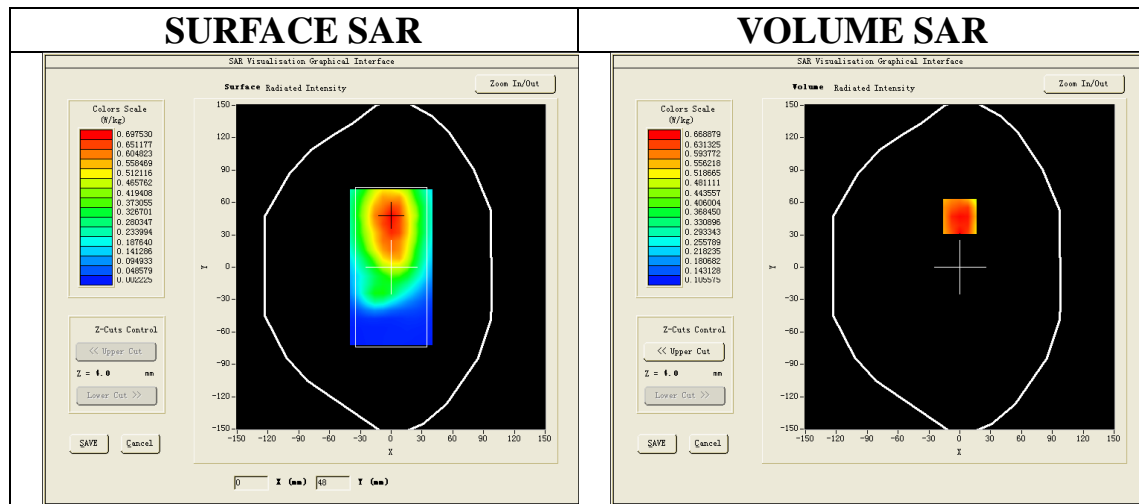

Maximum location: X=0.00, Y=25.00
SAR Peak: 0.76 W/kg

SAR 10g (W/Kg)	0.389710
SAR 1g (W/Kg)	0.548791

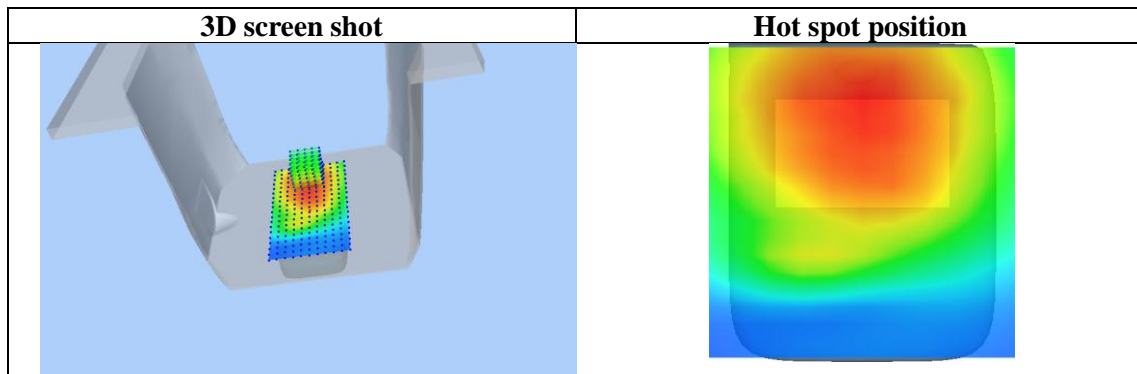
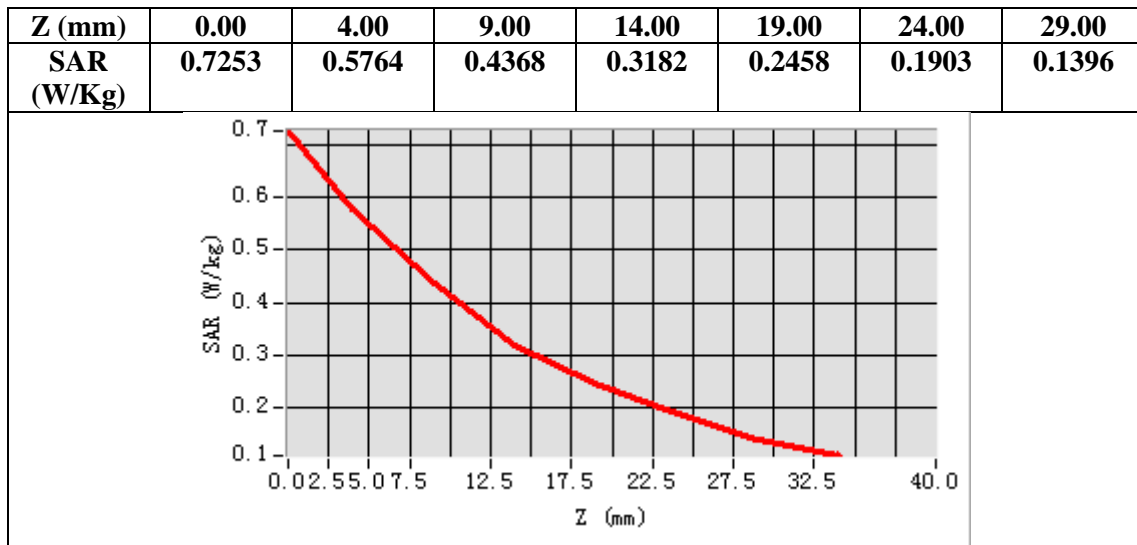

Test Laboratory: AGC Lab
GPRS 850 Mid- Body- Back (2up)
DUT:Smart Phone; Type:LitePro

Date: Oct. 10,2018

Communication System: GPRS-2 Slot; Communication System Band: GSM 850; DutyCycle: 1:4.2; Conv.F=5.49;
Frequency: 836.6 MHz; Medium parameters used: $f = 835$ MHz; $\sigma = 0.97$ mho/m; $\epsilon_r = 54.73$; $\rho = 1000$ kg/m³ ;
Phantom section: Flat Section
Ambient temperature (°C): 22.1, Liquid temperature (°C): 21.7

SATIMO Configuration:

Probe: SSE5; Calibrated: Aug. 08,2018; Serial No.: SN 22/12 EP159
Sensor-Surface: 4mm (Mechanical Surface Detection)
Phantom: SAM twin phantom
Measurement SW: OpenSAR V4_02_32

Configuration/GPRS 850 Mid-Body-Back/Area Scan: Measurement grid: dx=8mm, dy=8mm
Configuration/GPRS 850 Mid-Body-Back/Zoom Scan: Measurement grid: dx=8mm,dy=8mm, dz=5mm;

Area Scan	surf_sam_plan.txt, h= 5.00 mm
Zoom Scan	5x5x7,dx=8mm dy=8mm dz=5mm,Complete
Phantom	Validation plane
Device Position	BodyBack
Band	GSM 850
Channels	Middle
Signal	TDMA (Crest factor: 4.0)

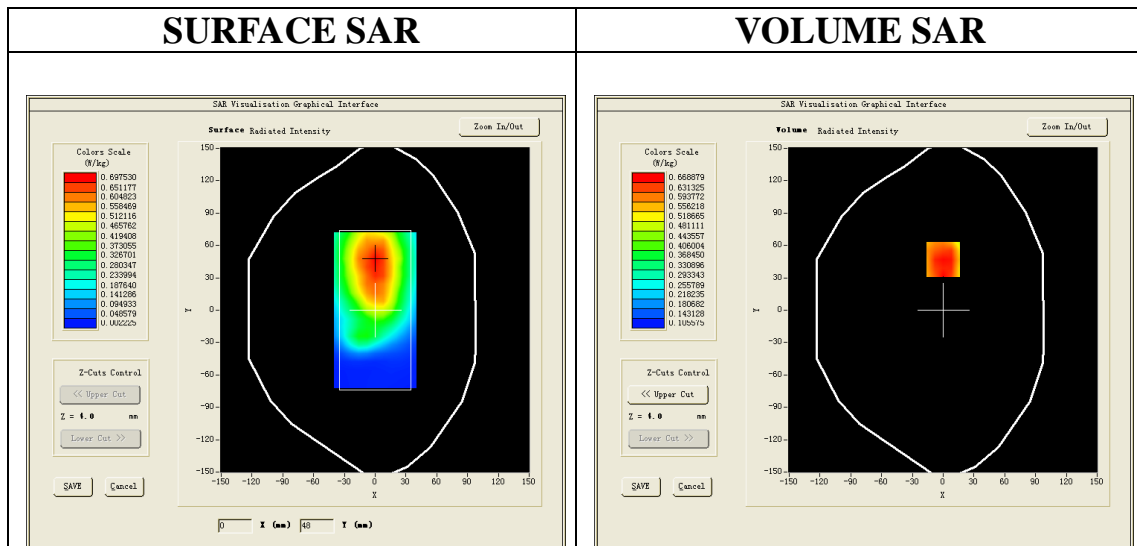

Maximum location: X=0.00, Y=47.00
SAR Peak: 0.86 W/kg

SAR 10g (W/Kg)	0.480751
SAR 1g (W/Kg)	0.647448

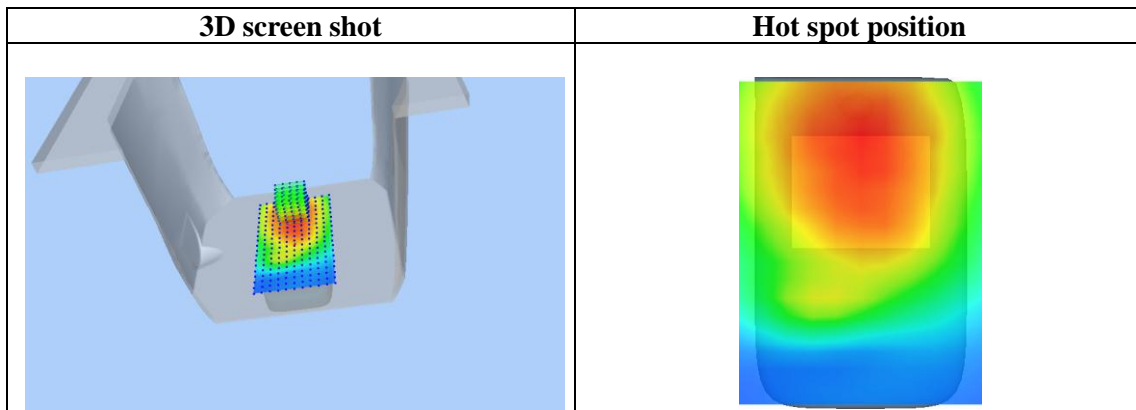
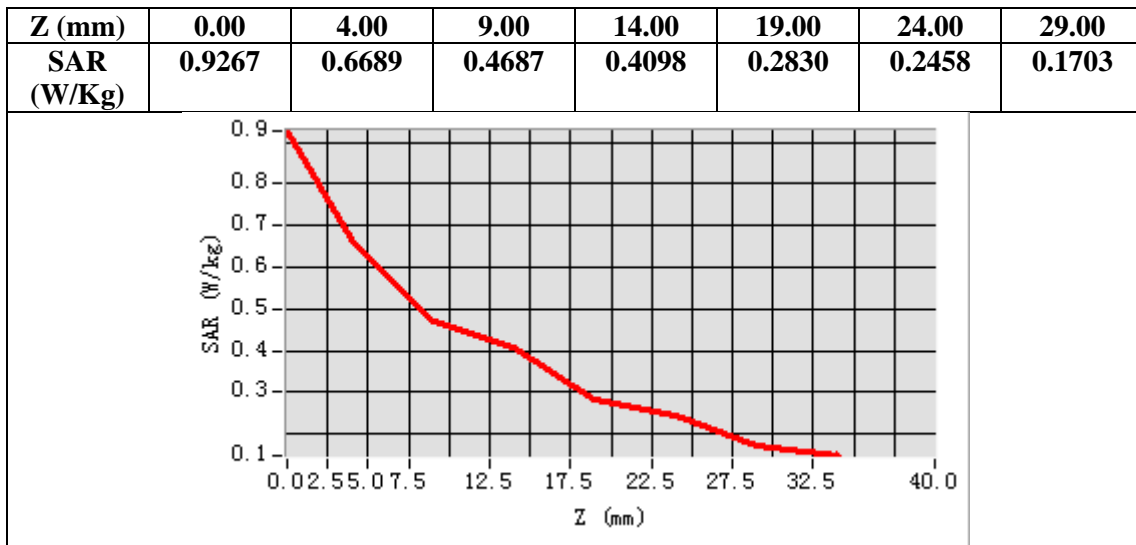

Test Laboratory: AGC Lab
PCS 1900 Mid-Touch-Right <SIM 1>
DUT:Smart Phone; Type:LitePro

Date: Oct. 12,2018

Communication System: Generic GSM; Communication System Band: PCS 1900;Duty Cycle: 1:8.3; Conv.F=5.24;
Frequency: 1880 MHz; Medium parameters used: $f = 1850$ MHz; $\sigma = 1.39$ mho/m; $\epsilon_r = 40.76$; $\rho = 1000$ kg/m³ ;
Phantom section: Right Section
Ambient temperature (°C): 21.8, Liquid temperature (°C): 21.3

SATIMO Configuration:

Probe: SSE5; Calibrated: Aug. 08,2018; Serial No.: SN 22/12 EP159
Sensor-Surface: 4mm (Mechanical Surface Detection)
Phantom: SAM twin phantom
Measurement SW: OpenSAR V4_02_32

Configuration/PCS1900 Mid-Touch-Right/Area Scan: Measurement grid: dx=8mm, dy=8mm
Configuration/PCS1900 Mid-Touch-Right/Zoom Scan: Measurement grid: dx=8mm,dy=8mm, dz=5mm;

Area Scan	dx=8mm dy=8mm, h= 5.00 mm
ZoomScan	5x5x7,dx=8mm dy=8mm dz=5mm,Complete
Phantom	Right head
Device Position	Cheek
Band	PCS1900
Channels	Middle
Signal	TDMA (Crest factor: 8.0)

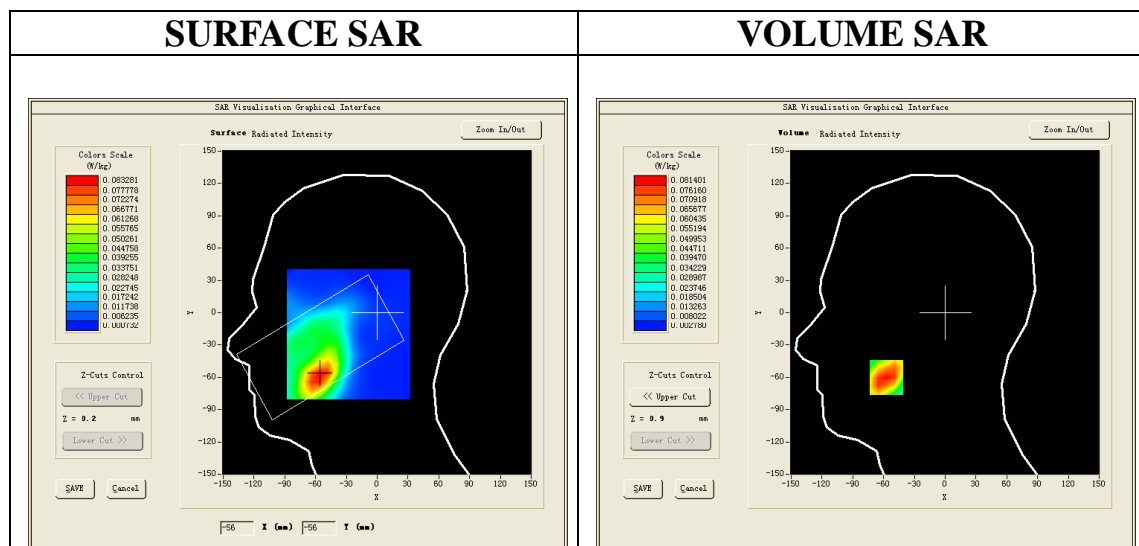

Maximum location: X=-57.00, Y=-60.00
SAR Peak: 0.12 W/kg

SAR 10g (W/Kg)	0.046956
SAR 1g (W/Kg)	0.077391

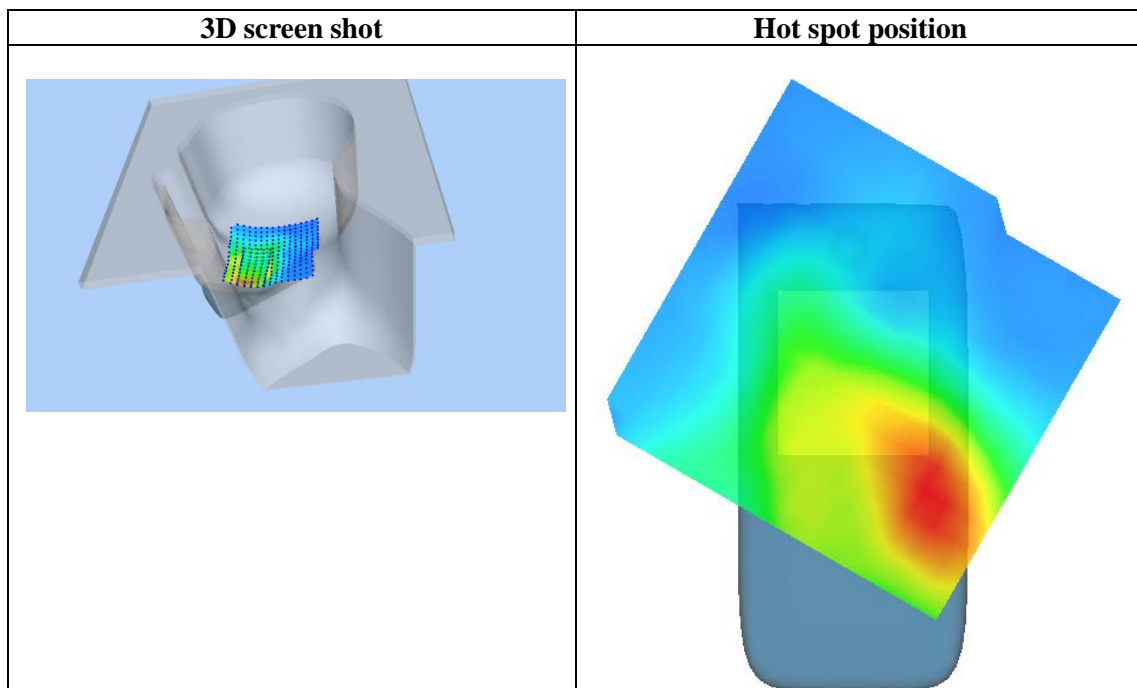
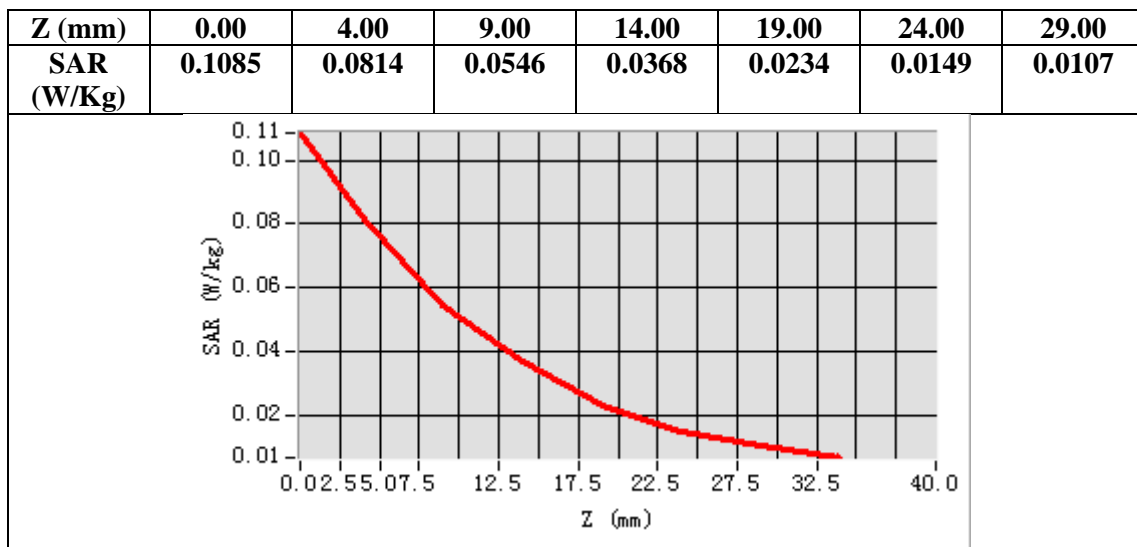

Test Laboratory: AGC Lab
PCS 1900 Mid-Body-Back (MS)<SIM 1>
DUT:Smart Phone; Type:LitePro

Date: Oct. 12,2018

Communication System: Generic GSM; Communication System Band: PCS 1900;Duty Cycle: 1:8.3; Conv.F=5.39;
Frequency: 1880 MHz; Medium parameters used: $f = 1850$ MHz; $\sigma = 1.51$ mho/m; $\epsilon_r = 53.69$; $\rho = 1000$ kg/m³ ;
Phantom section: Flat Section
Ambient temperature (°C): 21.8, Liquid temperature (°C): 21.5

SATIMO Configuration:

Probe: SSE5; Calibrated: Aug. 08,2018; Serial No.: SN 22/12 EP159
Sensor-Surface: 4mm (Mechanical Surface Detection)
Phantom: SAM twin phantom
Measurement SW: OpenSAR V4_02_32

Configuration/PCS1900 Mid-Body-Back/Area Scan: Measurement grid: dx=8mm, dy=8mm
Configuration/PCS1900 Mid-Body-Back/Zoom Scan: Measurement grid:dx=8mm,dy=8mm, dz=5mm;

Area Scan	surf_sam_plan.txt, h= 5.00 mm
ZoomScan	5x5x7,dx=8mm dy=8mm dz=5mm,Complete
Phantom	Validation plane
Device Position	BodyBack
Band	PCS1900
Channels	Middle
Signal	TDMA (Crest factor: 8.0)

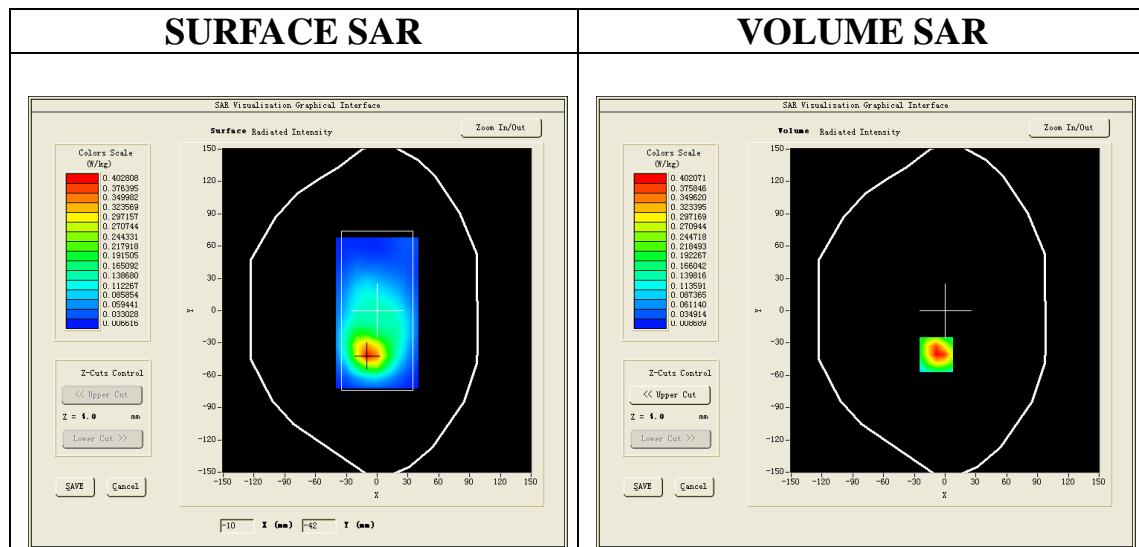

Maximum location: X=-9.00, Y=-41.00

SAR Peak: 0.63 W/kg

SAR 10g (W/Kg)	0.208173
SAR 1g (W/Kg)	0.384544

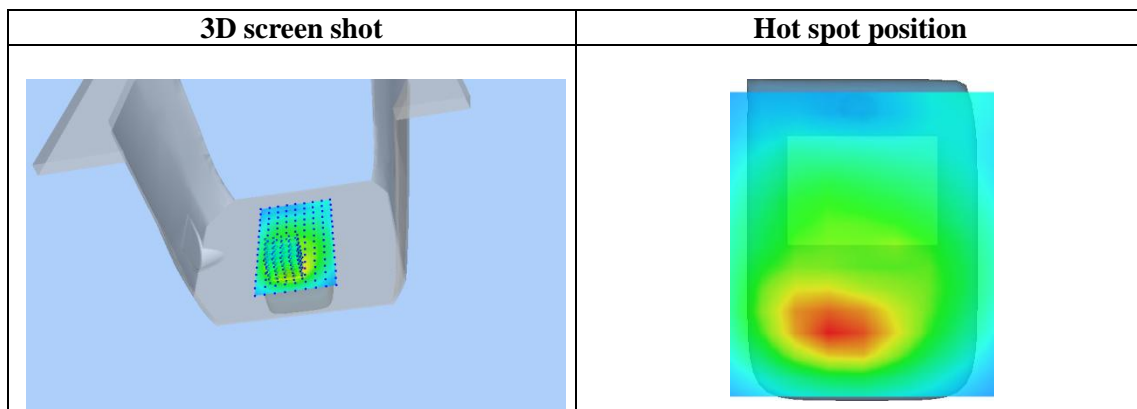
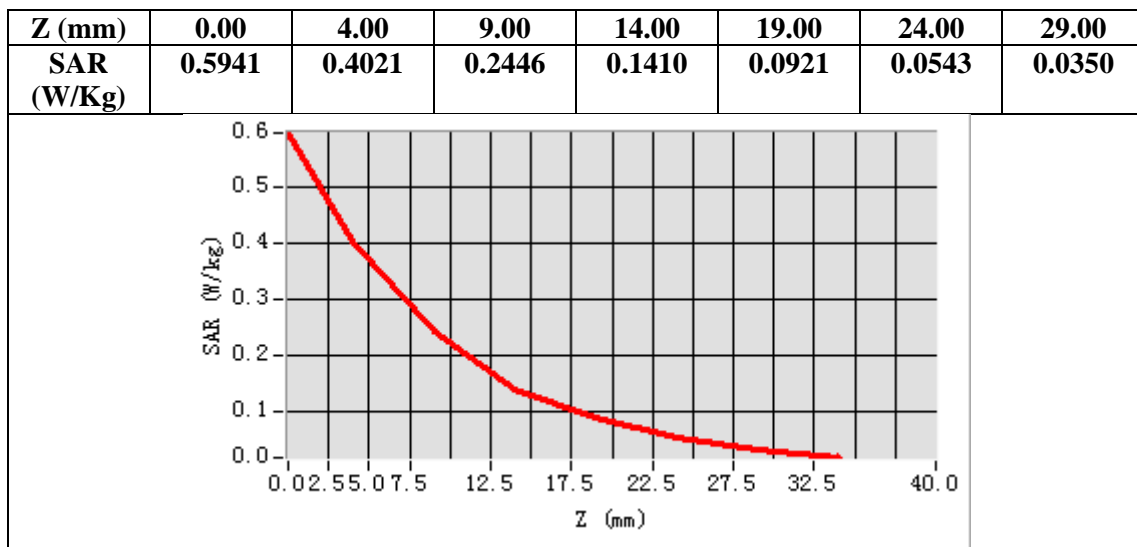

Test Laboratory: AGC Lab
GPRS 1900 Low-Edge3(4up)
DUT:Smart Phone; Type:LitePro

Date: Oct. 12,2018

Communication System: GPRS-4Slot; Communication System Band: PCS 1900;Duty Cycle: 1:2.1; Conv.F=5.39;
Frequency: 1850.2 MHz; Medium parameters used: $f = 1850$ MHz; $\sigma = 1.46$ mho/m; $\epsilon_r = 54.75$; $\rho = 1000$ kg/m³ ;
Phantom section: Flat Section
Ambient temperature (°C): 21.8, Liquid temperature (°C): 21.5

SATIMO Configuration:

Probe: SSE5; Calibrated: Aug. 08,2018; Serial No.: SN 22/12 EP159
Sensor-Surface: 4mm (Mechanical Surface Detection)
Phantom: SAM twin phantom
Measurement SW: OpenSAR V4_02_32

Configuration/GPRS1900 Low-Edge3/Area Scan: Measurement grid: dx=8mm, dy=8mm
Configuration/GPRS1900 Low-Edge3/Zoom Scan: Measurement grid:dx=8mm,dy=8mm, dz=5mm;

Area Scan	surf_sam_plan.txt, h= 5.00 mm
ZoomScan	5x5x7,dx=8mm dy=8mm dz=5mm,Complete
Phantom	Validation plane
Device Position	Edge3
Band	PCS1900
Channels	Low
Signal	TDMA (Crest factor: 2.0)

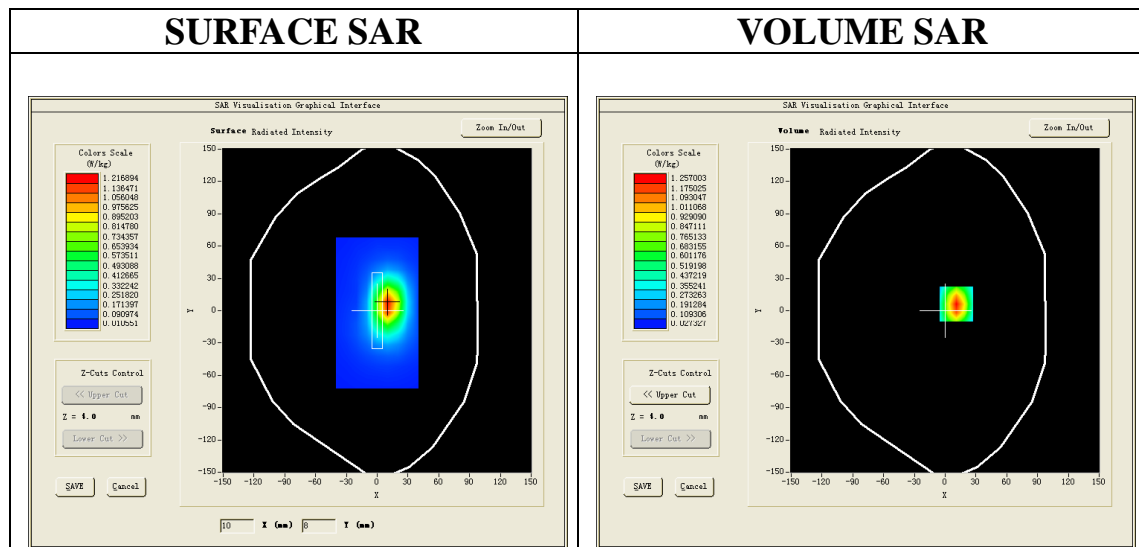

Maximum location: X=11.00, Y=6.00
SAR Peak: 1.84 W/kg

SAR 10g (W/Kg)	0.607114
SAR 1g (W/Kg)	1.125134

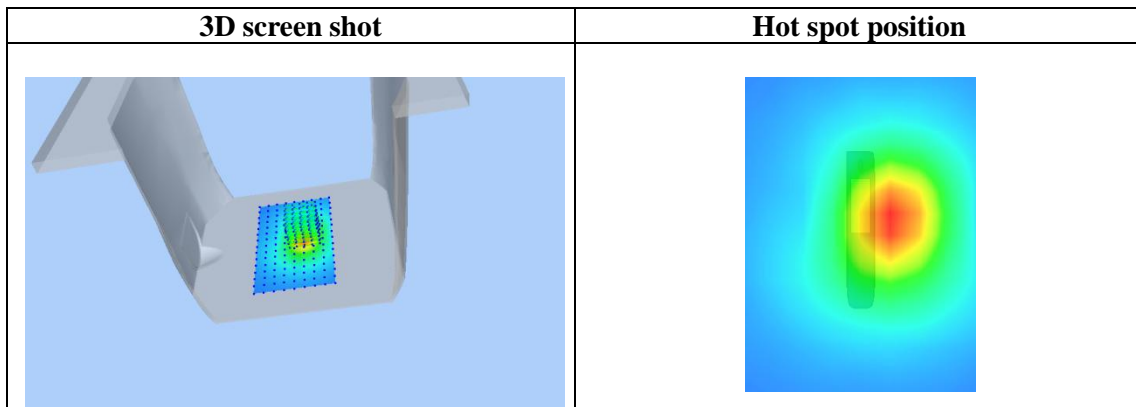
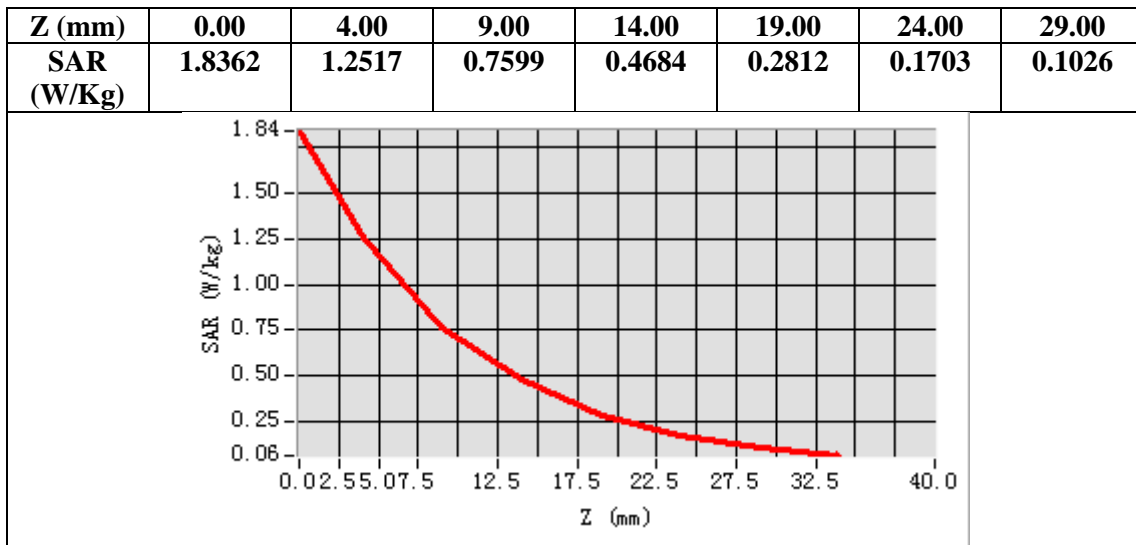

Test Laboratory: AGC Lab
WCDMA Band II Mid-Touch-Right (RMC)
DUT:Smart Phone; Type:LitePro

Date: Oct. 12,2018

Communication System: UMTS;Communication System Band: Band II UTRA/FDD ;Duty Cycle:1:1;Conv.F=5.24;Frequency: 1880 MHz; Medium parameters used: $f = 1850$ MHz; $\sigma = 1.39$ mho/m; $\epsilon_r = 40.76$; $\rho = 1000$ kg/m³ ;
Phantom section: Right Section
Ambient temperature (°C): 21.8, Liquid temperature (°C): 21.3

SATIMO Configuration:

Probe: SSE5; Calibrated: Aug. 08,2018; Serial No.: SN 22/12 EP159
Sensor-Surface: 4mm (Mechanical Surface Detection)
Phantom: SAM twin phantom
Measurement SW: OpenSAR V4_02_32

Configuration/WCDMA band II Mid-Touch-Right/Area Scan: Measurement grid: dx=8mm, dy=8mm
Configuration/WCDMA band IIMid-Touch-Right/Zoom Scan: Measurement grid: dx=8mm,dy=8mm, dz=5mm;

Area Scan	dx=8mm dy=8mm, h= 5.00 mm
ZoomScan	5x5x7,dx=8mm dy=8mm dz=5mm,Complete
Phantom	Right head
Device Position	Cheek
Band	WCDMA band II
Channels	Middle
Signal	CDMA (Crest factor: 1.0)

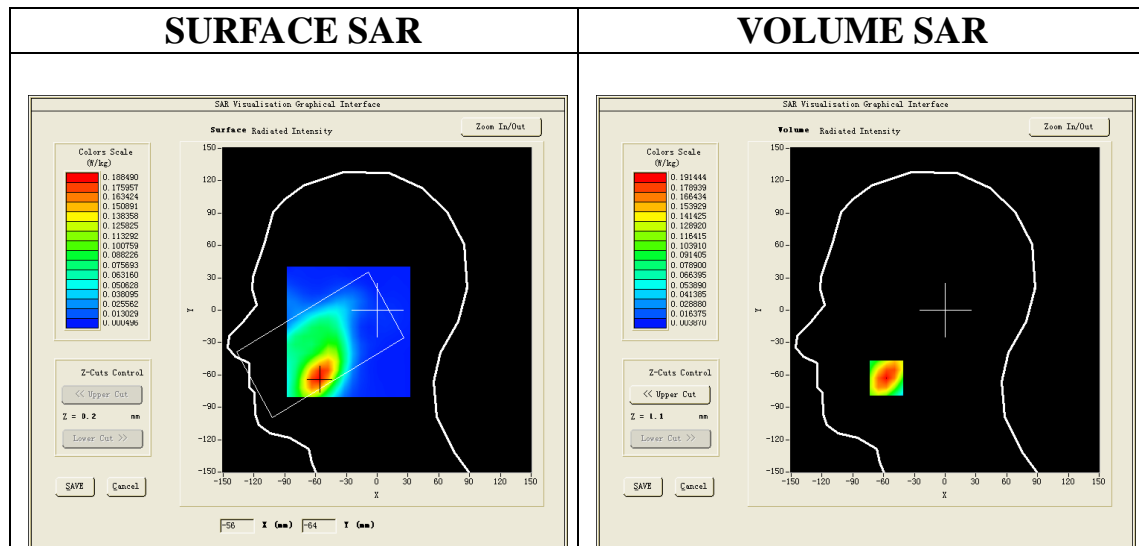

Maximum location: X=-57.00, Y=-63.00

SAR Peak: 0.29 W/kg

SAR 10g (W/Kg)	0.107322
SAR 1g (W/Kg)	0.182921

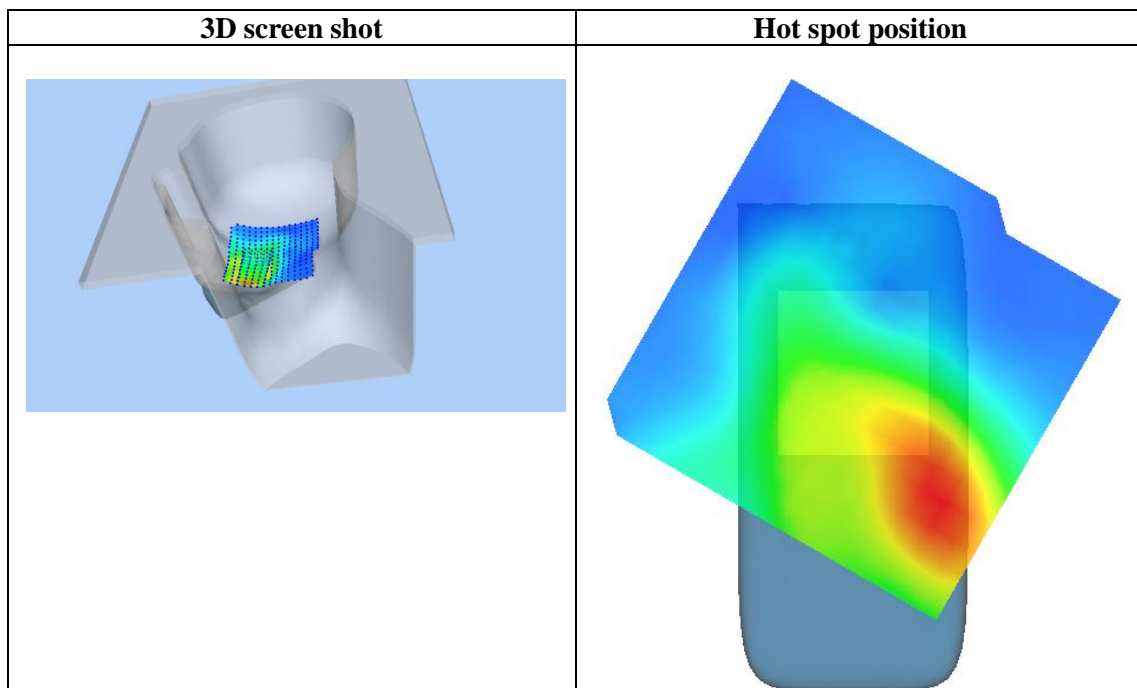
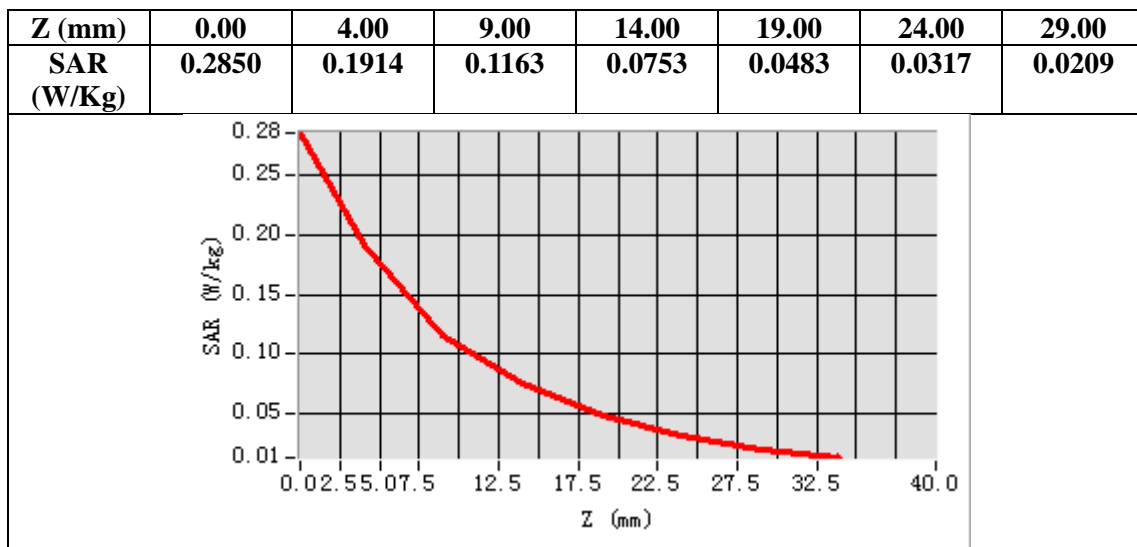

Test Laboratory: AGC Lab
WCDMA BandII Low-Edge 3(RMC)
DUT:Smart Phone; Type:LitePro

Date: Oct. 12,2018

Communication System: UMTS;Communication System Band: Band II UTRA/FDD ;Duty
Cycle:1:1;Conv.F=5.39Frequency: 1852.4MHz; Medium parameters used: $f = 1850$ MHz; $\sigma = 1.50$ mho/m; $\epsilon_r = 54.23$; $\rho = 1000$ kg/m³ ;
Phantom section: Flat Section
Ambient temperature (°C): 21.8, Liquid temperature (°C): 21.5

SATIMO Configuration:

Probe: SSE5; Calibrated: Aug. 08,2018; Serial No.: SN 22/12 EP159
Sensor-Surface: 4mm (Mechanical Surface Detection)
Phantom: SAM twin phantom
Measurement SW: OpenSAR V4_02_32

Configuration/ WCDMA band IILow-Edge 3/Area Scan: Measurement grid: dx=8mm, dy=8mm
Configuration/ WCDMA band IILow-Edge 3/Zoom Scan: Measurement grid: dx=8mm,dy=8mm, dz=5mm;

Area Scan	surf_sam_plan.txt, h= 5.00 mm
Zoom Scan	5x5x7,dx=8mm dy=8mm dz=5mm,Complete
Phantom	Validation plane
Device Position	Edge 3
Band	WCDMA band II
Channels	Low
Signal	CDMA (Crest factor: 1.0)

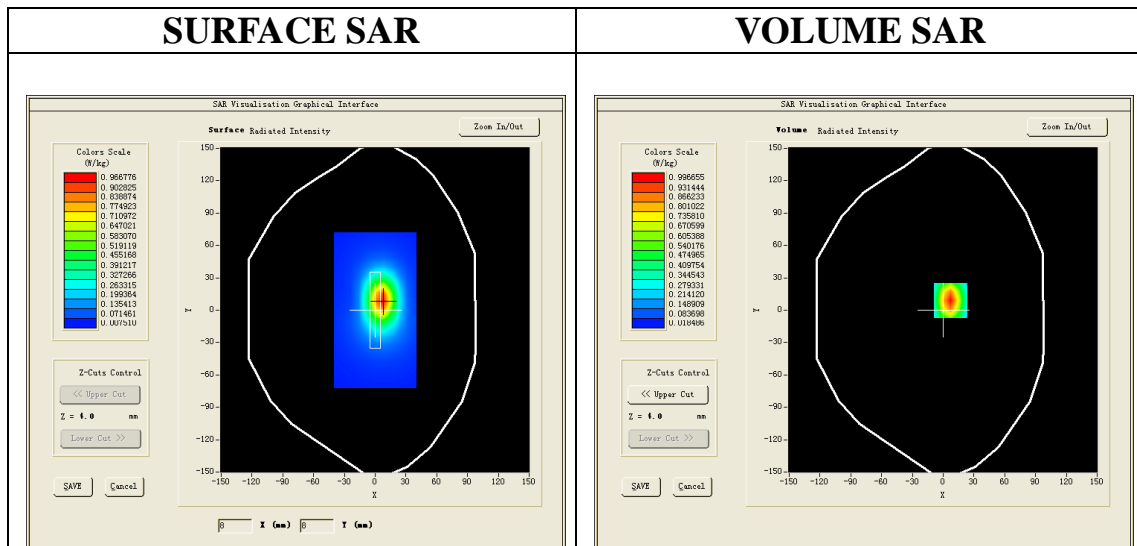

Maximum location: X=-1.00, Y=7.00

SAR Peak: 1.57 W/kg

SAR 10g (W/Kg)	0.521676
SAR 1g (W/Kg)	0.976360

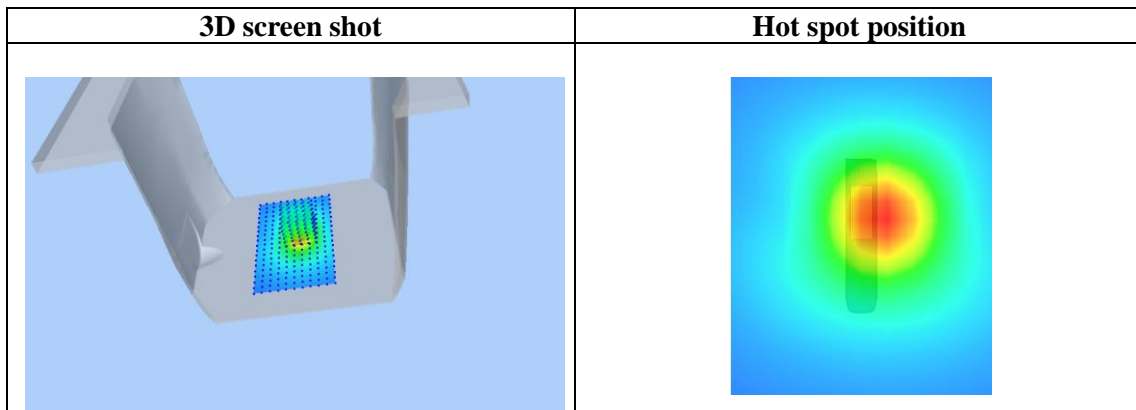
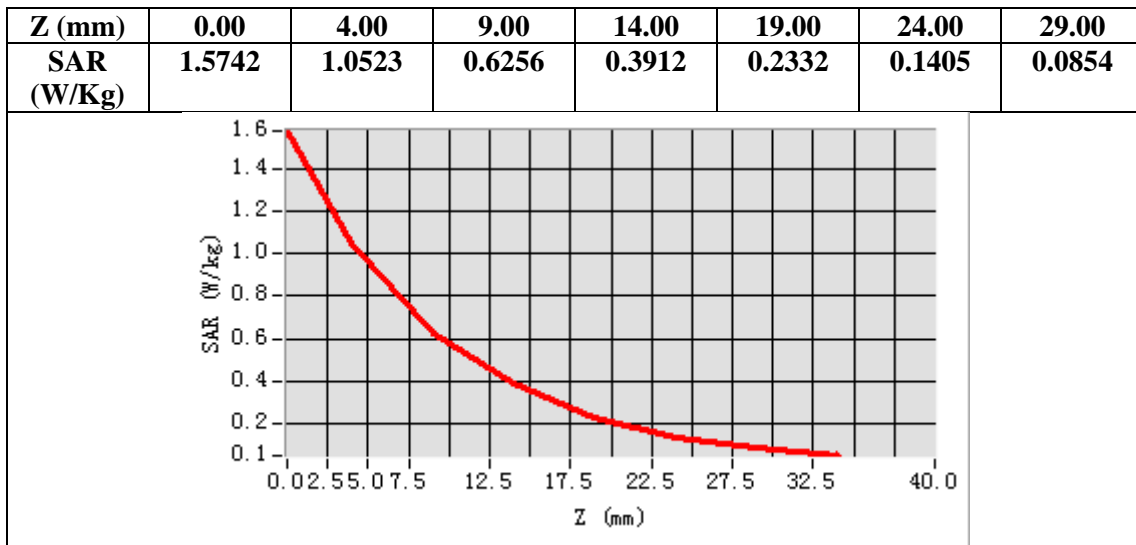

Test Laboratory: AGC Lab
WCDMA Band V Mid- Touch-Right (RMC)
DUT:Smart Phone; Type:LitePro

Date: Oct. 10,2018

Communication System: UMTS; Communication System Band: BAND V UTRA/FDD ; DutyCycle:1: 1;Conv.F=5.29;
Frequency: 836.6 MHz; Medium parameters used: $f = 835\text{MHz}$; $\sigma = 0.92 \text{ mho/m}$; $\epsilon_r = 40.81$; $\rho = 1000 \text{ kg/m}^3$;
Phantom section: Right Section
Ambient temperature ($^{\circ}\text{C}$): 22.1, Liquid temperature ($^{\circ}\text{C}$): 21.5

SATIMO Configuration:

Probe: SSE5; Calibrated: Aug. 08,2018; Serial No.: SN 22/12 EP159
Sensor-Surface: 4mm (Mechanical Surface Detection)
Phantom: SAM twin phantom
Measurement SW: OpenSAR V4_02_32

Configuration/ WCDMA Band V Mid-Touch-Right/Area Scan: Measurement grid: $dx=8\text{mm}$, $dy=8\text{mm}$
Configuration/ WCDMA Band V Mid-Touch-Right/Zoom Scan: Measurement grid: $dx=8\text{mm}$, $dy=8\text{mm}$, $dz=5\text{mm}$;

Area Scan	$dx=8\text{mm}$ $dy=8\text{mm}$, $h= 5.00 \text{ mm}$
ZoomScan	$5 \times 5 \times 7$, $dx=8\text{mm}$ $dy=8\text{mm}$ $dz=5\text{mm}$, Complete
Phantom	Right head
Device Position	Cheek
Band	WCDMA Band V
Channels	Middle
Signal	CDMA (Crest factor: 1.0)

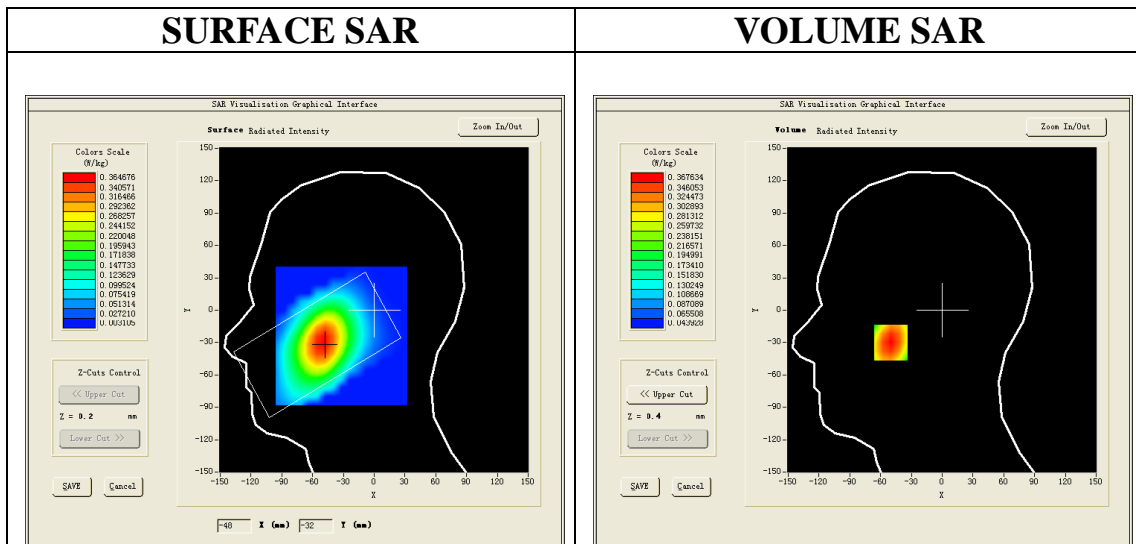

Maximum location: X=-50.00, Y=-30.00
SAR Peak: 0.42 W/kg

SAR 10g (W/Kg)	0.270114
SAR 1g (W/Kg)	0.355400

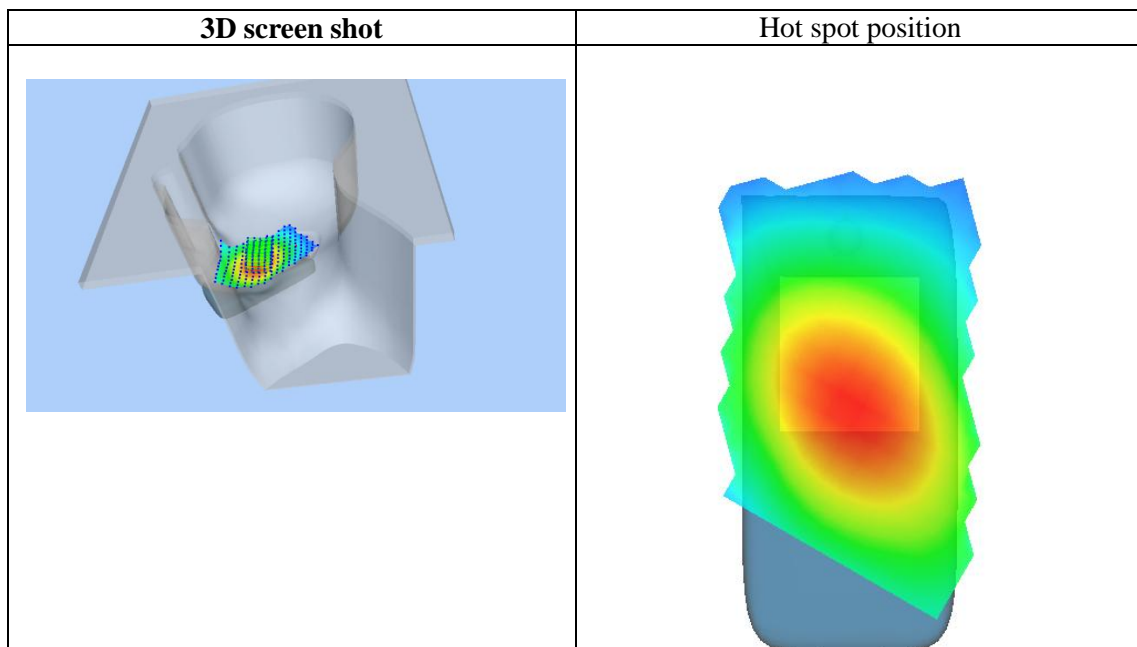
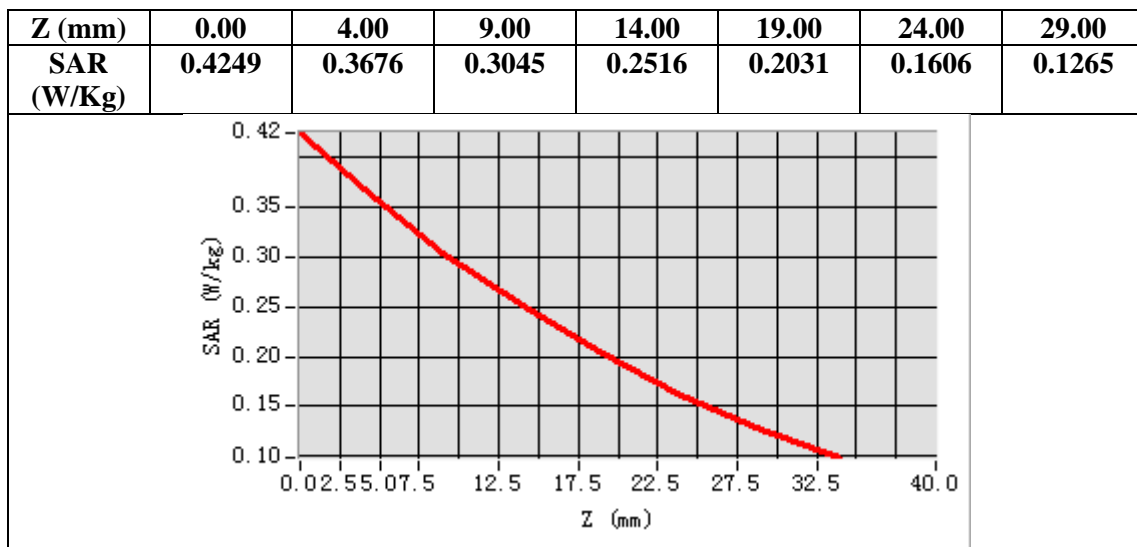

Test Laboratory: AGC Lab
WCDMA Band V Mid-Body-Towards Grounds(RMC)
DUT:Smart Phone; Type:LitePro

Date: Oct. 10,2018

Communication System: UMTS; Communication System Band: BAND V UTRA/FDD; DutyCycle:1: 1;
Conv.F=5.49;Frequency: 836.6 MHz; Medium parameters used: f = 835MHz; $\sigma = 0.97$ mho/m; $\epsilon_r = 54.73$; $\rho = 1000$ kg/m³ ;
Phantom section: Flat Section
Ambient temperature (°C): 22.1, Liquid temperature (°C): 21.7

SATIMO Configuration:

Probe: SSE5; Calibrated: Aug. 08,2018; Serial No.: SN 22/12 EP159
Sensor-Surface: 4mm (Mechanical Surface Detection)
Phantom: SAM twin phantom
Measurement SW: OpenSAR V4_02_32

Configuration/ WCDMA Band V Mid-Body-Back/Area Scan: Measurement grid: dx=8mm, dy=8mm
Configuration/ WCDMA Band V Mid-Body-Back/Zoom Scan: Measurement grid: dx=8mm,dy=8mm, dz=5mm;

Area Scan	surf_sam_plan.txt, h= 5.00 mm
ZoomScan	5x5x7,dx=8mm dy=8mm dz=5mm,Complete
Phantom	Validation plane
Device Position	Body Back
Band	WCDMA Band V
Channels	Middle
Signal	CDMA (Crest factor: 1.0)

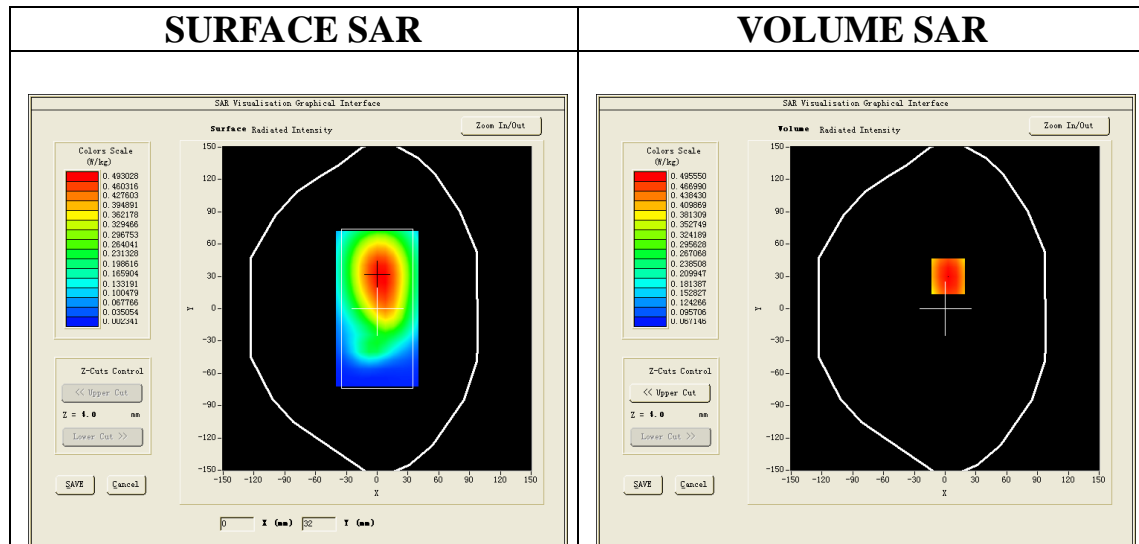

Maximum location: X=3.00, Y=30.00
SAR Peak: 0.61 W/kg

SAR 10g (W/Kg)	0.353731
SAR 1g (W/Kg)	0.478598

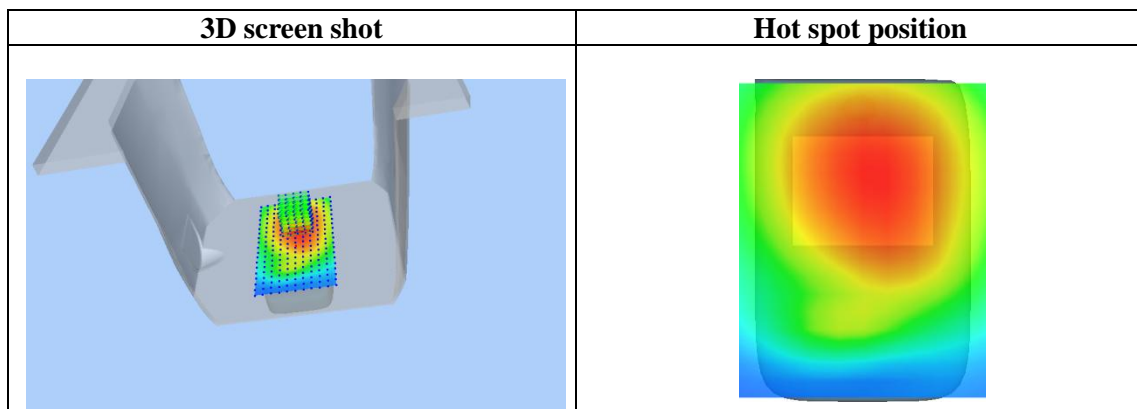
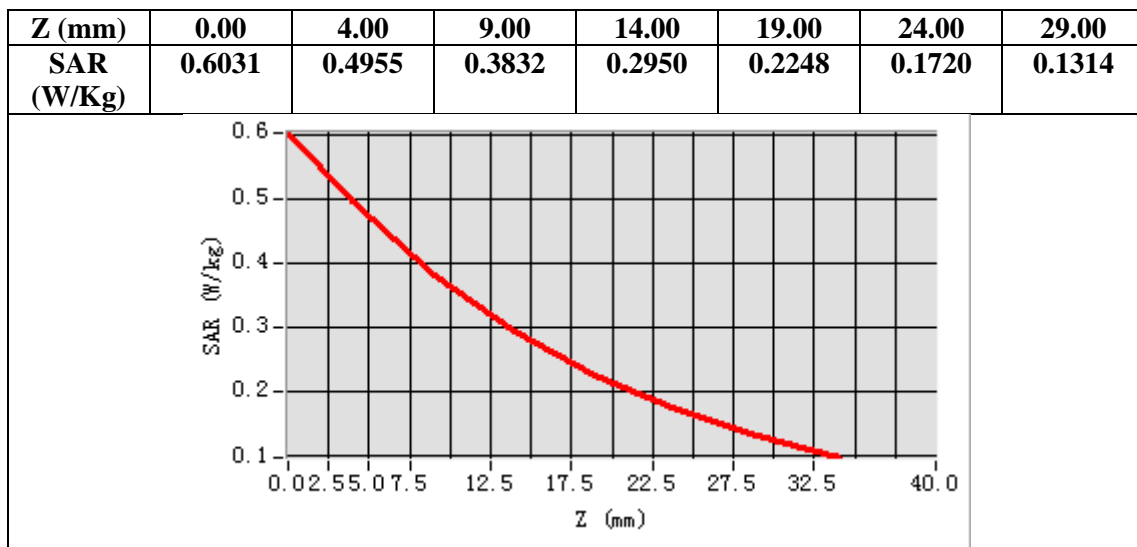

WIFI MODE

Test Laboratory: AGC Lab
802.11b Mid- Touch-Right
DUT:Smart Phone; Type:LitePro

Date: Oct. 11,2018

Communication System: Wi-Fi; Communication System Band: 802.11b; DutyCycle: 1:1; Conv.F=4.90;
Frequency: 2437 MHz; Medium parameters used: $f = 2450$ MHz; $\sigma = 1.80$ mho/m; $\epsilon_r = 40.22$; $\rho = 1000$ kg/m³ ;
Phantom section: Right Section
Ambient temperature (°C):21.9, Liquid temperature (°C): 21.3

SATIMO Configuration:

Probe: SSE5; Calibrated: Aug. 08,2018; Serial No.: SN 22/12 EP159
Sensor-Surface: 4mm (Mechanical Surface Detection)
Phantom: SAM twin phantom
Measurement SW: OpenSAR V4_02_35

Configuration/802.11b Mid- Touch-Right /Area Scan: Measurement grid: dx=8mm, dy=8mm
Configuration/802.11b Mid- Touch-Right /Zoom Scan: Measurement grid: dx=5mm,dy=5mm, dz=5mm;

Area Scan	dx=8mm dy=8mm, h= 5.00 mm
ZoomScan	7x7x7,dx=5mm dy=5mm dz=5mm
Phantom	Right head
Device Position	Cheek
Band	2450MHz
Channels	Middle
Signal	Crest factor: 1.0

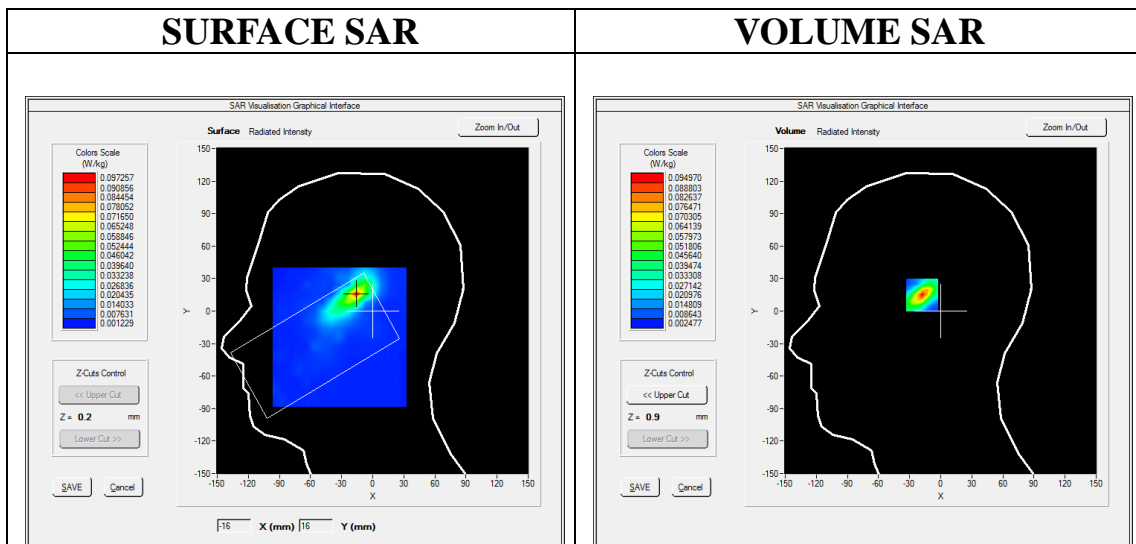

Maximum location: X=-16.00, Y=16.00
SAR Peak: 0.18 W/kg

SAR 10g (W/Kg)	0.030251
SAR 1g (W/Kg)	0.080238

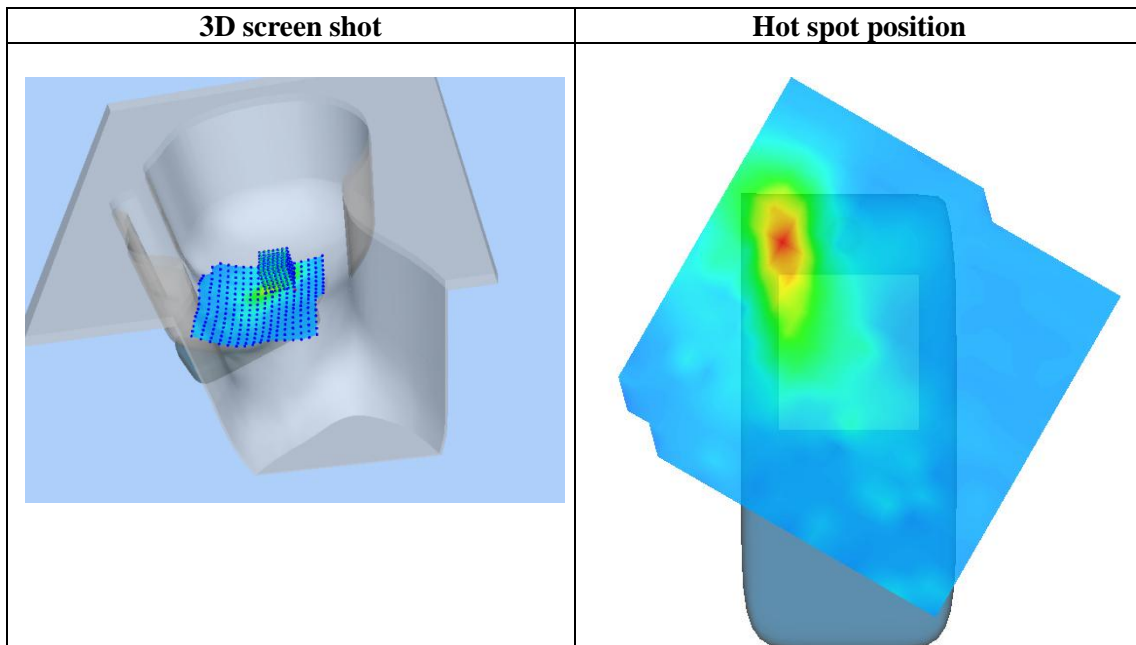
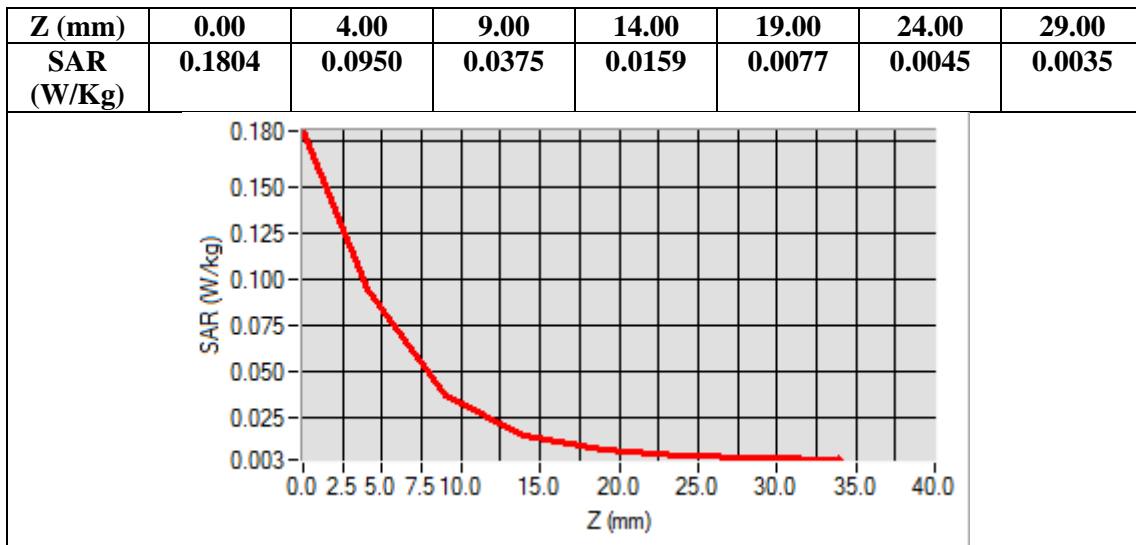

Test Laboratory: AGC Lab
802.11bMid-Body-Worn- Back (DTS)
DUT:Smart Phone; Type:LitePro

Date: Oct. 11,2018

Communication System: Wi-Fi; Communication System Band: 802.11b; DutyCycle: 1:1; Conv.F=5.04;
Frequency: 2437 MHz; Medium parameters used: $f = 2450$ MHz; $\sigma = 1.90$ mho/m; $\epsilon_r = 54.31$; $\rho = 1000$ kg/m³ ;
Phantom section: Flat Section
Ambient temperature (°C):21.9, Liquid temperature (°C): 21.5

SATIMO Configuration:

Probe: SSE5; Calibrated: Aug. 08,2018; Serial No.: SN 22/12 EP159
Sensor-Surface: 4mm (Mechanical Surface Detection)
Phantom: SAM twin phantom
Measurement SW: OpenSAR V4_02_35

Configuration/802.11b Mid- Body- Back /Area Scan: Measurement grid: dx=8mm, dy=8mm
Configuration/802.11b Mid- Body- Back /Zoom Scan: Measurement grid: dx=5mm,dy=5mm, dz=5mm;

Area Scan	surf_sam_plan.txt, h= 5.00 mm
ZoomScan	7x7x7,dx=5mm dy=5mm dz=5mm
Phantom	Validation plane
Device Position	BodyBack
Band	2450MHz
Channels	Middle
Signal	Crest factor: 1.0

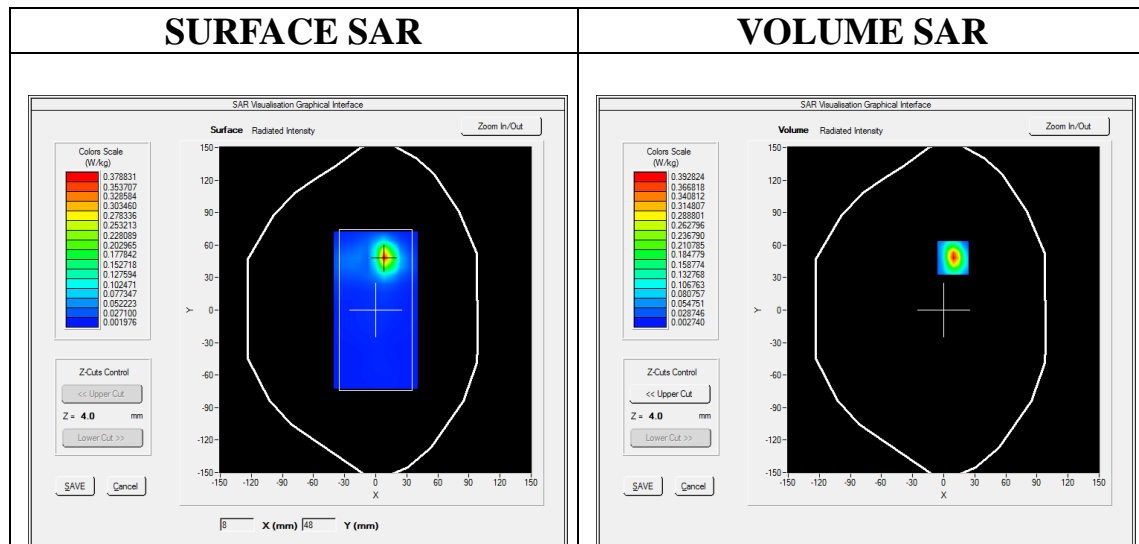

Maximum location: X=9.00, Y=48.00

SAR Peak: 0.70 W/kg

SAR 10g (W/Kg)	0.122622
SAR 1g (W/Kg)	0.334700

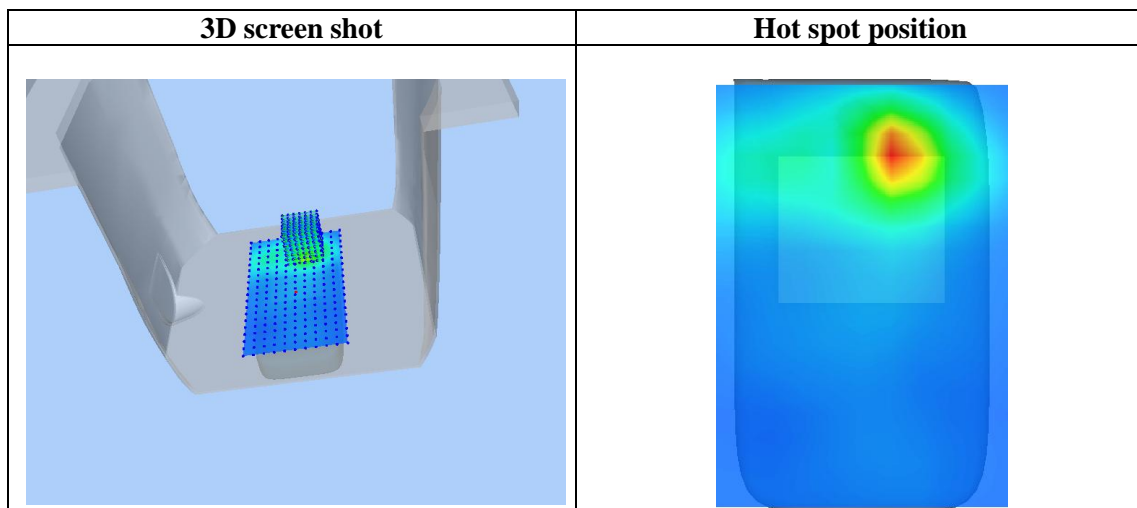
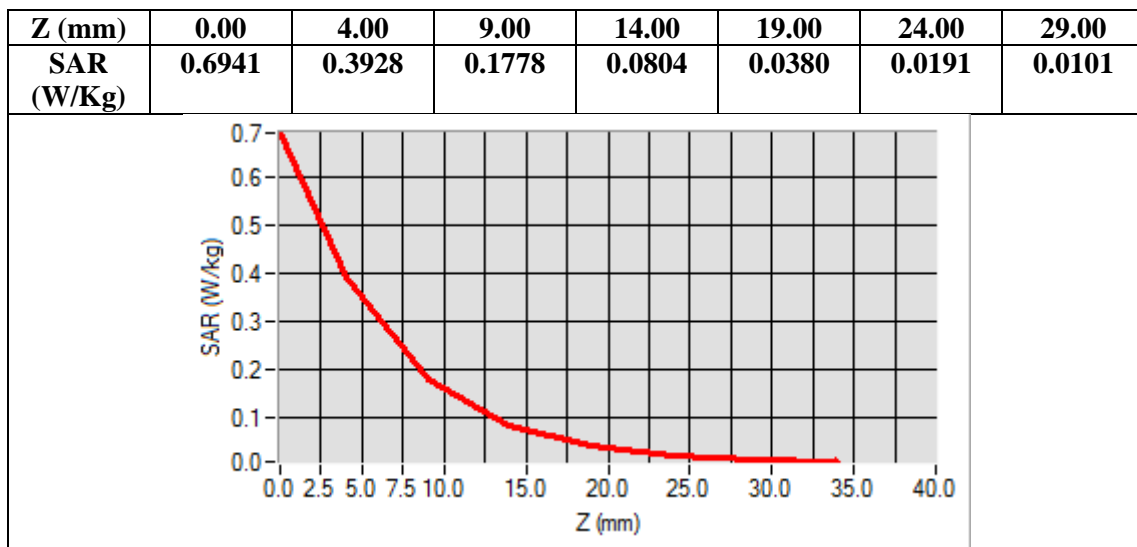

Repeated SAR

Test Laboratory: AGC Lab
GPRS 1900 Low-Edge3(4up)
DUT:Smart Phone; Type:LitePro

Date: Oct. 12,2018

Communication System: GPRS-4Slot; Communication System Band: PCS 1900;Duty Cycle: 1:2.1; Conv.F=5.39;
Frequency: 1850.2 MHz; Medium parameters used: $f = 1850$ MHz; $\sigma = 1.46$ mho/m; $\epsilon_r = 54.75$; $\rho = 1000$ kg/m³ ;
Phantom section: Flat Section
Ambient temperature (°C): 21.8, Liquid temperature (°C): 21.5

SATIMO Configuration:

Probe: SSE5; Calibrated: Aug. 08,2018; Serial No.: SN 22/12 EP159
Sensor-Surface: 4mm (Mechanical Surface Detection)
Phantom: SAM twin phantom
Measurement SW: OpenSAR V4_02_32

Configuration/GPRS1900 Low-Edge3/Area Scan: Measurement grid: dx=8mm, dy=8mm
Configuration/GPRS1900 Low-Edge3/Zoom Scan: Measurement grid:dx=8mm,dy=8mm, dz=5mm;

Area Scan	surf_sam_plan.txt, h= 5.00 mm
ZoomScan	5x5x7,dx=8mm dy=8mm dz=5mm,Complete
Phantom	Validation plane
Device Position	Edge3
Band	PCS1900
Channels	Low
Signal	TDMA (Crest factor: 2.0)

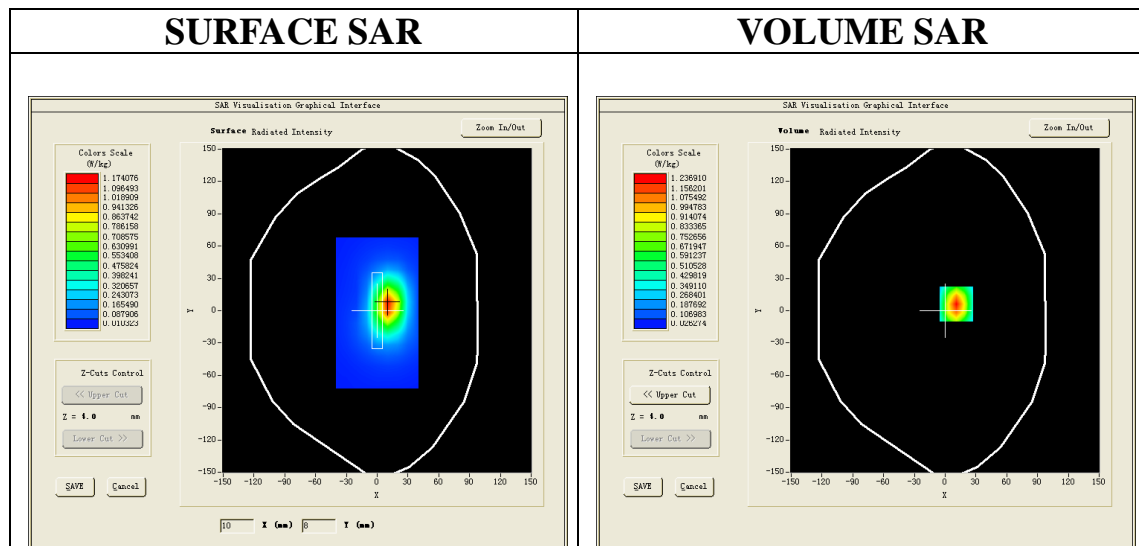

Maximum location: X=11.00, Y=6.00

SAR Peak: 1.84 W/kg

SAR 10g (W/Kg)	0.612972
SAR 1g (W/Kg)	1.138162

Z (mm)	0.00	4.00	9.00	14.00	19.00	24.00	29.00
SAR (W/Kg)	1.8491	1.2369	0.7509	0.4418	0.2900	0.1714	0.1015

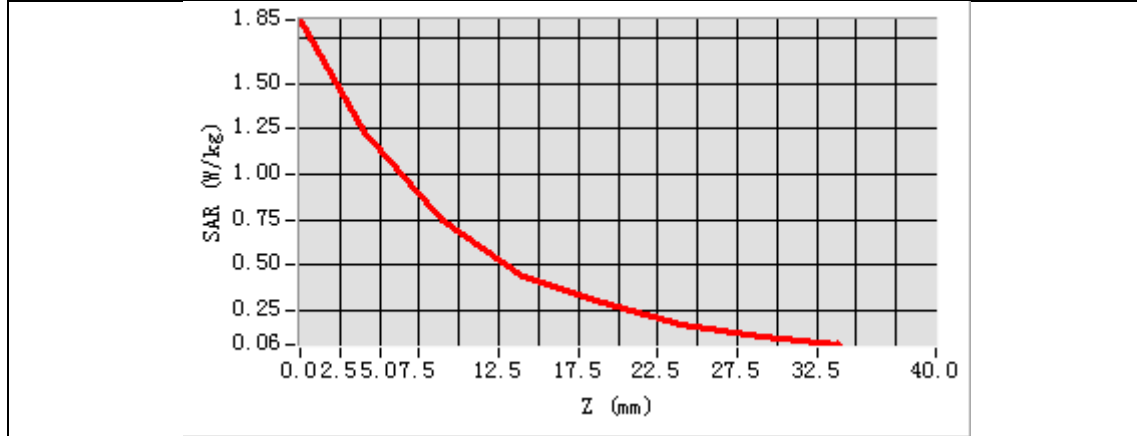

3D screen shot	Hot spot position
<p>A 3D perspective view of a grey, L-shaped device. A small rectangular area on the flat surface of the L is highlighted with a color-coded heatmap, showing a central red/orange area (high SAR) transitioning to yellow, green, and blue (lower SAR) towards the edges.</p>	<p>A 2D heatmap showing the spatial distribution of SAR. The central region is red, indicating the highest SAR values, surrounded by concentric rings of yellow, green, and blue, indicating decreasing SAR values. A vertical grey bar is overlaid on the heatmap, corresponding to the device's profile.</p>

Test Laboratory: AGC Lab
WCDMA BandII Low-Edge 3(RMC)
DUT:Smart Phone; Type:LitePro

Date: Oct. 12,2018

Communication System: UMTS;Communication System Band: Band II UTRA/FDD ;Duty
Cycle:1:1;Conv.F=5.39Frequency: 1852.4MHz; Medium parameters used: $f = 1850$ MHz; $\sigma = 1.50$ mho/m; $\epsilon_r = 54.23$; $\rho = 1000$ kg/m³ ;
Phantom section: Flat Section
Ambient temperature (°C): 21.8, Liquid temperature (°C): 21.5

SATIMO Configuration:

Probe: SSE5; Calibrated: Aug. 08,2018; Serial No.: SN 22/12 EP159
Sensor-Surface: 4mm (Mechanical Surface Detection)
Phantom: SAM twin phantom
Measurement SW: OpenSAR V4_02_32

Configuration/ WCDMA band IILow-Edge 3/Area Scan: Measurement grid: dx=8mm, dy=8mm
Configuration/ WCDMA band IILow-Edge 3/Zoom Scan: Measurement grid: dx=8mm,dy=8mm, dz=5mm;

Area Scan	surf_sam_plan.txt, h= 5.00 mm
Zoom Scan	5x5x7,dx=8mm dy=8mm dz=5mm,Complete
Phantom	Validation plane
Device Position	Edge 3
Band	WCDMA band II
Channels	Low
Signal	CDMA (Crest factor: 1.0)

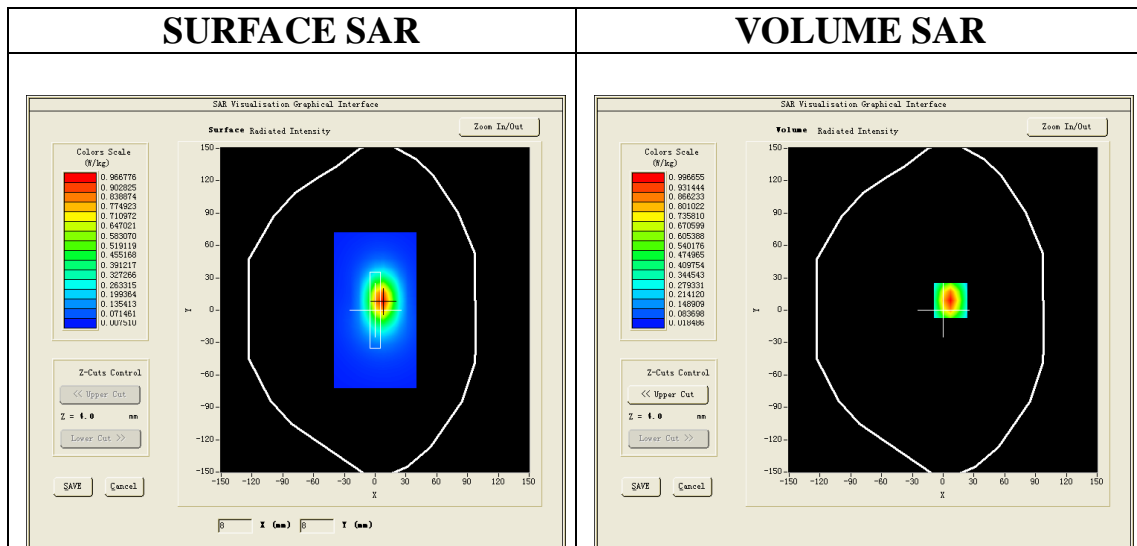

Maximum location: X=-1.00, Y=7.00

SAR Peak: 1.61 W/kg

SAR 10g (W/Kg)	0.535319
SAR 1g (W/Kg)	1.006930

Z (mm)	0.00	4.00	9.00	14.00	19.00	24.00	29.00
SAR (W/Kg)	1.6166	1.0864	0.6492	0.3919	0.2353	0.1426	0.0861

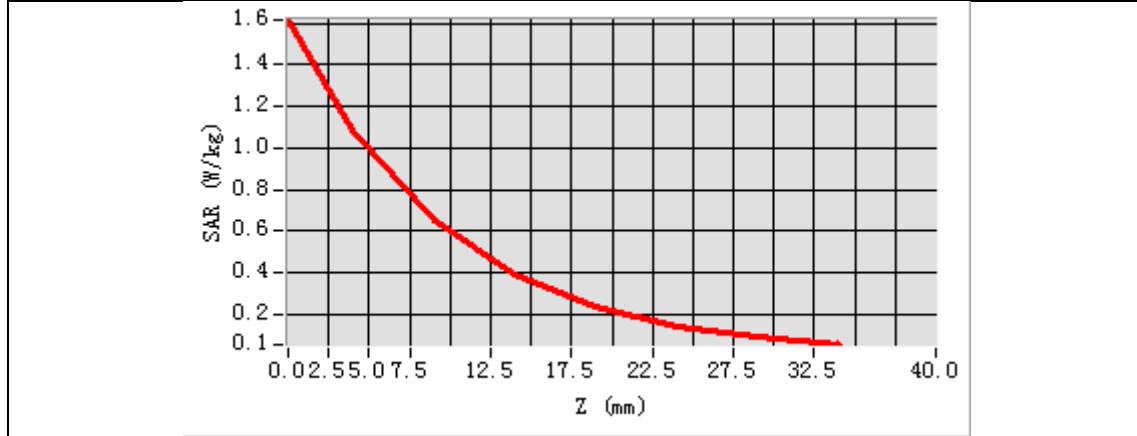

3D screen shot	Hot spot position
<p>A 3D perspective view of a grey, L-shaped device. A small rectangular area on the flat surface of the L-shape is highlighted with a color-coded grid, showing a central red/yellow hot spot that transitions to green and then blue towards the edges.</p>	<p>A 2D heatmap visualization of the hot spot. It shows a central red/yellow circular region, surrounded by concentric rings of green and then blue, indicating the spatial distribution of the SAR field.</p>

APPENDIX C. TEST SETUP PHOTOGRAPHS

LEFT- CHEEK TOUCH

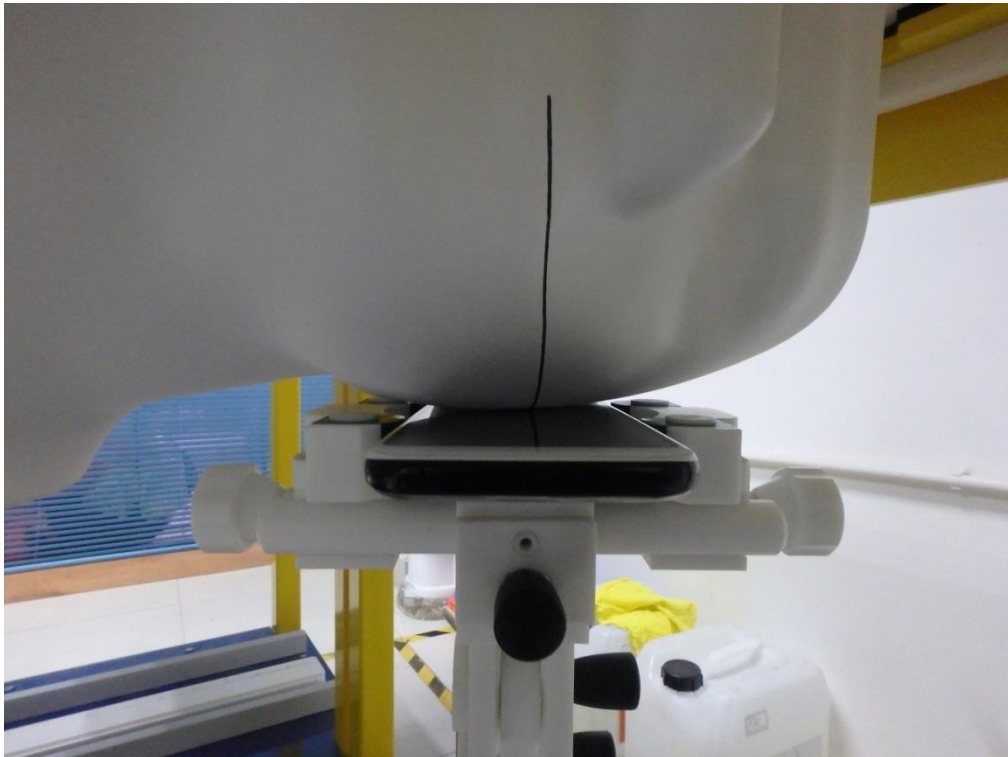

LEFT-TILT 15°

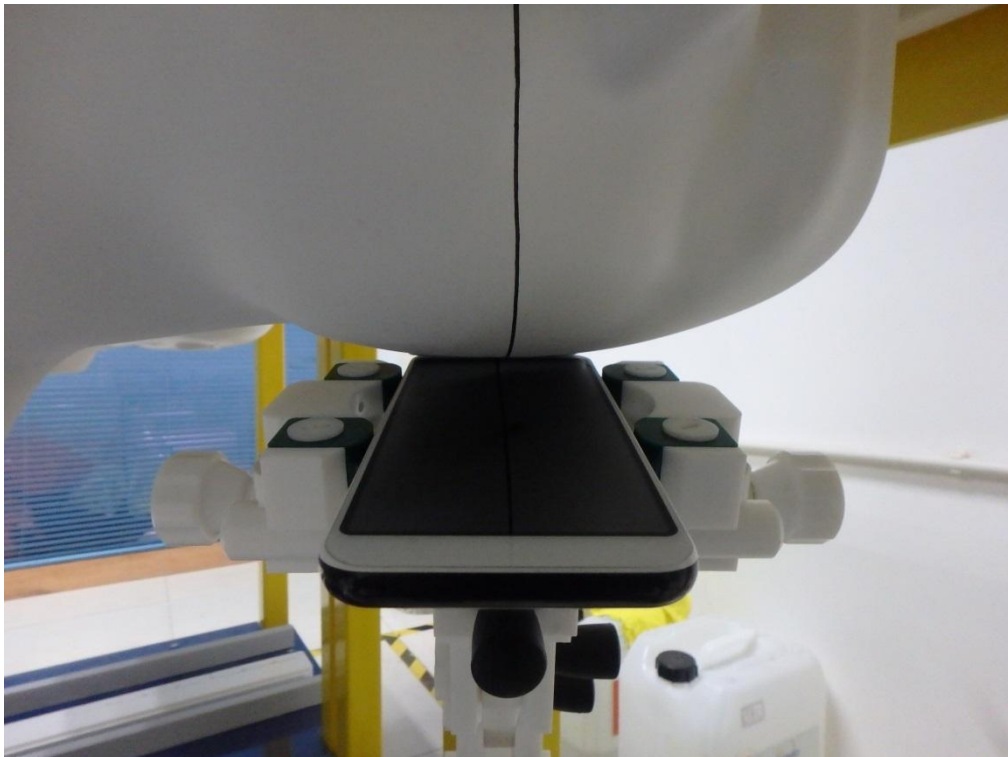

RIGHT- CHEEK TOUCH

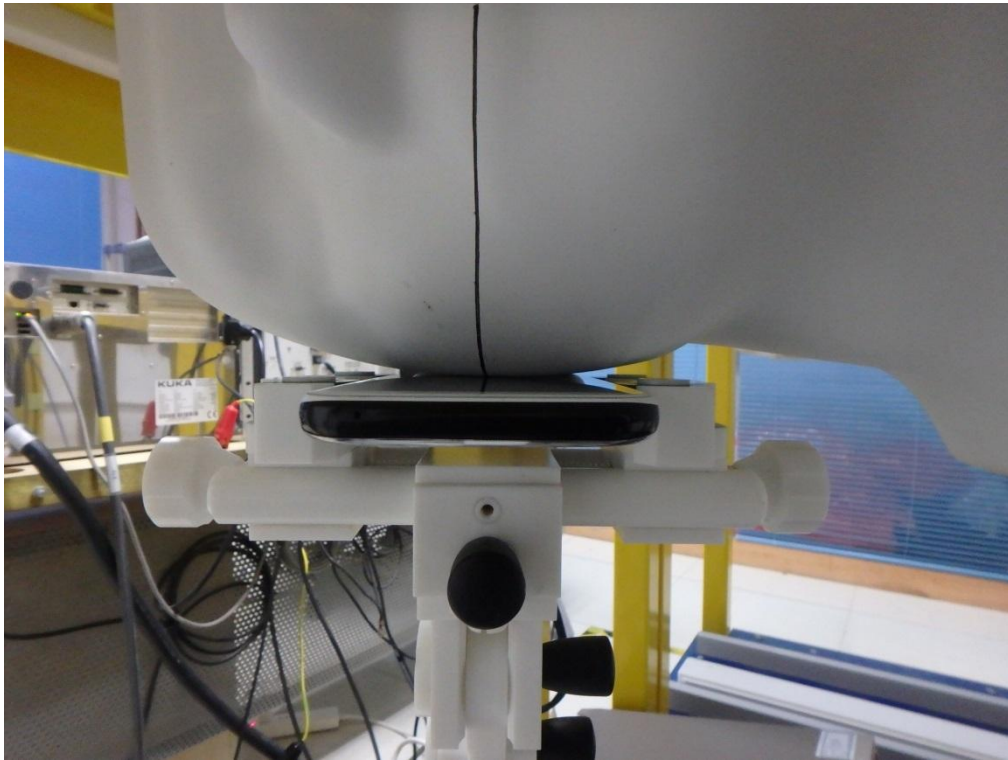

RIGHT-TILT 15°

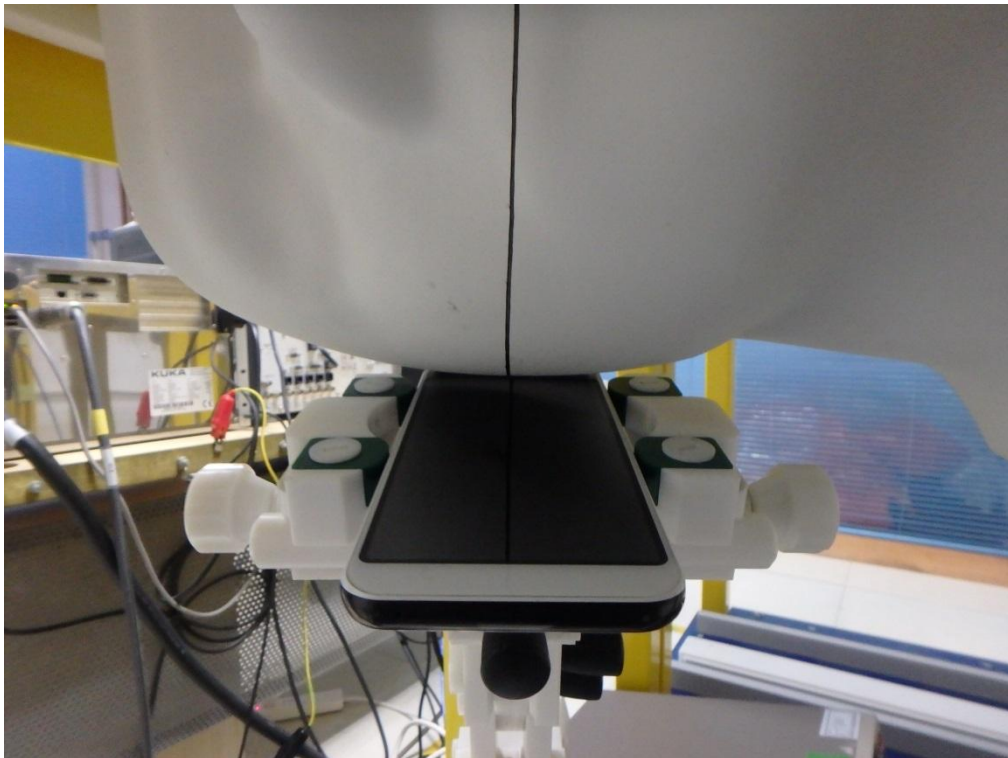

Body Back 10mm

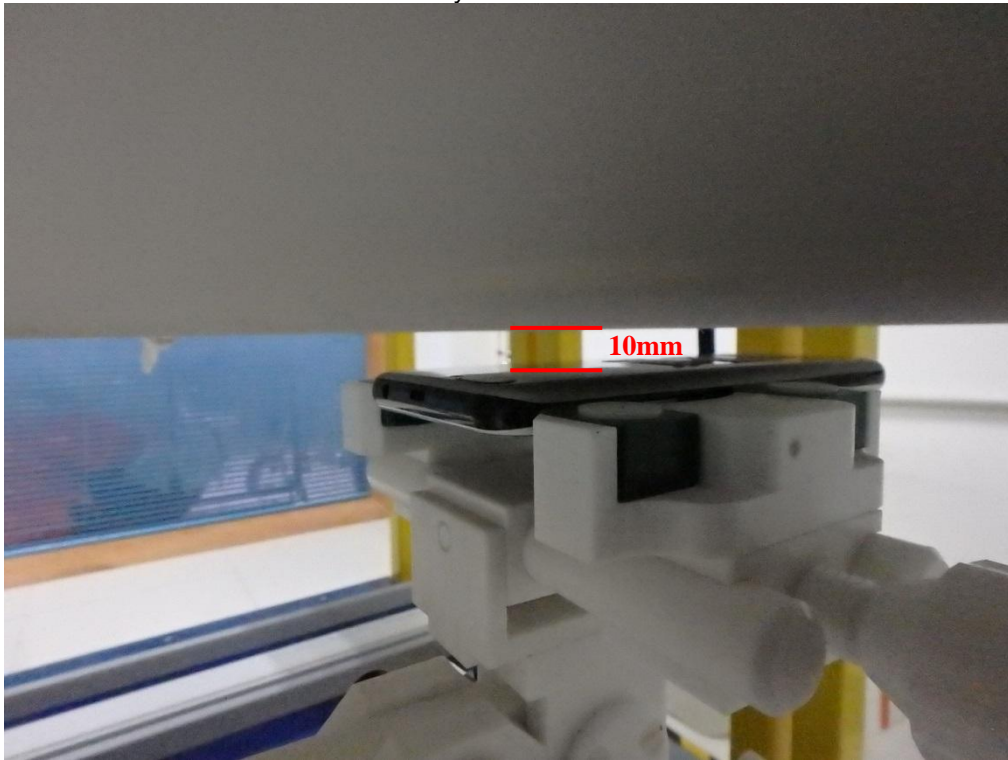

Body Front 10mm

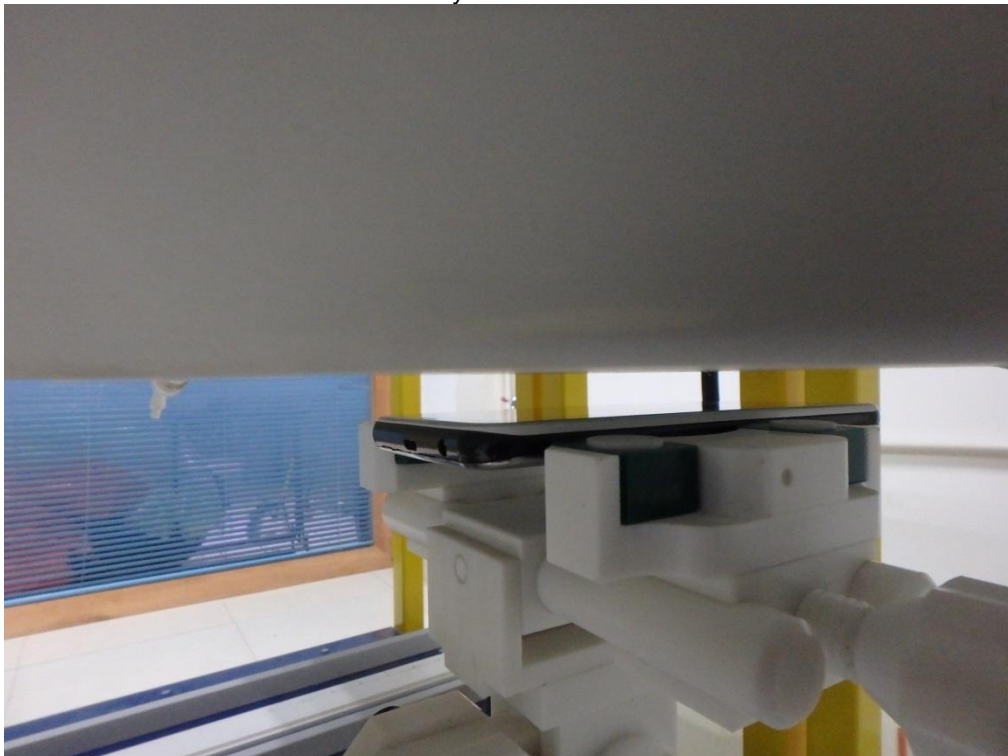

Edge 1(Top)10mm

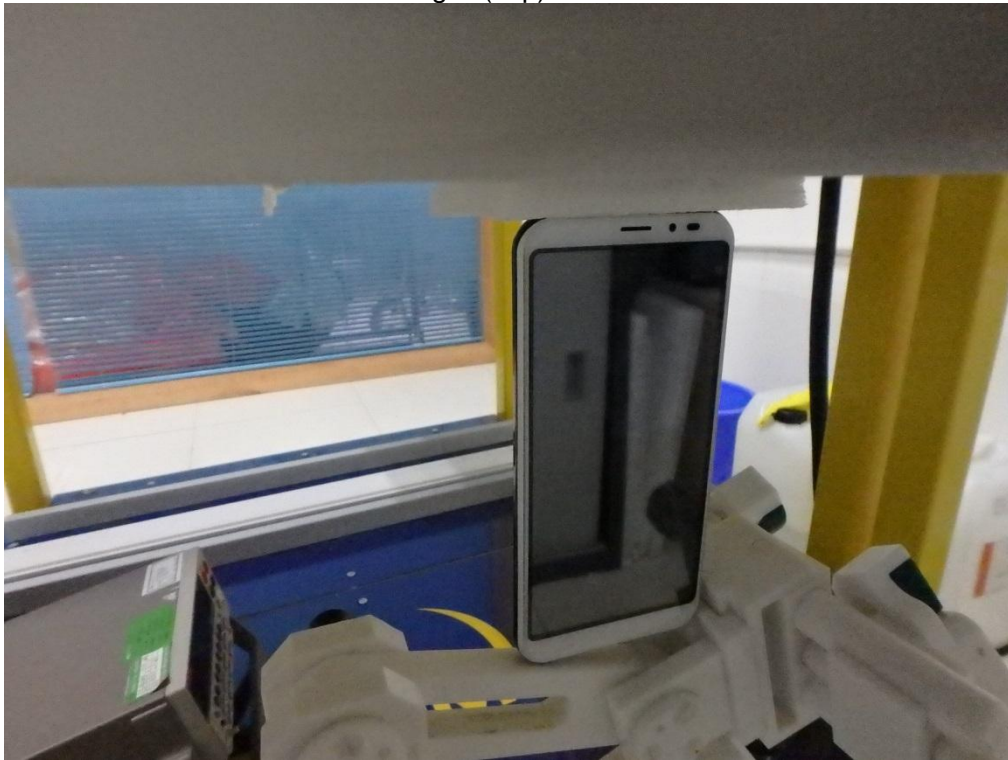

Edge 2(Right)10mm



Edge 3(Bottom) 10mm

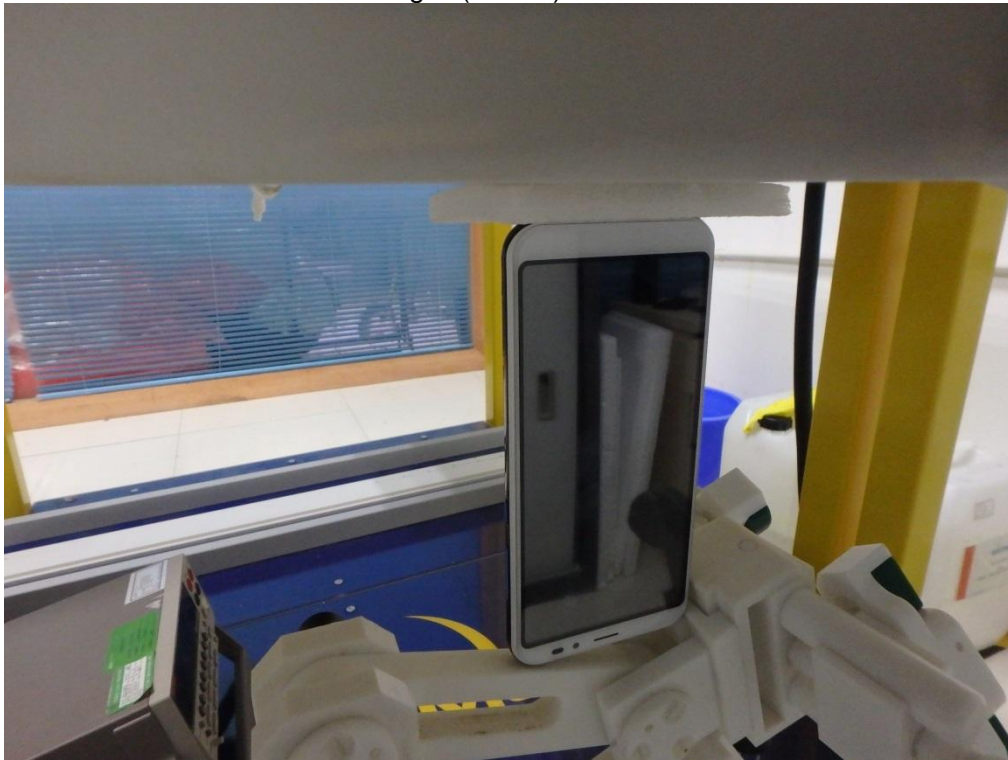

Edge 4(Left) 10mm



DEPTH OF THE LIQUID IN THE PHANTOM—ZOOM IN

Note : The position used in the measurement were according to IEEE 1528-2013

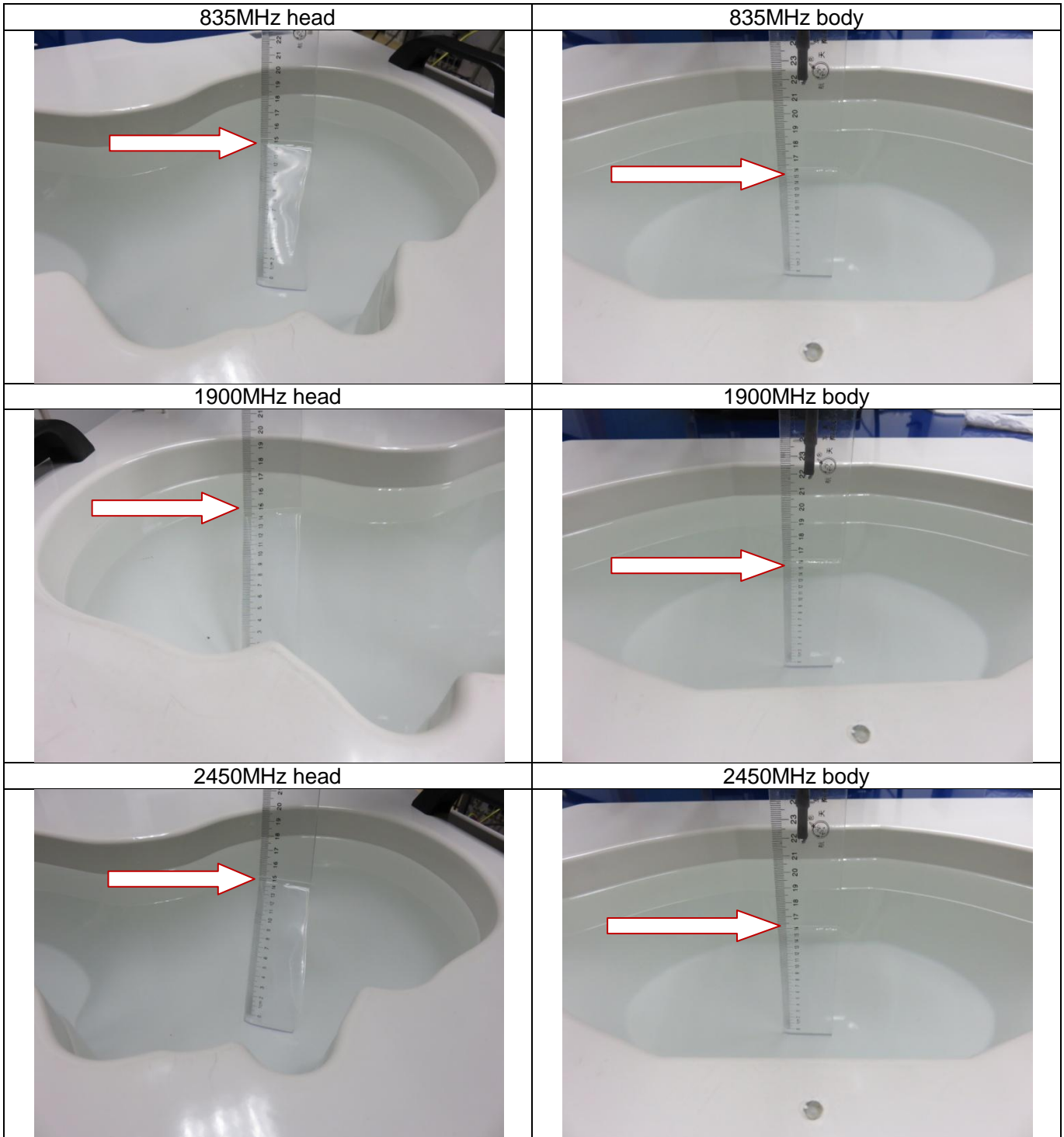

APPENDIX D. CALIBRATION DATA

Refer to Attached files.